

**IBM File Manager for z/OS®
User's Guide and Reference for CICS
Version 16.1.4**

Note

Before using this document, read the general information under [Notices on page cxli](#).

Edition Notice

This edition (June 2026) applies to Version 16 Release 1 Modification Level 4 of IBM® File Manager for z/OS® (program number 5755-AB3) and to all subsequent releases and modifications until otherwise indicated in new editions.

Contents

About this document.....	vii	Viewing queue names with unprintable characters.....	51
Who should use this document.....	vii	Refreshing the current selection list.....	51
How to read syntax diagrams.....	viii	Changing resource attributes.....	52
Summary of changes.....	xii	Selecting items from a display list.....	52
Part I. Working with FM/CICS.....	13	Initiating a FM/CICS Browse editor session from a display list.....	53
Chapter 1. FM/CICS overview.....	14	Sorting a CICS selection list.....	53
Chapter 2. System requirements for File Manager for CICS®.....	15	Chapter 8. Working with CICS enqueues.....	55
Chapter 3. Getting started with FM/CICS.....	16	Invocation and execution.....	55
Starting FM/CICS.....	16	Displaying additional CICS attributes.....	56
Checking your FM/CICS version.....	19	Purging CICS tasks.....	56
Checking the level of connected CICS systems.....	19	Chapter 9. Messages.....	57
Exiting from FM/CICS.....	20	Format of numbered messages.....	57
Using the FM/CICS interface.....	21	File Manager messages.....	58
Moving from panel to panel.....	21	FM/CICS logon and message log messages.....	59
Showing more information on a panel.....	21	FMNCA000	59
Scrollable input and display fields for long names.....	23	FMNCA001	59
Issuing commands.....	24	FMNCA002	60
Specifying resource names.....	24	FMNCA003	60
Specifying a data set and a member name.....	26	FMNCA004	60
Specifying quoted strings.....	30	FMNCA005	60
Using hexadecimal values in FM/CICS.....	31	FMNCA006	60
Getting help.....	31	FMNCA007	60
Displaying field help information.....	32	FMNCA008	60
Accessing Tutorial Help.....	32	FMNCA009	61
Viewing error messages.....	34	FMNCA010	61
Customizing your FM/CICS session.....	35	FMNCA011	61
Hiding or showing PF key descriptions.....	35	FMNCA012	61
Changing terminal characteristics.....	35	FMNCA013	61
Setting your default processing options.....	37	FMNCA014	62
Running the File Manager Base function against CICS resources.....	39	FMNCA015	62
Running File Manager IMS component under FM/CICS.....	41	FMNCA016	62
Running File Manager Db2 component under FM/CICS.....	41	FMNCA017	62
Running File Manager Db2 component under FM/CICS.....	41	FMNCA018	62
Running File Manager Db2 component under FM/CICS.....	41	FMNCA019	63
Chapter 4. Viewing and changing CICS resources.....	42	FMNCA020	63
Editing CICS files.....	44	FMNCA021	63
Editing temporary storage.....	44	FMNCA022	63
Editing transient data queues.....	46	FMNCA023	63
Locking your CICS resource.....	47	FMNCA024	64
Chapter 5. Working with FM/CICS utilities.....	48	FMNCA025	64
Chapter 6. Printing a CICS resource.....	49	FMNCA026	64
Chapter 7. Working with lists of CICS resources.....	50	FMNCA027	64
Finding a string in a selection list.....	50	FMNCA028	64
Searching the current primary sort order column.....	51	FMNCA029	64

FMNCA030.....	65	CICS Temporary Storage Selection List panel.....	94
FMNCA031.....	65	CICS Transient Data Queue Selection List panel.....	96
FMNCA032.....	65	Edit Entry panels.....	99
FMNCA033.....	65	Extrapartition Queue panel.....	102
FMNCA034.....	65	File Information panel.....	106
FMNCA035.....	65	File Manager for CICS Logon panels.....	111
FMNCA036.....	66	FMN Keylist Change panel.....	114
FMNCA037.....	66	Intrapartition Queue panel.....	115
FMNCA038.....	66	IPDCC Settings panel.....	118
FMNCA039.....	66	List CICS Resources Entry panel.....	120
FMNCA040.....	66	Primary Option Menu panels.....	121
FMNCA041.....	67	Print Entry panels.....	124
FMNCA042.....	67	Set Processing Options panel.....	130
FMNCA043.....	67	Utility Functions panel.....	131
FMNCA051.....	67	View Entry panels.....	133
FMNCA065.....	67	Support resources.....	cxl
FMNCA999.....	68	Notices.....	cxli
FMNCA060.....	68	Programming interface information.....	cxliv
FMNCA061.....	68	Index.....	145
FMNCA062.....	68		
FMNCA063.....	68		
FMNCA064.....	69		
Part II. FM/CICS reference.....	70		
Chapter 10. FM/CICS primary commands.....	71		
General primary commands.....	71		
CUAATTR primary command.....	71		
DX primary command.....	72		
KEYS primary command.....	72		
PFSHOW primary command.....	72		
SETTINGS primary command.....	73		
VER primary command.....	74		
VERCICS primary command.....	74		
XD primary command.....	74		
Selection list primary commands.....	75		
FIND primary command.....	75		
HEX primary command.....	76		
LOCATE primary command.....	76		
REFRESH primary command.....	77		
RFIND primary command.....	77		
SELECT primary command.....	78		
SORT primary command.....	78		
Chapter 11. FM/CICS panels and fields.....	79		
Browse Entry panels.....	79		
Change CUA Attributes panel.....	85		
CICS Enqueue Resource panel.....	86		
CICS Enqueue Selection List panel.....	89		
CICS File Selection List panel.....	91		

User's Guide and Reference for CICS®

This publication provides guidance and reference information for users of File Manager for z/OS CICS® component (FM/CICS).

About this document

This document provides guidance and reference information for users of File Manager for CICS Component (FM/CICS).

File Manager for z/OS® contains four “flavors” of File Manager, for working in different environments or with different data formats:

- **FM/CICS** for working with CICS® resources.
- File Manager Base component for working with QSAM data sets, VSAM data sets, or PDS members
- **Db2 Component** for working with Db2® data
- **IMS Component** for working with IMS™ data

In addition, reference is made to the IBM® Application Delivery Foundation for z/OS® Common Components server (ADFzCC server).

This information is primarily focussed on the FM/CICS component and the differences between it and the File Manager Base component. You should use this document in conjunction with the *File Manager for z/OS User's Guide and Reference*.

This document is divided into three parts:

Part 1. Working with FM/CICS

Describes the key FM/CICS concepts and tasks.

Part 2. FM/CICS reference

Provides a lookup reference for FM/CICS panels, fields, and commands.

Part 3. Appendixes

This part contains the notices and index. The support information tells you about IBM Web sites that can help you answer questions and solve problems.

For more information about the File Manager Base component, FM/Db2, and FM/IMS components, see the following books:

- *File Manager for z/OS User's Guide and Reference*
- *File Manager User's Guide and Reference for DB2 Data*
- *File Manager User's Guide and Reference for IMS Data*

Who should use this document

This document is for three kinds of File Manager users:

- Application programmers who need to test and debug programs
- Service support personnel who need to analyze and fix problems
- System administrators and system operators who need to do routine tasks such as moving large amounts of data

This document assumes that you are familiar with using CICS.

How to read syntax diagrams

The syntactical structure of commands described in this document is shown by means of syntax diagrams.

Figure 1: Sample syntax diagram on page viii shows a sample syntax diagram that includes the various notations used to indicate such things as whether:

- An item is a keyword or a variable.
- An item is required or optional.
- A choice is available.
- A default applies if you do not specify a value.
- You can repeat an item.

Figure 1. Sample syntax diagram

Figure 1. Syntax

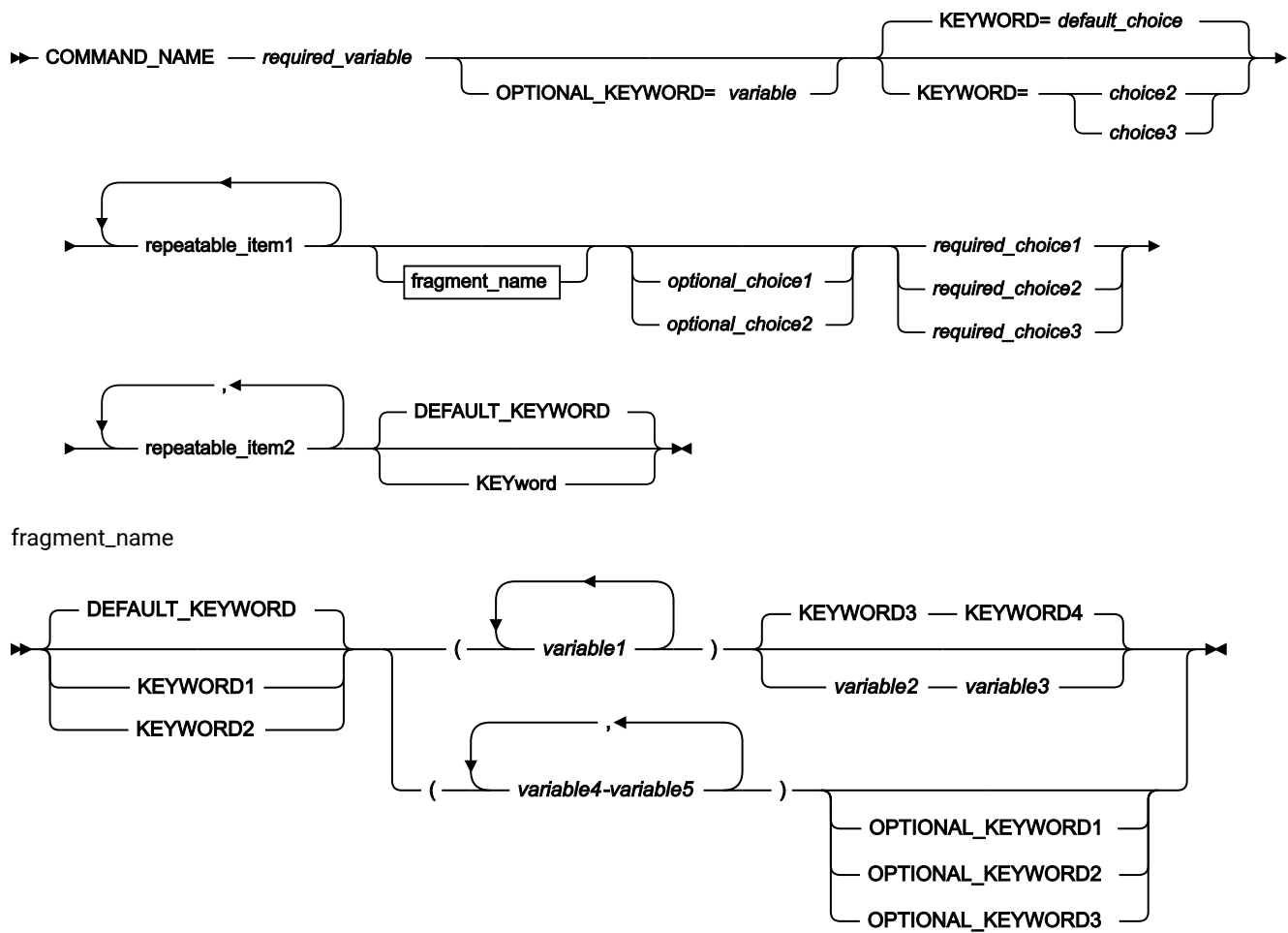

Here are some tips for reading and understanding syntax diagrams:

Order of reading

Read the syntax diagrams from left to right, from top to bottom, following the path of the line.

The \blacktriangleright — symbol indicates the beginning of a statement.

The — \blacktriangleright symbol indicates that a statement is continued on the next line.

The \blacktriangleright — symbol indicates that a statement is continued from the previous line.

The — \blacktriangleleft symbol indicates the end of a statement.

Keywords

Keywords appear in uppercase letters.

\blacktriangleright COMMAND_NAME \blacktriangleleft

Sometimes you only need to type the first few letters of a keyword. The required part of the keyword appears in uppercase letters.

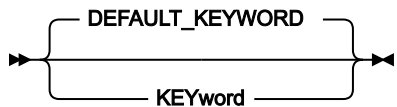

In this example, you could type "KEY", "KEYW", "KEYWO", "KEYWOR" or "KEYWORD".

The abbreviated or whole keyword you enter must be spelled exactly as shown.

Variables

Variables appear in lowercase letters. They represent user-supplied names or values.

\blacktriangleright *required_variable* \blacktriangleleft

Required

items

Required items appear on the horizontal line (the main path).

\blacktriangleright COMMAND_NAME — *required_variable* \blacktriangleleft

Optional

items

Optional items appear below the main path.



Choice of items

If you can choose from two or more items, they appear vertically, in a stack.

If you *must* choose one of the items, one item of the stack appears on the main path.

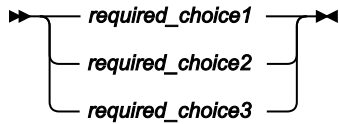

If choosing one of the items is optional, the entire stack appears below the main path.

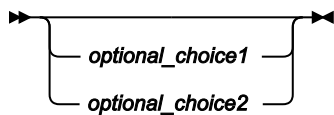

If a default value applies when you do not choose any of the items, the default value appears above the main path.

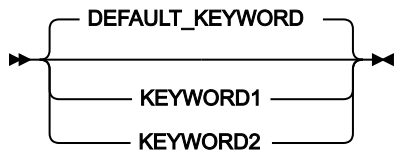

Repeatable items

An arrow returning to the left above the main line indicates an item that can be repeated.

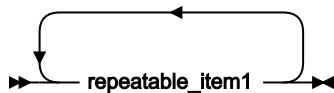

If you need to specify a separator character (such as a comma) between repeatable items, the line with the arrow returning to the left shows the separator character you must specify.

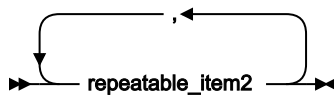

Fragments

Where it makes the syntax diagram easier to read, a section or *fragment* of the syntax is sometimes shown separately.

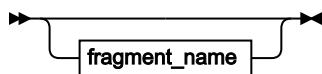

fragment_name

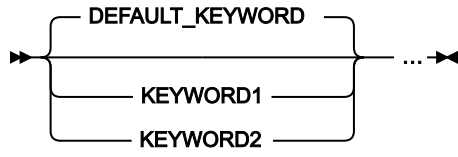

Summary of changes

June 2026, changes for V16R1M4

This edition of the document provides information applicable to File Manager Version 16 Release 1 Modification Level 4. It contains minor changes and clarifications to the information in the previous version.

February 2026, changes for V16R1M3

This edition of the document provides information applicable to File Manager Version 16 Release 1 Modification Level 3. Here are the major changes to this document from the previous release.

- Support for the `PASSWORD=REMEMBER` option has been removed. Use `PASSWORD=PASSTICKET` for FM/CICS logon handling. See topic [Starting FM/CICS on page 16](#).

October 2025, changes for V16R1M2

This edition of the document provides information applicable to File Manager Version 16 Release 1 Modification Level 2. It contains minor changes and clarifications to the information in the previous version.

June 2025, changes for V16R1M1

This edition of the document provides information applicable to File Manager Version 16 Release 1 Modification Level 1. It contains minor changes and clarifications to the information in the previous version.

October 2024, changes for V16R1M0 First Edition

This edition of the document provides information applicable to File Manager Version 16 Release 1 Modification Level 0. It contains minor changes and clarifications to the information in the previous version.

Part I. Working with FM/CICS

Chapter 1. FM/CICS overview

FM/CICS is a powerful set of utility functions for editing, browsing, printing, and altering the status of CICS® resources. The CICS resources supported are files, temporary storage queues, transient data queues, and data tables. If you have the authority, you can also modify the status of the CICS resources. FM/CICS incorporates much of the functionality of the File Manager Base component into the CICS environment.

FM/CICS uses IBM® ADFz Common Components to display panels on CICS with a similar capability to ISPF panels. FM/CICS panels allow you to select options and to specify parameters, commands, and program function (PF) keys to simplify requests for common functions. FM/CICS panels provide full-screen format for information display and editing.

The main functions provided by FM/CICS are:

- The ability to view or edit CICS resources.
- The ability to list CICS resources and change their status and attributes.
- The ability to run the File Manager Base component under FM/CICS, hence using it without requiring ISPF. This includes the ability to use File Manager Base component tools and utilities against FM/CICS resources when running under FM/CICS.
- The ability to run File Manager IMS Component (FM/IMS) under FM/CICS, using it without requiring ISPF.

The CICS resources that are supported are:

- Files (VSAM and data tables only).
- Temporary storage queues.
- Transient data queues.

Chapter 2. System requirements for File Manager for CICS®

FM/CICS supports:

- CICS® Transaction Server for z/OS® Version 6.3
- CICS® Transaction Server for z/OS® Version 6.2 (750)
- CICS® Transaction Server for z/OS® Version 6.1 (740)
- CICS® Transaction Server for z/OS® Version 5.6
- CICS® Transaction Server for z/OS® Version 5.5
- CICS® Transaction Server for z/OS® Version 5.4

For the complete list of software supported by File Manager, see the topic about Supported software environments in the *File Manager Customization Guide*.

Where variations exist within FM/CICS depending on the version of CICS® you are using, these variations are highlighted in this document by indicators that identify the start and end of a section of text.

Chapter 3. Getting started with FM/CICS

This chapter is designed to help the new user to familiarize themselves with the user interface and general methods for working within FM/CICS panels.

Starting FM/CICS

You can invoke FM/CICS:

- By submitting a batch job, or
- Directly (if FM/CICS has been configured to connect to ADFzCC server).

To start FM/CICS, enter the transaction name for File Manager:

```
FM userid (invocation options)
```

To run FM/CICS from another CICS® application, code this command:

```
EXEC CICS LINK PROGRAM('FMN3CICS') COMMAREA('FM userid (invocation options)')
```

Where:

FM

- For the transaction invocation, this is the default transaction name for File Manager.



Note: The default transaction name, FM, may have been changed at your site during installation due to local standards or other reasons. If you change this value, then you must also change the FMN3POPT options module to reflect the current transaction identifier for the (BACKGROUND) option to work.

- For the coded command (when running from another CICS application), this is required and must be the first two characters in the COMMAREA

userid

Is optional. Each FM/CICS user is required to provide an MVS userid and (on the next panel) the password. If you omit the userid then:

- If you sign on using CESN and the product is installed with `*DEFAULT=SIGNON`, the user ID defaults to the signed-on user ID.



Note: The `PASSWORD=REMEMBER` option is no longer supported.

- If you have not signed on, then you are prompted for a userid before the logon panel is presented.

invocation options

These options allow you to specify how you want to invoke FM/CICS. You specify them within parentheses, separated with a space:

START=BATCH

Invokes FM/CICS by submitting a batch job. You only need to specify this option if the installation option is set to START=TASK and you want to override it.

START=TASK

Invokes FM/CICS directly (non-batch). You only need to specify this option if the installation option is set to START=BATCH and you want to override it.

BACKGROUND

Instructs FM/CICS to run non-terminal processing in a background task.

Once a valid userid has been specified to the FM transaction, FM/CICS displays the File Manager for CICS Logon panel. There are two forms of this logon panel:

- The batch invocation panel is displayed when `START=BATCH` is in effect at logon. It submits a batch job that invokes FM/CICS.
- The non-batch invocation panel is displayed when `START=TASK` is in effect at logon.



Note: The File Manager for CICS Logon panel is displayed for every user the first time the FM transaction is entered. The File Manager for CICS logon panel is displayed when logon processing is required.



Note: The `PASSWORD=REMEMBER` option is no longer supported.

1. On the File Manager for CICS Logon panel, enter your password in the **Password** entry field.

The **Password** entry field is normally the only field on the File Manager for CICS Logon panel in which you need to enter details (all the entry fields are prefilled). If this is the case, go to [Step 9 on page 18](#).

2. To change the current password for the MVS userid, enter the new password in the **New Password** field. The new password must comply with the password rules for your system. If the new password is valid, you are prompted to enter the new password again to confirm. If you enter the same password again, your new password is accepted.

(Non-batch invocation only.) You can enter a passphrase of up to 100 characters.

3. (Batch invocation only.)

If necessary, specify the node on which the job is to run in the **Node** field. A `/*ROUTE XEQ node.user` statement is added after the job card to run the job on the specified machine.

4. (Batch invocation only.)

If necessary, in the **Procedure** field, specify the procedure name for running File Manager on your system. This must be available from an active procedure library. The installation default procedure is `FMN3CICB`.

5. If necessary, in the **Profile data set** field, specify the name of the profile data set to be used to save session information for subsequent invocations. The userid must have access to create and update the specified data set, or the batch job fails. If the data set does not exist, the batch procedure creates it. If the data set exists, it must be a fixed-blocked partitioned data set (preferably a PDSE, if possible) with LRECL of 80.
6. If necessary, in the **Prefix** field, specify the prefix to be used as the high-level qualifier when specifying unquoted data sets during the File Manager session. If you do not want prefixing on unquoted data set names, leave this field blank.
7. (Batch invocation only.)

If necessary, in the **Jobcard** entry field lines, edit the jobcard details for the submitted job.

The jobcard can use the following variables which are substituted when the job is submitted:

&TERM

The current 1–4 character terminal ID is substituted.

&USER

The current 1–7 character MVS userid is substituted.



Note:

- a. You can terminate the variable with a period which will also be removed during substitution.
- b. The jobcard should be unique and assigned to a class where it will run immediately.

8. (Non-batch invocation only.)

The **Port** field shows the port number used to connect to the ADFzCC server .

The **Host name** field shows the name of the system where the ADFzCC server is running. If it is blank, then FM/CICS obtains and uses the host name of the current system.

9. To submit the batch job that invokes FM/CICS, press Enter.

When the job is submitted, the logon panel waits for 20 seconds for the job to start and respond. If the job has not responded, it issues a "Job not responding" message. You need to check on the status of the job and either press F5 to wait a further 20 seconds, or press Enter to resubmit the job with any applicable changes. Look up the error message number in the *File Manager for z/OS® User's Guide and Reference* for further information if the job is not responding.

FM/CICS displays the FM/CICS Primary Option Menu.

10. For View (option 1), Edit (option 2), and Print (option 3.2, reached by means of Utilities, option 3), you must specify the **CICS Resource**. The **CICS Resource** option setting on the Primary Option Menu is not used by the other functions.
11. Select the option you want by typing the corresponding highlighted number on the command line.

For example, to edit a CICS file:

- a. Set the **CICS Resource** option to 1 (File).
- b. Type 2 (Edit) in the command line.
- c. Press Enter.

Related topics

[File Manager for CICS Logon panels on page 111](#)

[Primary Option Menu panels on page 121](#)

Checking your FM/CICS version

To display the full version information for FM/CICS, enter VER on the command line of any panel. The current FM/CICS version number and the PTF number for each File Manager component is displayed in a window. The window also indicates whether or not FM/CICS is APF-authorized.

Figure 3. Window showing the current FM/CICS version number and PTF information

```

Process  Options  Help
-----
FM/CICS                               Primary Option Menu

IBM File Manager for z/OS Version x Release x Modification x
CICS Component
(not APF authorized)

Service Levels of installed components

English      Base      IMS      Db2      CICS      IPV
xxxxxxx     xxxxxxx  xxxxxxx  xxxxxxx  xxxxxxx  xxxxxxx
Japanese     xxxxxxx  xxxxxxx  xxxxxxx  xxxxxxx  xxxxxxx

PF  1=HELP    2=TOP    3=END    4=RETURN  5=BOTTOM  6=LOCATE
PF  7=UP      8=DOWN  9=PRINT 10=LEFT  11=RIGHT  12=CRETRIEV

Command ==> ver
F1=Help    F3=Exit    F4=CRetrieV F7=Backward F8=Forward  F10=Actions
F12=Cancel

```

Related topics

[VER primary command on page 74](#)

Checking the level of connected CICS systems

To display the level of connected CICS systems, enter VERCICS on the command line of any panel. The current level for each connected CICS system is displayed in a window.

The VERCICS command queries the version, PTF, and level information of FM/CICS on the local and connected CICS regions. The retrieved information is then compared against the version, PTF, and level of the running File Manager batch job and the results are displayed. Any FM/CICS value that differs from the File Manager batch job is also highlighted.

Any difference in version, PTF, or level can cause a failure due to services not being available in the downlevel instances. A difference might be due to maintenance not being applied to the FM/CICS instance or the FM/CICS programs might not have been refreshed in the CICS region after maintenance was applied.

Figure 4. Window showing the level of connected CICS systems

```

Process  Options  Help
-----
FM/CICS                                Primary Option Menu
                                     CICS Levels
IBM File Manager for z/OS Version x Release x CICS Component
Current PTF: V8GAD4B      Level: 2

  Connected FM/CICS Levels
  Sysid    Applid    Version    PTF        Level
  xxxx    xxxxxxxx   xxxx      xxxxxxxx   x
  xxxx    xxxxxxxx   xxxx      xxxxxxxx   x
  xxxx    xxxxxxxx   xxxx      xxxxxxxx   x

Command ==>
F1=Help    F3=Exit    F4=CRetriev F7=Backward F8=Forward  F10=Actions
F12=Cancel

F12=Cancel
    
```

In the above example, there are 2 connected CICS regions all at the same level. If the level or version are different, these values are highlighted in red. To avoid unforeseen errors, ensure that all connected systems are running the same level of File Manager.

If program FMN3LVL is not available on a connected system, the text "LOAD ERROR condition" is displayed. In this case, check that FMN3LVL can be loaded on the connected CICS region and retry the VERCICS command.

Related topics

[VERCICS primary command on page 74](#)

Exiting from FM/CICS

To exit from FM/CICS from the Primary Options Menu panel, do one of the following:

- Press the Exit function key (F3)
- Enter `x` (or `EXIT` or `END`) on the command line
- Select **Process> Exit** from the Action Bar

To exit the application from any panel within FM/CICS:

- Enter `=x` (or `=EXIT` or `=END`) on the command line.

Using the FM/CICS interface

The FM/CICS interface is based upon the ISPF model, using ADFz Common Components. Tasks are performed by processing a function, together with its applicable parameters. Panels provide a user-friendly way of selecting a function and supplying the parameter information.

Moving from panel to panel

You move from panel to panel in FM/CICS in the same way as you do under ISPF. That is, you launch processing panels from menu panels, by entering the appropriate menu option number on the command line. FM/CICS uses a Primary Options Menu panel to provide access to processing panels that are related to a particular function or group of functions. In some cases, an option on the Primary Options menu leads to another menu panel, from which you can select the required processing panel.

When you know the menu structure well, you can quickly jump to the required panel by entering the full pathway through the menu options. For example, entering `3.2` from the Primary Option Menu panel takes you to one of the Print Entry panels. Entering a relative path in this way allows you "jump over" intermediary panels that you would otherwise need to navigate through.

You can also jump to any FM/CICS panel from any other panel, without having to navigate the menu structure, by using an equals sign (=) to prefix the option number. The equals sign instructs FM/CICS to start the menu navigation from the Primary Options Menu panel and not from your current location. For example, if you are positioned on the Utility Functions panel, entering `2` on the command line displays the Print CICS File Entry panel (option 2 on the current menu), while entering `=2` displays the Edit CICS File Entry panel (option 2 on the Primary Options Menu panel).

To access a panel, choose one of the following methods:

- If necessary, navigate your way back to the Primary Option Menu panel (by pressing the Exit function key (F3) one or more times), then type the menu option number on the Command line and press Enter. Repeat for each nested menu until the required processing panel is displayed.
- Type an equals sign followed by the complete menu path to the required panel, separating each menu level with a period, then press Enter.

To exit from any panel, choose one of the following:

- Press the Exit function key (F3).
- Type `END` on the on the Command line and press Enter.

Showing more information on a panel

Many FM/CICS panels have more information than can be seen in a single screen, particularly when you are running in 80x24 display. When this happens, a message (`More: +`) is displayed in the top right corner of the panel.

Figure 5. Example panel showing "More" message

```

Process  Options  Help
-----
FM/CICS          Print CICS File Entry Panel
                                     More:  +
Input CICS VSAM File:
  File name . . . . .
  Sysid . . . . .
  Start key . . . . .
  Skip count . . . . .          key or slot
  Print count . . . . . ALL     number of records to be skipped
  :                             number of records to be printed

```

To scroll down the panel, choose one of these methods:

- Press the Forward function key (F8) (this scrolls down by your default scroll amount, usually one screen at a time).
- Enter DOWN on the command line (this command scrolls down by your default scroll amount, usually one screen at a time).

To scroll back to the top of the panel, choose one of these methods:

- Press the Backward function key (F7) (this scrolls up by your default scroll amount, usually one screen at a time).
- Enter UP on the command line (this command scrolls up by your default scroll amount, usually one screen at a time).

Related topics

[Primary Option Menu panels on page 121](#)

Scrollable input and display fields for long names

Some FM/CICS panels have *scrollable fields* that allow you to input or view longer values than can be displayed at the one time.

There are two types of scrollable fields on FM/CICS panels:

Input fields

The fields on FM/CICS panels where you can *enter* information, such as the start position on the Browse, Edit, or View entry panels.

Display fields

The fields on FM/CICS panels that *display* information as a result of some action you have taken.

Scrollable fields have one of the following characters after the end of the entry field:

+

Plus sign. Indicates the field is scrollable to the right

-

Minus sign. Indicates the field is scrollable to the left

+-

Plus sign and minus sign. Indicates the field is scrollable to the right or left

If the length of the field displayed on the panel is insufficient for the value you want to input or view, you can either:

- Progressively scroll to the right with the Right function key (F11) or by entering the RIGHT primary command (with the cursor positioned within the field), or
- Press the Expand function key (F4) if available, or enter the EXPAND or ZEXPAND primary command, to display a pop-up window that allows you to input or view the whole field.

In the expand pop-up window, you can toggle the view of the data between character and hex by issuing the commands HEX OFF and HEX ON.

Deleting data in scrollable input fields

If you want to delete all the data in a field that is displayed as a scrollable input field, take care to ensure that you do, in fact, delete all the data (and not just the displayed data).

If you use the field delete key combination to delete data, FM/CICS deletes only the data that is currently displayed. If the field contains more data than is displayed, the undisplayed data is left undeleted.

 **Tip:** Before deleting data in a field that is displayed as a scrollable field, first display the entire contents of the field by pressing the Expand function key (F4) or entering the EXPAND primary command. You can then use the field delete key combination to delete all data in the field at once.

For more information about working with scrollable fields, see the section "Primary commands for scrollable fields" in the *ISPF Dialog Developer's Guide and Reference*.

Issuing commands

Within the FM/CICS panels, you can use "primary" and "prefix" commands to instruct FM/CICS to perform an action.

You enter *primary* commands on the command line of FM/CICS panels. On many of these panels, the most commonly used primary commands have been assigned to function keys, also known as Programmable Function keys or PF keys.

Some primary commands are exclusive to a particular panel, although most are available on several panels. Where a command is available on more than one panel, its behavior might differ depending upon the context in which it is used.

You can enter *prefix* commands in the prefix field provided in most panels, and in the prefix area within the Edit panel. Prefix commands are generally exclusive to a panel and details of their operation are provided within each panel description.

Related topics

[FM/CICS primary commands on page 71](#)

[Edit Entry panels on page 99](#)

Specifying resource names

Before we describe each function in detail, we need to describe how we specify a CICS resource to File Manager. FM/CICS provides specific functions to process your CICS resources. These are referred to as CICS ONLY functions.

When entering the CICS ONLY resource name, the following applies:

Resource name

- 1–8 character file name
- 1–16 character temporary storage queue
- 1–4 character transient data queue

The resource name is used in conjunction with SYSID and POOLNAME (TS queues only) to produce a list of matching resources.

You can enter a fully-qualified or generic resource name. In a generic resource, use the percent sign (%) to represent a single character, and an asterisk (*) to represent any number of characters.

CICS temporary storage and transient data queue names can be mixed-case. Therefore, the resource name input fields for these resource types throughout the FM/CICS interface are case sensitive.

Also, CICS temporary storage queue names can contain unprintable characters. To view or enter the TS queue name in hex, place the cursor on the queue name input field and enter the EXPAND primary command (or equivalent function key). Enter the HEX ON command from within the expand pop-up panel to view and enter hex values.

SYSID

Default value is blank. This field contains the ID of the CICS systems where the resource resides. A blank value defaults to the local system. You can enter a fully-qualified or generic SYSID. In a generic SYSID, use the percent sign (%) to represent a single character, and an asterisk (*) to represent any number of characters.



Note:

FM/CICS can process CICS resources that are owned by a region other than the region where FM/CICS is running if:

- An active connection between the current region where FM/CICS is running and the remote region that owns the resource is active, and
- The FM/CICS program, FMN3CICS, is available on the remote region.

To process a remote CICS resource, you must specify the SYSID that owns the resource on the FM/CICS panels (generics are allowed). A remote definition on the local CICS region for the remote resource is not required by FM/CICS. In addition, specifying a blank SYSID value for a remote CICS resource that is owned by another region causes "not found" condition.

For further information, see the *File Manager for z/OS Customization Guide*.

TS Pool name

(TS Data sharing only.) Default value is blank. This field is used to specify the pool name of a shared temporary storage pool and temporary storage processing is shipped to a temporary storage server that manages the pool. You can enter a fully-qualified or generic pool name. In a generic pool name, use the percent sign (%) to represent a single character, and an asterisk (*) to represent any number of characters.

If you specify a **SYSID** value *and* a **TS Pool name**, then a list of queues that match either is produced from which you can select the appropriate queue for processing.

A resource selection list is produced when any one of the following conditions is met:

- A generic resource name is entered
- A generic sysid value is entered
- A generic pool name is entered (temporary storage only)
- A pool name and sysid value are both specified (temporary storage only)

Specifying a data set and a member name

Some FM/CICS panels require you to specify the data set that you wish to use for a copybook or template. When the data set is a PDS or a CA-Panvalet or other external library, you must also specify the member name.

Figure 6. Data set name specification fields

```

:
Copybook or Template:
  Data set name . . _____
  Member . . . . . _____ Blank or pattern for member list
:
    
```

To specify your copybook or template:

1. In the **Data set name** field, enter a fully-qualified data set name or a name pattern. The name may include a member name or name pattern in parenthesis. If the member is specified here, the associated **Member** field must be empty.

In the case of a copybook, this can be the name of a CA-Panvalet library or external library accessed using the Library Management System Exit.

If you do not enclose the data set name in quotation marks, then the default High Level Qualifier (HLQ) is used. The HLQ is specified in the **Prefix** field on the File Manager for CICS Logon panel.

If you enter a pattern, when the panel is processed FM/CICS displays a list of the data sets that match the pattern.

Patterns can contain a percent sign (%) to represent a single character, and an asterisk (*) to represent any number of characters within one qualifier. Two asterisks (**) represent any number of characters within any number of qualifiers.

For performance reasons, you should qualify the data set name as much as you can.

2. If you specified the name of a partitioned data set (PDS) or a CA-Panvalet or other external library in the **Data set name** field (without including a member name or name pattern in parenthesis), then enter a name or name pattern in the **Member** field.

A member name pattern can consist of any characters that are valid in a member name and the following two special pattern characters:

asterisk (*)

Represents any number of characters. As many asterisks as required can appear anywhere in a member name. For example, if you enter *d*, a list of all members in the data set whose name contains "d" is displayed.

percent sign (%)

A place-holding character representing a single character. As many percent symbols as necessary may appear anywhere in a member name. For example, if you enter %%%%, a list of all members in the data set whose name is four characters in length is displayed.

If you perform either of these actions:

- Do not include a member name or name pattern in parenthesis in the **Data set name field**, and leave the **Member** field blank or you specify a pattern in the **Member** field,
 - Include a member name pattern in parenthesis in the **Data set name field** and leave the **Member** field blank, FM/CICS displays a member name list when the panel is processed and the data set has been specified or selected.
3. Complete the remaining panel-specific fields, and then press Enter to process the panel function.

If both the data set name and the member name have been fully specified, the panel action proceeds to its next stage.

If you entered a pattern for the data set name or member name, the data set selection panel is displayed, followed by the member selection panel, as needed. When you have made your selections from these panels, the Entry panel action proceeds to its next stage.

4. When the data set selection panel is displayed, select your data set by entering an s in the **Sel** field adjacent to the required data set. You can only select one name from this list.
5. When the member selection panel is displayed, select a member by typing an s in the **Sel** field next to the member or with the SELECT primary command, and then pressing Enter.

Because you are selecting a copybook or template, you select only one name.

**Note:**

- a. To reset values entered in the prefix area that have not yet been processed, use the RESET primary command.
 - b. To re-read the directory and display the current member list, use the REFRESH primary command.
6. When you are selecting a member, you might find it useful to sort the list of displayed members. To do this, perform one of these actions:

- Use the SORT primary command to sort the member list by up to two of the displayed columns. The field names are the column headings. For example, `SORT SIZE CREATED` sorts the list of members first by size and then by the date created.
- Place the cursor on the column header of the column you want to sort and press Enter.



Note: When you sort members, the sequence (ascending or descending) for a given column is predetermined and consistent with ISPF.

Examples of data set name patterns

The examples below assume that the following data sets exist under the USERID high-level qualifier:

```
USERID.FMN.DATA
USERID.FMN.TEMPLATES
USERID.COBOL.COPY
USERID.COBOL.SOURCE
USERID.PLI.COPY
USERID.PLI.SOURCE
USERID.MISC.DATA.BACKUP
USERID.WORK
```

Example 1

Entering the following pattern (with a single asterisk):

```
'USERID.*'
```

displays the only item with exactly one level of qualifier after USERID:

```
USERID.WORK
```

Example 2

Entering the following pattern (with two asterisks):

```
'USERID.**'
```

displays the complete list of data sets with the USERID high-level qualifier.

Example 3

Entering the following pattern:

```
'USERID.*.%%%'
```

displays the following list (containing those data sets with exactly three qualifiers, whose third-level qualifier contains exactly four characters):

```
USERID.FMN.DATA
USERID.COBOL.COPY
USERID.PLI.COPY
```

Examples of specifying a member name or pattern

The examples below assume that the following members exist within the data set name, FMNUSER.DATA:

```
DATA1
FMNCDATA
FMNCTAM
FMNCTEM
FMNCTMP
NEWDATA
NEWSTUFF
TEMPA
TEMPB
```

Example 1

Entering the following details on a panel:

```

:
:  Data set name . . . . . FMNUSER.DATA
:  Member . . . . . -----
:
:
```

displays the entire member name list:

```
DATA1
FMNCDATA
FMNCTAM
FMNCTEM
FMNCTMP
NEWDATA
NEWSTUFF
TEMPA
TEMPB
```

Example 2

Entering the following details on a panel:

```

:
:  Data set name . . . . . FMNUSER.DATA
:  Member . . . . . FMNCT*
:
:
```

displays the member name list:

```
FMNCTAM
FMNCTEM
FMNCTMP
```

Example 3

Entering the following details on a panel:

```

:
:  Data set name . . . . . FMNUSER.DATA(NEWDATA)
:  Member . . . . . _____
:
:
```

uses the specified template or cookbook NEWDATA in data set FMNUSER.DATA.

Example 4

Entering the following details on an Entry panel:

```

:
  Data set name . . . . . FMNUSER.DATA(TEM*)
  Member . . . . .
:
    
```

displays the member name list:

```

TEMPA
TEMPB
    
```

Example 5

Entering the following details on a panel:

```

:
  Data set name . . . . . FMNUSER.DATA(*)
  Member . . . . .
:
    
```

displays the entire member name list:

```

DATA1
FMNCDATA
FMNCTAM
FMNCTEM
FMNCTMP
NEWDATA
NEWSTUFF
TEMPA
TEMPB
    
```

Specifying quoted strings

Throughout the FM/CICS interface, there are places where you need to specify a *quoted string*, for example, fully qualified data set names. In these situations, you can use either the double quotation symbol ("), also called simply a quotation mark, or the single quotation symbol ('), also called an apostrophe. However, you must use matching symbols to open and close the quoted string. For example:

- "fmndata.test1" and 'fmndata.test1' are both legitimate ways to specify a data set.
- "fmndata.test1' or 'fmndata.test1" are rejected.

The simplest way to include an apostrophe or quotation symbol as a character is to use the opposite character as the string delimiters. For example:

```

"it's"
OR
'he said, "hello"'
    
```

When your string contains a mix of apostrophes and quotation marks, use two consecutive quotation marks ("" to represent a " character within a string delimited by quotation marks, or two consecutive apostrophes ('' to represent a ' character within a string delimited by single quotation marks. For example, to find the string, "he said, "Take it it's yours.", you would type:

```
FIND 'he said, "Take it it''s yours."'
```



Note: In this document the words *quotation marks* or *quotes* mean either " or '.

Using hexadecimal values in FM/CICS

In many FM/CICS panels, you can view and enter decimal values as text characters or as hexadecimal values. To help you quickly convert decimal values to hexadecimal or hexadecimal values to decimal values, FM/CICS provides a simple converter tool, in the form of two primary commands.

To convert a decimal value to its equivalent hexadecimal value:

1. On the command line of any panel, enter `DX` followed by the decimal value.

FM/CICS displays the results in a message at the bottom of your screen.

For example, if you enter `DX 10` on a FM/CICS command line, then FM/CICS displays the following message box:

```
Dec 10 = hex 0000000A
```

To convert a hexadecimal value to its equivalent decimal value:

1. On the command line of any panel, enter `XD` followed by the hexadecimal value.

FM/CICS displays the results in a message at the bottom of your screen.

For example, if you enter `XD 10` on a FM/CICS command line, then FM/CICS displays the following message box:

```
Hex 00000010 = dec 16
```

Related topics

[DX primary command on page 72](#)

[XD primary command on page 74](#)

Getting help

FM/CICS offers two levels of help information: context-sensitive field information and Tutorial Help. The field help information provides a description of your current field, lists the valid values or range of values that can be entered, and gives the default field value where applicable. Tutorial Help is a context-sensitive help system that provides detailed explanations of the FM/CICS panels and the processes in which they are used. In addition, all error messages have an associated full text explanation, which can help you to determine the cause of a problem.

Displaying field help information

To display the field help information:

1. Place your cursor on the field entry line.
2. Press the Help function key (F1). The field help information is displayed in a pop-up window.

If further information is needed, press the Extended Help function key (F5), to access the Tutorial Help page for the current panel.

Pressing Help while the field information window is displayed takes you to the Help Tutorial page within the Tutorial Help system (that is, the page that describes how to use Tutorial Help).

3. When you have finished reading the message or the relevant Tutorial Help page, press the Exit function key (F3) to return to your starting panel.

For example, [Figure 7: Field help information for the Sysid field on page 32](#) shows the message seen when F1 is pressed from the **Sysid** field in the Edit CICS File Entry panel.

Figure 7. Field help information for the Sysid field

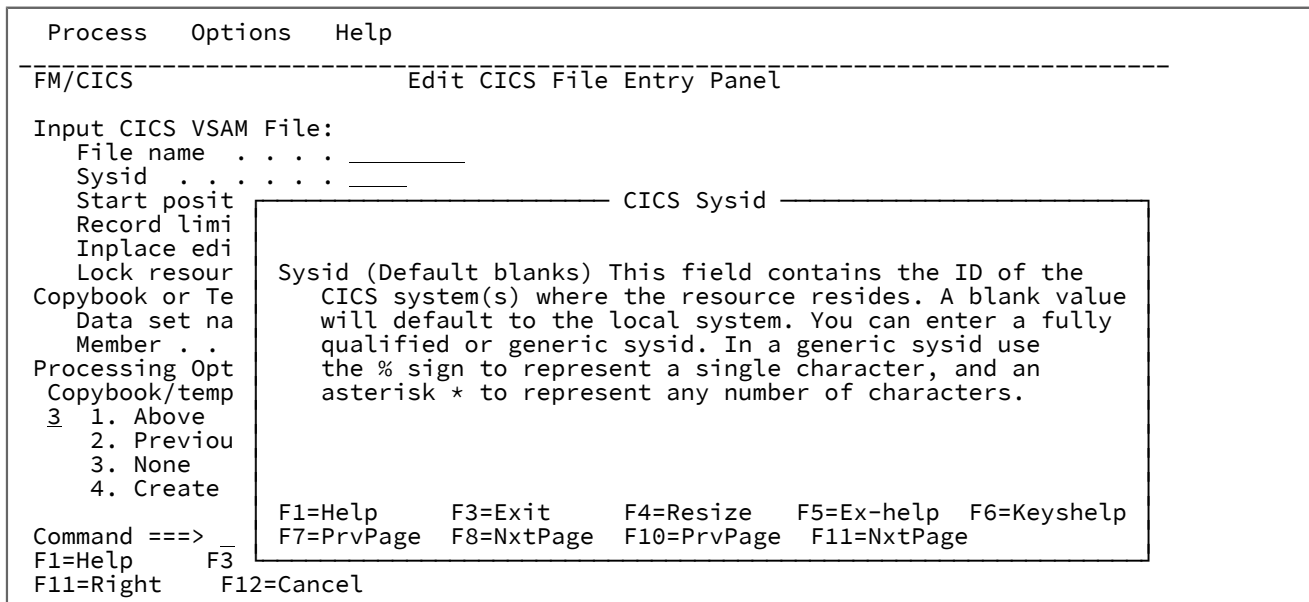

Accessing Tutorial Help

The Tutorial Help system is both context-sensitive and structurally organized. You can get directly to the information you need, using the context-sensitive access method or you can enter the Help system at a specific location and navigate to any topic information within the structure.

To access a context-sensitive Tutorial Help page:

1. Place your cursor on the Command Line or anywhere in the panel that is outside of a field entry line.
2. Press F1. The Tutorial Help page associated with the current panel is displayed.

When you access the Tutorial Help in this way, the first page that is displayed may be a main topic page, with a menu listing the associated sub-topics, or it may be a sub-topic page, depending upon the context from which you started.

3. Navigate through the Tutorial Help pages, to find the information you require (see below for a list of navigation commands).
4. When you have finished, press F3 (Exit) to return to your starting panel.

The Tutorial Help system is organized with a Table of Contents structure that is based upon the FM/CICS Primary Options menu. Each entry within the Table of Contents leads to a main topic with a number of associated sub-topics. In addition, there is an index that lists selected topics from the Tutorial Help, alphabetically by subject.

To choose your starting point in Tutorial Help:

1. Select the Help pull-down menu from any panel Action Bar.
2. Enter the option number for the Tutorial Help entry point that you require. These are:

1. Help for help

Displays the Help panel for the Tutorial Help system.

2. Extended help

Displays the Tutorial Help panel associated with the current FM/CICS panel (equivalent to pressing F1 from the FM/CICS panel). When on the Primary Options menu, this is the Tutorial Help Table of Contents panel.

3. Keys help

Displays a panel that provides help for the Function Keys that are active on the current FM/CICS panel.

4. Help index

Displays the Help Index.

5. Tutorial

Displays the Tutorial Help Table of Contents panel.

6. About

Displays the FM/CICS version and release information in a pop-up window.

7. News about FM/CICS

Displays a panels providing general information about the current FM/CICS version/release.

To navigate Tutorial Help, enter one of the following commands in the Command line on any Tutorial page:

BACK or B

To back up to the previously viewed page.

SKIP or S

To skip the current topic and go on to the next topic.

UP or U

To display a higher level list of topics.

TOC or T

To display the Table of Contents.

INDEX or I

To display the Tutorial Index. Once the Index has been displayed, use the RIGHT (F11) and LEFT (F10) keys to scroll through the list, then position your cursor on a subject and press ENTER (Ctrl) to display the topic.

Alternatively, you may use the following keys whenever you are in the tutorial:

ENTER (Ctrl)

To display the next sequential page within a topic.

HELP (F1)

To display the Help Tutorial page within the Tutorial Help system (that is, the page that describes how to use Tutorial Help).

END (F3)

To terminate the tutorial.

UP (F7)

To display a higher level list of topics (instead of typing UP).

DOWN (F8)

To skip to the next topic (instead of typing SKIP).

RIGHT (F11)

To display the next sequential page within a topic (instead of pressing ENTER).

LEFT (F10)

To display the previous sequential page within a topic (instead of typing BACK).



Note: The listed keys are the default key mappings. As you can customize key mappings, they may be different on your system.

Viewing error messages

If an error occurs when FM/CICS attempts to process a panel, a short text message displays in the upper right corner of the screen. While this message is displayed, pressing F1 displays the expanded text of the error message at the bottom of the screen.

Figure 8: Utility Functions panel showing expanded message on page 35 shows the short text message "Empty print data set" (in upper right corner) with the expanded text (shown in bold) at the bottom of the screen.

Figure 8. Utility Functions panel showing expanded message

```

Process  Options  Help
FM/CICS                                Utility Functions          Empty print data set

0 DBCS          Set DBCS data format for print
2 Print         Print data
4 List         List resources
5 Printdsn     Browse FM/CICS print data set
6 Audit trail  Print audit trail report

Processing Options:
CICS Resource
1 1. File
   2. Temporary Storage
   3. Transient Data

The PRINTDSN print data set FMUSERFMNCICS.LIST is empty
Command ==>
F1=Help   F3=Exit   F4=CRetriev F7=Backward F8=Forward  F10=Actions
F12=Cancel

```

Customizing your FM/CICS session

You can customize FM/CICS so that its behavior is best suited to your needs. The following sections describe how you can change your screen layout and function key values.

Hiding or showing PF key descriptions

Use the PFSHOW primary command (from any FM/CICS panel) to either show or hide the PF key descriptions on FM/CICS panels.

- To *show* the PF key descriptions, type `PFSHOW ON` on the command line and press Enter.
- To *hide* the PF key descriptions, type `PFSHOW OFF` on the command line and press Enter.
- To *toggle* between showing or hiding the PF key descriptions, type `PFSHOW` on the command line and press Enter.

Related topics

[PFSHOW primary command on page 72](#)

Changing terminal characteristics

Use the SETTINGS primary command (from any FM/CICS panel) to change various options and terminal characteristics that affect the way information is displayed on your screen.

You can enter the SETTINGS primary command directly, or select it from the Options pull-down menu.

When you enter the `SETTINGS` primary command, FM/CICS displays the IPDCC Settings panel.

On the IPDCC Settings panel, set the ADFz Common Components settings according to your needs:

Command line at bottom

Enter a "/" to place the command line and long message line at the bottom of your panel. Deselecting the option places the command line and long message line as they are specified in your panel definition (usually at the top of the panel).

Panel display CUA mode

Enter a "/" to display the panel in CUA mode. Action bars are displayed. The action bars are not displayed if you deselect the option.

Tab to action bar choices

Enter a "/" to use the Tab key to position the cursor on action bar choices when not running in GUI mode.

Replace the "/" with a blank to NOT use the Tab key to position the cursor on action bar choices.

Graphic border

If the action bar separator line or borders are not displayed correctly, you can force dotted lines by deselecting the graphic border option.

Screen format

Specify the screen format you require by typing a value (1–3).



Note: Changing to 24x80 (STD) display may not change the screen size for expandable panels that have been previously displayed with the `DATA` or `MAX` option.

Terminal type

Specify the terminal type you require by typing a value (1–2).

Related topics

[SETTINGS primary command on page 73](#)

[IPDCC Settings panel on page 118](#)

Changing panel colors, intensity, and highlighting

Use the `CUAATTR` primary command (from any FM/CICS panel) to adjust panel colors, intensity, and highlighting.

When you enter the `CUAATTR` primary command, FM/CICS displays the Change CUA Attributes panel.

On the Change CUA Attributes panel, you can change the existing values by overtyping with any of the following values:

Color	Intensity	Highlight
RED	HIGH	NONE
PINK	LOW	BLINK
GREEN		REVERSE
YELLOW		USCORE
BLUE		
TURQ (turquoise)		
WHITE		

To restore a default value, clear the field and press Enter. To restore all default values, press F2 (Reset).

Related topics

[CUAATTR primary command on page 71](#)

[Change CUA Attributes panel on page 85](#)

Changing the current key list values

Use the KEYS primary command from any FM/CICS panel to display and modify the keys for the current function.

When you enter the KEYS primary command, FM/CICS displays the FMN Keylist Change panel.

On the FMN Keylist Change panel, set the keys for the current function according to your needs.

Related topics

[KEYS primary command on page 72](#)

[FMN Keylist Change panel on page 114](#)

Setting your default processing options

Many of the processing operations performed by File Manager utilize default values that can be set from within the FM/CICS application. By adjusting these values, you can customize FM/CICS so that its behavior is best suited to your needs. Your settings for these options are stored in your ADFz Common Components profile, and are invoked when you log in, regardless of which workstation you use.

You can update these default values by accessing the relevant processing option panel.

To access a processing option panel, use any one of the following methods:

- From the Primary Options Menu panel:
 1. Select Option 0 (Settings). The Set Processing Options Menu panel is displayed.
 2. Select the required processing options type from the menu.
- From any FM/CICS panel, use the **Options** pull-down menu to select the required processing options type:

Figure 9. Options pull-down menu

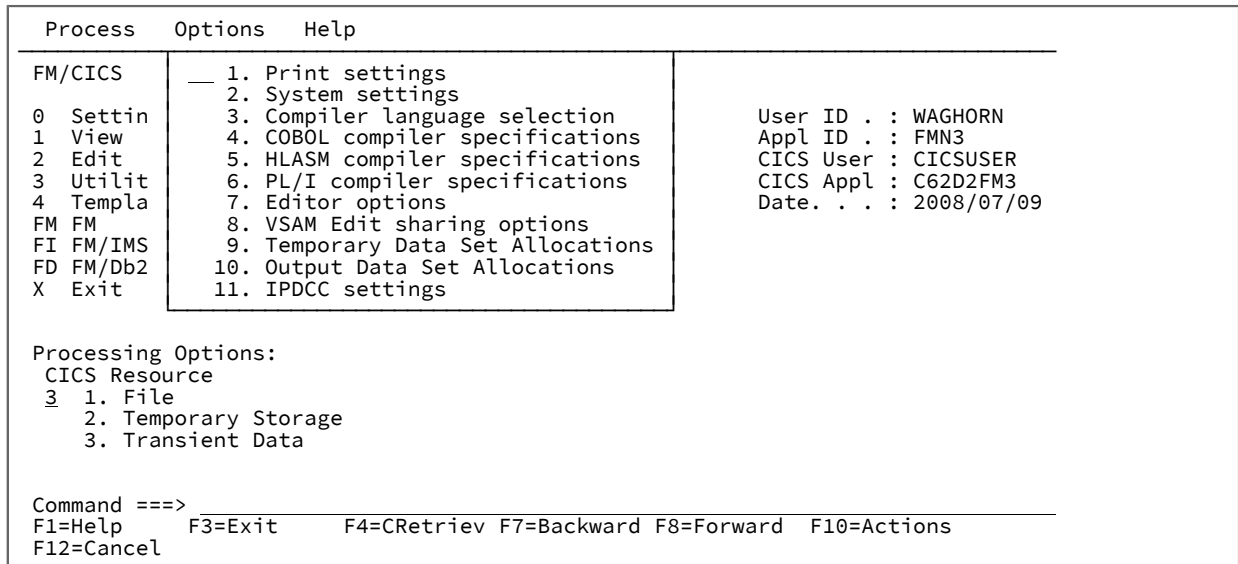

- On the command line of any FM/CICS panel, enter an equals sign (=), followed by the option number for the required processing type. For example, to display the Compiler Language Selection panel, enter =0.3.

When you select an option processing type, File Manager displays a panel listing those options and their current values. The following notes apply to all of these option panels:

- To change the value of an option, overwrite its current value.
- To save the options you have changed and exit the panel, press the Exit function key (F3).

Changes are saved in your ADFz Common Components user profile for future FM/CICS sessions. They remain in effect until you change the option again.

- To exit a panel without saving changes, press the Cancel function key (F12).
- To reset all options on the panel to their installation defaults, enter `RESET` on the command line.

Related topics

[Primary Option Menu panels on page 121](#)

[Set Processing Options panel on page 130](#)

Setting your System Processing Options

You set any of the processing options on the Set Processing Options panel (within FM/CICS) using the File Manager Base component, if authorized. When you select an option on the Set Processing Options panel, the relevant File Manager Base component panel is displayed.

For example, when you select option 1 (Print) on the Set Processing Options panel (from within FM/CICS), File Manager displays the Set Print Processing Options panel from within "base" File Manager.

To find information about each processing option on the Set Processing Options panel, see the relevant section in the File Manager User's Guide and Reference as shown in [Table 1: Sections in the base User's Guide and Reference describing processing options on page 39](#).

Table 1. Sections in the base User's Guide and Reference describing processing options

To find out more about this option on the FM/CICS Set Processing Options panel...	See this section in the "Base" User's Guide and Reference...
Print	<i>"Printing from File Manager"</i>
System	<i>"Setting your default processing options"</i>
LANG	<i>"Setting your template processing options"</i>
COBOL	<i>"Setting your COBOL processing options"</i>
HLASM	<i>"Setting your HLASM processing options"</i>
PL/I	<i>"Setting your PL/I processing options"</i>
EDIT	<i>"Editor options (option 0.6)"</i>
Sharing	<i>"VSAM edit sharing options (option 0.7)"</i>
Temporary	<i>"Temporary Data Set Allocations (option 0.8)"</i>
Output	<i>"Output Data Set Allocations (option 0.9)"</i>

Related topics

[Set Processing Options panel on page 130](#)

Running the File Manager Base function against CICS resources

If you choose the FM option from the Primary Options Menu panel, you start the File Manager Base component in a CICS environment. The main enhancement provided in the CICS environment is that you can run the File Manager Base component utilities, such as Data Set Copy and Data Set Compare, using CICS resources.

Specifying resource names in File Manager for z/OS® ("Base")

The following functions in File Manager for z/OS® (option "FM" on the Primary Options Menu panel within FM/CICS) also accept a CICS resource name in the primary data set field as well as the supported MVS data set names.



Note: The options below are from the File Manager Base component main menu, not the FM/CICS main menu.

Function	Option
View	1
Edit	2
Data create	3.1
Print	3.2
Copy	3.3
Find/Change	3.6
Compare	3.11

To distinguish the CICS resource name from an MVS data set name, the following prefixes (including the colon character) are used:

FI:

CICS file

TS:

CICS temporary storage queue

TD:

CICS transient data queue

The name following the resource follows the same rules as the resource names described above. For example, you could specify `FI:CICSPFI01`.



Note: The File Manager Base function can only be used with local CICS resources (resources owned by the CICS region running FM/CICS).

A resource selection list is produced when a generic resource name is entered.

Related topics

[Primary Option Menu panels on page 121](#)

Running File Manager IMS component under FM/CICS

There are no differences between the FM/IMS function running under ISPF and running under CICS. It is especially important to note that File Manager does not access CICS resources related to IMS.

Running File Manager Db2 component under FM/CICS

These File Manager Db2 functions are not available when running under CICS:

- FM/Db2 Object Functions (option 3.2).
- FM/Db2 Utility Job Generation (option 3.9).
- FM/Db2 Interactive Db2 (option 5).
- FM/Db2 line commands EE, VE, and RE which start another FM/Db2 session.

Chapter 4. Viewing and changing CICS resources

To view data stored in a CICS file, use the FM/CICS View Utility or the FM/CICS Edit Utility:

View Utility

The View Utility (option 1) allows you to view and temporarily change the data, but without the ability to save any changes.

When you initiate the FM/CICS editor with the View Utility, this is referred to as being in a "View editor session" (or just "View").

The view function, similar to ISPF view, provides an editor session that works essentially the same as the Edit Utility, but without the need for exclusive access to the data set. It presents you with an interface that is capable of holding your temporary changes to data. This may be useful, for example, for assessing a change but without any risk of altering live data.

The first time you make a change to the data in a View editor session, FM/CICS displays the following warning:

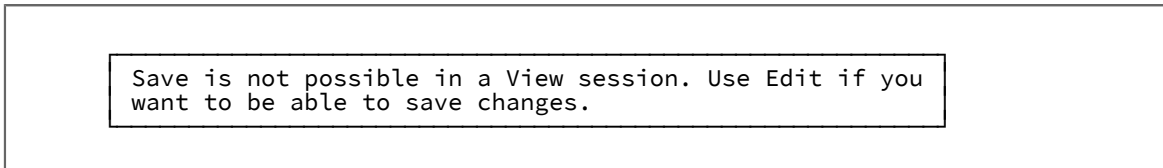

When you exit from a View editor session by pressing the Exit function key (F3), if you have made a change to the data in the editor session, FM/CICS displays a warning as shown in [Figure 10: Warning pop-up displayed when exiting from a View editor session if changes made to data on page 42](#).

Figure 10. Warning pop-up displayed when exiting from a View editor session if changes made to data

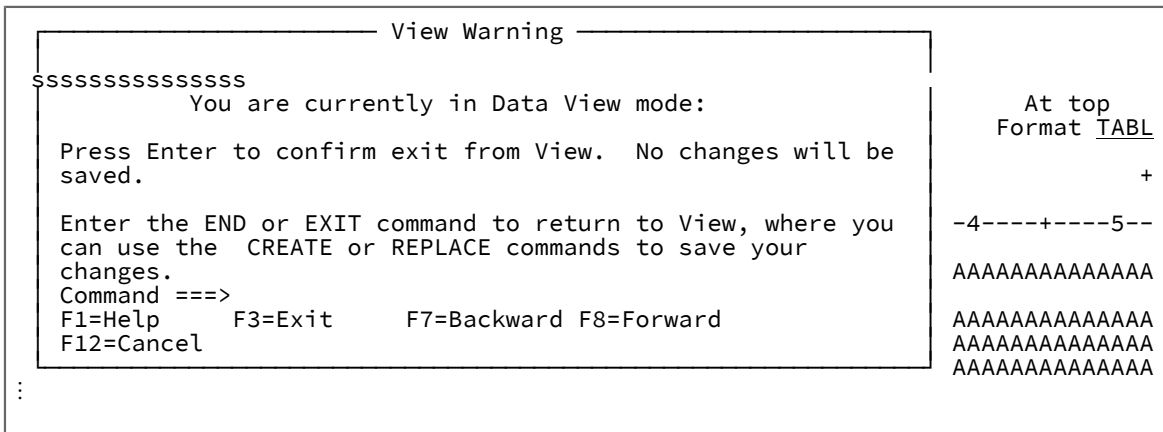

Edit Utility

The Edit Utility (option 2) allows you to view and change your data (by inserting, deleting, or otherwise modifying records), and save any changes you make.

When you initiate the FM/CICS editor with the Edit Utility, this is referred to as being in an "Edit editor session" (or just "Edit").

FM/CICS Browse

FM/CICS Browse allows you to view CICS data, but without the ability to save any changes.

When you start up the FM/CICS editor in browse mode, this is referred to as being in a "Browse editor session" (or just "Browse").

From a list of FM/CICS resources, to start up a Browse editor session, enter the prefix command, B.

When you start up a Browse editor session, FM/CICS displays the relevant FM/CICS Browse entry panel.

Related references

[Initiating a FM/CICS Browse editor session from a display list on page 53](#)

[Browse Entry panels on page 79](#)

These instructions are given within the context of the FM/CICS editor. In most cases, you can perform these actions in either Edit or View, in which case the term "editor" is used. Similarly, the term "editor session" can indicate either a View editor session or an Edit editor session.

To display one of the View Entry panels, select option 1 ("View") from the FM/CICS Primary Options Menu panel.

To display one of the Edit Entry panels, select option 2 ("Edit") from the FM/CICS Primary Options Menu panel.

You can view or edit a CICS resource with a number of formats. You can use a copybook or template to provide a logical view of the data set. The logical view describes the field format of the records. In addition, a template can be used to:

- Select the records to be displayed.
- Select the fields to be displayed.
- Format how the fields are displayed.

The FM/CICS editor displays a full screen of data, and allows you to overwrite the data that is displayed. You can scroll the data in any direction: backward, forward, left, and right. It allows you to perform general editing operations by entering primary commands in the command field of the display. It also allows you to perform record-oriented operations by entering prefix commands in the prefix area of the display.



Note: Once the FM/CICS editor is started, the way in which you use the editor (commands, template usage, PF keys, and so on) is the same as for File Manager Base component. For further information about using the browser, see *"Viewing and changing data sets"* in the *File Manager for z/OS User's Guide and Reference*.

Related topics

[Primary Option Menu panels on page 121](#)

[View Entry panels on page 133](#)

[Edit Entry panels on page 99](#)

Editing CICS files

To edit a CICS file in View:

1. Select **1. File** on the Primary Option Menu panel.
2. Type 1 on the command line.
3. Press Enter.

FM/CICS displays the View CICS File Entry panel.

To edit a CICS file in Edit:

1. Select **1. File** on the Primary Option Menu panel.
2. Type 2 on the command line.
3. Press Enter.

FM/CICS displays the Edit CICS File Entry panel.

You can view CICS VSAM files that have browse and read access.

For Edit, CICS VSAM files must have update access. Full editing capability (inserts/deletes) is available for KSDS files that have add and delete attributes. All other files are in place editing only—new records can be appended to ESDS files, and slots can be deleted or new records can be inserted into empty slots for an RRDS.



Note:

FM/CICS requests against CICS data tables not owned by the local CICS region always use function shipping (cross-memory services are not used).

BDAM files are not supported.

Related topics

[View Entry panels on page 133](#)

[Edit Entry panels on page 99](#)

Editing temporary storage

To edit temporary storage in View:

1. Select **2. Temporary Storage** on the Primary Option Menu panel.
2. Type 1 on the command line.
3. Press Enter.

FM/CICS displays the View Temporary Storage Entry panel.

To edit temporary storage in Edit:

1. Select **2. Temporary Storage** on the Primary Option Menu panel.
2. Type 2 on the command line.
3. Press Enter.

FM/CICS displays the Edit Temporary Storage Entry panel.

In View, you must specify the name of an existing queue.

In Edit, you can specify an existing or new queue name for temporary storage editing.

New queue name

If you specify a new queue name, you are asked to specify whether the queue location is to be in memory or auxiliary storage. An Edit session then commences with no records and you can insert new records. On completion of the Edit session, the queue is created with the records created during the Edit session.



Note:

If the TS queue name matches the prefix of an existing TS model, it is allocated according to the attributes of the corresponding model. If the TS queue name does not match a prefix of a TS model, it is allocated in auxiliary storage.

However, if SYSID is not blank, the TS queue is defined on the specified CICS system either using a corresponding TS model on the remote system if a match exists, otherwise it is allocated in auxiliary storage on the remote system.

Existing queue name

FM/CICS attempts to read all the records into memory. In Edit, you can insert, delete, and change records and, on completion, FM/CICS deletes the existing queue and replaces it with the records from your Edit session. Any changes to the queue made by other applications are lost.

Other elements of the View and Edit functions are described in *“Viewing and changing data sets”* in the *File Manager for z/OS User’s Guide and Reference*.

Related topics

[View Entry panels on page 133](#)

[Edit Entry panels on page 99](#)

Editing transient data queues

To edit transient data in View:

1. Select **3. Transient Data** on the Primary Option Menu panel.
2. Type 1 on the command line.
3. Press Enter.

FM/CICS displays the View Transient Data Entry panel.

To edit transient data in Edit:

1. Select **3. Transient Data** on the Primary Option Menu panel.
2. Type 2 on the command line.
3. Press Enter.

FM/CICS displays the Edit Transient Data Entry panel.

You can edit the following types of transient data queues:

Intrapartition

FM/CICS reads the entire queue into memory. You can edit or delete records or insert new ones.

In Edit, confirming exit causes a destructive read and restore of the transient data queue to occur. If another application added records to the queue during your Edit session, these records will be interspersed with the records from your Edit session.

In View, when you exit, you are given the option of restoring all the records read back to the queue. These records are appended to the existing queue if you select to rewrite the records.

Extrapartition

In Edit, you can only edit Extrapartition queues defined for output and you can only append records. The Edit session begins with no records and you can insert records. On completion, the records are appended to the queue.



Attention: If the queue is not defined to CICS with a disposition of MOD, closing and opening the queue erases all previous contents.

In View, you can only view Extrapartition queues defined for input.

Indirect

If the associated queue is the same as the above, then editing is supported as stated for those queues.

Related topics

[View Entry panels on page 133](#)

[Edit Entry panels on page 99](#)

Locking your CICS resource

FM/CICS uses standard CICS services to update and change resources. FM/CICS is also capable of issuing CICS enqueues to help you coordinate access against resources as described below.

FM/CICS-generated CICS enqueue

When editing a temporary storage queue or transient data queue with FM/CICS, a CICS enqueue using the following resource naming convention is issued:

```
FMLOCK:xxsysidname
```

Where:

xx

TD or TS depending on the type of queue being edited.

sysid

The ID of the CICS system where the queue resides. A blank value indicates the queue resides on the local system.

name

The name of the queue.

This CICS enqueue is issued to prevent multiple FM/CICS sessions on the same region from concurrently editing the same queue.

User-specified CICS enqueue

You can specify a 1–36 character CICS enqueue resource name that is issued for the duration of the Edit session for a file, TS queue, or TD queue by:

- Entering "/" in the **Lock resource** field
- Specifying a valid 1–36 character CICS enqueue resource name in the corresponding **Name** field

This user-specified CICS enqueue can be used to provide additional coordination for CICS resources accessed by FM/CICS and other applications that issue similar CICS enqueues. This enqueue is issued in addition to the FM/CICS-generated CICS enqueue for TS and TD queues.

FM/CICS issues CICS enqueues on the **local region only** (the CICS region where FM/CICS is running). An enqueue resource length of 255 is used and all unused characters are padded with spaces.

If FM/CICS issues an enqueue but receives a "busy" response, this indicates that a similar CICS enqueue has already been issued by another application. FM/CICS then displays the message "CICS resource locked" and terminates the Edit. To display further information about the active CICS enqueue, press F1. You can also list and display further CICS attributes for CICS enqueues by using the FM/CICS List utility. For further information, see [Working with CICS enqueues on page 55](#).

Chapter 5. Working with FM/CICS utilities

To display the Utility Functions panel, select option 3 ("Utilities") from the Primary Options Menu panel.

Some of the utilities you can select are File Manager Base component utilities. The numbers of the options for the File Manager Base component utilities match the equivalent options on the File Manager Base component Utilities Functions menu panel.

To find information about each utility on the Utility Functions panel, see the relevant section as shown in [Table 2: Sections describing utilities on page 48](#).

Table 2. Sections describing utilities

To find out more about this utility on the Primary Options Menu panel...	See this section...
0 DBCS	<i>"Set DBCS Format panel"</i> in the <i>File Manager for z/OS User's Guide and Reference</i>
2 Print	Printing a CICS resource on page 49
4 List	Working with lists of CICS resources on page 50
5 Printdsn	(Displays print output in full-screen mode)
6 Audit trail	<i>"Print Audit Trail panel"</i> in the <i>File Manager for z/OS User's Guide and Reference</i>

Related topics

[Primary Option Menu panels on page 121](#)

[Utility Functions panel on page 131](#)

Chapter 6. Printing a CICS resource

To display one of the Print Entry panels, select option 2 ("Print") from the FM/CICS Utility panel.

You can use the FM/CICS Print utility to print a CICS resource in a selected format. Data can be printed by record or by field if a template or copybook has been provided. Records can be selected for printing using the start key (VSAM only), skip and print count fields and a conditional expression defined in the template provided. The output for the Print function is controlled by the SET options.

The following restrictions apply when printing a CICS resource:

- CICS files: only VSAM files with read and browse access are supported.
- CICS extrapartition queues must be INPUT.



Note: After printing a intrapartition queue you are prompted to restore the queue items.

Other elements of the Print function are described in *"Printing from File Manager"* in the *File Manager User's Guide and Reference*.

Related topics

[Primary Option Menu panels on page 121](#)

[Print Entry panels on page 124](#)

Chapter 7. Working with lists of CICS resources

FM/CICS displays a list of CICS resources when you:

- **Specify a fully-qualified or generic resource name on the List CICS Resources Entry panel.**

To display the List CICS Resources Entry panel, select option 4 ("List") from the FM/CICS Utility panel.

The List CICS Resources Entry panel allows you to list resources that match a specified resource name and SYSID. You can modify the listed resources or perform functions such as Edit, View, and Print against any listed file or enqueue.

The type of resource selection list that FM/CICS displays when you press Enter is determined by the **CICS Resource** you selected on the List CICS Resources Entry panel.

- **Use a wildcard when specifying a CICS resource name on a FM/CICS entry panel.**

The type of resource selection list that FM/CICS displays when you press Enter is determined by the **CICS Resource** you selected on the FM/CICS entry panel.



Note: When you enter a wildcard on a FM/CICS entry panel, only the function from the previously displayed FM/CICS entry panel (view, edit, browse, or print) can be selected for the listed resource.

Related topics

[Utility Functions panel on page 131](#)

[List CICS Resources Entry panel on page 120](#)

Finding a string in a selection list

To find the next occurrence of a character string in the list being displayed, use the FIND primary command.

The cursor is placed in the prefix area of the line containing the found string and that line is made the top line.

To find the next occurrence of the same string, use the RFIND command, or enter the FIND command with no argument. A message is displayed if the string cannot be found.

Controlling the starting point, direction and extent of the search

You can qualify the search string with one of the following optional parameters before or after the search string: NEXT, PREV, FIRST, LAST. If you do not specify any parameter, or if you specify the NEXT parameter, the search begins at the cursor location (if the cursor is within the data portion of the display) or the beginning of the first record displayed, and searches ahead to find the next occurrence of the string.

If you specify the FIRST parameter, the search begins at the beginning of the list and searches ahead. If the LAST parameter is used, the search begins at the end of the list and searches backwards. If you specify the PREV parameter, the search

begins either at the cursor location (if the cursor is within the data portion of the display) or the beginning of the first record displayed, and searches backwards to find the string.

Related topics

[FIND primary command on page 75](#)

[RFIND primary command on page 77](#)

Searching the current primary sort order column

To search the current primary sort order column for an occurrence of a specified string, use the LOCATE primary command. The string syntax must be consistent with the target column for the LOCATE primary command. The LOCATE primary command positions to the top of the display the column value either equal to or closest value less than or greater than depending on the SORT order.

Related topics

[LOCATE primary command on page 76](#)

Viewing queue names with unprintable characters

CICS temporary storage queue names can contain unprintable characters. To view the hex value of the queue names listed on the CICS Temporary Storage Selection List panel, enter `HEX ON`. To suppress the hex values, enter `HEX OFF`.



Note: Only the TS queue selection list supports this command.

[Figure 11: Queue names displayed in hex format on page 51](#) shows an example of queue names displayed in hex format.

Figure 11. Queue names displayed in hex format

<u>P</u> rocess	<u>O</u> ptions	<u>H</u> elp							Row 1 of 2		
FM/CICS			CICS Temporary Storage Selection List								
Queue	Loc	Items	Size	Max	Min	Tran	Last	Sys	Pool		
SAMP _ _	AUX	2	128	64	64	CECI	67				
ECDD440344444444											
2147013400000000											
SAMP2é _	AUX	3	192	64	64	CECI	8				
ECDDF54344444444											
2147211200000000											
****	End of data	****									

Related topics

[CICS Temporary Storage Selection List panel on page 94](#)

[HEX primary command on page 76](#)

Refreshing the current selection list

To refresh the current selection list, use the REFRESH primary command.

Related topics

[REFRESH primary command on page 77](#)

Changing resource attributes

On the CICS resource list or corresponding attributes panel, you can change any value that is underlined by overtyping the field and pressing Enter.

For example, to close a VSAM file from the CICS file selection list, type "c" in the open status column and press Enter.

All attribute changes requested through FM/CICS are performed by issuing the SET CICS command, and therefore must adhere to all CICS restrictions.

Related topics

[FM/CICS panels and fields on page 79](#)

Selecting items from a display list

To select items from a display list, use the SELECT primary command. The SELECT primary command performs the equivalent processing of the S prefix command against resource names matching the supplied pattern or resource name.

▶ **Select** — *resource_name_pattern* ▶

resource_name_pattern

A resource name or pattern used to match resource names on the list.

Examples

SELECT TDM1

Selects the resource called TDM1.

S *

Selects all resources.

S A*

Selects all resources starting with "A".

S *Z

Selects all resources ending with the letter "Z".

Related topics

[SELECT primary command on page 78](#)

Initiating a FM/CICS Browse editor session from a display list

To initiate the FM/CICS editor in Browse mode from a display list, enter the prefix command, B, against the resource you want to browse. FM/CICS displays the relevant Browse Entry panel.

Related topics

[Browse Entry panels on page 79](#)

Sorting a CICS selection list

To sort a CICS selection list, use the SORT primary command. You can sort a CICS selection list by any two fields displayed on the selection list, except the line command field and Status columns. The field names are the column heading values with the following exceptions:

- Use "Dsn" for the **Data set name** field on the File selection list.
- Use "Resource" for the **Resource name** field on the Enqueue selection list.

The sort sequence is ascending for columns with character values, and descending for columns with numeric values. The SORT primary command is also invoked for a single column by placing the cursor on the column heading and pressing Enter.

Example 1. File Selection list

The following example shows how the file list is sorted by dsn and then by type within dsn:

```
COMMAND ==> sort dsn type
  File      Data set name   Type  Sys
ACCTFIL    FMN.CICS.ACCTFILE  VSAM
ACCTNAM    FMN.CICS.ACCTNAME  KSDS
ACINUSE    FMN.CICS.ACTINUSE  PATH
```

Example 2. Temporary Storage Selection List

The following example shows how the temporary storage can be sorted by size (descending) and queue name within size (ascending):

```
COMMAND ==> sort size queue
  Queue Loc  Items      Size  Max
FMT3  AUX    20        2560  128
FMT5  AUX    10        1280  128
FMT1  AUX    10        1280  128
FMT2  AUX    10        1280  128
FMT4  AUX    10        1280  128
```

Example 3. Transient Data Selection List

The following example shows how the transient data queue list can be sorted by type, and then disposition within type:

```
COMMAND ==> sort Typ dsp
  Queue Typ DDname  Dsp
CXRF  EXT DFHCXRF  MOD
FMO1  EXT FMO1    SHR
FMO2  EXT FMO2    SHR
```

```
FM03 EXT FM03 SHR
FM04 EXT FM04 SHR
```

Example 4. Enqueue Selection List

The following example shows how the enqueue selection list can be sorted by task (descending), and then resource name within task (ascending):

```
COMMAND ==> sort task resource
Resource name (first 36 characters)    Task
ENQUEUE2                             0001177
ENQUEUE4                             0001177
ENQUEUE1                             0001176
ENQUEUE3                             0001176
ENQUEUE5                             0001176
```

Related topics

[SORT primary command on page 78](#)

Chapter 8. Working with CICS enqueues

This section describes the enqueue list and task purge function of FM/CICS.

Invocation and execution

During an Edit session, if FM/CICS receives a busy condition when attempting to issue the FM/CICS-generated or user-specified CICS enqueue, the message shown in [Figure 12: Sample edit panel with "busy condition" message on page 55](#) is displayed.

Figure 12. Sample edit panel with "busy condition" message

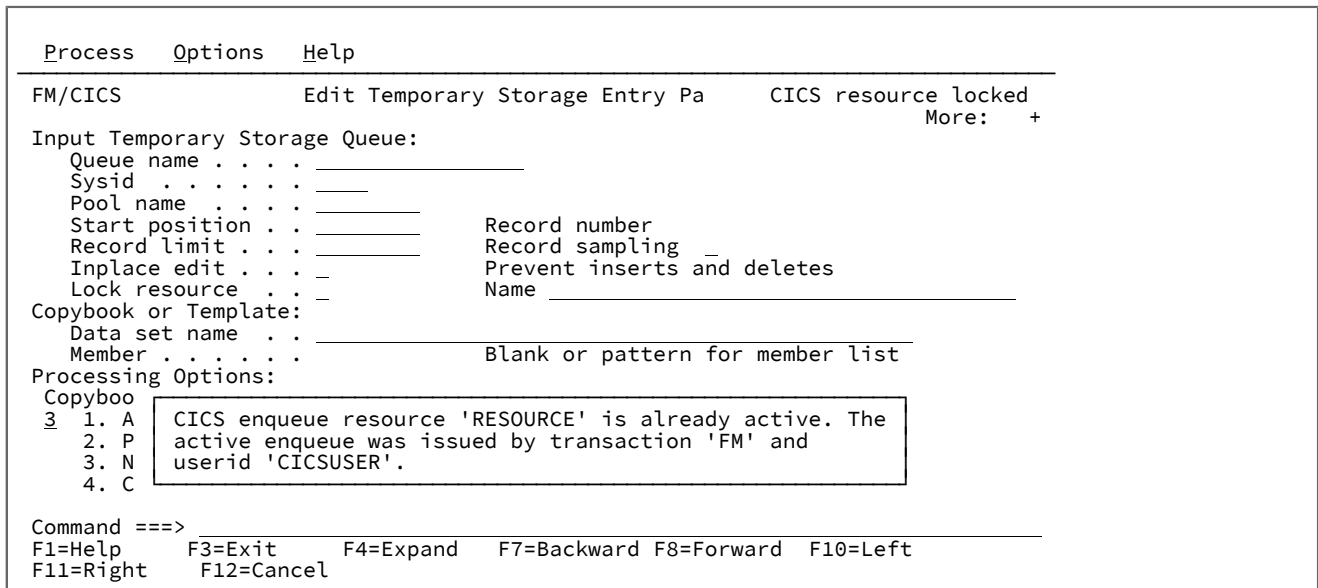

To display the long message, press the Help function key (F1).

The message provides the userid and transaction associated with the active CICS enqueue, along with the enqueue resource name that is preventing the FM/CICS session from issuing an enqueue with the same name.

To find more information about the CICS enqueue:

1. Select the **List** option (3.4) from the Utility Functions panel to display the List CICS Resources Entry panel.
2. On the List CICS Resources Entry panel:
 - a. Specify the name of the CICS enqueue resource that you want more information about in the **Resource name** input field.
 - b. Select option 4, Enqueue, from the Processing Options list.
 - c. Press Enter.

FM/CICS displays a list of all active CICS enqueues that match the specified resource name on the CICS Enqueue Selection List panel.

Related topics

[Utility Functions panel on page 131](#)

[List CICS Resources Entry panel on page 120](#)

[CICS Enqueue Selection List panel on page 89](#)

Displaying additional CICS attributes

To display additional CICS attributes related to a CICS enqueue, enter the A or S prefix command against the enqueue on the CICS Enqueue Selection List panel to display the CICS Enqueue Resource panel.

Related topics

[CICS Enqueue Selection List panel on page 89](#)

[CICS Enqueue Resource panel on page 86](#)

Purging CICS tasks

To purge a task that issued the CICS enqueue that is locking a resource:

1. Enter the P or F prefix command against the listed enqueue on the CICS Enqueue Selection List panel.

FM/CICS issues a SET TASK PURGE or SET TASK FORCEPURGE CICS command respectively against the task.



Note:

1. You cannot issue a P line command (SET TASK PURGE) for tasks defined as not purgeable (**Prg** on the CICS Enqueue Selection List panel shows as NO).
2. You can issue an F line command (SET TASK FORCEPURGE) against a task defined as not purgeable. Before issuing the first PURGE or FORCEPURGE, FM/CICS displays a warning panel asking you to confirm the purge.

If the purge was successfully issued against one or more tasks, FM/CICS changes the entry on the CICS Enqueue Selection List panel to `*** PURGE ISSUED ***`. This does not indicate that the task was successfully purged, but only that the purge command was successfully issued.

If the purge command failed, FM/CICS changes the entry on the CICS Enqueue Selection List to `*** PURGE ERROR ***` and displays the condition and RESP2 values returned by CICS at the bottom of the panel.

3. Issuing PURGE or FORCEPURGE against a task terminates the task. Therefore, you should issue a REFRESH command after purging one or more tasks to produce a current list of all active CICS enqueues.

Related topics

[CICS Enqueue Selection List panel on page 89](#)

Chapter 9. Messages

There are four categories of FM/CICS messages. These messages are generated by FM/CICS, to confirm successful processing, or to tell you about errors.



Note: To see the message number under ADFz Common Components, issue the MSGID command.

FM/CICS level verification messages

These messages are displayed when you first enter FM/CICS, and displays information about the CICS level. FM/CICS level verification messages are preceded by "FMNBB" and a message number.

FM/CICS logon messages

Messages that are issued on the FM/CICS logon screen.

FM/CICS message log messages

Messages that are written to the FM/CICS message log.

The default FM/CICS message log is defined as transient data queue FMNM to sysout class A. However, this may have been changed in the options module during installation.

FM/CICS interface messages

These messages are displayed when an error is encountered during a FM/CICS session. You can get more information about these messages by pressing the F1 (help) key.

If FM/CICS encounters an error after issuing a CICS command (such as INQUIRE FILE), message 1172 is produced, listing the function and returned condition and resp2 values. For further information, look up the condition and resp2 values in either the CICS Application Programming Reference or CICS System Programming Reference.

If FM/CICS receives an ILLOGIC condition when performing resource i/o, message 0063 is displayed, giving the VSAM return and error code. Look up the listed VSAM return and error code for the VSAM function in the *DFSMS Macro Instructions for Data Sets* for further information.



Note: Messages FMN1172I and FMN0063I are also documented in the File Manager User's Guide and Reference.

FM/CICS logon and message log messages are preceded by "FMNCA" and a message number.

Format of numbered messages

File Manager messages

The format of numbered FM/CICS level verification messages is:

File Manager message syntax

FMNBBnnn message text

FMNBB

Indicates that the message comes from File Manager.

nnn

Is the message number.

FM/CICS messages

The format of numbered FM/CICS messages is:

FM/CICS message syntax

FMNCAnnn message text

FMNCA

Indicates that the message comes from FM/CICS.

nnn

Is the message number.

File Manager messages

The following messages may be issued when the batch job is first invoked from CICS and validates that the CICS region that submitted the job is running with the same level of File Manager.

FMNBB252

No storage to obtain CICS buffer to query CICS levels

Explanation: There is insufficient memory to perform the level check.

User response: Increase the available region size to the submitted batch job.

FMNBB253

CICS level inquiry failed to run successfully rc = rc

Explanation: Internal error occurred processing the inquire level command.

User response: Contact IBM® Support.

FMNBB254

You are running a higher level of File Manager in the batch job than in at least one of the connected CICS regions. This could lead to failures due to services being unavailable. Use the command VERCICS to verify the current levels of File Manager for CICS that are running and ensure all regions with a lower level are upgraded appropriately.

Explanation: This message indicates a mismatch in buffer layout between the batch job and FM/CICS most likely due to maintenance not being applied to all instances of FM/CICS. This mismatch can lead to severe errors if not resolved.

User response: Use the VERCICS command to display the level of FM/CICS on all connected CICS regions. Correct all instances that are running at a lower level from the running File Manager batch job. A difference in level may be due to maintenance not being applied to the FM/CICS instance or the FM/CICS programs may not have been refreshed in the CICS region after maintenance was applied.

FMNBB255

CICS level inquiry failed with cond=CICS *condition code*

Explanation: The load for program FMN3LVL has failed in the connected CICS region with the CICS condition code *condition code*.

User response: This normally indicates an installation problem as FMN3LVL is not accessible in the connected CICS region. Check the DFHRPL and ensure FMN3LVL is available in File Manager libraries.

FMNBB256

Warning - PTF mismatch

Explanation: You are running different maintenance levels of File Manager in the batch job and FM/CICS in one or more of the connected CICS regions. This indicates that FM/CICS in one or more region may be downlevel and therefore not contain all available services or resolutions for problems provided by more recent levels of maintenance.

User response: Use the VERCICS command to display the PTF level of FM/CICS on all the connected CICS regions. Correct all instances that are running at a different PTF level from the running File Manager batch job. A difference in PTF level may be due to maintenance not being applied to the FM/CICS instance or the FM/CICS programs may not have been refreshed in the CICS region after maintenance was applied.

FMNBB257

CICS level inquiry was unable to load FMN3LVL

Explanation: The batch job was unable to load the module FMN3LVL.

User response: Ensure FMN3LVL is available to be loaded by the batch job.

FM/CICS logon and message log messages

The following messages are issued on the FM/CICS logon screen or in the message log.

FMNCA000

File Manager ended

Explanation: File Manager for CICS has ended.

User response: If File Manager for CICS has ended unexpectedly, refer to output in the job that was submitted to start the File Manager batch address space for further information.

FMNCA001

Password required

Explanation: A password was not entered for the specified userid.

User response: Enter the current password for the specified userid in the Password field.

FMNCA002

Confirm new password

Explanation: The new password entered for the specified userid requires confirmation.

User response: Re-enter the new password for the specified userid in the New Password field.

FMNCA003

Re-enter new password

Explanation: An error occurred while processing the new password.

User response: Re-enter the new password for the specified userid in the New Password field.

FMNCA004

Invalid password

Explanation: An invalid or unauthorized password has been entered for the specified userid.

User response: Enter the current password for the specified userid in the Password field.

FMNCA005

Password has expired

Explanation: The current password for the specified userid has expired.

User response: Enter a new password for the specified userid in the New Password field.

FMNCA006

Invalid new password

Explanation: The new password entered for the specified userid does not meet your system's password requirements.

User response: Enter an acceptable new password for the specified userid in the New Password field.

FMNCA007

Userid is revoked

Explanation: The specified userid is revoked.

User response: Contact your security administrator to determine why the specified userid is revoked.

FMNCA008

Procedure name required

Explanation: The Procedure input field has been left blank.

User response: Specify a valid 1–8 character File Manager procedure name in the Procedure input field. Refer to *File Manager Customization Guide* for further information.

FMNCA009

Profile data set name required

Explanation: The Profile data set input field has been left blank.

User response: Specify a valid 1–44 character profile data set name in the Profile data set input field. Refer to *File Manager Customization Guide* for further information.

FMNCA010

Invalid profile data set name

Explanation: The data set name entered in the Profile data set input field does not follow standard MVS data set naming conventions.

User response: Specify a valid 1–44 character profile data set name in the Profile data set input field. Refer to *File Manager Customization Guide* for further information.

FMNCA011

Jobcard required

Explanation: The first line of the Jobcard input field has been left blank. It must contain a valid jobname along with the JOB JCL statement.

User response: Specify a valid jobcard in the Jobcard input field. Refer to *File Manager Customization Guide* for further information.

FMNCA012

Jobname requires //

Explanation: A non-comment line in the jobcard specified in the Jobcard input field does not begin with "//".

User response: Follow JCL conventions by specifying // at the beginning of each non-comment line in the Jobcard input field.

FMNCA013

Invalid jobname

Explanation: The jobname specified in the Jobcard input field does not follow JCL conventions.

User response: Specify a valid jobname on the first line of the Jobcard input field.

FMNCA014

Jobname too long

Explanation: The jobname specified in the Jobcard input field exceeds 8 characters.

User response: Specify a valid jobname on the first line of the Jobcard input field.

FMNCA015

Invalid jobcard, JOB statement required

Explanation: The first line specified in the Jobcard input field does not contain the required JOB JCL statement.

User response: Specify a valid jobcard in the Jobcard input field. Refer to *File Manager Customization Guide* for further information.

FMNCA016

Job *jobname* not responding

Explanation: Job *jobname* has been submitted to start the File Manager address space, but a response has not been received within the allocated amount of time. The job may be queued or may have failed. This message is accompanied by message FMNCA019.

User response: Refer to the output of job *jobname* for any further error messages that may indicate why the job has not responded. If the job log cannot be found (the FM/CICS job was never started), verify that the FMNRDR DD statement has been properly defined in the CICS startup JCL and your system has sufficient initiators. Refer to the *File Manager Customization Guide* for further information.

Here are some of the most common reasons the batch job may have failed or been queued:

- Insufficient authority to access one of the libraries in the FM/CICS procedure. Check the system log for security messages.
 - TCP/IP is not active on the CICS region. Check for TCP/IP error messages in the job log and verify that TCP/IP is active on the CICS region.
 - Duplicate job name. Verify if another user may have specified the same job name in the FM/CICS jobcard input field, or a previous FM/CICS job is still active.
-

FMNCA017

Job *jobname* submitted

Explanation: Job *jobname* has been submitted to start the File Manager address space.

User response: None.

FMNCA018

Profile READ error, COND: *cond*, RESP2: *resp2*

Explanation: File Manager has encountered an error while attempting to read from the profile data set. CICS has returned a condition of *cond* and a resp2 value of *resp2*. This profile data set is used to populate the FM/CICS logon screen. FM/CICS default values have been used instead.

User response: Look up the condition and resp2 values in CICS Application Programming Reference for the READ FILE API for further information.

FMNCA019

Press F5 to wait another 20 seconds, ENTER to resubmit

Explanation: File Manager has submitted a batch job to start the File Manager address space but has not received a response. The job may be queued, or may have failed. This message is accompanied by message FMNCA016.

User response: Press F5 to wait another 20 seconds for a response from the batch job or ENTER to resubmit the batch job. Refer to the output in the job displayed in message FMNCA016 for any further error messages that may indicate why the job has not responded.

FMNCA020

Sockets error

Explanation: File Manager has encountered an error with the TCP/IP sockets interface. This message is accompanied by message FMNCA021.

User response: Look up the error code for the function displayed in message FMNCA021 in IP CICS Sockets Guide for further information.

FMNCA021

FUNCTION: *function*, ERROR CODE: *error_code*, RETURN CODE: *return_code*

Explanation: File Manager has encountered an error with the TCP/IP sockets interface when issuing a call to the listed function. This message is accompanied by message FMNCA020.

User response: Look up the error code for the listed sockets function in IP CICS Sockets Guide for further information.

FMNCA022

Internal reader error, RESOURCE: *resource*, FUNCTION: *function*

Explanation: File Manager has encountered an error while processing the internal reader. File Manager uses the internal reader to submit a batch job that invokes the File Manager address space. The *function* is the operation File Manager attempted to perform against the internal reader. The *resource* is the name of the transient data queue defined to the internal reader used by the OPEN, WRITE, and CLOSE functions. For ENQ and DEQ functions, *resource* is the enqueue resource name used by File Manager. This message is accompanied by message FMNCA023 that contains the returned condition and resp2 values.

User response: Look up the condition and error code displayed in message FMNCA023 for the listed function in CICS Application Programming Reference for further information.

FMNCA023

COND: *condition*, RESP2: *resp2*

Explanation: File Manager has encountered an error while processing the internal reader. The *condition* and *resp2* values returned by CICS are displayed. This message is accompanied by message FMNCA022 that contains the resource name and function that encountered the error.

User response: Look up the condition and error code for the function listed in message FMNCA022 in CICS Application Programming Reference for further information.

FMNCA024

Internal reader incorrectly defined, RESOURCE: *resource*

Explanation: The transient data queue resource is incorrectly defined to the internal reader. File Manager uses the internal reader to submit a batch job that invokes the File Manager address space.

User response: Correctly define a transient data queue to the internal reader. Refer to *File Manager for z/OS Customization Guide* for further information.

FMNCA025

Password successfully changed

Explanation: The password has been successfully changed for the specified userid.

User response: None.

FMNCA026

Unknown return code in ESMRESP from external security manager

Explanation: A CICS request to verify the entered password for the specified userid has returned an unknown return code in ESMRESP from the external security manager.

User response: Contact your security administrator.

FMNCA027

The CICS external security manager interface is not initialized

Explanation: A CICS request to verify the entered password for the specified userid has returned an error condition indicating that the CICS external security manager interface is not initialized.

User response: Contact your security administrator.

FMNCA028

The external security manager is not responding

Explanation: A CICS request to verify the entered password for the specified userid has returned an error condition indicating that the CICS external security manager interface is not responding.

User response: Contact your security administrator.

FMNCA029

The USERID field contains a blank character in an invalid position

Explanation: A CICS request to verify the entered password for the specified userid has returned an error condition indicating that the userid field contains a blank character in an invalid position.

User response: Specify a valid userid or contact your security administrator.

FMNCA030

Unknown INVREQ value when validating password

Explanation: A CICS request to verify the entered password for the specified userid has returned an unknown INVREQ resp2 value.

User response: Contact IBM® Support.

FMNCA031

The USERID is not known to the external security manager

Explanation: A CICS request to verify the entered password for the specified userid has returned an error condition indicating that the specified userid is not known to the external security manager.

User response: Specify a valid userid or contact your security administrator.

FMNCA032

Unknown condition received from password validation

Explanation: A CICS request to verify the entered password for the specified userid has returned an unknown condition.

User response: Contact IBM® Support.

FMNCA033

Abend during job submission

Explanation: An abend was encountered when File Manager attempted to submit a batch job to the internal reader to start the File Manager address space.

User response: Refer to the CICS and system log for further information about the cause of the abend.

FMNCA034

The change password request failed during SECLABEL processing

Explanation: A CICS request to change the password for the specified userid has returned an error condition indicating that the change password request failed during SECLABEL processing.

User response: Contact your security administrator.

FMNCA035

The user is revoked in the connection to the default group

Explanation: A CICS request to change the password for the specified userid has returned an error condition indicating that the user is revoked in the connection to the default group.

User response: Contact your security administrator.

FMNCA036

NOTAUTH condition received from change password request

Explanation: A CICS request to change the password for the specified userid has returned an error condition indicating that the user is not authorized.

User response: Contact your security administrator.

FMNCA037

**** File Manager for CICS has ended ****

Explanation: File Manager for CICS has ended.

User response: None.

FMNCA038

Invalid userid, re-enter

Explanation: You have entered an invalid userid. The userid either contains incorrect characters or is not recognized by the external security manager.

User response: Enter a valid userid.

FMNCA039

Userid not authorized to issue INQUIRE command

Explanation: CICS command security has prevented your userid from issuing INQUIRE commands on the CICS region. Your userid must have the authority to issue INQUIRE commands to run FM/CICS.

User response: Contact your security administrator.

FMNCA040

Connection tdqueue error, RESOURCE: *resource*, FUNCTION: *function*

Explanation: File Manager has encountered an error while processing the connection transient data queue. File Manager reads this queue (if specified) to obtain a list of APPLIDs of connected CICS regions where FM/CICS has been installed to process remote resources. The *function* is the operation File Manager attempted to perform against the queue. The *resource* is the name of the transient data queue defined to FM/CICS on the CONN option in FMN3POPT.

User response: Look up the condition and error code displayed in message FMNCA023 for the listed function in *CICS Application Programming Reference* for further information.

FMNCA041

Connection tdqueue incorrectly defined, RESOURCE: *resource*

Explanation: The connection transient data queue is incorrectly defined. File Manager reads this queue (if specified) to obtain a list of APPLIDs of connected CICS regions where FM/CICS has been installed to process remote resources. The *resource* is the name of the transient data queue defined to FM/CICS on the CONN option in FMN3POPT. This resource must be defined as an extrapartition, input tdqueue with a record length no larger than 80 bytes.

User response: Correctly define the connection transient data queue. Refer to *File Manager Customization Guide* for further information.

FMNCA042

Trace requested, message log error, RESOURCE: *resource*, FUNCTION *function*

Explanation: You have requested FM/CICS tracing, but an error was encountered with the transient data queue defined as the FM/CICS message log. FM/CICS tracing writes data to the message log, and therefore FM/CICS cannot perform tracing until the error with this resource has been resolved. The *function* is the operation File Manager attempted to perform against the queue. The *resource* is the name of the transient data queue defined to FM/CICS as the message log on the MSGL option in FMN3POPT. Refer to the *File Manager Customization Guide* for further details about the FM/CICS message log.

User response: Look up the condition and error code displayed in message FMNCA0023 for the listed function in *CICS Application Programming Reference* for further information.

FMNCA043

CICS socket interface abend, interface may not be started

Explanation: FM/CICS encountered an abend when attempting to invoke the CICS socket interface. The CICS socket interface is required to communicate with the FM batch address space. The abend may be due to the CICS socket interface not being started on the CICS region.

User response: Issue the EZAO CICS transaction (if available) to view the status and start the CICS socket interface, then rerun the FM/CICS transaction.

FMNCA051

User ID does not have access to *appl*

Explanation: FM/CICS received an error from the IBM Application Delivery Foundation for z/OS® Common Components server indicating that the user ID does not have at least READ access to the RACF APPL class profile associated with the server. *appl* is the name of the profile.

User response: Contact your security administrator and request that your user ID be given READ access to the APPL class profile associated with the IBM Application Delivery Foundation for z/OS® Common Components server.

FMNCA065

hh:mm:ss.ms trace message

Explanation: Various tracing information as requested during FM/CICS initialization.

User response: None.

FMNC999

File Manager/CICS problem - message *nnnn* not found in table

Explanation: File Manager for CICS cannot find the message number *nnnn* in the message table. This is probably a File Manager error.

User response: Contact IBM® Support.

FMNCA060

mm/dd/yy hh:mm:ss File Manager for CICS started by USER: *userid*, FACILITY: *facility*

Explanation: A FM/CICS session has been started on the CICS region at the specified date and time. The FM/CICS transaction was initiated by the listed *userid* and *facility*. This facility will also be written in all subsequent messages written to the message log during this FM/CICS session.

User response: None.

FMNCA061

mm/dd/yy hh:mm:ss File Manager for CICS ended, USER: *userid*, FACILITY: *facility*, RC: *rc*

Explanation: A FM/CICS session has ended on the CICS region at the specified date and time with return code *rc*. The FM/CICS transaction was originally initiated by the listed *userid* and *facility*.

User response: If the return code is not 0, refer to previous messages for an explanation of the errors encountered.

FMNCA062

mm/dd/yy hh:mm:ss Failure loading options module, COND: *condition*, RESP2: *resp2*, FACILITY: *facility*

Explanation: FM/CICS was unable to load the options module FMN3POPT. When attempting to load the program, CICS returned the listed *condition* and *resp2* values.

User response: If your installation accepted the FM/CICS default values and therefore did not define and install the options module, ignore this message. Otherwise, look up the *condition* and *resp2* values in the CICS Application Programming Reference for the LOAD PROGRAM API for further information. Refer to the *File Manager Customization Guide* for further information about the options module FMN3POPT.

FMNCA063

mm/dd/yy hh:mm:ss Failure loading message module, COND: *condition*, RESP2: *resp2*, FACILITY: *facility*

Explanation: A language other than ENGLISH was specified in the FM/CICS options module. However, FM/CICS was unable to load the message module for the specified language.

User response: Look up the *condition* and *resp2* values in the CICS Application Programming Reference for the LOAD PROGRAM API for further information. Refer to the *File Manager Customization Guide* for further information about multicultural support.

FMNCA064

mm/dd/yy hh:mm:ss Failure starting verify transaction, COND: *condition*, RESP2: *resp2*, FACILITY: *facility*

Explanation: FM/CICS attempted to start a transaction to verify that the entered userid is valid. The transaction failed with the listed *condition* and *resp2* values. The default FM/CICS verification transaction is FMVU, but this may have been changed in the options module during installation.

User response: Look up the *condition* and *resp2* values in the CICS Application Programming Reference for the START API for further information. Refer to the *File Manager Customization Guide* for further information about the userid verification transaction (FMVU).

Part II. FM/CICS reference

Chapter 10. FM/CICS primary commands

This chapter describes the syntax and parameters for the primary commands that you can use in various FM/CICS panels.

You enter primary commands on the command line of a panel.

Where the syntax allows you to specify more than one operand, you can use either a blank or a comma as a separator between each operand.

For example, both of the following commands are correct:

```
SORT DSN TYPE  
SORT DSN,TYPE
```

The primary commands are listed in two categories:

General primary commands

Commands you can issue from anywhere there is a command line. See [General primary commands on page 71](#).

Selection list primary commands

Commands that apply to the CICS resource selection lists displayed with option 3.4, or when you specify a generic CICS resource name on a function entry panel. See [Selection list primary commands on page 75](#).

General primary commands

CUAATTR primary command

The CUAATTR primary command displays the Change CUA Attributes panel which allows you to change color, intensity, and highlighting attributes for panel elements.

Syntax

► CUAATTR ◀

Availability

Available on all panels

Related tasks

- [Changing panel colors, intensity, and highlighting on page 36](#)

DX primary command

The DX command converts a decimal value to its equivalent hexadecimal value.

Syntax

► DX — *decimal_value* ◄

Availability

This command can be entered on any FM/CICS panel.

Related tasks

[Using hexadecimal values in FM/CICS on page 31](#)

KEYS primary command

The KEYS primary command displays the FMN Keylist Change panel which allows you to display and modify the keys for the current function.

Syntax

► KEYS ◄

Availability

Available on all panels

Related tasks

- [Changing the current key list values on page 37](#)

PFSHOW primary command

The PFSHOW primary command allows the toggling on or off of descriptions of PF Keys.

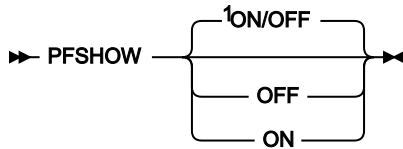
Syntax

Notes:

¹ If no parameter is specified: if the current setting is ON, acts as if OFF as been specified; if the current setting is OFF, acts as if ON has been specified.

ON

Shows PF key descriptions.

OFF

Hides PF key descriptions.

Availability

Available on all panels

Related tasks

- [Hiding or showing PF key descriptions on page 35](#)

SETTINGS primary command

The SETTINGS primary command displays the IPDCC Settings panel, which allows you to change various options and terminal characteristics that affect the way information is displayed on your screen.



Note: For File Manager for z/OS® panels, the option for ISPF SETTINGS drives this command when run from CICS.

Syntax

```
➤ SETTINGS ➤
```

Availability

Available on all panels

Related tasks

- [Changing terminal characteristics on page 35](#)

VER primary command

The VER command displays the FM/CICS release and PTF level, and indicates whether or not FM/CICS is APF-authorized.

If the VER command already exists in the ISPF command table at your site, you can use the LVL synonym to perform the same task.

Syntax

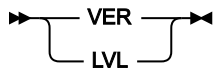

The diagram shows the command syntax for VER. It starts with a right-pointing arrow, followed by the text 'VER'. Below 'VER' is the text 'LVL'. A bracket connects 'LVL' to 'VER', indicating that 'LVL' is a synonym for 'VER'. The command ends with a right-pointing arrow.

Availability

Available on all panels

Related tasks

- [Checking your FM/CICS version on page 19](#)

VERCICS primary command

The VERCICS command displays the level of connected CICS systems.

Syntax



The diagram shows the command syntax for VERCICS. It starts with a right-pointing arrow, followed by the text 'VERCICS', and ends with a right-pointing arrow.

Availability

Available on all panels

Related tasks

- [Checking the level of connected CICS systems on page 19](#)

XD primary command

The XD command converts a hexadecimal value to its equivalent decimal value.

Syntax



The diagram shows the command syntax for XD. It starts with a right-pointing arrow, followed by the text 'XD', then a horizontal line, then the text '*hexadecimal_value*', and ends with a right-pointing arrow.

Availability

Available on all panels.

Results

Related tasks

[Using hexadecimal values in FM/CICS on page 31](#)

Selection list primary commands

FIND primary command

The FIND primary command normally finds the next occurrence of a character string in a selection list.

Syntax

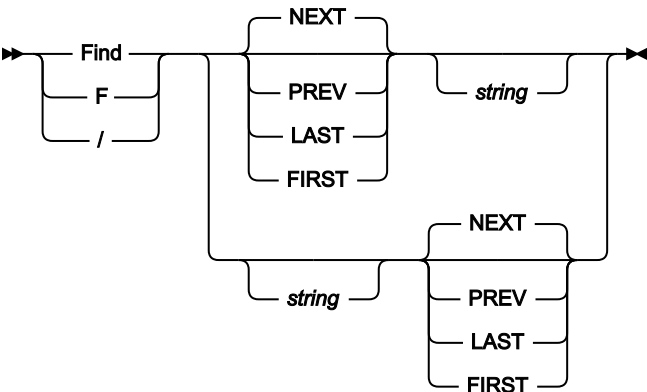

string

The search string can be:

- A character string not starting or ending with a single quotation mark and not containing any embedded blanks or commas. The case of the string is ignored. Uppercase and lowercase representations of the same character match. For example, "Mixed" matches "MIXED".
- A character string enclosed in single quotation marks. The string can contain blanks and commas. The case of the string is ignored.
- C followed by a character string enclosed in quotation marks (C'Frog'), or a character string enclosed in quotation marks followed by c ('Frog'C). The string can contain blanks and commas. The string must match exactly (including case).
- X followed by a hexadecimal string enclosed in single quotation marks (X'C1C2').

Availability

Available on selection lists.

Related tasks

- [Finding a string in a selection list on page 50](#)

HEX primary command

When displaying a Temporary Storage Selection list, use the HEX primary command to display the hexadecimal value of any non-displayable characters in the temporary storage queue name.

Syntax

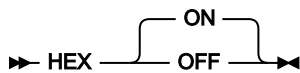

ON

Display the hexadecimal representation of the data vertically (three lines per byte).

OFF

Display the data in character format.

Availability

- [CICS Temporary Storage Selection List panel on page 94](#)

Related tasks

- [Viewing queue names with unprintable characters on page 51](#)

LOCATE primary command

The LOCATE primary command searches the current primary sort order column for an occurrence of the specified string.

Syntax

```
►► LOCATE ►►
```

Availability

Available on selection lists.

Related tasks

- [Searching the current primary sort order column on page 51](#)

REFRESH primary command

The REFRESH primary command replaces the current selection list with a new selection list taken from the matching CICS resources.

Syntax

▶▶ REFRESH ◀◀

Availability

Available on all selection lists.

Related tasks

- [Refreshing the current selection list on page 51](#)

RFIND primary command

The RFIND primary command repeats the search performed by the previous FIND primary command.

Syntax

▶▶ RFIND ◀◀

When your cursor is positioned in the body of the data, RFIND finds the next instance of *string* down from the cursor position. When your cursor is outside of the data area, RFIND finds the first instance of *string*. If you press the RFIND function key (F5), you can easily move to the each instance of *string*, as your cursor remains in the data area after the command is issued. However, if you type the RFIND command on the command line, you need to reposition your cursor on the last instance of *string* and then press Enter, in order to find the next instance.

Availability

Available on all selection lists.

Related tasks

- [Finding a string in a selection list on page 50](#)

SELECT primary command

The SELECT primary command selects items from a display list

Syntax

▶▶ **Select** — *resource_name_pattern* ▶◀

Availability

Available on all selection lists.

Related tasks

- [Selecting items from a display list on page 52](#)

SORT primary command

The SORT primary command sorts a CICS selection list by any two fields displayed on the selection list, except the line command field and Status columns.

Syntax

▶▶ **SORT** ▶◀

Availability

Available on all selection lists.

Related tasks

- [Sorting a CICS selection list on page 53](#)

Chapter 11. FM/CICS panels and fields

These topics list most of the FM/CICS panels. In most cases there is a definition for each field in the panel and, where applicable, the value ranges that are valid for each entry field.

The CICS entry panels for Browse, Edit, View, Print, and List have a field named **Applid** after the command line which displays the VTAM applid of the CICS system. You can specify a generic name to display a list of CICS systems, if an FMNCICS DD describing CICS applids has been allocated to the ISPF session. See the *File Manager Customization Guide* for details.



Note: The **Applid** field can only be modified when running FM/CICS under ISPF.

Browse Entry panels

You use the Browse Entry panels to enter the name of a resource to be browsed. You also use these panels to specify the name of the copybook or template that describes a logical view of the data set.

There are three different Browse Entry panels. The type of Browse Entry panel that FM/CICS displays depends on which **CICS Resource** you selected:

Table 3. Browse Entry panels

CICS Resource	Browse Entry panel displayed
File	Browse CICS File Entry panel
Temporary Storage	Browse Temporary Storage Entry panel
Transient Data	Browse Transient Data Entry panel

Each of the Browse Entry panels is shown below, followed by a list of entry fields covering all three panels. Where an entry field is not common to all three panels, the panel to which it applies is indicated.

Panel and field definitions

Figure 13. Browse CICS File Entry panel

```

Process  Options  Help
-----
FM/CICS          Browse CICS File Entry Panel

Input CICS VSAM File:
  File name . . . . . _____
  Sysid . . . . . _____
  Start position . . . . . _____
  Record limit . . . . . _____ Record sampling _
Copybook or Template:
  Data set name . . . . . _____
  Member . . . . . _____ Blank or pattern for member list
Processing Options:
  Copybook/template  Start position type  Enter "/" to select option
  3 1. Above         - 1. Key             - Edit template  _ Type (1,2,S)
    2. Previous      - 2. RBA             - Include only selected records
    3. None          - 3. Record number
    4. Create dynamic
Command ===> _____ Applid _____
F1=Help   F3=Exit   F4=Expand  F7=Backward F8=Forward F10=Left
F11=Right F12=Cancel
    
```

Figure 14. Browse Temporary Storage Entry panel

```

Process  Options  Help
-----
FM/CICS          Browse Temporary Storage Entry Panel

Input Temporary Storage Queue:
  Queue name . . . . . _____ (Case sensitive)
  Sysid . . . . . _____
  Pool name . . . . . _____
  Start position . . . . . _____ Record number
  Record limit . . . . . _____ Record sampling _
Copybook or Template:
  Data set name . . . . . _____
  Member . . . . . _____ Blank or pattern for member list
Processing Options:
  Copybook/template  Enter "/" to select option
  3 1. Above         - Edit template  _ Type (1,2,S)
    2. Previous      - Include only selected records
    3. None
    4. Create dynamic
Command ===> _____ Applid _____
F1=Help   F3=Exit   F4=Expand  F7=Backward F8=Forward F10=Left
F11=Right F12=Cancel
    
```

Figure 15. Browse Transient Data Entry panel

<u>P</u> rocess	<u>O</u> ptions	<u>H</u> elp
FM/CICS Browse Transient Data Entry Panel		
Input Transient Data Queue:		
Queue name	_____	(Case sensitive)
Sysid	_____	
Start position	_____	Record number
Record limit	_____	Record sampling _
Copybook or Template:		
Data set name	_____	
Member	_____	Blank or pattern for member list
Processing Options:		
Copybook/template	Enter "/" to select option	
3 1. Above	_ Edit template	_ Type (1,2,S)
2. Previous	_ Include only selected records	
3. None		
4. Create dynamic		
Command ==> _____ Applid _____		
F1=Help	F3=Exit	F4=Expand
F11=Right	F12=Cancel	F7=Backward
		F8=Forward
		F10=Left

File name (CICS resource: File only)

The 1–8 character name of the file you want to browse. It is used in conjunction with **Sysid** to produce a list of matching resources.

You can enter a fully-qualified or generic resource name. In a generic resource, use the percentage sign (%) to represent a single character, and an asterisk (*) to represent any number of characters.

Queue name (CICS resource: Temporary Storage only)

The 1–16 character name of the temporary storage queue you want to browse. It is used in conjunction with **Sysid** and **Pool name** to produce a list of matching resources.

You can enter a fully-qualified or generic resource name. In a generic resource, use the percentage sign (%) to represent a single character, and an asterisk (*) to represent any number of characters.

A CICS temporary storage queue name can contain mixed-case and unprintable characters. Therefore, this input field is case sensitive.

To view or enter the hex value of a TS queue name, place the cursor on the field and enter the EXPAND primary command (or equivalent function key). Enter the HEX ON command from within the expand pop-up panel to view and enter hex values.

Queue name (CICS resource: Transient Data only)

The 1–4 character name of the transient data queue you want to browse. It is used in conjunction with **Sysid** to produce a list of matching resources.

You can enter a fully-qualified or generic resource name. In a generic resource, use the percentage sign (%) to represent a single character, and an asterisk (*) to represent any number of characters.

A CICS transient data queue name can contain mixed-case characters. Therefore, this input field is case sensitive.

Sysid

The ID of the CICS systems where the resource resides. A blank value defaults to the local system.

You can enter a fully qualified or generic sysid. In a generic sysid, use the % sign to represent a single character, and an asterisk (*) to represent any number of characters.

Pool name (CICS resource: Temporary Storage only)

The TS pool name of a shared temporary storage pool and temporary storage processing shipped to the temporary storage server that manages the pool.

You can enter a fully-qualified or generic pool name. In a generic pool name use the percentage sign (%) to represent a single character, and an asterisk (*) to represent any number of characters.

If you specify a **Sysid** value and a TS Pool name, then a list of queues that match either is produced from which you can select the appropriate queue for processing.

Start position

Initial starting position for the data set to be browsed. The initial display is positioned at the specified record.

The default is the top of the data set. You can enter a negative record to indicate the number of records before the end of file. For example, to see just the last record on the file, enter -1 as the start point.

The format of the start position field is either numeric or character, depending upon the type of start position selected. For VSAM KSDS Key values, if the value you enter contains leading, embedded or trailing blanks, commas or quotation marks, it must be enclosed in quotation marks. You may also enter a hexadecimal string enclosed in quotation marks and preceded by X or x, for example, `x'c1c2'`.

This field is scrollable and can be expanded with the EXPAND primary command (or equivalent function key). See [Scrollable input and display fields for long names on page 23](#).

For all other data set formats, a valid unsigned number must be entered.

To specify a starting position as the number of records before the end of file, enter a negative record number. For example, to see just the last record on the file, enter a start position of -1.

If you specify a starting position, you should also specify the **Start position type** in the Processing Options. If you do not, File Manager assumes that the value provided in the Starting position field is a record number.

VSAM - KSDS: Key value

If the key is not matched, the record with a key greater than the value given is specified. If the key value is greater than the last record in the data set, the "Position not found" condition is returned.

VSAM - ESDS: RBA (Relative Byte Address) Value

If the RBA is not matched, the record with a RBA greater than the value given is specified. If the RBA value is greater than that of the last record in the data set, the "Position not found" condition is returned.

VSAM - RRDS: Slot value

If the slot number is greater than the last used slot in the data set, the "Position not found" condition is returned.

Queues – temporary storage and transient data

For queues, the start position is the record number. If the specified record number is greater than the number of records in the queue, the "Position not found" condition is returned.

Record limit

This field restricts the number of records retrieved from a data set (from the start point or top) resulting in an edit of a portion of the data set. You can use the keyword "MEMORY" as a record limit to restrict the number of records retrieved to as many as will fit comfortably in the available virtual storage.

The default start position is the top of the data set.

Record Sampling

Indicates whether you want record sampling to be performed on the data set. If you select this option, FM/CICS displays the Record Sampling panel.

Copybook or Template

Data set name and Member name of the template or copybook to be used to format your data.



Note: In the case of a copybook, this can be the name of a CA-Panvalet library, or a library accessed using the Library Management System Exit.

Copybook/template usage

Indicates if you want to use a template for a logical view of the data.

1

Use the template specified on the panel (or compile the specified copybook into a template, and use that).

2

Use the last template associated with the data set.

3

No logical view is to be used by the function.

4

Create a dynamic template.

Start position type (CICS resource: File only)

Determines how FM/CICS interprets the value provided in the Starting position field. If the Start position type is not specified, FM/CICS assumes that the value is a Record Number.

1. KEY

Only valid when the data set is a VSAM KSDS, VSAM AIX or VSAM PATH.

2. RBA

Only valid when the data set is a CICS VSAM ESDS.

3. Record Number

Default. Valid for any type of supported data set.

Edit template

Indicates if you want to edit the template before use. You edit the template when you need to change format, selection, data create attributes, and reformatting information for output copy templates.

Type (1,2,S)

The type of editing you want to perform.

You can specify one of the following values:

1

Edit the Record Identification Criteria by field first

2

Edit the Record Selection Criteria by field first

S

Edit the source definition for a template using the advanced copybook selection facility.

This option is ignored when editing a dynamic template.

Include only selected records

When the FM/CICS editor session is either in-storage (a record limit of *"MEMORY"* is used) or when you have selected **Record Sampling**, only the records selected by template processing are included in the Edit or Browse session.

This option does not alter the operation of the FM/CICS editor session if a template is not used.

Use I/O exit

Allows you to specify a user I/O exit for compressed or encrypted data sets.

This option has two fields. To select the option, enter "/" in the field to the left of Use I/O exit. With this selected, you can then specify which exit to use in the field to the right of the field label.

**Note:**

1. The fields only display if File Manager is installed with the option **USEIOX=ENABLE**, and the **Exit enabled** field (in the Set System Processing Options panel) is set to YES. If a default is specified with either of those options, it is displayed in the field to the right of Use I/O exit.
2. I/O exits can only be used to process the data sets that you are using. They cannot be used to process the copybook or template that you are using to format the data set.

Parent panels

- [Primary Option Menu panels on page 121](#) (when you enter DSB on the command line.)
- When you use the B prefix command in a list of CICS resources.

Child panels

The next panel displayed depends on the options selected in the Browse CICS File Entry panel.

Related tasks

- [Viewing and changing CICS resources on page 42](#)

Change CUA Attributes panel

You use the Change CUA Attributes panel to adjust panel colors, intensity, and highlighting.

Panel and field definitions

Figure 16. Change CUA Attributes panel

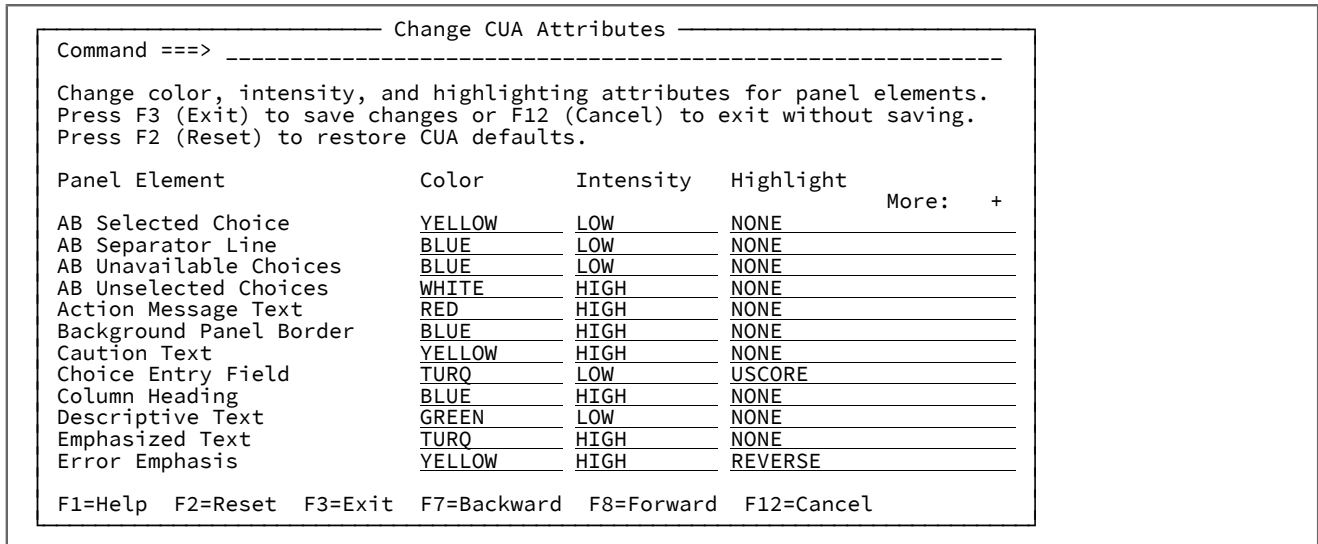

Parent panels

- Any FM/CICS panel.

Child panels

- None.

Related tasks

- [Changing panel colors, intensity, and highlighting on page 36](#)

CICS Enqueue Resource panel

You use the CICS Enqueue Resource panel to display additional CICS attributes for the selected enqueue. You cannot change any of the fields on this panel.

Panel and field definitions

Figure 17. CICS Enqueue Resource panel

Process	Options	Help
FM/CICS	CICS Enqueue	Resource FMLOCK:TS TEST
General		
ENQ resource name	FMLOCK:TS	TEST
Resource length	. 255	
Duration	2454	
Enqfails	0	
Enscope		
Network UOWAUIBMQXP.TCPS1355^5.!V...	
Program	FMN3CICS	
Purgeability	Not purgeable	
Relation	OWNER	
State	ACTIVE	
Sysid		
Task	0000241	
Transaction	FM	
Type	EXECENQ	
UOW	BE5FF5425AE5FD02	
Userid	SAMPLEID	
Qualifier		
Qualifier length	0	
Command ==>		
F1=Help	F3=Exit	F4=CRetrieval F7=Backward F8=Forward F10=Actions
F12=Cancel		

ENQ resource name

The 1–255 characters of the resource name associated with the enqueue lock.

Resource length

The length of the enqueue resource name.

Duration

The elapsed time in seconds since the enqueue entered its current state.

Enqfails

For retained enqueues, the number of failed enqueue attempts for this resource after the enqueue was last acquired.

Enscope

If the enqueue has sysplex scope, the 4-character name which was used to qualify the sysplex-wide enqueue request issued by this CICS region is returned. If it has region scope, blanks are returned.

Network UOW

The 1–27 character network-wide LU6.2 ID of the UOW that issued the enqueue.

Program

The 1–8 character name of the first program invoked by the task executing the transaction specified in the **Transaction** field.

Purgeability

Indicates whether CICS is allowed to purge the task associated with the UOW that issued the enqueue.

Relation

Indicates whether the data being returned is associated with the owner of the enqueue or with a task waiting for the enqueue.

State

The state that the enqueue is held in.

Sysid

The System ID of the CICS system on which the enqueue resides. A blank value indicates the enqueue resides on the local system.

Task

The number of the task associated with the UOW that issued the enqueue.

Transaction

The 1–4 character identifier of the transaction associated with the UOW that issued the enqueue.

Type

The type of resource enqueued upon.

UOW

The 16-character local identifier of the UOW that issued the enqueue.

Userid

The 1–8 character identifier of the user associated with the task specified in the **Task** field.

Qualifier

The optional 0–255 character qualifier that further identifies the resource associated with the enqueue.

Qualifier length

The length of the optional qualifier.

Parent panels

- [CICS Enqueue Selection List panel on page 89](#)

Child panels

- None.

Related tasks

- [Working with CICS enqueues on page 55](#)

CICS Enqueue Selection List panel

The CICS Enqueue Selection List panel shows all the CICS enqueues that match the resource name and sysid values specified on the previous panel. Standard scrolling applies and you can sort any of the columns. You can also perform the following tasks:

- Display attributes related to the CICS enqueue (A or S prefix command)
- Issue PURGE against the task that issued the selected CICS enqueue (P prefix command)
- Issue FORCEPURGE against the task that issued the selected CICS enqueue (F prefix command)

Panel and field definitions

Figure 18. CICS Enqueue Selection List panel

Process	Options	Help				
File Manager		CICS Enqueue Selection List			Row 00001 of 00001	
Resource name (first 36 characters)		Task	Tran	Program	User	Purg +
* FMLOCK:TS TS02		165	FM	FMN3CICS	CICSUSER	NO
**** End of data ****						
Command ==>		Scroll PAGE				
F1=Help	F3=Exit	F4=CRetriev	F5=RFind	F7=Backward	F8=Forward	
F10=Left	F11=Right	F12=Cancel				

Prefix area (first column)

You can use the prefix area to enter the following commands:

A

Displays the CICS Enqueue Resource panel from which you can display and alter the CICS information associated with a given CICS resource, CICS files, or CICS enqueues. Transient data intrapartition and extrapartition only.

F

Issue FORCEPURGE against the task that issued the selected CICS enqueue. CICS enqueues only.

P

The print function is invoked for the CICS file or queue. Option 3.4 only.

For CICS enqueues, PURGE is issued against the task that issued the selected CICS enqueue.

S

For enqueues, the A (Attributes) prefix command is substituted. For any other function selection list, this selects the resource for the calling function.

Resource Name

The first 36 characters of the resource name associated with the enqueue lock. The full resource name can contain 255 characters and can be viewed by entering the A prefix command.

Task

The number of the task associated with the UOW that issued the enqueue.

Tran

The 1–4 character identifier of the transaction associated with the UOW that issued the enqueue.

Program

The 1–8 character name of the first program invoked by the task executing the transaction specified in the **Tran** field.

User

The 1–8 character identifier of the user associated with the task specified in the **Task** field.

Purge

Indicates whether CICS is allowed to purge the task associated with the UOW that issued the enqueue (Purgeability).

SYS

The System ID of the CICS system on which the enqueue resides. A blank value indicates the enqueue resides on the local system.

Parent panels

- [List CICS Resources Entry panel on page 120](#)
- Any FM/CICS entry panel where you use a wildcard when specifying a CICS resource name.

Child panels

- [CICS Enqueue Resource panel on page 86](#)

B

Perform a BROWSE command against the CICS file. Option 3.4 only.

E

Perform an EDIT command against the CICS file. Option 3.4 only.

I

Perform an INFO command against the CICS resource if a z/OS® data set is associated with it. This command displays the data set details and, for VSAM entries, also displays statistics and allocation information.

S

For option 3.4, the edit prefix command (E) is substituted for files and queues. For enqueues, the A (Attributes) prefix command is substituted. For any other function selection list, this selects the resource for the calling function.

P

The print function is invoked for the CICS file or queue. Option 3.4 only.

For CICS enqueues, PURGE is issued against the task that issued the selected CICS enqueue.

V

Perform a VIEW command against the CICS resource. Option 3.4 only.

X

Perform an EXTENTS command against the CICS resource if a z/OS® data set is associated with it. This command displays the statistics and extent information for a data set.

File

The 1–8 character CICS file name.

Data set name

The name of the associated z/OS® data set (if available).

Type

The type of the associated z/OS® data set. The value is VSAM or BDAM for closed files. If a VSAM file is open, **Type** contains KSDS, ESDS, AIX, PATH, RRDS, VRDS values describing the type of VSAM file. For CICS data tables, **Type** contains TABL.

Status

Shows the CICS file attributes and the current status of the file. The status can be changed by overtyping and pressing Enter.

Ope

You can change the open status by overtyping the character with an "O" to open, or "C" to close.

Ena

You can change the enable status by overtyping the displayed character with an "E" to enable, or "D" to disable. A "U" status is only displayed when a file has had a close issued against it.

Rea

This field has either the value "R" or blanks. To change the status, type "R" in the displayed character to set the status, or blank to disallow read to the file.



Note: The read status can only be cleared when browse (**Bro**), update (**Upd**) and delete (**Del**) are also cleared.

Upd

This field has either the value "U" or blanks. To change the status, type "U" in the displayed character to set the status, or blank to disallow updates to the file.

Add

This field has either the value "A" or blanks. To change the status, type "A" in the displayed character to set the status, or blank disallow ADDs to the file.

Bro

This field has either the value "B" or blanks. To change the status, type "B" in the displayed character to set the status or blank to disallow BROWSE to the file.

Del

This field has either the value "D" or blanks. To change the status, type "D" in the displayed character to set the status or blank to disallow DELETES to the file.

Sys

The System ID of the CICS system on which the file has been defined.

Parent panels

- [List CICS Resources Entry panel on page 120](#)
- Any FM/CICS entry panel where you use a wildcard when specifying a CICS resource name.

Child panels

- [File Information panel on page 106](#)

Related tasks

CICS Temporary Storage Selection List panel

You use the CICS Temporary Storage Selection List panel to list all matching temporary storage queues.

Panel and field definitions

Figure 20. CICS Temporary Storage Selection List panel

Process	Options	Help							
File Manager		CICS Temporary Storage Selection List				Row 00001 of 00002			
Queue	Loc	Items	Size	Max	Min	Tran	Last	SYS	Pool
* _ TS01	* AUX	1	128	128	128	* FM	666	*	*
_ TS02	AUX	1	128	128	128	FM	567		
**** End of data ****									
Command ==>								Scroll PAGE	
F1=Help		F3=Exit		F4=CRetriev		F5=RFind		F7=Backward F8=Forward	
F10=Left		F11=Right		F12=Cancel					

Prefix area(first column)

You can use the prefix area to enter the following commands:

B

Perform a BROWSE command against the CICS queue.

D

Delete a temporary storage queue, or delete all the items for a transient data intrapartition queue.

E

Perform an EDIT command against the CICS queue.

P

Print a temporary storage queue.

S

Select a single CICS queue and return to the name for processing by the current function.

V

Perform a VIEW command against the CICS resource.

Queue

The 1–16 character CICS queue ID.

Loc

The location of the temporary storage queue:

AUX

The temporary storage queue is held in the CICS temporary storage VSAM data set.

MAIN

The temporary storage queue is held in main storage.

Items

The number of items currently on this queue.

Size

Total length of all the items for the queue.

Max

The length of the largest item in the queue.

Min

The length of the smallest item in the queue.

Tran

The identifier of the transaction that created the queue.

Last

The interval in seconds since the queue was last referenced.

SYS

The system ID of the CICS system on which the file has been defined.

Pool

The shared TS pool name. this is blank for a non-shared pool.

Parent panels

- [List CICS Resources Entry panel on page 120](#)
- Any FM/CICS entry panel where you use a wildcard when specifying a CICS resource name.

Child panels

- None.

Related tasks

- [Viewing queue names with unprintable characters on page 51](#)

CICS Transient Data Queue Selection List panel

The CICS Transient Data Queue Selection List panel shows all the queues that match the queue name and sysid values specified on the previous panel. Standard scrolling applies and you can sort all of the columns with exception of the status columns. You can also perform the following tasks:

- Open close and modify various queue attributes.
- Display catalog information for extrapartition data sets.
- Invoke various File Manager functions against a queue.

Panel and field definitions

Figure 21. CICS Transient Data Queue Selection List panel

Process	Options	Help								Row	00001 of 00051						
File Manager	Queue	Type	SYS	INDQ	Tran	Term	User	Trig	Items	DDNam	DSP	O	E	I	O	+	
*	*	*	*	*	*	*	*	*	*	*	*	P	N	U	C		
											E	A	P	T	K		
—	CADL	IND		CSSL													
—	CADO	IND		CSSL													
—	CAIL	IND		CSSL													
—	CCPI	IND		CSSL													
—	CCSE	IND		CCSO													
—	CCSO	EXT								COU	SHR	O	E		0		
—	CCZM	IND		CSSL													
—	CDBC	IND		CSSL													
—	CDB2	IND		CSSL													
—	CDUL	IND		CSSL													
—	CEJL	IND		CSSL													
—	CESE	EXT								CEEMSG	MOD	O	E		0		
—	CESO	EXT								CEEOUT	MOD	O	E		0		
—	CIEO	IND		CSSL													
Command ==>											Scroll PAGE						
F1=Help			F3=Exit			F4=CRetriev			F5=RFind			F7=Backward			F8=Forward		
F10=Left			F11=Right			F12=Cancel											

Prefix area (first column)

You can use the prefix area to enter the following commands:

A

Display and alter the CICS information associated with a given CICS resource, CICS files, or CICS enqueues. Transient data intrapartition and extrapartition only.

B

Perform a BROWSE command against the CICS TD queue.

D

Delete the CICS resource.

E

Perform an EDIT command against the CICS queue.

I

Perform an INFO command against the CICS resource if a z/OS data set is associated with it. This command displays the data set details and, for VSAM entries, also displays statistics and allocation information.

P

Print the CICS resource.

S

For option 3.4, the edit prefix command (E) is substituted for files and queues. For enqueues, the A (Attributes) prefix command is substituted. For any other function selection list, this selects the resource for the calling function.

V

Perform a VIEW command against the CICS resource.

X

Perform an EXTENTS command against the CICS resource if a z/OS data set is associated with it. This command displays the statistics and extent information for a data set.

Queue

The 1–4 character CICS queue ID.

Type

Type of queue:

IND

Indirect queue

EXT

Extrapartition queue

INT

Intrapartition queue

SYS

The System ID of the CICS system on which the file has been defined.

INDQ

(Indirect) The 1–4 character queue name that an indirect queue points to. This column is blank for other types of queues.

Tran

(Intrapartition) The 1–4 character transaction to be executed when CICS initiates a task automatically to process the queue. This column only applies to intrapartition queues and is protected for other types of queues. You can overtype the transaction ID with valid CICS transaction characters.

Term

(Intrapartition) The 1–4 character terminal or session associated with the queue. If the facility is a terminal, you can overtype this value with a valid terminal ID. This column only applies to intrapartition queues with a terminal facility.

User

(Intrapartition) The 1–8 character user identifier associated with the queue. If the facility is not a terminal, you can overtype this value with a valid user ID. This column only applies to intrapartition queues without a terminal facility.

Trig

(Intrapartition) The number of items the queue must reach before automatic transaction initiation (ATI) occurs. You can overtype this value with a valid number.

Items

(Intrapartition) The number of items currently on this queue.

DDNam

(Extrapartition) The DD name for the extrapartition queue.

DSP

(Extrapartition) The disposition of the extrapartition data set.

OPE

(Extrapartition) You can change the open status by overtyping the character with an O to open, or C to close.

ENA

You can change the enable status by overtyping the displayed character with an E to enable or D to disable. This field only applies to extrapartition and intrapartition queues.

INP

(Extrapartition) Indicates the extrapartition data set is opened for input.

OUT

(Extrapartition) Indicates the extrapartition data set is opened for output.

BCK

(Extrapartition) Indicates the queue is defined for input and is read backward.

EMP

(Extrapartition) Indicates that CICS has detected an empty (E) or full (F) status for the queue.

Parent panels

- [List CICS Resources Entry panel on page 120](#)
- Any FM/CICS entry panel where you use a wildcard when specifying a CICS resource name.

Child panels

- [Extrapartition Queue panel on page 102](#)
- [Intrapartition Queue panel on page 115](#)

Related tasks**Edit Entry panels**

You use the Edit Entry panels to enter the name of a resource to be edited. You also use these panels to specify the name of the copybook or template that describes a logical view of the data set.

There are three different Edit Entry panels. The type of Edit Entry panel that FM/CICS displays depends on which **CICS Resource** you selected on the Primary Option Menu panel:

Table 4. Edit Entry panels

CICS Resource	Edit Entry panel displayed
File	Edit CICS File Entry panel
Temporary Storage	Edit Temporary Storage Entry panel
Transient Data	Edit Transient Data Entry panel

The Edit Entry panels are virtually identical to the corresponding Browse Entry panels with the following additional options:

- **Inplace edit**
- **Lock resource**
- **Name**
- **Create audit trail**

Each of the Edit Entry panels is shown below followed by a description of the four entry additional fields mentioned above. For an explanation of the other fields in this panel, see the field definitions in [Browse Entry panels on page 79](#).

Panel and field definitions

Figure 22. Edit CICS File Entry panel

```

Process  Options  Help
-----
FM/CICS           Edit CICS File Entry Panel

Input CICS VSAM File:
  File name . . . . . _____
  Sysid . . . . . _____
  Start position . . . . . _____
  Record limit . . . . . _____   Record sampling _____
  Inplace edit . . . . . _____   Prevent inserts and deletes
  Lock resource . . . . . _____   Name _____
Copybook or Template:
  Data set name . . . . . _____
  Member . . . . . _____   Blank or pattern for member list
Processing Options:
Copybook/template  Start position type  Enter "/" to select option
 3 1. Above         - 1. Key             - Edit template  _ Type (1,2,S)
   2. Previous     - 2. RBA             - Include only selected records
   3. None         - 3. Record number  - Create audit trail
   4. Create dynamic

Command ==> _____   Applid _____
F1=Help    F3=Exit    F4=Expand    F7=Backward F8=Forward  F10=Left
F11=Right  F12=Cancel
    
```

Figure 23. Edit Temporary Storage Entry panel

```

Process  Options  Help
-----
FM/CICS           Edit Temporary Storage Entry Panel

Input Temporary Storage Queue:
  Queue name . . . . . _____   (Case sensitive)
  Sysid . . . . . _____
  Pool name . . . . . _____
  Start position . . . . . _____   Record number
  Record limit . . . . . _____   Record sampling _____
  Inplace edit . . . . . _____   Prevent inserts and deletes
  Lock resource . . . . . _____   Name _____
Copybook or Template:
  Data set name . . . . . _____
  Member . . . . . _____   Blank or pattern for member list
Processing Options:
Copybook/template  Enter "/" to select option
 3 1. Above         - Edit template  _ Type (1,2,S)
   2. Previous     - Include only selected records
   3. None         - Create audit trail
   4. Create dynamic

Command ==> _____   Applid _____
F1=Help    F3=Exit    F4=Expand    F7=Backward F8=Forward  F10=Left
F11=Right  F12=Cancel
    
```

Figure 24. Edit Transient Data Entry panel

Process	Options	Help
FM/CICS	Edit Transient Data Entry Panel	
Input Transient Data Queue:		
Queue name	_____	(Case sensitive)
Sysid	_____	
Start position	_____	Record number
Record limit	_____	Record sampling _
Inplace edit	_____	Prevent inserts and deletes
Lock resource	_____	Name _____
Copybook or Template:		
Data set name	_____	
Member	_____	Blank or pattern for member list
Processing Options:		
Copybook/template	Enter "/" to select option	
3 1. Above	-	Edit template _ Type (1,2,S)
2. Previous	-	Include only selected records
3. None	-	Create audit trail
4. Create dynamic		
Command ==>	_____	Applid _____
F1=Help	F3=Exit	F4=Expand F7=Backward F8=Forward F10=Left
F11=Right	F12=Cancel	

Inplace edit

If you select this option, the edit session does not allow you to insert or delete records.

If Inplace edit is not selected for queues, then FM/CICS uses an auxiliary file to allow rewriting of the data.

You must select **Inplace edit** when using any of the following:

- A segmented record type data set (as indicated by your chosen template)
- Record sampling
- A record limit of "MEMORY"
- A VSAM data set defined as NOREUSE

Lock resource

Causes a CICS enqueue to be issued with the enqueue resource name specified in the corresponding **Name** field during the Edit session. The enqueue is issued on the local system that is running FM/CICS.

When editing TS and TD queues, FM/CICS also issues a CICS enqueue that occurs regardless of the Lock setting. The enqueue is issued on the **local system** that is running FM/CICS. This prevents concurrent update access against a TS or TD queue by multiple FM/CICS instances on the same system. FM/CICS uses the following naming convention for the internally generated CICS enqueue resource name: `FMLOCK:xxsysidname` where:

xx

TD or TS.

sysid

The ID of the CICS system where the resource resides. A blank value indicates the resource resides on the local system.

name

The name of the queue.

Name

If the **Lock resource** field is selected, FM/CICS issues a CICS enqueue with the resource name specified in this field for the duration of the Edit session. FM/CICS issues the CICS enqueue with a resource length of 255 and pads all unused characters with blanks.

Create audit trail

Determines if FM/CICS generates an audit report of all successful modifications to data made during an Edit session.

The display of this option depends on whether SAF-rule controlled auditing is in effect. See "SAF-rule controlled auditing" in the *File Manager User's Guide and Reference for DB2 Data*.

The ability to change this option depends on the installation options (in the FMN3POPT macro). The **Create audit trail** option can be:

- When your system administrator has enforced audit logging, the **Create audit trail** option in this panel is ignored.
- When your system administrator has not enforced audit logging, you can set this option on or off for any particular editing task. Type a "/" in the option entry field to generate audit reporting for the current Edit session.

For more information about setting the Audit Trail options, refer to the *File Manager Customization Guide* or see your systems administrator.

Parent panels

- [Primary Option Menu panels on page 121](#)

Child panels

The next panel displayed depends on the options selected in the Edit Entry panel.

Related tasks

- [Viewing and changing CICS resources on page 42](#)

Extrapartition Queue panel

The Extrapartition Queue panel displays the CICS information for the associated queue. You can change the status of the queue from this panel.

You can change the status fields on this panel and view the other information. If the status change fails, you are provided with the CICS command (func=) and error codes which are found in the command code section of the CICS Application Programming Reference. If the request fails, the displayed status represent the current status of the queue.

Panel and field definitions

Figure 25. Extrapartition Queue panel

```

  Process  Options  Help
-----
FM/CICS          Extrapartition Queue CAFF

General
Status . . . . . OPEN      Enabled
Sysid . . . . .
DDname . . . . . CAFF
Disposition . . . SHR
Sysout Class . . *
Record Format . . V
Record Length . . 133
Blocksize . . . . 137
Attributes . . . OUTPUT  IGNORERR

Command ==> _____ Scroll CSR

```

Open

You can change the open status by overtyping the first character with an O to open, or C to close. The following status values can be displayed:

OPEN

Queue is open

OPENING

Queue is being opened

CLOSED

Queue is closed

CLOSING

Queue is being closed

Enabled

You can change the enable status by overtyping the first character with an E to enable, or D to disable. The following status values can be displayed:

DISABLED

Queue is disabled

DISABLING

Queue is being disabled

PENDING

Queue is being pending

ENABLED

Queue is enabled

Sysid

This value is blank for the local system on which File Manager is running and represents the connection ID for remote resources.

DDname

8-character identifier (padded with blanks if necessary) that may refer to a data set name used in the startup JCL.

Data set name

A 1–44 character name that indicates an associated QSAM data set, or DUMMY data set.

Disposition

The disposition for the associated data set:

MOD

The system first assumes that the data set exists. For an existing data set, MOD causes the read/write mechanism to be positioned after the last record in the data set. The read/write mechanism is positioned after the last record each time the data set is opened for output. If the system cannot find volume information for the data set on the DD statement, in the catalog, or passed with the data set from a previous step, the system assumes that the data set is being created in this job step. For a new data set, MOD causes the read/write mechanism to be positioned at the beginning of the data set.

NOTAPPLIC

The option does not apply because the queue is not open or is not an extrapartition queue.

OLD

The data set existed before this job step.

SHR

The data set existed before this job step and can be read by other concurrent jobs.

Sysout Class

A single character indicating the class attribute of the associated SYSOUT data set.

Record Format

FIXED or VARIABLE to indicate whether the queue has fixed or variable length records.

Record Length

The record length (in bytes) for queues having fixed-length records, or the maximum record length for queues having variable-length records.

Blocksize

The length of the block in bytes (in the range 1–32767).

Attributes

Describes attributes of the queue:

BACKWARD

The input queue is read backwards

INPUT

This is an input queue

OUTPUT

This is an output queue

EMPTY

The queue is empty

FULL

The queue is full

IGNORERR

A block that causes an I/O error will be accepted

SKIP

A block that causes an I/O the error will be skipped

LEAVE

The current tape is positioned to the logical end of the data set

REREAD

The current tape is positioned to reprocess the data set

Parent panels

- [CICS Transient Data Queue Selection List panel on page 96](#)

Child panels

- None.

Related tasks

File Information panel

You use the File Information panel to display the CICS file control information for the associated file. You can change the status of the file and various attributes from this panel.

Panel and field definitions

Figure 26. File Information panel

```

Process  Options  Help
-----
FM/CICS          File Information FMKSDS5

Changeable:      Open      Enabled   Read Update Add Browse Delete
Status . . . . . OPEN      ENABLED   READ UPDATE ADD BROWSE DELETE
Data Set Name . . FMN.CICS.TEST.KSDS.FIXED.RECOVER'
Strings . . . . . 5
Disposition      RLS access                Read Integrity
 1 1. SHR          2 1. Not applicable       1 1. Not applicable
  2. OLD          2. No RLS                2. Consistent
                   3. RLS                    3. Repeatable
                   4. Uncommitted
General:
Sysid . . . . .
Type . . . . . KSDS
Key position . . 0
Key length . . . 11
LSR Pool value . 0
Record size . . . 80
Journal number . 0
Attributes . . . FWDRECOV RECOV LOCKING

Command ==> _____ Scroll CSR
    
```

Changeable

This section of the panel contains file attributes that you can alter. Any change causes a close of the file, followed by an attempted change with attributes you have requested. If the request fails, you are provided with the CICS command (func=) and error codes which can be located in the CICS Application Programming Reference under the command code section. If the request fails, the displayed attributes represent the current status of the file.

Open

You can change the open status by overtyping the first character with "O" to open, or "C" to close. The following status values can be displayed:

OPEN

File is open.

OPENING

File is being opened.

CLOSED

File is closed.

CLOSING

File is being closed.

CLOSEREQ

A close has been requested.

Enabled

You can change the enable status by overtyping the first character with "E" to enable, or "D" to disable. The following status values can be displayed:

DISABLED

File is disabled.

DISABLING

File is being disabled.

ENABLED

File is enabled.

UNENABLED

File is closed unenabled.

UNENABLING

File is being unenabled.

Read

This field has either the value READ or blanks. To change the status, type "R" in the first byte to set the status, or clear the field to disallow READ to the file.



Note: The read status can only be cleared when **Browse**, **Update**, and **Delete** are also cleared.

Update

This field has either the value UPDATE or blanks. To change the status, type "U" in the first byte to set the status, or clear the field to disallow updates to the file.

Add

This field has either the value ADD or blanks. To change the status, type "A" in the first byte to set the status, or clear the field to disallow ADDs to the file.

Browse

This field has either the value BROWSE or blanks. To change the status, type "B" in the first byte to set the status, or clear the field to disallow BROWSE to the file.

Delete

This field has either the value DELETE or blanks. To change the status, type "D" in the first byte to set the status, or clear the field to disallow DELETES to the file.

Data Set Name

This field contains the associated data set name. You can enter a fully-qualified or generic data set name to change the name. In a generic data set name, use the percent (%) sign to represent a single character, and an asterisk (*) to represent any number of characters within one qualifier. Two asterisks (**) represent any number of qualifiers.

Strings

This field contains the string number value associated with a VSAM file. It is a value within the range 1–255.

Disposition

You can change the disposition by changing the selection number:

- 1
DISP=SHR
- 2
DISP=OLD

RLS Access

You can change the RLS access value by changing the selection number:

- 1
Does not apply to remote or BDAM data set.
- 2
The data set is not accessed in RLS mode.
- 3
The data set is accessed in RLS mode.



Note: You may get errors opening a file on CICS systems where RLS is not supported.

Read Integrity

You can change the read integrity by changing the selection number:

1

Does not apply to VSAM accessed in non-RLS mode, remote, BDAM, or CFDT files.

2

Consistent. Read requests for this file are subject to consistent read integrity (unless otherwise specified on the read request).

3

Repeatable. Read requests for this file are subject to repeatable read integrity (unless otherwise specified on the read request).

4

Uncommitted. No read integrity for this file.

General:

The following fields are values that cannot be changed for the associated CICS file:

SYSID

Blank for the local system on which File Manager is running and represents the connection ID for remote resources.

Type

VSAM or BDAM for closed files. If a VSAM file is open, this field contains KSDS, ESDS, AIX, PATH, RRDS, VRRDS values describing the type of VSAM file. For CICS data tables, **Type** contains TABL.

Key position

Shown for VSAM files with a keylength > 0 and is the starting position of the key.

Key length

Shown for VSAM files with a keylength > 0 and is the key length.

LSR Pool value

Number indicating the VSAM LSR pool associated with this file. In the range 1–8.

Record size

Maximum record size for variable files or record length for fixed files.

Journal number

A number between 1 and 99 corresponding to the number of the journal to which CICS writes information required for auto journaling. A value of 0 indicates JOURNAL(NO) is specified for the file.

Attributes

The following literals are displayed describing various attributes of the file:

Emptyreq

A reusable VSAM file is reset on open.

Load

The coupling facility data table is, or is to be, preloaded from a source data set.

FWDRECOV

The file is forward recoverable.

RECOV

The file is recoverable.

CFTABLE

Coupling facility data table.

CICSTABLE

CICS-maintained data table.

USERTABLE

User-maintained data table.

KEYED

The data is addressed by physical keys

CONTENTION

The coupling facility data table is updated using the contention model.

LOCKING

The coupling facility data table is updated using the locking model.

EXTENDED

This VSAM data set uses extended relative byte addressing.

Table name

Shown for coupling facility data tables and is the coupling facility data table name.

Table pool

Shown for coupling facility data tables and is the name of the coupling facility data table pool in which the coupling facility data table resides.

Max records

Shown for data tables and indicates the maximum number of records that the data table for this file can hold. A value of 0 may indicate the resource was defined with NOLIMIT.

Parent panels

- [CICS File Selection List panel on page 91](#)

Child panels

- None.

File Manager for CICS Logon panels

There are two forms of the File Manager for CICS Logon panel.

The batch invocation panel is displayed when `START=BATCH` is in effect at logon. It submits a batch job that invokes FM/CICS.

The non-batch invocation panel is displayed when `START=TASK` is in effect at logon.

Panel and field definitions

Figure 27. File Manager for CICS Logon panel - batch invocation

```

----- File Manager for CICS Logon -----

Enter Logon parameters
Userid . . . . . FMUSER
Password . . . . .          New Password . . .
Node . . . . . PTHAPD0    (Machine the job is to be run on)
Procedure. . . . . FMN3CICB (Procedure to run File Manager)
Profile data set . . . FMUSER.IPV.IPVPROF
Prefix . . . . . FMUSER   (Default prefix for data sets)
Jobcard
//FM&TERM.B JOB (,,,)&USER,
//      MSGCLASS=A,MSGLEVEL=(1,1),CLASS=A
-----
F1=Help  F3=Logoff  F4=Reset  F5=Wait  F6=Default  F12=Cancel
Enter=Submit

```

Figure 28. File Manager for CICS Logon panel - non-batch invocation

```

----- File Manager for CICS Logon -----

Enter Logon parameters
Userid . . . . . FMUSER
Password . . . . .
New Password . . . . .
Profile data set . . . FMUSER.IPV.IPVPROF
Prefix . . . . . FMUSER   (Default prefix for data sets)
Port . . . . . 2054
Host name

F1=Help  F3=Logoff  F4=Reset  F6=Default  F12=Cancel

```

Userid

A 1–7 character MVS userid. For batch invocation, this is the owner of the submitted job. This is specified when invoking the File Manager transaction.

Password

(Batch invocation.) The current password for the MVS userid. The password is not visible during logon.

(Non-batch invocation.) The current password or passphrase for the MVS userid.

New Password

A new password (if you want to change the current password for the MVS userid).

(Non-batch invocation only.) You can enter a passphrase of up to 100 characters.

Node

(Batch invocation only.) The 1–8 character machine Node on which the job is to run. A `/*ROUTE XEQ node.user` statement is added after the job card to run the job on the specified machine.

Procedure

(Batch invocation only.) The 1–8 character procedure name that has been set up to run File Manager on your system. The default procedure is FMN3CICB.

Profile data set

The profile data set used to save session information for subsequent invocations.

Prefix

1–8 character value used as the prefix high-level qualifier when specifying unquoted data sets during the File Manager session.

Jobcard

(Batch invocation only.) The jobcard used for the submitted job. The jobcard can use the following variables which are substituted when the job is submitted:

&TERM

The current 1–4 character terminal ID is substituted.

&USER

The current 1–7 character MVS userid is substituted.



Note:



1. You can terminate the variable with a period which will also be removed during substitution.
2. The jobcard should be unique and assigned to a class where it will run immediately.

Port

(Non-batch invocation only.) Port number which used to connect to the ADFzCC server . This value is defined in the FMN3POPT options module currently loaded.

Host name

(Non-batch invocation only.) Host name of the system where the ADFzCC server is running. This value is defined in the FMN3POPT options module currently loaded. If a host name is blank, then FM/CICS obtains and uses the host name of the current system.

The function keys are:

F1

Help panel.

F3

Exit. Exit File Manager and save logon parameters.

F4

Reset. Restore logon parameters as at start of session.

F5

(Non-batch invocation only.) Wait. Use this to tell File Manager to wait another 20 seconds when the batch job has not been responding.

F6

Default: Change the logon parameters to the installation defaults.

F12

Cancel. Exit File Manager without saving logon parameters.

Parent panels

- CICS logon panel

Child panels

- [Primary Option Menu panels on page 121](#)

Related tasks

[Starting FM/CICS on page 16.](#)

FMN Keylist Change panel

You use the FMN Keylist Change panel to display and modify the keys for the current function.

Panel and field definitions

Figure 29. FMN Keylist Change panel

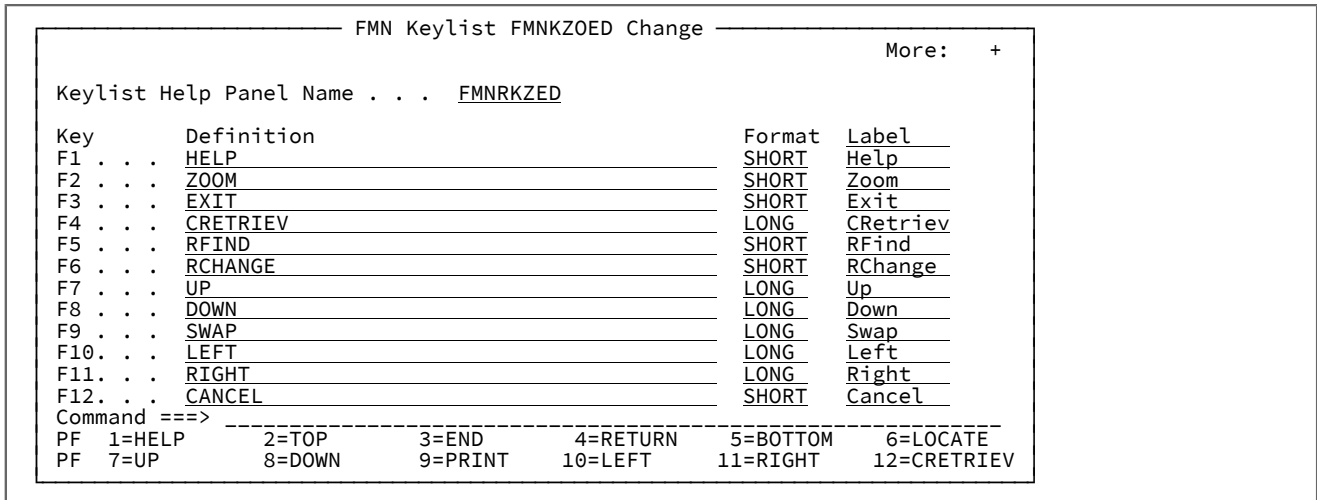

You can change the current key list values by the values displayed. You can scroll up and down to view all the function key values.

The fields shown on the Function keys change panel are:

Keylist help panel name

The name of the help panel for this keylist.

Key

Function key

Definition

The command for each assigned function key.

FORMAT

You can enter one of the following values:

LONG

Indicates that you want this key label to display only when you request the long form of the function key area. Long is the default.

SHORT

Indicates that you want this key label to display when you request either the short or long form of the function key area.

NO

Indicate that the key label should never be displayed in the function key area.

Label

Enter the label you want to appear with each assigned function key.

Parent panels

- Any FM/CICS panel.

Child panels

- None.

Related tasks

- [Changing the current key list values on page 37](#)

Intrapartition Queue panel

You use the Intrapartition Queue panel to display the CICS information for the associated queue. You can change the status of the queue from this panel.

Panel and field definitions

Figure 30. Intrapartition Queue panel

```

  Process  Options  Help
-----
FM/CICS          Intrapartition Queue CSZX
Changeable:          Enabled
Status . . . . . ENABLED
Transaction . . . . CZUX
Terminal . . . . .
User . . . . . CICSUSER
Trigger level . . . 1
Facility
1 1. No Terminal
  2. Terminal
General:
Sysid . . . . .
Number of items . . 0
Attributes . . . . NOTRECOVERABLE

Command ==> _____ Scroll CSR

```

Changeable fields

This section of the panel contains queue attributes that you can alter. Any change causes the associated queue to be disabled followed by an attempted change with attributes you have requested. If the request fails, you are provided with the CICS command (func=) and error codes which can be found in command code section of the CICS Application Programming Reference. If the request fails, the displayed attributes represent the current status of the queue.

Enabled

You can change the enable status by overtyping the first character with an E to enable, or D to disable. The following status values can be displayed:

DISABLED

Queue is disabled

DISABLING

Queue is being disabled

PENDING

Queue is being pending

ENABLED

Queue is enabled

Transaction

The 1–4 character transaction to be executed when CICS initiates a task automatically to process the queue. You can overtype the transaction ID with valid CICS transaction characters.

Terminal

The 1–4 character terminal or session associated with the queue. If the facility is set to terminal, then you can overtype this value with a valid terminal ID.

User

The 1–8 character user identifier associated with the queue. If the facility is a not a terminal, you can overtype this value with valid user ID.

Trigger level

The number of items the queue must reach before automatic transaction initiation (ATI) occurs. You can overtype this value with a valid number.

Facility

Indicates whether a terminal is associated with queue:

1

No terminal associated with queue

2

Terminal associated with queue

General

The following fields cannot be changed for the associated CICS queue:

Sysid

Blank for the local system on which File Manager is running, and represents the connection ID for remote resources.

Number of items

The number of items currently on this queue.

Attributes

Describes attributes of the queue:

QUEUE

The UOW is in doubt and waiting; any locks held by the UOW for this queue remain active until the final state of the UOW is known. This means that tasks are suspended rather than receiving the LOCKED response. When the final state of the UOW is known, any changes that it has made are committed or backed out. Until then, any further requests of the following types that need one of the active locks must wait:

READQ

The in doubt UOW has issued READQ or DELETEDQ requests.

WRITEQ

The in doubt UOW has issued WRITEQ or DELETEDQ requests.

DELETEDQ

The in doubt UOW has issued READQ, WRITEQ, or DELETEDQ requests.

REJECT

The UOW is in doubt and waiting, and any locks held by the UOW for this queue are retained until the final state of the UOW is known. When the final state is known, any changes it has made are committed or backed out. Until then, any further requests that need one of the retained locks are rejected, and a LOCKED condition is returned. REJECT causes LOCKED to be raised in exactly the same circumstances as those in which QUEUE causes a transaction to wait.

WAIT

The UOW is to wait and any action required while waiting is determined by the WAITACTION option.

NOWAIT

The UOW is not to wait, and any changes made to recoverable resources are to be backed out or committed, as specified by the ACTION attribute on the transaction resource definition.

LOGICAL

The queue is logically recoverable.

NOTRECOVERABLE

The queue is not recoverable.

PHYSICAL

The queue is physically recoverable.

Parent panels

- [CICS Transient Data Queue Selection List panel on page 96](#)

Child panels

- None.

Related tasks

IPDCC Settings panel

You use the IPDCC (ADFz Common Components) Settings panel to change various options and terminal characteristics that affect the way information is displayed on your screen.

Panel and field definitions

Figure 31. IPDCC (ADFz Common Components) Settings panel

```

----- IPDCC -----
Command ==> -----
Options:
  Enter "/" to select option
  / Command line at bottom
  / Panel display CUA mode
  / Tab to action bar choices
  - Graphic border

Terminal Characteristics:
Screen format  2  1. Data    2. Std    3. Max
Terminal type  1  1. 3270   2. 3270KN

PF 1=HELP      2=TOP      3=END      4=RETURN   5=BOTTOM   6=LOCATE
PF 7=UP        8=DOWN     9=PRINT   10=LEFT    11=RIGHT   12=CRETRIEV
    
```

Command line at bottom

Determines whether the command line and long message line appear at the bottom of your panel.

Panel display CUA mode

Determines whether the panel is displayed in CUA mode and action bars are displayed.

Tab to action bar choices

Determines whether the Tab key positions the cursor on action bar choices when not running in GUI mode.

Graphic Border

Determines whether you can force dotted lines if the action bar separator line or borders are not displayed correctly.

Screen Format

Determines the screen formatting. The supported formats are:

DATA (1)

Alternate screen sizes are used for expandable panels only.

STD (2)

Always format 24 lines by 80 characters

MAX (3)

Always uses the alternate screen size

Terminal Type

Determines the terminal type. The supported types are as follows:

3270 (1)

Terminal does not support Japanese Katakana characters.

3270KN (2)

Terminal supports Japanese Katakana characters.

Parent panels

- Any FM/CICS panel.

Child panels

- None.

Related tasks

- [Changing terminal characteristics on page 35](#)

List CICS Resources Entry panel

You use the List CICS Resources Entry panel to list the resources matching the entered name, sysid, and TS pool.

Panel and field definitions

Figure 32. List CICS Resources Entry panel

```

Process  Options  Help
-----
FM/CICS                               List CICS Resources Entry Panel

CICS File, Transient Data, Temporary Storage Queue, or Enqueue Name:
Resource name . . . _____
Sysid . . . . . _____
TS pool name . . . _____

Processing Options:
CICS Resource
 1. File
 2. Temporary Storage (Case sensitive)
 3. Transient Data (Case sensitive)
 4. Enqueue

Command ==> _____ Applid _____
F1=Help    F3=Exit    F4=Expand    F7=Backward F8=Forward  F10=Left
F11=Right  F12=Cancel
    
```

Resource name

A 1–36 character resource name used in conjunction with **Sysid** to produce a list of matching resources. It can also be used in conjunction with **TS pool name** for TS queues.

You can enter a fully-qualified or generic resource name. In a generic resource, use the % sign to represent a single character, and an asterisk (*) to represent any number of characters.

If Temporary Storage or Transient Data is selected as the CICS resource type, the value entered in the **Resource name** input field is case sensitive.

Sysid

The ID of the CICS systems where the resource resides. A blank value defaults to the local system.

You can enter a fully qualified or generic sysid. In a generic sysid, use the % sign to represent a single character, and an asterisk (*) to represent any number of characters.

TS pool name

Pool Name (TS Data sharing only) (Default blanks) This is used to specify the pool name of a shared temporary storage pool and temporary storage processing is shipped to the temporary storage server that manages the pool. You can enter a fully qualified or generic pool name. In a generic pool name use the % sign to represent a

single character, and an asterisk * to represent any number of characters. If you specify a SYSID value and a TS Pool name then a list of queues that match either is produced from which you can select the appropriate queue for processing.

CICS Resource

CICS resource processing type:

1. File

CICS files

2. Temporary Storage

CICS temporary storage queues

3. Transient Data

CICS transient data queues

4. Enqueue

CICS enqueues

Parent panels

- [Utility Functions panel on page 131](#)

Child panels

- [CICS File Selection List panel on page 91](#)
- [CICS Temporary Storage Selection List panel on page 94](#)
- [CICS Transient Data Queue Selection List panel on page 96](#)
- [CICS Enqueue Selection List panel on page 89](#)

Related tasks

- [Working with lists of CICS resources on page 50](#)
- [Working with CICS enqueues on page 55](#)

Primary Option Menu panels

The Primary Option Menu panel is the starting point for all FM/CICS operations.

Panel and field definitions

Figure 33. File Manager Primary Option Menu panel

```

Process  Options  Help
-----
FM/CICS                                Primary Option Menu

0  Settings      Set processing options           User ID . . : JHELVON
1  Browse        Browse data                       Appl ID . . : FMN3
2  Edit          Edit data                         CICS User  : CICSUSER
3  Utilities     Perform utility functions        CICS Appl  : C62D2FM3
4  Templates     Template and copybook utilities  Date. . .  : 2018/12/12
FM FM          File Manager for z/OS®
FI FM/IMS      File Manager for IMS
FD FM/Db2      File Manager for Db2
X  Exit         Terminate FM/CICS

Processing Options:
CICS Resource
 1 1. File
   2. Temporary Storage
   3. Transient Data

Command ==> _____
F1=Help      F3=Exit      F4=CRetriev F7=Backward F8=Forward  F10=Actions
F12=Cancel
    
```

0 Settings

Displays the Set Processing Options panel.

1 Browse

Displays one of the Browse Entry panels. The type of Browse Entry panel displayed is determined by the setting of the **CICS Resource** field.

2 Edit

Displays one of the Edit Entry panels. The type of Edit Entry panel displayed is determined by the setting of the **CICS Resource** field.

3 Utilities

Displays the Utility Functions panel.

4 Templates

Displays the File Manager Base function Template Workbench panel.

FM FM

Displays the File Manager Base component Primary Option Menu panel.

FI FM/IMS

Displays the File Manager IMS Component Primary Option Menu panel.

FD FM/Db2

Displays the File Manager Db2® Component Primary Option Menu panel.

X Exit

Exits from FM/CICS.

CICS Resource

The type of CICS resource you want to work with:

1. File

Select this option to work with CICS files.

2. Temporary Storage

Select this option to work with CICS temporary storage queues.

3. Transient Data

Select this option to work with CICS transient data queues.

The File Manager and FM options **only** appear on the Primary Option Menu if your user ID is authorized.

If you are running FM/CICS under ISPF, a modified FM/CICS Primary Option Menu panel is displayed.

Figure 34. FM/CICS File Manager Primary Option Menu panel (when using ISPF)

```

Process  Options  Help
-----
FM/CICS                Primary Option Menu
1 View          View data          User ID . . : JHELVON
2 Edit          Edit data          Date. . . . : 2018/12/12
3 Print         Print data         Time.....: 14:17
4 List          List resources
X Exit          Terminate FM/CICS

Processing Options:
CICS Resource
 1 1. File
   2. Temporary Storage
   3. Transient Data

Command ==>
F1=Help   F3=Exit   F4=CRetrie v F7=Backward F8=Forward  F10=Actions
F12=Cancel

```

1 View

Displays one of the View Entry panels. The type of View Entry panel displayed is determined by the setting of the **CICS Resource field**.

2 Edit

Displays one of the Edit Entry panels. The type of Edit Entry panel displayed is determined by the setting of the **CICS Resource field**.

3 Print

Displays one of the Print Entry panels. The type of Print Entry panel displayed is determined by the setting of the **CICS Resource** field.

4 List

Displays the List CICS Resources Entry panel.

X Exit

Exits from FM/CICS.

CICS Resource

Same as definition for [Primary Option Menu panels on page 121](#).

Parent panels

[File Manager for CICS Logon panels on page 111](#)

Child panels

- [Set Processing Options panel on page 130](#)
- [Browse Entry panels on page 79](#)
- [Edit Entry panels on page 99](#)
- [Print Entry panels on page 124](#)
- [List CICS Resources Entry panel on page 120](#)
- [Utility Functions panel on page 131](#)
- *"Set DBCS Format panel"* in the File Manager User's Guide and Reference
- *"Print Audit Trail panel"* in the File Manager User's Guide and Reference

Related tasks

- [Starting FM/CICS on page 16](#)
- [Specifying resource names in File Manager for z/OS \("Base"\) on page 39](#)
- [Running the File Manager Base function against CICS resources on page 39](#)
- [Working with FM/CICS utilities on page 48](#)

Print Entry panels

You use the Print Entry panels to enter the name of a resource to be browsed. You also use these panels to specify the name of the copybook or template that describes a logical view of the data set.

There are three different Print Entry panels. The type of Print Entry panel that FM/CICS displays depends on which **CICS Resource** you selected on the previous panel (Utility Functions or Primary Option Menu):

Table 5. Print Entry panels

CICS Resource	Print Entry panel displayed
File	Print CICS File Entry panel
Temporary Storage	Print Temporary Storage Entry panel
Transient Data	Print Transient Data Entry panel

Each of the Print Entry panels is shown below, followed by a list of entry fields covering all three panels. Most of the entry fields are common to all three panels. Where an entry field is not common to all three panels, the panel to which it applies is indicated.

Panel and field definitions

Figure 35. Print CICS File Entry panel

```

Process  Options  Help
-----
FM/CICS          Print CICS File Entry Panel

Input CICS VSAM File:
File name . . . . . _____
Sysid . . . . . _____
Start key . . . . . _____ key or slot
Skip count . . . . . _____ number of records to be skipped
Print count . . . . . ALL _____ number of records to be printed

Copybook or Template:
Data set name . . . . . _____
Member . . . . . _____ (Blank or pattern for member list)

Processing Options:
Print Option      Copybook/template/access  Enter "/" to select option
- 1. Char         3 1. Above                 _ Edit template _ Type (1,2,S)
  2. Hex          2 2. Previous                _ Use proc _____
  3. Sngl         3 3. None
  4. Tabl         4 4. Create dynamic        _ Additional print options

Command ==> _____ Applid _____
F1=Help      F3=Exit      F4=Expand    F7=Backward  F8=Forward   F10=Actions
F12=Cancel

```

Figure 36. Print Temporary Storage Entry panel

Process	Options	Help
FM/CICS	Print Temporary Storage Entry Panel	
Input Temporary Storage Queue:		
Queue name	_____	(Case sensitive)
Sysid	_____	
Pool name	_____	
Skip count	_____	number of records to be skipped
Print count	ALL _____	number of records to be printed
Copybook or Template:		
Data set name	_____	
Member	_____ (Blank or pattern for member list)	
Processing Options:		
Print Option	Copybook/template/access	Enter "/" to select option
- 1. Char	3 1. Above	- Edit template
2. Hex	2. Previous	- Use proc _____
3. Sngl	3. None	
4. Tabl	4. Create dynamic	- Additional print options
Command ==> _____ Applid _____		
F1=Help	F3=Exit	F4=Expand F7=Backward F8=Forward F10=Actions
F12=Cancel		

Figure 37. Print Transient Data Entry panel

Process	Options	Help
FM/CICS	Print Transient Data Entry Panel	
Input Transient Data Queue:		
Queue name	_____	(Case sensitive)
Sysid	_____	
Skip count	_____	number of records to be skipped
Print count	ALL _____	number of records to be printed
Copybook or Template:		
Data set name	_____	
Member	_____ (Blank or pattern for member list)	
Processing Options:		
Print Option	Copybook/template/access	Enter "/" to select option
- 1. Char	3 1. Above	- Edit template
2. Hex	2. Previous	- Use proc _____
3. Sngl	3. None	
4. Tabl	4. Create dynamic	- Additional print options
Command ==> _____ Applid _____		
F1=Help	F3=Exit	F4=Expand F7=Backward F8=Forward F10=Actions
F12=Cancel		

File name (CICS resource: File only)

The 1–8 character name of the file you want to print. It is used in conjunction with **Sysid** to produce a list of matching resources.

You can enter a fully-qualified or generic resource name. In a generic resource, use the percentage sign (%) to represent a single character, and an asterisk (*) to represent any number of characters.

Queue name (CICS resource: Temporary Storage only)

The 1–16 character name of the temporary storage queue you want to print. It is used in conjunction with **Sysid** to produce a list of matching resources.

You can enter a fully-qualified or generic resource name. In a generic resource, use the percentage sign (%) to represent a single character, and an asterisk (*) to represent any number of characters.

This input field is case sensitive.

To view or enter the hex value of a TS queue name, place the cursor on the field and enter the EXPAND primary command (or equivalent function key). Enter the HEX ON command from within the expand pop-up panel to view and enter hex values.

Queue name (CICS resource: Transient Data only)

The 1–4 character name of the transient data queue you want to print. It is used in conjunction with **Sysid** to produce a list of matching resources.

You can enter a fully-qualified or generic resource name. In a generic resource, use the percentage sign (%) to represent a single character, and an asterisk (*) to represent any number of characters.

This field is case sensitive.

Sysid

The ID of the CICS systems where the resource resides. A blank value defaults to the local system.

You can enter a fully-qualified or generic sysid. In a generic sysid, use the % sign to represent a single character, and an asterisk (*) to represent any number of characters.

Pool name (CICS resource: Temporary Storage only)

The TS pool name of a shared temporary storage pool and temporary storage processing shipped to the temporary storage server that manages the pool.

You can enter a fully-qualified or generic pool name. In a generic pool name use the percentage sign (%) to represent a single character, and an asterisk (*) to represent any number of characters.

If you specify a **Sysid** value and a TS Pool name, then a list of queues that match either is produced from which you can select the appropriate queue for processing.

Start key (CICS resource: File only)

The starting key or slot location for a VSAM file

This field is scrollable and can be expanded with the EXPAND primary command (or equivalent function key).

See [Scrollable input and display fields for long names on page 23](#).

Skip count

The number of records to be skipped before processing begins

Print count

The number of records to be printed

Copybook or Template: Data set name and Member

These fields identify either a copybook or a template to be used to select records and format the print output.

If a copybook is specified, it is compiled to create a temporary template that can optionally be saved if edit was requested.

Print Option

The format of the printed output:

Char

Records are printed in character format.

Hex

Records are printed in hexadecimal format. The DUMP processing option on the Set Processing Options panel determines how HEX data is printed. See [Set Processing Options panel on page 130](#).

Sngl

Single record format (one field on each line of the display). The left-hand side of the printout contains the field or header names. The right-hand side contains the field values formatted according to the field type. A template is required for this option.

In this print format, additional field information (redefined fields, field reference number, field type and length values, picture clause, start location, structure) can be printed depending on the Edit/Browse options. Numeric fields can be left-justified depending on the options.

Tabl

Tabular format (fields printed across the display). The records are displayed in columns with field or heading names as column headers and the data formatted according to the field types. In this format, the display might be truncated depending on the current print width. A template is required for this option.

Copybook/template/access

Use this option to specify if you want to use a template, or how records are to be printed.

Above

FM/CICS uses the template specified on the panel. (If you specified a copybook, then File Manager compiles the copybook into a template before use.)

Previous

FM/CICS uses the last template you used to process this resource. If you have not previously used a template for this data set, a message is displayed and processing continues without using a template.

None

FM/CICS does not use a template. SNGL and TABL print formats are not available.

Create dynamic

FM/CICS creates a dynamic template. You can now define fields and field creation attributes.

Edit template

FM/CICS opens the template you have specified for editing, before processing the panel.



Note: For details about using templates, see *“Creating and editing templates”* in the File Manager User’s Guide and Reference.

Type (1,2,S)

The type of editing you want to perform.

You can specify one of the following values:

1

Edit the Record Identification Criteria by field first

2

Edit the Record Selection Criteria by field first

S

Edit the source definition for a template using the advanced copybook selection facility.

This option is ignored when editing a dynamic template.

Use proc

Use this option to specify a procedure to search and change the data, rather than using the Find and Change commands. When you select the option, you can perform one of these actions:

- Choose to create a temporary procedure for one-time use by entering a single asterisk (*). FM/CICS displays an Edit panel, in which you can create the procedure.
- Specify the name of the member containing the procedure you want to use. The member must belong to the PDS allocated to ddname FMNEXEC. You can enter any of the following:
 - The name of the member.
 - A member name pattern (other than a single *) to list all matching members. You can then select the required member by entering an **s** in the **Sel** field. A member name pattern can consist of any characters that are valid in a member name and the following two special pattern characters:

asterisk (*)

Represents any number of characters. As many asterisks as required can appear anywhere in a member name. For example, if you enter `*d*`, a list of all members in the data set whose name contains “d” is displayed.

percent sign (%)

A place-holding character representing a single character. As many percent symbols as necessary can appear anywhere in a member name. For example, if you enter `%%%`, a list of all members in the data set whose name is four characters in length is displayed.



Note: If you select this option but leave the **Use proc** member entry field blank, File Manager displays a member name list. You can then select the required member by entering **s** in the **Sel** field.

(Also, see “*Supplying a procedure when using a File Manager panel*” in the File Manager User’s Guide and Reference.)

Additional print options

Displays the Print Options panel allowing you to specify additional print options.

Parent panels

- [Utility Functions panel on page 131](#)

Child panels

- “*Print Options panel*” in the File Manager User’s Guide and Reference

Related tasks

- [Printing a CICS resource on page 49](#)

Set Processing Options panel

Lists the processing options available within FM/CICS. Selecting an option displays the relevant options panel.

Panel and field definitions

Figure 38. Set Processing Options panel

Process	Options	Help
FM/CICS	Set Processing Options	
1	Print	Print settings
2	System	System settings
3	Compiler	Language and compiler specifications
4	EDIT	Editor options
5	Sharing	VSAM Edit sharing options
6	Temporary	Temporary Data Set Allocations
7	Output	Output Data Set Allocations
8	Trace	Trace options
Command ==> _____		
F1=Help	F3=Exit	F4=CRetrieiv F7=Backward F8=Forward F10=Actions
F12=Cancel		

1 Print

Displays the Set Print Processing Options panel

2 System

Displays the Set System Processing Options panel

3 Compiler

Language and compiler specifications

4 EDIT

Displays the Edit/Browse Options panel

5 Sharing

VSAM Edit Sharing Options panel

6 Temporary

Displays the Set Temporary Data Set Allocation Options panel

7 Output

Displays the Set Output Data Set Allocation Options panel

8 Trace

Displays the Set Trace options panel

Parent panels

- [Primary Option Menu panels on page 121](#)

Child panels

- *“Set Print Options panel (option 0.1)”* in the File Manager User’s Guide and Reference
- *“Language and Compiler Specifications panel”* in the File Manager User’s Guide and Reference
- *“Edit/Browse Options panel”* in the File Manager User’s Guide and Reference
- *“VSAM Edit Sharing Options panel”* in the File Manager User’s Guide and Reference
- *“Set Temporary Data Set Allocation Options”* in the File Manager User’s Guide and Reference
- *“Set Output Data Set Allocation Options”* in the File Manager User’s Guide and Reference
- *“Set Trace options”* in the File Manager User’s Guide and Reference

Related tasks

- [Setting your System Processing Options on page 38](#)
- [Setting your default processing options on page 37](#)

Utility Functions panel

Lists the utility functions available within FM/CICS. Selecting an option displays the relevant utility entry panel.

Panel and field definitions

Figure 39. Utility Functions panel

```

Process  Options  Help
-----
FM/CICS                               Utility Functions

0 DBCS          Set DBCS data format for print
2 Print         Print data
4 List          List resources
5 Printdsn     Browse FM/CICS print data set
6 Audit trail   Print audit trail report
7 Websphere MQ List Websphere MQ managers and queues

Processing Options:
CICS Resource
1 1. File
    2. Temporary Storage
    3. Transient Data

Command ==>
F1=Help      F3=Exit      F4=CRetriev F7=Backward F8=Forward  F10=Actions
F12=Cancel
    
```

0 DBCS

Displays the Set DBCS Format panel

2 Print

Displays the Print CICS File Entry panel

4 List

Displays the List CICS Resources Entry panel

5 Printdsn

Displays print output in full-screen mode

6 Audit trail

Displays the Print Audit Trail panel

7 Websphere MQ

Displays the Websphere MQ Managers panel

For more information about accessing Websphere MQ queues, see the "Base" *File Manager User's Guide*.

Parent panels

- [Primary Option Menu panels on page 121](#)

Child panels

- “Set DBCS Format panel” in the File Manager User’s Guide and Reference
- [Print Entry panels on page 124](#)
- [List CICS Resources Entry panel on page 120](#)
- “Print Audit Trail panel” in the File Manager User’s Guide and Reference
- “Copybook View and Print: Entry panel” in the File Manager User’s Guide and Reference
- “WebSphere MQ Managers panel” in the File Manager User’s Guide and Reference

Related tasks

- [Working with FM/CICS utilities on page 48](#)
- [Working with lists of CICS resources on page 50](#)
- [Working with CICS enqueues on page 55](#)

View Entry panels

You use the View Entry panels to enter the name of a resource to be edited. You also use these panels to specify the name of the copybook or template that describes a logical view of the data set.



Note: If you want to save any changes you make in the File Manager/CICS editor session, use the FM/CICS Edit Utility.

There are three different View Entry panels. The type of View Entry panel that FM/CICS displays depends on which **CICS Resource** you selected on the Primary Option Menu panel:

Table 6. View Entry panels

CICS Resource	View Entry panel displayed
File	View CICS File Entry panel
Temporary Storage	View Temporary Storage Entry panel
Transient Data	View Transient Data Entry panel

Each of the View panels is shown below, followed by a list of entry fields covering all three panels. Where an entry field is not common to all three panels, the panel to which it applies is indicated.

Panel and field definitions

Figure 40. View CICS File Entry panel

<u>P</u> rocess	<u>O</u> ptions	<u>H</u> elp
FM/CICS	View CICS File Entry Panel	
Input CICS VSAM File:		
File name	_____	
Sysid	_____	
Start position	_____	
Record limit	_____	Record sampling _
Copybook or Template:		
Data set name	_____	
Member	_____	Blank or pattern for member list
Processing Options:		
Copybook/template	Start position type	Enter "/" to select option
3 1. Above	- 1. Key	- Edit template _ Type (1,2,S)
2. Previous	2. RBA	- Include only selected records
3. None	3. Record number	
4. Create dynamic		
Command ==> _____ Applid _____		
F1=Help	F3=Exit	F4=Expand F7=Backward F8=Forward F10=Left
F11=Right	F12=Cancel	

Figure 41. View Temporary Storage Entry panel

<u>P</u> rocess	<u>O</u> ptions	<u>H</u> elp
FM/CICS	View Temporary Storage Entry Panel	
Input Temporary Storage Queue:		
Queue name	_____	(Case sensitive)
Sysid	_____	
Pool name	_____	
Start position	_____	Record number
Record limit	_____	Record sampling _
Copybook or Template:		
Data set name	_____	
Member	_____	Blank or pattern for member list
Processing Options:		
Copybook/template	Enter "/" to select option	
3 1. Above	-	Edit template _ Type (1,2,S)
2. Previous	-	Include only selected records
3. None		
4. Create dynamic		
Command ==> _____ Applid _____		
F1=Help	F3=Exit	F4=Expand F7=Backward F8=Forward F10=Left
F11=Right	F12=Cancel	

Figure 42. View Transient Date Entry panel

<u>P</u> rocess	<u>O</u> ptions	<u>H</u> elp
FM/CICS	View Transient Data Entry Panel	
Input Transient Data Queue:		
Queue name	_____	(Case sensitive)
Sysid	_____	
Start position	_____	Record number
Record limit	_____	Record sampling _
Copybook or Template:		
Data set name	_____	
Member	_____	Blank or pattern for member list
Processing Options:		
Copybook/template	Enter "/" to select option	
3 1. Above	_ Edit template	_ Type (1,2,S)
2. Previous	_ Include only selected records	
3. None		
4. Create dynamic		
Command ==> _____ Applid _____		
F1=Help	F3=Exit	F4=Expand
F11=Right	F12=Cancel	F7=Backward
		F8=Forward
		F10=Left

File name (CICS resource: File only)

The 1–8 character name of the file you want to browse. It is used in conjunction with **Sysid** to produce a list of matching resources.

You can enter a fully-qualified or generic resource name. In a generic resource, use the percentage sign (%) to represent a single character, and an asterisk (*) to represent any number of characters.

Queue name (CICS resource: Temporary Storage only)

The 1–16 character name of the temporary storage queue you want to browse. It is used in conjunction with **Sysid** and **Pool name** to produce a list of matching resources.

You can enter a fully-qualified or generic resource name. In a generic resource, use the percentage sign (%) to represent a single character, and an asterisk (*) to represent any number of characters.

Queue name (CICS resource: Transient Data only)

The 1–4 character name of the transient data queue you want to browse. It is used in conjunction with **Sysid** to produce a list of matching resources.

You can enter a fully-qualified or generic resource name. In a generic resource, use the percentage sign (%) to represent a single character, and an asterisk (*) to represent any number of characters.

Sysid

The ID of the CICS systems where the resource resides. A blank value defaults to the local system.

You can enter a fully qualified or generic sysid. In a generic sysid, use the % sign to represent a single character, and an asterisk (*) to represent any number of characters.

Pool name (CICS resource: Temporary Storage only)

The TS pool name of a shared temporary storage pool and temporary storage processing shipped to the temporary storage server that manages the pool.

You can enter a fully-qualified or generic pool name. In a generic pool name use the percentage sign (%) to represent a single character, and an asterisk (*) to represent any number of characters.

If you specify a **Sysid** value and a TS Pool name, then a list of queues that match either is produced from which you can select the appropriate queue for processing.

Start position

Initial starting position for the data set to be browsed. The initial display is positioned at the specified record.

The default is the top of the data set. You can enter a negative record to indicate the number of records before the end of file. For example, to see just the last record on the file, enter -1 as the start point.

The format of the start position field is either numeric or character, depending upon the type of start position selected. For VSAM KSDS Key values, if the value you enter contains leading, embedded or trailing blanks, commas or quotation marks, it must be enclosed in quotation marks. You may also enter a hexadecimal string enclosed in quotation marks and preceded by X or x, for example, `X'C1C2'`.

For all other data set formats, a valid unsigned number must be entered.

To specify a starting position as the number of records before the end of file, enter a negative record number. For example, to see just the last record on the file, enter a start position of -1.

If you specify a starting position, you should also specify the **Start position type** in the Processing Options. If you do not, File Manager assumes that the value provided in the Starting position field is a record number.

VSAM - KSDS: Key value

If the key is not matched, the record with a key greater than the value given is specified. If the key value is greater than the last record in the data set, the "Position not found" condition is returned.

VSAM - ESDS: RBA (Relative Byte Address) Value

If the RBA is not matched, the record with a RBA greater than the value given is specified. If the RBA value is greater than that of the last record in the data set, the "Position not found" condition is returned.

VSAM - RRDS: Slot value

If the slot number is greater than the last used slot in the data set, the "Position not found" condition is returned.

Queues — temporary storage and transient data

For queues, the start position is the record number. If the specified record number is greater than the number of records in the queue, the "Position not found" condition is returned.

Record limit

This field restricts the number of records retrieved from a data set (from the start point or top) resulting in an edit of a portion of the data set. You can use the keyword *"MEMORY"* as a record limit to restrict the number of records retrieved to as many as will fit comfortably in the available virtual storage.

The default start position is the top of the data set.

Record Sampling

Indicates whether you want record sampling to be performed on the data set. If you select this option, FM/CICS displays the Record Sampling panel.

Copybook or Template

Data set name and Member name of the template or copybook to be used to format your data.



Note: In the case of a copybook, this can be the name of a CA-Panvalet library, or a library accessed using the Library Management System Exit.

Copybook/template usage

Indicates if you want to use a template for a logical view of the data.

1

Use the template specified on the panel (or compile the specified copybook into a template, and use that).

2

Use the last template associated with the data set.

3

No logical view is to be used by the function.

4

Create a dynamic template.

Start position type (CICS resource: File only)

Determines how FM/CICS interprets the value provided in the Starting position field. If the Start position type is not specified, FM/CICS assumes that the value is a Record Number.

1. KEY

Only valid when the data set is a VSAM KSDS, VSAM AIX or VSAM PATH.

2. RBA

Only valid when the data set is a CICS VSAM ESDS.

3. Record Number

Default. Valid for any type of supported data set.

Edit template

Indicates if you want to edit the template before use. You edit the template when you need to change format, selection, data create attributes, and reformatting information for output copy templates.

Type (1,2,S)

The type of editing you want to perform.

You can specify one of the following values:

1

Edit the Record Identification Criteria by field first

2

Edit the Record Selection Criteria by field first

S

Edit the source definition for a template using the advanced copybook selection facility.

This option is ignored when editing a dynamic template.

Include only selected records

When the FM/CICS editor session is either in-storage (a record limit of "MEMORY" is used) or when you have selected **Record Sampling**, only the records selected by template processing are included in the Edit or Browse session.

This option does not alter the operation of the FM/CICS editor session if a template is not used.

Use I/O exit

Allows you to specify a user I/O exit for compressed or encrypted data sets.

This option has two fields. To select the option, enter "/" in the field to the left of Use I/O exit. With this selected, you can then specify which exit to use in the field to the right of the field label.



Note:



1. The fields only display if File Manager is installed with the option **USEIOX=ENABLE**, and the **Exit enabled** field (in the Set System Processing Options panel) is set to YES. If a default is specified with either of those options, it is displayed in the field to the right of Use I/O exit.
2. I/O exits can only be used to process the data sets that you are using. They cannot be used to process the copybook or template that you are using to format the data set.

Parent panels

- [Primary Option Menu panels on page 121](#)

Child panels

The next panel displayed depends on the options selected in the View Entry panel.

Related tasks

- [Viewing and changing CICS resources on page 42](#)

Support resources

Use these resources to find product details, fixes, and support.

Search knowledge bases

- Download a Program Directory:
 - [Program Directory for Application Delivery Foundation for z/OS Common Components](#)
 - [Program Directory for IBM File Manager for z/OS](#)
 - [Program Directory for IBM Fault Analyzer for z/OS](#)
- Get up-to-date details about installing, customizing, and using these products:
 - [Application Delivery Foundation for z/OS Common Components Customization Guide and User Guide](#)
 - [Fault Analyzer User's Guide and Reference](#)
 - [File Manager Customization Guide](#)
 - [File Manager User's Guide and Reference](#)
 - [File Manager User's Guide and Reference for DB2](#)
 - [File Manager User's Guide and Reference for CICS](#)
 - [File Manager User's Guide and Reference for IMS](#)

Get the latest PTFs

- [ADFz Common Components](#)
- [Fault Analyzer for z/OS](#)
- [File Manager for z/OS](#)
- [z/OS Debugger](#)
- [IBM Developer for z/OS Enterprise Edition](#)
- [Application Performance Analyzer for z/OS](#)

Collect diagnostic data

Before you contact Support, be ready to answer these questions:

- What software versions are you running?
- Do you have logs, traces, and messages related to the problem?
- Can you re-create the problem? If so, how do you re-create the problem?
- Did you make hardware, operating system, or networking software changes?
- Do you have a workaround for the problem?

Contact Support

Open a case, chat with Support, or connect to resources and communities through <https://www.ibm.com/mysupport>.

Notices

IBM File Manager for z/OS License Materials - Property of IBM Corp. and HCL Technologies Ltd. © Copyright IBM Corporation 2000, 2016. © Copyright HCL Technologies Limited 2017, 2026

This information was developed for products and services offered in the U.S.A.

IBM® may not offer the products, services, or features discussed in this document in other countries. Consult your local IBM representative for information on the products and services currently available in your area. Any reference to an IBM product, program, or service is not intended to state or imply that only that IBM product, program, or service may be used. Any functionally equivalent product, program, or service that does not infringe any IBM intellectual property right may be used instead. However, it is the user's responsibility to evaluate and verify the operation of any non-IBM product, program, or service.

IBM may have patents or pending patent applications covering subject matter described in this document. The furnishing of this document does not give you any license to these patents. You can send license inquiries, in writing, to:

IBM Director of Licensing
IBM Corporation
North Castle Drive, MD-NC119
Armonk, NY 10504-1785
US

For license inquiries regarding double-byte (DBCS) information, contact the IBM Intellectual Property Department in your country or send inquiries, in writing, to:

Intellectual Property Licensing
Legal and Intellectual Property Law
IBM Japan Ltd.
19-21, Nihonbashi-Hakozakicho, Chuo-ku
Tokyo 103-8510, Japan

INTERNATIONAL BUSINESS MACHINES CORPORATION PROVIDES THIS PUBLICATION "AS IS" WITHOUT WARRANTY OF ANY KIND, EITHER EXPRESS OR IMPLIED, INCLUDING, BUT NOT LIMITED TO, THE IMPLIED WARRANTIES OF NON-INFRINGEMENT, MERCHANTABILITY OR FITNESS FOR A PARTICULAR PURPOSE. Some jurisdictions do not allow disclaimer of express or implied warranties in certain transactions, therefore, this statement may not apply to you.

This information could include technical inaccuracies or typographical errors. Changes are periodically made to the information herein; these changes will be incorporated in new editions of the publication. IBM may make improvements and/or changes in the product(s) and/or the program(s) described in this document at any time without notice.

Any references in this information to non-IBM websites are provided for convenience only and do not in any manner serve as an endorsement of those websites. The materials at those websites are not part of the materials for this IBM product and use of those websites is at your own risk.

IBM may use or distribute any of the information you provide in any way it believes appropriate without incurring any obligation to you.

Licensees of this program who want to have information about it for the purpose of enabling: (i) the exchange of information between independently created programs and other programs (including this one) and (ii) the mutual use of the information which has been exchanged, should contact:

*IBM Director of Licensing
IBM Corporation
North Castle Drive, MD-NC119
Armonk, NY 10504-1785
US*

Such information may be available, subject to appropriate terms and conditions, including in some cases, payment of a fee.

The licensed program described in this information and all licensed material available for it are provided by IBM under terms of the IBM Customer Agreement, IBM International Program License Agreement, or any equivalent agreement between us.

The performance data discussed herein is presented as derived under specific operating conditions. Actual results may vary.

Information concerning non-IBM products was obtained from the suppliers of those products, their published announcements or other publicly available sources. IBM has not tested those products and cannot confirm the accuracy of performance, compatibility or any other claims related to non-IBM products. Questions on the capabilities of non-IBM products should be addressed to the suppliers of those products.

Statements regarding future direction or intent of IBM File Manager for z/OS are subject to change or withdrawal without notice, and represent goals and objectives only.

This information contains examples of data and reports used in daily business operations. To illustrate them as completely as possible, the examples include the names of individuals, companies, brands, and products. All of these names are fictitious and any similarity to the names and addresses used by an actual business enterprise is entirely coincidental.

COPYRIGHT LICENSE:

This information contains sample application programs in source language, which illustrates programming techniques on various operating platforms. You may copy, modify, and distribute these sample programs in any form without payment to IBM, for the purposes of developing, using, marketing or distributing application programs conforming to the application programming interface for the operating platform for which the sample programs are written. These examples have not been thoroughly tested under all conditions. IBM, therefore, cannot guarantee or imply reliability, serviceability, or function of these programs. The sample programs are provided "AS IS", without warranty of any kind. IBM shall not be liable for any damages arising out of your use of the sample programs.

Each copy or any portion of these sample programs or any derivative work must include a copyright notice as follows:

© (your company name) (year).

Portions of this code are derived from IBM Corp. and/or

HCL Ltd. sample programs.

© Copyright IBM Corp. 2000, 2016. © Copyright HCL Ltd. 2017, 2026.

Programming interface information

This documentation describes intended Programming Interfaces that allow the customer to write programs to obtain the services of File Manager.

Trademarks

IBM®, the IBM® logo, and ibm.com® are trademarks or registered trademarks of International Business Machines Corp., registered in many jurisdictions worldwide. Other product and service names might be trademarks of IBM® or other companies. A current list of IBM® trademarks is available on the web at "Copyright and trademark information" at www.ibm.com/legal/copytrade.shtml.

Terms and conditions for product documentation

Permissions for the use of these publications are granted subject to the following terms and conditions.

Applicability

These terms and conditions are in addition to any terms of use for the IBM® website.

Personal use

You may reproduce these publications for your personal, noncommercial use provided that all proprietary notices are preserved. You may not distribute, display or make derivative work of these publications, or any portion thereof, without the express consent of IBM®.

Commercial use

You may reproduce, distribute and display these publications solely within your enterprise provided that all proprietary notices are preserved. You may not make derivative works of these publications, or reproduce, distribute or display these publications or any portion thereof outside your enterprise, without the express consent of IBM®.

Rights

Except as expressly granted in this permission, no other permissions, licenses or rights are granted, either express or implied, to the publications or any information, data, software or other intellectual property contained therein.

IBM® reserves the right to withdraw the permissions granted herein whenever, in its discretion, the use of the publications is detrimental to its interest or, as determined by IBM®, the above instructions are not being properly followed.

You may not download, export or re-export this information except in full compliance with all applicable laws and regulations, including all United States export laws and regulations.

IBM® MAKES NO GUARANTEE ABOUT THE CONTENT OF THESE PUBLICATIONS. THE PUBLICATIONS ARE PROVIDED "AS-IS" AND WITHOUT WARRANTY OF ANY KIND, EITHER EXPRESSED OR IMPLIED, INCLUDING BUT NOT LIMITED TO IMPLIED WARRANTIES OF MERCHANTABILITY, NON-INFRINGEMENT, AND FITNESS FOR A PARTICULAR PURPOSE.

IBM Online Privacy Statement

IBM Software products, including software as a service solutions, ("Software Offerings") may use cookies or other technologies to collect product usage information, to help improve the end user experience, to tailor interactions with the end user, or for other purposes. In many cases no personally identifiable information is collected by the Software Offerings. Some of our Software Offerings can help enable you to collect personally identifiable information. If this Software Offering uses cookies to collect personally identifiable information, specific information about this offering's use of cookies is set forth below.

This Software Offering does not use cookies or other technologies to collect personally identifiable information.

If the configurations deployed for this Software Offering provide you as customer the ability to collect personally identifiable information from end users via cookies and other technologies, you should seek your own legal advice about any laws applicable to such data collection, including any requirements for notice and consent.

For more information about the use of various technologies, including cookies, for these purposes, see IBM's Privacy Policy at <http://www.ibm.com/privacy> and IBM's Online Privacy Statement at <http://www.ibm.com/privacy/details> in the section entitled "Cookies, Web Beacons and Other Technologies," and the "IBM Software Products and Software-as-a-Service Privacy Statement" at <http://www.ibm.com/software/info/product-privacy>.

Programming interface information

The User's Guide and Reference documents intended Programming Interfaces that allow the customer to write programs to obtain the services of File Manager.

Index

A

APF-authorized 19, 74

B

Base functions, running 39
BDAM files 44
Browse Entry panels 79
browsing CICS resources , *See* viewing

C

CA-Panvalet 26
Change CUA Attributes panel 85
CICS
 checking level of connected systems 19, 74
 data table 44, 92, 109, 110
 Enqueue Resource panel 86
 Enqueue Selection List panel 89
 File Selection List panel 91
 files
 viewing 44
 releases supported by FM/CICS 15
 resource
 lists 50
 locking 47
 printing 49
 resources
 viewing 42
 system requirements FM/CICS 15
 temporary storage
 viewing 44
 Temporary Storage Selection List panel 94
 Transient Data Queue Selection List panel 96
 transient data queues
 viewing 46
COBOL, processing option 39
commands
 reading syntax diagrams viii
commands, issuing 24
copybooks
 stored in CA-Panvalet library 26
 viewing CICS resources 43
CUAATTR primary command 36, 71

D

data set
 information 92, 97, 106
 name
 patterns 28
 specifying on panel 26
data table 44, 92, 109, 110
decimal to hexadecimal converter 31, 72
DOWN primary command 22
DX primary command 31, 72
dynamic template, specifying 83, 137

E

Edit Entry panel 99
EDIT, processing option 39
editor session, starting 44
error messages, viewing 34
errors
 messages 57
Exit 20
 exiting from FM/CICS 20
EXPAND primary command 23
Extrapartition Queue panel 102

F

FI prefix 40
File Information panel 106
File Manager
 CICS Logon panel 111
 Db2, running under FM/CICS 41
 flavors vii
 IMS, running under FM/CICS 41
 level of connected CICS systems 74
files, CICS
 viewing 44

FIND primary command 50, 75
first page, scrolling to 22
flavors, of File Manager vii
FM/CICS
 checking level of connected CICS systems 19
 checking version 19
 customizing 35
 exiting 20, 20
 function keys change panel 114
 main functions 14
 starting 16
 using interface 21
FM/CICS Primary Option Menu panel 123
FORWARD primary command 22
fragments, syntax diagrams viii
functions, FM/CICS 14

H

help
 accessing 31
 fields 32
 tutorial 32
HEX primary command 76
hexadecimal to decimal converter 31, 74
HLASM, processing option 39

I

IMS component, running under FM/CICS 41, 41
interface, FM/CICS 21
Intrapartition Queue panel 115
IPDCC Settings panel 118

K

key list values, changing 37
KEYS primary command 37, 72
keywords, syntax diagrams viii

L

LANG, processing option 39
last page, scrolling to 22
license inquiry cxli
List CICS Resources Entry panel 120
lists, resources
 finding string 50
 refreshing 51
 searching 51
 selecting items 52, 53
 sorting 53
 working with 50
LOCATE primary command 51, 76
locking, CICS resource 47
logical view, showing data without 83, 137

M

member name
 PDS, specifying on panel 26
 specifying 29

 specifying on panel 26
messages
 list 57

O

Output, processing option 39

P

pages, scrolling to
 first 22
 last 22
panel colors, changing 36
panels
 Browse Entry 79
 Change CUA Attributes 85
 CICS Enqueue Resource 86
 CICS Enqueue Selection List 89
 CICS File Selection List 91
 CICS Temporary Storage Selection List 94
 CICS Transient Data Queue Selection List 96
 Edit Entry 99
 Extrapartition Queue 102
 File Information 106
 File Manager CICS Logon 111
 FM/CICS function keys change 114
 FM/CICS Primary Option Menu 123
 Intrapartition Queue 115
 IPDCC Settings 118
 List CICS Resources Entry 120
 moving between 21
 Primary Option Menu 121
 Print Entry 124
 Set Processing Options 130
 showing more information 21
 Utility Functions 132
 View Entry 133
PFSHOW primary command 35, 72
PK keys, hiding or showing 35
PL/I, processing option 39
pool name, specifying 25
POOLNAME, specifying 24
prefix
 commands 24
 resource name 40
primary commands
 CUAATTR 36, 71
 DOWN 22
 FIND 75
 FORWARD 22
 general 24
 KEYS 37, 72
 LOCATE 76
 PFSHOW 35, 72
 REFRESH 77
 RFIND 77
 SELECT 78
 SETTINGS 36, 73
 SORT 78
 UP 22
Primary Option Menu panel 121
Print Entry panel 124
Print, processing option 39
printing, CICS resource 49
processing options 37
Program Directory cxl
PTF level, displaying FM/CICS 19, 74

Q

quoted strings, specifying 30

R

REFRESH primary command 77
refreshing current selection list 51
release, displaying FM/CICS 19, 74
repeatable items, syntax diagrams viii
repeating search 77
resource attributes
 changing 52
resources
 CICS
 locking 47
 viewing 42
 names
 distinguishing from data set name 40
 specifying in Base File Manager 39
 specifying in FM/CICS 24
 printing 49
 selection list 26
 working with lists 50
RFINN primary command 50, 77

S

scrollable fields 23
scrolling
 in panels 22, 22
 to first page 22
 to last page 22
search
 primary sort order column 51
 repeating 77
SELECT primary command 78
selecting items from list 52, 53
Set Processing Options panel 130
SETTINGS primary command 35, 73
Sharing, processing option 39
SORT primary command 78
sorting lists 53
starting FM/CICS 16
string
 delimiters 30
 entering when quoted 30
 finding 50
syntax diagrams, how to read viii
SYSID, specifying 25
system processing options 38
system requirements FM/CICS 15
System, processing option 39

T

TD prefix 40
templates
 editing before use 84, 138
 viewing CICS resources 43
temporary storage
 viewing 44
Temporary, processing option 39
terminal, changing characteristics 35
transient data queues
 viewing 46
TS
 pool name, specifying 25
 prefix 40

U

unprintable characters, HEX primary
 command 76
unprintable characters, viewing
 refreshing 51
UP primary command 22
utilities

base File Manager 48
FM/CICS 48
Utility Functions panel 131

V

variables, syntax diagrams viii
VER primary command 19, 74
VERCICS primary command 19, 74
version, FM/CICS, checking 19
View Entry panel 133
viewing
 CICS
 files 44
 resources 42
 transient data queues 46

X

XD primary command 31, 74

Z

ZEXPAND primary command 23