

**IBM File Manager for z/OS®
User's Guide and Reference for IMS Data
Version 15.1.6**

Note

Before using this document, read the general information under [Notices on page dclxxxix](#).

Edition Notice

This edition (published November 2024) applies to Version 15 Release 1 Modification Level 6 of IBM® File Manager for z/OS® (program number 5755-A03) and to all subsequent releases and modifications until otherwise indicated in new editions.

Contents

About this document.....	x	Output data set allocation options (option 0.8).....	44
Who should use this document.....	xi	Trace options (option 0.9).....	44
Prerequisite and related information.....	xi	Displaying or editing DBCS characters.....	44
How to read syntax diagrams.....	xi	National characters.....	45
Summary of changes.....	xv	Chapter 4. Viewing your databases.....	47
Part I. Working with FM/IMS.....	16	Accessing your databases.....	47
Chapter 1. Overview.....	17	About the different access modes.....	47
Databases and segments.....	17	Deciding if you will use a view.....	48
FM/IMS and hierarchical databases.....	19	Accessing in BMP mode using a Static PSB.....	49
DLI and BMP modes in FM/IMS.....	20	Accessing in BMP mode using a Dynamic PSB.....	51
Dynamic and static PSBs.....	21	Accessing in DLI mode using a Static PSB.....	52
Templates and views.....	21	Accessing in DLI mode using a Dynamic PSB.....	55
Why use a template and views?.....	21	Unavailable HALDB partitions and DEDB areas in browse or edit.....	57
What can you do with views?.....	23	Determining how to display your data.....	58
Where can you use views?.....	24	Setting your initial display format.....	58
Working with HALDB partitions and DEDB areas.....	24	How FM/IMS finds a position in the database.....	59
Chapter 2. System requirements for File Manager for IMS™.....	26	Determining your starting position via the Database Positioning panel.....	59
Chapter 3. Getting started.....	27	Determining your starting position via the Key Specification panel.....	60
Starting and exiting FM/IMS.....	27	Manipulating your view of the data.....	61
Starting FM/IMS.....	27	Selecting a display format.....	61
Checking your FM/IMS version.....	28	Zooming in to see all of a segment.....	67
Checking which COBOL compiler you're using.....	29	Scrolling to see data.....	68
Exiting from FM/IMS.....	30	Locating a field or column.....	71
Using the FM/IMS interface.....	30	How the sliding window affects scrolling and database position.....	71
Navigating in FM/IMS.....	31	Printing your database in batch.....	72
Specifying a Library data set.....	32	Creating a keys file.....	73
Using hexadecimal values in FM/IMS.....	36	Generating a batch job that performs a print.....	73
Getting help.....	37	Modifying the JCL to specify the KEYLIST, KEYRANGE and MAXROOTS parameters.....	76
Displaying field help information.....	37	Print reports.....	77
Accessing Tutorial Help.....	38	Viewing your database in batch.....	77
Viewing expanded error messages.....	40	IBB REXX procedure (Batch Browse).....	79
Setting processing options.....	40	Listing statistics for the current Browse or Edit session.....	81
Set print processing options (option 0.1).....	41	Chapter 5. Working with Templates and Views.....	82
System settings (option 0.2).....	41	Creating and updating templates.....	82
Set batch job card information (option 0.3).....	42	Creating a template.....	82
Set language and compiler specifications (option 0.4).....	42	Updating templates.....	85
Compiler language selection (option 0.4.1).....	42	Editing templates.....	94
COBOL processing options (option 0.4.2).....	42	Creating and editing views.....	98
HLASM processing options (option 0.4.3).....	43	Creating a view prior to browsing or editing.....	99
PL/I processing options (option 0.4.4).....	43	Creating a view while browsing or editing.....	100
Editor options (option 0.5).....	43		
IMS subsystem settings (option 0.6).....	43		
Temporary data set allocation options (option 0.7).....	44		

Updating views	100	Changing segments in records.....	142
Editing a view.....	103	Inserting segments.....	142
Selecting and excluding segment types and layouts.....	105	Repeating segments.....	144
Selecting and sequencing fields in a view.....	106	Deleting segments.....	145
Setting field attributes.....	107	Editing your database in batch.....	146
Displaying a field without truncation.....	108	IEB REXX procedure (Batch Edit).....	148
Defining date and time fields.....	108	Chapter 7. Managing data.....	151
Specifying scrambling options.....	109	Defining and initializing IMS databases.....	151
Selecting a field for specifying scrambling options.....	109	Deleting and redefining your data sets.....	151
Using views to filter data display.....	113	Initializing an empty database.....	153
Changing the currently formatted segment type.....	113	Extracting data.....	156
Showing shadow lines.....	114	Creating a full copy of a database.....	157
Specifying field selection criteria.....	115	Partial extract using a Keys file.....	159
The effects of selecting and field selection criteria.....	115	Partial extract using extract criteria.....	162
File Manager and REXX.....	118	Modifying the JCL to specify the KEYLIST, KEYRANGE and MAXROOTS parameters.....	167
General information about REXX.....	118	Extracting and loading DEDB databases with sequential dependent segments.....	168
Using the REXX compiler.....	118	Creating an extract template.....	170
Improving performance using internal expression processing.....	118	Extract reports.....	172
Overview of REXX expressions.....	119	Loading data.....	172
Handling floating point numbers.....	122	Loading into an initialized database.....	173
Comparison operators.....	123	Loading into an uninitialized database.....	175
Arithmetic operators.....	125	Load reports.....	177
Logical (Boolean) operators.....	127	Chapter 8. Working with Criteria.....	179
Useful functions.....	127	Criteria Set Entry panel.....	179
REXX examples.....	129	Create a Criteria Set using a template (CT).....	180
Chapter 6. Editing data.....	131	Create a Criteria Set from model (CM).....	180
Committing changes to your database.....	131	Edit Criteria Set (E).....	180
Concurrent editing and data locks.....	132	Updating criteria sets.....	181
Setting your checkpoint frequency.....	132	Updating one criteria set in the foreground using option 4.3.....	181
Using AUTOSAVE.....	133	Updating one or more criteria sets in the foreground or as a batch job using option 4.6... ..	181
Undoing your changes.....	133	Changing Relationship Criteria.....	183
Changing data.....	134	Changing Field Selection Criteria.....	185
Changing data in individual segments.....	134	Chapter 9. Printing an audit trail report.....	186
Editing size fields in variable-length segments.....	135	What does the report contain?.....	186
Finding and changing strings.....	135	How to create an audit trail data set.....	186
Sequence of searched segments.....	136	How to print an audit trail report.....	186
Finding a string.....	136	SMF logfile retrieval JCL.....	188
Finding invalid data.....	137	Audit Trail report.....	188
Changing invalid numeric fields in your data.....	137	Part II. Reference.....	191
Handling long strings in FIND.....	138	Chapter 10. Panels and fields.....	192
Changing strings.....	138	Advanced Member Selection panel.....	192
Handling long strings in CHANGE.....	139	AGN Selection panel.....	193
Limiting the search in FIND or CHANGE.....	139	Batch Browse Entry panel.....	195
		Batch Browse Options panel.....	201
		Batch Edit Entry panel.....	201

Batch Edit Options panel.....	207	PCB Selection panel.....	343
BMP Mode Options panel.....	209	Primary Option menu.....	346
BMP Mode Parameters panel.....	212	Print Audit Trail panel.....	349
Browse Entry panel.....	214	Print Entry panel.....	351
Compiler Language Selection panel.....	220	Print Options panel.....	358
Copybook Library List panel.....	222	PSB and DBD Data Sets panel.....	359
Criteria Member Selection panel.....	224	PSB Selection panel.....	361
Criteria Set Entry panel.....	226	Record Type Selection panel.....	362
Criteria Set Update Utility panel.....	229	Redefines / Range Specifications panel.....	363
Data Set Selection panel.....	233	Relationship Criteria panel.....	365
Database Data Set Display panel.....	234	Secondary Index Selection panel.....	367
Database Data Set Specification panel.....	236	Segment Information panel.....	369
Database Hierarchy panel.....	239	Segment Layout panel.....	370
Database Positioning panel.....	239	Segment Layout Selection panel.....	377
Database Selection panel.....	242	Segment Selection panel.....	379
Date/Time Attributes panel.....	244	Set Batch Job Card Information panel.....	381
DBD Information panel.....	248	Set COBOL Processing Options panel.....	382
DBD Library List panel.....	250	Set HLASM Processing Options panel.....	384
Delete/Define Entry panel.....	251	Set Language and compiler specifications panel.....	385
DLI Mode Data Sets 1 panel.....	254	Set Output Data Set Allocation Options panel.....	386
DLI Mode Data Sets 2 panel.....	256	Set PL/I Processing Options panel.....	389
DLI Mode Options panel.....	259	Set Print Processing Options panel.....	390
DLI Mode Parameters panel.....	262	Set Temporary Data Set Allocation Options panel.....	394
Edit Entry panel.....	266	Set Trace options panel.....	396
Editor Options panel.....	272	Settings Menu panel.....	397
Extract Entry panel.....	275	Subset Selection panel.....	399
Extract Options panel.....	282	Subsystem Selection panel.....	401
Extract : To Data Set Specification panel.....	285	Subsystem Settings Menu panel.....	404
Field Attributes panel - alphanumeric fields.....	287	System Settings panel.....	406
Field Attributes panel - numeric field.....	294	Template Data Sets panel.....	408
Field Information panel.....	300	Template Entry panel.....	409
Field Selection Criteria panel.....	301	Template Member Selection panel.....	411
IMS™ Catalog Specification panel	306	Template Specification panel.....	412
IMS™ Subsystem Specification panel	308	Template Update : New Database Segments panel.....	417
IMS data panel.....	309	Template Update Utility panel.....	418
Initial Load Options panel.....	317	Template/View/Criteria Set Menu panel.....	423
Initialize Entry panel.....	318	Utility Menu panel.....	425
Insert Root Segment panel.....	321	View Entry panel.....	425
Insert Segment panel.....	323	View Member Selection panel.....	428
Insert Segment Layout Selection panel.....	328	View Update Utility panel.....	429
Insert Segment Selection panel.....	329	Chapter 11. Commands.....	434
ISPF Settings panel.....	330	ABOUT primary command.....	434
JCL Submission panel.....	331	AUTOSAVE primary command (Edit only).....	434
Key Specification panel.....	332	BOTTOM primary command.....	435
Load Entry panel.....	335	CANCEL primary command.....	436
Load Options panel.....	341	CAPS primary command.....	437
Logical Relationship Information panel.....	342	CCSID primary command.....	438

CE (Find Error) primary command.....	438	SCOPE primary command.....	492
CHANGE primary command (Edit only).....	440	SEGMENT primary command.....	492
CHILD primary command.....	448	SEGSTATS primary command.....	493
DBD primary command.....	449	SELECT ALL primary command.....	493
DBDLIST primary command.....	450	SHOW (FLD) primary command.....	494
DELETE primary command (Edit only).....	450	SHOW (REC) primary command.....	495
DOWN primary command.....	450	SHOWCOB primary command.....	495
DPRINT primary command.....	452	SLOC primary command.....	495
EDIT primary command.....	453	SORT primary command.....	496
END primary command.....	453	SSID primary command.....	500
FE (Find Error) primary command.....	454	STR primary command.....	500
FIELD primary command.....	455	TOP primary command.....	501
FIND primary command.....	455	TPRINT primary command.....	501
FMAP primary command.....	463	TWIN primary command.....	501
FORMAT primary command.....	464	TYPE primary command.....	502
FREE primary command.....	465	UNDO primary command.....	503
GE primary command.....	466	UP primary command.....	503
HEX primary command.....	467	UPDATE primary command.....	504
HIDE primary command.....	468	VER primary command.....	505
HIERARCH primary command.....	469	VIEW primary command.....	505
HOLD primary command.....	469	VSAVE primary command.....	505
INSERT primary command (Edit only).....	470	WIDTH primary command.....	506
JUST primary command.....	471	XKEY primary command.....	507
KEY primary command.....	472	ZOOM primary command.....	508
LEFT primary command.....	473	Using primary commands.....	508
LHEX primary command.....	474	When browsing.....	508
LIBLIST primary command.....	475	When editing.....	510
LOCATE primary command.....	476	Differences between primary commands when editing and browsing.....	511
LZERO primary command.....	478	Line commands.....	511
NEXT primary command.....	479	D (Delete - Edit only).....	511
OFFSET primary command.....	480	FC, FH, FL, FS, FT (Format).....	511
ORDER primary command.....	481	I (Insert - Edit only).....	511
PARENT primary command.....	482	K (Key).....	511
PIC primary command.....	483	R (Repeat - Edit only).....	512
PREVIOUS primary command.....	483	RA (Repeat All - Edit only).....	512
QUIT primary command.....	485	V (View).....	512
RCHANGE primary command.....	485	Chapter 12. Batch reference.....	513
RDF primary command.....	485	How to use this reference chapter.....	513
REFRESH primary command.....	486	IMS Template Update (ITU).....	514
REFS primary command.....	486	IMS View Update (IVU).....	528
RELATED primary command.....	486	Criteria set update (ICU).....	533
REPEAT primary command (Edit only).....	487	Extract (IXB).....	539
RESET primary command.....	488	FMNIMSIN control statements.....	540
RFINN primary command.....	489	Database Extract Summary report.....	561
RIGHT primary command.....	490	Database Extract Statistics report.....	563
ROOT primary command.....	491	Extract data layout.....	564
SAVE primary command (Edit only).....	491	Example.....	567

Load (ILB).....	568
FM/IMS Load step description.....	569
FMNIMSIN control statements.....	570
Database Load Statistics report.....	575
Database Load Summary report.....	576
Database Load Diagnostic report.....	578
Example.....	578
Print (IPR).....	579
FMNIMSIN control statements.....	580
Database Print Summary.....	586
Database Print Statistics Report.....	589
Example.....	589
Batch Edit (IEB).....	590
FMNIMSIN control statements.....	593
REXX IEB calls.....	598
Retrieval using a view.....	598
Retrieval without a view.....	611
Example.....	628
General tips for using the REXX functions defined by IEB and IBB.....	629
Use of the filerc variable.....	631
Batch Browse (IBB).....	631
FMNIMSIN control statements.....	633
REXX IBB calls.....	637
Initialize (DIB).....	639
FMNIMSIN control statements.....	642
Example.....	644
Print Audit Report (AUD).....	646
Examples.....	648
Appendix A. Messages.....	653
File Manager IMS Messages.....	653
Appendix B. Support resources.....	688
Notices.....	dclxxxix
Glossary.....	dcxciii
Index.....	699

User's Guide and Reference for IMS™ Data

This publication provides guidance and reference information for users of File Manager for z/OS IMS™ component (FM/IMS).

About this document

This document provides guidance and reference information for users of IBM® File Manager for z/OS® IMS Component.

File Manager for z/OS® contains four “*flavors*” of File Manager, for working in different environments or with different data formats:

- **IMS Component** (*described in this document*) for working with IMS™ data
- File Manager Base component for working with IAM data sets, QSAM data sets, VSAM data sets or PDS members
- **Db2 Component** for working with Db2® data
- **FM/CICS** for working with CICS® resources.

This document describes only the **IMS Component**. For more information about the File Manager Base component, Db2, and CICS components, see these documents:

- *File Manager User's Guide and Reference for IMS Data*
- *File Manager User's Guide and Reference for DB2 Data*
- *File Manager User's Guide and Reference for CICS*

In the rest of this document, the term FM/IMS refers to the File Manager IMS Component.

This document is divided into two parts:

Part 1. Working with FM/IMS

This part describes the tasks that you can undertake using FM/IMS. The emphasis is on step-by-step procedures. This part also describes the concepts of FM/IMS.

Part 2. Reference

This part provides detailed reference information for the elements of FM/IMS.

It provides a lookup reference for FM/IMS panels, commands, and functions.

These documents are:

- **Panels and fields:** Lists the FM/IMS panels, provides a definition for each field in the panel and, where applicable, lists the value ranges that are valid for each field.
- **Commands:** Lists the Primary and Line commands and gives a brief description of its syntax, usage and equivalent function.
- **Functions:** Lists the FM/IMS functions and gives a description of its syntax, usage and available parameters.

The Appendix is made up of the File Manager IMS Messages, and provides the full text explanation of all FM/IMS batch error messages.

Who should use this document

This document is for:

- Application programmers who need to test and debug programs
- Service support personnel who need to analyze and fix problems
- System administrators and system operators who need to do routine tasks such as moving large amounts of data

FM/IMS is a powerful set of utility functions for editing, browsing, extracting, loading, and maintaining data in IMS databases. It provides powerful functions in one product for use by application programmers and database administrators.

This document assumes that you are familiar with using ISPF and IMS databases.

To use FM/IMS functions in batch jobs, you must already be familiar with JCL.

To use FM/IMS functions in REXX™ procedures, you must already be familiar with the REXX programming language.

Prerequisite and related information

File Manager documentation supports the following tasks:

Planning for, installing, customizing, and maintaining File Manager

Refer first to the *File Manager Customization Guide*, which may then refer you to the File Manager Program Directory (shipped with the product tape) for some information.

Using FM/IMS

This document, the *File Manager User's Guide and Reference for IMS Data*, is a guide to using FM/IMS. When using FM/IMS under ISPF, you can also refer to the online help.

How to read syntax diagrams

The syntactical structure of commands described in this document is shown by means of syntax diagrams.

[Figure 1: Sample syntax diagram on page xii](#) shows a sample syntax diagram that includes the various notations used to indicate such things as whether:

- An item is a keyword or a variable.
- An item is required or optional.
- A choice is available.
- A default applies if you do not specify a value.
- You can repeat an item.

Figure 1. Sample syntax diagram

Figure 1. Syntax

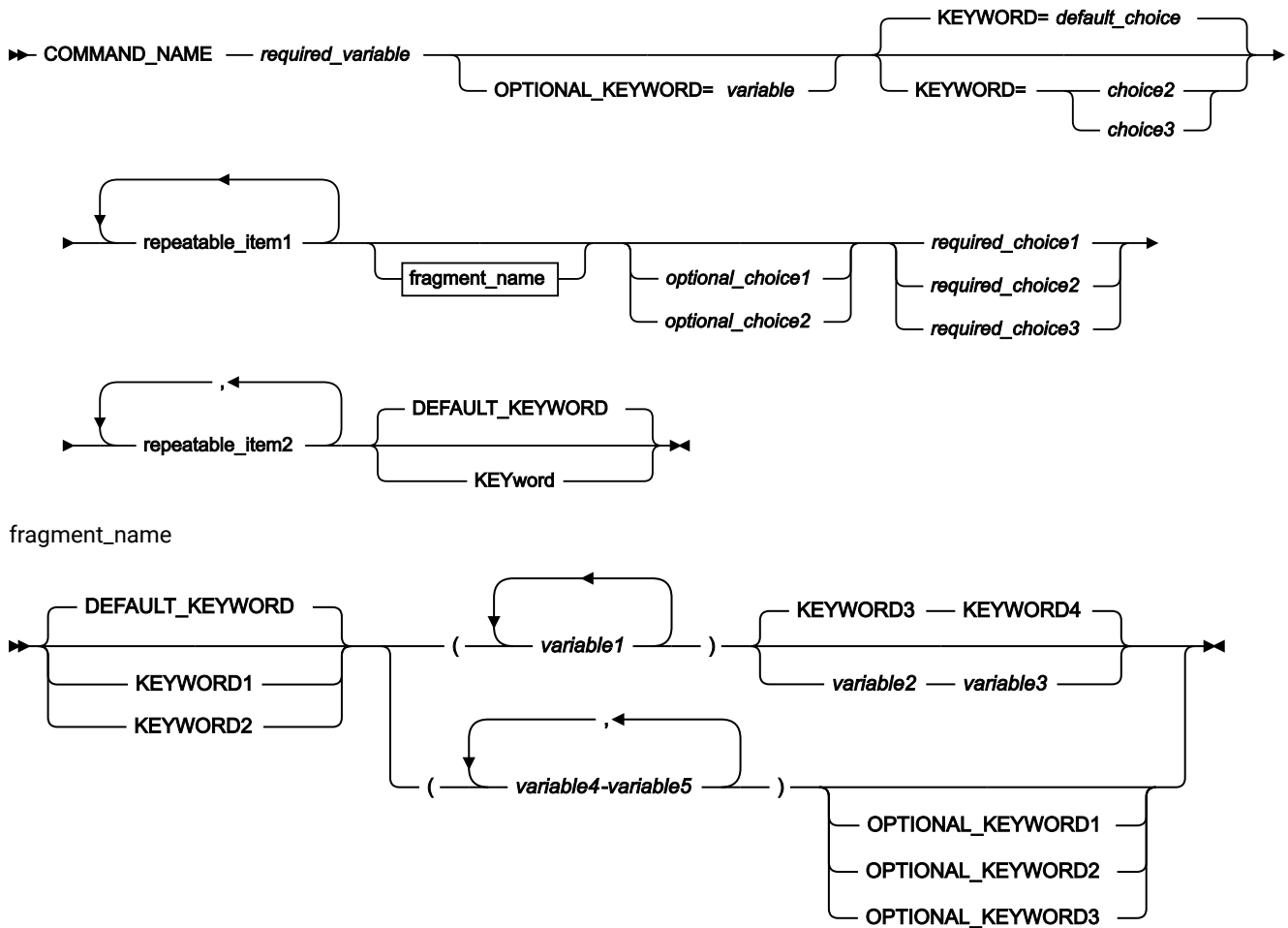

Here are some tips for reading and understanding syntax diagrams:

Order of reading

Read the syntax diagrams from left to right, from top to bottom, following the path of the line.

The \blacktriangleright — symbol indicates the beginning of a statement.

The — \blacktriangleright symbol indicates that a statement is continued on the next line.

The \blacktriangleright — symbol indicates that a statement is continued from the previous line.

The — $\blacktriangleright\blacktriangleright$ symbol indicates the end of a statement.

Keywords

Keywords appear in uppercase letters.

\blacktriangleright **COMMAND_NAME** $\blacktriangleright\blacktriangleright$

Sometimes you only need to type the first few letters of a keyword, The required part of the keyword appears in uppercase letters.

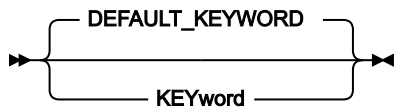

In this example, you could type "KEY", "KEYW", "KEYWO", "KEYWOR" or "KEYWORD".

The abbreviated or whole keyword you enter must be spelled exactly as shown.

Variables

Variables appear in lowercase letters. They represent user-supplied names or values.

▶▶ *required_variable* ◀◀

Required items

Required items appear on the horizontal line (the main path).

▶▶ **COMMAND_NAME** — *required_variable* ◀◀

Optional items

Optional items appear below the main path.



Choice of items

If you can choose from two or more items, they appear vertically, in a stack.

If you *must* choose one of the items, one item of the stack appears on the main path.

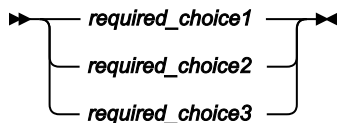

If choosing one of the items is optional, the entire stack appears below the main path.

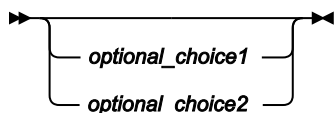

If a default value applies when you do not choose any of the items, the default value appears above the main path.

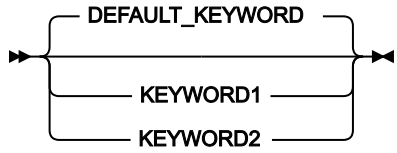

Repeatable items

An arrow returning to the left above the main line indicates an item that can be repeated.

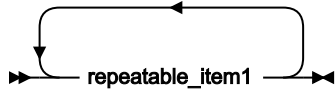

If you need to specify a separator character (such as a comma) between repeatable items, the line with the arrow returning to the left shows the separator character you must specify.

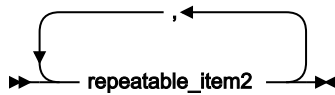

Fragments

Where it makes the syntax diagram easier to read, a section or *fragment* of the syntax is sometimes shown separately.

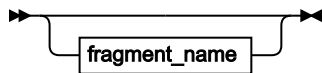

fragment_name

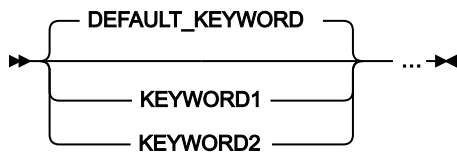

Summary of changes

November 2024, V15R1M6

This edition of the document provides information applicable to File Manager Version 15 Release 1 Modification Level 6. It contains minor changes and clarifications to the information in the previous version.

June 2024, V15R1M5

This edition of the document provides information applicable to File Manager Version 15 Release 1 Modification Level 5. It contains minor changes and clarifications to the information in the previous version.

March 2024, V15R1M4

This edition of the document provides information applicable to File Manager Version 15 Release 1 Modification Level 4. It contains minor changes and clarifications to the information in the previous version.

October 2023, V15R1M3

This edition of the document provides information applicable to File Manager Version 15 Release 1 Modification Level 3. It contains minor changes and clarifications to the information in the previous version.

June 2023, V15R1M2

This edition of the document provides information applicable to File Manager Version 15 Release 1 Modification Level 2. It contains minor changes and clarifications to the information in the previous version.

March 2023, V15R1M1

This edition of the document provides information applicable to File Manager Version 15 Release 1 Modification Level 1. It contains minor changes and clarifications to the information in the previous version.

October 2022, changes for V15R1 First Edition

This edition of the document provides information applicable to File Manager Version 15 Release 1 Modification Level 0.

Part I. Working with FM/IMS

Chapter 1. Overview

The IMS component of File Manager (FM/IMS) is an ISPF application, in which you can manipulate data stored in IMS databases. Using FM/IMS, you can:

- Display data from one or more IMS segment occurrences, and see their relationship to other segment types within the database.
- Edit and update data in IMS segment occurrences.
- Insert segment occurrences into an IMS database.
- Delete segment occurrences from an IMS database.
- Delete/Define and initialize database datasets.
- Extract a subset of IMS data to a flat file.
- Load data into IMS databases.
- Print selected data or entire databases.

For many tasks, you can use the FM/IMS elements called *templates* and *views* to define a logical view of a database, based upon field definitions from copybooks. When you associate a view with a database you can:

- Format data according to segment layouts defined in copybooks.
- Select the segment types and fields that you want to display, edit or extract.
- Change the order in which fields are displayed and adjust field headings.
- Create criteria to identify and select the data that you want to use.



Note: File Manager supports copybooks stored in a PDS(E) or a CA-Panvalet library.

FM/IMS provides you with a number of flexible ways to connect to your IMS databases. For example, with BMP mode you can connect to an online multi-user database and manipulate the data. In DLI mode, you can work with data offline as a single user or you can share the data with others. You can even access a database without creating a PSB as FM/IMS can dynamically create a PSB from the DBD, if your installation allows it.

In addition, FM/IMS provides several batch functions. FM/IMS Batch Edit (IEB) runs a REXX procedure that can insert, update, retrieve, delete or print segments and create views. FM/IMS Print (IPR) can print the entire database in one of several available display formats, or a selected subset of the database, based on a view.

Databases and segments

FM/IMS allows you to work with the IMS data organization model. IMS uses a *hierarchical* model as the basic method of storing data. In this model, the individual entity types are implemented as *segments* in a hierarchical structure.

The basic building element of a hierarchical data structure is the *parent/child* relationship between segments of data. Each occurrence (or instance) of a parent segment has associated with it 0, 1, 2, or more occurrences of a child segment. Each child segment occurrence has associated with it one, and only one, occurrence of a parent segment. The segment with no parent segment, that is, the one at the top, is called the *root segment*. Sometimes it is necessary to distinguish between a *segment type*, that is, the kind of segment; and the *segment occurrence*, that is, the particular instance of the segment type.

Figure 3. Hierarchical data structure

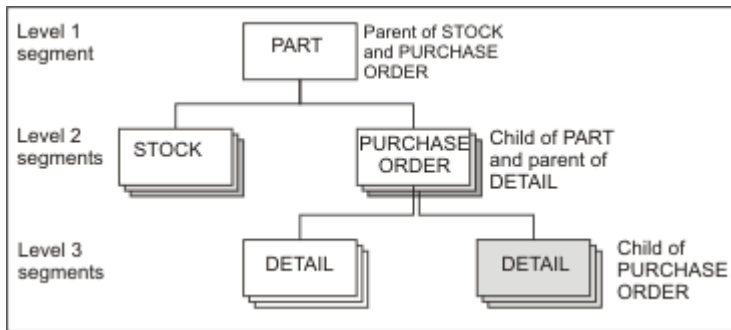

In IMS, the term “database” is commonly used to describe the implementation of one hierarchy, that is, the various segment types defined in the structure and the relationships between them. In [Figure 3: Hierarchical data structure on page 18](#), each PART segment with its dependent STOCK, ORDER, and DETAIL segments constitutes a database record. The collection of all these records for all PARTS is called a database, that is, the PARTS database.



Note: The preceding information has been adapted from the IBM Redbook, *IMS Primer*, p. 69, published in January 2000 (SG24-5352-00).

The hierarchical structure is determined by the designer of the database, based on the relationship between the segments and the access paths required. This structure is defined in a Database Definition (DBD). To access a database through FM/IMS, you must specify the data set member in which the DBD is stored. The DBD also defines the database type (Access Method) and the DDNAMES for the data sets in which the segment data is stored. The names of data sets that are allocated to these DDNAMES are stored in DFSMDA dynamic allocation members (a must in BMP mode) or defined by the user. DL/I mode access accepts a dataset name specified by the user if it is allowed at the installation.

FM/IMS supports a number of different IMS database types, using the IMS model of data organization. These types are:

- HDAM - Hierarchical Direct Access Method
- HIDAM - Hierarchical Index Direct Access Method
- HISAM - Hierarchical Index Sequential Access Method
- SHISAM - Simple Hierarchical Index Sequential Access Method
- HSAM - Hierarchical Sequential Access Method (BSAM or QSAM only)
- SHSAM - Simple Hierarchical Sequential Access Method (BSAM or QSAM)
- INDEX - Index database
- DEDB - Data Entry Database (Fast Path)
- MSDB - Main Storage Database (Fast Path)
- PHDAM - Partitioned Hierarchical Direct Access Method (HALDB)
- PHIDAM - Partitioned Hierarchical Index Direct Access Method (HALDB)
- PSINDEX - Partitioned Secondary Index (HALDB)

FM/IMS does not support the use of Generalized Sequential Access Method (GSAM) databases. A GSAM database is a sequential dataset, so it can be accessed using File Manager Base component.

Segment data can be manipulated in any way as long as it adheres to the rules defined in the DBD in use. Segments can be displayed in a variety of formats, depending on your settings and the information you provide. The display formats, CHAR, HEX and LHEX, show segment data as it is stored. TABL and SNGL formats use templates and views to display data in columns or lines for each field.

FM/IMS and hierarchical databases

FM/IMS allows you to see the hierarchical relationship of segments in an IMS database and to see each segment and its connection to its parent and child segments. FM/IMS also allows you to interactively switch between viewing parent or child segments. For example, if you chose to view the PARTS, PURCHASE ORDER and DETAILS segments in the PARTS database, FM/IMS displays the PARTS segments and each of its child segments within the hierarchy:

Figure 4. PARTS occurrences with child segments

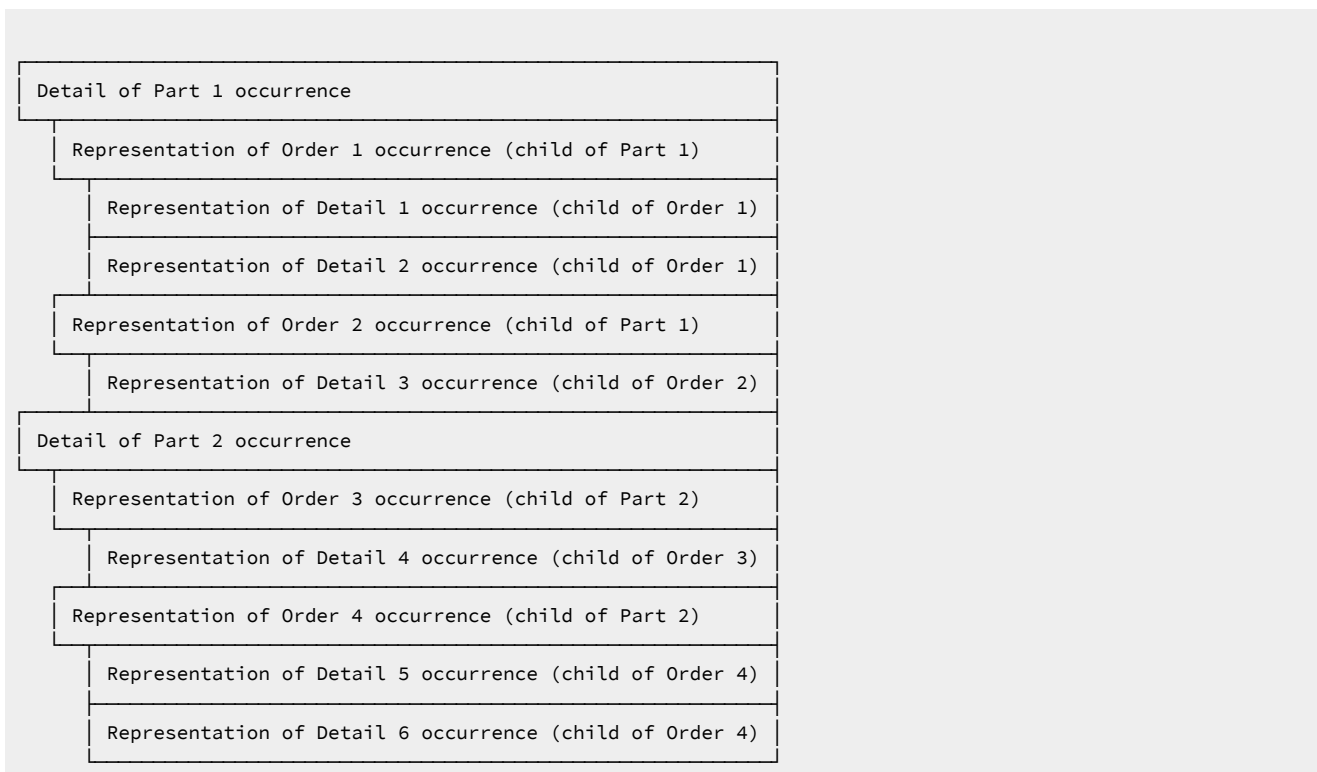

With a simple command, you can switch to viewing the DETAILS segments, seeing each one in relationship to its parents:

Figure 5. DETAILS occurrences with parent segments

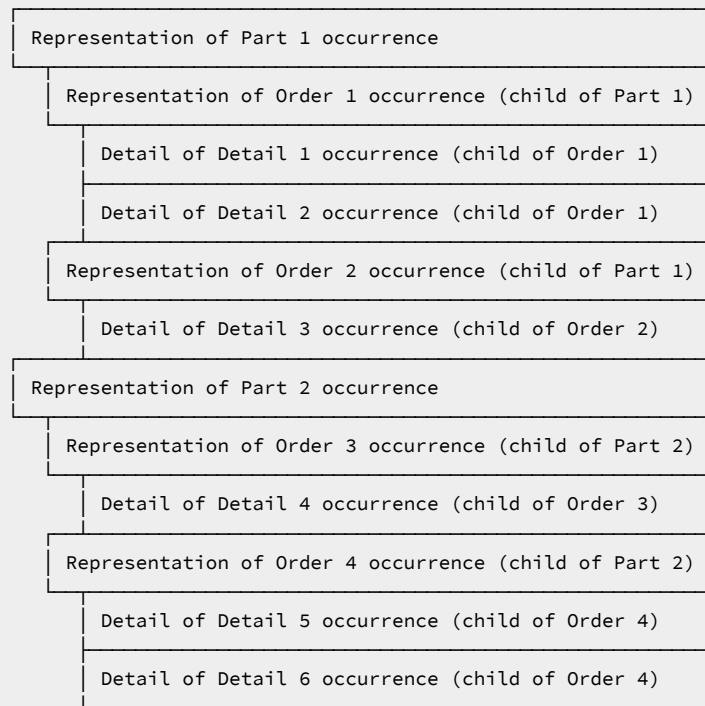

DLI and BMP modes in FM/IMS

From FM/IMS, you can connect to an IMS database in either DLI (Data Language 1) or BMP (Batch Messaging Processing) mode. In general, you would choose to use DLI mode when you are working in a development or test environment and you want to be able to manipulate your own copies of the data without impacting upon a live environment. Typically, you would use BMP mode to connect to databases in a “live” or production environment, when it is important that multiple users can access and update the data at the same time.

In DLI mode, FM/IMS allocates the IMS database data sets in the TSO address space. The databases can only be updated by a single user unless you use the Internal Resource Lock Manager (IRLM). By using IRLM to govern your access in DLI mode, several users can update the same databases. To enable multi-user access in DLI mode, you must make sure that your databases are allocated with DISP=SHR.

In BMP mode, the database data sets are allocated in the IMS Control Region, allowing multiple users to update the same databases.

The installation process for FM/IMS provides default IMS control information for each IMS subsystem that the FM/IMS administrator allows FM/IMS functions to access. For much of the control information, different values can be specified for BMP and DLI mode. The installation process also allows the FM/IMS administrator to specify whether you, the user, are allowed to override each default value that is specified. So, for example:

- For a production subsystem, you may not be able to override any of the IMS subsystem settings.
- For a test subsystem, you may be able to override the IMS settings used when the function is run in DLI mode, but not the IMS settings used when the function is run in BMP mode.
- For a development subsystem, you may be able to override all of the IMS subsystem settings.

Dynamic and static PSBs

A PSB (Program Specification Block) is a load library member that defines and controls the access to IMS databases. It is made up of one or more PCBs (Program Communication Block), each of which controls the access to an individual database.

In FM/IMS you can use pre-built PSBs, known as Static PSBs, or you can allow FM/IMS to generate the PSBs for you, known as Dynamic PSBs.

Static PSBs are usually developed by a Database Administrator and contain strict rules for access and control. Typically, they are used when connecting to a live or production environment. When using Static PSBs, FM/IMS uses the existing PSB load library member that you specify. If the PSB contains more than one PCB, then you can select the PCB you want to use.

Dynamic PSBs are generated by FM/IMS, using the information found in the DBD that you have specified. Dynamic PSBs generally allow full access to all the segments listed in the DBD and are, therefore, suitable for testing or development environments, but are often have restricted use in production environments. They can only be used when your FM/IMS system administrator has set up FM/IMS to allow their use. When using Dynamic PSBs, you can choose to access the database using a secondary index (if any are defined).

Templates and views

An FM/IMS template is a collection of information that you can use to select and format fields and segments for an IMS database. The template provides FM/IMS with a logical view of the data to be used when editing, browsing, extracting and printing.

Templates are based on COBOL, HLASM, or PL/I copybooks

The FM/IMS component, File Manager Base component and FM/Db2 component all use templates. However, these templates are not interchangeable: you cannot, for example, use a File Manager Base component template for IMS data.

Why use a template and views?

Typically, databases containing application data have a well-defined structure, where each segment in the database consists of several fields. Each field contains a discrete item of data, such as a customer's name, a product code, or any value that can be stored in a database. This data can be of various types: some fields contain character data, others contain numeric data encoded in binary format or packed decimal format.

To work efficiently with these databases, you need tools that recognize segment layouts, allowing you to selectively process individual fields.

For example, if you use the IMS test program DFSDDLT0 to print an application database, then each segment appears as a string of characters, with no indication that the segments consist of individual fields. Fields containing numeric data encoded in binary or packed decimal format are represented by double line hexadecimal values.

Even if you know the column boundaries of each field, maintaining application data by using a DFSDDLT0 can be difficult and tedious:

- If you want to find and replace data in a specific field, then you have to be careful not to change the field length; otherwise, you could move the boundaries of subsequent fields, and corrupt the segment structure.
- If you want to find and replace data in numeric fields where the data has been encoded in binary or packed decimal format, then you have to specify the find and replace values in that format (typically, as hexadecimal values), rather than as numeric values.
- If the database you are editing contains several segment types (each with one or several layouts), and you only want to find and replace data in one segment/layout type, then you have to exclude other segment/layout types from editing.

To illustrate, here is a segment containing a mixture of alphanumeric and numeric fields displayed in SDFS, after executing DFSDDLT0.

```

                                100003599000015970004282
SEGMENT      =(BROOME          112300666980800170C0011120C005C62)

DBPCB  LEV=01  SEG=SHIRE      RET CODE=   KFDB LEN=0020  KEY FDB=(BROOME      )
.....
    
```

In this segment, the last two bytes (X'8622') are stored in a binary numeric field. The decimal equivalent of this value is 34338. If you wanted to change this value to 12151, you need to:

1. Display the hexadecimal values of the segment data.
2. Determine the column positions occupied by the field.
3. Convert the numeric value 12151 into its hexadecimal equivalent (X'2F77').
4. Overtyping the old hexadecimal value of the numeric field (X'8622') with the new value, or use a CHANGE command with the old and new hexadecimal values.

Here is the same segment displayed in SNGL format.

Figure 6. Database segment

```

Process  Options  Help
-----
FM/IMS          Browse : IMS Database DJ1E
                SHOW SUP ON  Scope DB  Format SNGL
Segment SHIRE   Level: 1
Concatenated key value: DENMARK

                Top Line is 1   of 9

Current 01: SHIRE-TOWN
Ref Field      Typ  Len  Data
 3 SHIRE-NAME   AN   20  K DENMARK
 4 SHIRE-TYPE   AN    1   1
 5 SHIRE-CODE1  ZD    3  305
 6 SHIRE-CODE2  ZD    5  244
 7 SHIRE-YEAR   BI    2  6280
 8 SHIRE-BRICK  PD    8  606363187610
 9 SHIRE-WOODEN PD    8  2034233224332
10 SHIRE-SCHOOL PD    4  3020312
11 SHIRE-GOLF   BI    2  12608
*** End of record ***

Command ==>
F1=Help      F2=Format   F3=Exit     F4=CRetriev F5=RFind    F6=RChange
F7=Up        F8=Down     F9=Swap     F10=Previous F11=Next    F12=Cancel

```

In FM/IMS, to change the numeric value of the SHIRE-GOLF binary numeric field from 12608 to 12151, you can overwrite the numeric value, or enter the command:

```
CHANGE 12608 12151 #11
```

What can you do with views?

When you apply a view to a database:

- **Format and edit fields**

You can display, print and edit fields according to their data types. For example, binary numeric fields are displayed as their true numeric values, not as the character representation of their binary value.

When editing, you can overwrite or use CHANGE commands to replace formatted numeric field values with different numeric values; FM/IMS stores the underlying binary value in the segment.

You can select which fields are displayed or printed. When browsing or editing data, you can limit the scope of commands (such as FIND and CHANGE) to particular fields.

You can change the order in which fields are displayed or printed.

For numeric fields, you can display or suppress leading zeros (so that, for example, 00057 is displayed and printed as 57); the default is to suppress leading zeros.

- **Identify layout types and select segments with those types**

In addition to selecting segment types, you can select segments using two levels of criteria:

- Layout identification criteria

The unique characteristics of a segment layout are identified within your template, enabling File Manager to distinguish it from other layouts in the same segment. In your view, you can select which segment occurrences you want to use, based on their layout type.

- Field selection criteria

After a segment occurrence has been identified as belonging to a particular layout, you can specify selection criteria for field values, to narrow down which occurrence of a particular layout type you want to use.

Where can you use views?

You can use views to browse, edit, extract and print data. The table below lists the dialogs (when using File Manager under ISPF) and batch functions where you can use templates:

Task	Dialog	Batch function
Browse data	Browse (option 1)	IBB
Edit data	Edit (option 2)	IEB
Print data	Print (option 3.5)	IPR
Extract	Extract (option 3.3)	

With any of the above dialogs or batch functions, you can supply an existing view or create a view on the fly from a template.

Working with HALDB partitions and DEDB areas

FM/IMS can process data stored in HALDBs (High Availability Large Databases) and DEDBs (Fast Path Data Entry Databases). Data in these databases is stored in partitions (HALDB) and areas (DEDB).

A HALDB partition or a DEDB area might not be available, for example, when it is stopped so that IMS utilities can be run, or when there are errors associated with the partition or area. However, this does not prevent FM/IMS from processing data in partitions or areas that are available.

If FM/IMS encounters an unavailable partition or area while you are browsing or editing, an *“unavailable partition/area line”* is displayed to show that data is unavailable. If the data subsequently becomes available, FM/IMS replaces the unavailable partition/area line with the data. If you are doing a global edit change (such as a CHANGE ALL), then the change is not applied to data that is not available.

If FM/IMS encounters an unavailable partition or area during the execution of a load or extract job, FM/IMS continues processing the database, loading from or extracting to available partitions or areas. The job completes with a return code of 4, and the report from the job indicates that data was unavailable while processing the database. If you wish to load or extract the complete database, you have to take steps to make all data available, and then rerun the load or extract.

If FM/IMS encounters an unavailable partition or area during the execution of a batch print job, FM/IMS prints an unavailable partition/area line and continues processing the database. The job completes with a return code of 4, to indicate that data was unavailable while processing the database.

The user specifies the action required when FM/IMS encounters an unavailable HALDB partition or DEDB area while running an IMS batch (IEB) job. If FM/IMS encounters an unavailable HALDB partition or DEDB area while running the DELIMS, GETIMS, ISRTIMS or REPLIMS functions, the function receives a return code of 8 and the ISPF variable FMSTATUS has an IMS status code of:

- FH for an unavailable DEDB area.
- BA for an unavailable HALDB partition.

Chapter 2. System requirements for File Manager for IMS™

FM/IMS supports:

- IMS™ Version 13
- IMS™ Version 14
- IMS™ Version 15
- IMS™ Version 15.1.0 or higher

Chapter 3. Getting started

This chapter is designed to help the new user to familiarize themselves with the user interface and general methods for working within FM/IMS panels.

The major tasks described in this chapter are:

- [Starting and exiting FM/IMS on page 27](#)
- [Using the FM/IMS interface on page 30](#)
- [Getting help on page 37](#)
- [Setting processing options on page 40](#)

Starting and exiting FM/IMS

FM/IMS is an ISPF application and is usually run from within an ISPF session. Exiting from FM/IMS returns you to your ISPF session.

The tasks described in this section are:

- [Starting FM/IMS on page 27](#)
- [Checking your FM/IMS version on page 28](#)
- [Exiting from FM/IMS on page 30](#)

Starting FM/IMS

How you start FM/IMS depends on how it is installed on your system. Typically, FM/IMS is installed as an option on one of your ISPF menus, for example:

Figure 7. z/OS Primary Option menu showing FM/IMS option

```
Menu Utilities Compilers Options Status Help
-----
z/OS Primary Option Menu
0 Settings Terminal and user parameters User ID . : FMUSER
1 View Display source data or listings Time . . : 13:50
2 Edit Create or change source data Terminal . : 3278
3 Utilities Perform utility functions Screen . . : 1
4 Foreground Interactive language processing Language . : ENGLISH
5 Batch Submit job for language processing Appl ID . : ISR
6 Command Enter TSO or Workstation commands TSO logon : ISPF
7 Dialog Test Perform dialog testing TSO prefix: FMUSER
9 IBM Products IBM program development products System ID : FMD2
10 SCLM SW Configuration Library Manager MVS acct. : USER
11 Workplace ISPF Object/Action Workplace Release . : ISPF 5.0
12 z/OS System z/OS system programmer applications
13 z/OS User z/OS user applications
14 IBMGSA IBMGSA Development and Service Apps
S SDSF Spool Display and Search Facility
F File Manager File Manager z/OS
FI FM/IMS File Manager/IMS
Option ==> FI
-----
F1=Help F2=Split F3=Exit F7=Backward F8=Forward F9=Swap
F10=Actions F12=Cancel
```

To start FM/IMS:

1. Select the FM/IMS option from the z/OS Primary Option Menu.

When you start FM/IMS, the Primary Option Menu is shown, with a summary of the current version information displayed in a pop-up message box.

Figure 8. Primary Option menu with version information

```

Process  Options  Help
-----
FM/IMS                                Primary Option Menu

0  Settings      Set processing options           User ID . . : FMUSER
1  Browse        Browse data                     System ID  : FMD2
2  Edit          Edit data                          Appl ID   : FMN1
3  Utilities     Perform utility functions          Version   : 15.1.6
4  Templates    Template/view/criteria set utilities Terminal. : 3278
X  Exit          Terminate FM/IMS                   Screen. . : 1
                                           Date. . . : 2024/01/01
                                           Time. . . : 11:24

| IBM* File Manager for z/OS Version Version 15 Release 1 Modification
| 6
| 5755-A03 IMS Component
| Licensed Materials - Property of IBM* and HCL**
| (C) Copyright IBM Corp. 2001, 2017 - All Rights Reserved.
| (C) Copyright HCL Technologies Ltd. 2017, 2024 - All Rights Reserved.
| * Trademark of International Business Machines
| ** Trademark of HCL Technologies Limited

Command ==>
F1=Help      F2=Split    F3=Exit     F4=CRetriev F7=Backward F8=Forward
F9=Swap      F10=Actions F12=Cancel
    
```

2. Press Enter to close the version window.

If FM/IMS is not an option on one of your ISPF menus, ask your system administrator to explain the startup process used at your site.

Related topics

[Primary Option menu on page 346](#)

Checking your FM/IMS version

To display the full version information for FM/IMS, enter **VER** on the Command line of any panel. The current FM/IMS version number and the PTF number for each File Manager component is displayed in a window. The window also indicates whether or not FM/IMS is APF-authorized.

When logging a problem, please supply your support team with the information provided by the **VER** command. This helps them in diagnosing and resolving your issue.

Figure 9. Primary Option menu with PTF information

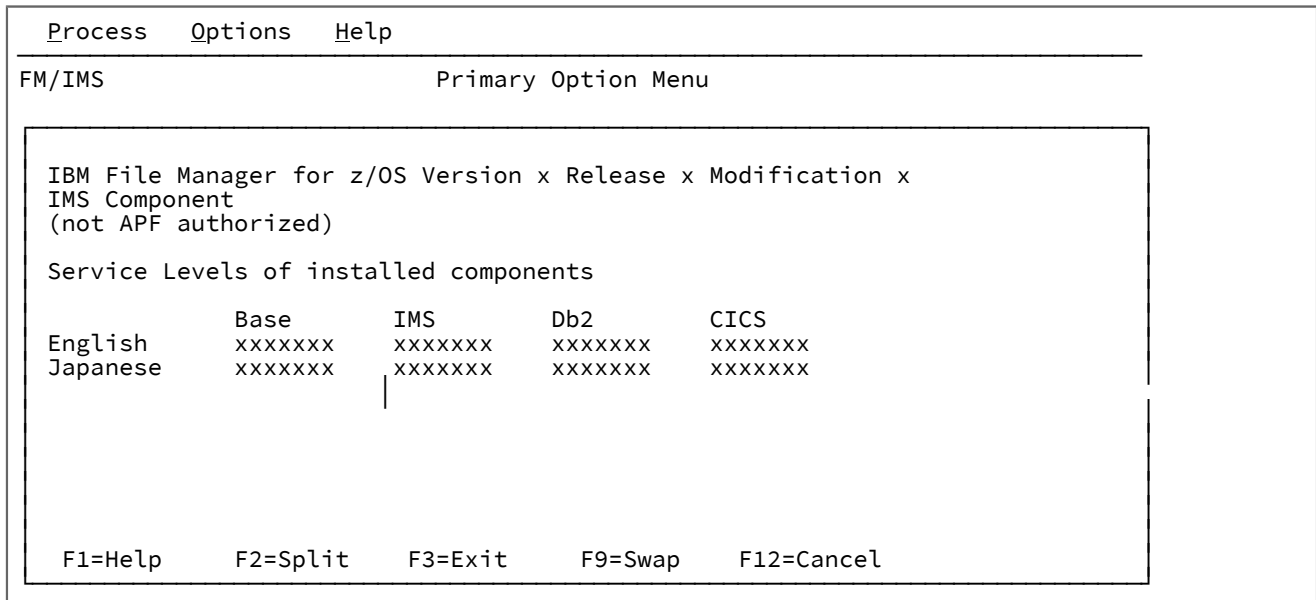

Related topics

[ABOUT primary command on page 434](#)

[VER primary command on page 505](#)

What if the VER command won't work for you?

If **VER** already exists in your ISPF command table, the VER command won't work in FM/IMS. Instead you can use a synonym called LVL. The LVL command can be issued in the same way as the VER command.

An alternative way to display version information is to select **Help > 6. About** from the Action Bar on any panel or enter the ABOUT primary command.

The current FM/IMS version number and the PTF number of the File Manager IMS component are displayed. The window also shows the copyright information and any notes that are shipped with the product.

Related topics

[VER primary command on page 505](#)

Checking which COBOL compiler you're using

FM/IMS uses the currently loaded COBOL compiler to create a template from COBOL copybooks.

To display details about the current COBOL compiler, enter SHOWCOB on the Command line of any panel. FM/IMS displays details about the current COBOL compiler in a window.

Related topics

[SHOWCOB primary command on page 495](#)

Exiting from FM/IMS

You can exit from File Manager from the Primary Option menu in any of the following ways:

- Press the Exit function key (F3)
- Enter X (or EXIT or END) on the Command line.
- Select **Process > Exit from File Manager** from the Action Bar.

To exit the application from any panel within FM/IMS:

- Enter `=x` on the Command line.

You can exit a panel and return to the calling panel by pressing:

- The Exit function key (F3). When you use this key to exit from a settings panel (option 0), the values you specify in the panel fields are saved in your user profile.
- In most cases, the Cancel function key (F12). When you use this key to exit from a settings panel (option 0), the values you specify in the panel fields are discarded.

Related topics

[CANCEL primary command on page 436](#)

[END primary command on page 453](#)

Using the FM/IMS interface

This section provides instructions on how to navigate to panels within FM/IMS and how to specify common panel information. It also explains how to convert values from decimal to hexadecimal (and vice versa), so that you can enter those values into panels using the appropriate format.

The FM/IMS interface is based upon the ISPF model. Tasks are performed by processing a function, together with its applicable parameters. Panels provide a user-friendly way of selecting a function and supplying the parameter information.

In many cases, FM/IMS provides a series of panels in which you must supply information and choose options before the selected function is processed. This series of panels, known as a *dialog*, starts with an Entry panel. Different subsequent panels are presented, depending upon the information supplied in each panel, and there can be many different paths through the dialog to the end result. For example, the *Edit dialog* starts with the Edit Entry panel, and then presents a number of different panels depending on:

- Whether or not you have fully qualified your data sets
- Whether you have selected to use a Static or Dynamic PSB
- Whether you have chosen to access via BMP or DL/I mode

FM/IMS finally displays the IMS Data panel (the final destination of the Edit dialog).

Most panels are processed in foreground mode. In foreground mode, the selected options are processed immediately and any results are returned to you on screen or directed to print outputs, as dictated by your settings. For all Utility functions, JCL is generated from the panel information, and then presented to you for editing. The exception to the rule is the Print Audit Trail function where the generation of JCL is optional. For the Update Template, View and Criteria utilities, the generation of JCL is also optional. You can modify this code and submit it to a processing queue. The result can then either be displayed via SDSF or routed to a printer.

The tasks described in this section are:

- [Navigating in FM/IMS on page 31](#)
- [Specifying a Library data set on page 32](#)
- [Using hexadecimal values in FM/IMS on page 36](#)

Navigating in FM/IMS

You navigate around FM/IMS panels in the same way as any other panels under ISPF. That is, you start a dialog from a menu, by entering the appropriate menu option number on the Command line. The Primary Option menu provides access to dialogs that are related to a particular function or group of functions. In some cases, an option on the Primary Option menu leads to another menu, from which you can make a further selection.

Some FM/IMS panels have more information than can be seen in a single screen, particularly when you are running in 80x24 display. When this happens, a “More?” message is displayed in the top right corner of the panel. This also happens in split screen mode when all of the data cannot be displayed in the window.

Figure 10. Example panel showing “More?” message

<u>P</u> rocess	<u>O</u> ptions	<u>H</u> elp						
FM/IMS		Set Output Data Set Allocation Options						More: +
Data set	Space Units	Primary Quantity	Secondary Quantity	Management Class	Storage Class	Data Class		Device Type
Audit Log	CYL	16	8					SYSALLDA
Print	CYL	64	32					SYSALLDA
Trace								
IMS log	TRK	20	20					SYSALLDA
Extract Keys	TRK	1	1					SYSALLDA
Logical Keys	CYL	10	10					Volume (NonSMS)
Command ==>								
F1=Help	F2=Split	F3=Exit	F4=CRetriev	F6=Reset	F7=Backward			
F8=Forward	F9=Swap	F10=Actions	F12=Cancel					

You can view the extra information by:

- Pressing the Forward function key (F8). (This scrolls down one screen at a time).
- Enter FORWARD or DOWN on the Command line (these commands scroll down one screen at a time)
- Enter BOTTOM on the Command line (this takes you to the bottom of the information)

To scroll back towards the top of the information:

- Press the Backward function key (F7) (this scrolls up one screen at a time)
- Enter BACKWARD or UP on the Command line (these commands scroll down one screen at a time)
- Enter TOP on the Command line (this takes you to the beginning of the panel)

To exit from a panel:

- Press the Exit function key (F3).
- Type END on the Command line and press Enter.
- Press the Cancel function key (F12).
- Type CANCEL on the Command line and press Enter.

Related topics

[Scrolling to see data on page 68](#)

[BOTTOM primary command on page 435](#)

[DOWN primary command on page 450](#)

[TOP primary command on page 501](#)

[UP primary command on page 503](#)

Specifying a Library data set

Many FM/IMS panels require you to specify a PDS Library that you want the function to use.

To specify a data set, follow these steps:

1. In the **Data set name** field, enter a data set name or a data set name pattern. In the case of a copybook library, this can be the name of a CA-Panvalet library. When there is a Member field immediately below the **Data set name** field, the name may include a member name or member name pattern in parentheses. If the member is specified in the **Data set name** field, the associated **Member** field must be left blank.

If you do not enclose the data set name in quotation marks, then the TSO prefix for your user ID is used as the high-level qualifier.

Data set name patterns can contain a percent sign (%) to represent a single character, and an asterisk (*) to represent any number of characters within one qualifier. Two asterisks (**) represent any number of characters within any number of qualifiers.

For performance reasons, you should qualify the data set name as much as you can.

2. If there is a **Member** field immediately below the **Data set name** field and you have not specified a member name or a member name pattern in the **Data set name** field, then enter a member name or member name pattern in the **Member** field.

A member name pattern can consist of any characters that are valid in a member name and the following two special pattern characters:

asterisk (*)

Represents any number of characters. As many asterisks as required can appear anywhere in a member name. For example, if you enter `*d*`, a list of all members in the data set whose name contains "d" is displayed.

percent sign (%)

A place-holding character representing a single character. As many percent symbols as necessary may appear anywhere in a member name. For example, if you enter `%%%`, a list of all members in the data set whose name is four characters in length is displayed.

3. Press Enter. According to what you entered in the fields, one or both of these panels may be displayed in the order they are listed:
 - Data Set Selection panel
 - Displayed when you enter a data set name pattern.
 - Displays a list of the data sets whose names match the specified data set name pattern.
 - Member Selection panel
 - Displayed when the specified data set is partitioned and you enter no member name or a member name pattern.
 - Displays either a list of all the members in the data set (when you enter no member name) or a list of the members whose names match the specified member name pattern (otherwise).
4. To select a data set from the data set selection list, enter `s` in the **Sel** field adjacent to the required data set and press Enter. You can only select one name from this list.
5. To select a member from the member selection list, enter `s` in the **Sel** field adjacent to the required member and press Enter.



Note:

- a. To reset values entered in the prefix area that have not yet been processed, use the RESET primary command.
 - b. To re-read the directory and display the current member list, use the REFRESH primary command.
6. When you are selecting members, you might find it useful to sort the list of displayed members. There are two different ways to do this:

- Use the SORT primary command to sort the member list by up to two of the displayed columns. The field names are the column headings. For example, `SORT SIZE CREATED` sorts the list of members first by size and then by the date created.
- Place the cursor on the column header of the column you want to sort and press Enter.



Note: When you sort members, the sequence (ascending or descending) for a given column is predetermined and consistent with ISPF.

Examples of data set name patterns

The examples below assume that the following data sets exist under the USERID high-level qualifier:

```
USERID.FMN.DATA
USERID.FMN.TEMPLATES
USERID.COBOL.COPY
USERID.COBOL.SOURCE
USERID.PLI.COPY
USERID.PLI.SOURCE
USERID.MISC.DATA.BACKUP
USERID.WORK
```

Example 1

Entering the following pattern (with a single asterisk):

```
'USERID.*'
```

displays the only item with exactly one level of qualifier after USERID:

```
USERID.WORK
```

Example 2

Entering the following pattern (with two asterisks):

```
'USERID.**'
```

displays the complete list of data sets with the USERID high-level qualifier.

Example 3

Entering the following pattern:

```
'USERID.*.%%%'
```

displays the following list (containing those data sets with exactly three qualifiers, whose third-level qualifier contains exactly four characters):

```
USERID.FMN.DATA
USERID.COBOL.COPY
USERID.PLI.COPY
```

Examples of specifying a member name or pattern

The examples below assume that the following members exist within the data set named, FMNUSER.DATA:

```
DATA1
FMNCDATA
FMNCTAM
FMNCTEM
FMNCTMP
NEWDATA
NEWSTUFF
TEMPA
TEMPB
```

Example 1

Entering the following details on an Entry panel:

```

:
:  Data set name . . . . . FMNUSER.DATA
:  Member . . . . . -----
:
:
```

displays the entire member name list:

```
DATA1
FMNCDATA
FMNCTAM
FMNCTEM
FMNCTMP
NEWDATA
NEWSTUFF
TEMPA
TEMPB
```

Example 2

Entering the following details on an Entry panel:

```

:
:  Data set name . . . . . FMNUSER.DATA
:  Member . . . . . FMNCT*
:
:
```

displays the member name list:

```
FMNCTAM
FMNCTEM
FMNCTMP
```

Example 3

Entering the following details on an Entry panel:

```

:
:  Data set name . . . . . FMNUSER.DATA (NEWDATA)
:  Member . . . . .
:
:
```

displays details for the member NEWDATA in data set FMNUSER.DATA.

Example 4

Entering the following details on an Entry panel:

```
:  
Data set name . . . . . FMNUSER.DATA(TEM*)  
Member . . . . . _____  
:
```

displays the member name list:

```
TEMPA  
TEMPB
```

Example 5

Entering the following details on an Entry panel:

```
:  
Data set name . . . . . FMNUSER.DATA(*)  
Member . . . . . _____  
:
```

displays the entire member name list:

```
DATA1  
FMNCDATA  
FMNCTAM  
FMNCTEM  
FMNCTMP  
NEWDATA  
NEWSTUFF  
TEMPA  
TEMPB
```

Using hexadecimal values in FM/IMS

In many FM/IMS panels, you can view and enter decimal values as text characters or as hexadecimal values. To help you quickly convert decimal values to hexadecimal or hexadecimal values to decimal values, FM/IMS provides two primary commands:

DX

converts a decimal value to a hexadecimal value.

XD

converts a hexadecimal value to its equivalent decimal value.

When you enter a DX or XD command, FM/IMS displays the result in a message at the bottom of your screen.

For example, if you enter the following on a File Manager/IMS command line:

```
DX 10
```

FM/IMS displays the message:

```
Dec 10 = hex 0000000A
```

To convert a hexadecimal value to its equivalent decimal value:

1. On the command line of any panel, enter `xD` followed by the hexadecimal value.

FM/IMS displays the results in a message at the bottom of your screen.

For example, if you enter the following on a File Manager/IMS command line:

```
xD 10
```

FM/IMS displays the message:

```
Hex 00000010 = dec 16
```

Getting help

FM/IMS offers two types of built-in help: context-sensitive field information, and Tutorial Help. The field help information provides a description of the current field, lists the valid values or range of values that can be entered, and gives the default field value where applicable. Tutorial Help is a context-sensitive help system that provides detailed explanations of the FM/IMS panels and the dialogs in which they are used. In addition, all error messages have an associated full text explanation, which can help you to determine the cause of a problem.

The tasks described in this section are:

- [Displaying field help information on page 37](#)
- [Accessing Tutorial Help on page 38](#)
- [Viewing expanded error messages on page 40](#)

Displaying field help information

To display the field help information:

1. Place your cursor on the field.
2. Press the Help function key (F1). The field help information is displayed in a pop-up window.

While the pop-up window is displayed:

- Press the Extended Help function key (F5) to access the Tutorial Help page for the current panel.
 - Pressing the Help function key (F1) takes you to the Help Tutorial page within the Tutorial Help system (that is, the page that describes how to use Tutorial Help).
3. When you have finished reading the message or the relevant Tutorial Help page, press the Exit function key (F3) to return to your starting panel.

For example, [Figure 11: Field help information for the PSB Type field on page 38](#) shows the message displayed when F1 is pressed when the cursor is in the **PSB Type** field on the Browse Entry Panel.

Figure 11. Field help information for the PSB Type field

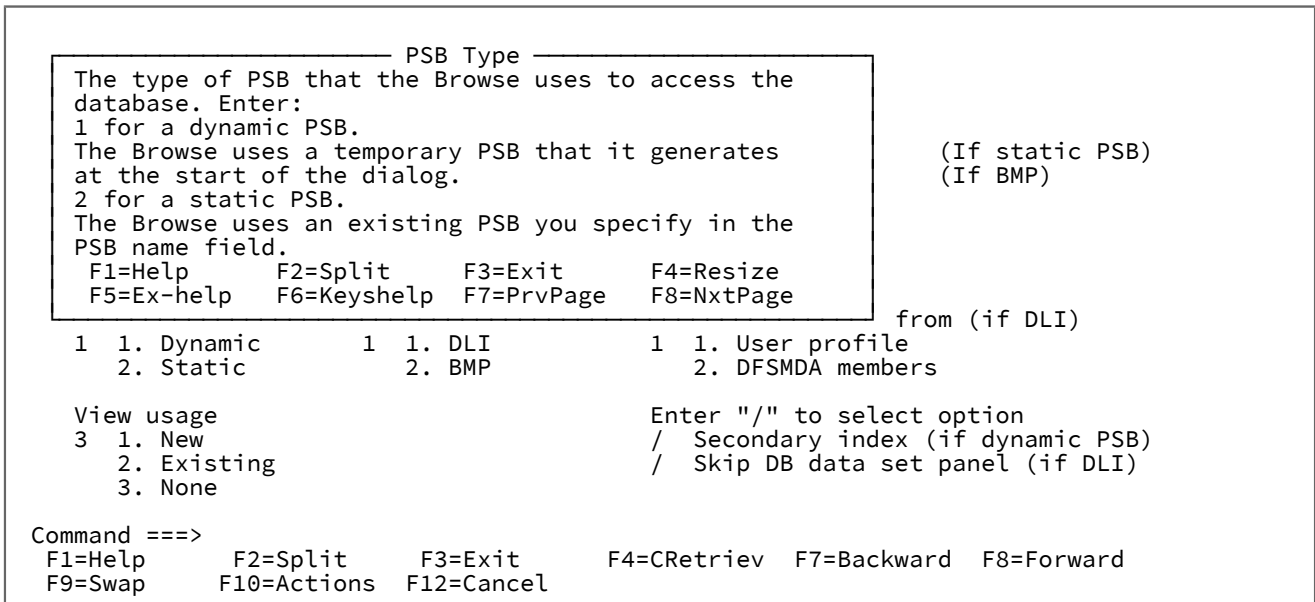

Accessing Tutorial Help

The Tutorial Help system is both context-sensitive and structurally organized. You can get directly to the information you need, using the context-sensitive access method or you can enter the Help system at a specific location and navigate to any topic information within the structure.

To access a context-sensitive Tutorial Help page:

1. Place your cursor on the Command Line or anywhere in the panel that is outside of a field entry line.
2. Press the Help function key (F1). The Tutorial Help page associated with the current panel is displayed.

When you access the Tutorial Help in this way, the first page that is displayed may be a main topic page, with a menu listing the associated sub-topics, or it may be a sub-topic page, depending upon the context from which you started.

3. Navigate through the Tutorial Help pages, to find the information you require (see below for a list of navigation commands).
4. When you have finished, press the Exit function key (F3) to return to your starting panel.

The Tutorial Help system is organized with a Table of Contents structure that is based upon the Primary Option menu. Each entry within the Table of Contents leads to a main topic with a number of associated sub-topics. In addition, there is an index that lists selected topics from the Tutorial Help, alphabetically by subject.

To choose your starting point in Tutorial Help:

1. Select the Help pull-down menu from any panel Action Bar.
2. Enter the option number for the Tutorial Help entry point that you require. These are:

1. Help for help

Displays the Help panel for the Tutorial Help system.

2. Extended help

Displays the Tutorial Help panel associated with the current FM/IMS panel (equivalent to pressing F1 from the FM/IMS panel). When on the Primary Options menu, this is the Tutorial Help Table of Contents panel.

3. Keys help

Displays help for the Function Keys that are active on the current FM/IMS panel.

4. Tutorial

Displays the Tutorial Help Table of Contents panel.

5. About

Displays the FM/IMS version and release information in a pop-up window.

6. News about FM/IMS

Displays general information about the current FM/IMS release.

To navigate Tutorial Help, enter one of the following commands in the Command line on any Tutorial page:

To back up to the previously viewed page.

BACK or B

To skip the current topic and go on to the next topic.

SKIP or S

To display a higher level list of topics.

UP or U

To display the Table of Contents.

TOC or T

To display the Tutorial Index.

INDEX or I

Alternatively, you may use the following keys whenever you are in the tutorial:

To display the next sequential page within a topic.

ENTER (Ctrl)

To display the Help Tutorial page within the Tutorial Help system (that is, the page that describes how to use Tutorial Help).

HELP (F1)

To terminate the tutorial.

END (F3)

To display a higher level list of topics (instead of typing UP).

UP (F7)

To skip to the next topic (instead of typing SKIP).

DOWN (F8)

To display the next sequential page within a topic (instead of pressing ENTER).

RIGHT (F11)

To display the previous sequential page within a topic (instead of typing BACK).

LEFT (F10)



Note: The listed keys are the default key mappings. As you can customize key mappings, they may be different on your system.

Viewing expanded error messages

If an error occurs when FM/IMS attempts to process a panel, a short text message displays in the upper right corner of the screen. To see the expanded text while this message is displayed, pressing the Help function key (F1) displays the expanded text of the error message in a box at the bottom of the screen.

Related topics

[Messages on page 653](#)

Setting processing options

Many of the processing operations performed by FM/IMS use values that can be set from within the FM/IMS application. By adjusting these values, you can customize FM/IMS.

Any value in any Settings panel can be controlled by the FM/IMS administrator through the use of the FMN1POPT macro. See the *File Manager Customization Guide* for further information.

Any field can be write protected forcing the users to use certain values. The values specified in the panels are exclusive for each subsystem (an IMSID field is provided) and the values can be different for BMP and DL/I mode in the same subsystem. All default values can be set by the administrator. If several subsystems have same default values for certain fields, these values only needs to be entered once.

You can update these values from the relevant Processing Options panel.

To access a processing option panel, use any one of the following methods:

- From the Primary Option menu:
 1. Select Option 0 (Settings). The Settings menu is displayed.
 2. Select the required option from the menu.
- From any FM/IMS panel, use the **Options** pull-down menu to select the required processing option.



Note: Editor options (Option 5 on the pull-down menu) is not accessible while inside a Browse or Edit session.

Either method results in the display of a group of options and their current values.

- To change the value of an option that is not write-protected, overwrite its current value.
- To save the options you have changed and exit the panel, press the Exit function key (F3).

Changes are saved in your ISPF user profile for future FM/IMS sessions. They remain in effect until you change the option again.

In the case of the settings on the Subsystem Settings Menu (option 6 on the Settings Menu), values are stored for each IMS subsystem you access. This means you can save different values for different subsystems.

- To exit a panel without saving changes, press the Cancel function key (F12).
- To reset all options on the panel to their installation defaults, enter `RESET` on the command line.

Related topics

[Settings Menu panel on page 397](#)

Set print processing options (option 0.1)

The print processing options control such things as the destination of your print output, the page format to use and the number of records to print.

Related topics

[Set Print Processing Options panel on page 390](#)

System settings (option 0.2)

The System Settings panel allows you to set some miscellaneous options used by the FM/IMS functions.

Related topics

[System Settings panel on page 406](#)

Set batch job card information (option 0.3)

On the Set Batch Job Card Information panel, you can specify batch job card information to be used for generating batch job submission JCL. The Batch Job Card Information panel provides a number of blank lines (**Batch Submission Job Statement Information**) where you can enter this information.

FM/IMS assumes any non-blank lines define a JCL job card and copies the information from these lines into generated JCL. If all the lines are blank, the JCL generation process generates a basic job card using information from system variables.

Related topics

[Set Batch Job Card Information panel on page 381](#)

Set language and compiler specifications (option 0.4)

The language and compiler specifications options allow you to select which compiler is used to generate templates from your copybooks.

Related topics

[Compiler Language Selection panel on page 220](#)

Compiler language selection (option 0.4.1)

The Compiler Language Selection panel allows you to specify the compiler that FM/IMS uses to build templates.

You can also specify whether you want FM/IMS to use the compiler options in the template or the compiler options specified on the compiler options panel when it updates the template.

Related topics

[Compiler Language Selection panel on page 220](#)

COBOL processing options (option 0.4.2)

The Set COBOL Processing Options panel allows you to specify:

- Selected COBOL compiler options that FM/IMS uses when it builds templates from COBOL copybooks and source.
- Up to 5 pseudo-text character strings that you want replaced in your COBOL copybooks.
- The replacement pseudo-text character strings for the character strings you want replaced.
- The maximum return code that FM/IMS accepts from the COBOL compiler when building a template.
- Additional compiler options which will be added via the CBL statement.

Related topics

[Set COBOL Processing Options panel on page 382](#)

HLASM processing options (option 0.4.3)

The Set HLASM Processing Options panel allows you to specify:

- Selected HLASM compiler options that FM/IMS uses when it builds templates from HLASM copybooks and source.
- The maximum return code that FM/IMS accepts from the HLASM compiler when building a template.
- Additional compiler options which will be added via the *PROCESS statement.

Related topics

[Set HLASM Processing Options panel on page 384](#)

PL/I processing options (option 0.4.4)

The Set PL/I Processing Options panel allows you to specify:

- Selected PL/I compiler options that FM/IMS uses when it builds templates from PL/I copybooks and source.
- The maximum return code that FM/IMS accepts from the PL/I compiler when building a template.
- Additional compiler options which will be added via the *PROCESS statement.

Related topics

[Set PL/I Processing Options panel on page 389](#)

Editor options (option 0.5)

The editor options control various options used to format the display of data when browsing or editing.



Note: It is not possible to access option 0.5 when you are in a Browse or Edit session. To change the behavior for the current browse or edit session, use an equivalent primary command (where available).

Related topics

[Editor Options panel on page 272](#)

IMS subsystem settings (option 0.6)

The Subsystem Settings panels allow you to view and modify your IMS subsystem settings:

- The parameters that are passed to the IMS region controller when a File Manager/IMS function is run in DLI mode (option 0.6.1).
- The names of the DFSVSAMP, RESLIB, and IMS macros data sets used by the FM/IMS functions when run in DLI mode (option 0.6.2).
- The names of the RECON and ACBLIB data sets used by the FM/IMS functions when run in DLI mode (option 0.6.3).
- Other selected options used by the FM/IMS functions when run in DLI mode (option 0.6.4).

- The parameters that are passed to the IMS region controller when a File Manager/IMS function is run in BMP mode (option 0.6.5).
- Other selected options used by the FM/IMS functions when run in BMP mode (option 0.6.6).
- The names of the PSB and DBD data sets used by the FM/IMS functions (option 0.6.7).
- The names of the Template data sets used by the FM/IMS functions (0.6.8). Values are stored for each IMS subsystem you access. This means you can save different values for different subsystems.

Temporary data set allocation options (option 0.7)

These options provide data set characteristics for temporary data sets used by FM/IMS.

Related topics

[Set Temporary Data Set Allocation Options panel on page 394](#)

Output data set allocation options (option 0.8)

These options provide data set characteristics for data sets created by FM/IMS, like Audit log, print files and extract keys file.

Related topics

[Set Output Data Set Allocation Options panel on page 386](#)

Trace options (option 0.9)

These options control the Trace output produced by FM/IMS when it is run in debug mode.

Displaying or editing DBCS characters

If you want to display or edit DBCS characters in FM/IMS and you have a DBCS capable terminal, you must ensure that your ISPF settings specify a terminal type that supports these characters.

To specify the Terminal Type in ISPF:

1. Exit from FM/IMS, returning to the z/OS Primary Option menu.

You can change the ISPF Terminal Type setting while FM/IMS is running, but the change is not implemented until the next time that FM/IMS is invoked.

2. Select option 0 from the z/OS Primary Option menu.

Figure 12. ISPF Settings panel

```

Log/List  Function keys  Colors  Environ  Workstation  Identifier  Help
-----
                                ISPF Settings
                                More:  -
- Session Manager mode          Command delimiter . ;
/ Jump from leader dots
/ Edit PRINTDS Command
/ Always show split line
- Enable EURO sign

Terminal Characteristics
Screen format  1 1. Data    2. Std    3. Max    4. Part

Terminal Type  3_
1. 3277        2. 3277A    3. 3278    4. 3278A
5. 3290A      6. 3278T    7. 3278CF  8. 3277KN
9. 3278KN    10. 3278AR  11. 3278CY  12. 3278HN
13. 3278H0    14. 3278IS  15. 3278L2  16. BE163
17. BE190     18. 3278TH  19. 3278CU  20. DEU78
21. DEU78A    22. DEU90A  23. SW116   24. SW131
25. SW500

Command ==> -----
F1=Help      F2=Split    F3=Exit     F7=Backward F8=Forward  F9=Swap
F10=Actions  F12=Cancel

```

3. Select either 3277KN or 3278KN from the list of Terminal Types.



Tip: You may need to scroll down this panel to find the list of Terminal Types.

4. Press the Exit function key (F3) to save your selection and return to the z/OS Primary Option menu.
5. Restart FM/IMS.

National characters

File Manager uses the national characters shown in [Table 1: National characters on page 45](#).

Table 1. National characters

Character	Hexadecimal value	Displayed as, in code pages 37 and 500
Dollar sign	X'5B'	\$
Hash sign	X'7B'	#
At sign	X'7C'	@



Note:

1. The dollar sign (\$) and the hash sign (#) have special syntactical meaning in File Manager syntax.
2. In countries using code pages other than 37 and 500:

Table 1. National characters

(continued)

Character	Hexadecimal value	Displayed as, in code pages 37 and 500
		<p>a. The above characters as represented on terminal keyboards might generate a different hexadecimal representation, and this might cause an error or unwanted results. For example, in some countries the \$ character might generate a X'4A'.</p> <p>b. The above hexadecimal values might display as different characters to those shown.</p>

When you enter File Manager commands in batch or on-line, use the keyboard characters that correspond to the hexadecimal values.

Chapter 4. Viewing your databases

To view data stored in an IMS database, you can use the Browse option, which allows you to view the data without being able to change it, or you can use the Edit option which allows you to view and change your data. Before you can view the data, you must make a number of decisions about how you want to access the database and how you would like to view the data. Once you have displayed your data, you can manipulate your view to best suit your needs.

The major tasks described in this chapter are:

- [Accessing your databases on page 47](#)
- [Determining how to display your data on page 58](#)
- [Manipulating your view of the data on page 61](#)

These instructions are given within the context of a Browse dialog. However, unless otherwise specified, you can also perform these actions within an Edit dialog.

Accessing your databases

You can access an IMS database in one of two ways: either under the control of an IMS Control Region (BMP mode); or as a batch process executing as its own IMS subsystem (DLI mode). For both modes, you have the option of using a dynamic PSB or a static PSB.

The concepts and tasks described in this section are:

- [About the different access modes on page 47](#)
- [Accessing in BMP mode using a Static PSB on page 49](#)
- [Accessing in BMP mode using a Dynamic PSB on page 51](#)
- [Accessing in DLI mode using a Static PSB on page 52](#)
- [Accessing in DLI mode using a Dynamic PSB on page 55](#)

About the different access modes

When your database is allocated to an online system, you access it in BMP mode. BMP mode provides strict controls that are suited to live production environments. For example, you can only access those database data sets that have been defined for your IMS subsystem. Any changes that you make are logged in the IMS online log data set and IMS controls such things as multi-user access to the segment data and automatic backouts if needed.

When running in BMP mode, you can choose to access the database using a Static PSB or a Dynamic PSB. Static PSBs provide control over what segments are available and what processing options, such as Browse or Edit, can be performed on the available segments. Typically, an end-user who updates data in a live production environment would access a database in BMP mode using a Static PSB.

You can also use Dynamic PSBs in BMP mode, if your site installation has been set up to allow this type of access. Because this combination provides full access to live data, some sites may choose not to enable it. Dynamic PSBs are generated by FM/IMS from the specified DBD and allow both Read and Update access to all segments in a database (PROCOPT=G or

GO for Browse and PROCOPT=A for Edit). This type of access might be required by a Database Administrator who wants to make critical changes to live data, without having to bring the entire IMS subsystem offline.



Note: To allow the use of Dynamic PSBs in BMP mode, your FM/IMS administrator must have followed the setup process, as explained in the Customization Guide.

When your database is offline, you access it in DLI mode. In DLI mode, you must specify the data sets that you want to access and security is controlled at the data set level, that is, if you have access to the data sets via ISPF, you can access them via FM/IMS in DLI mode. These data sets are allocated to your TSO address space. This type of access is typically used by developers. While DLI mode usually provides single user access, you can share databases with other users by working with the IRLM option turned on (depending on your IMS subsystems definitions).

In DLI mode, you can use a Static PSB or a dynamic PSB. Static PSBs provide the same measure of control in DLI mode as that given in BMP mode. Using a Dynamic PSB in DLI mode requires no special set up at installation time and allows you to have full access to the data sets you have specified.



Note: You can also control the type of read provided in the Browse, Extract, Print, and Batch Browse functions by changing the PROCOPT settings (PROCOPT=G for normal read, PROCOPT=GO for read without integrity) on the DLI Mode Options panel (option 0.6.4) or BMP Mode Options panel (option 0.6.6).

A setting of G means that database read locks are set and released as you read the data, ensuring that you are always reading the complete updated database record.

A setting of GO means that no locks are set, which can result in internally inconsistent segments (with different parts of the segment updated by two different units of work).

Related topics

[DLI and BMP modes in FM/IMS on page 20](#)

[Dynamic and static PSBs on page 21](#)

[Edit Entry panel on page 266](#)

Deciding if you will use a view

Having determined the mode for accessing your database, the next step is to decide if you will use a view or not when displaying the data. Your databases can be displayed without using a view, or with a view applied. You have the option of using either a temporary view that the function creates from a template for the database, or an existing view.

Data displayed without a view appears as unformatted text, with no indication that the segments consist of individual fields. Fields containing numeric data encoded in binary or packed decimal format are represented by double line hexadecimal values.

Data displayed with a view applied appears as formatted text, in the fields defined by the template. The view defines which fields from the template are displayed, the order in which the fields are shown and, if field selection criteria has been defined, which segments are displayed.

Accessing in BMP mode using a Static PSB

Before you can access a database in BMP mode using a Static PSB, your PSB and DBD must have been defined in your IMS Subsystem. This is a task that is performed by your IMS System Administrator, outside of the FM/IMS environment.

1. Select either option **1 Browse** or option **2 Edit** from the Primary Option Menu. The Browse Entry Panel or Edit Entry Panel is displayed.
2. In the **Subsystem name** field, enter the ID of the IMS subsystem that the database you want to access is defined in, or if you want to select the required subsystem from a list, enter a subsystem name pattern or leave the field blank.
3. In the **PSB name** field, enter the name of the PSB that you want the function to use, or if you want to select the required PSB from a list, enter a PSB name pattern or leave the field blank. The PSB that you specify must have a PCB for the database you want to access.
4. In the **Database name** field, enter the name of the database that you want to access, or if you want to select a PCB from the list of PCBs in the PSB, enter a database name pattern or leave the field blank.
5. If the subsystem that you specified uses AGNs, enter in the **AGN name** field, an AGN name that provides you with the access your function requires and that you have authority to use or, if AGNs for the subsystem are listed in the installation options module and you want to select an AGN from the list, enter an AGN name pattern or leave the field blank. If the subsystem that you specified does not use AGNs, no AGN name should be entered.
6. If you want the function to use an existing view, enter in the **View data set name** field, the name of the data set that contains the view you want the function to use or, if you want to select the data set from a data set list, enter a data set name pattern. If the selected data set is partitioned, enter in the **View member** field the view member name, or if you want to select the required view member from a list, enter a view member name pattern or leave the field blank. If the selected data set is not partitioned, leave the view member field blank.
7. In the **PSB type** field, enter **2** to select a static PSB.
8. In the **Region type** field, enter **2** to select a BMP region.
9. In the **View usage** field:
 - Enter **1** if you want the function to use a new view. The function creates a temporary view from the template for the database.
 - Enter **2** if you want the function to use the existing view you specified in the **View data set name** and **Member** fields.
 - Enter **3** if you do not want the function to use a view.
10. Press Enter to process the data you entered. According to what you entered on the panel, one or more of these panels may be displayed in the order they are listed:
 - Subsystem Selection panel
 - Displayed when you enter no subsystem name or a subsystem name pattern.
 - Displays a list of IMS subsystems defined by the FM/IMS administrator at installation time.
 - PSB Selection panel

- Displayed when you enter no PSB name or a PSB name pattern.
- Displays a list of the PSBs in the PSB libraries for the specified subsystem.

If the PSB libraries for the subsystem are not fixed, you specify the PSB libraries for the subsystem on the PSB and DBD Data Sets panel (option 0.6.7). If the PSB libraries for the subsystem are fixed, the FM/IMS administrator specifies the PSB libraries for the subsystem at installation time.

- PCB Selection panel
 - Displayed when:
 - You enter no database name and there is more than one database PCB in the specified PSB, or
 - You enter a database name and there is more than one PCB for the database in the PSB, or
 - You enter a database name pattern and the PSB has PCBs for databases with names that match the pattern.
 - Displays a list of the PCBs in the specified PSB.
- AGN Selection panel
 - Displayed when the specified subsystem uses AGNs and has some of them listed in the FM/IMS installation options module and you enter no AGN name or an AGN name pattern.
 - Displays the AGNs for the subsystem that are listed in the FM/IMS installation options module.
- View Data Set Selection panel
 - Displayed when you enter a **View data set name** pattern and select "Existing" for **View usage**.
 - Displays a list of the data sets whose names match the specified **View data set name** pattern.
- View Member Selection panel
 - Displayed when the specified View data set is partitioned, you enter no View member name or a View member name pattern and you select "Existing" for **View usage**.
 - Displays a list of the members in the View data set.

On each selection panel that is displayed, enter **s** in the **Cmd** field adjacent to the item you want to select and press Enter.

11. Once you have completed these steps, the Database Positioning panel is displayed. You complete the access process by setting up the way you display the segment data. This process is described in [Determining how to display your data on page 58](#).

Related topics

[Browse Entry panel on page 214](#)

[Data Set Selection panel on page 233](#)

[Edit Entry panel on page 266](#)

[PCB Selection panel on page 343](#)

[PSB Selection panel on page 361](#)

[Subsystem Selection panel on page 401](#)

[System Settings panel on page 406](#)

Accessing in BMP mode using a Dynamic PSB

Before you can access a database in BMP mode using a Dynamic PSB, your FM/IMS system must have been set up to allow this type of access. This is a task that is performed by your FM/IMS administrator, during the installation and customization of the FM/IMS environment.

1. Select either option **1 Browse** or option **2 Edit** from the Primary Option Menu. The Browse Entry Panel or Edit Entry Panel is displayed.
2. In the **Subsystem name** field, enter the ID of the IMS subsystem that the database you want to access is defined in, or if you want to select the required subsystem from a list, enter a subsystem name pattern or leave the field blank.
3. In the **Database name** field, enter the name of the database that you want to access, or if you want to select a database from a list of DBDs, enter a database name pattern or leave the field blank.
4. If the subsystem that you specified uses AGNs, enter in the **AGN name** field, an AGN name that will provide you with the access the function requires and that you have authority to use or, if AGNs for the subsystem are listed in the installation options module and you want to select an AGN from the list, enter an AGN name pattern or leave the field blank. If the subsystem that you specified does not use AGNs, no AGN name should be entered.
5. If you want the function to use an existing view, enter in the **View data set name** field, the name of the data set that contains the view you want the function to use or, if you want to select the data set from a data set list, enter a data set name pattern. If the selected data set is partitioned, enter in the **View Member** field the view member name, or if you want to select the required view member from a list, enter a view member name pattern or leave the field blank. If the selected data set is not partitioned, leave the **View member** field blank.
6. In the **PSB type** field, enter **1** to select a dynamic PSB.
7. In the **Region type** field, enter **2** to select a BMP region.
8. In the **View usage** field:
 - Enter **1** if you want the function to use a new view. The function creates a temporary view from the template for the database.
 - Enter **2** if you want the function to use the existing view you specified in the **View data set name** and **Member** fields.
 - Enter **3** if you do not want the function to use a view.
9. If the database you selected has secondary indexes and you want to access the database by means of a secondary index, enter "/" in the **Secondary index** field.
10. Press Enter to process the data you entered. According to what you entered on the panel, one or more of these panels may be displayed in the order they are listed:
 - Subsystem Selection panel
 - Displayed when you enter no subsystem name or a subsystem name pattern.
 - Displays a list of IMS subsystems defined by the FM/IMS administrator at installation time.
 - Database Selection panel
 - Displayed when you enter no database name or a database name pattern.
 - Displays a list of the DBDs in the DBD libraries for the specified subsystem.

If the DBD libraries for the subsystem are not fixed, you specify the DBD libraries for the subsystem on the PSB and DBD Data Sets panel (option 0.6.7). If the DBD libraries for the subsystem are fixed, the FM/IMS administrator specifies the DBD libraries for the subsystem at installation time.

- AGN Selection panel
 - Displayed when the specified subsystem uses AGNs and has some of them listed in the FM/IMS installation options module and you enter no AGN name or an AGN name pattern.
 - Displays the AGNs for the subsystem that are listed in the FM/IMS installation options module.
- View Data Set Selection panel
 - Displayed when you enter a **View data set name** pattern and select "Existing" for **View usage**.
 - Displays a list of the data sets whose names match the specified **View data set name** pattern.
- View Member Selection panel
 - Displayed when the specified View data set is partitioned, you enter no **View member name** or a **View member name** pattern and you select "Existing" for **View usage**.
 - Displays a list of the members in the View data set.
- Secondary Index Selection panel
 - Displayed when you select the Secondary index option and the database that you selected has more than one secondary index.
 - Displays all the secondary indexes for the selected database.

On each selection panel that is displayed, enter **s** in the **Cmd** field adjacent to the item you want to select and press Enter.

11. Once you have completed these steps, the Database Positioning panel is displayed. You complete the access process by setting up the way you display the segment data. This process is described in [Determining how to display your data on page 58](#).

Related topics

- [Browse Entry panel on page 214](#)
- [Data Set Selection panel on page 233](#)
- [Edit Entry panel on page 266](#)
- [PSB Selection panel on page 361](#)
- [Secondary Index Selection panel on page 367](#)
- [Subsystem Selection panel on page 401](#)
- [System Settings panel on page 406](#)

Accessing in DLI mode using a Static PSB

1. Select either option **1 Browse** or option **2 Edit** from the Primary Option Menu. The Browse Entry Panel or Edit Entry Panel is displayed.
2. In the **Subsystem name** field, enter the ID of the IMS subsystem that the database you want to access is defined in, or if you want to select the required subsystem from a list, enter a subsystem name pattern or leave the field blank.
3. In the **PSB name** field, enter the name of the PSB that you want the function to use, or if you want to select the required PSB from a list, enter a **PSB name** pattern or leave the field blank. The PSB that you specify must have a PCB for the database you want to access.
4. In the **Database name** field, enter the name of the database that you want to access, or if you want to select a PCB from the list of PCBs in the PSB, enter a database name pattern or leave the field blank.

5. If you want the function to use an existing view, enter in the **View data set name** field, the name of the data set that contains the view you want the function to use or, if you want to select the data set from a data set list, enter a data set name pattern. If the selected data set is partitioned enter in the **View Member** field the view member name, or if you want to select the required view member from a list, enter a view member name pattern or leave the field blank. If the selected data set is not partitioned, leave the **View Member** field blank.
6. In the **PSB type** field, enter **2** to select a static PSB.
7. In the **Region type** field, enter **1** to select a DL/I batch processing region.
8. If you selected a database that is not a HALDB and an IMS subsystem that is not a dynamic allocation only subsystem, in the **Fetch DB dsnames from** field:
 - Enter **1** if you want the function to use the database data sets whose names were saved in your user profile
 - Enter **2** if you want the function to use the database data sets specified in the DFSMDA dynamic allocation members.
9. In the View usage field:
 - Enter **1** if you want the function to use a new view. The function creates a temporary view from the template for the database.
 - Enter **2** if you want the function to use the existing view you specified in the **View data set name** and **Member** fields.
 - Enter **3** if you do not want the function to use a view.
10. If you want to skip the display of the Database Data Set Specification or the Database Data Set Display panel, enter "/" in the **Skip DB data set panel** field.
11. Press Enter to process the data you entered. According to what you entered on the panel, one or more of these panels may be displayed in the order they are listed:
 - Subsystem Selection panel
 - Displayed when you enter no subsystem name or a subsystem name pattern.
 - Displays a list of IMS subsystems defined by the FM/IMS administrator at installation time.
 - PSB Selection panel
 - Displayed when you enter no PSB name or a PSB name pattern.
 - Displays a list of the PSBs in the PSB libraries for the specified subsystem.

If the PSB libraries for the subsystem are not fixed, you specify the PSB libraries for the subsystem on the PSB and DBD Data Sets panel (option 0.6.7). If the PSB libraries for the subsystem are fixed, the FM/IMS administrator specifies the PSB libraries for the subsystem at installation time.
 - PCB Selection panel
 - Displayed when:
 - You enter no database name and there is more than one database PCB in the specified PSB, or
 - You enter a database name and there is more than one PCB for the database in the PSB, or
 - You enter a database name pattern and the PSB has PCBs for databases with names that match the pattern.
 - Displays a list of the PCBs in the specified PSB.
 - View Data Set Selection panel
 - Displayed when you enter a **View data set name** pattern and select "Existing" for **View usage**.
 - Displays a list of the data sets whose names match the specified **View data set name** pattern.
 - View Member Selection panel

- Displayed when the specified View data set is partitioned, you enter no **View member name** or a **View member name** pattern and you select "Existing" for **View usage**.
- Displays a list of the members in the View data set.

On each selection panel that is displayed, enter **s** in the **Cmd** field adjacent to the item you want to select and press Enter.

12. If you did not select the **Skip DB data set panel** option, either the Database Data Set Display or the Database Data Set Specification panel is displayed.
 - The Database Data Set Display panel is displayed when a database that is a HALDB or a subsystem that is defined as dynamic allocation only is selected on the Browse or Edit Entry panel. This panel displays the names of the database data sets that the Edit or Browse uses. Verify that the database data sets listed are the ones you want the function to use. To confirm usage of these data sets and to proceed to the next panel in the dialog, press Enter.
 - The Database Data Set Specification panel is displayed when a database that is not a HALDB and a subsystem that is not defined as dynamic allocation only is selected on the Browse or Edit Entry panel. If you selected "User profile" for the **Fetch DB dsnames from** option, it displays the data set names saved in your user profile. If you selected DFSMDA members for the **Fetch DB dsnames from** option, it displays the data set names specified in the DFSMDA dynamic allocation members for the subsystem.

The Database Data Set Specification panel is displayed when the **Skip DB data set panel** option is not selected, but it is also displayed when the **Skip DB data set panel** option is selected and one of the following conditions is true:

- FM/IMS fails to obtain all the required data set names from either your user profile or the DFSMDA members.
- One or more of the database data sets does not exist or has an invalid data set organization.
- Allocation of one or more of the data sets fails.

If the displayed data set names are not the ones you want the function to use or no data set names are displayed, enter the data set names that you want the function to use and press Enter. To confirm usage of the displayed data set names and to proceed to the next panel in the dialog, press Enter once more.

13. Once you have completed these steps, the Database Positioning panel is displayed. You complete the access process by setting up the way you display the segment data. This process is described in [Determining how to display your data on page 58](#).

Related topics

- [Browse Entry panel on page 214](#)
- [Data Set Selection panel on page 233](#)
- [Database Data Set Specification panel on page 236](#)
- [DLI Mode Parameters panel on page 262](#)
- [Edit Entry panel on page 266](#)
- [PCB Selection panel on page 343](#)
- [PSB Selection panel on page 361](#)

[Subsystem Selection panel on page 401](#)

[System Settings panel on page 406](#)

Accessing in DLI mode using a Dynamic PSB

1. Select either option **1 Browse** or option **2 Edit** from the Primary Option Menu. The Browse Entry Panel or Edit Entry Panel is displayed.
2. In the **Subsystem name** field, enter the ID of the IMS subsystem that the database you want to access is defined in, or if you want to select the required subsystem from a list, enter a subsystem name pattern or leave the field blank.
3. In the **Database name** field, enter the name of the database that you want to access, or if you want to select a database from a list of DBDs, enter a database name pattern or leave the field blank.
4. If you want the function to use an existing view, enter in the **View data set name** field, the name of the data set that contains the view you want the function to use or, if you want to select the data set from a data set list, enter a data set name pattern. If the selected data set is partitioned enter in the **View Member** field the view member name, or if you want to select the required view member from a list, enter a view member name pattern or leave the field blank. If the selected data set is not partitioned, leave the **View Member** field blank.
5. In the **PSB type** field, enter **1** to select a dynamic PSB.
6. In the **Region type** field, enter **1** to select a DL/I batch processing region.
7. If you selected a database that is not a HALDB and an IMS subsystem that is not a dynamic allocation only subsystem, in the **Fetch DB dsnames from** field:
 - Enter **1** if you want the function to use the database data sets whose names were saved in your user profile
 - Enter **2** if you want the function to use the database data sets specified in the DFSMDA dynamic allocation members.
8. In the View usage field:
 - Enter **1** if you want the function to use a new view. The function creates a temporary view from the template for the database.
 - Enter **2** if you want the function to use the existing view you specified in the **View data set name** and **Member** fields.
 - Enter **3** if you do not want the function to use a view.
9. If you want to skip the display of the Database Data Set Specification or the Database Data Set Display panel, enter "/" in the **Skip DB data set panel** field.
10. If the database you selected has secondary indexes and you want to access the database via a secondary index, enter "/" in the **Secondary index** field.
11. Press Enter to process the data you entered. According to what you entered on the panel, one or more of these panels may be displayed in the order they are listed:
 - Subsystem Selection panel
 - Displayed when you enter no subsystem name or a subsystem name pattern.
 - Displays a list of IMS subsystems defined by the FM/IMS administrator at installation time.
 - Database Selection panel
 - Displayed when you enter no database name or a database name pattern.
 - Displays a list of the DBDs in the DBD libraries for the specified subsystem.

If the DBD libraries for the subsystem are not fixed, you specify the DBD libraries for the subsystem on the PSB and DBD Data Sets panel (option 0.6.7). If the DBD libraries for the subsystem are fixed, the FM/IMS administrator specifies the DBD libraries for the subsystem at installation time.

- View Data Set Selection panel
 - Displayed when you enter a **View data set name** pattern and select "Existing" for **View usage**.
 - Displays a list of the data sets whose names match the specified **View data set name** pattern.
- View Member Selection panel
 - Displayed when the specified View data set is partitioned, you enter no View member name or a View member name pattern and you select "Existing" for **View usage**.
 - Displays a list of the members in the View data set.
- Secondary Index Selection panel
 - Displayed when you select the **Secondary index** option and the database that you selected has more than one secondary index.
 - Displays all the secondary indexes for the selected database.

On each selection panel that is displayed, enter **s** in the **Cmd** field adjacent to the item you want to select and press Enter.

12. If you did not select the **Skip DB data set panel** option, either the Database Data Set Display or the Database Data Set Specification panel is displayed.

- The Database Data Set Display panel is displayed when a database that is a HALDB or a subsystem that is defined as dynamic allocation only is selected on the Browse or Edit Entry panel. This panel displays the names of the database data sets that the Edit or Browse will use. Verify that the database data sets listed are the ones you want the function to use. To confirm usage of these data sets and to proceed to the next panel in the dialog, press Enter
- The Database Data Set Specification panel is displayed when a database that is not a HALDB and a subsystem that is not defined as dynamic allocation only is selected on the Browse or Edit Entry panel. If you selected "User profile" for the **Fetch DB dsnames from** option, it displays the data set names saved in your user profile. If you selected "DFSMDA members" for the **Fetch DB dsnames from** option, it displays the data set names specified in the DFSMDA dynamic allocation members for the subsystem.

The Database Data Set Specification panel is displayed when the **Skip DB data set panel** option is not selected, but it is also displayed when the **Skip DB data set panel** option is selected and one of these conditions is true:

- FM/IMS fails to obtain all the required data set names from either your user profile or the DFSMDA members.
- One or more of the database data sets does not exist or has an invalid data set organization.
- Allocation of one or more of the data sets fails.

If the displayed data set names are not the ones you want the function to use or no data set names are displayed, enter the data set names that you want the function to use and press Enter. To confirm usage of the displayed data set names and to proceed to the next panel in the dialog, press Enter once more.

13. Once you have completed these steps, the Database Positioning panel is displayed. You complete the access process by setting up the way you display the segment data. This process is described in [Determining how to display your data on page 58](#).

Related topics

- [Browse Entry panel on page 214](#)
- [Data Set Selection panel on page 233](#)
- [Database Data Set Specification panel on page 236](#)
- [DLI Mode Parameters panel on page 262](#)
- [Edit Entry panel on page 266](#)
- [PSB Selection panel on page 361](#)
- [Secondary Index Selection panel on page 367](#)
- [Subsystem Selection panel on page 401](#)
- [System Settings panel on page 406](#)

Unavailable HALDB partitions and DEDB areas in browse or edit

FM/IMS allows you to edit or browse a HALDB database with unavailable partitions or a DEDB database with unavailable areas. The only time you can't edit or browse is if all the partitions or areas are unavailable. If a HALDB database has all its partitions unavailable or a DEDB database has all its areas stopped, a message is displayed on the Database Positioning panel and the user is not allowed to continue until the data becomes available.

From the Database Positioning panel or Key Specification panel if a user attempts to position on a segment that is in an unavailable HALDB partition or DEDB area, FM/IMS displays a message. The user either needs to change the key values of the segment they are attempting to position on or ensure the HALDB partition or DEDB area is made available.

If a Key value has not been specified for the Root segment on the Database Positioning Panel and FM/IMS encounters an unavailable HALDB partition or DEDB area it skips over the unavailable partitions/areas to position on the first available data after the unavailable HALDB partition or DEDB area. This is to ensure that FM/IMS has a valid starting position when processing.

Once in the edit session when FM/IMS is reading the IMS database, if it encounters an unavailable HALDB partition or DEDB area it displays an unavailable partition/area line to indicate that the data at the position indicated is unavailable.

For a HALDB database, FM/IMS displays the line:

```
===== Unavailable Partitions =====
```

to indicate unavailable data. If there are multiple consecutive unavailable partitions, only a single line indicates that the partitions are unavailable.

For a DEDB database FM/IMS displays the line:

```
===== Unavailable Area =====
```

to indicate unavailable data. FM/IMS displays an unavailable area line for each area that is unavailable.

If FM/IMS determines that the data at the position indicated by the unavailable line has become available, it then displays it.

Determining how to display your data

Once you have determined the mode for accessing your database and whether you will use a view or not, you then need to determine your starting position within the database and the initial display format to be used. Your starting position can be determined using the Database Positioning panel and, if required, this can be further refined using the Key Specification panel. Segments prior to the specified starting position are not displayed on the IMS data panel. The display format is initially set on the Database Positioning panel, but can also be changed from within the IMS data panel.

The tasks and concepts described in this section are:

- [Setting your initial display format on page 58](#)
- [How FM/IMS finds a position in the database on page 59](#)
- [Determining your starting position via the Database Positioning panel on page 59](#)
- [Determining your starting position via the Key Specification panel on page 60](#)

Setting your initial display format

A display format is a way of arranging your data within the data area of an IMS data panel, to suit your viewing or editing needs. Display formats can be applied to data that has or has not been given a logical format via a view. Data that has not been formatted with a view can be shown in CHAR, HEX or LHEX display format. Data that has been formatted with a view, can be shown in CHAR, HEX, LHEX SNGL or TABL display format.

CHAR

the data for each segment is displayed as a continuous string.

HEX

the data for each segment displayed as a continuous double line hexadecimal string with a top line where all displayable data is presented in character format.

LHEX

the data for each segment displayed as a continuous hexadecimal string.

TABL

the data for each field placed in a column.

SNGL

the data for each segment displayed on one page.

Your initial display format is specified on the Database Positioning panel. This format can be changed when displaying the data in a Browse or Edit session.

To specify your initial display format:

1. On the Database Positioning panel, enter the first letter of the format you require, in the **Format** field.
2. Press Enter. The field displays the full format name.

How FM/IMS finds a position in the database

The default starting position for any database is to display the first segment occurrence of the root segment. However, IMS databases can contain many millions of records and, for performance reasons, you might want to position the display of the data at a different segment occurrence.

To achieve this, you specify key values for a selected segment type. FM/IMS uses these key values to create SSAs (segment search arguments) for each segment level in the hierarchical path of the selected segment type. FM/IMS displays the first segment occurrence in the database that matches the key values you specify. If a view has been used and the matching segment is not displayed by that view, the starting position is the next displayable segment occurrence after the matching segment.

The *“hierarchical path”* of a segment consists of the segments at each level in the database hierarchy between that segment and the root segment. For example, for a segment at level 3, you enter key values for that segment, and for its related level 2 and 1 (root) segments.

You can specify the starting position key values on either the Database Positioning panel or the Key Specification panel. The Database Positioning panel lists segments for many hierarchical paths and you can specify key values for any segment in the list. However, when you select a segment to view, FM/IMS only uses the keys in the hierarchical path of that segment. The SSA created for any value specified uses the equals (=) operator. The Key Specification panel lists only the segments in the hierarchical path of the segment you selected. This makes it easier to see exactly which keys are used to determine the database position. The Key Specification panel also allows you to create complex SSA statements, using a variety of relational operators.

If you leave blank any key values in the hierarchical path of the selected segment type, then FM/IMS formats an unqualified SSA for that level.

Determining your starting position via the Database Positioning panel

You can determine your starting position within a database, by entering values in the segment key fields displayed on the Database Positioning panel. In this panel you specify unformatted key values, regardless of whether or not you are using a view. For binary and packed decimal numeric keys, this typically involves specifying byte values in hexadecimal ('`HEX ON`').

If you are accessing your database using a Dynamic PSB, the panel displays all of the segments listed in your DBD. If you are using a Static PSB, the panel only displays those segments that are referenced in the PSB.

To specify your starting position:

1. In the Database Positioning panel, type the `S` command in the **Cmd** field adjacent to the segment you want to view.
2. Type a value in the **Key value** field for the specified segment.

If you want to view a segment other than the root segment, enter values in the **Key value** fields for the segment you want and all segments above it in the hierarchy.

3. If the values you have entered are an exact match for values in the segment occurrences, press the Enter key. The IMS data panel is displayed, with the first displayable segment that matches your criteria positioned at the top of the data area.

If no segment matches the key values you have specified, the error message, "*Segment not found*", is displayed in the top right corner of the panel.

4. If the values you have entered are not an exact match for values in the segment occurrences, press the GE function key (F5). This converts all of the SSA statements to "greater than or equal to? (>=) operators.



Note: If the database type is HDAM, PHDAM or DEDB or a secondary index has been used, the SSA statement for the root segment uses the "equal to? (=) operator; other segments are converted to "greater than or equal to?".

The IMS data panel is displayed, with the first segment with key values that are greater than or equal to your criteria positioned at the top of the data area.

Determining your starting position via the Key Specification panel

You can determine your starting position in a database by entering values in the **Key value** fields on the Key Specification panel. This panel provides the ability to specify starting position criteria using operators other than "equal to? and "greater than or equal to?. If you have used a view, you can also specify your keys as formatted values, that is, you can specify binary and packed decimal numeric keys as their numeric values, instead of as byte values in hexadecimal (as you must do in the Database Positioning panel).

To specify your starting position:

1. In the Database Positioning panel, type the **k** command in the **Cmd** field adjacent to the segment you want to view. The Key Specification panel is displayed and shows all the segments in the hierarchical path of the selected segment.
2. Type a value in the **Key value** field for the specified segment.

If you want to view a segment other than the root segment, enter values in the **Key value** fields for the segment you want and all segments above it in the hierarchy.

3. Enter a relational operator in the relevant RO fields.
4. Press Enter. The IMS data panel is displayed, with the first segment that matches your criteria positioned at the top of the data area.

Related topics

[Key Specification panel on page 332](#)

Relational Operators

On the **Key Positioning** panel, you are able to enter the following relational operators in the **RO** field:

> or GT

Greater than

>=, => or GE

Greater than or equal to

= or EQ

Equal to

< or LT

Less than

<=, =< or LE

Less than or equal to

-=, =- or NE

Not equal to

Or you can enter:

UQ

FM/IMS uses an unqualified SSA at this level (if the **Key value** field does contain a value, it is ignored).

Manipulating your view of the data

Once your data has been displayed in the IMS data panel, you can manipulate your view of the data to focus on the segments of interest to you.

The tasks described in this section are:

- [Selecting a display format on page 61](#)
- [Zooming in to see all of a segment on page 67](#)
- [Scrolling to see data on page 68](#)
- [Locating a field or column on page 71](#)
- [How the sliding window affects scrolling and database position on page 71](#)

Selecting a display format

A display format is a way of arranging your data within the data area of an IMS data panel, to suit your browsing or editing needs. Display formats can be applied to data that has or has not been given a logical format via a template and view. Data that has not been formatted with a template can be shown in CHAR, HEX or LHEX display format (also called unformatted displays). Data that has been formatted with a template, can be shown in these formats, as well as in SNGL or TABL display formats (also called formatted displays).

In an unformatted display, bytes of segment data are displayed contiguously. Characters that cannot be displayed (for example, a packed decimal value) are represented by dots.

The segments are displayed one per line in hierarchical order, starting from the key specified on the Database Positioning or Key Specification panel. When a segment holds sufficient data, the display flows off the right of the panel. You can access the overflow by scrolling to the right.

Setting the initial display format

To specify how the IMS data panel appears at the start of a Browse or Edit session, set the **Format** option on the Editor Options panel to the required display format.

Changing the display format

You can change the display format in two ways:

1. Position your cursor in the **Format** field (upper right corner). Then overwrite the current setting with the first letter of the required format and press Enter. The panel redisplay in the selected format.
2. Enter the FC (FORMAT CHAR), FH (FORMAT HEX), FL (FORMAT LHEX), FS (FORMAT SNGL) or FT (FORMAT TABL) primary commands.



Note: When working in an Edit session, the abbreviated form of these commands can also be entered in any prefix command field.

Display formats

To determine which display format is best for your needs, review the display format descriptions below.

CHAR

Character display format. This format is suitable for viewing or editing unstructured text that is composed of characters that can be entered via the keyboard.

```

FM/IMS                               Edit : IMS Database DJ1E
  CHKPID FM000001 Autosave OFF SHOW SUP ON  Scope DB  Col 1_____ Format CHAR
Cmd Level Segment  ----+----1----+----2----+----3----+----4----+----5---
                    ****  Top of window  ****
___ 1      SHIRE   DENMARK                130500244.h....g/.....
    
```

HEX

Hexadecimal updown format, followed by a scale. This format uses separate lines; one for the characters, one for the zone digit and one for the numeric digit of each byte. Hexadecimal updown format is suitable for editing data that is composed of characters or values that cannot be entered via a keyboard or cannot be displayed. For example, you may want to use the HEX display format when editing DBCS characters or packed decimal numbers.

```

FM/IMS                               Edit : IMS Database DJ1E
  CHKPID FM000001 Autosave OFF SHOW SUP ON  Scope DB  Col 1_____ Format HEX_
    
```



```

11  2 SHIRE-GOLF      BI      2      12608
***  End of record  ***

```

This example shows the Ref (Field Reference), Typ (Type), and Len (Length) columns, and the Field column contains structure information. The display of this information is optional (the default is for it to be displayed).

To change the information displayed in SNGL mode, enter one of the following commands:

JUST

Left justifies the numeric fields

PIC

Displays or hides the Picture column

RDF

Displays or hides the Redefines information and redefined fields

REFS

Displays or hides the Field References column

SLOC

Displays or hides the Start column

STR

Displays or hides the structure information in the Field column

TYP

Displays or hides the Type and Length columns

These are toggle commands that change the display from on to off or off to on, depending on the current status of the panel. The commands only affect the current Edit or Browse session, they do not change the default settings.

To change the default settings for the IMS data panel:

1. Ensure that you are not currently in a Browse or Edit session.
2. Choose Option 0.5 **Editor options** from the Primary Option menu. or **Options -> Editor Options** from the action bar.
3. Select or clear the following options on the Editor Options panel:
 - Show redefined fields on SNGL and TABL displays
 - Show field reference numbers on SNGL displays
 - Show field type & length on SNGL displays
 - Show field picture clauses on SNGL displays
 - Show field start locations on SNGL displays
 - Show record structure on SNGL displays
 - Left justify numerics on SNGL displays
 - Show field CCSID on SNGL display.



Note: These options cannot be changed when you are in a Browse or Edit session.

TABL

Tabular format (only available when using a view). Arranges fields in columns. This format is suitable for viewing information that has been structured into fields and segments and you need to review multiple segments.

FM/IMS		Edit : IMS Database DJ1E							
Cmd	Level	Segment	CHKPID	FM000001	Autosave OFF	SHOW SUP ON	Scope DB	Format	TABL
			SHIRE-NAME		SHIRE-TYPE	SHIRE-CODE1	SHIRE-CODE2		
			#3		#4		#5		#6
			AN 1:20		AN 21:1		ZD 22:3		ZD 25:5
			<---+-----1-----+---->		-		<-->		<----+>
---	1	SHIRE	DENMARK		1		305		244

In TABL display format, only one segment type in the data set is displayed at any time. The column headings at the top of the screen reflect the fields in the current segment type. There are three lines in the headings:

```
field_heading
#n [R #n]
type start_column:length
<- ... ->
```

where:

field_heading

Defaults to the field name defined in the copybook. You can change this by editing the template or view. For details, see [Setting field attributes on page 107](#).

#n [R #n]

The field reference. You use this to refer to the field in File Manager. For example, to limit the FIND primary command to searching only certain fields, you specify the field references for those fields.

If the field redefines another field, then this is shown by the "R?" notation, followed by the field it redefines. For example, #5 [R #4] shows that this is field 5, which redefines field 4.

type

The field data type.

start_column

The field start column.

length

The field length.

<- ... ->

Ruler, indicating the size of the field.

CCSID

Displays or hides the CCSID column.

Segments of other types are “suppressed? from display: they are either hidden or represented by shadow lines.

In CHAR, HEX and LHEX formats, and for alphanumeric fields in SNGL or TABL formats, characters that cannot be displayed (“non-displayable? characters) are represented as periods.

- You can display hexadecimal values under your formatted field data by entering `HEX ON` on the Command line. For example, imagine you are viewing data in TABL display format and your display looks something like this:

```

FM/IMS                      Edit : IMS Database DJ1E
          CHKPID FM000001 Autosave OFF SHOW SUP ON  Scope DB  Format TABL
          SHIRE-NAME          SHIRE-TYPE SHIRE-CODE1 SHIRE-CODE2
Cmd Level Segment  #3          #4          #5          #6
          AN 1:20            AN 21:1      ZD 22:3      ZD 25:5
          <---+-----1-----+----> -          <-->      <---+>
___ 1      SHIRE  DENMARK      1          305          244
    
```

Issuing the command `HEX ON` displays the hexadecimal representation:

```

FM/IMS                      Edit : IMS Database DJ1E
          CHKPID FM000001 Autosave OFF SHOW SUP ON  Scope DB  Format TABL
          SHIRE-NAME          SHIRE-TYPE SHIRE-CODE1 SHIRE-CODE2
Cmd Level Segment  #3          #4          #5          #6
          AN 1:20            AN 21:1      ZD 22:3      ZD 25:5
          <---+-----1-----+----> -          <-->      <---+>
___ 1      SHIRE  DENMARK      1          305          244
          CCDDCDD4444444444444 F          FFF          FFFFF
          45541920000000000000 1          305          00244
    
```

- If a numeric field contains data that cannot be correctly interpreted as a numeric value (for example, a packed decimal field contains invalid packed values), then the field is displayed as highlighted asterisks.
- If a numeric field contains a valid numeric value, but the value is too large to fit in the width allocated to the field on the screen (as defined in the picture specification of the original copybook), then the value is truncated. The field is highlighted to indicate that truncation has occurred.

To show the entire field without truncation, you need to edit the template, and specify an output width for the field.

- If a field is a array element, then its field heading is followed by a subscript in parentheses; for example, `ELEMENT(1)`.

Related topics

[FORMAT primary command on page 464](#)

[HEX primary command on page 467](#)

[REFS primary command on page 486](#)

[TYPE primary command on page 502](#)

[Setting field attributes on page 107](#)

[Editor Options panel on page 272](#)

[Editor options \(option 0.5\) on page 43](#)

Zooming in to see all of a segment

In CHAR, HEX or LHEX display format, if you want to show all of the data in a particular segment without having to scroll left or right, you can “zoom in” on a single segment. File Manager limits the display to just that one segment and wraps the data onto the next line, as shown in [Figure 13: Zooming in on one segment \(CHAR display format\) on page 67](#).

Figure 13. Zooming in on one segment (CHAR display format)

```

FM/IMS                      Browse : IMS Database DJ1G
                               Col 1 _____ Zoom Format CHAR
Segment  SHRLSUB              Level: 2
Concatenated key value:  BROOME          BROOME
Length Byte  ----+----1----+----2----+----3----+----4----+----5----+----
           80  1  BROOME          BROOME          6725  B6501664DERBY
           61  169175812214BROOM

```

In SNGL display format, zooming in shows all fields in the segment, presented in SNGL display format, rather than only those fields selected in the view. The word **Zoom** is displayed to the left of the **Format** field, so that you can easily distinguish between “normal” SNGL and “zoomed” SNGL display.

Zooming in while in TABL display format changes your display to “zoomed” SNGL display format.

Figure 14. Zooming in on one segment (SNGL display format)

```

FM/IMS                      Edit : IMS Database DJ1E
                               Zoom Format SNGL
Segment  SHIRE                Level: 1
Concatenated key value:  DENMARK
                               Top Field is 3   of 11
Current 01: SHIRE-TOWN
Ref Field      Typ  Len  Data
 3  3 SHIRE-NAME  AN   20 K DENMARK
 4  2 SHIRE-TYPE  AN    1  1
 5  2 SHIRE-CODE1 ZD    3  305
 6  2 SHIRE-CODE2 ZD    5  244
 7  2 SHIRE-YEAR  BI    2  6280
 8  2 SHIRE-BRICK PD    8  606363187610
 9  2 SHIRE-WOODEN PD    8  2034233224332
10  2 SHIRE-SCHOOL PD    4  3020312
11  2 SHIRE-GOLF  BI    2  12608
*** End of record ***

```

To ZOOM in:

1. Type **ZOOM** on the Command line.
2. Move the cursor to the segment that you want displayed in zoom mode.
3. Press Enter.

If the cursor is not on a segment, FM/IMS zooms in on the segment that is currently the top segment displayed in the panel. If the top line is not a displayed segment, the zoom does not work.

The zoomed display automatically scrolls to the column that was shown in the **Col** field (CHAR, HEX or LEX) or the leftmost displayed field (TABL), prior to zooming.

While you are zoomed in on a segment, you can change the format to another format in the normal way, by overtyping the first character of the **Format** field.

To zoom out, re-enter the ZOOM primary command. When you zoom out, the display format returns to its setting prior to zooming in. For example, if you zoom in when the display format is CHAR, then you change to HEX, zooming out returns the display to CHAR format. Zooming out also returns to the prior column setting.

In SNGL (non-ZOOM) display format, you can navigate between segments using the Previous function key (F10) and Next function key (F11). If you zoom a segment that is currently being displayed in either SNGL or TABL display format, just that segment is displayed in SNGL format, but all fields are displayed, regardless of whether they were selected for display in the template.

If you zoom a segment that is currently being displayed in CHAR or HEX display format, only that segment is displayed on the screen, but with the entire segment displayed.



Note: ZOOM mode is used to give you a more complete view of a single segment. When you are in ZOOM mode, you cannot navigate between segments.

SEGMENT, REC and CHILD are not active in ZOOM mode.

Scrolling to see data

Most of the time, the Browse database panel is not large enough to display all of the data. To view data not currently displayed, you can scroll the data.

To scroll through your data, use the following function keys:

Use this function key

To...

Up function key (F7)

Scroll backward (up)

Down function key (F8)

Scroll forward (down)

Left function key (F10)

Scroll left

Right function key (F11)

Scroll right

The F10 and F11 function keys operate differently in SNGL display format:

Previous function key (F10)

Go to the previous segment

Next function key (F11)

Go to the next segment

You can also scroll using the primary commands UP, DOWN, LEFT, RIGHT, TOP, BOTTOM, NEXT and PREVIOUS.

In SNGL display format, there are two ways to move forward n segments:

- Enter NEXT n on the command line.
- Enter n on the command line and press Next function key (F11).



Note: If you specify a number of segments greater than the number of subsequent segments, FM/IMS displays the “**** End of data ****” indicator. You can then press the Previous function key (F10) to view the last selected segment.

In SNGL display format, there are two ways to move back n segments:

- Enter PREVIOUS n on the command line.
- Enter n on the command line and press the Previous function key (F10).



Note: If you specify a number of segments greater than the number of prior segments, the first selected segment is displayed.

Examples

```
LEFT 8
```

Scrolls 8 columns to the left.

```
LEFT
```

Scrolls left the number of columns indicated by the **Scroll** field.

```
LEFT CSR
```

If the cursor is positioned on a segment, scrolls left to the cursor position; otherwise scrolls left one page.

Related topics

[Commands on page 434](#)

Controlling how far you scroll

To control how far you scroll when you press one of the scrolling function keys, enter a scroll amount in the **Scroll** field:

Scroll amount

Scrolls...

PAGE

One screen at a time

HALF

Half a screen at a time

DATA

One line or column less than a screen at a time

CSR

To the cursor position (if the cursor is not positioned on a segment when the scroll is performed, then the scroll amount defaults to PAGE)

nnnn

A number of columns (when scrolling left or right) or a number of segments (when scrolling up or down) at a time



Note:

1. When you use the Next function key (F11) or Previous function key (F10) to scroll through segments, the only indication that a hidden segment has been skipped is that the segment number (shown in the upper right corner of the screen) skips accordingly.
2. In TABL display format, scrolling left or right moves to the start of the field that is closest to the specified scroll amount. For example, if the **Scroll** field contains CSR, then moving your cursor into a field and pressing the Right function key (F11) scrolls the display right so that the first column of the field is at the left of the screen. If you enter a numeric (*nnnn*) scroll amount, it is treated as an absolute column number (rather than a relative number), and the display scrolls to the start of the field that occupies that column.

You can temporarily override the amount in the **Scroll** field by typing a scroll amount on the command line, then pressing a scroll function key. For example, if you enter `8` on the command line, then press the Right function key (F11), File Manager scrolls right 8 columns.

Scrolling to the first or last segment or column

To scroll to the first or last segment or first or last column in the data set, type `MAX` (or `M`) on the command line, then press one of the scroll function keys. For example, typing `M` then pressing the Right function key (F11) scrolls right to the last column.

You can also scroll to the first or last segment by entering `TOP` or `BOTTOM` on the command line.

Holding fields when scrolling

You can hold fields so that they are always displayed regardless of how far you scroll.

To hold a field, enter `H` in the **Cmd** field.

In TABL display format, held fields always appear as the leftmost fields on the screen (in the order that you held them when editing the template). Held fields take priority, as far as the left-to-right display is concerned, over other fields.

In SNGL display format, held fields always appear as the topmost fields on the screen (in the order that you held them when editing the template). Held fields take priority, as far as the top-to-bottom display is concerned, over other fields.

To free a held field, enter `H` in the **Cmd** field.

For details about holding fields, see [Working with Templates and Views on page 82](#).

Locating a field or column

In all display formats except SNGL and TABL you can scroll to a particular column by typing the column number in the **Col** field, then pressing Enter.

In SNGL and TABL display format, you can use the LOCATE primary command to scroll to a particular field, using either the field reference number or the Field Name. For example:

```
LOCATE #5
```

or

```
LOCATE Age
```

When the field is an item in an array, you must specify a subscript in parentheses to identify the occurrence that you want to locate. If your field is part of a multi-dimensional array, you must specify a subscript for each dimension in the array. For example:

```
L #7(5)
```

```
L #9(2,3)
```

In TABL display format, the LOCATE command scrolls your view so that the specified field becomes the leftmost visible field. Once positioned on a field, you can use the DOWN (F8) or UP (F7) commands (function keys) to scroll through the segments and maintain the same relative field view.

In SNGL display format, the LOCATE command scrolls your view so that the specified field becomes the topmost visible field. Once positioned on a field, you can use the Next (F11) or Prev (F10) commands (function keys) to scroll through the segments and maintain the same relative field view.

Related topics

[LOCATE primary command on page 476](#)

How the sliding window affects scrolling and database position

Databases potentially are very large. FM/IMS has to work with limited memory, which means that FM/IMS cannot always hold every segment in the database within memory.

Instead, FM/IMS works with a sliding window that provides you with a look into the database. The top of this window is shown on your IMS data panel by **Top of window** line. You see this on the IMS data panel if you enter the `TOP` command. The sliding window holds approximately 500 segments, though this depends on the size of the individual segments, and the structure and size of the database records.

The top of window might also be the top of the database, but there is no immediate way of knowing this. You can position yourself at the top of the database by blanking out the root segment key value in the Database Positioning panel, or by entering the `ROOT FIRST` command. (The top of the database is determined by the selection criteria that are currently in force.)

If you are looking at data on an IMS data panel, and you keep pressing Up function key (F7), eventually you get to the Top of window line. You cannot go back beyond this line by pressing Up function key (F7).

When the sliding window has reached its maximum size, the top of window moves down (toward the bottom of the database) whenever you do anything that would add to the segments within the sliding window. So if, for example, you enter the `BOTTOM` command, or press the Down function key (F8), the top of the sliding window moves down. Other commands that might change the contents of the sliding window are `CHANGE NEXT`, `CHANGE ALL`, `RCHANGE`, `DOWN`, `FIND NEXT`, `RFIND`, `KEY`, `ROOT FIRST`, and `UP MAX`.

The `TOP` command is constrained by the sliding window.

Printing your database in batch

The Print dialog (option 5 on the Utility menu) generates a batch job that prints data from your IMS database in one of these formats:

- Character format
- Hexadecimal format.

The printed IMS segment has three lines. The first is the character representation, the second and third the hexadecimal representation of the IMS segment.

- Single format.

The printed IMS segment will have a line for each field specified in the view for the IMS segment.

- Table format

The printed IMS segment will have the fields specified in the view presented horizontally.

You can print the entire database or some subset of your database. When you only want a subset of the database printed, you can use any combination of the following to control which segment occurrences are printed:

- A file containing the root segment key values of the database records you want printed. This file is called a keys file.
- A `KEYLIST` parameter specifying the root segment key values of the database records you want printed.

You can specify full and partial key values in this list. When you specify a partial key, the database records with root key values that match the partial key are printed.

- A KEYRANGE parameter specifying a range of root segment key values for which you want the database records printed.
- A view specifying criteria that a segment occurrence must satisfy for it to be printed.

The view can also be used to specify which fields of a segment are to be printed.

Ordinarily, you would use either a keys file, or the KEYLIST parameter or the KEYRANGE parameter to specify which database records you want the function to print and you would use the view to control which specific segment occurrences are to be printed.

Creating a keys file

One way to control the database records that are printed is to use a keys file that specifies the root key values of the required database records. The following describes one way you can create the keys file:

1. Use the Browse function (option 1) to browse the root segments of the database from which you want to print data.

To get the Browse function to display only the root segments, select New for View usage on the Browse Entry panel and deselect all the dependent segments on the Database Positioning panel.

2. On the IMS data panel, scroll to the root segment of the first database record that you want printed and issue the XKEY command. FM/IMS creates a sequential keys file with the name

```
temphlq.XKEY.Dyymmdd.Thhmmss.dbname
```

where:

- temphlq is the high level qualifier specified on the Set Temporary Data Set Allocation Options panel (option 0.7)
- yymmdd is the date the data set is created
- hhmmss is the time that the data set is created
- dbname is the name of the database that you are browsing

This file contains the key value of the root segment that you scrolled to and the key values of all the root segments that are after that root segment in the database.

3. Edit the keys file to remove any root key values for database records that you don't want printed.

Generating a batch job that performs a print

To generate a batch job that prints data from an IMS data base:

1. Select option **3 Utilities** from the Primary Options Menu and then **5 Print** from the Utility Menu. The Print Entry panel is displayed.
2. Notice that many of the fields on the Print Entry panel are also on the Browse Entry panel. To fill out the fields that are common to both panels, follow one of these sets of instructions according to which Region type and PSB type you want the Print to use:
 - Steps 2 to 9 in [Accessing in BMP mode using a Static PSB on page 49](#).
 - Steps 2 to 8 in [Accessing in BMP mode using a Dynamic PSB on page 51](#).
 - Steps 2 to 10 in [Accessing in DLI mode using a Static PSB on page 52](#).
 - Steps 2 to 9 in [Accessing in DLI mode using a Dynamic PSB on page 55](#).
3. In the **Print format** field, enter the format you want used for the printed data:
 - Enter 1 for character format.
 - Enter 2 for hexadecimal format.
 - Enter 3 for SNGL format.
 - Enter 4 for TABL format.

If you select SNGL or TABL format, you must select "New" or "Existing" for **View usage**.

4. If you want the print to use a keys file, enter / in the Use key values field.
5. If you selected "Existing" for **View usage** and you want to edit the view before the Print uses it, enter "/" in the **Edit view** field.
6. Press Enter to process the data you entered. According to what you entered on the panel, one or more of these panels may be displayed in the order they are listed:
 - Subsystem Selection panel
 - Displayed when you enter no subsystem name or a subsystem name pattern.
 - Displays a list of IMS subsystems defined by the FM/IMS administrator at installation time.
 - PSB Selection panel
 - Displayed when you enter no PSB name or a PSB name pattern and select Static for the PSB type.
 - Displays a list of the PSBs in the PSB libraries for the specified subsystem.

If the PSB libraries for the subsystem are not fixed, you specify the PSB libraries for the subsystem on the PSB and DBD Data Sets panel (option 0.6.7). If the PSB libraries for the subsystem are fixed, the FM/IMS administrator specifies the PSB libraries for the subsystem at installation time.
 - PCB Selection panel
 - Displayed when you select "Static" for **PSB type** and one of the following is true:
 - You enter no database name and there is more than one database PCB in the specified PSB, or
 - You enter a database name and there is more than one PCB for the database in the PSB, or
 - You enter a database name pattern and the PSB has PCBs for databases with names that match the pattern
 - Displays a list of the PCBs in the specified PSB.
 - Database Selection panel
 - Displayed when you enter no database name or a database name pattern and select "Dynamic" for **PSB type**.
 - Displays a list of the DBDs in the DBD libraries for the specified subsystem.

If the DBD libraries for the subsystem are not fixed, you specify the DBD libraries for the subsystem on the PSB and DBD Data Sets panel (option 0.6.7). If the DBD libraries for the subsystem are fixed, the FM/IMS administrator specifies the DBD libraries for the subsystem at installation time.

- AGN Selection panel
 - Displayed when all of these are true:
 - You select "BMP" for **Region type**.
 - The specified subsystem uses AGNs and has some of them listed in the FM/IMS installation options module.
 - You enter no AGN name or an AGN name pattern.
 - Displays the AGNs for the subsystem that are listed in the FM/IMS installation options module.
- View Data Set Selection panel
 - Displayed when you enter a View data set name pattern and select "Existing" for **View usage**.
 - Displays a list of the data sets whose names match the specified View data set name pattern.
- View Member Selection panel
 - Displayed when the specified View data set is partitioned, you enter no View member name or a View member name pattern and you select Existing for View usage.
 - Displays a list of the members in the View data set.

On each selection panel that is displayed, enter **s** in the **Cmd** field adjacent to the item you want to select and press Enter.

7. If you selected "DLI" for **Region type** and did not select the **Skip DB data set panel** option, either the Database Data Set Display or the Database Data Set Specification panel is displayed.
 - The Database Data Set Display panel is displayed when a database that is a HALDB or a subsystem that is defined as dynamic allocation only is selected on the Print Entry panel. This panel displays the names of the database data sets that the function will use. Verify that the database data sets listed are the ones you want the function to use. To confirm usage of these data sets and to proceed to the next panel in the dialog, press Enter.
 - The Database Data Set Specification panel is displayed when a database that is not a HALDB and a subsystem that is not defined as dynamic allocation only is selected on the Print Entry panel. If you selected User profile for the Fetch DB dsnames from option, it displays the data set names saved in your user profile. If you selected DFSMDA members for the Fetch DB dsnames from option, it displays the data set names specified in the DFSMDA dynamic allocation members for the subsystem.

The Database Data Set Specification panel is displayed when the Skip DB data set panel option is not selected, but it is also displayed when the Skip DB data set panel option is selected and one of the following conditions is true:

- FM/IMS fails to obtain all the required data set names from either your user profile or the DFSMDA members.
- One or more of the database data sets does not exist or has an invalid data set organization.

If the displayed data set names are not the ones you want the function to use or no data set names are displayed, enter the data set names that you want the function to use and press Enter. To confirm usage of the displayed data set names and to proceed to the next panel in the dialog, press Enter once more.

8. If you selected the Use key values option on the Print Entry panel, the Print Options panel is displayed.

On the Print Options panel, specify the name of your keys file in the Key Values fields and press Enter.

9. FM/IMS uses the data you specified in the dialog to generate JCL for the Print job. The JCL is displayed at the end of the dialog.

You can edit the JCL before submitting the job.



Note: The minimum required region size is 2M.

Related topics

[Utility Menu panel on page 425](#)

[Print Entry panel on page 351](#)

[System Settings panel on page 406](#)

[PCB Selection panel on page 343](#)

[Database Data Set Specification panel on page 236](#)

Modifying the JCL to specify the KEYLIST, KEYRANGE and MAXROOTS parameters

[Generating a batch job that performs a print on page 73](#) describes how you can use the Print dialog to generate the JCL for a job that prints data from an IMS database.

There are, however, three parameters you can use that the Print dialog does not generate. These are the KEYLIST, KEYRANGE and MAXROOTS parameters.

The KEYLIST parameter allows you to specify a list of the root segment key values of the database records that you want printed. You can, of course, specify this list in a keys file, but this parameter provides you with an alternative way of specifying the key list. Unlike the keys file, however, the KEYLIST parameter also allows you to specify partial keys - if the length of a specified root key value is less than the key length of the root segment, the function considers it to be the first part of the key and prints all those database records with root key values that match the partial key value.

The KEYRANGE parameter allows you to specify the start and end of a range of root key values. The function prints those database records that have a root key value in the specified range.

The MAXROOTS parameter allows you to limit the number of database records that the function prints. When this parameter is specified, the function counts the number of database records that it has printed and terminates when it reaches the specified limit.

For information on how you code these parameters, see [Print \(IPR\) on page 579](#).

Print reports

The Print function produces two reports:

- The Database Print Summary
- The Database Print Statistics Report

The Database Print Summary reports the options and resources that the Print used. For information on the contents of this report, see [Database Print Summary on page 586](#).

The Database Print Statistics Report provides print statistics including the number of occurrences of each segment type printed. For information on the contents of this report, see [Database Print Statistics Report on page 589](#).

Viewing your database in batch

The Batch Browse dialog (option 7 on the Utility menu) generates the JCL for a Batch Browse job. A Batch Browse job runs user-written REXX procedures that invoke built-in functions that allow you to read your IMS databases.

To generate the JCL for a Batch Browse job:

1. Select option **3 Utilities** from the Primary Option Menu and then **7 Batch Browse** from the Utility Menu. The Batch Browse Entry panel is displayed.
2. Notice that many of the fields on the Batch Browse Entry panel are also on the Browse Entry panel. To fill out the fields that are common to both panels, follow one of these sets of instructions according to which Region type and PSB type you want the Batch Browse to use:
 - Steps 2 to 9 in [Accessing in BMP mode using a Static PSB on page 49](#).
 - Steps 2 to 8 in [Accessing in BMP mode using a Dynamic PSB on page 51](#).
 - Steps 2 to 10 in [Accessing in DLI mode using a Static PSB on page 52](#).
 - Steps 2 to 9 in [Accessing in DLI mode using a Dynamic PSB on page 55](#).
3. If you selected "Existing" for **View usage** and you want to edit the view before the Batch Browse uses it, enter "/" in the Edit view field.
4. If the REXX procedure that you want the Batch Browse to run includes a VIEWIMS call with the TPLDD parameter, enter `s` in the Include template DD field. If you select this option, the generated JCL includes a TDDIN DD statement that specifies the Template data sets for the specified subsystem.
5. Press Enter to process the data you entered. According to what you entered on the panel, one or more of these panels may be displayed in the order they are listed:
 - Subsystem Selection panel
 - Displayed when you enter no subsystem name or a subsystem name pattern.
 - Displays a list of IMS subsystems defined by the FM/IMS administrator at installation time.
 - PSB Selection panel
 - Displayed when you enter no PSB name or a PSB name pattern and select Static for the PSB type.
 - Displays a list of the PSBs in the PSB libraries for the specified subsystem.

If the PSB libraries for the subsystem are not fixed, you specify the PSB libraries for the subsystem on the PSB and DBD Data Sets panel (option 0.6.7). If the PSB libraries for the subsystem are fixed, the FM/IMS administrator specifies the PSB libraries for the subsystem at installation time.

- PCB Selection panel
 - Displayed when you select "Static" for **PSB type** and one of the following is true:
 - You enter no database name and there is more than one database PCB in the specified PSB, or
 - You enter a database name and there is more than one PCB for the database in the PSB, or
 - You enter a database name pattern and the PSB has PCBs for databases with names that match the pattern
 - Displays a list of the PCBs in the specified PSB.
- Database Selection panel
 - Displayed when you enter no database name or a database name pattern and select "Dynamic" for **PSB type**.
 - Displays a list of the DBDs in the DBD libraries for the specified subsystem.

If the DBD libraries for the subsystem are not fixed, you specify the DBD libraries for the subsystem on the PSB and DBD Data Sets panel (option 0.6.7). If the DBD libraries for the subsystem are fixed, the FM/IMS administrator specifies the DBD libraries for the subsystem at installation time.

- AGN Selection panel
 - Displayed when all of these are true:
 - You select "BMP" for **Region type**.
 - The specified subsystem uses AGNs and has some of them listed in the FM/IMS installation options module.
 - You enter no AGN name or an AGN name pattern.
 - Displays the AGNs for the subsystem that are listed in the FM/IMS installation options module.
- View Data Set Selection panel
 - Displayed when you enter a View data set name pattern and select "Existing" for **View usage**.
 - Displays a list of the data sets whose names match the specified View data set name pattern.
- View Member Selection panel
 - Displayed when the specified View data set is partitioned, you enter no View member name or a View member name pattern and you select Existing for View usage.
 - Displays a list of the members in the View data set.

On each selection panel that is displayed, enter **s** in the **Cmd** field adjacent to the item you want to select and press Enter.

6. If you selected "DLI" for **Region type** and did not select the **Skip DB data set panel** option, either the Database Data Set Display or the Database Data Set Specification panel is displayed.
 - The Database Data Set Display panel is displayed when a database that is a HALDB or a subsystem that is defined as dynamic allocation only is selected on the Print Entry panel. This panel displays the names of the database data sets that the function will use. Verify that the database data sets listed are the ones you want the function to use. To confirm usage of these data sets and to proceed to the next panel in the dialog, press Enter.

- The Database Data Set Specification panel is displayed when a database that is not a HALDB and a subsystem that is not defined as dynamic allocation only is selected on the Print Entry panel. If you selected User profile for the Fetch DB dsnames from option, it displays the data set names saved in your user profile. If you selected DFSMDA members for the Fetch DB dsnames from option, it displays the data set names specified in the DFSMDA dynamic allocation members for the subsystem.

The Database Data Set Specification panel is displayed when the Skip DB data set panel option is not selected, but it is also displayed when the Skip DB data set panel option is selected and one of the following conditions is true:

- FM/IMS fails to obtain all the required data set names from either your user profile or the DFSMDA members.
- One or more of the database data sets does not exist or has an invalid data set organization.

If the displayed data set names are not the ones you want the function to use or no data set names are displayed, enter the data set names that you want the function to use and press Enter. To confirm usage of the displayed data set names and to proceed to the next panel in the dialog, press Enter once more.

7. On the Batch Browse Options panel, specify whether the REXX procedure to be run is to be created instream by yourself or run from a dataset (or member) you previously created.

To create the REXX Procedure instream:

- Select "In-stream" for **Procedure type**. You must edit the generated JCL to specify the REXX that is to be run.

To run REXX from an existing data set (or member):

- In the REXX Procedure fields specify the data set (must be a PDS) and member containing the REXX that is to be run.
- Select Cataloged for the Procedure type.
- You can maintain the REXX by selecting the Edit REXX field. This will take you into an ISPF edit session to maintain the REXX procedure.

8. Press Enter. FM/IMS uses the data you specified in the dialog to generate JCL for the Batch Browse job. You can edit the JCL before submitting the job.



Note: The minimum required region size is 2M.

IBB REXX procedure (Batch Browse)

The REXX Procedure run by Batch Browse calls IBB functions to process the database with or without a view.

Using a view, you have limited control over how FM/IMS can navigate the IMS database. By specifying Selection Criteria in the view, FM/IMS only returns the IMS segments that match the selection criteria specified.

The IBB calls available when using a view are:

GETIMS

Retrieve IMS segments using the view specified.

PRINT

Print an IMS segment in CHAR, HEX, SNGL, or TABL format.

SETRC

Set the IBB job step return code.

VIEWIMS

Create and load a view to be used by the REXX procedure to retrieve IMS segments.

VIEWPOSN

Position on an IMS segment prior to invoking the GETIMS call. This allows you to start processing the IMS database from a point within the database.

When not using a view, you can navigate the IMS database using the GETIMS call. This mode is similar to issuing IMS calls within a program. You can:

- Retrieve segments based on the segments key values.
- Retrieve a segment's children.
- Position on a segment's parent or its root segment.

The IBB calls available when not using a view are:

GETIMS

Retrieve IMS segments.

PRINT

Print an IMS segment in CHAR, HEX, SNGL, or TABL format.

SETRC

Set the IBB job step return code.

VIEWIMS

Create and load a view to be used by the REXX procedure. When not processing the database using a view, FM/IMS uses the IMS segment layouts and fields in the view to:

- Print in SNGL or TABL format.
- Generate an IMS SSA when retrieving an IMS segment and the WHERE clause specifies fields from the view.

Related topics

[Utility Menu panel on page 425](#)

[Print Entry panel on page 351](#)

[System Settings panel on page 406](#)

[PCB Selection panel on page 343](#)

[Database Data Set Specification panel on page 236](#)

Listing statistics for the current Browse or Edit session

To list statistics for the current Browse or Edit session, use the SEGSTATS primary command.

The SEGSTATS primary command shows (in a pop-up panel):

- The number of segments in the current Edit or Browse session
- The total data bytes

When a view has been used, the SEGSTATS primary command also shows:

- The number of layouts
- A list of layout names and the number of segments belonging to each layout
- The number of segments not identified due to the record data not meeting identification criteria
- The number of segments with the segment length being outside the related layout length

Figure 15: Example of statistics for an Edit session listed with the SEGSTATS command on page 81 shows an example of statistics listed by the SEGSTATS command for an Edit session when a view has been used.

Figure 15. Example of statistics for an Edit session listed with the SEGSTATS command

```

Process  Options  Help
-----
FM/IMS                               Edit : IMS Database DJ1E
                                CHPID FM000001 Autosave OFF SHOW SUP ON  Scope DB  Format TABL
                                File Manager Messages

IBM File Manager for z/OS IMS Component
Segment statistics

Total segments                    : 190
Total data bytes                  : 2270

Segment SHIRE                    : 13
Layout  SHIRE                    : 13
Layout  SHIRE-TOWN               : 0
Layout  SHIRE-CITY               : 0

Segment SHIRENP                  : 11
Layout  SHIRE-NON-PUBLIC          : 11

Segment LINKSUB                  : 87
Layout  SHIRE-SUBURB            : 87

Command ==>
F1=Help      F2=Split      F3=Exit      F4=CRetriev  F7=Backward
F8=Forward   F9=Swap       F10=Actions  F12=Cancel

```

Related topics

[SEGSTATS primary command on page 493](#)

Chapter 5. Working with Templates and Views

When browsing or editing a database in FM/IMS, you can use a *view* to format segments into their individual fields, and to select the segments and fields you want to display. To create a view, you first need to create a *template* from the copybooks that define the layouts of the database segments.

A template contains the basic description of the segments in a database and the layout of fields in each segment, that is, the field type, size and position within the segment. Because there can be more than one layout for a segment type in a database, you can define layout identification criteria within the template, to enable you to distinguish between the different layouts. Before you can specify layout identification criteria, you need to examine your data, and determine what field values uniquely identify a segment occurrence as belonging to a particular type. Once defined, you can use these *segment layouts* in your views. Usually, you have only one template defined for each database.

Views are created from a template and contain additional information, such as segment selection, and field selection and display order. It is likely that you will create many views of your databases, each tailored to a specific purpose.

Creating and updating templates

An FM/IMS template is a collection of information that you can use to select and format segments and fields for an IMS database. The template provides FM/IMS with a logical view of the data to be used when editing, browsing, extracting, and printing. Templates are based upon *copybooks*.

Creating a template

Before you create a template for a database, you need to know the name of the database, the name of the DBD load library that contains the DBD for the database, the name of the partitioned data set where you want to save the new template and the names of the partitioned data sets containing the copybooks that describe the segment layouts. You must also know which copybook member corresponds to each segment type.

To create a template:

1. From the Primary Option menu, select option **4 Template**. The Template/View/Criteria Set menu is displayed.
2. Select option **1 Templates**. The Template Entry Panel is displayed.
3. In the **Template data set name** field, enter the name of the partitioned data set in which you want the template stored.
4. In the **Template Member** field, enter the name of the database that you want the template for. If this member does not already exist, the Template dialog creates a template with the specified name and stores it in this member.
5. Press Enter. The DBD Library List panel is displayed. On this panel, you enter the names of up to 6 DBD load libraries. FM/IMS searches these libraries for a DBD with the specified database name. The libraries are searched in the order in which they are specified and FM/IMS uses the first DBD it finds with the specified database name. The DBD library list you specify is saved in the template and is used for subsequent updates.
6. Press Enter. FM/IMS displays the Copybook Library List panel. On this panel, you specify the names of the copybook libraries that contain the copybooks that you want the Template function to use. The function searches the specified libraries for the layout members you specify on the Template Specification panel. The Copybook library list you specify is saved in the template and is used for subsequent updates.

**Note:**

- a. You cannot use a mix of language copybooks to create a template; you can use only COBOL, HLASM, or PL/I copybooks.
- b. Library members may not be packed by ISPF.

7. Press Enter. FM/IMS displays the Template Specification panel. This panel displays a list of the names of the segment types specified in the DBD for the database.
8. For each segment type, enter in the Layout member fields, the names of the copybooks that defines the layout or layouts of the segment. You can use prefix commands to copy (C, *Cn*, CC, with A or B), insert (I, *In*), delete (D, *Dn*, DD), move (M, *Mn*, MM, with A or B), overlay (O, *On*, OO, with C, *Cn*, CC, M, *Mn*, or MM,), or repeat (R, *Rn*, RR, *RRn*) rows on the panel. You can also use prefix commands to edit the segment layout (E), edit the copybook member (S), view the copybook member (V), update and edit the segment layout to which this copybook belongs (U) or specify redefines and range parameters for a copybook (X).

You can enter the complete member name, enter a member name pattern or, for segment header records only, leave the member name blank; then press Enter to select the members from the Member Selection panel. This panel shows a list of all the member names from all the libraries specified on the Copybook Library List panel. The name of the current segment is also displayed. The panel is redisplayed for each segment in which you have left the member name blank or specified a pattern.



Tip: If your copybook members have the same name as their matching segments, you can copy and paste the segment names into the member name fields.

9. To insert a level-01 statement in a copybook, specify \bar{x} in the **01** column.

To include a name in the generated 01 statement for the copybook, specify the required name in the **Field name** column.

10. To generate multiple record layouts for a source that contains more than one record definition within a single level-01 structure:
 - a. Type an X in the **Cmd** field next to the required segment type to display the Redefines / Range Specifications pop-up panel.
 - b. In the **Level** field, specify the source level value to be used to identify REDEFINES or UNION-level clauses that are to generate new record layouts.

Alternatively, to change the source before compile so that all matching levels are changed to 01, place a "/" against the **Change all matching levels to 01** option.

- c. In the **Field name** field, specify the target field name of the REDEFINES clause or the field name with a UNION clause that identifies the REDEFINES or UNION statements that are to be used to direct FM/IMS to create new layouts.
- d. To adjust the offset value for each layout so that the starting location is the redefines or union field start location, enter a "/" in the **Set offset** field.

11. To extract a subset of the copybook to be compiled into the template:
 - a. Type an X in the **Cmd** field next to the required segment type to display the Redefines / Range Specifications pop-up panel.
 - b. In the **From statement** field, specify the starting line number for the extract.
 - c. In the **To statement** field, specify the ending line number for the extract.
 - d. In the **From string** field, specify the string that FM/IMS is to search the copybook for. The first statement that contains the string begins the extract.
 - e. In the **To string** field, specify the string that FM/IMS is to search the copybook for. The first statement that contains the string ends the extract.
12. To compile the specified copybooks from the Template Specification panel, and either update an existing template or create a new template, use the UPDATE primary command or the U prefix command.
13. To edit the template for a given segment, use the E prefix command; alternatively, you can use the E primary command to edit the template for the segment at the top of the display.



Note: If you have made any changes, FM/IMS performs a compile and update.

14. The "R?" column contains the value "R?" if redefines or range parameters have been specified for the corresponding layout member.

The "I?" column is blank when a new template is being created. It contains the value "I?" when the template has been created and either only one layout has been specified for the segment or criteria have been provided for each layout for a given segment.

If the field is blank, then the copybook contains more than one layout for each segment type and you need to specify *layout identification criteria* in the template (see [Specifying layout identification criteria on page 96](#)).

FM/IMS does not require you to specify layout identification criteria. If you exit this panel with this field still being blank, FM/IMS saves the template. However, when browsing or editing a database using a view created from such a template, FM/IMS might display segments using an incorrect layout (or it might not display some segments at all).

Related topics

- [EDIT primary command on page 453](#)
- [LIBLIST primary command on page 475](#)
- [UPDATE primary command on page 504](#)
- [Key Specification panel on page 332](#)
- [Redefines / Range Specifications panel on page 363](#)
- [Template Entry panel on page 409](#)
- [Template Specification panel on page 412](#)

Updating templates

If, after you create a template, segment types are added to or deleted from the associated database, or segment layouts change, you must update the template to reflect these changes and also update any views that you have created from the template. Templates can be updated in the following ways:

- Selecting option **1 Templates** from the Template/View/Criteria Set menu.
- Selecting option **4 Template update** from the same menu.
- Using a batch function. See [IMS Template Update \(ITU\) on page 514](#).

Updating a template in the foreground using option 1 Templates

1. Select option **4 Templates** from the **Primary Options menu** to display the **Template/View/Criteria Set menu**.
2. Select option **1. Templates** to display the **Template Entry** panel.
3. In the **Template data set name** field, enter the name of the partitioned data set that contains the template that you want to update.
4. In the **Template Member** field, enter the name of the template member that you want to update. If you enter either no member name or a member name pattern, the Template Member Selection panel is displayed. You can select a template from the list of templates displayed on that panel.
5. Press **Enter**. FM/IMS creates a new template based on the latest DBD and copybook members, and copies from the old template as much other information as is now relevant to the new database structure:
 - The mapping of segment types to copybook members
 - Segment descriptions
 - Layout identification criteria
 - Field sequencing

After which, FM/IMS displays the Template Specification panel.

If you want to modify or just view the list of DBD libraries that FM/IMS uses to update the template, issue the DBDLIST command. When you issue this command, FM/IMS displays the DBD Library List panel. The DBD Library List panel displays the DBD library list that is currently saved in your template. If you change the list and then press the Exit function key (F3), FM/IMS:

- Validates the specified DBD libraries.
- Searches the libraries for a DBD for the template.
- Uses the DBD it finds to rebuild the template.
- Returns to the Template Specification panel.

If you save the updated template, the specified DBD library list is also saved.

If the only change to the database is a **change of copybooks** then you can change the names, or if the names are the same, you can enter the UPDATE command in the command line on this panel.

If the **new copybooks** are located in a different copylib, you will need to change the reference to the copybook data set. To do this issue the LIBLIST command and make sure the proper data sets are in place.

If you have **added new segment(s)** to the database, the segments will be displayed with blank I and **Layout member** fields. For any new segment types, you need to specify a copybook member, and perhaps also layout identification criteria, as if you were creating a new template.

If you have **removed segments** from the database, the display will reflect this and you will get a "Template changed?" message.

6. The update process adjusts field reference numbers in the layout identification criteria to reflect any changes in the field order. However, if the criteria refer to a field that has been deleted from a copybook, then the update process displays the **Segment Layout** panel, with references to deleted fields changed to "#0?". Edit the criteria, removing or replacing the obsolete field references, then press the Exit function key (F3) to continue with the update process.
7. To save the updated template, press the Exit function key (F3) on the **Template Specification** panel.

Related topics

[Primary Option menu on page 346](#)

[Template Entry panel on page 409](#)

[Template Specification panel on page 412](#)

[Template/View/Criteria Set Menu panel on page 423](#)

Updating templates in either foreground or batch using option 4 Template update

Use the **Template Update Utility** to update templates in foreground or batch.

You can filter the templates you want to process on either or both of these criteria:

- Template name pattern (if you fill in one complete template name only that one template will be processed).
- Up to four copybook names or patterns.

You can also select to use the Advanced member selection option. Then it is possible to select or filter using one or more of:

- Select templates in a name range
- Filter by userid (or a pattern or range) by whom the template was updated
- Filter by Date created (or pattern or range)
- Filter by Date modified (or pattern or range)

To update one or more templates in the foreground or in batch, using Option 4:

1. Select option **4 Templates** from the Primary Option menu to display the **Template/View/Criteria Set menu**.
2. Select option **4 Template update** to display the **Template Update Utility** panel.
3. On the **Template Update Utility** panel, enter the details to select the templates you want to update:

- In the Template **Data set name** field, specify a fully-qualified or generic data set name to identify the data set (which must be partitioned).
 - In the Template **Member** field, you can specify a template name or a template name pattern.
 - In the Template **Copybook filter** field, you can specify up to four member names or patterns to be used as a filter so that only templates referencing those copybooks, or copybooks that match the member patterns, are selected for processing.
4. In the Output Template **Data set name** field, you can specify a fully-qualified or generic data set name to identify the output data set where the updated templates are to be stored. If you leave this field blank, then the update takes place on the input data set.
 5. In the Output **Template Member mask** field, you can specify a rename mask so that the updated templates are stored under an alternative name.
 6. Select the processing options:
 - **Batch execution** to run the function in batch.
 - **Replace member** to replace like-named members in the output partitioned data set.
 - **Advanced member selection** to specify a range of members to be selected, rather than a specific or generic member name.
 - **Specify library data sets** to specify the library data sets that the utility uses to build the template. If this option is not selected, the utility uses the library data sets referenced in the template.
 - **Skip member list** to run without showing the member selection list. This option bypasses the member list panel and processes all the qualifying members. If an error (like a duplicate output name) results from the specified parameters, then the member list panel is displayed with the errors highlighted.
 - **Specify DBD data sets** to update the DBD data set name referenced in the template with one of the DBD data set names provided. You can provide up to 2 DBD data set names. The DBD data set name is changed to the first one searched that contains the matching DBD (template name). If a matching DBD member is not found, the DBD data set name is not updated.
 - **Skip database segment list update** to improve performance by eliminating DBD checking and key position processing when updating templates. Only select this option when there are no changes to the list of segment names specified in the DBDs that the templates are built from.
 - **Check mode - no update** to run the function without saving the resulting members.
 - **New database segments** to add new segments to an existing DBD/Template. If this option is selected and the **Skip database segment list update** option has not been selected, the **New Database Segments** panel will be displayed where you can specify the layout members for each of the new segments.
 - **Forced update**, if you want to perform the update when no changes have been detected.
 - **Preserve copybook library** to ensure that if a copybook still exists in the library that it was previously found in and that library is in the list that the update is using, then that version of the copybook is used.

The utility searches the libraries in the order they are listed and uses the first version of the copybook that it finds when one of these cases is true:

- This option is not selected.
- The copybook no longer exists in the library it was previously found in.
- That library is not in the list the update is using.

7. Press **Enter**.

First all datasets specified as generic will be searched for and you need to select the wanted datasets. Then, depending on what options are selected, the following panels will be displayed.

8. If **Specify library data sets** or **Specify DBD data sets** was selected then the **Template Update : DBDLIB/Library lists** panel will be displayed.

In the **DBD data set name** fields, you can specify up to 2 data set names (which must be DBD libraries). The data sets are used as alternative DBD libraries when searching for the DBD matching the template name.

If you have selected the **Specify DBD data sets** option, and the template member name exists as a DBD, then the DBD is used from this library when updating the template and the DBD data set name is updated to the first data set found containing the matching member name.

In the **Library data set name** fields, you can specify up to twelve copybook library names. The copybook library names referenced in the template are changed to the copybook library names specified in these fields. The new library data sets are used to locate and compile the copybooks during the update process, so you need to ensure that all the copybooks referenced in all the templates selected are available in the libraries you specify to avoid update errors occurring.

9. Press **Enter**.
10. If **New database segments** was selected then the **Template Update : New Database Segments** panel will be displayed. You can specify up to twelve segment (or layout) name pairs. If you need more, run the update as a batch job. Before you submit the generated JCL just modify it to cater for the additional segments.
11. Press **Enter**.
12. If **Advanced member selection** was selected then the **Advanced Member Selection** panel is displayed. Here you can specify a combination of template name pattern, or a range of template names, and updated by userid (or pattern or range), and date created (or pattern or range), and date modified (or pattern or range).
13. Press **Enter**.
14. Unless you have selected **Skip member list** then the **Template Member Selection** panel is displayed. Press F11 (Right) to scroll right to display the Description column, and F10 (Left) to return to the original display.
15. In the prefix area (**Sel**), type any of the following prefix commands and press **Enter** to perform the associated action:

B

The member is displayed using the **ISPF** Browse panel (not the File Manager Browse panel).

E

The member is displayed in the **Template Specification** panel.

V

The member is displayed using the **ISPF** View panel.

S

Select one or more members to be processed.

 **Tip:** Enter the primary command `SELECT *` to select all displayed members.

Press Enter to process all of the selected templates.

16. If **Batch execution** was selected then the JCL will be generated.

For any other processing option a message is displayed to show the result of the action performed. If any of the updates fails an error message is displayed and the status for each member is displayed in the **Prompt** field.

When you get back to the **Template Update Utility** panel, you get a summary message like:

```
42 members read 23 Updated 5 Not changed 0 Not replaced 14 Errors
```

Related topics

[Advanced Member Selection panel on page 192](#)

[Template Member Selection panel on page 411](#)

[Template Specification panel on page 412](#)

[Template Update : New Database Segments panel on page 417](#)

[Template Update Utility panel on page 418](#)

[Template/View/Criteria Set Menu panel on page 423](#)

Template and copybook concepts

A copybook is a PDS member containing either COBOL data description entries, PL/I DECLARE statements, or HLASM data description entries:

COBOL copybook

Each level-01 group item in the copybook describes a segment layout; elementary items in the group describe fields in the layout. For example, the following copybook describes three layouts (SHIRE, SHIRE-TOWN and SHIRE-CITY) for a fixed-length segment type:

```
01 SHIRE.
  05 SHIRE-KEY.
    10 SHIRE-NAME          PIC X(20).
  05 SHIRE-TYPE           PIC X(1).
    88 SHIRETYPE-SHIRE    VALUE '0'.
    88 SHIRETYPE-TOWN     VALUE '1'.
    88 SHIRETYPE-CITY     VALUE '2'.
  05 SHIRE-CODE1         PIC 9(3).
  05 SHIRE-CODE2         PIC 9(5).
  05 SHIRE-ROAD          PIC S9(15) COMP-3.
  05 SHIRE-RIVER         PIC S9(15) COMP-3.
  05 SHIRE-BRIDGE        PIC S9(15) COMP-3.
01 SHIRE-TOWN.
  05 SHIRE-KEY.
    10 SHIRE-NAME          PIC X(20).
  05 SHIRE-TYPE           PIC X(1).
    88 SHIRETYPE-SHIRE    VALUE '0'.
    88 SHIRETYPE-TOWN     VALUE '1'.
```

```

      88 SHIRETYPE-CITY VALUE '2'.
      05 SHIRE-CODE1    PIC 9(3).
      05 SHIRE-CODE2    PIC 9(5).
      05 SHIRE-YEAR     PIC 9(4) COMP.
      05 SHIRE-BRICK    PIC S9(15) COMP-3.
      05 SHIRE-WOODEN   PIC S9(15) COMP-3.
      05 SHIRE-SCHOOL   PIC S9(7) COMP-3.
      05 SHIRE-GOLF     PIC S9(4) COMP.
01 SHIRE-CITY.
      05 SHIRE-KEY.
      10 SHIRE-NAME     PIC X(20).
      05 SHIRE-TYPE     PIC X(1).
          88 SHIRETYPE-SHIRE VALUE '0'.
          88 SHIRETYPE-TOWN VALUE '1'.
          88 SHIRETYPE-CITY VALUE '2'.
      05 SHIRE-CODE1    PIC 9(3).
      05 SHIRE-CODE2    PIC 9(5).
      05 SHIRE-MAJOR    PIC S9(4) COMP.
      05 SHIRE-MAIN-ATTRACTION PIC X(20).
      05 SHIRE-MINOR    PIC S9(4) COMP.

```

PL/I copybook

Similar to COBOL copybooks, each major structure (level-1 name) describes a segment layout, and elementary names describe fields:

```

1 SHIRE,
  3 SHIRE_KEY,
    5 SHIRE_NAME          CHAR(20),
  3 SHIRE_TYPE           CHAR(1),
                          /* '0' -SHIRE */
  3 SHIRE_CODE1          PIC '(3)9',
  3 SHIRE_CODE2          PIC '(5)9',
  3 SHIRE_ROAD           FIXED(15),
  3 SHIRE_RIVER          FIXED(15),
  3 SHIRE_BRIDGE         FIXED(15);
1 SHIRE_TOWN,
  3 SHIRE_KEY,
    5 SHIRE_NAME          CHAR(20),
  3 SHIRE_TYPE           CHAR(1),
                          /* '1' -TOWN */
  3 SHIRE_CODE1          PIC '(3)9',
  3 SHIRE_CODE2          PIC '(5)9',
  3 SHIRE_YEAR           FIXED BIN(15),
  3 SHIRE_BRICK          FIXED(15),
  3 SHIRE_WOODEN         FIXED(15),
  3 SHIRE_SCHOOL         FIXED(9),
  3 SHIRE_GOLF           FIXED BIN(15);
1 SHIRE_CITY,
  3 SHIRE_KEY,
    5 SHIRE_NAME          CHAR(20),
  3 SHIRE_TYPE           CHAR(1),
                          /* '2' -CITY */
  3 SHIRE_CODE1          PIC '(3)9',
  3 SHIRE_CODE2          PIC '(5)9',
  3 SHIRE_MAJOR          FIXED BIN(15),
  3 SHIRE_MAIN_ATTRACTION CHAR(20),
  3 SHIRE_MINOR          FIXED BIN(15);

```

HLASM copybook

HLASM copybooks are similar to COBOL copybooks, in that the major structures (DSECT names) describe record types and elementary names describe fields:

```

SHIRE          DSECT
SHIRE_KEY     DS  0CL20
SHIRE_NAME    DS  CL20
SHIRE_TYPE    DS  CL1
SHIRE_CODE1   DS  CL3
SHIRE_CODE2   DS  CL5
SHIRE_ROAD    DS  H
SHIRE_RIVER   DS  H
SHIRE_BRIDGE  DS  H
*
SHIRE_TOWN    DSECT
SHIRE_KEY     DS  0CL20
SHIRE_NAME    DS  CL20
SHIRE_TYPE    DS  CL1
SHIRE_CODE1   DS  CL3
SHIRE_CODE2   DS  CL5
SHIRE_YEAR    DS  H
SHIRE_BRICK   DS  PL8
SHIRE_WOODEN  DS  PL8
SHIRE_SCHOOL  DS  PL4
SHIRE_GOLF    DS  H
*
SHIRE_CITY    DSECT
SHIRE_KEY     DS  0CL20
SHIRE_NAME    DS  CL20
SHIRE_TYPE    DS  CL1
SHIRE_CODE1   DS  CL3
SHIRE_CODE2   DS  CL5
SHIRE_MAJOR   DS  H
SHIRE_MAIN_ATTRACTION DS CL10
SHIRE_MINOR   DS  H

```

For more information, see the section "Using HLASM copybooks with File Manager" in the Base *File Manager User's Guide and Reference*.

Whenever you create or update a template, FM/IMS:

1. Concatenates the copybooks (that you have matched with segment types) and includes them all in a shell program.
2. Invokes the selected compiler to check the syntax of the copybooks, and to produce an ADATA file.

You can use the Compiler Language Selection panel (option 0.4.1) to specify which compiler you want FM/IMS to invoke. You can specify the acceptable return code level for the compilation in these panels:

- Set COBOL Processing Options panel (option 0.4.2)
- Set HLASM Processing Options panel (option 0.4.3)
- Set PL/I Processing Options panel (option 0.4.4)

3. If the compilation is completed without errors, then FM/IMS processes the information in the ADATA file to create a template.

If the compilation is completed with a return code of greater than the specified maximum, then FM/IMS displays a pop-up menu, where you can choose to:

- Browse the compilation listing.
- Stop the template creation process.
- Try the compilation again. Before you select this option, first view the compilation listing and correct any errors in the copybooks. While you are viewing the compilation listing, you can use the ISPF split screen facility to edit the copybooks and correct the errors in another ISPF session.
- Ignore the errors and proceed with creating the template. This option is only available if FM/IMS is able to create the template. Some compilation errors, such as warnings, might have no effect on the creation of the template. If you are unsure, you should view the compilation listing. If the compilation error is too severe, FM/IMS cannot create a template.
- Try the compiler for the other language (if the COBOL or PLI compiler language has been selected).

Using Assembler copybooks with FM/IMS

To instruct FM/IMS to process an Assembler copybook, set the language option to HLASM. (**Auto detect** applies to COBOL and PL/I copybooks only.) When the option is set to HLASM, every function that supports copybooks can be used with an Assembler copybook. Use the HLASM compiler specifications to provide extra SYSLIB and change ALIGN and DBCS processing options.

FM/IMS support of COBOL data description entries

In the data description entries specified in the copybook, FM/IMS supports:

- ASSIGN clause
- OCCURS clause (including OCCURS DEPENDING ON)
- PICTURE clause (except for numeric editing)
- REDEFINES clause
- RENAMES clause
- USAGE clause
- VALUE clause

FM/IMS ignores:

- BLANK WHEN ZERO clause
- DATE FORMAT clause
- EXTERNAL clause
- GLOBAL clause
- JUSTIFIED clause
- Numeric editing in the PICTURE clause
- SYNCHRONIZED clause

FM/IMS supports all data item level numbers except 88 (condition-names); these are ignored.

Details of the support for various clauses are described in the following sections.

VALUE clause

The literal value that you specify in a VALUE clause is used in the template to specify the **Start value** (for numeric fields) or **Pattern** (for alphanumeric fields) “*create attribute*” on the Field Attributes panel for that field.

FM/IMS uses this attribute to initialize the value of the field when creating data or inserting new fields when copying data.

Support for variable-length arrays

A variable-length array is defined in a COBOL copybook by an OCCURS DEPENDING ON (ODO) clause, and in a PL/I copybook by a dimension attribute where the lower or upper bounds (or both) are defined by REFER options.



Note: Variable-length segments begin with a 2-byte binary numeric “*size field*”. So, in a layout for a variable-length segment, the first elementary item must be a 2-byte binary numeric field.

The following considerations apply when using layouts that contain variable-length arrays:

- Only use variable-length arrays in layouts for variable-length segment types.
- A layout can contain multiple variable-length arrays, however, the fields that define the size of the arrays (the ODO or refer “*objects*”) must all be in the layout before the first variable-length array item.
- When browsing or editing a database, if either of the following conditions is true, the **Cmd** field for the segment contains the tag `=LG`, indicating that the segment length is incorrect for its layout.
 - (COBOL copybook only.) The object is out of the range specified by the ODO clause.
 - The actual length of a segment does not match the calculated length of a segment with the number of array items specified by the object.
- In SNGL or TABL display format:
 - If you change the value of an object field, then the number of items in the array expands or contracts automatically, and the value of the size field (the 2-byte binary numeric field at the start of a variable-length segment) is adjusted to match the new segment length.

New items are inserted at the end of the current array (and before any fields that follow the array); numeric items are initialized to zero and alphanumeric items are initialized to blanks.

Similarly, items are deleted from the end of the array, and any fields subsequent to the end of the array are not affected.

For PL/I, the number of items in an array is determined by subtracting the lower bound of the dimension attribute from the upper bound. If both the lower and upper bounds are specified using REFER options, then changing the value of either of the refer object fields inserts or deletes array items accordingly.

- (COBOL copybook only.) You cannot change the object field to a value outside the range specified by the ODO clause. (FM/IMS supports an ODO lower value of 0.)

- (COBOL copybook only.) Inserting a new segment results in a segment with the minimum number of array items specified by the ODO definition. For example:
 - Given the following ODO clause, when you insert a new segment, the ODO-CNTRL-ONE field is initialized to zero and there are no ODO-ONE array items in the new segment:

```
ODO-ONE OCCURS 0 TO 10 TIMES DEPENDING ON ODO-CNTRL-ONE.
```
 - Given the following ODO clause, then ODO-CNTRL-ONE is initialized to 5, and there are five ODO-ONE array items in the new segment.:

```
ODO-ONE OCCURS 5 TO 7 TIMES DEPENDING ON ODO-CNTRL-ONE.
```
- (PL/I copybook only.) Inserting a new segment results in a segment with zero array items. Upper and lower bound refer object fields are initialized to zero.
- In CHAR, HEX or LHEX display format, changing the value of an object field does **not** change the segment length. In these display formats, changing the value of an object field can result in a mismatch between the object field value and the calculated length of the segment with that many array items.

Editing templates

Once a template has been created, you can edit it further to ensure that it suits your requirements. You can edit a template to:

- View and print the segment layouts.
- Specify expressions for layout identification.
- Set the order of fields using a sequence number.
- Modify the offset value for a layout.

Figure 16. Editing a template

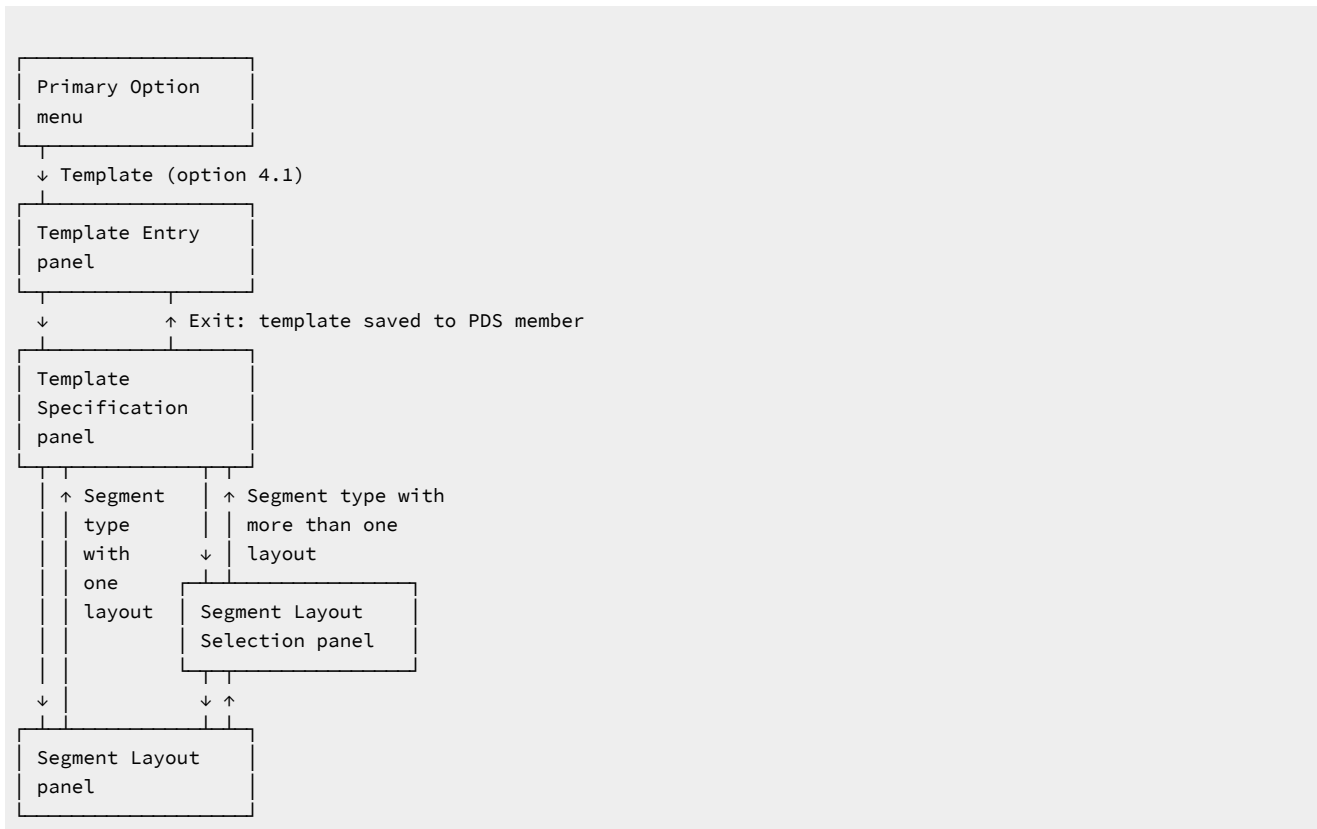

Viewing and printing segment layouts

You can view or print the layout for a segment by editing the layout.

1. From the Template Specification panel, type an **E** in the Cmd field adjacent to the segment that you want to view, then press Enter.



Note: Before you enter the E line command, you need to fill in all the **Layout member** fields. If you enter an E line command before you have filled in all of the **Layout member** fields, FM/IMS ignores the command and displays a member selection list for the first empty **Layout member** field.

If the copybook member has only one layout Level 01 definition for this segment, the Template : Segment Layout panel is displayed.

If the copybook member has more than one layout definition for this segment, the Template : Segment Layout Selection panel is displayed. Type an **E** in the Cmd field adjacent to the layout that you want to view, then press Enter. The Template : Segment Layout panel is displayed.

2. You can use the FIND primary command to locate a string within the layout.
3. To print the layout, issue the TPRINT (or TP) primary command.

Related topics

- [TPRINT primary command on page 501](#)
- [LZERO primary command on page 478](#)
- [Segment Layout panel on page 370](#)
- [Segment Layout Selection panel on page 377](#)
- [Template Specification panel on page 412](#)

Specifying layout identification criteria

In a template, if a segment type has more than one layout, you need to specify layout identification criteria for each layout of that segment type.

When you use a view (based on the template) to browse or edit a database containing that segment type, FM/IMS determines which layout to use by comparing occurrences of that segment type with the layout identification criteria. If the segment data matches the layout identification criteria for more than one layout, FM/IMS uses the first matching layout (according to the order of the layouts in the copybook). If the data matches none of the layout criteria, then the segment is flagged to identify it as not having matched any layout criteria.

For example, in the COBOL copybook in [Template and copybook concepts on page 89](#), all three layouts contain a SHIRE-TYPE field. If SHIRE-TYPE contains "0" for SHIRE, "1" for SHIRE-TOWN, and "2" for SHIRE-CITY, you can specify #4=0 as the layout identification criteria for the SHIRE layout, #4=1 for SHIRE-TOWN and #4=2 for SHIRE-CITY (where #4 is a field reference to SHIRE-TYPE). When browsing or editing data, FM/IMS uses the appropriate layout to display occurrences of that segment type, depending on the value of SHIRE-TYPE.

To specify layout identification criteria:

1. From the Template Specification panel, type an **E** in the Cmd field adjacent to the segment that you want to view, then press Enter. If the copybook member has more than one Level 01 layout definition for this segment, the Template : Segment Layout Selection panel is displayed.
2. Type an **E** in the Cmd field adjacent to the layout that you want to edit, then press Enter. The Template : Segment Layout panel is displayed.
3. Specify the segment identification criteria by doing one of:
 - Enter a freeform REXX expression in the ID field. You can scroll to the right or left within the field, using the Right (F11) or Left (F10) function keys, or you can expand the field, using the Expand function key (F4).
 - Entering the 1 primary command, to display the Layout Identification Criteria panel and then building your criteria statement using the fields on this panel.
4. Press the Exit function key (F3) to return to the Template Layout Selection panel, and repeat these steps for each Level 01 layout.
5. When you have assigned layout identification criteria to all the layouts, press F3 again to return to the Template Specification panel and save your template.

Related topics

[Segment Layout panel on page 370](#)

[Field Selection Criteria panel on page 301](#)

Setting the template field sequence

To change the order in which fields are displayed when browsing or editing the database:

1. On the Template : Segment Layout panel, enter a sequence number in the **Seq** fields.

Fields with sequence numbers are displayed before fields without sequence numbers. Fields with sequence numbers are displayed in the relative order of the sequence numbers. The remaining fields (without sequence numbers) are displayed in their default order (the order in which they appear in the panel). Sequence numbers do not need to start at 1, or be consecutive.

Every view or criteria set that you create from a template inherits the sequence numbers that you enter in the Template : Segment Layout panel. You can change or delete these sequence numbers in the View or Criteria : Segment Layout panels.

Related topics

[Segment Layout panel on page 370](#)

Modify the offset value for a layout

When you are using a template to format your data, there are times when the information in your segments is displaced because your copybook or template defines its fields as beginning to the right or left of the actual data in the segment. For example, your segments may include header information, which is not defined in the copybook structure, or your copybook may include a definition for some header information which is not in the actual data. (PL/I copybooks are sometimes coded with a 4 byte RDW field that File Manager strips from the segment, as it isn't normally considered part of the data.) To map your template to your segments without changing the originating copybook, you can specify an offset value, which changes the template's field starting positions to the left or right.

The offset value is an integer between -32760 and 32760, which is applied to one or more Level 01 fields in the template. The starting position of each field within the Level 01 segment layout is increased or decreased by this value. A positive offset moves the fields to the right and some fields might be mapped beyond the length of the segment. Data that falls beyond the length of the segment layout is not represented. You cannot edit a field where the data you supply would fall beyond the physical end of the layout (whether the record is of fixed or variable length). A negative offset moves the fields to the left and all fields with a resultant zero or negative start location are removed from the display.

All required fields must have a positive start location. Required fields are fields such as OCCURS DEPENDING ON target fields, PL/I REFER fields, or fields referenced in segment identification or field selection criteria. If a required field would have a negative or zero start column value under the supplied offset, the offset is invalid, and thus not allowed. If the first element of a dimensioned field is at a zero or negative start location, that field (all array elements) is removed from the display.

The offset is applied before values are calculated for use in identification or selection criteria.

When you are editing a template, you can enter an offset value in the Template : Segment Layout panel to change the starting position of the currently displayed segment type. If the template contains more than one Level 01 field, you can use the OFFSET primary command in the Template : Segment Layout Selection panel to change one or more Level 01 fields.

To change the offset in a single segment type:

1. In the Template : Segment Layout panel, enter a positive or negative number, between -32760 and 32760, in the Offset field.

The offset value is added to the segment length of the Level 01 field and to the starting position of all fields within the segment layout.

To change the offset in multiple segment layouts:

1. In Command line on the Template : Segment Layout Selection panel, enter the OFFSET primary command and the offset value.

By default, the offset value is applied to all segment layouts with a current offset value of zero. To apply the offset value to all segment types in the template, regardless of the current offset value, use the ALL keyword with the primary command. To apply the offset value to a specific segment layout, specify the layout name with the primary command.

The offset value is added to the segment length of the Level 01 field and to the starting position of all fields within the specified segment layouts.

Related topics

[OFFSET primary command on page 480](#)

[Segment Layout panel on page 370](#)

[Segment Layout Selection panel on page 377](#)

Creating and editing views

A view begins as a copy of a template. You can then add information to:

- Select the segments you want displayed
- Select the fields you want displayed
- Select the order in which you want the fields displayed.
- Change the display width of a field
- Display leading zeros on numeric fields
- Specify a field heading to use instead of the field name in the copybook



Tip: You create one template per database (DBD); the template and DBD have matching member names. You only need to update a template if segment types are added, segment types are renamed, or segment layouts change in the underlying database structure.

You can create as many views as you like for the same database, with each view providing a different way of looking at the data, selecting different segments and fields. You can prepare your views before you browse or edit your data, or you can create and edit a view while you are browsing or editing a database.

Figure 17. Overview of templates and views

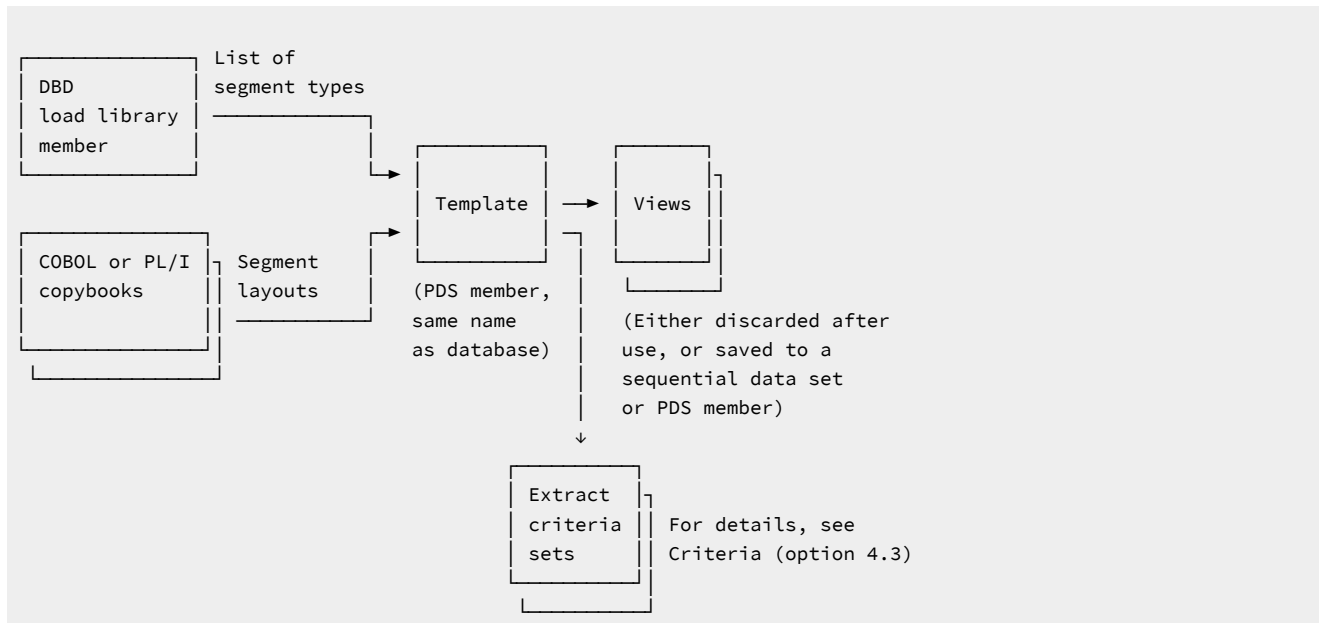

Creating a view prior to browsing or editing

To create a view prior to browsing or editing:

1. Select **Views** (option 4.2) from the Primary Option menu. The View Entry panel is displayed
2. In the **Template** fields, enter the data set and member name of your template.
3. In the **View: Data set name** field, enter the name of an existing data set, in which you want to store your view.
4. In the **View: Member** field, enter the name of a new member. This member is created when the view is saved.
5. If you want your new view to begin as a copy of an existing view, enter the data set name and member name of the model view in the **Model view:** fields, and then enter the CM primary command on the Command line.

otherwise

Enter the CT primary command on the Command line.

6. Press the Enter key. The view is created and a confirmation message is displayed in the top right corner of the panel.

After creating a view using either method, you can edit it. You can also edit a view while you are browsing or editing a database.

Related topics

[View Entry panel on page 425](#)

Creating a view while browsing or editing

When you create a view during the browse or edit process, you can choose to create a temporary view or to save the view for later reuse.

To create a view while browsing or editing:

1. If you want to be prompted to save your view, select option **0 Settings** from the Primary Option Menu and then option **5 EDIT** from the Settings Menu. The Editor Options panel is displayed. Enter "/" in **Prompt** to save the view when exiting the edit/browse session and then press the Exit function key (F3) to save this setting and exit the panel.
2. Follow the instructions provided in [Accessing your databases on page 47](#) and select "New" for **View usage** on the Browse Entry or Edit Entry panel.
3. The Database Positioning panel is displayed. Notice that the View field displays "Temporary".
4. Use the X line command to deselect a segment type and press Enter, notice that the letter "C" appears next to the View header. The C indicator is displayed when you make any change to the view.
5. Issue the VSAVE command, FM/IMS displays the View Save panel. Specify the name of a data set and member in which you want the temporary view saved, then press the Exit function key (F3).
6. FM/IMS saves the view in the specified data set and returns you to the Database Positioning panel. Notice that the C indicator is no longer displayed and the View field now displays the data set and member name in which you saved the view.
7. Use the X line command to deselect a segment type once more and press Enter. Notice that the C indicator appears as before.
8. Press the Exit function key (F3) and if the Database Data Set Display or Database Data Set Specification panel is displayed press the Exit function key once more. The View Save panel is displayed once more, where you have the choice of saving the changes you made to your view or discarding the changes.



Note: You are only prompted to save your view before you return to the Browse or Edit Entry panel, if you have selected the Prompt to save view when exiting edit/browse session option on the Editor Options panel and you have modified the view during the session and not saved it.

Related topics

[Database Positioning panel on page 239](#)

Updating views

If you have updated a template, then you must also update all the views based on the template.

Views can be updated in the following ways:

- Selecting option **2 Views** from the **Template/View/Criteria Set** menu.
- Selecting option **5 View update** from the same menu.
- Using a batch function. See [IMS View Update \(IVU\) on page 528](#).

Updating one view in the foreground using option 2 Views

Here is how you update one view in the foreground using option **2 Views**.

- Select option **4 Templates** from the **Primary Option** menu to display the **Template/View/Criteria Set** menu.
- Select option **2 Views** to display the **View Entry** panel.
- On the **View Entry** panel, enter the details to select the view you want to update.

In the View **Data set name** field, specify a fully-qualified or generic data set name to identify the data set (which must be partitioned). Fill in the view member name, or enter a view name pattern to be able to select the view from the **View Member Selection** list.

- Then type `u` on the command line and press **Enter**.
- If the process detect that a change has been done to the template that warrants an update of the view, a “View updated?” message is displayed. The view is then updates with the new information found in the template. You can now edit the view, to account for any changes in segments. If the view is still valid for the current template then a “Update not required?” will be displayed.

Related topics

[Primary Option menu on page 346](#)

[Template/View/Criteria Set Menu panel on page 423](#)

[View Entry panel on page 425](#)

[View Member Selection panel on page 428](#)

Updating one or more views in the foreground or as a batch job using option 5 View update

The **View Update Utility** allows you to update one or more views in either foreground or batch. The views you want to process can be filtered on either or both of these criteria:

- View name pattern (if you fill in one complete view name only that one view will be processed).
- Up to four template names or patterns.

You can also select to use the Advanced member selection option. Then it is possible to select or filter using one or more of:

- Select views in a name range
- Filter by userid (or a pattern or range) by whome the view was updated
- Filter by Date created (or pattern or range)
- Filter by Date modified (or pattern or range)

To update one or more views in the foreground or as a batch job using option 5:

- Select option **4 Templates** from the **Primary Option menu** to display the **Template/View/Criteria Set menu**.
- Select option **5 View update** to display the **View Update Utility** panel.
- On the **View Update Utility** panel, enter the details to select the views you want to update:
 - In the View **Data set name** field, specify a fully-qualified or generic data set name to identify the data set (which must be partitioned).
 - In the View **Member** field, you can specify a view name or a view name pattern.
 - In the **Template filter** field, you can specify up to four member names or patterns to be used as a filter so that only views referencing those templates, or templates that match the member patterns, are selected for processing.
 - In the Output View **Data set name** field, you can specify a fully-qualified or generic data set name to identify the output data set where the updated views are to be stored. If you leave this field blank, then the update takes place on the input data set.
 - In the Output View **Member mask** field, you can specify a rename mask so that the updated templates are stored under an alternative name.
 - In the Template **Data set name** field, specify a fully-qualified or generic data set name to identify the data set (which must be partitioned).
- Select the processing options:
 - **Batch execution** to run the function in batch.
 - **Replace member** to replace like-named members in the output partitioned data set.
 - **Advanced member selection** to specify a range of members to be selected, rather than a specific or generic member name.
 - **Specify template data sets** to update the template data set name referenced in the view with this template dataset. If this option is not selected, the utility uses the template data set referenced in the view.
 - **Skip member list** to run without showing the member selection list. This option bypasses the member list panel and processes all the qualifying members. If an error (like a duplicate output name) results from the specified parameters, then the member list panel is displayed with the errors highlighted.
 - **Check mode - no update** to run the function without saving the resulting members.
 - **Forced update**, if you want to perform the update when no changes have been detected.
- Press **Enter**.

First all datasets specified as generic will be searched for and you need to select the wanted datasets. Then, depending on what options are selected, the following panels will be displayed.

- If **Advanced member selection** was selected then the **Advanced Member Selection** panel is displayed. Here you can specify a combination of view name pattern, or a range of view names, and updated by userid (or pattern or range), and date created (or pattern or range), and date modified (or pattern or range).
- Press **Enter**.

Unless you have selected **Skip member list** then the **View Member Selection** panel is displayed. Press F11 (Right) to scroll right to display the Description column, and F10 (Left) to return to the original display.

- In the prefix area (Sel), type any of the following prefix commands and press Enter to perform the associated action:

B

The member is displayed using the **ISPF** Browse panel (not the File Manager Browse panel).

E

The member is displayed in the **Segment Selection** panel.

V

The member is displayed using the **ISPF** View panel.

S

Select one or more members to be processed.



Tip: Enter the primary command `SELECT *` to select all displayed members.

Press Enter to process all of the selected views.

- If **Batch execution** was selected then the **JCL** will be generated. Else the process that is ordered is executed and a message is displayed to inform you of the result of the action performed. If any of the updates fails an error message is displayed and the status for each member is displayed in the Prompt field.

When you get back to the **View Update Utility** panel you will get a summary message that will be similar to this:

```
4 members read 2 Updated 1 Not changed 0 Not replaced 1 Errors
```

Related topics

[Advanced Member Selection panel on page 192](#)

[Primary Option menu on page 346](#)

[Segment Selection panel on page 379](#)

[Template/View/Criteria Set Menu panel on page 423](#)

[View Member Selection panel on page 428](#)

[View Update Utility panel on page 429](#)

Editing a view

You can edit a view via the View Entry Panel or on the fly in an Edit or Browse session. You can use the view to perform the following tasks:

- Select or deselect a **segment type** for display. If a segment type is not selected for display, then FM/IMS does not display any segments of this type in an IMS data panel. Values in the segment might still be used in determining if the database record is selected.

If a segment type is selected for display, segments of this type are displayed, either as the currently formatted segments or as suppressed segments.

- Select or deselect a **segment layout** for display. If a segment layout is not selected for display, then FM/IMS does not display any segments that meet the Layout Identification criteria of this segment layout in an IMS data panel. Values in the segment might still be used in determining if the database record is selected.

If a segment layout is selected for display, segments of this layout are displayed either as the currently formatted segments or as suppressed segments.

- Select or deselect a field for display. If a field is not selected for display, then FM/IMS does not show the field in any IMS data panel. (If you zoom on a formatted segment, all fields are displayed whether they are selected or not.)
- Change the field heading. The default field (column) heading is the field name from the copybook. When you provide a different field heading, FM/IMS uses your heading as the column heading for TABL formatted panels, or the field heading for SNGL formatted panels.
- Supply Field Selection criteria. If a segment instance is to be selected, it must satisfy the Field Selection criteria supplied for the matching segment layout. If a segment fails to satisfy the criteria, and so is not selected, the database record of which it is a component might also not be selected. (Layout Identification criteria are supplied in the template.)
- Adjust the output width of fields.
- Display leading zeros. Applied to numeric fields.
- Supply creation attributes. These attributes are used when you insert a segment.

Figure 18. Editing a view

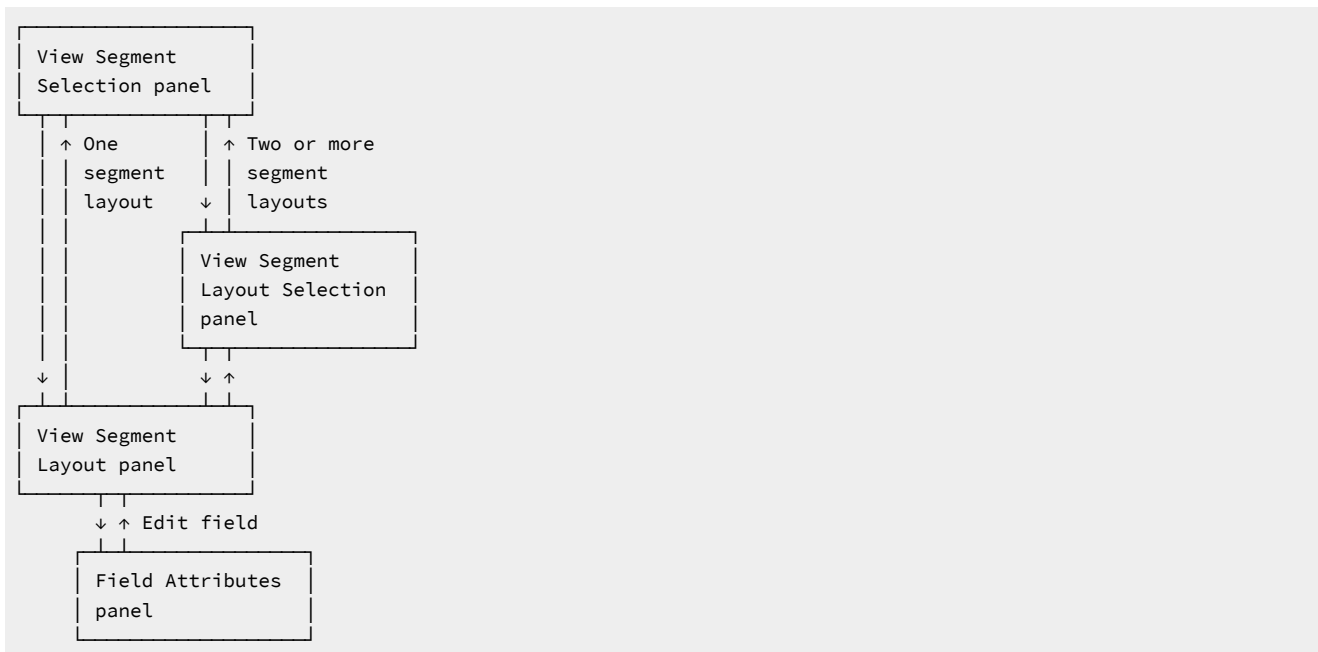

You can begin to edit your view in two different ways:

1. On the View Entry Panel, fill in the Template data set name and member name and the View data set and member name, then enter an `E` on the Command line. On the Segment Selection panel, enter an `E` in Cmd field, adjacent to the segment type that you want to edit.
2. On the Database Positioning panel, enter an `E` in Cmd field, adjacent to the segment type that you want to edit.

If the selected segment is not a multi-layout segment, the **View : Segment Layout** panel is displayed.

If the selected segment is a multi-layout segment, the **View : Segment Layout Selection** panel is displayed. Select the layout by entering the an `E` in Cmd field, adjacent to the layout that you want to edit.

Related topics

[View Entry panel on page 425](#)

[Database Positioning panel on page 239](#)

[Segment Layout panel on page 370](#)

[Segment Layout Selection panel on page 377](#)

Selecting and excluding segment types and layouts

By default, all segment types in a template are initially selected in the view. Because of this, the usual way of specifying which segments are selected for viewing is to exclude the unwanted segments.

You can exclude a segment type from display via the View Entry Panel or on the fly in an Edit or Browse session.

To exclude a segment type via the View Entry panel:

1. Follow the instructions in [Editing a view on page 103](#) to display the Segment Selection panel.
2. Enter an `s` in the **Cmd** field adjacent to each selected segment type that you want to exclude.

The `s` command toggles the selection on or off, depending upon its current status. An asterisk is shown in the **Sel** column for each segment type that is selected. To re-select an excluded segment, enter the `s` command again.

To exclude a segment type via the Database Positioning panel:

1. Follow the instructions in [Editing a view on page 103](#) to display the Database Positioning panel.
2. Enter an `x` in the **Cmd** field adjacent to each selected segment type that you want to exclude.

The `x` command toggles the selection on or off, depending upon its current status. An 'X' is shown in the **SXE** column for each segment type that is selected. To re-select an excluded segment, enter the `x` command again.

To exclude a segment layout:

1. From the Segment Selection panel or Database Positioning panel, enter an **E** in the **Cmd** field adjacent to a multi-layout segment type.
2. Enter an **S** in the **Cmd** field adjacent to each selected segment layout that you want to exclude.

The **S** command toggles the selection on or off, depending upon its current status. An 'S' is shown in the **SIE** column for each segment layout that is selected.

When there are a large number of segment types or segment layouts in your view and you only want to select a few, you can exclude all the segment types in one action, and then re-select only those you want to include.

1. In any panel, enter `SELECT ALL OFF` in the Command line.
2. Enter **S** or **X** in the **Cmd** field adjacent to each segment type or layout that you want to include.

To re-select all segment types or layouts, enter `SELECT ALL` in the Command line.

Related topics

[SELECT ALL primary command on page 493](#)

[Database Positioning panel on page 239](#)

[Segment Layout panel on page 370](#)

[Segment Layout Selection panel on page 377](#)

Selecting and sequencing fields in a view

The order in which fields are displayed in a view is initially drawn from the underlying template. However, you can modify the field sequence in your view and exclude fields from display. Fields excluded from display can still be used in layout identification or field selection criteria.

To change the order in which fields are displayed when browsing or editing the database:

1. On the View : Segment Layout panel, enter a sequence number in the **Seq** fields.

Fields with sequence numbers are displayed before fields without sequence numbers. Fields with sequence numbers are displayed in the relative order of the sequence numbers. The remaining fields (without sequence numbers) are displayed in their default order (the order in which they appear in the panel). Sequence numbers do not need to start at 1, or be consecutive.

To exclude a field from a layout:

1. On the View : Segment Layout panel, enter an **S** in the **Cmd** field adjacent to each field that you want to include.

The **S** command toggles the selection on or off, depending upon its current status. An 'S' is shown in the **SHC** column for each field that is selected.



Note: Field selection differs from segment type or layout selection, in that all fields are selected by default. Therefore, if no selection is made in this panel, and no field is tagged with an 'S' in the **SHC** column, all fields are selected. However, as soon as you tag one field with the `s` command, all other fields become excluded.

When there are a large number of fields in your layout and you only want to deselect a few, you can tag all the fields for selection in one action, and then deselect only those you want to exclude. To do this:

1. On the View : Segment Layout panel, enter the `SELECT ALL` primary command in the Command line.
2. Enter the `s` command in the **Cmd** field adjacent to each field that you want to exclude.

Related topics

[SELECT ALL primary command on page 493](#)

[Segment Layout panel on page 370](#)

Setting field attributes

In a view, you can change the display and create attributes for a field.

You can change the following field display attributes:

- Field heading. (By default, the heading in the database display is the field name used in the layout, but you can change this for display purposes only.)
- Output width
- Leading zeros (numeric fields)

You can change the following field creation attributes for alphanumeric fields:

- Filler
- Action
- Start character
- Pattern
- Repeat user pattern

You can change the following field creation attributes for numeric fields:

- Start value
- End value
- Increment
- Cycle

To change the field attributes:

1. On the View : Segment Layout panel, enter an **E** in the **Cmd** field adjacent to the field that you want to edit.

The Field Attributes panel is displayed and shows the attributes appropriate for the field type.

2. Enter values in the attribute fields that you want to change.

Related panels

[Field Attributes panel - alphanumeric fields on page 287](#)

[Field Attributes panel - numeric field on page 294](#)

Displaying a field without truncation

If a numeric field contains a valid numeric value, but the value is too large to fit in the width allocated to the field (as defined in the original copybook by the PICTURE clause), then the value is truncated. The field is highlighted to indicate that truncation has occurred.

To display the entire field without truncation, you need to edit the view, and specify an output width for the field:

1. Press F3 to get to the Database Positioning panel.
2. If the view contains two or more segment types, enter **E** next to the segment type for the field.
3. Enter **E** next to the field.

The Field Attributes panel for the field is displayed.

4. In the **Output width** field, enter a value that is wide enough to display the entire field.
5. Press the Exit function key (F3) until you are back at the IMS data panel.

If a field is a table element (defined in the original copybook by an OCCURS clause), then its field heading is followed by a subscript in parentheses; for example, TABLE-ELEMENT(1).

Defining date and time fields

In a view, you can identify to FM/IMS fields that hold date and/or time values. This is done through the Date/Time Attributes panel where you can specify:

- The format used to store the date and time value in the field
- An alternate data type used for date and time processing
- The format used to display the date and time values saved in the field
- Date creation options
- Date/Time scrambling options

To define or change date and time attributes for a field:

1. On the View : Segment Layout panel, enter **DT** in the **Cmd** field adjacent to the date/time field.

The Date/Time Attributes panel is displayed and shows any attributes that may have already been defined for the field.

2. Enter values in the attribute fields that you want to define or change.

Specifying scrambling options

Scrambling data allows you to create test data based on production (or "live") data, but with the ability to change the values of certain fields.

Scrambling can be performed by running the FM/IMS extract utility and selecting the scramble option either from the panel or using the SCRAMBLE=YES keyword for existing batch jobs. The fields in the templates associated with the extracted databases that have scrambling attributes set will be scrambled accordingly.

To mark a field for scrambling, set the scrambling options for that field in the template. You can specify or change scrambling options on the Field Attributes panel. This panel comes in two versions: one for alphanumeric fields and the other for numeric fields.

Selecting a field for specifying scrambling options

You select a field from the Field Selection/Edit panel. To select one or more fields for specifying scrambling options, enter **E** in the **Cmd** field adjacent to the required fields. For each selected field, FM/IMS displays a Field Attributes panel.

After you have updated the scrambling options for a field (or any of the other field attributes), when you return to the Field Selection/Edit panel you will see an "E" for that field in the E column (under the "SHE" heading) indicating that the attributes for that field have changed.

The scrambling options you can specify are:

- Scramble type
- Value option
- Value input column
- Value output column
- Minimum and maximum values for a numeric range
- Value data set name

The scrambling options determine how the input data is scrambled (if at all) when it is copied to an output dataset.

Specifying the scramble type

The **Scramble Type** option determines how data is scrambled when it is copied to the output data set.

Set the scramble type to one of these values:

Blank

Data is not scrambled.

1 ("Random")

Data scrambled to produce a random output value on each invocation.

2 ("Repeatable")

Data scrambled to produce the same output value on each invocation.

3 ("Translate")

Data scrambled using input and output values held in the value data set (specified in the **Dsn** field).

This option requires you to select the **Value** option with an input and output column (**In** and **Out**) and value data set name (**Dsn**). All records in the translate data set are loaded into memory for the copy operation. The input and output columns provide the location of the input and output field values as stored in the data set. Their lengths are determined by the respective input and output fields that have been mapped for the copy operation. If a matching input field value is found, then the corresponding output field value is obtained from the matching record. If no match is found, then the field is initialized to zero, or the value determined by the data create attributes.

4 ("Exit")

Data scrambled using a scrambling exit (as specified on a separate panel). For details about writing a scrambling exit, see the *File Manager Customization Guide*.

Related topics

[Specifying the value option on page 110](#)

[Specifying value input and out columns on page 111](#)

[Specifying range values on page 111](#)

[Specifying a value data set name on page 112](#)

Specifying the value option

The **Value** option and corresponding fields control the output of the scrambling process.

The way in which you select, or specify, this option differs according to whether the associated field is alphanumeric or numeric:

- For alphanumeric fields, do one of these:
 - Deselect the **Value** option by entering a blank.
 - Select the **Value** option by entering a "/".
- For numeric fields, do one of these:
 - Deselect the **Value** option by entering a blank.
 - Select a range by entering "1".
 - Select the **Value** option by entering "2".

Value option selected ("/")

Selecting this option allows you to provide:

- **A translate data set.** This applies when you select **Scramble Type** 3 ("Translate") with input and output columns and a value data set.
- **A lookup data set.** This applies when you select a **Scramble Type** of 1 ("Random") or 2 ("Repeatable") along with a value data set name. The data set is loaded into memory and the output value is randomly or repeatably selected from one of the loaded records. The output column determines the location of the value that is selected for this field.
- **A value list.** This applies when you select a **Scramble Type** of 1 ("Random") or 2 ("Repeatable") *without* a value data set name and allows you to enter the selection values for this field on the panel displayed when you press Enter. One of the values you provide is randomly or repeatably selected during a copy operation. The values you enter are stored in the template. Value lists are described in more detail later.

Value option deselected (blank)

Deselecting this option scrambles the input field to produce a random or repeatable output value. **Scramble Type** must be set to 1 ("Random") or 2 ("Repeatable").

Specifying value input and out columns

The input column field (**In**) defines the start location of the input field value on the value data set and is used when the translate process is run during a copy operation to match the input field with a value on the value data set. The length of the field is set to the length of the input field that is mapped to this field during the copy process.



Note: This value is only required when you select **Scramble Type** 3 ("Translate").

The output column field **Out** defines the start location of the output field value on the value data set and is used in these ways during a copy operation:

- **Translate.** If an input field value is matched on the value data set, then the corresponding output value is used.
- **Random** or **Repeatable.** The input value is used to randomly, or repeatably, select an output value from the value data set.

The length of the field is the field length as displayed on the Field Attributes panel.



Note: This value is required when you select **Scramble Type** 3 ("Translate").

If you select **Scramble Type** 1 ("Random") or 2 ("Repeatable"), and you have also selected the **Value** option, then the output column defaults to 1 if you have specified a value data set name (**Dsn**).

Specifying range values

When you are specifying scramble options for a numeric field, you can specify a range of values from which the resultant scrambled value is to be selected.

You specify the minimum value of the range in the **Min** field and the maximum value of the range in the **Max** field.

You can only select the range option with random and repeatable scrambling. The output value is randomly or repeatably selected from a number within the specified range.

Specifying a value data set name

The output data set name field **Dsn** defines the value data set. It can be any cataloged sequential, partitioned or VSAM data set containing data that is used to determine the output field value during a copy process.

If you select **Scramble Type 3** ("Translate"), then the data set must contain the input and output values in the locations provided in the input and output columns.

If you select **Scramble Type 1** ("Random") or 2 ("Repeatable"), then the data set must contain the output value in the locations provided in the output column.



Notes:

1. This field is required when you select **Scramble Type 3** ("Translate"). If you select **Scramble Type 1** ("Random") or 2 ("Repeatable"), and also select the **Value** option, then you can optionally provide a data set name. If you leave this field blank having selected the **Value** option, you are prompted to enter the value list to be stored in the template.
2. The value data set record length must be greater than or equal to the field length.

Specifying and editing a value list

A value list is a list of values which is used in conjunction with the scrambling options to select a value with which a field is populated during a copy operation. When the output field is being populated, one of the values in this list is selected. Scrambling options combine the originating value with the random or repeatable seed to select a value from the list.

For random and repeatable scrambling, you can specify a value list inline by leaving the value data set field (**Dsn**) blank and selecting the **Value** option.

To edit the related value list, select the **Value** option and press Enter. FM/IMS displays the Value List Edit panel.

The values you provide must be valid for the corresponding field type. Deleting a value list turns off the value list option on the previous panel.

- To enter hexadecimal values, use the X'hhhh' format:

```
x' C1C2C3'
```

- To provide leading blanks or a blank value, use a quoted string:

```
' SMITH'
```

- Blank value lines (no quotation marks) are ignored.

Use the FIND and LOCATE commands to bring a value containing or starting with a given string to the current line.

You can use prefix commands to copy, insert, move, repeat or delete lines.

To save the values, press F3. To ignore changes, press Cancel.

Specifying scrambling options for date and time fields

You select a field from the Field Selection/Edit panel. To select a field for specifying date and time scrambling options, enter DT in the Cmd field adjacent to the required field. You can enter DT against as many fields as you like. For each field you select, FM/IMS displays a Date/Time Attributes panel.

The scrambling options you can specify are:

- Scramble type (random or repeatable)
- Start and end values for a date and time range

Specifying the scramble type

Select the **Random** option to have FM/IMS produce a random date and time output value on each invocation of the copy process. If the Random option is not selected and range **Start** and **End** values are specified, FM/IMS performs repeatable scrambling where the same date and time output value is produced on each invocation of the copy process.

Specifying range values

Range **Start** and **End** values must be specified for FM/IMS to perform scrambling on the date and time field. The **Start** and **End** values must be entered as date and time values in the output attribute **Format** defined for the field. These values define the range from which FM/IMS can generate scrambled date and time values.

Using views to filter data display

When a view is associated with the database, TABL display mode only shows the data (segment occurrences) associated with one segment type at any one time. This segment type is referred to as the “*currently formatted*” segment type. Selected segment occurrences that are not of the current type are represented by *shadow lines*. These segment occurrences are referred to as the “*suppressed*” segments. Segment occurrences that are of the current type but are not selected are not shown in the view.

Segment occurrences of the current type are selected or not-selected, depending upon how their values match the layout identification and field selection criteria defined in your view.

Changing the currently formatted segment type

Within the currently selected segments, only the currently formatted type is displayed in TABL display mode. All other selected segments are represented by shadow lines. A shadow line can represent one or many segment.

To change a line from being a shadow line to being the currently formatted segment, enter `v` (VIEW) in the **Cmd** line against the segment. The display changes to show the new “*currently formatted*” segments with the field headings from that segment layout.

In SNGL display format, the VIEW command is not needed as the current layout automatically changes to match the segment being displayed as you scroll through the segments. If SHOW SUP OFF is in effect, then suppressed segments are skipped.

In CHAR/HEX/LEX modes the segments are only suppressed if SHOW SUP OFF is used. All segments are displayed if SHOW SUP ON is used.

Showing shadow lines

Shadow lines in FM/IMS can represent two types of segments:

- **Suppressed segments**

A suppressed segment shadow line holds information about one segment type and one layout, and represents all of the segments that match that type and layout. If the suppressed segments have no children, then the shadow line shows how many suppressed segments it is replacing. If there is more than one possible layout for the segments, then the line also shows the segment layout name. If a suppressed segment has child segments, then the shadow line shows only the first 30 bytes of the key field for the segment, and, if there is more than one possible layout, the segment layout name.

- **Not-matched segments**

Not-matched lines show segments that contain data that matches a layout identification criteria, but the segments differ in length from the segment layout.

You can show or hide the shadow lines, by entering the SHOW SUP ON or SHOW SUP OFF command in the Command line.



Note: Suppressed segments are only hidden from display. They are still selected and are still included in any print, copy or create data functions.

A tag under the **Cmd** field indicates why the line was a shadow line:

=ID

Indicates that the segment did not satisfy any of the layout identification criteria.

=LG

Indicates that the segment matches the current layout, but the segment length does not fall within the valid range for this layout.

If all of the fields in the layout are of fixed length, then the “*valid range*” is limited to a single value: that is, the sum of the lengths of all the fields in the layout.

However, if the layout includes any variable-length arrays, then the minimum valid length is the length of a segment with the minimum number of array items allowed by the copybook (which might allow zero items).

The maximum valid length depends on whether the copybook specified an upper limit on the number of array items.

=DA

Indicates that the segment matches the current layout, but one of the following is true:

- (COBOL copybook only.) An ODO object field value is outside of the range allowed by its ODO clause.
- The layout contains one or more variable-length arrays, but the segment length does not match the calculated length of a segment with the number of array items specified by the array size (or “*object*”) fields.

For details on using layouts that include variable-length arrays, see [Support for variable-length arrays on page 93](#).

Specifying field selection criteria

In a view, you can specify field selection criteria for each layout. Field selection criteria determine which segment occurrences FM/IMS selects for display when browsing or editing.

Field selection criteria are also used in extract criteria sets, to determine which segments are extracted when you use Extract (option 3.3). For more information about extract criteria sets, see [Working with Criteria on page 179](#).

To specify field selection criteria, do one of the following actions on the View: Segment Layout panel:

- Enter a freeform REXX expression in the Sel field. You can scroll to the right or left within the field, using the Right (F11) or Left (F10) function keys, or you can expand the field, using the Expand function key (F4).
- Enter the 1 primary command, to display the Field Selection Criteria panel and then build your criteria statement using the fields on this panel. Press the Exit function key (F3) to return to the Segment Layout panel



Note: You cannot enter criteria by field for an array element (a data element with an OCCURS clause in COBOL). Instead, you must use the freeform expression for array element criteria.

Related topics

[Segment Layout panel on page 370](#)

[Field Selection Criteria panel on page 301](#)

[File Manager and REXX on page 118](#)

The effects of selecting and field selection criteria

For a segment to be selected for display, the following conditions must be met:

- The segment type is selected in the View Segment Selection panel **or** the Database Positioning panel.
- The relevant values in the segment satisfy the Layout Identification criteria for a layout of the segment type (set in the Template Segment Layout panel). The layout is called the “*matching*” layout. If there is only one layout, there are no Layout Identification criteria, and the segment is automatically matched with the layout.
- The matching layout is selected for display in the View Segment Layout Selection panel. If there is only one layout, the segment layout is automatically selected.
- The relevant values in the segment satisfy the Field Selection criteria for the matching layout (set in the View Segment Layout panel). The short-hand way of saying this is that the segment satisfies the criteria.
- The parent and child segments of the segment match the field selection criteria for their segments.

If the view contains field selection criteria for a child segment layout, then the parent segment is selected only if at least one child segment satisfies the criteria. If no child segments satisfy the criteria or the parent has no child segments, then the parent segment is not selected.

If a segment fails any of these tests, then it is a not-selected segment, and it is not displayed.

If a segment passes all these tests, but FM/IMS finds that the length of the segment does not match the length of the matching layout, then the segment is displayed as a not-matched shadow line.

The effect of criteria ripples up the database hierarchy. Consider a database hierarchy that has three levels: Level 1 (root segment); Level 2 (child of Level 1); and Level 3 (child of Level 2).

If field selection criteria are specified on the Level 3 segment, then the Level 1 segment is selected only if it has at least one Level 2 child segment that, in turn, has at least one Level 3 child that satisfies the field selection criteria in the Level 3 layout. If criteria is set in each level, the Level 1 segment is only selected when all of these conditions are true:

- The Level 1 segment satisfies the field selection criteria for the Level 1 layout.
- The Level 1 segment has at least one Level 2 child that satisfies the field selection criteria for a Level 2 layout.
- That Level 2 segment has at least one Level 3 child that satisfies the field selection criteria for a Level 3 layout.

The effect of criteria also ripples down the database hierarchy. That is, if the Level 1 (root) segment has two child segment types, and it has no child segments that satisfy the selection criteria in one child type, then none of the second type of child segments are selected either.

If there are two or more layouts for a child segment, then the parent segment is not selected only if all the child segments of either layout are not selected.



Note: When determining if a segment satisfies the field selection criteria, it does not matter whether or not you have chosen to display a child segment type.

Here are some examples, to show you how the selection criteria are applied:

Patient: Si Key

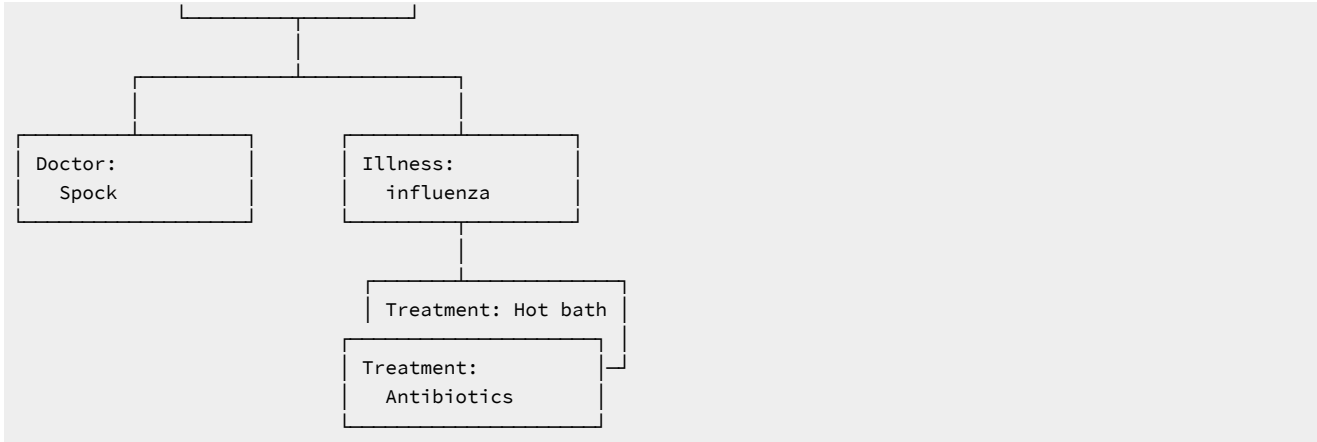

For these examples, the root segment is Patient. It has two child segments, Doctor and Illness, and the Illness segment has two occurrences of its child segment Treatment. Here are some possibilities:

- Example One

Select for display:

- Doctor segment

Supply Field Selection criteria:

- Treatment segment: Treatment=Antibiotics

FM/IMS displays:

- Doctor: Spock segment

- Example Two

Select for display:

- Patient segment

Supply Field Selection criteria:

- Doctor segment: Doctor=Spock
- Treatment segment: Treatment=Vitamin C

FM/IMS displays:

- Nothing. The Doctor segment satisfies its Field Selection criteria. However, there is no Treatment segment to satisfy the Treatment segment Field Selection criteria, which means that no Illness segment is selected, so no Patient segment is selected.

- Example Three

Select for display:

- Patient segment and Illness segment

Supply Field Selection criteria:

- Doctor segment: Doctor=Spock
- Treatment segment: Treatment=Antibiotics

FM/IMS displays:

- Patient: Si Key segment
- Illness: influenza segment

File Manager and REXX

Much of the information in this section has been summarized from the *z/OS TSO/E REXX Reference* and *z/OS TSO/E REXX User's Guide*.

General information about REXX

REXX is a general purpose programming language, similar to PL/I. It includes extensive parsing capabilities for character manipulation, extensive mathematical capabilities, and numerous built-in functions that perform various processing, searching, and comparison functions.

REXX programs are typically run by a language processor (interpreter). That is, the program is run statement-by-statement, without first being translated to another form (compiled). Because of the interpretive nature of REXX, FM/IMS is able to exploit the power of REXX when processing segment identification and field selection criteria.

Although REXX is a powerful and versatile language, coding selection criteria using REXX is straightforward. You do not need to know how to write REXX programs. All you need to know is how to write REXX comparison expressions. FM/IMS takes care of turning your selection criteria into a REXX program.

Using the REXX compiler

If you have the REXX compiler installed, you can improve the performance of REXX processing by including the following DD statement for batch jobs or have the DD allocated for TSO/ISPF sessions:

```
//FMNRXCMP dd DSN=rexx.compiler.lib,DISP=SHR
```

Improving performance using internal expression processing

For simple criteria, FM/IMS can process the expression internally without needing to invoke REXX. This can result in faster processing of layout identification and field selection criteria. If an expression is not eligible for internal processing, FM/IMS displays the message *"REXX required"* when you press Enter on the relevant panel. In this case, you can choose to either modify the expression so that REXX is not required, or use the expression with REXX processing instead of internal processing.

For an expression to be eligible for internal processing, it must consist only of:

- **Literal strings:** These include ordinary quoted strings as well as binary and hexadecimal strings.
- **Numerics:** Unlike REXX, the internal expression processor distinguishes between character and numeric types. To ensure internal processing uses the correct numeric value, enter numeric data as unquoted strings.

For example, the internal expression processor treats the string `5` as a number and compares it equal to any other numeric with a value of five. However, it treats the string `'5'` as character data and compares it equal to a string containing `X'F5'` (with optional leading and trailing blanks for non-strict comparison). REXX treats both strings the same and handles them as character data, but allows them to behave as numbers in appropriate contexts.

Non-floating point numerics are limited to 31 decimal digits, and floating point numerics are limited to the range of numbers that can be stored as a double-precision floating point number.

- **Comparison operators:** The internal expression processor supports all the REXX comparison operators.

The internal processor performs numeric comparisons when both operands are numeric or contain numeric data (formatted references to numeric fields, or FLD references specifying a numeric formatting type); bit comparisons when both operands are bit fields; otherwise, the internal processor performs character comparisons.

Where both operands have the same value, numeric comparisons match regardless of the length and type of the data. Bit comparisons match only when both bit fields are the same. Leading zero-bits are ignored in the longer field if the fields are not the same length. Character comparisons match only if the two strings are identical, except that leading and trailing blanks are ignored by the non-strict operators. The internal expression processor compares character strings byte by byte according to the standard EBCDIC collating sequence and, where a shorter string matches a longer string up to the end of its length, the longer string is deemed to be greater.

- **Logical AND (&) and OR (|) operators:** The only other binary operators that the internal processor allows are the logical AND (&) and inclusive OR (|) operators. You can use the plus (+) and minus (-) operators before decimal numerics (to indicate sign), and before and within floating point numerics as defined by the REXX syntax.
- **File Manager field references:** The internal expression processor supports both formatted and unformatted references.
- **Parentheses**

Related topics

[Overview of REXX expressions on page 119](#)

[Handling floating point numbers on page 122](#)

[Comparison operators on page 123](#)

[Symbols on page 121](#)

Overview of REXX expressions

REXX expressions consist of one or more *terms* interspersed with zero or more *operators* that denote operations to be carried out on terms. Expressions are evaluated left to right, modified by parentheses and by operator precedence in the typical algebraic manner. When parentheses are encountered (other than those that identify function calls) the entire subexpression between the parentheses is evaluated immediately when the term is required. Expressions are wholly evaluated, unless an error occurs during evaluation.

REXX statements are free format. This means you can insert extra spaces between words without causing an error.

The terms you can use in a selection criteria expression are described below. The operators you can use are described on following panels.

Literal strings

A literal string is a sequence including any characters and delimited by the single quotation mark (') or the double quotation mark ("). Use two consecutive double quotation marks (") to represent a " character within a string delimited by double quotation marks. Use two consecutive single quotation marks (') to represent a ' character within a string delimited by single quotation marks. A literal string is a constant and its contents are never modified when it is processed.

These are valid strings:

```
'Fred'
"Don't Panic!"
'You shouldn't' /* Same as "You shouldn't" */
```

Note that a string followed immediately by a (is considered to be the name of a function. If followed immediately by the symbol x or x it is considered to be a hexadecimal string. If followed immediately by the symbol B or b it is considered to be a binary string.

A hexadecimal string is a literal string, expressed using a hexadecimal notation of its encoding. It is any sequence of zero or more hexadecimal digits (0-9, a-f, A-F), grouped in pairs. A single leading 0 is assumed, if necessary, at the front of the string to make an even number of hexadecimal digits. The groups of digits are optionally separated by one or more blanks, and the whole sequence is delimited by single or double quotation marks, and immediately followed by the symbol X or x. (Neither x nor X can be part of a longer symbol). A hexadecimal string is a literal string formed by packing the hexadecimal digits given. Packing the hexadecimal digits removes blanks and converts each pair of hexadecimal digits into its equivalent character, for example:

```
'Cl'X A.
```

With hexadecimal strings you can include characters in a program even if you cannot directly enter the characters themselves. These are valid hexadecimal strings:

```
'ABCD'x
"1d ec f8"X
"1 d8"x
```

A binary string is a literal string, expressed using a binary representation of its encoding. It is any sequence of zero or more binary digits (0 or 1) in groups of 8 (bytes) or 4 (nibbles). The first group might have fewer than four digits; in this case, up to three 0 digits are assumed to the left of the first digit, making a total of four digits. The groups of digits are optionally separated by one or more blanks, and the whole sequence is delimited by matching single or double quotation marks and immediately followed by the symbol b or B.

A binary string is a literal string formed by packing the binary digits given. If the number of binary digits is not a multiple of eight, leading zeros are added on the left to make a multiple of eight before packing. Using binary strings, you can specify characters explicitly, bit by bit.

These are valid binary strings:

```
'11110000'b      /* == 'f0'x          */
"101 1101"b      /* == '5d'x          */
'1'b             /* == '00000001'b and '01'x */
'10000 10101010'b /* == '0001 0000 1010 1010'b */
'b              /* == ''            */
```

Symbols

Character strings, without quotation marks, which are translated to uppercase. Any symbol that begins with a # is treated as a reference to a field in the segment being processed, and the value of the field is used. All other symbols are treated as constants.

FM/IMS assigns to each field defined in a template a unique field reference number. When you want to refer to a field in a selection criteria expression, you specify the field's field reference number prefixed by #. Note that you can only refer to fields defined in the segment you are currently working with. You cannot refer to fields defined in a different segment type. Note also that, in segment identification criteria, you can only refer to fields defined in the static portion of the segment (that is, the portion of the segment that precedes any variable-length array defined with the OCCURS DEPENDING ON clause).

REXX expression evaluation only processes data in the form of “*typeless*” character strings (typeless because they are not, as in the case of COBOL, of a particular data type such as binary, packed-decimal, and so forth). Therefore, when you refer to a numeric field, FM/IMS converts the value of the field to a numeric character string that can be processed by REXX when evaluating the selection criteria expression. The number of integer and decimal digits in the character string is determined by the field definition in your template. For example, if you refer to a packed-decimal field with a COBOL or PL/I PICTURE clause of 999V99, FM/IMS converts the value of the field to a character string consisting of numeric digits, a period for the virtual decimal place, and, if the value of the field is negative, a leading sign character (such as -123.45). Note that all numeric fields are treated as signed, regardless of whether the COBOL or PL/I PICTURE clause contains a sign symbol.

Occasionally, you might want to evaluate the value of a numeric field without converting it to a numeric character string. To do this, prefix the field reference number by #u instead of #. This tells FM/IMS not to convert the number to a numeric character string. For example, if you want to test a two-byte binary numeric field (with a field reference number of 45) for a special value of X'FFFF', you can code:

```
#u45 = 'FFFF'x
```

When you refer to a field in an array, you must qualify the field reference with the required number of subscripts enclosed in parentheses and separated by commas. The number of subscripts you specify must equal the number of dimensions in the array that contains the field you are referencing. In COBOL terms, there must be a subscript for each OCCURS clause in the hierarchy containing the field, including any OCCURS clause for the field itself. Each subscript you specify must be a positive integer in the range 1 to the maximum number of occurrences of the field as specified in the OCCURS clauses. If the field you refer to is in a variable-length array (specified using the OCCURS DEPENDING ON clause), you should ensure that you do not refer to an occurrence of the field that, for any given segment, might not exist. If you do refer to a non-existent field, the selection criteria is not satisfied, and the segment is not selected.



Note: The object of an OCCURS DEPENDING ON clause must be defined as a field in the static portion of the same segment as the array (that is, the portion of the segment that precedes any variable-length array defined with the OCCURS DEPENDING ON clause). If the object of the OCCURS DEPENDING ON clause is not so defined, you cannot refer to any fields in the array or any fields in the segment that follow the array.

Function call

A call to REXX built-in function.

Subexpressions

Terms in an expression bracketed within left and right parentheses.

Handling floating point numbers

The internal expression processor operates on internal floating point fields in their native, hexadecimal floating point format. External floating point fields are converted to double-precision internal format before being processed as if they were internal floating point fields. If two fields in a comparison have different precisions, then the field with the greater precision is rounded to the lesser precision, and the comparison is performed using the lesser precision. Because internal floating point fields are converted to external (decimal) format and passed to REXX as strings, and external floating point fields are also passed as strings, the result of evaluating a comparison can differ between REXX and the internal expression processor.

To ensure consistency, pay attention to the following points when coding expressions involving floating point fields:

- When comparing a floating point field to a constant, make sure you use a constant that matches the external representation used by FM/IMS. For example, `-2.2527494E+08` and `-2.2527495E+08` are both stored as `'C7D6D6C4'` when entered for a single-precision floating point field, but FM/IMS always displays the data as `-2.2527494E+08`. Using either value matches with the internal expression processor, but only `-2.2527494E+08` matches with REXX.
- Use hex strings and unformatted field references instead of external format to precisely represent internal floating point values. For example, instead of `#2 = -2.2527494E+08` you can use `#U2 = x2c(C7D6D6C4)`. This technique can only be applied if your expression requires REXX, because the `x2c()` function is not processed internally.
- Comparing floating point fields with different precisions using REXX might not produce the results expected because the external representations of floating point numbers with values that match (with or without rounding) but with different precisions are generally not the same. For example, the external representation of `'C7D6D6C4'x (-2.2527494E+08)` is different from that for `'C7D6D6C4 00000000'x (-2.2527494400000000E+08)` because the extra precision of the field produces a more precise external representation. This situation, where the internal values match exactly can be handled in REXX by truncating the longer field (assuming `#2` refers to a short float and `#3` refers to a long float):

```
#U2 = Substr(#U3,1,4)
```

Simulating the rounding process to achieve the same results as the internal processor, and therefore achieving a more general test of equality between fields of different precision requires the following extraordinary expression:

```
#U2 = d2c(c2d(Substr(#U3,1,4))+Substr(x2b(c2x(Substr(#U3,5,1))),1,1),4)
```

This works by:

- Truncating the long float to four bytes and converting it to decimal.
- Adding the high-order byte of the discarded half of the characteristic.
- Converting the result back to internal format.

The addition is valid because the characteristic is in the rightmost bits of the field, and any carry from the addition increments the mantissa as required. The only case it does not handle is that of exponent overflow.

Comparison operators

REXX comparison operators compare two terms and return the value 1 if the result of the comparison is true, or 0 otherwise. Comparison operators can compare numbers or character strings. The most commonly used comparison operators are:

Operator

Meaning

=

Equal

≠, \=

Not equal

<

Less than

≧, \<

Not less than

>

Greater than

≦, \>

Not greater than

<=

Less than or equal to

>=

Greater than or equal to

><

Greater than or less than (same as not equal)

<>

Less than or greater than (same as not equal)

Note that the `not` character (`↯`), is synonymous with the backslash (`\`). You can use the two characters interchangeably.

When comparing terms using these comparison operators, if both terms in the expression are numeric, REXX performs a numeric comparison. Otherwise, both terms are treated as character strings and REXX performs character comparison. (A number in REXX is a string that contains one or more decimal digits, an optional decimal point, and an optional leading sign character. The string can contain one or more leading or trailing blanks, and the sign character can be separated from the digits by one or more blanks.)

In a character comparison, leading and trailing blanks are ignored, and the shorter string is padded with blanks on the right. Character comparisons are case-sensitive. Therefore, you should delimit character strings with quotation marks to prevent lowercase characters being translated to upper case. For example, if the field #4 contains the value `MixedCase` both the following comparison operations would be true:

```
#4 = 'MixedCase'
#4 = '  MixedCase  '
```

but the following comparison operation would not be true:

```
#4 = MixedCase
```

In numeric comparisons, the comparison is effected by subtracting the two numbers (calculating the difference) and then comparing the result with 0. For example, the comparison operation:

```
#6 = 10
```

is identical to the operation:

```
(#6 - 10) = 0
```

In addition to these comparison operators, REXX provides a number of “*strict*” comparison operators that are mainly intended for use when comparing character strings. The strict comparison operators all have one of the characters defining the operator doubled, such as `==` (strictly equal).

The strict comparison operators are:

Operator

Meaning

`==`

Strictly equal

`-==, \==`

Strictly not equal

`<<`

Strictly less than

`-<<, \<<`

Strictly not less than

`>>`

Strictly greater than

`->>, |>>`

Strictly not greater than

`<<=`

Strictly less than or equal to

`>>=`

Strictly greater than or equal to

When you use the `==` comparison operator (strictly equal), the two character strings being compared must be identical (character by character) and of the same length to be considered strictly equal. Leading and trailing blanks are significant. For example, continuing the example using field `#4` that contains the value `MixedCase` only the first of the following comparison operations would be true:

```
#4 == 'MixedCase'
#4 == '  MixedCase  '
```

Similarly, the strict comparison operators such as `>>` or `<<` carry out a simple character-by-character comparison, with no padding of either of the strings being compared. The comparison of the two strings is from left to right. If one string is shorter than and is a leading substring of another, then it is smaller than (less than) the other. The strict comparison operators do not attempt to perform a numeric comparison on the two terms, and should not be used to compare numeric fields.

Arithmetic operators

You can process numeric terms in comparison expressions using the arithmetic operators:

Operator

Meaning

`+`

Add

`-`

Minus

`*`

Multiply

`/`

Divide

`%`

Integer divide (divide and return the integer part of the result)

`//`

Remainder (divide and return the remainder—not modulo, because the result might be negative)

Power (raise a number to a whole-number power)

Prefix -

Same as the subtraction: `0 - number`

Prefix +

Same as the addition: `0 + number`

You can use these operators to produce an intermediate result that you can compare with another term. For example, if the field #6 contains a numeric value representing an employee's annual salary, and the fields #15 and #23 contain numeric values representing the employee's annual travel allowance and annual bonus, respectively, you can select segments for employees with a combined annual payment of greater than \$100,000 using this comparison:

```
(#6 + #15 + #23) > 100000
```

For another example, if field #45 contains the number of sick days an employee is entitled to annually, and the field #46 contains the number of sick days an employee has used in the current year, you can select segments for employees who have used 50% or more of their sick days entitlement using this comparison:

```
(#46 / #45) >= .5
```

Note that in each of these examples, the arithmetic subexpression is contained in parentheses. This ensures that the entire subexpression is evaluated before the comparison operation.

The order of precedence of arithmetic operators is as follows (highest is at the top):

Operator

Meaning

**+ - - **

Prefix operators

Power

*** /**

Multiply and divide

+ -

Add and subtract

For example, * (multiply) has a higher priority than + (add), so `3+2*5` evaluates as `13` (rather than the `25` that would result if strict left to right evaluation occurred). To force the addition to occur before the multiplication, you can rewrite the expression as `(3+2)*5`. Adding the parentheses makes the first three tokens a subexpression.

Logical (Boolean) operators

REXX comparison expressions return a true (1) or false (0) value when processed. Logical operators combine two comparisons and return the true (1) or false (0) value depending on the results of the comparisons.

The logical operators are:

Operator

Meaning

&

AND

Returns 1 if both comparisons are true. For example:

```
(4 > 2) & (a = a)      /* true, so result is 1 */
(2 > 4) & (a = a)      /* false, so result is 0 */
```

|

Inclusive OR

Returns 1 if at least one comparison is true. For example: `(4 > 2) | (5 = 3) /* at least one is true, so result is 1 */` `(2 > 4) | (5 = 3) /* neither one is true, so result is 0 */`

&&

Exclusive OR

Returns 1 if only one comparison (but not both) is true. For example:

```
(4 > 2) && (5 = 3)     /* only one is true, so result is 1 */
(4 > 2) && (5 = 5)     /* both are true, so result is 0 */
(2 > 4) && (5 = 3)     /* neither one is true, so result is 0 */
```

Prefix - \

Logical NOT

Returns the opposite response. For example:

```
\ 0:                  /* opposite of 0, so result is 1 */
\ (4 > 2)              /* opposite of true, so result is 0 */
```

Logical expressions are used in complex comparisons and can be and can act as checkpoints to stop unwanted conditions (such as testing a field for a value of zero before using it as a divisor). When you have a series of logical expressions, for clarification, use one or more sets of parentheses to enclose each expression. For example:

```
(#46 = 999) | ((#45 > 0) & (#46 / #45) >= .5)
```

Useful functions

REXX provides a rich set of built-in functions, including character manipulation and conversion functions. Some of these functions might be of use when you are writing your comparison expressions. They are described in the following list. FM/IMS also provides some functions that might be of use. They are also described in the following list. To call a function,

type the function name directly followed by one or more arguments within parentheses. There can be no space between the function name and the left parenthesis. For example:

```
function(arguments)
```

A function call can contain up to 20 arguments separated by commas. Each argument can be one or more of the following:

Argument

Example

Blank

```
function()
```

Constant

```
function(55)
```

Symbol

```
function(#5)
```

Literal string

```
function('With a literal string')
```

Option recognized by function

```
function(option)
```

Another function

```
function(function(arguments))
```

Combination of argument types

```
function('Literal string', #5, option)
```

Some of the built-in functions provided by REXX that you might find useful are:

ABS

►► **ABS** — (*number*) —◄◄

Returns the absolute value of *number*. For example, if you want to select segments in which field #12 contains a value in the range -10 to +10, you can specify:

```
ABS(#12) <= 10
```

MAX

►► **MAX** — (— *number* —) —◄◄

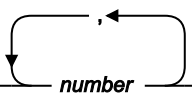

Returns the largest number from the list specified. For example, if you want to select segments in which any of fields #10, #11, or #12 contains a value greater than 55, you can specify:

```
MAX(#10, #11, #12) > 55
```

MIN

►► **MIN** — (— *number* —) ►►

Returns the smallest number from the list specified. For example, if you want to select segments in which any of fields #10, #11, or #12 contains a value less than 0, you can specify:

```
MIN(#10, #11, #12) < 0
```

POS

►► **POS** — (— *needle* — , — *haystack* —) ►►

Returns the position of one string, *needle*, in another, *haystack*. Returns 0 if *needle* is a null string, or is not found in *haystack*, or if *start* is greater than the length of *haystack*. By default the search starts at the first character of *haystack* (that is, the value of *start* is 1). You can override this by specifying *start* (which must be a positive whole number), the point at which the search starts. For example, if you want to select segments in which any character in field #22 is a blank, you can specify: `POS(' ', #22) > 0`

SUBSTR

►► **SUBSTR** — (— *string,n* —) ►►

Returns the substring of *string* that begins at the *n*th character and is of length *length*, padded with *pad* if necessary. *n* is a positive whole number. If *n* is greater than the length of *string*, then only pad characters are returned.

If you omit *length*, the rest of the string is returned. The default *pad* character is a blank.

For example, if you want to select segments in which characters 4-6 of field #22 are the string 'NOT', you can specify:

```
SUBSTR(#22,4,3) = 'NOT'
```

REXX examples

Here are examples of REXX comparison expressions:

Example 1

Select segments in which the transaction date (field #14) is any date in July 2000, or the transaction value (field #27) is greater than \$100,000.00

```
(#14 >= 20000701 & #14 < 20000801) | #27 > 100000.00
```

Example 2

Select segments in which the count of credit notes (field #62) is greater than 10% of the count of invoices (field #61)

```
#62 > #61/10
```

Example 3

Select segments in which the employee identifier (field #17) starts with any of the letters A, C, or E.

```
CO(SUBSTR(#17,1,1), 'A', 'C', 'E')
```

Example 4

Select segments in which the supplier number (field #23) is 997644 or 997645, and the item description (field #33) contains the word 'CABINET'

```
NCO(#23,997644,997645) & CO(#33, 'CABINET')
```

Example 5

Select segments in which the 4-byte packed decimal field starting at position 17 in the segment contains a negative value

```
FLD(17,4,P) < 0
```

Example 6

Select segments in which either the transaction value (field #27) is greater than \$50,000.00 and the purchase order number (field #25) starts with characters other than 'TX', or the transaction value is greater than \$70,000 and the supplier number (field #23) is 984545, but not if both sets of conditions are true

```
(#27 > 50000.00 & SUBSTR(#25,1,2) != 'TX') &&  
(#27 > 70000.00 & #23 = 984545)
```

Chapter 6. Editing data

You can use FM/IMS to find and change segment data in an IMS database. You can also insert, copy, delete and otherwise modify segment occurrences.

The major tasks described in this chapter are:

[Committing changes to your database on page 131](#)

[Changing data on page 134](#)

[Finding and changing strings on page 135](#)

Committing changes to your database

When you are editing a database, your changes are held in IMS buffers until they are written to the database data set files, in a process called *committing* your data.

As you first enter the Database Positioning panel during the Edit dialog, FM/IMS issues a checkpoint, marking the current state of the segment data. Each time that you commit your data (via a SAVE or EXIT command, or when FM/IMS automatically saves the data for you), a new checkpoint is issued. At any time up until you commit the data, you can revert to the last checkpoint position by undoing or canceling your changes. If you are working in DLI mode and the Dynamic Backout option is selected, FM/IMS reverts to the last checkpoint position when an abend occurs. If you are working in BMP mode, this rollback occurs automatically.

The point at which data is committed to the database depends upon the setting of the AUTOSAVE option.

- If AUTOSAVE is set to OFF, your changes are stored in the IMS buffers as you work, but not committed to the database until you issue a SAVE command or you exit from the Database Positioning panel. You can change more than one segment occurrence at a time and change occurrences in more than one segment type before committing the changes to the database.
- If AUTOSAVE is set to ON, your changes are automatically committed to the database when the number of changes recorded in a counter reaches the value specified in either the Edit Checkpoint Frequency field or the Change All Checkpoint Frequency field in the DLI Mode Options panel (option 0.6.4) or the BMP Mode Options panel (option 0.7.2).



Note: If you are working in DLI mode and are using a Static PSB that does not have an I/O PCB, AUTOSAVE is not available and the SAVE, UNDO and CANCEL commands are not active. Your changes can only be committed to the database or cancelled when you leave the Database Positioning panel. Use the Exit function key (F3) from that panel to save your changes; use the Cancel function key (F12) to discard your changes.

The tasks described in this section are:

- [Setting your checkpoint frequency on page 132](#)
- [Using AUTOSAVE on page 133](#)
- [Undoing your changes on page 133](#)

Concurrent editing and data locks

When you are viewing or editing records in a multi-user environment, there is always the possibility that more than one person is using the same database at the same time. The FM/IMS Browse and Edit functions are designed to release data locks whenever control is returned to the user, to allow for concurrent user access. This is true for both DLI and BMP access modes.

Since FM/IMS does not hold locks on the current database record during user interactions, it uses other mechanisms to ensure that the data being changed has not been updated by other users during your read and editing operations. The mechanism is:

- When you display data in your Editor, FM/IMS creates a copy of the data in memory.
- When you request a change to the data, such as overtyping some details and pressing Enter, FM/IMS creates another copy of the requested changes and then performs an integrity check. In this check, FM/IMS:
 - Reads the segment as stored in the database again
 - Compares this segment to the original copy in memory (that is, before you made changes).
 - If the two segment versions are the same, the requested changes are stored in the IMS buffers and an update lock is issued on the database record.

If they are not the same, that is someone else has modified the segment between the time that you initially read the data and the time that you attempted to change it, FM/IMS issues a warning and does not store the requested change.

- The update lock remains on the database record until the changes have been committed to the database, at which point the lock is released. To minimize the locking time and ensure that the latest updated database records are available to other users, you can use the AUTOSAVE option with an Edit Checkpoint Frequency of 1. This instructs FM/IMS to commit any updates immediately upon passing the integrity check, effectively releasing the lock as soon as you enter the changes.

Setting your checkpoint frequency

FM/IMS uses three types of checkpoint frequency counters:

Edit Checkpoint Frequency

When AUTOSAVE is on, FM/IMS increments a count by 1 each time you press an action key (for example, Enter, a scroll key such as F8 or F7, and so on) and data changes have been requested. When the counter is equal to the number specified in the **Edit Checkpoint Frequency** field, FM/IMS commits the data, issues a checkpoint and resets the counter.

Change All Checkpoint Frequency

Because the CHANGE ALL command can affect so many segments in one action, the number of segments that are changed are recorded in a separate counter. When AUTOSAVE is on, FM/IMS increments this count by 1 each time a segment is updated during a CHANGE ALL operation and commits the data, issues a checkpoint and resets the counter when the count is equal to the number specified in the **Change All Checkpoint**

Frequency field. If a checkpoint is issued at any point during a CHANGE ALL operation, a final checkpoint is issued at the end of the operation, so that you cannot roll back to a point midway through the changes.

Batch Checkpoint Frequency

This value is used to determine the frequency of checkpoints when running a File Manager/IMS batch update job. FM/IMS increments a count by 1 each time your batch update job updates, deletes or inserts a segment and issues a checkpoint when the count is equal to the number specified in the **Batch Checkpoint Frequency** field.

To set your checkpoint frequencies:

1. From the Primary Option Menu, select option **0 Settings** and then option 6 Subsystem. The Subsystem Settings Menu is displayed. On this panel, select either option **4 DLI mode Options** if you want to change the DLI mode settings, or option **6 BMP mode Options** if you want to change the BMP mode settings and enter in the **Subsystem name** field, the ID of the subsystem that you want to set your options for. Then press Enter to display either the DLI Mode Options or BMP Mode Options panel.
2. Enter a value between 1 and 99 in the **Checkpoint Frequency: Edit** field. In a production environment, it is common to have a checkpoint frequency of 1.

The value is used in DLI mode. It is also used in BMP mode when your installation allows you to change the autosave settings of the IMS subsystem.

3. Enter a value between 1 and 9,999 in the **Checkpoint Frequency: Change all** field.

The value is used in DLI mode. It is also used in BMP mode when your installation allows you to change the autosave settings of the IMS subsystem.

4. Enter a value between 1 and 99,999 in the **Checkpoint Frequency: Batch** field.
5. Press the Exit function key (F3) to save your changes and return to the Subsystems Settings menu.

Using AUTOSAVE

To turn Autosave on, enter the `AUTOSAVE ON` command in the Command line of the IMS Data panel or Insert Segment panel. When this command is set on, FM/IMS displays a message in the top right corner of the panel, each time a checkpoint is written, for example:

```
CHKPT FM000005 written
```

To turn Autosave off, enter the `AUTOSAVE OFF` command in the Command line.

Undoing your changes

You can undo your editing changes back to the last point that the data was committed to the database. This is the most recent of:

- the last time you exited from the Database Positioning panel,
- the last time you issued the SAVE command, or
- the last time a checkpoint was issued.

To undo your changes, enter the UNDO command on the Command line of the IMS Data panel.

You can also discard your changes by using the CANCEL primary command to exit from the Database Positioning panel. At that point, you are asked to confirm that you want to discard your uncommitted data changes.



Note: Using the CANCEL command from the IMS Data panel only discards those changes that have not yet been processed. Changes to data are processed when you press Enter, issue a command or use a function key that issues a command (for example, the F10 key issues the LEFT command). Using CANCEL from the IMS Data panel does NOT discard changes that have been processed. To discard these changes, you must CANCEL from the Database Positioning panel.

Related topics

[CANCEL primary command on page 436](#)

[UNDO primary command on page 503](#)

Changing data

When editing data, you can change the data in individual segments by overtyping the old data with new text. This method is useful when you need to make ad hoc changes to specific segments.

The tasks described in this section are:

- [Changing data in individual segments on page 134](#)
- [Editing size fields in variable-length segments on page 135](#)

Changing data in individual segments

Your ability to make editing changes is controlled by the logical rules for database insert and deletes specified in your DBD. If you are using a Static PSB, your ability to access and change segments might also be limited.

As a general rule, you cannot change the data in a key field. If you have not changed your installation default colors, key fields are displayed in white text and editable fields in green text.

To change the data in an individual segment:

1. From the Database Positioning panel, use the `x` prefix command to select the segment types that you want to display on the IMS Data panel.
2. Type an `s` in the Cmd field for the segment type that you want to make the currently formatted segment type, then press Enter.

3. On the IMS Data panel, scroll to view the segment that you want to change, then move your cursor to the position where you want to start editing the text.

This can be done with your mouse or arrow keys or by using the LOCATE or FIND commands.

4. Overtyping the existing text with your changes or insert or delete characters.
5. Press Enter. If any change that you make violates the database rules, a message is displayed at this point and you must modify your changes until they satisfy the database rules.
6. Repeat steps 3 - 5 for each segment that you want to change.
7. When you are ready to commit your changes, enter the SAVE primary command.

The changes you have made are not committed to the database until a SAVE command is issued on the IMS Data panel or Database Positioning panel, or until you EXIT from the Database Positioning panel, or until the next automatic checkpoint is issued (if AUTOSAVE has been turned on).



Note: On some keyboards, the Enter function is assigned to the right Ctrl key (the Enter key on these keyboards acts as a Return key).

When you type in a File Manager/IMS Edit session, the default keyboard behavior is to overwrite existing text. You can change this behavior to inserting text by pressing the Insert key. Characters can be deleted using the Delete or Backspace keys. Care must be taken when using inserting or deleting in CHAR, HEX, or LHEX display formats, as inserted characters “push” subsequent characters to the right, so that they no longer fit into the starting column of fields. While this is not problematic when working with a view, it can cause data to become corrupt if a view has not been used to format the fields.

Editing size fields in variable-length segments

Variable-length segments begin with a 2-byte binary numeric “*size field*”. In SNGL or TABL display format, if you change the value of the size field, and the new value is within the minimum and maximum lengths allowed for the segment, then FM/IMS changes the segment length to match the new value. However, if the new value is less than the minimum allowed segment length (the length of the sequence field, if any, plus 2 bytes for the size field itself) or greater than the maximum allowed segment length (as defined in the DBD), then FM/IMS displays an error, does not change the segment length, and restores the size field to its previous value.

Finding and changing strings

You can use the FIND primary command to locate a string within selected segments in your database. You can use the CHANGE command to find a string multiple segments and replace it with another string. The FIND command is available on the IMS Data panel; the CHANGE command is available on the IMS Data panel when you are in Edit.

Automatic scrolling is performed, if necessary, to bring the string into view and the cursor is placed at the beginning of the string or field. The operands available and the operation of the FIND and CHANGE commands depends on whether a view is being used and if a view is used, the current setting of SHOW SUP ON (exposed data in group lines) or SHOW SUP OFF (grouped segments represented by a single line).

The effects of these changes can be limited by using command parameters or by applying limiting methods (see [Limiting the search in FIND or CHANGE on page 139](#)).

The tasks described in this section are:

- [Sequence of searched segments on page 136](#)
- [Finding a string on page 136](#)
- [Finding invalid data on page 137](#)
- [Handling long strings in FIND on page 138](#)
- [Changing strings on page 138](#)
- [Handling long strings in CHANGE on page 139](#)
- [Limiting the search in FIND or CHANGE on page 139](#)

Sequence of searched segments

When you specify the NEXT, FIRST, or ALL parameter with the FIND or CHANGE primary commands, FM/IMS searches in a forward direction from the first segment within the search range toward the last. In a forward direction, the FIND and CHANGE primary commands read the latest data from the database.

When you specify the PREV parameter with the FIND or CHANGE primary commands, FM/IMS searches in a backward direction from the last segment within the search range toward the first.



Note: When you specify the PREV parameter, it restricts the search range to those segments between the top of the sliding window and the segment at the cursor position. The reason for this is that IMS does not support reads in the backward direction, so FM/IMS mimics the backward search by examining segment locations that were stored in the sliding window as a result of your navigation actions. As a result, when you use the FIND or CHANGE primary commands in a backward direction FM/IMS may use segment information that is outdated and different from the actual database.

Related topics

[CHANGE primary command \(Edit only\) on page 440](#)

[FIND primary command on page 455](#)

Finding a string

To search the data for a specific string, use the FIND primary command (which you can abbreviate as F or /).

For example, to search for the next occurrence of the string “James” in any mix of uppercase and lowercase, enter the following on the command line:

```
F JAMES
```

To move the cursor to the next occurrence of the search string, press the RFind function key (F5).

To find the same string as you specified on the previous FIND primary command, specify an asterisk (*) as the search string.

To limit the search for a string to only where it appears as a prefix in the data, specify the PREFIX parameter.

To limit the search for a string to only where it appears as a suffix in the data, specify the SUFFIX parameter.

To limit the search for a string to only where it appears as a "word" in the data, specify the WORD parameter.

Related topics

[FIND primary command on page 455](#)

[RFIND primary command on page 489](#)

Finding invalid data

To find errors in your data (without correcting them), you can enter the FE (Find Error) primary command. The cursor is placed at the beginning of the string in error. Automatic scrolling is performed, if necessary, to bring the string into view.

To find *and change* numeric fields flagged as being in error (all asterisks in the field display) to a specific numeric value, use the CE primary command.

Related topics

[Changing invalid numeric fields in your data on page 137](#)

[FE \(Find Error\) primary command on page 454](#)

Changing invalid numeric fields in your data

To change an invalid numeric field in your data (all asterisks shown in the field display) to a specified numeric value, you can enter the CE (Change Error) primary command.

The find argument for the CE command is assumed to be a numeric field in error.

When a numeric field in error is found, it changes the field to the string specified in the CE command. The specified string must, of course, be a valid numeric value.

To change the next field in error (to the same value), either enter the CE command again, or press the RFind function key (F5).

To just *find* numeric fields flagged as being in error (without changing them), use the FE primary command.

Related topics

[CE \(Find Error\) primary command on page 438](#)

[FE \(Find Error\) primary command on page 454](#)

[IMS data panel on page 309](#)

Handling long strings in FIND

For character columns (CHAR, VARCHAR), you can specify a search string up to 100 characters long. However, when you are dealing with a long search string, you may find that you cannot fit the whole FIND command (including other parameters) on the command line. To overcome the problem, do one of the following to display an Extended Command Entry pop-up panel:

- Enter `FX` (for Find Extended)
- Enter the FIND command (or one of its abbreviations, such as F or /) *with no parameters*

The Extended Command Entry pop-up panel contains five lines (each 50 characters long) that you can use to enter all the FIND command parameters (but not the actual keyword FIND or any of its abbreviations). FM/IMS treats the five lines on the pop-up panel as contiguous, allowing you to specify a long search string and optionally any other parameters, using up to 250 characters in total.



Note: You can continue the search string (or any other parameter) from the last position on one line of the pop-up panel to the first position of the next line. However, this does not mean that you need to completely fill a line before using the next line. For example, you can specify the search string on the first of the five lines, and the FM/IMS field number (specified as #*n*) on the next line. If you do not use all of a line, FM/IMS treats the unused part of the line as a single space.

Changing strings

When you are *editing* data, you can change data in multiple segments, by entering the CHANGE primary command.

For example, to change the next occurrence of the string "JAMES?" to "JIMMY?", enter the following on the Command line:

```
C JAMES JIMMY
```

To change the next occurrence of the search string, enter the RChange command.

To change all occurrences of "JAMES?" to "JIMMY?", enter the following on the Command line:

```
C ALL JAMES JIMMY
```

To find the same string as you specified on the previous CHANGE primary command, specify an asterisk (*) as the search string.

To use the same replacement string as you specified on the previous CHANGE primary command, specify an asterisk (*) as the replacement string.

To limit the search for a string to only where it appears as a prefix in the data, specify the PREFIX parameter.

To limit the search for a string to only where it appears as a suffix in the data, specify the SUFFIX parameter.

To limit the search for a string to only where it appears as a "word" in the data, specify the WORD parameter.

Related topics

[CHANGE primary command \(Edit only\) on page 440](#)

[RCHANGE primary command on page 485](#)

Handling long strings in CHANGE

For character columns (CHAR, VARCHAR), you can specify “*from*” and “*to*” strings (*from_string* and *to_string*) up to 100 characters long. However, when you are dealing with long strings, you may find that you cannot fit the whole CHANGE command (including other parameters) on the command line. To overcome the problem, do one of the following to display an Extended Command Entry pop-up panel:

- Enter `cx` (for Change Extended)
- Enter the CHANGE primary command (or one of its abbreviations, such as C) *with no parameters*



Note: If you have previously used the CHANGE or FIND commands in the current Browse or Edit session, use the RESET command before entering the CHANGE command. Alternatively, enter `cx`.

The Extended Command Entry pop-up panel contains five lines (each 50 characters long) that you use to enter all the CHANGE command parameters (but not the actual keyword CHANGE or any of its abbreviations). FM/IMS treats the five lines on the pop-up panel as contiguous, allowing you to specify long “*from*” and “*to*” strings, the FM/IMS column number and optionally any other parameters, using up to 250 characters in total.



Note: You can continue a string (or any other parameter) from the last position on one line of the pop-up panel to the first position of the next line. However, this does not mean that you need to completely fill a line before using the next line. For example, you can specify the “*from*” string on the first of the five lines, the “*to*” string on the next line, and the FM/IMS column number (specified as #*n*) on the next line. If you do not use all of a line, FM/IMS treats the unused part of the line as a single space.

[Figure 123: Extended Command Entry pop-up panel for the CHANGE command on page 448](#) shows the Extended Command Entry pop-up panel for the CHANGE command. In this example, any occurrences of the string “*The Cappuccino Strip*” in FM/IMS are to be changed to the string “*LONG AND WINDING ROAD*” for non-excluded rows only.

Related topics

[CHILD primary command on page 448](#)

Limiting the search in FIND or CHANGE

When you use the FIND or CHANGE primary commands, the search may be applied to the entire segment type. Both of these commands have parameters that allow you to limit the effect of the command.

Limiting the search range

When you issue the FIND or CHANGE primary command, you can limit the range of the search by specifying either a *range* parameter or by means of the *scope* setting.

The following table shows the search range for each range parameter.

FIND or CHANGE range parameter	Search range
RECCURREC	All available segments within the current root record
NORECDBALLALLREC	All available segments within the database
CHILDDEP	All segments that are dependents of the segment at or closest to the cursor position
Not used	If scope setting is "DB", all available segments within the database. If scope setting is "REC", all available segments within the current root record.

There are two ways to change the scope setting:

- Use the SCOPE primary command:
 - To limit the search to within a database record, issue the command `SCOPE REC`.
 - To allow the search across all database records, issue the command `SCOPE DB`.
- Use the **Set SCOPE REC, limiting segments to within a database record** option on the Editor Options panel (0.5):
 - To limit the search to within a database record, select this option.
 - To allow the search across all database records, deselect this option.

Related topics

[CHANGE primary command \(Edit only\) on page 440](#)

[FIND primary command on page 455](#)

Limiting the search to specified columns

By default, in SNGL or TABL display formats, if you enter the CHANGE or FIND command without specifying any field references, FM/IMS searches all the visible fields based on the template attributes for each field.

You can override this method of searching by specifying a pair of column numbers, indicating the first and last columns to be searched when you enter the primary command.



Note: When you specify a column range, all fields in the segment type are searched as if they were character fields. For numeric fields, This can cause unexpected results.

The string is found if it is completely contained within the specified column range.

The following command finds the next segment containing the string "Exact" within columns 1 to 20.

```
FIND 'Exact' 1 20
```

Related topics

[CHANGE primary command \(Edit only\) on page 440](#)

[FIND primary command on page 455](#)

Limiting the search to specified fields

In SNGL or TABL display format, you can optionally limit the effects of primary commands to a specified field, a list of fields, or one or more ranges of fields. (You *cannot* specify field references in other display formats.)

The following command finds the next segment containing the numeric value 123 in either of the fields with field references #8 and #9:

```
FIND 123 #8,#9
```

If a field is part of a multi-dimensional array (table), then the array fields have the same field reference number, but are differentiated by the dimension, using a subscript. For example, given the following field references (shown in TABL display format):

```
(1,1)  (1,2)  (1,3)  (2,1)  (2,2)  (3,2)
#9     #9     #9     #9     #9     #9
```

You could use field references such as:

```
F bike #9(1,2)
F bike (#8 #9(2,1))
```

To search *all* items in the array, specify:

```
F bike #9
```

Related topics

[FIND primary command on page 455](#)

Specifying ranges of fields

You specify a range of fields by nominating the first and last field reference of the range, separated by a hyphen, with or without intervening spaces. You can optionally enclose the range in parentheses.

These are valid ranges of fields:

```
#17-#19
#17 - #19
(#17-#19)
(#17 - #19)
```

To specify more than one range of fields:

- Enclose each field range in parentheses (optionally separated by commas), or
- Separate each field range with commas, but without any intervening spaces.

These are valid ranges of fields:

```
(#8-#11) (#17-#19) (#24-#25)
(#8-#11), (#17-#19), (#24-#25)
#8-#11, #17-#19, #24-#25
```

These are invalid ranges of fields:

```
#8-#11 #17-#19 #24-#25
#8-#11, #17-#19, #24-#25
```



Note:

1. When using field ranges, the field reference number can not be subscripted. For example, #3(2) - #5(4) is not valid syntax.
2. Field ranges can overlap. For example, #2-#7, #5-#9. In this case, the result is a consolidated single field range equivalent to #2-#9.

Changing segments in records

You can use FM/IMS to insert new segments, delete segments and copy existing segments and then change values in those segments.

The tasks described in this section are:

- [Inserting segments on page 142](#)
- [Repeating segments on page 144](#)
- [Deleting segments on page 145](#)

Inserting segments

Segments can be inserted using a primary command or a prefix command. When using the primary command (INSERT), you can choose to insert any segment within the database hierarchy. When using the prefix command (I), you can only insert segments of the same type as those displayed.



Note: If your display is in SNGL format, you can only use the INSERT primary command.

To insert new segments using the INSERT primary command:

1. On the IMS Data panel, enter the INSERT primary command on the Command line. The Segment Selection panel is displayed.
2. Enter an **S** in the **Cmd** field for the segment type that you want to insert. The Insert Segment panel is displayed.

If you selected a root segment, then the Insert Segment panel shows the initialized fields for the root segment.

If you selected a child segment, the Insert Segment panel displays the Key Value details of the root segment and each parent segment in the hierarchy between the root and the selected child segment type in the top section of the

panel; and the initialized fields of the child segment in the bottom section of the panel. The root segment used is root of whatever segment was displayed at the top of the database window when you entered the command.

The fields in the new segment are initialized as follows:

- If the display format is CHAR, HEX or LHEX, then the entire segment is initialized to blanks.
 - If the display format is SNGL or TABL, then the segment is initialized according to the field creation attributes in the current layout. If no creation attributes have been specified:
 - Numeric fields are initialized to zero.
 - Alphanumeric fields are initialized to blanks.
 - If the segment type contains a variable-length array, then the segment is initialized with the minimum number of array elements, and the array size field (or fields, for multi-dimensional arrays) is initialized accordingly.
3. If necessary, you can adjust the values in the root and parent Key Value fields, to assign a child segment to a different parent or root.
 4. Use the Tab or Return key to move to the first available field in the new segment.
 5. Type the required data in the fields, then press Enter. If any changes you have made in the parent Key Value fields or any data you entered in your new segment breaks the database rules, a message is displayed at this point and you must modify your entries.
 6. Press the Exit function key (F3) to insert the segment and return to the IMS Data panel.

To insert new root segments, using the `␣` prefix command:

1. In CHAR, HEX, LHEX or TABL display formats, position your cursor in the prefix area of any root segment. Type the `␣` prefix command and press Enter.

The Insert Segment panel is displayed, and the fields in the new segment are initialized.

2. Use the Tab or Return key to move to the first available field.
3. Enter the required data.
4. Press the Exit function key (F3) to insert the segment and return to the IMS Data panel.

To insert a new child segment, using the `␣` prefix command:

1. From the Database Positioning panel, ensure that you have selected the child segment type for display.

You do not have to select the parent segment type, but selecting it makes it easier to identify the child segments of the required parent.

2. On the IMS Data panel, locate a child segment of the required parent. If the required parent does not have any child segments yet, locate any child segment of the same type that you want to insert.
3. In CHAR, HEX, LHEX or TABL display formats, position your cursor in the prefix area of one of the existing child segments. Type the `␣` prefix command and press Enter.

The Insert Segment panel is displayed, and shows the parent segments of the selected child (up to the root segment) and the new child segment. The fields in the child segment are initialized.

4. If necessary, change the Key Values in the parent segments to that of the required parent for your new child segment.
5. Use the Tab or Return key to move to the first available field in the child segment.
6. Enter the required data.
7. Press the Exit function key (F3) to insert the segment and return to the IMS Data panel.



Note:

1. New segments are sorted into the appropriate key order for that segment type. If the key for your new segment causes the segment to be sorted to a position prior to the database starting position, you may have to exit to the Database Positioning panel and change the starting Key values in that segment's database hierarchy.
2. The inserted segments are not committed to the database until a SAVE command is issued on the IMS Data or Database Positioning panels, or until you EXIT from the Database Positioning panel, or until the next automatic checkpoint is issued (if AUTOSAVE has been turned on).

Related topics

- [I \(Insert - Edit only\) on page 511](#)
- [Insert Segment panel on page 323](#)

Repeating segments

You can create copies of segments by repeating segments. Repeating allows you to quickly duplicate a segment, and then easily change the unique data.

To repeat segments:

1. Position your cursor in the prefix area of the segment that you wish to repeat.
2. Type the **R** prefix command and press Enter.
3. The Insert Segment panel is displayed, showing the copy of the selected segment.
4. Unless the segment is set to accept non-unique records, you must change at least the Key value field in the new segment.
5. Enter the required data.
6. Press the Exit function key (F3) to insert the segment and return to the IMS Data panel.

As well as repeating a single segment, you can repeat entire segment hierarchies, by creating a copy of a parent segment and all of its children.

To repeat a segment and all of its child segments:

1. Position your cursor in the prefix area of the parent segment that you wish to repeat.
2. Type the **RA** prefix command and press Enter.
3. The Insert Segment panel is displayed, showing the copy of the selected parent segment.

4. Unless the segment is set to accept non-unique records, you must change at least the Key value field in the new segment.
5. Enter the required data.
6. Press the Exit function key (F3) to insert the segment and return to the IMS Data panel.
7. Locate your new parent segment (see Notes below if you are having difficulty finding your new segment). Your new parent segment will have copies of all the children of the original parent segment, with each child linked to the new parent by the Key value field.
8. If necessary, change values in the child segments.

**Note:**

1. New segments are sorted into the appropriate key order for that segment type. If the key for this segment causes the segment to be sorted to a position prior to the database starting position, you may have to exit to the Database Positioning panel and change the Key values for any segments in that segment's database hierarchy.
2. The inserted segments are not committed to the database until a SAVE command is issued on the IMS Data or Database Positioning panel, or until you EXIT from the Database Positioning panel, or until the next automatic checkpoint is issued (if AUTOSAVE has been turned on).

Related topics

[R \(Repeat - Edit only\) on page 512](#)

[RA \(Repeat All - Edit only\) on page 512](#)

[Insert Segment panel on page 323](#)

Deleting segments

You can delete segments when in any display format, by using the DELETE primary command. When you delete a segment, you delete all of its child segments at the same time.

To delete a segment using the DELETE primary command:

1. In CHAR, HEX, LHEX or TABL display formats, scroll until the segment that you want to delete is at the top of the data area. In SNGL format, scroll until the segment that you want to delete is displayed on the screen.
2. Enter the DELETE primary command on the Command line.

In CHAR, HEX, LHEX or TABL display formats, you can also delete segments (and the dependent child segments) by using the D prefix command.

To delete a segment using the prefix command:

1. Position your cursor in the prefix area of the first segment to be deleted and type the D primary command.
2. Repeat this for each segment that you want to remove from the database.
3. Press Enter. The segment(s) and the dependent child segments are deleted from the data set.



Note:

1. Take care when deleting root or parent segments, as ALL dependent child segments are deleted, even if they are not currently displayed or selected.
2. In CHAR, HEX, LHEX or TABL display formats, it is often faster to use the prefix command as the process of scrolling to position the segment that you want to delete at the exact top of the data area might take several keystrokes.
3. The deletions are not committed to the database until a SAVE command is issued in the Edit : Database or Database Positioning panel, or until you EXIT from the Database Positioning panel, or until the next automatic checkpoint is issued (if AUTOSAVE has been turned on).

Related topics

[D \(Delete - Edit only\) on page 511](#)

[RA \(Repeat All - Edit only\) on page 512](#)

Editing your database in batch

The Batch Edit dialog (option 6 on the Utility menu) generates the JCL for a Batch Edit job. A Batch Edit job runs user-written REXX procedures that invoke built-in functions that allow you to read and update your IMS databases.

To generate the JCL for a Batch Edit job:

1. Select option 3 Utilities from the Primary Option Menu and then 6 Batch Edit from the Utility Menu. The Batch Edit Entry panel is displayed.
2. Notice that many of the fields on the Batch Edit Entry panel are also on the Browse Entry panel. To fill out the fields that are common to both panels, follow one of these sets of instructions according to which Region type and PSB type you want the Batch Edit to use:
 - Steps 2 to 9 in [Accessing in BMP mode using a Static PSB on page 49](#).
 - Steps 2 to 8 in [Accessing in BMP mode using a Dynamic PSB on page 51](#).
 - Steps 2 to 10 in [Accessing in DLI mode using a Static PSB on page 52](#).
 - Steps 2 to 9 in [Accessing in DLI mode using a Dynamic PSB on page 55](#).
3. If you selected Existing for the View usage and you want to edit the view before the Batch Edit uses it, enter / in the Edit view field.
4. If the REXX procedure that you want the Batch Edit to run, includes a VIEWIMS call with the TPLDD parameter, enter s in the Include template DD field. If you select this option, the generated JCL includes a TDDIN DD statement that specifies the Template data sets for the specified subsystem.

5. Press Enter to process the data you entered. According to what you entered on the panel, one or more of these panels may be displayed in the order they are listed:

- Subsystem Selection panel
 - Displayed when you enter no subsystem name or a subsystem name pattern.
 - Displays a list of IMS subsystems defined by the FM/IMS administrator at installation time.
- PSB Selection panel
 - Displayed when you enter no PSB name or a PSB name pattern and select "Static" for **PSB type**.
 - Displays a list of the PSBs in the PSB libraries for the specified subsystem.

If the PSB libraries for the subsystem are not fixed, you specify the PSB libraries for the subsystem on the PSB and DBD Data Sets panel (option 0.6.7). If the PSB libraries for the subsystem are fixed, the FM/IMS administrator specifies the PSB libraries for the subsystem at installation time.

- PCB Selection panel
 - Displayed when you select Static for the PSB type and one of the following is true:
 - you enter no database name and there is more than one database PCB in the specified PSB or
 - you enter a database name and there is more than one PCB for the database in the PSB or
 - you enter a database name pattern and the PSB has PCBs for databases with names that match the pattern
 - Displays a list of the PCBs in the specified PSB.
- Database Selection panel
 - Displayed when you enter no database name or a database name pattern and select Dynamic for the PSB type.
 - Displays a list of the DBDs in the DBD libraries for the specified subsystem.

If the DBD libraries for the subsystem are not fixed, you specify the DBD libraries for the subsystem on the PSB and DBD Data Sets panel (option 0.6.7). If the DBD libraries for the subsystem are fixed, the FM/IMS administrator specifies the DBD libraries for the subsystem at installation time.

- AGN Selection panel
 - Displayed when all of these are true:
 - you select BMP for the Region type
 - the specified subsystem uses AGNs and has some of them listed in the FM/IMS installation options module
 - you enter no AGN name or an AGN name pattern.
 - Displays the AGNs for the subsystem that are listed in the FM/IMS installation options module.
- View Data Set Selection panel
 - Displayed when you enter a View data set name pattern and select Existing for View usage.
 - Displays a list of the data sets whose names match the specified View data set name pattern.
- View Member Selection panel
 - Displayed when the specified View data set is partitioned, you enter no View member name or a View member name pattern and you select Existing for View usage.
 - Displays a list of the members in the View data set.

On each selection panel that is displayed, enter **s** in the **Cmd** field adjacent to the item you want to select and press Enter.

6. If you selected DLI for **Region type** and did not select the **Skip DB data set panel** option, either the Database Data Set Display or the Database Data Set Specification panel is displayed.

- The Database Data Set Display panel is displayed when a database that is a HALDB or a subsystem that is defined as dynamic allocation only is selected on the Browse or Edit Entry panel. This panel displays the names of the database data sets that the Edit or Browse uses. Verify that the database data sets listed are the ones you want the function to use. To confirm usage of these data sets and to proceed to the next panel in the dialog, press Enter.
- The Database Data Set Specification panel is displayed when a database that is not a HALDB and a subsystem that is not defined as dynamic allocation only is selected on the Browse or Edit Entry panel. If you selected "User profile" for the **Fetch DB dsnames from** option, it displays the data set names saved in your user profile. If you selected DFSMDA members for the **Fetch DB dsnames from** option, it displays the data set names specified in the DFSMDA dynamic allocation members for the subsystem.

The Database Data Set Specification panel is displayed when the **Skip DB data set panel** option is not selected, but it is also displayed when the **Skip DB data set panel** option is selected and one of the following conditions is true:

- FM/IMS fails to obtain all the required data set names from either your user profile or the DFSMDA members.
- One or more of the database data sets does not exist or has an invalid data set organization.

If the displayed data set names are not the ones you want the function to use or no data set names are displayed, enter the data set names that you want the function to use and press Enter. To confirm usage of the displayed data set names and to proceed to the next panel in the dialog, press Enter once more.

7. On the Batch Edit Options panel, specify whether the REXX procedure to be run is to be created instream by yourself or run from a dataset (or member) you previously created.

To create the REXX Procedure instream:

- Select the Instream field. You must edit the generated JCL to specify the REXX that is to be run.

To run REXX from an existing data set (or member):

- In the REXX Procedure fields specify the data set (must be a PDS) and member containing the REXX that is to be run.
- Ensure the Instream Field has not been specified.
- You can maintain the REXX by selecting the Edit REXX field. This will take you into an ISPF edit session to maintain the REXX procedure.

8. Press Enter. FM/IMS uses the data you specified in the dialog to generate JCL for the Batch Edit job. You can edit the JCL before submitting the job.



Note: The minimum region size is 2M.

IEB REXX procedure (Batch Edit)

The REXX Procedure run by Batch Edit calls IEB functions to process the database with or without a view.

Using a view, you have limited control over how FM/IMS can navigate the IMS database. By specifying Selection Criteria in the view, FM/IMS only returns the IMS segments that match the selection criteria specified.

The IEB calls available when using a view are:

DELIMS

Delete the current IMS segment.

GETIMS

Retrieve IMS segments using the view specified.

ISRTIMS

Insert a segment under the current IMS segment.

PRINT

Print an IMS segment in CHAR, HEX, SNGL, or TABL format.

REPLIMS

Replace the current IMS segments data.

SETRC

Set the IEB job step return code.

VIEWIMS

Create and load a view to be used by the REXX procedure to retrieve IMS segments.

VIEWPOSN

Position on an IMS segment prior to invoking the GETIMS call. This allows you to start processing the IMS database from a point within the database.

When not using a view, you can navigate the IMS database using the GETIMS call. This mode is similar to issuing IMS calls within a program. You can:

- Retrieve segments based on the segments key values.
- Retrieve a segment's children.
- Position on a segment's parent or its root segment.
- Insert or update an IMS segment using criteria specified by means of the WHERE clause.

The IEB calls available when not using a view are:

DELIMS

Delete the current IMS segment or the IMS segment specified by the WHERE clause.

GETIMS

Retrieve IMS segments.

ISRTIMS

Insert a segment either under the current IMS segment, or under the IMS segment specified on the WHERE clause.

PRINT

Print an IMS segment in CHAR, HEX, SNGL, or TABL format.

REPLIMS

Replace the current IMS segment or the IMS segment specified on the WHERE clause.

SAVEIMS

Save the IMS data. Issuing this call causes you to lose the position in the IMS database. GETIMS calls are required to re-establish the position in the database.

SETRC

Set the IEB job step return code.

VIEWIMS

Create and load a view to be used by the REXX procedure. When not processing the database using a view, FM/IMS uses the IMS segment layouts and fields in the view to:

- Print in SNGL or TABL format.
- Generate an IMS SSA when retrieving an IMS segment and the WHERE clause specifies fields from the view.

Related topics

[Utility Menu panel on page 425](#)

[Print Entry panel on page 351](#)

[System Settings panel on page 406](#)

[PCB Selection panel on page 343](#)

[Database Data Set Specification panel on page 236](#)

Chapter 7. Managing data

Using FM/IMS, you can define and initialize empty IMS databases, extract all or selected segments from your databases and load extracted data into your databases.

The major tasks described in this chapter are:

[Defining and initializing IMS databases on page 151](#)

[Extracting data on page 156](#)

[Loading data on page 172](#)

Defining and initializing IMS databases

When you are developing applications that access IMS databases, there are times when you want to empty your data sets and start to input the data again. FM/IMS provides a mechanism for you to:

- Delete and redefine the data sets associated with an IMS database.
- Initialize the database, so that it can be used in the edit or load process.
- Load data into an uninitialized IMS database (see [Loading into an uninitialized database on page 175](#)).

The tasks described in this section are:

[Deleting and redefining your data sets on page 151](#)

[Initializing an empty database on page 153](#)

Deleting and redefining your data sets

You can use the Delete/Define dialog to create a batch job that deletes and redefines the data sets associated with an IMS database and any logically related databases. When you delete and then redefine the data sets, you are effectively emptying the database, so that you can start again with fresh data. From this point, you can either initialize the database and manually add new segments to it, or you can load data into the uninitialized database.

You can delete/define the data sets associated with the following types of IMS databases:

- HDAM - Hierarchical Direct Access Method
- HIDAM - Hierarchical Index Direct Access Method
- HISAM - Hierarchical Index Sequential Access Method
- SHISAM - Simple Hierarchical Index Sequential Access Method
- HSAM - Hierarchical Sequential Access Method (BSAM or QSAM only)
- SHSAM - Simple Hierarchical Sequential Access Method (BSAM or QSAM)
- DEDB - Data Entry Database (Fast Path)
- PHDAM - Partitioned Hierarchical Direct Access Method (HALDB)
- PHIDAM - Partitioned Hierarchical Index Direct Access Method (HALDB)

To generate the JCL for a job that deletes and redefines your database data sets:

1. Ensure that your IMS database has been stopped within your IMS subsystem.



Note: You cannot delete and redefine data sets while they are in use by the IMS subsystem.

2. Select option **3 Utilities** from the Primary Option Menu and then option **1 Delete/Define** from the Utility Menu. The Delete/Define Entry Panel is displayed.
3. In the **Subsystem name** field, enter the ID of the IMS subsystem that the database whose data sets you want to delete/define is defined in, or if you want to select the required subsystem from a list, enter a subsystem name pattern or leave the field blank.
4. In the **Database name** field, enter the name of the database whose data sets you want to delete and redefine, or if you want to select a database from a list of DBDs, enter a database name pattern or leave the field blank. When the database you specify is logically related to other databases, the Delete/Define also deletes and redefines the data sets of the logically related databases.
5. If you selected a database that is not a HALDB and an IMS subsystem that is not a dynamic allocation only subsystem, in the **Fetch DB dsnames from** field:
 - Enter **1** if you want the function to delete and redefine the database data sets whose names were saved in your user profile.
 - Enter **2** if you want the function to delete and redefine the database data sets specified in the DFSMDA dynamic allocation members.
6. If you want to skip the display of the Database Data Set Specification or the Database Data Set Display panel, enter **"/** in the **Skip DB data set panel** field.
7. Press Enter to process the data you entered. According to what you entered on the panel, one or more of these panels may be displayed in the order they are listed:
 - Subsystem Selection panel.
 - Displayed when you enter no subsystem name or a subsystem name pattern.
 - Displays a list of IMS subsystems defined by the FM/IMS administrator at installation time.
 - Database Selection panel.
 - Displayed when you enter no database name or a database name pattern.
 - Displays a list of the DBDs in the DBD libraries for the specified subsystem.

If the DBD libraries for the subsystem are not fixed, you specify the DBD libraries for the subsystem on the PSB and DBD Data Sets panel (option 0.6.7). If the DBD libraries for the subsystem are fixed, the FM/IMS administrator specifies the DBD libraries for the subsystem at installation time.

On each selection panel that is displayed, enter **s** in the **Cmd** field adjacent to the item you want to select and press Enter.

8. If you did not select the **Skip DB data set panel** option, either the Database Data Set Display or the Database Data Set Specification panel is displayed.
 - The Database Data Set Display panel is displayed when a database that is a HALDB or a subsystem that is defined as dynamic allocation only is selected on the Delete/Define Entry panel. This panel displays the names of the database data sets that the Delete/Define deletes and redefines. Verify that the database data

sets listed are the ones you want the function to use. To confirm usage of these data sets and to proceed to the next panel in the dialog, press Enter.

- The Database Data Set Specification panel is displayed when a database that is not a HALDB and a subsystem that is not defined as dynamic allocation only is selected on the Delete/Define Entry panel. If you selected "User profile" for the **Fetch DB dsnames from** option, it displays the data set names saved in your user profile. If you selected DFSMDA members for the **Fetch DB dsnames from** option, it displays the data set names specified in the DFSMDA dynamic allocation members for the subsystem.

The Database Data Set Specification panel is displayed when the **Skip DB data set panel** option is not selected, but it is also displayed when the **Skip DB data set panel** option is selected and one of the following conditions is true:

- FM/IMS fails to obtain all the required data set names from either your user profile or the DFSMDA members.
- One or more of the database data sets does not exist or has an invalid data set organization.

If the displayed data set names are not the ones you want the function to use or no data set names are displayed, enter the data set names that you want the function to use and press Enter. To confirm usage of the displayed data set names and to proceed to the next panel in the dialog, press Enter once more.

9. Press Enter. FM/IMS uses the data you specified in the dialog to generate JCL for the Delete/Define job. You can edit the JCL before submitting the job.

Related topics

[Delete/Define Entry panel on page 251](#)

[Database Data Set Specification panel on page 236](#)

[Utility Menu panel on page 425](#)

Initializing an empty database

You can use the Initialize dialog to create a batch job that initializes your IMS database.

You can initialize these types of IMS databases:

- HDAM - Hierarchical Direct Access Method
- HIDAM - Hierarchical Index Direct Access Method
- HISAM - Hierarchical Index Sequential Access Method
- SHISAM - Simple Hierarchical Index Sequential Access Method
- DEDB - Data Entry Database (Fast Path)
- PHDAM - Partitioned Hierarchical Direct Access Method (HALDB)
- PHIDAM - Partitioned Hierarchical Index Direct Access Method (HALDB)

To generate the JCL for a job that initializes an IMS database:

1. Select option **3 Utilities** from the Primary Option Menu and then option **2 Initialize** from the Utility Menu. The Initialize Entry Panel is displayed.
2. In the **Subsystem name** field, enter the ID of the IMS subsystem that the database you want to initialize is defined in, or if you want to select the required subsystem from a list, enter a subsystem name pattern or leave the field blank.
3. In the **Database name** field, enter the name of the database that you want to initialize, or if you want to select a database from a list of DBDs, enter a database name pattern or leave the field blank. When the database you specify is logically related to other databases, the Initialize also initializes the logically related databases.
4. If you want the generated JCL to include a job step that uses GENJCL.IC commands to generate an image copy job:
 - Enter "/" in the **Submit image copy** field.
 - Enter in the **Image Copy Skeleton** field, the name of the partitioned data set that contains the image copy skeletons that you want the Initialize to use.

The generated image copy job is submitted to the internal reader.

5. If you selected a database that is not a HALDB and an IMS subsystem that is not a dynamic allocation only subsystem, in the **Fetch DB dsnames from** field:
 - Enter **1** if you want the function to initialize the database data sets whose names were saved in your user profile.
 - Enter **2** if you want the function to initialize the database data sets specified in the DFSMDA dynamic allocation members.
6. If you want the generated JCL to include job steps that delete and redefine the database data sets, enter "/" in the **Delete/Define DB data sets** field.
7. If you want to skip the display of the Database Data Set Specification or the Database Data Set Display panel, enter "/" in the **Skip DB data set panel** field.
8. Press Enter to process the data you entered. According to what you entered on the panel, one or more of these panels may be displayed in the order they are listed:
 - Subsystem Selection panel
 - Displayed when you enter no subsystem name or a subsystem name pattern.
 - Displays a list of IMS subsystems defined by the FM/IMS administrator at installation time.
 - Database Selection panel
 - Displayed when you enter no database name or a database name pattern.
 - Displays a list of the DBDs in the DBD libraries for the specified subsystem.

If the DBD libraries for the subsystem are not fixed, you specify the DBD libraries for the subsystem on the PSB and DBD Data Sets panel (option 0.6.7). If the DBD libraries for the subsystem are fixed, the FM/IMS administrator specifies the DBD libraries for the subsystem at installation time.

On each selection panel that is displayed, enter an s in the Cmd field adjacent to the item you want to select and press Enter.

9. If you did not select the Skip DB data set panel option, either the Database Data Set Display or the Database Data Set Specification panel is displayed.

- The Database Data Set Display panel is displayed when a database that is a HALDB or a subsystem that is defined as dynamic allocation only is selected on the Initialize Entry panel. This panel displays the names of the database data sets that the function initializes. Verify that the database data sets listed are the ones you want the function to use. To confirm usage of these data sets and to proceed to the next panel in the dialog, press Enter.
- The Database Data Set Specification panel is displayed when a database that is not a HALDB and a subsystem that is not defined as dynamic allocation only is selected on the Initialize Entry panel. If you selected "User profile" for the **Fetch DB dsnames from** option, it displays the data set names saved in your user profile. If you selected DFSMDA members for the **Fetch DB dsnames from** option, it displays the data set names specified in the DFSMDA dynamic allocation members for the subsystem.

The Database Data Set Specification panel is displayed when the **Skip DB data set panel** option is not selected, but it is also displayed when the **Skip DB data set panel** option is selected and one of the following conditions is true:

- FM/IMS fails to obtain all the required data set names from either your user profile or the DFSMDA members.
- One or more of the database data sets does not exist or has an invalid data set organization.

If the displayed data set names are not the ones you want the function to use or no data set names are displayed, enter the data set names that you want the function to use and press Enter. To confirm usage of the displayed data set names and to proceed to the next panel in the dialog, press Enter once more.

10. FM/IMS retrieves the data set information and builds a job to initialize these data sets.

The generated JCL contains instructions appropriate to the database type and selected options:

- If you selected **Delete/Define IMS data sets**, the JCL also contains the instructions to delete/define these data sets.
- For a DEDB Fast Path, the IMS Utility DBFUMIN0 is used to initialize the Fast Path areas.
- For a Full Function database, the steps to initialize the database are:
 - Delete Work data sets. See Note a and b.
 - IMS Prereorganization Utility (DFSURPR0). See Notes a and b.
 - Database load.
 - IMS Database Prefix Resolution Utility (DFSURG10). See Notes a and b.
 - HISAM Reorganization Unload Utility (DFSURUL0). See Note a.
 - IMS HISAM Reorganization Load Utility (DFSURRL0). See Note a.
 - IMS Database Prefix Update Utility (DFSURGP0). See Note b.
 - Database segment delete.
 - Generate IMS image copy (DSPURX00). See Note c.
 - Delete Work data sets. See Notes a and b.
- For a HALDB database, the steps to initialize the database are:
 - Delete Work data sets.
 - PINIT DBRC STEP (DSPURX00). Set the master HALDB database to PINIT, so all partitions need to be initialized.

- IMS Preorganization Utility (DFSURPRO). Use to initialize the HALDB partitions.
- Generate IMS image copy (DSPURX00). See Note c.
- Delete Work data sets.



Note:

- a. This step only runs when the Database has secondary indexes
- b. This step only runs when the Database has logical relationships.
- c. The GENJCL step only runs if the Submit image copy flag has been selected for the database.
Databases that use DBRC (particularly HALDBs) are unusable until an image copy has been run for the IMS database.

Related topics

[Initialize Entry panel on page 318](#)

[Database Data Set Specification panel on page 236](#)

[Utility Menu panel on page 425](#)

Extracting data

With Extract (option 3.3), you can extract all or selected segments from an IMS database, and save them to a sequential data set. After extracting the segments, you can use Load (option 3.4) to load them into another IMS database.

The types of extracts that can be performed are:

- A full database extract, including a full extract of any logically related databases.
- A partial database extract, containing segments selected by a combination of:
 - A file containing the root segment key values to determine the database records you want to extract.

You can create this file when editing a database, by entering the XKEY command.

- Extract criteria specifying the segments you want to extract and field selection criteria to select the database records to be extracted.
- Relationship criteria specifying how logical segments are chased.

Here are two example uses for Extract:

Creating a small test database from a large production database

You can extract a relatively small number of segments from a large production database, then load those segments into a separate database for application testing.

Querying the database

You can use a combination of criteria to extract only those segments whose fields match particular values.

To print a formatted extract of the IMS Segments, use the IPR (IMS print) function.



Note: The Extract utility can use a Dynamic PSB or a Static PSB.

The tasks described in this section are:

[Creating a full copy of a database on page 157](#)

[Partial extract using a Keys file on page 159](#)

[Partial extract using extract criteria on page 162](#)

Creating a full copy of a database

A full copy of a database allows you to backup the data or to create a copy of the database.

FM/IMS performs a full database extract if you select "None" for the **Criteria usage** option and you do not select the **Use key values** option.

To create a full copy of a database:

1. Select option **3 Utilities** from the Primary Options Menu and then option **3 Extract** from the Utility Menu. The Extract Entry panel is displayed.
2. Notice that many of the fields on the Extract Entry panel are also on the Browse Entry panel. To fill out the fields that are common to both panels, follow one of these sets of instructions according to which Region type and PSB type you want the Extract to use:
 - Steps 2, 3, 4, 5, 7 and 8 in [Accessing in BMP mode using a Static PSB on page 49](#).
 - Steps 2, 3, 4, 6 and 7 in [Accessing in BMP mode using a Dynamic PSB on page 51](#).
 - Steps 2, 3, 4, 6, 7, 8 and 10 in [Accessing in DLI mode using a Static PSB on page 52](#).
 - Steps 2, 3, 5, 6, 7 and 9 in [Accessing in DLI mode using a Dynamic PSB on page 55](#).
3. In the **Criteria usage** field, enter **3** to select an Extract that does not use criteria.
4. Blank out the **Use key values** field.
5. If you want either the Extract dialog or your Extract job to create a template for the Extract file, enter "/" in the **Create extract template** field.
6. If you are extracting data from a DEDB with Sequentially Dependent (SDEP) segments, the extracted SDEP segments are to be loaded into a database and there is a requirement for the loaded SDEP segments to be in timestamp order, enter "/" in the **SDEP in timestamp order** field.
7. Press Enter to process the data you entered. According to what you entered on the panel, one or more of these panels may be displayed in the order they are listed:
 - Subsystem Selection panel
 - Displayed when you enter no subsystem name or a subsystem name pattern.
 - Displays a list of IMS subsystems defined by the FM/IMS administrator at installation time.
 - PSB Selection panel
 - Displayed when you enter no PSB name or a PSB name pattern and select Static for the PSB type.
 - Displays a list of the PSBs in the PSB libraries for the specified subsystem.

If the PSB libraries for the subsystem are not fixed, you specify the PSB libraries for the subsystem on the PSB and DBD Data Sets panel (option 0.6.7). If the PSB libraries for the subsystem are fixed, the FM/IMS administrator specifies the PSB libraries for the subsystem at installation time.

- PCB Selection panel
 - Displayed when you select Static for the PSB type and one of the following is true:
 - You enter no database name and there is more than one database PCB in the specified PSB, or
 - You enter a database name and there is more than one PCB for the database in the PSB, or
 - You enter a database name pattern and the PSB has PCBs for databases with names that match the pattern.
 - Displays a list of the PCBs in the specified PSB.
- Database Selection panel
 - Displayed when you enter no database name or a database name pattern and select Dynamic for the PSB type.
 - Displays a list of the DBDs in the DBD libraries for the specified subsystem.

If the DBD libraries for the subsystem are not fixed, you specify the DBD libraries for the subsystem on the PSB and DBD Data Sets panel (option 0.6.7). If the DBD libraries for the subsystem are fixed, the FM/IMS administrator specifies the DBD libraries for the subsystem at installation time.

- AGN Selection panel
 - Displayed when all of these are true:
 - You select "BMP" for **Region type**.
 - The specified subsystem uses AGNs and has some of them listed in the FM/IMS installation options module.
 - You enter no AGN name or an AGN name pattern.
 - Displays the AGNs for the subsystem that are listed in the FM/IMS installation options module.

On each selection panel that is displayed, enter **s** in the **Cmd** field adjacent to the item you want to select and press Enter.

8. If you selected "DLI" for **Region type** and did not select the **Skip DB data set panel** option, either the Database Data Set Display or the Database Data Set Specification panel is displayed.
 - The Database Data Set Display panel is displayed when a database that is a HALDB or a subsystem that is defined as dynamic allocation only is selected on the Extract Entry panel. This panel displays the names of the database data sets that the function uses. Verify that the database data sets listed are the ones you want the function to use. To confirm usage of these data sets and to proceed to the next panel in the dialog, press Enter.
 - The Database Data Set Specification panel is displayed when a database that is not a HALDB and a subsystem that is not defined as dynamic allocation only is selected on the Extract Entry panel. If you selected "User profile" for the **Fetch DB dsnames from** option, it displays the data set names saved in your user profile. If you selected DFSMDA members for the **Fetch DB dsnames from** option, it displays the data set names specified in the DFSMDA dynamic allocation members for the subsystem.

The Database Data Set Specification panel is displayed when the **Skip DB data set panel** option is not selected, but it is also displayed when the **Skip DB data set panel** option is selected and one of the following conditions is true:

- FM/IMS fails to obtain all the required data set names from either your user profile or the DFSMDA members.
- One or more of the database data sets does not exist or has an invalid data set organization.

If the displayed data set names are not the ones you want the function to use or no data set names are displayed, enter the data set names that you want the function to use and press Enter. To confirm usage of the displayed data set names and to proceed to the next panel in the dialog, press Enter once more.

9. On the To Data Set Specification panel, specify the name of the data set that you want your extract data stored in. This must be a sequential file.
10. Specify a disposition for the extract data set:
 - If you have specified an existing sequential data set, set the Disposition to OLD. This overwrites the existing file
 - If you have specified a new sequential data set, set the Disposition to NEW and complete the **Allocation parameters** as necessary for your site.



Note: The Storage Management System in use at your site might assign default values to all of these parameters. If that is the case, you do not need to complete these fields.

11. Press Enter. FM/IMS uses the data you specified in the dialog to generate JCL for the Extract job. You can edit the JCL before submitting the job. Submit the JCL.

FM/IMS extracts the segments into the sequential data set that you have specified.

For a full extract, FM/IMS performs a Get Next through the primary database extracting all of the segments. If the database has logical relationships, then all segments on each of the Related databases are extracted.

Partial extract using a Keys file

When you want to extract a subset of your database records, you can use a Keys file to specify the root segment of each record that you want to extract. FM/IMS extracts all segments of:

- The database records that have their root key specified in the Keys file
- The database records that include one or more logical parents of the logical child segments that are extracted

To perform a partial extract using a Keys file:

1. In the IMS data panel, display the root segment type of your database.



Note: While you can use any segment type from within the database hierarchy, the extracted keys are always drawn from the root segment.

2. Scroll to the first segment instance that you want to extract to your Keys file.
3. Issue the XKEY command. FM/IMS creates a sequential Keys file in the format:

```
userid.XKEY.Dyymmdd.Thhmmss.dbd-name
```

This file contains a list of the root segment keys, from the current segment forward through the database.

4. Edit the Keys file to remove any root keys for records that you do not want to extract. This can be done manually, using the ISPF Editor, or programmatically, using IEB.
5. Select option **3 Utilities** from the Primary Options Menu and then option **3 Extract** from the Utility Menu. The Extract Entry panel is displayed.
6. Notice that many of the fields on the Extract Entry panel are also on the Browse Entry panel. To fill out the fields that are common to both panels, follow one of these sets of instructions according to which Region type and PSB type you want the Extract to use:
 - Steps 2, 3, 4, 5, 7 and 8 in [Accessing in BMP mode using a Static PSB on page 49](#).
 - Steps 2, 3, 4, 6 and 7 in [Accessing in BMP mode using a Dynamic PSB on page 51](#).
 - Steps 2, 3, 4, 6, 7, 8 and 10 in [Accessing in DLI mode using a Static PSB on page 52](#).
 - Steps 2, 3, 5, 6, 7 and 9 in [Accessing in DLI mode using a Dynamic PSB on page 55](#).
7. In the Criteria usage field, enter 3 to select an Extract that does not use criteria.
8. In the Use key values field, enter / to select an Extract that uses a Key values file.
9. If you want either the Extract dialog or your Extract job to create a template for the Extract file, enter / in the Create extract template field.
10. If you are extracting data from a DEDB with Sequentially Dependent (SDEP) segments, the extracted SDEP segments are to be loaded into a database and there is a requirement for the loaded SDEP segments to be in timestamp order, enter / in the SDEP in timestamp order field.
11. Press Enter to process the data you entered. According to what you entered on the panel, one or more of these panels may be displayed in the order they are listed:
 - Subsystem Selection panel
 - Displayed when you enter no subsystem name or a subsystem name pattern.
 - Displays a list of IMS subsystems defined by the FM/IMS administrator at installation time.
 - PSB Selection panel
 - Displayed when you enter no PSB name or a PSB name pattern and select Static for the PSB type.
 - Displays a list of the PSBs in the PSB libraries for the specified subsystem.

If the PSB libraries for the subsystem are not fixed, you specify the PSB libraries for the subsystem on the PSB and DBD Data Sets panel (option 0.6.7). If the PSB libraries for the subsystem are fixed, the FM/IMS administrator specifies the PSB libraries for the subsystem at installation time.
 - PCB Selection panel

- Displayed when you select Static for the PSB type and one of the following is true:
 - You enter no database name and there is more than one database PCB in the specified PSB, or
 - You enter a database name and there is more than one PCB for the database in the PSB, or
 - You enter a database name pattern and the PSB has PCBs for databases with names that match the pattern
- Displays a list of the PCBs in the specified PSB.
- Database Selection panel
 - Displayed when you enter no database name or a database name pattern and select Dynamic for the PSB type.
 - Displays a list of the DBDs in the DBD libraries for the specified subsystem.

If the DBD libraries for the subsystem are not fixed, you specify the DBD libraries for the subsystem on the PSB and DBD Data Sets panel (option 0.6.7). If the DBD libraries for the subsystem are fixed, the FM/IMS administrator specifies the DBD libraries for the subsystem at installation time.

- AGN Selection panel
 - Displayed when all of these are true:
 - You select "BMP" for **Region type**.
 - The specified subsystem uses AGNs and has some of them listed in the FM/IMS installation options module.
 - You enter no AGN name or an AGN name pattern.
 - Displays the AGNs for the subsystem that are listed in the FM/IMS installation options module.

On each selection panel that is displayed, enter an s in the Cmd field adjacent to the item you want to select and press Enter.

12. If you selected DLI for the Region type and did not select the Skip DB data set panel option, either the Database Data Set Display or the Database Data Set Specification panel is displayed.

- The Database Data Set Display panel is displayed when a database that is a HALDB or a subsystem that is defined as dynamic allocation only is selected on the Extract Entry panel. This panel displays the names of the database data sets that the function will use. Verify that the database data sets listed are the ones you want the function to use. To confirm usage of these data sets and to proceed to the next panel in the dialog, press Enter.
- The Database Data Set Specification panel is displayed when a database that is not a HALDB and a subsystem that is not defined as dynamic allocation only is selected on the Extract Entry panel. If you selected User profile for the Fetch DB dsnames from option, it displays the data set names saved in your user profile. If you selected DFSMDA members for the Fetch DB dsnames from option, it displays the data set names specified in the DFSMDA dynamic allocation members for the subsystem.

The Database Data Set Specification panel is displayed when the Skip DB data set panel option is not selected, but it is also displayed when the Skip DB data set panel option is selected and one of the following conditions is true:

- FM/IMS fails to obtain all the required data set names from either your user profile or the DFSMDA members.
- One or more of the database data sets does not exist or has an invalid data set organization.

If the displayed data set names are not the ones you want the function to use or no data set names are displayed, enter the data set names that you want the function to use and press Enter. To confirm usage of the displayed data set names and to proceed to the next panel in the dialog, press Enter once more.

13. On the Extract Options panel, specify the name of your Keys file in the **Key Values** fields and press Enter. The To Data Set Specification panel is displayed.
14. On the To Data Set Specification panel, specify the name of the data set that you want your extract data stored in. This must be a sequential file.
15. Specify the **Disposition** and, if necessary, the **Allocation parameters** for the Extract file (see [Creating a full copy of a database on page 157](#)).
16. Press Enter. FM/IMS uses the data you specified in the dialog to generate JCL for the Extract job. You can edit the JCL before submitting the job. Submit the JCL.

Once the JCL is submitted, FM/IMS reads the Keys file and, for each key, extracts the root segment and all of its dependents.

Partial extract using extract criteria

FM/IMS is able to place criteria against segments to determine if they are to be extracted. A group of criteria is combined into a Criteria Subset. A single criteria subset is used to determine if a database record is extracted, each of the field selection criteria is tested to determine if the database record is extracted. If you have multiple criteria subsets, it is possible for FM/IMS to extract the same database record multiple times. This is why when multiple criteria subsets have been specified, the JCL created by FM/IMS sorts the extracted data to remove duplicate data.

If you have specified either a keys file or Extract criteria, FM/IMS performs a partial extract of the primary database. For databases with logical relationships, FM/IMS only extracts segments from a logically-related database when the logical child segment type in the primary database has been selected for extract.

If you have selected the relationship criteria subset, the settings specified in this subset govern how FM/IMS chases logical relationships.

Through maintaining the logical relationship criteria subset, you are able to determine if in extracting the database FM/IMS:

- Chooses to chase logical relationships between databases.
- The number of each logical relationship that FM/IMS chases for each database record.

To extract statements using logical relationships:

1. From the **Primary Option** panel, select **Extract (option 3.3)** and press Enter.

The **Extract Entry** panel is displayed.

Use the **IVP sample database Data Sets**. The member we are using is **DJ2E**.

2. Notice that many of the fields on the Extract Entry panel are also on the Browse Entry panel. To fill out the fields that are common to both panels, follow one of these sets of instructions according to which Region type and PSB type you want the Extract to use:
 - Steps 2, 3, 4, 5, 7 and 8 in [Accessing in BMP mode using a Static PSB on page 49](#).
 - Steps 2, 3, 4, 6 and 7 in [Accessing in BMP mode using a Dynamic PSB on page 51](#).
 - Steps 2, 3, 4, 6, 7, 8 and 10 in [Accessing in DLI mode using a Static PSB on page 52](#).
 - Steps 2, 3, 5, 6, 7 and 9 in [Accessing in DLI mode using a Dynamic PSB on page 55](#).
3. If you want the Extract to use existing criteria, enter **2** in the **Criteria usage** field and specify in the **Criteria** fields the name of the data set that contains the criteria you want your extract to use. If you want to edit these criteria before you run the Extract, enter "/" in the **Edit criteria** field. If you want to create new criteria for the Extract, enter **1** in the **Criteria usage** field.
4. If you want the Extract to use a Key values file, enter "/" in the **Use key values** field.
5. If you want either the Extract dialog or your Extract job to create a template for the Extract file, enter "/" in the **Create extract template** field.
6. If you are extracting data from a DEDB with Sequentially Dependent (SDEP) segments, the extracted SDEP segments are to be loaded into a database and there is a requirement for the loaded SDEP segments to be in timestamp order, enter "/" in the **SDEP in timestamp order** field.
7. Press Enter to process the data you entered. According to what you entered on the panel, one or more of these panels may be displayed in the order they are listed:
 - Subsystem Selection panel
 - Displayed when you enter no subsystem name or a subsystem name pattern.
 - Displays a list of IMS subsystems defined by the FM/IMS administrator at installation time.
 - PSB Selection panel
 - Displayed when you enter no PSB name or a PSB name pattern and select Static for the PSB type.
 - Displays a list of the PSBs in the PSB libraries for the specified subsystem.

If the PSB libraries for the subsystem are not fixed, you specify the PSB libraries for the subsystem on the PSB and DBD Data Sets panel (option 0.6.7). If the PSB libraries for the subsystem are fixed, the FM/IMS administrator specifies the PSB libraries for the subsystem at installation time.
 - PCB Selection panel
 - Displayed when you select "Static" for **PSB type** and one of the following is true:
 - You enter no database name and there is more than one database PCB in the specified PSB, or
 - You enter a database name and there is more than one PCB for the database in the PSB, or
 - You enter a database name pattern and the PSB has PCBs for databases with names that match the pattern.
 - Displays a list of the PCBs in the specified PSB.
 - Database Selection panel
 - Displayed when you enter no database name or a database name pattern and select Dynamic for the PSB type.
 - Displays a list of the DBDs in the DBD libraries for the specified subsystem.

If the DBD libraries for the subsystem are not fixed, you specify the DBD libraries for the subsystem on the PSB and DBD Data Sets panel (option 0.6.7). If the DBD libraries for the subsystem are fixed, the FM/IMS administrator specifies the DBD libraries for the subsystem at installation time.

- AGN Selection panel
 - Displayed when all of these are true:
 - You select "BMP" for **Region type**.
 - The specified subsystem uses AGNs and has some of them listed in the FM/IMS installation options module.
 - You enter no AGN name or an AGN name pattern.
 - Displays the AGNs for the subsystem that are listed in the FM/IMS installation options module.

On each selection panel that is displayed, enter **s** in the **Cmd** field adjacent to the item you want to select and press Enter.

8. If you selected "Existing" for **Criteria usage** and the **Edit criteria** option or "New" for **Criteria usage**, the Criteria : Subset Selection panel is displayed. This is the first panel in the Edit criteria dialog. This dialog allows you to create or edit your criteria.

Steps [9 on page 164](#) to [15 on page 165](#) illustrate how you create criteria for your extract.

9. Type **E** against the **Relationship Criteria** and press Enter.
10. Enter the following Max Occurrences to pursue per DB Record

```

FM/IMS                                Relationship Criteria

Criteria New
Template FMN.IMS.IVP.TEMPLATE(DJ2E)

Default max relationship occurrences to pursue          (Blank for no limit)

      Source      Source      Target
Cmd Sel DBD      segment  DBD      Relationship type  Max occurrences to
      *  DJ2E     LINKSTR  DJ3E     Bidirectional     2
      *  DJ2E     INSHIRE  DJ1E     Bidirectional     1
      *  DJ3E     INSUB   DJ2E     Bidirectional     1
      *  DJ1E     LINKSUB  DJ2E     Bidirectional     1
**** End of data ****
    
```

11. Press Enter.
12. Type **I** against the Relationship criteria to create Field Selection criteria subset and press Enter.

The **Criteria: Segment Selection** panel is displayed.

13. Type **E** against the SUBURB segment and press Enter.

The **Criteria: Segment Layout** panel is displayed.

14. Under the **Field Selection Criteria**, type **#2=FREMANTLE** and press Enter.

The top right screen displays **Retrieving with qual SSA**. If you press the **Help function key (F1)**, the extended message is displayed.



Note: The message is only displayed if you have specified a key in the selection criteria where FM/IMS retrieves using qualified SSA's for improved performance.

15. Press the Exit function key (F3) three times to save the criteria.

The Extract Entry panel is redisplayed. The top right corner of this panel displays the message, *“Criteria Set saved”*.

16. Press Enter.

The **Extract: To Data Set Specification** panel is displayed.

17. Specify the data set name to extract the segments to and press Enter.

The JCL is displayed.

18. Submit the JCL.

The report specifies the database extract details including the number of segments of each segment type extracted.



Note: The minimum region size is 2M.

Example logical relationships

This relationship diagram shows how the logical relationships for the Suburb segment with a key of **FREMANTLE** are extracted.

Figure 19. Logical relationships for DJ2E database

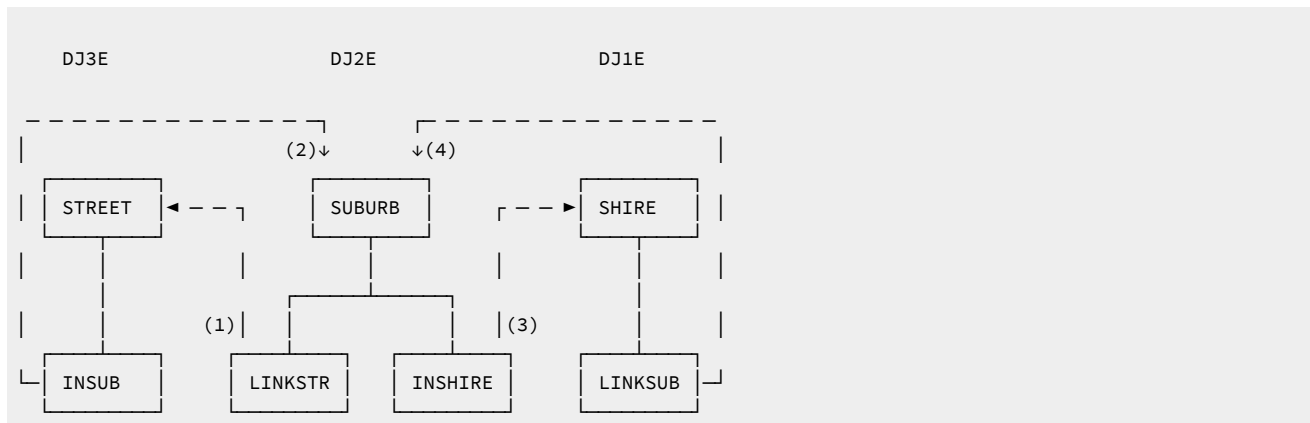

Normally in the extract process, logical relationships are chased after all the database records in the primary database have been processed. In the following example, we are only extracting the Suburb FREMANTLE and all its dependents. The Relationship criteria on the previous page is used.

Firstly the root segment for Suburb FREMANTLE is selected and the LINKSTR and INSHIRE segments are written to the extract file.

For the logical relationship between INSHIRE and SHIRE we are only chasing one segment, hence the Shire of FREMANTLE is chased. This means:

1. The SHIRE root segment for FREMANTLE and all its dependents are written to the extract file.
2. The first logical relationship between LINKSUB and SUBURB is chased. This LINKSUB segment has a logical parent of BEACONSFIELD. This SUBURB segment has not previously been extracted so the database record for BEACONSFIELD is extracted.
3. For the logical relationship between INSHIRE and SHIRE for BEACONSFIELD we are only chasing one segment, hence the Shire of FREMANTLE is chased. The SHIRE segment for FREMANTLE has already been extracted, so no further chasing is required.

For the logical relationship between LINKSTR and STREET for BEACONSFIELD we are only chasing two segments, hence the Streets of AGNES ST and ANNIE ST (the first two streets in Beaconsfield, according to alphabetic order) are chased.

1. The STREET root segment of AGNES ST and all its dependents are written to the extract file.
2. The first logical Relationship between INSUB and SUBURB is chased. This LINKSUB segment has a logical parent of BEACONSFIELD, this has been extracted so no further chasing is required for AGNES ST.
3. The STREET root segment of ANNIE ST and all its dependents are written to the extract file.
4. The first logical Relationship between INSUB and SUBURB is chased. This LINKSUB segment has a logical parent of BEACONSFIELD. This database record has been extracted so no further chasing is required for ANNIE ST.

The logical relationships have all been chased for the INSHIRE and SHIRE segments that have a key value of FREMANTLE.

After the chasing for the INSHIRE logical relationship has completed, the logical relationship between LINKSTR and STREET is chased. For this relationship FM/IMS chases the first two occurrences of the LINKSTR segment. This means the following streets are processed:

- ADELAIDE ST
- ALMA ST

For ADELAIDE ST the following processing takes place:

1. The STREET root segment of ADELAIDE ST and all its dependents are written to the extract file.
2. The first logical Relationship between INSUB and SUBURB is chased. This LINKSUB segment has a logical parent of ESPERANCE. This DJ2E database record hasn't been processed so it is written to the extract file.
3. For the logical relationship between INSHIRE and SHIRE where the key is ESPERANCE only one occurrence is chased. Hence the SHIRE segment with a key of ESPERANCE is chased. This hasn't been processed so the DJ1E database record is extracted.
4. For the logical relationship between LINKSUB and SUBURB where the key is ESPERANCE only one occurrence is chased. Hence the SUBURB segment with a key of CASCADE is chased. This hasn't been processed so the DJ2E database record is extracted.

5. For the logical relationship between INSHIRE and SHIRE where the key is CASCADE only one occurrence is chased. Hence the SHIRE segment with a key of ESPERANCE is chased. This has been processed so the DJ1E database record is not extracted.
6. For the logical relationship between LINKSTR and STREET for the SUBURB of CASCADE only one occurrence is chased. Hence the STREET segment with a key of ASHA CT is chased. This hasn't been processed so the DJ3E database record is extracted.
7. The first logical Relationship between INSUB and SUBURB is chased. This LINKSUB segment has a logical parent of ESPERANCE. This has been processed so the DJ2E database record is not extracted.
8. For the logical relationship between LINKSTR and STREET for the SUBURB with a key of ESPERANCE only one occurrence is chased. Hence the STREET segment with a key of ADDINGTON CRO is chased. This hasn't been processed so the DJ3E database record is extracted.
9. The first logical Relationship between INSUB and SUBURB is chased. This LINKSUB segment has a logical parent of ESPERANCE. This has been processed so the DJ2E database record is not extracted.

Extract processing continues chasing logical relationships for SUBURB of FREMANTLE. For ALMA ST the following processing takes place:

1. The STREET root segment of ALMA ST and all its dependents are written to the extract file.
2. The first logical Relationship between INSUB and SUBURB is chased. This LINKSUB segment has a logical parent of FREMANTLE. This DJ2E database record has been processed so it is not written to the extract file.
3. Since there are no more logical relationships to chase, the extract process is terminated.

Related topics

[Working with Criteria on page 179](#)

Modifying the JCL to specify the KEYLIST, KEYRANGE and MAXROOTS parameters

The previous three subsections describe how you can use the Extract dialog to generate the JCL for a job that extracts data from your IMS databases. There are, however, three parameters you can use that the Extract dialog does not generate.

These are the KEYLIST, KEYRANGE and MAXROOTS parameters.

The KEYLIST parameter allows you to specify a list of the root segment key values of the database records that you want extracted. You can, of course, specify this list in a keys file, but this parameter provides you with an alternative way of specifying the key list. Unlike the keys file, however, the KEYLIST parameter also allows you to specify partial keys - if the length of a specified root key value is less than the key length of the root segment, the function considers it to be the first part of the key and extracts all those database records with root key values that match the partial key value.

The KEYRANGE parameter allows you to specify the start and end of a range of root key values. The function extracts those database records that have a root key value in the specified range.

The MAXROOTS parameter allows you to limit the number of database records that the function extracts. When this parameter is specified, the function counts the number of database records that it has extracted and terminates when it reaches the specified limit.

For information on how you code these parameters, see [Extract \(IXB\) on page 539](#).

Extracting and loading DEDB databases with sequential dependent segments

Sequential dependent (SDEP) segments are stored in the sequential dependent part of the DEDB area in the chronological order in which they were inserted without regard to the root or unit of work (UOW) that contains the root. The SDEP segment is then retrieved in a last-in first-out (LIFO) sequence by DL/I calls. Hence, when they are viewed, SDEP segments under a single root are in reverse of the insertion sequence.

Example database after inserting six SDEP segments under two different roots:

```
CUSTROOT  ..00000001 CUSTROOT SEGMENT
CUSDEPSG  .. 5TH SEGMENT INSERTED
CUSDEPSG  .. 4TH SEGMENT INSERTED
CUSDEPSG  .. 1ST SEGMENT INSERTED
CUSTROOT  ..00000010 CUSTROOT SEGMENT
CUSDEPSG  .. 6TH SEGMENT INSERTED
CUSDEPSG  .. 3RD SEGMENT INSERTED
CUSDEPSG  .. 2ND SEGMENT INSERTED
```

The design of the SDEP segments allows for better performance when inserting SDEP segments or when processing the SDEP segments using the Sequential Dependent Scan or Sequential Dependent Delete Fast Path utilities. However reading the sequential dependent segments via DL/I calls is slower.

Sample result of the sequential scan utility:

```
1ST SEGMENT INSERTED
2ND SEGMENT INSERTED
3RD SEGMENT INSERTED
4TH SEGMENT INSERTED
5TH SEGMENT INSERTED
6TH SEGMENT INSERTED
```

The SDEP segments can only be deleted by deleting their root segments or by using the IMS Fast Path Sequential Dependent Delete Utility. Since IMS only allows sequential dependent segments to be inserted and not replaced, care must be taken when loading DEDB databases with SDEP segments to avoid duplicate segments being created.

To avoid duplicating SDEP segments, the Fast Path Sequential Dependent Delete Utility can be run to remove the existing SDEPs. When running this utility you need to consider the following:

- Prior to running the Utility, you may want to run the Fast Path Sequential Dependent Scan utility to read the SDEPs to be deleted.
- The Sequential Dependent Delete utility removes the SDEPs from the earliest SDEP inserted until a point you specify. There is no way to specify individual root segment sequential dependents, so be aware you may be deleting other user's data.



Note: For more information on the Fast Path Sequential Dependent Scan and Sequential Dependent Delete Utilities, please refer to the IMS Utilities Reference: Database and Transaction Manager.

Extracting SDEP segments

FM/IMS allowed two possible methods to order extracted SDEP segments:

Reverse-retrieval order (default)

This method reverses the SDEPs order from their retrieval sequence. Loading SDEPs in this order restores their sequence under each root but does not restore the sequence as seen by the sequential scan utility.

Sample result as viewed in the database:

```
CUSTROOT ..00000001 CUSTROOT SEGMENT
CUSDEPSG .. 5TH SEGMENT INSERTED
CUSDEPSG .. 4TH SEGMENT INSERTED
CUSDEPSG .. 1ST SEGMENT INSERTED
CUSTROOT ..00000010 CUSTROOT SEGMENT
CUSDEPSG .. 6TH SEGMENT INSERTED
CUSDEPSG .. 3RD SEGMENT INSERTED
CUSDEPSG .. 2ND SEGMENT INSERTED
```

Sample result of the sequential scan utility:

```
2ND SEGMENT INSERTED
3RD SEGMENT INSERTED
6TH SEGMENT INSERTED
1ST SEGMENT INSERTED
4TH SEGMENT INSERTED
5TH SEGMENT INSERTED
```

SDEP Timestamp order

This method attempts to place the retrieved SDEP segments into their original insertion order by reading their timestamps with the POS DL/I call. The timestamps are written to the unload file with the SDEP segments. This method is more costly because of the POS call overhead, however, loading SDEPs in this order restores both their order under each root as well as the sequence as seen by the sequential scan utility.

Sample result as viewed in the database:

```
CUSTROOT ..00000001 CUSTROOT SEGMENT
CUSDEPSG .. 5TH SEGMENT INSERTED
CUSDEPSG .. 4TH SEGMENT INSERTED
CUSDEPSG .. 1ST SEGMENT INSERTED
CUSTROOT ..00000010 CUSTROOT SEGMENT
CUSDEPSG .. 6TH SEGMENT INSERTED
CUSDEPSG .. 3RD SEGMENT INSERTED
CUSDEPSG .. 2ND SEGMENT INSERTED
```

Sample result of the sequential scan utility:

```
1ST SEGMENT INSERTED
2ND SEGMENT INSERTED
3RD SEGMENT INSERTED
```

```
4TH SEGMENT INSERTED
5TH SEGMENT INSERTED
6TH SEGMENT INSERTED
```

To use this extract method, check the **SDEP in timestamp order** option on the Extract Entry panel when generating the extract JCL, or manually specify the SDEPTSO JCL option in the IXB function.

Creating an extract template

With Extract (option 3.3), you can optionally create an extract template. The extract template is a composite File Manager Base component template derived from one or more IMS templates to describe the extracted data.

You can use the extract template with the File Manager Base component utilities to:

- Edit, view, or browse the extract file. For example:

You might have copies of the same IMS™ database information loaded under similar DBD names. This allows multiple IMS™ environments using similar data. Once the FM/IMS extract is completed, you can use the template created by the extract to change the database names and update other data in a formatted view.

- Scramble fields on the output file using the DSC function.

How an extract template is created

The extract template is derived from:

- The template for the primary database of the extract, and
- The templates for all the databases that are logically related to the primary database.

The extract process combines the field definitions found in these templates with the field definitions of the extract header records and prefix areas to produce a base extract template that describes all the different types of extract records for the current extract process.

How to create an extract template

To create an extract template, perform these steps:

1. From the Primary Option menu, select **Extract** (option 3.3). The Extract Entry panel is displayed.
2. Enter details for the type of extract you want to perform:
 - See [Creating a full copy of a database on page 157](#).
 - See [Partial extract using a Keys file on page 159](#).
3. Select the **Create extract template** option on the Extract Entry panel and press Enter. FM/IMS displays the Extract Options panel.

The Extract Options panel allows you to:

- Create the extract template in foreground.
 - Edit the created extract template.
 - Generate keywords so the extract template can be created as a part of the batch extract job.
4. On the Extract Options panel, enter details for these fields as required:

Extract Template: Data set name

This is a required field. Specify a fully-qualified or generic data set name that identifies the data set where the extract template is to be stored. If the member name is the same as any of the input IMS templates, then the data set must be a different name to the input template data set name.

Extract Template: Member

This field is the member name . Specify the name of a member of a partitioned data set for the extract template. If you leave this field blank or specify a member name pattern, FM/IMS displays a member name list. You can then select the required member by entering `s` in the select field for the appropriate member.

5. On the Extract Options panel, select these options as required:

Foreground

Select this option if you want the extract template to be created in foreground. If selected, FM/IMS creates the template when you press Enter.

Batch

Select this option if you want your extract job to create the extract template. If selected, FM/IMS generates the keywords that the batch extract requires to create the extract template.

Skip

Select this option if you do not want to create an extract template.

Edit extract template

Select this option if you want to edit the template. When you select this option and the **Foreground execution** option, FM/IMS creates the template when you press Enter and then displays the Record Type Selection panel so that you can edit and save the template. FM/IMS only uses this field when the **Foreground execution** option is selected.

6. Press Enter to perform the function as determined by the processing options and continue with the extract dialog, or press PF3 to return to the previous panel without performing the function.

Related topics

[Record Type Selection panel on page 362](#)

Extract template naming conventions.

The extract header records have these names:

HEADER-DYNAMIC

Dynamic PSB header record

HEADER1-STATIC

Static PSB first header record

HEADER2-STATIC

Static PSB subsequent header record

The extracted IMS segment records have this naming convention:

```
dbd-segment-01name
```

where:

dbd

The DBD name.

segment

The segment name.

01name

The name of the 01 layout describing this segment as given in the originating template.



Note: The dash separator ("-") is replaced with an underscore ("_") when the originating IMS templates are built from PL/I copybooks.

Extract reports

The Database Extract Summary reports the options and resources that the Extract used.

The Database Extract Statistics Report provides extract statistics including the number of occurrences of each segment type extracted from each database.

Related topics

[Database Extract Summary report on page 561](#)

[Database Extract Statistics report on page 563](#)

Loading data

You can use **Load (option 3.4)** to load data that was previously extracted with the FM/IMS **Extract (option 3.3)** utility into a database.

Load can use a Dynamic PSB or a Static PSB.

There are three types of loads:

No replace

The Load only attempts to insert the segment. If the Insert call receives an II status code, the Load does not replace the existing segment in the database with the load segment.

Replace

The Load attempts to insert the segment as it does for No replace. However, if the Insert call receives an II status code, the Load replaces the existing segment in the database with the load segment. Note: If a segment has a non-unique key or no key, existing segments in the database are not replaced. The load segments will be inserted even when there is an existing segment in the database with the same key.

Initial

This uses a Load PSB to insert the IMS segments into an empty, uninitialized database. If the database has not yet been emptied, you can use the **Delete/define data sets** option to prepare the files.



Restrictions: FM/IMS load process cannot be used to recover logically related databases with pointer errors. Such problems should be addressed by utilizing the IMS utilities.

The tasks described in this section are:

[Loading into an initialized database on page 173](#)

[Loading into an uninitialized database on page 175](#)

[Load reports on page 177](#)

Loading into an initialized database

You can use the **No replace** or the **Replace** option to load data into a database that has been initialized or already contains data. These options can be used in conjunction with a Static or Dynamic PSB.

To load data into an initialized IMS database:

1. Select option **3 Utilities** from the Primary Options Menu and then option **4 Load** from the Utility Menu. The Load Entry panel is displayed.
2. Notice that many of the fields on the Load Entry panel are also on the Browse Entry panel. To fill out the fields that are common to both panels, follow one of these sets of instructions according to which Region type and PSB type you want the Load to use:
 - Steps 2, 3, 4, 5, 7 and 8 in [Accessing in BMP mode using a Static PSB on page 49](#).
 - Steps 2, 3, 4, 6 and 7 in [Accessing in BMP mode using a Dynamic PSB on page 51](#).
 - Steps 2, 3, 4, 6, 7, 8 and 10 in [Accessing in DLI mode using a Static PSB on page 52](#).
 - Steps 2, 3, 5, 6, 7 and 9 in [Accessing in DLI mode using a Dynamic PSB on page 55](#).
3. In the **Load type** field, enter either **1** if you do not want the Load to replace existing database segments or **2** if you do want existing segments replaced with the load segment.

4. Press Enter to process the data you entered. According to what you entered on the panel, one or more of these panels may be displayed in the order they are listed:

- Subsystem Selection panel
 - Displayed when you enter no subsystem name or a subsystem name pattern.
 - Displays a list of IMS subsystems defined by the FM/IMS administrator at installation time.
- PSB Selection panel
 - Displayed when you enter no PSB name or a PSB name pattern and select "Static" for **PSB type**.
 - Displays a list of the PSBs in the PSB libraries for the specified subsystem.

If the PSB libraries for the subsystem are not fixed, you specify the PSB libraries for the subsystem on the PSB and DBD Data Sets panel (option 0.6.7). If the PSB libraries for the subsystem are fixed, the FM/IMS administrator specifies the PSB libraries for the subsystem at installation time.

- PCB Selection panel
 - Displayed when you select Static for the PSB type and one of the following is true:
 - You enter no database name and there is more than one database PCB in the specified PSB or
 - You enter a database name and there is more than one PCB for the database in the PSB or
 - You enter a database name pattern and the PSB has PCBs for databases with names that match the pattern
 - Displays a list of the PCBs in the specified PSB.
- Database Selection panel
 - Displayed when you enter no database name or a database name pattern and select "Dynamic" for **PSB type**.
 - Displays a list of the DBDs in the DBD libraries for the specified subsystem.

If the DBD libraries for the subsystem are not fixed, you specify the DBD libraries for the subsystem on the PSB and DBD Data Sets panel (option 0.6.7). If the DBD libraries for the subsystem are fixed, the FM/IMS administrator specifies the DBD libraries for the subsystem at installation time.

- AGN Selection panel
 - Displayed when all of these are true:
 - You select "BMP" for **Region type**
 - the specified subsystem uses AGNs and has some of them listed in the FM/IMS installation options module.
 - You enter no AGN name or an AGN name pattern.
 - Displays the AGNs for the subsystem that are listed in the FM/IMS installation options module.

On each selection panel that is displayed, enter **s** in the **Cmd** field adjacent to the item you want to select and press Enter.

5. If you selected "DLI" for **Region type** and did not select the **Skip DB data set panel** option, either the Database Data Set Display or the Database Data Set Specification panel is displayed.
- The Database Data Set Display panel is displayed when a database that is a HALDB or a subsystem that is defined as dynamic allocation only is selected on the Load Entry panel. This panel displays the names of the database data sets that the function will use. Verify that the database data sets listed are the ones you want

the function to use. To confirm usage of these data sets and to proceed to the next panel in the dialog, press Enter.

- The Database Data Set Specification panel is displayed when a database that is not a HALDB and a subsystem that is not defined as dynamic allocation only is selected on the Load Entry panel. If you selected "User profile" for the **Fetch DB dsnames from** option, it displays the data set names saved in your user profile. If you selected "DFSMDA members" for the **Fetch DB dsnames from** option, it displays the data set names specified in the DFSMDA dynamic allocation members for the subsystem.

The Database Data Set Specification panel is displayed when the **Skip DB data set panel** option is not selected, but it is also displayed when the **Skip DB data set panel** option is selected and one of the following conditions is true:

- FM/IMS fails to obtain all the required data set names from either your user profile or the DFSMDA members.
- One or more of the database data sets does not exist or has an invalid data set organization.

If the displayed data set names are not the ones you want the function to use or no data set names are displayed, enter the data set names that you want the function to use and press Enter. To confirm usage of the displayed data set names and to proceed to the next panel in the dialog, press Enter once more.

6. On the Load Options panel, specify the **Load from:** data set details. This must be a sequential file containing data previously extracted using the FM/IMS Extract utility.
7. Press Enter. FM/IMS uses the data you specified in the dialog to generate JCL for the Load job. You can edit the JCL before submitting the job. Submit the JCL.



Note: The minimum required region size is 2M.

Loading into an uninitialized database

You can use the Initial option to load data into an uninitialized database. This option only supports Dynamic PSBs and DLI region types. The database must have already been emptied using the **Delete/Define data sets** utility or you must select the **Delete/define data sets** option during this process.

To load data into an uninitialized IMS database:

1. Select option **3 Utilities** from the Primary Option Menu and then option **4 Load** from the Utility Menu. The Load Entry Panel is displayed.
2. In the **Subsystem name** field, enter the ID of the IMS subsystem that the database you want to access is defined in, or if you want to select the required subsystem from a list, enter a subsystem name pattern or leave the field blank.
3. In the **Database name** field, enter the name of the database that you want to access, or if you want to select a database from a list of DBDs, enter a database name pattern or leave the field blank.
4. In the **PSB type** field, enter **1** to select a dynamic PSB.
5. In the **Region type** field, enter **1** to select a DL/I batch processing region.
6. If you selected a database that is not a HALDB and an IMS subsystem that is not a dynamic allocation only subsystem, in the **Fetch DB dsnames from** field:

- Enter **1** if you want the function to use the database data sets whose names were saved in your user profile.
 - Enter **2** if you want the function to use the database data sets specified in the DFSMDA dynamic allocation members.
7. In the **Load type** field, enter **3** to select a Load that uses a load PSB (PROCOPT=L).
8. If you want to skip the display of the Database Data Set Specification or the Database Data Set Display panel, enter "/" in the **Skip DB data set panel** field.
9. Press Enter to process the data you entered. According to what you entered on the panel, one or more of these panels may be displayed in the order they are listed:
- Subsystem Selection panel
 - Displayed when you enter no subsystem name or a subsystem name pattern.
 - Displays a list of IMS subsystems defined by the FM/IMS administrator at installation time.
 - Database Selection panel
 - Displayed when you enter no database name or a database name pattern.
 - Displays a list of the DBDs in the DBD libraries for the specified subsystem.
- If the DBD libraries for the subsystem are not fixed, you specify the DBD libraries for the subsystem on the PSB and DBD Data Sets panel (option 0.6.7). If the DBD libraries for the subsystem are fixed, the FM/IMS administrator specifies the DBD libraries for the subsystem at installation time.

On each selection panel that is displayed, enter **s** in the **Cmd** field adjacent to the item you want to select and press Enter.

10. If you did not select the **Skip DB data set panel** option, either the Database Data Set Display or the Database Data Set Specification panel is displayed.
- The Database Data Set Display panel is displayed when a database that is a HALDB or a subsystem that is defined as dynamic allocation only is selected on the Load Entry panel. This panel displays the names of the database data sets that the function will use. Verify that the database data sets listed are the ones you want the function to use. To confirm usage of these data sets and to proceed to the next panel in the dialog, press Enter.
 - The Database Data Set Specification panel is displayed when a database that is not a HALDB and a subsystem that is not defined as dynamic allocation only is selected on the Load Entry panel. If you selected "User profile" for the **Fetch DB dsnames from** option, it displays the data set names saved in your user profile. If you selected "DFSMDA members" for the **Fetch DB dsnames from** option, it displays the data set names specified in the DFSMDA dynamic allocation members for the subsystem.

The Database Data Set Specification panel is displayed when the **Skip DB data set panel** option is not selected, but it is also displayed when the **Skip DB data set panel** option is selected and one of the following conditions is true:

- FM/IMS fails to obtain all the required data set names from either your user profile or the DFSMDA members.
- One or more of the database data sets does not exist or has an invalid data set organization.

If the displayed data set names are not the ones you want the function to use or no data set names are displayed, enter the data set names that you want the function to use and press Enter. To confirm usage of the displayed data set names and to proceed to the next panel in the dialog, press Enter once more.

11. On the Initial Load Options panel, specify the **Load from:** data set details. This must be a sequential file containing data previously extracted using the FM/IMS Extract utility.
12. If you have specified DBRC in option 0.6.1, enter the name of the data set containing the DBRC skeleton in the **Image copy skeleton: Data set name** field. This is used to generate an IMS image copy job for the database. Sample skeletons are found in the IMS Proclib data set.



Note: The use of DBRC is required for HALDB databases, so this option must be selected to initialize a HALDB.

13. If you have not yet emptied the database, select the **Delete/Define DB` data sets** option.
14. If you are using DBRC and you want the JCL generated for the database to issue the GENJCL.IC DBRC command to generate an IMS image copy, select the **Submit image copy** option. This generated image copy job is submitted to the internal reader.

If this option is not selected, you must run your site's external jobs to issue this command, as the database is unusable until an image copy has been run.

15. Press Enter. FM/IMS uses the data you specified in the dialog to generate JCL for the Load job. You can edit the JCL before submitting the job. Submit the JCL.



Note:

The minimum required region size is 2M.

Load reports

The Load produces these reports:

- The Database Load Summary
- The Database Load Statistics Report
- The Database Load Diagnostic Reports (only when diagnostics are issued)

The Database Load Summary reports the options and resources that the Load used.

The Database Load Statistics Report provides load statistics including the number of occurrences of each segment type loaded into each database.

The Database Load Diagnostic Report provides the details of each segment occurrence that could not be loaded including its type, its concatenated key, its data and the IMS status code that the attempted insert received.

Related topics

[Database Load Summary report on page 576](#)

[Database Load Statistics report on page 575](#)

[Database Load Diagnostic report on page 578](#)

Chapter 8. Working with Criteria

When you use the Extract dialog (option 3.3) to generate a batch job that extracts segments from IMS databases, you can specify a *criteria set* to determine:

- the segments to be extracted.
- the database records (root and all dependents) to be extracted using field selection criteria.
- how logical relationships between databases are extracted using Relationship Criteria.

A criteria set contains one relationship criteria subset and up to n subsets containing field selection criteria for determining the database records to be extracted.

Each field selection criteria subset is applied to a database record separately. Duplicate records are removed using a sort utility after the extract is completed.

You can create and edit a criteria set in the Extract dialog, or you can use Criteria (option 4.3) to create and edit a criteria set for later use.

Before you can create a criteria set, you must already have created a template for the associated database.

Within a subset, you can specify criteria for each segment type in the database (for segment types with more than one layout, you can specify criteria for each layout). If a root segment and all of its hierarchical dependents (at every level) match their criteria, then the root segment is extracted, along with all of its dependents. However, if any segment does not match its criteria, then its root segment, and all of the root segment's hierarchical dependents, are **not** extracted.

A criteria set always contains a “*relationship*” criteria subset. If the database contains logical relationships, then you can use this subset to determine if FM/IMS extracts an occurrence of a logical relationship.

Related topics

[Creating a template on page 82](#)

Criteria Set Entry panel

From the Criteria Set Entry panel, you are able to:

- Create a criteria set from a template (CT command).
- Model the criteria set on an existing criteria set (CM command).
- Edit the criteria sets (with the E command) to maintain:
 - field selection criteria
 - logical relationship criteria
 - segments to be extracted
- Update the criteria set using a template that has been previously updated (U command).

These commands (CT, CM, E, U) are explained below.

Create a Criteria Set using a template (CT)

1. Select option **4 Templates** from the **Primary Option menu** to display the **Template/View/Criteria Set menu**.
2. Select option **3 Criteria sets** to display the **Criteria Set Entry** panel.
3. On the **Criteria Set Entry** panel, enter the details for the criteria sets you want to create.
 - In the Template **Data set name** field, specify a fully-qualified or generic data set name to identify the required data set (which must be partitioned). Fill in the template member name, or enter a template name pattern to be able to select the template from the **Template Member Selection list**.
 - In the Criteria **Data set name** field, specify a fully-qualified or generic data set name to identify the required data set. If the data set is partitioned, fill in the criteria set member name, or enter a criteria set member name pattern to be able to select a criteria set from the **Criteria Member Selection list** if you want to replace an existing criteria set.
4. Then type **CT** on the command line and press **Enter**.
5. After the criteria set is created you can edit it by using the E command described below.

Create a Criteria Set from model (CM)

1. Select option **4 Templates** from the **Primary Option menu** to display the **Template/View/Criteria Set menu**.
2. Select option **3 Criteria sets** to display the **Criteria Set Entry** panel.
3. On the **Criteria Set Entry** panel, enter the details for the criteria sets you want to create.
 - In the Criteria **Data set name** field, specify a fully-qualified or generic data set name to identify the required data set. If the data set is partitioned, fill in the criteria set member name, or enter a criteria set member name pattern to be able to select a criteria set from the **Criteria Member Selection list**.
 - In the Model Criteria **Data set name** field, specify a fully-qualified or generic data set name to identify the required data set. If the data set is partitioned, fill in the model member name, or enter a model name pattern to be able to select the criteria set from the **Model Member Selection list**.
 - Then type **CM** on the command line and press **Enter**.
 - After the criteria set is created you can edit it by using the E command described below.

Edit Criteria Set (E)

The **E** command allows you to maintain the field selection and relation criteria for a criteria set.

1. Select option **4 Templates** from the Primary Option menu to display the Template/View/Criteria Set menu.
2. Select **option 3 Criteria** sets to display the Criteria Set Entry panel.
3. In the Criteria **Data set name** and **Member** fields, enter the details for the criteria set you want to edit.
4. Type **E** on the command line and press Enter.

FM/IMS displays the Criteria : Subset Selection panel. From this panel you are able to maintain Relationship criteria and Field Selection Criteria.

Related topics

[Changing Relationship Criteria on page 183](#)

[Changing Field Selection Criteria on page 185](#)

Updating criteria sets

If you have updated a template, then you need to update all the criteria sets based on the template.

This update process can be done in either one of two ways:

- Selecting option 3 Criteria Sets from the Template/View/Criteria Set menu
- Selecting option 6 Criteria update from the same menu.

Updating one criteria set in the foreground using option 4.3

1. Select option **4 Templates** from the **Primary Option menu** to display the **Template/View/Criteria Set menu**.
2. Select option **3 Criteria sets** to display the **Criteria Set Entry** panel.
3. In the Criteria **Data set name** field, specify a fully-qualified or generic data set name to identify the required data set. If the data set is partitioned, fill in the criteria set member name, or enter a criteria set member name pattern to be able to select the criteria set from the **Criteria Member Selection** list.
4. Then type `u` on the command line and press **Enter**.
5. If the process detects that there has been a change to the template that warrants an update of the criteria set, a "Criteria set updated? message is displayed. The criteria set is then updates with the new information found in the template. You can now edit the criteria set, to account for any changes in segments. If the criteria set is still valid for the current template then a "Update not required? will be displayed.

If significant changes have been made to the template, then the update process might not produce the expected results. In this case, use the `CT` command to recreate the criteria set from the template and then the `E` command to edit it.

Related topics

[Criteria Member Selection panel on page 224](#)

[Criteria Set Entry panel on page 226](#)

[Primary Option menu on page 346](#)

[Template/View/Criteria Set Menu panel on page 423](#)

Updating one or more criteria sets in the foreground or as a batch job using option 4.6

The **Criteria set Update Utility** allows you to update one or more criteria sets in either foreground or batch. The criteria sets you want to process can be filtered on either or both:

- Criteria set name pattern (if you fill in one complete criteria set name only that one criteria set will be processed)
- Up to four template names or patterns

You can also select to use the Advanced member selection option. Then it is possible to select or filter using one or more of:

- Select criteria sets in a name range
- Filter by userid (or a pattern or range) by whome the criteria set was updated
- Filter by Date created (or pattern or range)
- Filter by Date modified (or pattern or range)

Here is how you update one criteria or more sets in the foreground or as a batch job using option 6:

1. Select option **4 Templates** from the **Primary Option menu** to display the **Template/View/Criteria Set menu**.
2. Select option **6 Criteria set update** to display the **Criteria set Update Utility** panel.
3. On the **Criteria set Update Utility** panel, enter the details to select the criteria sets you want to update:
 - In the Criteria set **Data set name** field, specify a fully-qualified or generic data set name to identify the data set (which must be partitioned).
 - In the Criteria set **Member** field, you can specify a criteria set name or a criteria set name pattern.
 - In the **Template filter** field, you can specify up to four member names or patterns to be used as a filter so that only criteria sets referencing those templates, or templates that match the member patterns, are selected for processing.
 - In the Output Criteria set **Data set name** field, you can specify a fully-qualified or generic data set name to identify the output data set where the updated criteria sets are to be stored. If you leave this field blank, then the update takes place on the input data set.
 - In the Output Criteria set **Member mask** field, you can specify a rename mask so that the updated templates are stored under an alternative name.
 - In the Template **Data set name** field, specify a fully-qualified or generic data set name to identify the data set (which must be partitioned).
4. Select the processing options:
 - **Batch execution** to run the function in batch.
 - **Replace member** to replace like-named members in the output partitioned data set.
 - **Advanced member selection** to specify a range of members to be selected, rather than a specific or generic member name.
 - **Specify template data sets** to update the template data set name referenced in the criteria set with this template dataset. If this option is not selected, the utility uses the template data set referenced in the criteria set.
 - **Skip member list** to run without showing the member selection list. This option bypasses the member list panel and processes all the qualifying members. If an error (like a duplicate output name) results from the specified parameters, then the member list panel is displayed with the errors highlighted.
 - **Check mode - no update** to run the function without saving the resulting members.
 - **Forced update** if you want to perform the update when no changes have been detected.
5. Press **Enter**.

First all datasets specified as generic will be searched for and you need to select the wanted datasets. Then, depending on what options are selected, the following panels will be displayed.

6. If **Advanced member selection** was selected then the **Advanced Member Selection** panel is displayed. Here you can specify a combination of criteria set name pattern, or a range of criteria set names, and updated by userid (or pattern or range), and date created (or pattern or range), and date modified (or pattern or range).

7. Press **Enter**.

Unless you have selected **Skip member list** then the **Criteria set Member Selection** panel is displayed. Press F11 (Right) to scroll right to display the Description column, and F10 (Left) to return to the original display.

8. In the prefix area (**Sel**), type any of the following prefix commands and press Enter to perform the associated action:

B

The member is displayed using the ISPF Browse panel (not the File Manager Browse panel).

E

The member is displayed in the Subset Selection panel.

V

The member is displayed using the ISPF Criteria set panel.

S

Select one or more members to be processed.

When the S command is entered for the criteria sets you want to process, press **Enter**. If you want to select all members that are displayed, you can use the primary command SELECT with the “*?” parameter.

9. If **Batch execution** was selected then the **JCL** will be generated. Else the process that is ordered is executed and a message is displayed to inform you of the result of the action performed. If any of the updates fails an error message is displayed and the status for each member is displayed in the **Prompt** field.

When you get back to the **Criteria Set Update Utility** panel you will get a summary message that will be similar to this:

```
47 members read 33 Updated 8 Not changed 0 Not replaced 6 Errors
```

Related topics

[Advanced Member Selection panel on page 192](#)

[Criteria Member Selection panel on page 224](#)

[Criteria Set Update Utility panel on page 229](#)

[Primary Option menu on page 346](#)

[Subsystem Selection panel on page 401](#)

[Template/View/Criteria Set Menu panel on page 423](#)

Changing Relationship Criteria

From the Criteria : Subset Selection panel, FM/IMS allows you to change the way FM/IMS chases logical relationships (if the database contains logical relationships).

1. Type **E** against the Relationship criteria subset.
2. Press Enter.

FM/IMS displays the Relationship criteria panel.

From the Relationship criteria panel you are able to:

- determine the logical relationships FM/IMS is to chase in extracting data.

This is done by typing **S** against the logical relationship to deselect it. During extract FM/IMS does not pursue this logical relationship.

- the number of logical relationships chased for each database record.

This is done by specifying a numeric value in 'Max Occurrences to pursue per DB Record' field against each logical relationship. The **Default Max relationship occurrences** to pursue field is used if a value has not been specified against the logical relationship.

This way FM/IMS can build a small subset of the database for testing purposes.

This relationship diagram shows how the logical relationships for the Suburb segment with a key of **FREMANTLE** are extracted.

Figure 20. Logical relationships for DJ2E database

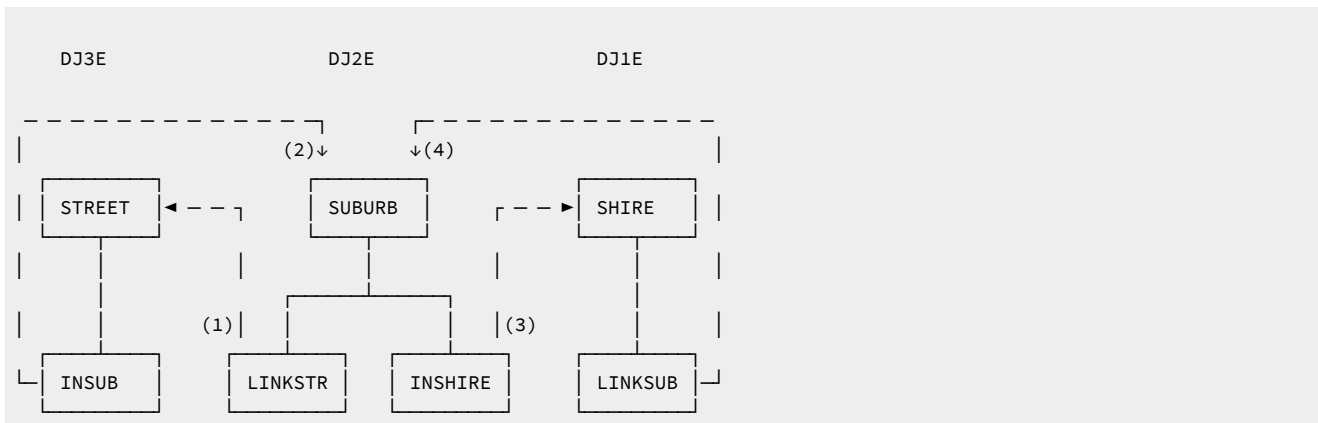

Specifying the logical relationships to chase means you can limit the data to be extracted.

For example it is possible to extract the information for FREMANTLE and WEST PERTH from the logically related databases but not include any other suburbs. This is done by not chasing the logical relationships between

- INSUB and SUBURB
- LINKSUB and SUBURB

Hence Street names which also exist in other suburbs are not extracted. Also the shires with other suburbs apart from FREMANTLE and WEST PERTH are not extracted.

To ensure that a relationship is not chased, deselect it on the Relationship Criteria panel.

Changing Field Selection Criteria

To edit an existing field criteria subset, type **E** against the field criteria subset. FM/IMS displays the Segment Selection panel for the criteria subset. To create a new field criteria subset, type **I** against any of the criteria subsets. FM/IMS displays the Segment Selection panel for the new criteria subset. From the Segment Selection panel, you are able to determine the segments FM/IMS extracts. If you were to change this in one criteria subset then this changes the segments to be extracted for all FM/IMS criteria subsets in this criteria set.

Also, from this panel you are able to maintain the Field Selection Criteria to determine what database records are extracted. If you have multiple criteria subsets, FM/IMS extracts the data matching each of the criteria subsets and then sorts the data to remove duplicate records.

1. Type **E** against an IMS segment.
2. Press Enter.

FM/IMS displays the selection:

- Criteria Segment Layout Selection panel (if segment contains multiple layouts).
- Criteria Segment Layout panel (if segment contains a single layout).

FM/IMS displays the Criteria Segment Layout panel, if the segment contains multiple layouts for the segments. FM/IMS allows you to place Field Selection criteria against each individual layout. For example, if the suburb segment had the city and country layouts, it is possible to only extract city suburbs starting with **F** and country suburbs starting with **S**.

1. Type **E** against the segment layout on the Segment Layout Selection panel, or against an IMS segment with a single layout on the Criteria Specification panel.
2. Press Enter.

From the Criteria Segment Layout panel, you are able to enter field selection criteria to be used to extract an IMS segment matching the criteria (if single layout) or an IMS segment using the required layout with criteria which matches the segment that has been specified for each layout (multiple layouts).

When extracting data, FM/IMS matches all data for segments and layouts for each criteria subset to determine if the database record (Root + dependants) is to be extracted or an IMS segment which matches the criteria specified for the layout and uses the particular layout. If any criteria fail, FM/IMS does not extract the database record. Multiple criteria subsets can be used to extract database records with different criteria.

Criteria 1

Extract segments starting with **S** that contain the **STREET CANNING HWY**.

Criteria 2

Extract segments with **POSTCODE > 6550** and have **STREET VICTORIA PARK**.

Chapter 9. Printing an audit trail report

The Print Audit Trail function (option 3.8) produces audit trail reports from user's audit log data sets. FM/IMS functions create audit log data sets when audit logging is required or, for Edit only, when a user requests audit logging.

What does the report contain?

The audit report consists of:

- Session information
- A log of audit events
- Audit trail statistics

The IMS segment data printed in the log of audit events may be formatted or unformatted. The unformatted mode is a hexadecimal printout. A formatted report prints the data according to the template which was used to edit the database.

How to create an audit trail data set

1. Use the batch job FMNSMFX (supplied with FM/IMS).

This job creates an audit trail data set using data from the SMF log file. For details, see the *File Manager Customization Guide*.

When you select the **Print audit trail report** option, the Data Create Utility panel shown in [Print Audit Trail panel on page 349](#) is displayed.

Use the Print audit trail report function to print an audit trail report using the contents of the audit trail data set. An audit trail data set is created if the **Create an audit trail** option is selected when you use the Edit option.

Related topics

[Edit Entry panel on page 266](#)

How to print an audit trail report

To print an audit trail report:

1. Specify the name of the audit trail data set that contains the audit trail data you want to print (**Data set name**).

If File Manager created the audit trail data set, the name is in the format *userid.IMSAUDIT.Dyyymmdd.Thhmmss* where:

userid

is the ID of the user

IMSAUDIT

is a constant that identifies the data set as an audit log (trail)

Dyymmdd

is the date File Manager created the audit trail data set

Tthmmss

is the time File Manager created the audit trail data set



Note: If the AUDITHLQ option is set in FMNPOPT (see *Customization Guide*), audit trail data sets have the name *audithlq.FMNLOG.Dyymmdd.Tthmmss*.

If you created the audit trail data set yourself, use the data set name you specified in the supplied batch job FMNSMFY. For details, see the *File Manager Customization Guide*.

2. To help identify your audit trail report, use the **Description** entry field. If the description contains embedded spaces, you must enclose it in quotation marks. The description you enter appears on the Formatted Audit Event Records section of the report.
3. Select the processing options you want:

Formatted print

Displays report entries in formatted character representation, rather than hexadecimal format.

Print only changed fields

Limits the amount of printed lines.

Delete data set after printing

Whether to keep or delete the data set after it is printed.

Browse report

The audit trail report is displayed immediately.



Note: The contents of the audit trail report are transferred to a SYSOUT class as specified by the **PRINTOUT** print option on the Set Print Processing Options panel. To browse the audit trail report, the **PRINTOUT** print option should be set to SYSOUT=c.

Related topics

[Set print processing options \(option 0.1\) on page 41](#)

Batch execution

To generate JCL for printing the audit trail report using a batch job.

1. Press Enter.

Audit Trail

Data set name

This is the name of the data set that contains the Audit Trail of the edit session you want to print. This data set can be created and filled by FM/IMS directly or it can also be populated from the SMF log file. To get the data from the SMF file, a job must be set up. A sample JCL is provided.

Description

The Audit Trail Description that is displayed in the Summary Statistics page of the Audit Trail report. If the description contains embedded spaces it must be enclosed in quotation marks.

Related topics

[Print Audit Trail panel on page 349](#)

SMF logfile retrieval JCL

Using the sort sysin statement as shown in this example, the SMF headers are removed, rendering the output in a format which can be handled by the FM/IMS print program.

Figure 21. SMF log file Retrieval

```
//EXTRACT EXEC PGM=IFASMFDP
//SYSPRINT DD SYSOUT=*
//SMFIN DD DISP=SHR,DSN=your.install.SMF.logfile
//DUMP DD DISP=(NEW,PASS,DELETE),DSN=whatever.you.wanna.callit,
// DCB=*.SMFIN,UNIT=unit,SPACE=(cyl,(prim,sec),RLSE)
//SYSPRINT DD SYSOUT=*
//SYSIN DD *
  INDD(SMFIN,OPTIONS(DUMP))
  OUTDD(DUMP,TYPE(your SMF rec id))
/*
//SORT EXEC PGM=SORT,COND=(0,LT)
//SYSUDUMP DD SYSOUT=0
//SYSPRINT DD SYSOUT=*
//SYSOUT DD SYSOUT=*
//SORTIN DD DISP=(OLD,DELETE,DELETE),DSN=*.EXTRACT.DUMP
//SORTOUT DD DISP=(NEW,CATLG,DELETE),DSN=whatever.you.wanna.callit,
// DCB=(RECFM=VB,LRECL=32756,BLKSIZE=32760),
// UNIT=unit,SPACE=(cyl,(prim,sec),RLSE)
//SORTWK01 DD UNIT=unit,SPACE=(cyl,(prim,sec),RLSE)
//SORTWK02 DD UNIT=unit,SPACE=(cyl,(prim,sec),RLSE)
//SORTWK03 DD UNIT=unit,SPACE=(cyl,(prim,sec),RLSE)
//SORTWK04 DD UNIT=unit,SPACE=(cyl,(prim,sec),RLSE)
//SYSIN DD *
  SORT FIELDS=(47,08,CH,A,
               11,04,CH,A,
               07,04,CH,A,
               15,04,CH,A,
               31,08,CH,A)
  INCLUDE COND=(6,1,CH,EQ,X'your SMF rec id')
  OPTION EQUALS
  OUTREC FIELDS=(1:1,4,5:19)
/*
```

Audit Trail report

The Audit Trail report has three parts:

- Session information
- A log of audit events
- Audit trail statistics

The heading on each page includes the date and time the report was printed. Beneath the heading is a Segment heading which is printed at the beginning of each database call. It consists of a sequential number assigned to each data base action, a description of the type of action (UPDATE/DELETE/INSERT) and when it was performed, date and time. The next line gives the segment name with an optional description and the segment level followed by RCDTYPE 1 and 2 values for multitype records. The third line list the concatenated key, separating each key with a ",". If any key is in a non-printable format, all the keys are printed on a three line hex format.

When is a checkpoint call issued?

FM/IMS issues a checkpoint call each time a SAVE command is entered and automatically after 'n' number of database updates. The 'n' is specified in the EDIT Checkpoint Frequency field in the DLI Mode Options panel (option 0.6.4) and BMP Mode Options panel (option 0.7.2), and activated via the **AUTOSAVE** command. The checkpoint calls are printed in the Audit Trail in a single line.

Detail Statistics Formatted

When the formatted report is printed, File Manager uses the same template/view specified during the EDIT session. The first column on the report list the level and field name as it is displayed in the segment layout. The format is similar to the EDIT/VIEW sub-option.

The next two columns are the Before and After value. Depending on whether the "Print only Changed Fields" option was selected, either or both columns are used. If any field contains unprintable data all values are printed in hex format. The rightmost column is for informational messages:

- "n OCCURS ADDED" is printed when the value of the object in a "occurs depending on" clause is increased in a COBOL segment layout. (COBOL only).
- "n OCCURS DELETED" is printed when the value of the object in a "occurs depending on" clause is decreased in a COBOL segment layout. (COBOL only).
- "FIELD INVALID" is printed if the value of the object printed do not conform with the layout format.

At the end of each segment the total segment length is printed.

Related topics

[Figure 174: Formatted audit report where only committed updates are reported \(Part 1 of 2\) on page 651](#)

Detail Statistics Unformatted

The second line of the segment heading has an additional field for Unformatted Statistics called "Edit sub Option". This indicates that a segment was edited as tabular, hexadecimal, character or single-segment.

When printing in hexadecimal format each line of data is represented on three lines of print. Top line is the character representation. Not printable symbols are printed as a space. Next two lines are the hex representation with the high-order halfbyte on the upper line and low-order on the lower line. Each line can hold a maximum of 100 bytes.

Start and Length columns can be used to navigate in the segment data.

Changed data is marked by a dash and the text "CHANGE" to the left on a fourth line.

Segment key area is marked with an asterisk on the fourth line.

As with the formatted print, not changed fields can be selected not to be printed. Since the display takes 100 bytes in one line, the 100 bytes are printed if one of the bytes have been changed. Groups of 100 unchanged bytes not printed is replaced by one line containing the message "n BYTES NOT PRINTED".

Related topics

[Figure 172: Unformatted audit report where all the audit events in the audit log are reported \(Part 1 of 2\) on page 649](#)

Summary Statistics

The Summary Statistics has the same heading as the Detail Statistics screens.

The heading on each page includes the name of the audited database and the name of its data set in addition to the date and time the report was printed.

Next are a couple of lines describing when the database was opened and closed and by whom. When a users TSO-PREFIX differ from the TSO-ID, both are printed.

Next is the Audit Trail description (entered on the ordering panel) and the Audit Trail data set. The DBDlib and the XREF data set names are also printed.

Total segments changed, divided into subtotals for replaced, inserted and deleted segments is printed next.

A count of any segments which were considered to be unacceptable because they did not contain the correct eyecatcher in the header is printed next.

At the bottom we find the Audit Trail report options as specified.

Audit Trail Report

The audit trail report is divided into two sections: Detailed Statistics and Summary Statistics.

The Detailed Statistics shows all changed segments before and after the change. The unformatted version of the report also indicates the positions that were changed. The formatted version of the report displays values in fields, if the data was edited using a template.

The Summary Statistics lists the totals for segments that were changed, deleted, or inserted.

Part II. Reference

Chapter 10. Panels and fields

This section of the manual lists all of the FM/IMS processing panels, provides a definition for each field in the panel and, where applicable, lists the value ranges that are valid for each field.

The **Parent panels** section lists the names of the panels from which you can navigate to the current panel. The **Child panels** section lists the names of the linked panels that you can navigate to, from the current panel. The **Related topics and examples** section lists the places in Part One: Working with FM/IMS that describe the usage of the panels.

Advanced Member Selection panel

The Advanced Member Selection panel is displayed when:

- The Advanced member selection option is selected on the View Update Utility, Template Update Utility, or the Criteria Set Update Utility panel.

This is a selection panel where you can refine the search for the modules you want to update.

Panel and field definitions

Figure 22. Advanced Member Selection panel

```
Process  Options  Help
-----
File Manager                Advanced Member Selection
Select members from:  FMN.IMS.IVP.VIEW
  Member name . . . . .      or range from:
  (or mask)                  to:
Using ISPF Statistics criteria:
  Updated by . . . . .      or range from:
  (User id or mask)         to:
  Date created . . . . .    or range from:
  (YYYY/MM/DD or mask)     to:
  Date modified . . . . .   or range from:
  (YYYY/MM/DD or mask)     to:
Command ==>
F1=Help      F2=Split    F3=Exit      F4=CRetriev  F7=Backward  F8=Forward
F9=Swap      F10=Actions  F12=Cancel
```

Member name (or mask)

Specify a pattern to rename members in the output partitioned data set based upon the member names in the input partitioned data set. A member name pattern can consist of any characters that are valid in a member name and two special pattern characters: the asterisk (*) and the percent sign (%).

*

A place-holding character that means multiple characters with no change. Only one asterisk should appear in the mask. Any subsequent asterisk characters are treated as percent signs. For

example, if you enter `ABC*` the renamed members all begin with ABC followed by the remainder of the old member name.

%

A place-holding character that means a single character with no change. As many percent symbols as necessary may appear anywhere in a member name. For example, if you enter `%%A*` the first 3 characters of the renamed members remain unchanged, the fourth character is replaced with the letter 'A', and the remainder of the old member name is unchanged.

range from / to

Specify from and to inclusive of names you want to select. If you specify the from name as A and the to name as D* then you will list all names that start with an 'A' through to 'D' inclusive.

Using ISPF statistics criteria

Specify a pattern, a name or a range for Userid, Date created or Date modified.

Parent panels

- [Criteria Set Update Utility panel on page 229](#)
- [Template Update Utility panel on page 418](#)
- [View Update Utility panel on page 429](#)

Child panels

- [View Member Selection panel on page 428](#)

AGN Selection panel

The AGN Selection panel is displayed when you specify these items on the entry panel for Browse, Edit, Extract, Load, Print, Batch Edit, or Batch Browse:

- BMP for the Region type.
- An IMS subsystem that uses AGNs and has some of them listed in the FM/IMS installation options module.
- Either no AGN name or an AGN name pattern.

If no AGN name is supplied, all the AGNs for the specified subsystem that are listed in the FM/IMS installation options module are shown on the panel. If an AGN name pattern is supplied, all the AGNs for the specified subsystem in the FM/IMS installation options module that have a name matching the pattern are shown on the panel.

Panel and field definitions

Figure 23. AGN Selection panel

Process	Options	Help
FM/IMS Browse : AGN Selection		
Subsystem IF62 IMS V13 NT QA System		
Cmd	AGN	Description
—	FMNA6201	IVP System
—	FMNA6202	Fast Path Databases
—	FMNA6203	HDOU System Only
—	FMNA6204	WP System - Update
—	FMNA6205	WP System - RO
—	FMNA6206	Dynamic PSB Access
	****	End of data ****
Command ==> _____ Scroll PAGE		
F1=Help	F2=Split	F3=Exit
F9=Swap	F10=Actions	F12=Cancel
	F4=CRetriev	F7=Backward
		F8=Forward

The panel displays the name and the description of the selected IMS subsystem and these details for each AGN:

Cmd

Selection entry field.

AGN

The Application Group Name.

Description

The AGN description as specified in the FM/IMS installation options module.

Parent panels

- [Browse Entry panel on page 214](#)
- [Extract Entry panel on page 275](#)
- [Edit Entry panel on page 266](#)
- [Print Entry panel on page 351](#)
- [Load Entry panel on page 335](#)
- [Batch Edit Entry panel on page 201](#)
- [Batch Browse Entry panel on page 195](#)

Child panels

- None.

Batch Browse Entry panel

The Batch Browse Entry Panel is the first panel in the Batch Browse dialog. It is displayed when you select option 7 (Batch Browse) on the Utility Menu panel.

Panel and field definitions

Figure 24. Batch Browse Entry panel

<u>P</u> rocess	<u>O</u> ptions	<u>H</u> elp
FM/IMS		
Batch Browse Entry Panel		
IMS:		
Subsystem name . . .	<u>I</u> F52	PSB name . . . _____ (If static PSB)
Database name . . .	<u>D</u> J1E	AGN name . . . _____ (If BMP)
View:		
Data set name . . .	* _____	
Member	_____	
Processing Options:		
PSB type	<u>R</u> egion type	<u>F</u> etch DB dsnames from (if DLI)
<u>1</u> 1. Dynamic	<u>1</u> 1. DLI	<u>2</u> 1. User profile
2. Static	2. BMP	2. DFSMDA members
View usage		
<u>1</u> 1. New	Enter "/" to select option	
2. Existing	_ Skip DB data set panel (if DLI)	
3. None	_ Edit view	
	_ Include template DD	
Command ==>		
F1=Help	F2=Split	F3=Exit
F9=Swap	F10=Actions	F12=Cancel
	F4=CRetrieiv	F7=Backward
		F8=Forward

IMS

Subsystem name

The ID of the IMS subsystem that the database you want to browse is defined in. FM/IMS searches the FM/IMS installation options module for the subsystem with the specified name. If you enter either no subsystem name or a subsystem name pattern, the Subsystem Selection panel is displayed. You can select a subsystem from the list of subsystems displayed on that panel.

PSB name

If you select "Static" for **PSB type**, specify the name of the PSB that you want the Batch Browse to use. The PSB that you specify must have a PCB for the database you want to browse.

FM/IMS searches either an IMS catalog or PSB libraries for a PSB with the specified name. Which of these two sources is searched depends on whether or not the selected subsystem uses IMS-managed ACBs.

If the selected subsystem uses IMS-managed ACBs, then FM/IMS searches the IMS catalog that the subsystem uses.

Otherwise, FM/IMS searches user- or administrator-specified PSB libraries. The libraries that are searched depend on which subsystem you select, so they are called the PSB libraries for the selected subsystem.

The PSB libraries for the selected subsystem are displayed on the PSB and DBD Data Sets panel and may or may not be fixed by the FM/IMS administrator.

If the PSB libraries for the subsystem are fixed, the PSB Data set name fields on the PSB and DBD Data Sets panel are protected and you must use the PSB libraries that the administrator has specified. Otherwise, these fields are not protected and you are free to modify the list of PSB libraries that FM/IMS searches.

FM/IMS searches the PSB libraries in the order in which they are specified and uses the first PSB it finds with the specified name.

If you do not enter a PSB name or if you enter a PSB name pattern, the PSB Selection panel is displayed. You can select a PSB from the list of PSBs displayed on that panel.



Note: If you select "Dynamic" for **PSB type**, this field is ignored.

Database name

The name of the database that you want to browse.

FM/IMS searches either an IMS catalog or DBD libraries for a DBD with the specified name. Which of these two sources is searched depends on whether or not the selected subsystem uses IMS-managed ACBs.

If the selected subsystem uses IMS-managed ACBs, then FM/IMS searches the IMS catalog that the subsystem uses.

Otherwise, FM/IMS searches user- or administrator-specified DBD libraries. The libraries that are searched depend on which subsystem you select, so they are called the DBD libraries for the selected subsystem.

The DBD libraries for the selected subsystem are displayed on the PSB and DBD Data Sets panel and may or may not be fixed by the FM/IMS administrator.

If the DBD libraries for the subsystem are fixed, the DBD Data set name fields on the PSB and DBD Data Sets panel are protected and you must use the DBD libraries that the administrator has specified. Otherwise, these fields are not protected and you are free to modify the list of DBD libraries that FM/IMS searches.

FM/IMS searches the DBD libraries in the order in which they are specified and uses the first DBD it finds with the specified name.

The following applies to when you select "Dynamic" for **PSB type**:

- If you enter either no database name or a database name pattern, the Database Selection panel is displayed. You can select a database from the list of databases displayed on that panel.
- If the selected subsystem does not use IMS-managed ACBs, then IMS requires these DBDs to be in at least one of the specified DBD libraries:
 - The DBD for the database you want to browse.
 - The DBD for each database that is logically related to the database you want to browse.

The following applies to when you select “Static?” for **PSB type**:

- The PCB Selection panel is displayed when any one of these is true:
 - You enter no database name and there is more than one database PCB in the specified PSB.
 - You enter a database name and there is more than one PCB for the database in the PSB.
 - You enter a database name pattern and the PSB has PCBs for databases with names that match the pattern.

You can select a PCB from the list of database PCBs that is displayed on the PCB Selection panel.

- If the subsystem does not use IMS-managed ACBs, then IMS requires these DBDs to be in at least one of the specified DBD libraries:
 - The DBD for each database that is specified in the PSB.
 - The DBD for each database that is logically related to a database specified in the PSB.

AGN name

The Application Group Name (AGN) identifies a group of IMS resources. The name you specify is passed to the IMS region controller when you select BMP for the Region type.

If you select a subsystem that does not use AGNs, no AGN name should be entered.

If you select a subsystem that uses AGNs, specify an AGN that provides you with the access the Batch Browse requires and that you have authority to use. (The BMP region that FM/IMS starts is only authorized to use the IMS resources that are associated with the specified AGN.)

The AGN Selection panel is displayed when all these conditions are true:

- A BMP region type is selected.
- The selected subsystem uses AGNs.

- AGNs for the selected subsystem are listed in the FM/IMS installation options module.
- Either no AGN name is entered or an AGN name pattern is entered and there are AGNs for the selected subsystem in the FM/IMS installation options module that match the pattern.

You can select an AGN from the list of AGNs that is displayed on the AGN Selection panel. If AGNs for the selected subsystem are not listed in the FM/IMS installation options module, you must specify the full name of the AGN.



Note: This field is ignored when you select DLI for the Region type.

View

Data set name

If you select "Existing" for the **View usage**, this is the name of the data set that contains the view that you want the Batch Browse to use.



Note: If you select "New" or "None" for **View usage**, this field is ignored.

Member

If you select "Existing" for **View usage**, then:

- If the view that you want the Batch Browse to use is in a PDS(E), specify the view member name in this field.
- If the view that you want the Batch Browse to use is in a sequential data set, blank out this field.



Note: If you select "New" or "None" for **View usage**, this field is ignored.

PSB type

The type of PSB that the Batch Browse uses to access the database:

1. Dynamic

The Batch Browse uses a temporary PSB that it generates at the start of the batch job.

2. Static

The Batch Browse uses an existing PSB you specify in the PSB name field.

Region type

The type of region that you want the Batch Browse to run in:

1. DLI

For a DL/I batch processing region. You can use a DL/I batch processing region when the database is offline or there is data sharing support.

2. BMP

For a BMP region. You can use a BMP region when the database is online.

Fetch DB dsnames from (if DLI)

If you select "DLI" for **Region type**, a database that is not a HALDB, and an IMS subsystem that is not a dynamic allocation only subsystem:

1. User profile

Batch Browse uses the database data sets whose names are saved in your user profile.

2. DFSMDA members

Batch Browse uses the database data sets specified in the DFSMDA dynamic allocation members.



Note: This field is ignored when you specify any one of these:

- "BMP" for **Region type**.
- A database that is a HALDB.
- An IMS subsystem that is defined as dynamic allocation only in the FM/IMS installation option module.

View usage

Determines whether the Batch Browse uses a new view, an existing view, or no view:

1. New

Select this option when you want Batch Browse to use a new view.

The Batch Browse creates a temporary view from a template for the specified database.

FM/IMS searches user administrator-specified template libraries for the template. The template libraries that FM/IMS searches depends on which subsystem you select:

- If the template libraries for the specified subsystem are not fixed, FM/IMS searches the template libraries specified on the Template Data Sets panel.
- If the template libraries for the subsystem are fixed, FM/IMS searches the default template libraries for the subsystem (specified in the FM/IMS installation options module).

FM/IMS searches the template libraries in the order in which they are specified and uses the first template it finds with the specified database name.

2. Existing

Select this option when you want Batch Browse to use an existing view. Batch Browse uses the view specified in the View **Data set name** and **Member** fields.

3. None

Select this option when you do not want Batch Browse to use a view.

Skip DB data set panel (if DLI)

Select this option if you do not want FM/IMS to display the Database Data Set Specification or the Database Data Set Display panel.

If this option is not selected and you select "DLI" for **Region type**, the Database Data Set Specification or the Database Data Set Display panel is displayed.



Note: This field is ignored when you select "BMP" for **Region type**.

Edit view

Select this option if you have selected Existing for **View usage** and you want to edit the view before the Batch Browse uses it. If you select this option, FM/IMS starts the View dialog where you can edit and save the view specified in the View data set and member fields.



Note: This field is ignored when you select New or None for **View usage**.

Include template DD

Select this option if the REXX procedure that you want the Batch Browse to run, includes a VIEWIMS call with the TPLDD parameter. If you select this option, the generated JCL includes a TDDIN DD statement that specifies the Template data sets for the specified subsystem.

Related topics

[Batch Edit Entry panel on page 201](#)

Parent panels

- [Utility Menu panel on page 425](#)

Child panels

- [AGN Selection panel on page 193](#)
- [Data Set Selection panel on page 233](#)
- [Database Data Set Display panel on page 234](#)
- [Database Data Set Specification panel on page 236](#)
- [PCB Selection panel on page 343](#)

- [PSB Selection panel on page 361](#)
- [Subsystem Selection panel on page 401](#)
- [View Member Selection panel on page 428](#)
- [Batch Browse Options panel on page 201](#)

Batch Browse Options panel

The Batch Browse Options panel is identical to the Batch Edit Options panel.

For a description of the entry fields, see the Batch Edit Options panel.

Related topics

[Batch Edit Options panel on page 207](#)

Parent panels

- [Batch Browse Entry panel on page 195](#)
- [Database Data Set Display panel on page 234](#)
- [Database Data Set Specification panel on page 236](#)

Child panels

- [JCL Submission panel on page 331](#)

Batch Edit Entry panel

The Batch Edit Entry Panel is the first panel in the Batch Edit dialog. It is displayed when you select option 6 (Batch Edit) on the Utility Menu panel.

Panel and field definitions

Figure 25. Batch Edit Entry panel

Process	Options	Help
FM/IMS		
Batch Edit Entry Panel		
IMS:		
Subsystem name . . .	<u>I</u> F52	PSB name . . . _____ (If static PSB)
Database name . . .	<u>D</u> J1E	AGN name . . . _____ (If BMP)
View:		
Data set name . . .	* _____	
Member	_____	
Processing Options:		
PSB type	Region type	Fetch DB dsnames from (if DLI)
<u>1</u> 1. Dynamic	<u>1</u> 1. DLI	<u>2</u> 1. User profile
2. Static	2. BMP	2. DFSMDA members
View usage		
<u>1</u> 1. New	Enter "/" to select option	
2. Existing	_ Skip DB data set panel (if DLI)	
3. None	_ Edit view	
	_ Include template DD	
Command ==> _____ Scroll PAGE		
F1=Help	F2=Split	F3=Exit
F9=Swap	F10=Actions	F12=Cancel
	F4=CRetriev	F7=Backward
		F8=Forward

IMS

Subsystem name

The ID of the IMS subsystem that the database you want to edit is defined in. FM/IMS searches the FM/IMS installation options module for the subsystem with the specified name. If you enter either no subsystem name or a subsystem name pattern, the Subsystem Selection panel is displayed. You can select a subsystem from the list of subsystems displayed on that panel.

PSB name

If you select "Static" for **PSB type**, specify the name of the PSB that you want the Batch Edit to use. The PSB that you specify must have a PCB for the database you want to edit.

FM/IMS searches either an IMS catalog or PSB libraries for a PSB with the specified name. Which of these two sources is searched depends on whether or not the selected subsystem uses IMS-managed ACBs.

If the selected subsystem uses IMS-managed ACBs, then FM/IMS searches the IMS catalog that the subsystem uses.

Otherwise, FM/IMS searches user- or administrator-specified PSB libraries. The libraries that are searched depend on which subsystem you select, so they are called the PSB libraries for the selected subsystem.

The PSB libraries for the selected subsystem are displayed on the PSB and DBD Data Sets panel and may or may not be fixed by the FM/IMS administrator.

If the PSB libraries for the subsystem are fixed, the PSB Data set name fields on the PSB and DBD Data Sets panel are protected and you must use the PSB libraries that the administrator has specified. Otherwise, these fields are not protected and you are free to modify the list of PSB libraries that FM/IMS searches.

FM/IMS searches the PSB libraries in the order in which they are specified and uses the first PSB it finds with the specified name.

If you do not enter a PSB name or if you enter a PSB name pattern, the PSB Selection panel is displayed. You can select a PSB from the list of PSBs displayed on that panel.



Note: If you select "Dynamic" for **PSB type**, this field is ignored.

Database name

The name of the database that you want to edit.

FM/IMS searches either an IMS catalog or DBD libraries for a DBD with the specified name. Which of these two sources is searched depends on whether or not the selected subsystem uses IMS-managed ACBs.

If the selected subsystem uses IMS-managed ACBs, then FM/IMS searches the IMS catalog that the subsystem uses.

Otherwise, FM/IMS searches user- or administrator-specified DBD libraries. The libraries that are searched depend on which subsystem you select, so they are called the DBD libraries for the selected subsystem.

The DBD libraries for the selected subsystem are displayed on the PSB and DBD Data Sets panel and may or may not be fixed by the FM/IMS administrator.

If the DBD libraries for the subsystem are fixed, the DBD Data set name fields on the PSB and DBD Data Sets panel are protected and you must use the DBD libraries that the administrator has specified. Otherwise, these fields are not protected and you are free to modify the list of DBD libraries that FM/IMS searches.

FM/IMS searches the DBD libraries in the order in which they are specified and uses the first DBD it finds with the specified name.

The following applies to when you select "Dynamic?" for **PSB type**:

- If you enter either no database name or a database name pattern, the Database Selection panel is displayed. You can select a database from the list of databases displayed on that panel.
- If the selected subsystem does not use IMS-managed ACBs, then IMS requires these DBDs to be in at least one of the specified DBD libraries:

- The DBD for the database you want to edit.
- The DBD for each database that is logically related to the database you want to edit.

The following applies to when you select "Static?" for **PSB type**:

- The PCB Selection panel is displayed when any one of these is true:
 - You enter no database name and there is more than one database PCB in the specified PSB.
 - You enter a database name and there is more than one PCB for the database in the PSB.
 - You enter a database name pattern and the PSB has PCBs for databases with names that match the pattern.

You can select a PCB from the list of database PCBs that is displayed on the PCB Selection panel.

- If the subsystem does not use IMS-managed ACBs, then IMS requires these DBDs to be in at least one of the specified DBD libraries:
 - The DBD for each database that is specified in the PSB.
 - The DBD for each database that is logically related to a database specified in the PSB.

AGN name

The Application Group Name (AGN) identifies a group of IMS resources. The name you specify is passed to the IMS region controller when you select BMP for the Region type.

If you select a subsystem that does not use AGNs, no AGN name should be entered.

If you select a subsystem that uses AGNs, specify an AGN that provides you with the access the Batch Edit requires and that you have authority to use. (The BMP region that FM/IMS starts is only authorized to use the IMS resources that are associated with the specified AGN.)

The AGN Selection panel is displayed when all these conditions are true:

- A BMP region type is selected.
- The selected subsystem uses AGNs.
- AGNs for the selected subsystem are listed in the FM/IMS installation options module.
- Either no AGN name is entered or an AGN name pattern is entered and there are AGNs for the selected subsystem in the FM/IMS installation options module that match the pattern.

You can select an AGN from the list of AGNs that is displayed on the AGN Selection panel. If AGNs for the selected subsystem are not listed in the FM/IMS installation options module, you must specify the full name of the AGN.



Note: This field is ignored when you select DLI for the Region type.

View

Data set name

If you select "Existing" for the **View usage**, this is the name of the data set that contains the view that you want the Batch Edit to use.



Note: If you select "New" or "None" for **View usage**, this field is ignored.

Member

If you select "Existing" for **View usage**, then:

- If the view that you want the Batch Edit to use is in a PDS(E), specify the view member name in this field.
- If the view that you want the Batch Edit to use is in a sequential data set, blank out this field.



Note: If you select "New" or "None" for **View usage**, this field is ignored.

PSB type

The type of PSB that the Batch Edit uses to access the database:

1. Dynamic

The Batch Edit uses a temporary PSB that it generates at the start of the batch job.

2. Static

The Batch Edit uses an existing PSB you specify in the PSB name field.

Region type

The type of region that you want the Batch Edit to run in:

1. DLI

For a DL/I batch processing region. You can use a DL/I batch processing region when the database is offline or there is data sharing support.

2. BMP

For a BMP region. You can use a BMP region when the database is online.

Fetch DB dsnames from (if DLI)

If you select "DLI" for **Region type**, a database that is not a HALDB, and an IMS subsystem that is not a dynamic allocation only subsystem:

1. User profile

Batch Edit uses the database data sets whose names are saved in your user profile.

2. DFSMDA members

Batch Edit uses the database data sets specified in the DFSMDA dynamic allocation members.



Note: This field is ignored when you specify any one of these:

- "BMP" for **Region type**.
- A database that is a HALDB.
- An IMS subsystem that is defined as dynamic allocation only in the FM/IMS installation option module.

View usage

Determines whether the Batch Edit uses a new view, an existing view, or no view:

1. New

Select this option when you want Batch Edit to use a new view.

The Batch Edit creates a temporary view from a template for the specified database.

FM/IMS searches user- or administrator-specified template libraries for the template. The template libraries that FM/IMS searches depends on which subsystem you select:

- If the template libraries for the specified subsystem are not fixed, FM/IMS searches the template libraries specified on the Template Data Sets panel.
- If the template libraries for the subsystem are fixed, FM/IMS searches the default template libraries for the subsystem (specified in the FM/IMS installation options module).

FM/IMS searches the template libraries in the order in which they are specified and uses the first template it finds with the specified database name.

2. Existing

Select this option when you want Batch Edit to use an existing view. Batch Edit uses the view specified in the View **Data set name** and **Member** fields.

3. None

Select this option when you do not want Batch Edit to use a view.

Skip DB data set panel (if DLI)

Select this option if you do not want FM/IMS to display the Database Data Set Specification or the Database Data Set Display panel.

If this option is not selected and you select "DLI" for **Region type**, the Database Data Set Specification or the Database Data Set Display panel is displayed.



Note: This field is ignored when you select "BMP" for **Region type**.

Edit view

Select this option if you have selected Existing for **View usage** and you want to edit the view before the Batch Edit uses it. If you select this option, FM/IMS starts the View dialog where you can edit and save the view specified in the View data set and member fields.



Note: This field is ignored when you select New or None for **View usage**.

Include template DD

Select this option if the REXX procedure that you want the Batch Edit to run, includes a VIEWIMS call with the TPLDD parameter. If you select this option, the generated JCL includes a TDDIN DD statement that specifies the Template data sets for the specified subsystem.

Parent panels

- [Utility Menu panel on page 425](#)

Child panels

- [AGN Selection panel on page 193](#)
- [Database Data Set Display panel on page 234](#)
- [Database Data Set Specification panel on page 236](#)
- [Database Selection panel on page 242](#)
- [PCB Selection panel on page 343](#)
- [PSB Selection panel on page 361](#)
- [Subsystem Selection panel on page 401](#)
- [View Member Selection panel on page 428](#)
- [Batch Edit Options panel on page 207](#)

Batch Edit Options panel

You use this panel to specify:

- Whether you want the Batch Edit to run a cataloged REXX procedure or an instream REXX procedure.
- When running a cataloged REXX procedure:
 - The name of the PDS(E) that contains the REXX procedure that you want the Batch Edit to run.
 - The REXX procedure member name.
 - Whether you want to edit the REXX procedure before the JCL is generated.

Panel and field definitions

Figure 26. Batch Edit Options panel

Process	Options	Help
FM/IMS	Batch Edit Options Panel	
Database DJ1E		
REXX Procedure:		
Data set name	_____	
Member	_____	
Processing Options:		
Procedure type	Enter "/" to select option	
2 1. In-stream	_ Edit procedure	
2. Cataloged		
Command ==> _____ Scroll PAGE		
F1=Help	F2=Split	F3=Exit
F9=Swap	F10=Actions	F12=Cancel
	F4=CRetrieve	F7=Backward
		F8=Forward

Database

The name of the database specified on the Batch Edit Entry panel.

Data set name

If you select "Cataloged" for **Procedure type**, specify the name of the PDS(E) that contains the REXX procedure that you want the Batch Edit to run.



Note: This field is ignored when you select "In-stream" for **Procedure type**.

Member

If you select Cataloged for the Procedure type, specify the REXX procedure member name.



Note: This field is ignored when you select "In-stream" for **Procedure type**.

Procedure type

Determines whether the Batch Edit is to run an in-stream procedure or a cataloged procedure:

1. In-stream

If you select this option, you must add the in-stream REXX procedure to the generated JCL. You should insert the REXX procedure immediately after the \$FILEM PROC=* statement.

2. Cataloged

The Batch Edit executes the procedure specified in the REXX procedure data set name and member fields.

Edit procedure

Select this option, if you selected "Cataloged" for **Procedure type** and you want to edit the procedure before the JCL is generated.



Note: This field is ignored when you select "In-stream" for **Procedure type**.

Parent panels

- [Batch Edit Entry panel on page 201](#)
- [Database Data Set Display panel on page 234](#)
- [Database Data Set Specification panel on page 236](#)

Child panels

- [JCL Submission panel on page 331](#)

BMP Mode Options panel

The BMP Mode Options panel allows you to view and modify selected options used by the FM/IMS functions when run in BMP mode.

The panel is displayed when option 6 is selected on the Subsystem Settings Menu panel.

The Subsystem field displays the IMS subsystem ID you specified on the Subsystem Settings Menu.

The panel displays the options that an online FM/IMS function uses when a BMP region type is selected and this IMS subsystem ID is specified on the function's Entry panel.

The FM/IMS administrator may have fixed the values of some or all of the options displayed on the panel. If an option has been fixed, the panel field is protected and you cannot change the specified value.

If an option has not been fixed, you can change the value that has been specified for it.

To reset all the options on the panel to their subsystem defaults, enter the RESET command.

To exit the panel saving the changes you have made, enter the EXIT command (F3).

To exit the panel without saving the changes you have made, enter the CANCEL command (F12).

Panel and field definitions

Figure 27. BMP Mode Options panel

```

Process  Options  Help
-----
FM/IMS                                BMP Mode Options

Subsystem IF52  IMS V13 NT Test

Options:
  Enter "/" to select option
  _ Autosave

Checkpoint Frequencies:
  Edit . . . . . 5
  Change All/Repeat All 55
  Load . . . . . 155
  Batch Edit . . . . . 255

PSB Processing Options:
  Browse      Extract      Print      Batch Browse
  2 1. G      2 1. G      1 1. G      1 1. G
  2. GO      2. GO      2. GO      2. GO

Command ==>
F1=Help      F2=Split      F3=Exit      F4=CRetriev  F7=Backward  F8=Forward
F9=Swap      F10=Actions   F12=Cancel
    
```

Subsystem

The IMS subsystem ID specified on the Subsystem Settings Menu.

Autosave

Select this option if you want the automatic save function to be set on when you start an Edit session.

Edit Checkpoint Frequency

The number that specifies the frequency of the automatic save function when editing databases.

When Autosave is on, FM/IMS:

- Increments a count by 1 each time you press an action key and data changes have been requested.
- Issues a checkpoint when the count is equal to the number specified in this field.

The value must be in the range 1 to 99.

Change All/Repeat All Checkpoint Frequency

The number that specifies the frequency of the automatic save function during Change All and Repeat All operations.

When Autosave is on, FM/IMS:

- Increments a count by 1 each time a segment is updated during a Change All operation or inserted during a Repeat All operation.
- Issues a checkpoint when the count is equal to the number specified in this field.

The value must be in the range 1 to 9,999.

Load Checkpoint Frequency

The number that specifies the frequency of the automatic save function when running a File Manager/IMS Load job.

FM/IMS increments a count by 1 each time your Load job inserts or replaces a segment and issues a checkpoint when the count is equal to the number specified in this field.

The value must be in the range 1 to 99,999.

Batch Edit Checkpoint Frequency

The number that specifies the frequency of the automatic save function when running a Batch Edit job.

FM/IMS increments a count by 1 each time your Batch Edit job inserts, deletes or replaces a database segment and issues a checkpoint when the count is equal to the number specified in this field.

The value must be in the range 1 to 99,999.

Browse PSB Processing Option

The PSB Processing Option (PROCOPT) that dynamic PSBs generated for a Browse will use:

1 - PROCOPT=G

The Browse reads with integrity.

2 - PROCOPT=GO

The Browse reads without integrity.

Extract PSB Processing Option

The PSB Processing Option (PROCOPT) that dynamic PSBs generated for a Extract will use:

1 - PROCOPT=G

The Extract reads with integrity.

2 - PROCOPT=GO

The Extract reads without integrity.

Print PSB Processing Option

The PSB Processing Option (PROCOPT) that dynamic PSBs generated for a Print will use:

1 - PROCOPT=G

The Print reads with integrity.

2 - PROCOPT=GO

The Print reads without integrity.

Batch Browse PSB Processing Option

The PSB Processing Option (PROCOPT) that dynamic PSBs generated for a Batch Browse will use:

1 - PROCOPT=G

The Batch Browse reads with integrity.

2 - PROCOPT=GO

The Batch Browse reads without integrity.

Parent panels

- [Subsystem Settings Menu panel on page 404](#)

Child panels

- None.

BMP Mode Parameters panel

The BMP Mode Parameters panel allows you to view and modify the parameters that are passed to the IMS region controller when a File Manager/IMS function is run in BMP mode.

The panel is displayed when option 5 is selected on the Subsystem Settings Menu.

The panel displays the parameters that an online FM/IMS function uses when a BMP region type is selected and this IMS subsystem ID is specified on the function's Entry panel. The **Subsystem** field displays the IMS subsystem ID you specified on the Subsystem Settings Menu.

The FM/IMS administrator may have fixed the values of some or all of the parameters displayed on the panel.

If a parameter has been fixed, the panel field will be protected and you will not be able to change the specified value. If a parameter has not been fixed, you can change the value that has been specified for it.

Enter the RESET command to reset all the parameters on the panel to their subsystem defaults.

Enter the EXIT command (F3) to exit the panel saving the changes you have made.

Enter the CANCEL command (F12) to exit the panel without saving the changes you have made.

Panel and field definitions

Figure 28. BMP Mode Parameters panel

Process	Options	Help
FM/IMS	BMP Mode Parameters	
Subsystem IF52 IMS V13 NT Test		
Options:		
PARDLI		
2	1. PARDLI=0	
	2. PARDLI=1	
Fast Path Buffer Allocation:		
NBA	<u>11</u>
OBA	<u>7</u>
Parameters:		
LOCKMAX	. . .	<u>555</u>
Command ==>		
F1=Help	F2=Split	F3=Exit
F9=Swap	F10=Actions	F12=Cancel
	F4=CRetriev	F7=Backward
	F8=Forward	

Subsystem

The IMS subsystem ID you specified on the Subsystem Settings Menu.

PARDLI

Specify the parallel DL/I option used by functions running in BMP mode:

1 - PARDLI=0

DL/I processing is performed in the BMP region.

2 - PARDLI=1

All DL/I processing for the BMP is performed in the IMS control region.

PARDLI=1 prevents control region system 113 abends resulting from system X22 abends in the BMP region.

However, if PARDLI=1, parallel DL/I is disabled. This can degrade performance.

Normal Buffer Allocation (NBA)

The number of Fast Path database buffers to be made available in the Common Service Area when a Fast Path region is activated. The number specified is used by functions when they access Fast Path databases.

Must be in the range 1 to 9999.

Overflow Buffer Allocation (OBA)

The number of additional page-fixed buffers to be made available to a Fast Path region if the normal allotment (specified in the NBA field) is used. The number specified is used by functions when they access Fast Path databases.

Must be in the range 1 to 9999.

LOCKMAX

The maximum number of locks (in units of 1000) that a function is allowed to hold at one time. The number must be in the range 0 to 32767.

If 0 is specified, there is no limit on the number of locks the function can hold at one time.

If you leave the field blank, the LOCKMAX value specified on the PSBGEN statement is used or 0 (no limit), if the LOCKMAX parameter is not specified on the PSBGEN statement.

Parent panels

- [Subsystem Settings Menu panel on page 404](#)

Child panels

- None.

Browse Entry panel

The Browse Entry Panel is the first panel in the Browse dialog. It is displayed when you select option 1 (Browse) on the Primary Option Menu panel.

Panel and field definitions

Figure 29. Browse Entry Panel

Process	Options	Help
FM/IMS	Browse Entry Panel	
IMS:		
Subsystem name . . .	<u>IF52</u>	PSB name . . . _____ (If static PSB)
Database name . . .	<u>DJ1E</u>	AGN name . . . _____ (If BMP)
View:		
Data set name . . .	_____	
Member	_____	
Processing Options:		
PSB type	Region type	Fetch DB dsnames from (if DLI)
<u>1</u> 1. Dynamic	<u>1</u> 1. DLI	<u>2</u> 1. User profile
2. Static	2. BMP	2. DFSMDA members
View usage		
<u>3</u> 1. New	Enter "/" to select option	
2. Existing	_ Secondary index (if dynamic PSB)	
3. None	_ Skip DB data set panel (if DLI)	
Command ==>		
F1=Help	F2=Split	F3=Exit
F9=Swap	F10=Actions	F12=Cancel
	F4=CRetrieve	F7=Backward
		F8=Forward

IMS

Subsystem name

The ID of the IMS subsystem that the database you want to browse is defined in. FM/IMS searches the FM/IMS installation options module for the subsystem with the specified name.

If you enter either no subsystem name or a subsystem name pattern, the Subsystem Selection panel is displayed. You can select a subsystem from the list of subsystems displayed on that panel.

PSB name

If you select "Static" for **PSB type**, specify the name of the PSB that you want the Browse to use. The PSB that you specify must have a PCB for the database you want to browse.

FM/IMS searches either an IMS catalog or PSB libraries for a PSB with the specified name. Which of these two sources is searched depends on whether or not the selected subsystem uses IMS-managed ACBs.

If the selected subsystem uses IMS-managed ACBs, then FM/IMS searches the IMS catalog that the subsystem uses.

Otherwise, FM/IMS searches user- or administrator-specified PSB libraries. The libraries that are searched depend on which subsystem you select, so they are called the PSB libraries for the selected subsystem.

The PSB libraries for the selected subsystem are displayed on the PSB and DBD Data Sets panel and may or may not be fixed by the FM/IMS administrator.

If the PSB libraries for the subsystem are fixed, the PSB Data set name fields on the PSB and DBD Data Sets panel are protected and you must use the PSB libraries that the administrator has specified. Otherwise, these fields are not protected and you are free to modify the list of PSB libraries that FM/IMS searches.

FM/IMS searches the PSB libraries in the order in which they are specified and uses the first PSB it finds with the specified name.

If you do not enter a PSB name or if you enter a PSB name pattern, the PSB Selection panel is displayed. You can select a PSB from the list of PSBs displayed on that panel.



Note: If you select "Dynamic" for **PSB type**, this field is ignored.

Database name

The name of the database that you want to browse.

FM/IMS searches either an IMS catalog or DBD libraries for a DBD with the specified name. Which of these two sources is searched depends on whether or not the selected subsystem uses IMS-managed ACBs.

If the selected subsystem uses IMS-managed ACBs, then FM/IMS searches the IMS catalog that the subsystem uses.

Otherwise, FM/IMS searches user- or administrator-specified DBD libraries. The libraries that are searched depend on which subsystem you select, so they are called the DBD libraries for the selected subsystem.

The DBD libraries for the selected subsystem are displayed on the PSB and DBD Data Sets panel and may or may not be fixed by the FM/IMS administrator.

If the DBD libraries for the subsystem are fixed, the DBD Data set name fields on the PSB and DBD Data Sets panel are protected and you must use the DBD libraries that the administrator has specified. Otherwise, these fields are not protected and you are free to modify the list of DBD libraries that FM/IMS searches.

FM/IMS searches the DBD libraries in the order in which they are specified and uses the first DBD it finds with the specified name.

The following applies to when you select "Dynamic?" for **PSB type**:

- If you enter either no database name or a database name pattern, the Database Selection panel is displayed. You can select a database from the list of databases displayed on that panel.
- If the selected subsystem does not use IMS-managed ACBs, then IMS requires these DBDs to be in at least one of the specified DBD libraries:
 - The DBD for the database you want to browse.
 - The DBD for each database that is logically related to the database you want to browse.

The following applies to when you select "Static?" for **PSB type**:

- The PCB Selection panel is displayed when any one of these is true:
 - You enter no database name and there is more than one database PCB in the specified PSB.
 - You enter a database name and there is more than one PCB for the database in the PSB.
 - You enter a database name pattern and the PSB has PCBs for databases with names that match the pattern.

You can select a PCB from the list of database PCBs that is displayed on the PCB Selection panel.

- If the subsystem does not use IMS-managed ACBs, then IMS requires these DBDs to be in at least one of the specified DBD libraries:
 - The DBD for each database that is specified in the PSB.
 - The DBD for each database that is logically related to a database specified in the PSB.

AGN name

The Application Group Name (AGN) identifies a group of IMS resources. The name you specify is passed to the IMS region controller when you select BMP for the Region type.

If you select a subsystem that does not use AGNs, no AGN name should be entered.

If you select a subsystem that uses AGNs, specify an AGN that provides you with the access the Browse requires and that you have authority to use. (The BMP region that FM/IMS starts is only authorized to use the IMS resources that are associated with the specified AGN.)

The AGN Selection panel is displayed when all these conditions are true:

- A BMP region type is selected.
- The selected subsystem uses AGNs.
- AGNs for the selected subsystem are listed in the FM/IMS installation options module.
- Either no AGN name is entered or an AGN name pattern is entered and there are AGNs for the selected subsystem in the FM/IMS installation options module that match the pattern.

You can select an AGN from the list of AGNs that is displayed on the AGN Selection panel. If AGNs for the selected subsystem are not listed in the FM/IMS installation options module, you must specify the full name of the AGN.



Note: This field is ignored when you select DLI for the Region type.

View

Data set name

If you select "Existing" for the **View usage**, this is the name of the data set that contains the view that you want the Browse to use.



Note: If you select "New" or "None" for **View usage**, this field is ignored.

Member

If you select "Existing" for **View usage**, then:

- If the view that you want the Browse to use is in a PDS(E), specify the view member name in this field.
- If the view that you want the Browse to use is in a sequential data set, blank out this field.



Note: If you select "New" or "None" for **View usage**, this field is ignored.

PSB type

The type of PSB that the Browse uses to access the database:

1. Dynamic

The Browse uses a temporary PSB that it generates at the start of the dialog.

2. Static

The Browse uses an existing PSB you specify in the PSB name field.

Region type

The type of region that you want the Browse to run in:

1. DLI

For a DL/I batch processing region. You can use a DL/I batch processing region when the database is offline or there is data sharing support.

2. BMP

For a BMP region. You can use a BMP region when the database is online.

Fetch DB dsnames from (if DLI)

If you select "DLI" for **Region type**, a database that is not a HALDB, and an IMS subsystem that is not a dynamic allocation only subsystem:

1. User profile

Browse uses the database data sets whose names are saved in your user profile.

2. DFSMDA members

Browse uses the database data sets specified in the DFSMDA dynamic allocation members.



Note: This field is ignored when you specify any one of these:

- "BMP" for **Region type**.
- A database that is a HALDB.
- An IMS subsystem that is defined as dynamic allocation only in the FM/IMS installation option module.

View usage

Determines whether the Browse uses a new view, an existing view, or no view:

1. New

Select this option when you want Browse to use a new view.

The Browse creates a temporary view from a template for the specified database.

FM/IMS searches user or administrator-specified template libraries for the template. The template libraries that FM/IMS searches depends on which subsystem you select:

- If the template libraries for the specified subsystem are not fixed, FM/IMS searches the template libraries specified on the Template Data Sets panel.
- If the template libraries for the subsystem are fixed, FM/IMS searches the default template libraries for the subsystem (specified in the FM/IMS installation options module).

FM/IMS searches the template libraries in the order in which they are specified and uses the first template it finds with the specified database name.

2. Existing

Select this option when you want Browse to use an existing view. Browse uses the view specified in the View **Data set name** and **Member** fields.

3. None

Select this option when you do not want Browse to use a view.

Secondary index (if dynamic PSB)

Select this option if you have selected "Dynamic" for **PSB type** and you want to access the database by means of a secondary index.

If you select this option and the database has more than one secondary index, the Secondary Index Selection panel is displayed. You can select a secondary index from the list of secondary indexes displayed on that panel.



Note: This field is ignored when you select "Static" for **PSB type**.

Skip DB data set panel (if DLI)

Select this option if you do not want FM/IMS to display the Database Data Set Specification or the Database Data Set Display panel.

If this option is not selected and you select "DLI" for **Region type**, the Database Data Set Specification or the Database Data Set Display panel is displayed.



Note: This field is ignored when you select "BMP" for **Region type**.

Parent panels

- [Primary Option menu on page 346](#)

Child panels

- [AGN Selection panel on page 193](#)
- [Data Set Selection panel on page 233](#)
- [Database Data Set Display panel on page 234](#)

- [Database Data Set Specification panel on page 236](#)
- [PCB Selection panel on page 343](#)
- [PSB Selection panel on page 361](#)
- [Secondary Index Selection panel on page 367](#)
- [Subsystem Selection panel on page 401](#)
- [Database Selection panel on page 242](#)
- [View Member Selection panel on page 428](#)
- [Database Positioning panel on page 239](#)

Related topics and examples

- [Accessing your databases on page 47](#)

Compiler Language Selection panel

The Compiler Language Selection panel is displayed when option 1 is selected from the Set Language and compiler specifications panel.

The panel allows you to specify the compiler that FM/IMS uses to build templates. You can also specify whether you want FM/IMS to use the compiler options in the template or the compiler options specified on the compiler options panel when it updates the template.

Enter the EXIT command (F3), to exit the panel saving the changes you have made.

Enter the CANCEL command (F12), to exit the panel without saving the changes you have made.

Panel and field definitions

Figure 30. Compiler Language Selection panel

```

Process  Options  Help
-----
FM/IMS                               Compiler Language Selection

Language Selection:
Specify Default Compiler
  1. COBOL          Use the COBOL compiler
  2. PL/I           Use the PL/I compiler
  3. Auto detect    Determine which compiler to use
  4. HLASM          Use the HLASM compiler

Processing Options:
Enter "/" to select option
  _ Override compiler options for template update
  / Preserve copybook library
  _ Show copybook name with record type field name
  _ Suppress boundary field errors

Command ==>
F1=Help      F2=Split      F3=Exit      F4=CRetrieval F7=Backward  F8=Forward
F9=Swap      F10=Actions   F12=Cancel
    
```

Language Selection

The language used for compiling copybooks to create a template:

1. COBOL

Use the COBOL compiler. This is the default value.

2. PL/I

Use the PL/I compiler.

3. Auto detect

Applies to COBOL and PL/I only. Analyze the source and use the appropriate compiler:

- If the copybooks do not contain any keywords that FM/IMS can use to determine the language, then FM/IMS uses the COBOL compiler.
- If the compiler creates ADATA and produces a return code of 4 or less, then FM/IMS creates the template without any prompting.
- If the compiler creates ADATA but produces a return code greater than 4, then FM/IMS displays a pop-up menu where you can select from various options, including using the other compiler.
- If no ADATA was created, then FM/IMS uses the other compiler without prompting.
- If the other compiler creates ADATA but the return code is greater than 4, then FM/IMS displays the pop-up menu.
- If the other compiler does not create ADATA, then FM/IMS retries the first compiler, and again displays the pop-up menu.

4. HLASM

Use the HLASM compiler.

Override compiler options for template update

Select this option if you want the compiler options specified on the Set COBOL Processing Options panel, the Set HLASM Processing Options panel, or the Set PL/I Processing Options panel to be used when you update a template. If you do not select this option, FM/IMS uses the compiler options stored in the template.

**Note:**

1. Foreground processing will always override the compiler options for older templates that do not contain compiler options. This option should be flagged for batch template update of older templates to generate compiler options in the JCL.
2. Older templates do not contain compiler options but once the update is performed the template is upgraded to contain compiler options that are used in subsequent updates if this option is not selected.

Preserve copybook library

Ensures that, if a copybook still exists in the library that it was previously found in and that library is in the list that the update is using, then that version of the copybook is used.

If you do not select this option, or the copybook no longer exists in the library it was previously found in, or that library is not in the list the update is using, then the utility searches the libraries in the order they are listed and uses the first version of the copybook that it finds.

Show copybook name with record type field name

Select this option to make the copybook name for a record layout visible during template edit and for an edit, view or browse session where a copybook or template is being used.



Note: For the editor session where the layout name is specified it is prefixed with the name of the associated copybook. This may cause the layout name to be truncated, depending on its length.

Suppress boundary field errors

Select this option to suppress in SNGL display format the display or printing of fields that start beyond the current record boundary.

Parent panels

- [Set Language and compiler specifications panel on page 385](#)

Child panels

- None.

Copybook Library List panel

The Copybook Library List panel is displayed in the Template dialog (option 4.1) and in the Template Update Utility dialog (option 4.4).

On the panel, you specify the names of the copybook libraries that contain the copybooks that you want the function to use.

Template dialog

The panel is displayed in the Template dialog when you specify a nonexistent member on the Template Entry panel, or when you issue the LIBLIST command on the Template Specification panel.

The function searches the specified libraries for the layout members you specify on the Template Specification panel.

The Copybook library list you specify is saved in the template and is used for subsequent updates.

When you issue the LIBLIST command, the panel displays the Copybook library list that is currently saved in your template.

Template Update Utility dialog

The panel is displayed in the Template Update Utility dialog when you select the **Specify library data sets** option on the Template Update Utility panel.

When this option is selected, the utility uses the layout members in the specified copybook libraries to build the template (rather than the layout members in the copybook libraries referenced in the template). To avoid update errors, you must ensure that all the layout members referenced in all the templates selected are available in the libraries you specify. If the update using the specified copybook libraries is successful, the utility changes the copybook library list in the template to the specified library list.

Panel and field definitions

Figure 31. Copybook Library List panel

Process	Options	Help
FM/IMS	Copybook Library List	
Copybook Library:		
Data set name	1	'FMN.REGTEST.IMS.COPYLIB.COBOL'
	2	'FMN.REGTEST.IMS.COPYLIB.PLI'
	3	'SSAND.\$RETAIN.SOURCE'
	4	
	5	
	6	
	7	
	8	
	9	
	10	
	11	
	12	
Command ==>		
F1=Help	F2=Split	F3=Exit F9=Swap F12=Cancel

Data set name

One to twelve libraries that must be all PDS(E)s, all CARMA, or all Panvalet libraries, containing the copybooks that describe the segment layouts of the databases whose templates you are creating or updating.

The function searches the libraries in the order in which they are specified.

You can leave early lines blank. For example, you can enter a data set name in line 3, but not in line 1 or line 2. However, you must enter at least one data set name, on one of the lines.

Parent panels

- [Template Specification panel on page 412](#)
- [Template Update Utility panel on page 418](#)

Child panels

- None.

Criteria Member Selection panel

The Criteria Member Selection panel is displayed when you specify either no criteria member name or a criteria member pattern on the Extract Entry panel, Criteria Set Entry panel, or the Criteria Set Update Utility panel.

If no criteria member name is supplied, all the members in the criteria data set are shown on the panel. If a criteria member pattern is supplied, all the members with names that match the pattern are shown on the panel.

To select a criteria member, type `s` in the **Cmd** field and press Enter.

When the selection list is for the field on the Extract or Criteria Set Entry panel, you can only select one member. When the selection list is for the field on the Criteria Set Update Utility panel, you can select multiple members.

The panel also allows you to:

- Select the member attributes that are displayed.
- Select the order in which the member attributes are displayed.
- Specify the width of the column used to display each member attribute.
- Sort the member list by any of the displayed member attributes.
- Use member attribute patterns to filter the member list.
- Browse or view the member.

When the selection list is for the field on the Criteria Set Update Utility panel you can also use the criteria set editor to edit and save the displayed criteria members.

For a detailed description of the panel fields and functionality, see "Member Selection panel" in the *User's Guide and Reference*.

Panel and field definitions

Figure 32. Criteria Member Selection panel (when the selection list is for the criteria member field on the Extract or Criteria Set Entry panel)

Process		Options		Help							
FM/IMS		Criteria Member List						Row 00001 of 00050			
DSNAME FMN.REGTEST.IMS.CRITERIA											
Name	Prompt	Typ	Created	Updated	Lang	Ver	Descri				
*	*	*	*	*	*	*	*				
AHRD#1		CR	2007/07/31	2008/11/26	10:34:55	PL/I	2				
ALPOLLO		CR	2006/12/06	2006/12/15	10:01:48	PL/I	1				
ALPOLXX		CR	2006/12/06	2006/12/15	10:26:55	PL/I	1				
ALPOL390		CR	2006/12/06	2006/12/15	10:26:55	PL/I	1				
A19D#C1		CR	2007/04/19	2007/04/19	10:48:24	COBOL	2				
A70D#C1		CR	2010/01/18	2010/01/18	11:39:39	COBOL	2				
A70D#C5		CR	2010/01/18	2010/01/18	11:50:02	COBOL	2				
A70D#1C1		CR	2010/01/18	2010/01/18	11:39:39	COBOL	2				
A70D#1C5		CR	2010/01/18	2010/01/18	11:50:02	COBOL	2				
A70D#2C1		CR	2010/01/18	2010/01/18	11:39:39	COBOL	2				
A70D#2C5		CR	2010/01/18	2010/01/18	11:50:02	COBOL	2				
A70D#3C1		CR	2010/01/18	2010/01/18	11:39:39	COBOL	2				
A70D#3C5		CR	2010/01/18	2010/01/18	11:50:02	COBOL	2				
A70D#4C1		CR	2010/01/18	2010/01/18	11:39:39	COBOL	2				
A70D#4C5		CR	2010/01/18	2010/01/18	11:50:02	COBOL	2				
CHDVMSOB		CR	2002/11/20	2006/10/06	05:52:34	COBOL	2				
CHDVMPLI		CR	2006/08/11	2006/08/11	06:10:56	COBOL	2				
CZUBD1PL		CR	2008/04/07	2008/04/07	11:57:07	PL/I	2				
C34COB		CR	2006/07/14	2006/07/14	11:41:09	COBOL	1				
C34LESS		CR	2006/07/18	2006/07/18	11:57:42	COBOL	1				
C34MORE		CR	2006/07/18	2006/07/20	10:54:04	COBOL	1				
C34NAME		CR	2006/07/18	2006/07/18	11:54:40	COBOL	1				
C34PLI		CR	2006/07/19	2006/07/19	07:29:43	PL/I	1				

Command ==>

F1=Help	F2=Split	F3=Exit	F4=CRetriev	F5=RFind	Scroll PAGE
F8=Forward	F9=Swap	F10=Left	F11=Right	F12=Cancel	F7=Backward

Figure 33. Criteria Member Selection panel (when the selection list is for the criteria member field on the Criteria Update Utility panel)

Process		Options		Help			
FM/IMS		Criteria Member Selection		Row 00001 of 00050			
Input data set		FMN.REGTEST.IMS.CRITERIA					
Update data set		FMN.REGTEST.IMS.CRITERIA					
Name	Prompt	Typ	Created	Updated	Lang	Ver	Descri
*	*	*	*	*	*	*	*
AHRD#1		CR	2007/07/31	2008/11/26	10:34:55	PL/I	2
ALPOLLO		CR	2006/12/06	2006/12/15	10:01:48	PL/I	1
ALPOLXX		CR	2006/12/06	2006/12/15	10:26:55	PL/I	1
ALPOL390		CR	2006/12/06	2006/12/15	10:26:55	PL/I	1
A19D#C1		CR	2007/04/19	2007/04/19	10:48:24	COBOL	2
A70D#C1		CR	2010/01/18	2010/01/18	11:39:39	COBOL	2
A70D#C5		CR	2010/01/18	2010/01/18	11:50:02	COBOL	2
A70D#1C1		CR	2010/01/18	2010/01/18	11:39:39	COBOL	2
A70D#1C5		CR	2010/01/18	2010/01/18	11:50:02	COBOL	2
A70D#2C1		CR	2010/01/18	2010/01/18	11:39:39	COBOL	2
A70D#2C5		CR	2010/01/18	2010/01/18	11:50:02	COBOL	2
A70D#3C1		CR	2010/01/18	2010/01/18	11:39:39	COBOL	2
A70D#3C5		CR	2010/01/18	2010/01/18	11:50:02	COBOL	2
A70D#4C1		CR	2010/01/18	2010/01/18	11:39:39	COBOL	2
A70D#4C5		CR	2010/01/18	2010/01/18	11:50:02	COBOL	2
CHDVMSOB		CR	2002/11/20	2006/10/06	05:52:34	COBOL	2
CHDVMPLI		CR	2006/08/11	2006/08/11	06:10:56	COBOL	2
CZUBD1PL		CR	2008/04/07	2008/04/07	11:57:07	PL/I	2
C34COB		CR	2006/07/14	2006/07/14	11:41:09	COBOL	1
C34LESS		CR	2006/07/18	2006/07/18	11:57:42	COBOL	1
Command ==>						Scroll PAGE	
F1=Help	F2=Split	F3=Exit	F4=CRetriev	F5=RFind	F7=Backward		
F8=Forward	F9=Swap	F10=Left	F11=Right	F12=Cancel			

Parent panels

- [Criteria Set Update Utility panel on page 229](#)
- [Extract Entry panel on page 275](#)

Child panels

- None.

Criteria Set Entry panel

When you select Criteria Sets (option 3) on the Template/View/Criteria Set menu, FM/IMS displays the Criteria Set Entry panel:

Panel and field definitions

Figure 34. Criteria Set Entry panel

Process	Options	Help
FM/IMS		Criteria Set Entry Panel
CT	Create criteria set from template	E Edit criteria set
CM	Create criteria set from model	U Update criteria set from template
Template:		
	Data set name . 'FMN.IMS.IVP.TEMPLATE'	
	Member DJ2E	
Criteria:		
	Data set name . 'FMN.IMS.IVP.CRITERIA'	
	Member SUBURB	
Model criteria:		
	Data set name .	
	Member	
Command ==> CT		
F1=Help	F2=Split	F3=Exit
F9=Swap	F10=Actions	F12=Cancel
	F4=CRetrieval	F7=Backward
		F8=Forward

To use this panel, first decide on the command you want to use, then fill in the required fields (described for each command, in the following list), then type the command on the command line and press Enter:

CT

Creates a new, empty extract criteria set from a template.

In this field...

Enter these details...

Template

The name of the partitioned data set that holds the template you want used to create the criteria set.

Criteria set

Sequential data set name, or PDS and member name, where you want to save the new criteria set.

The **Data set name** field may also include a member name or name pattern in parentheses. If a member or member pattern is specified here, the associated **Member** field must be blank.

CM

Creates a new extract criteria set by copying an existing (*model*) extract criteria set.

In this field...

Enter these details...

Model criteria set

Sequential data set name, or PDS and member name, of the criteria set you want to copy (use as a *“mode!”* for the new criteria set). The **Data set name** field may also include a member name or name pattern in parentheses. If a member or member pattern is specified here, the associated **Member** field must be blank.

Criteria set

Sequential data set name, or PDS and member name, where you want to save the new criteria set. The **Data set name** field may also include a member name or name pattern in parentheses. If a member or member pattern is specified here, the associated **Member** field must be blank.

E

Edits an extract criteria set.

In this field...

Enter these details...

Criteria set

Sequential data set name, or PDS and member name, of the criteria set you want to edit. The **Data set name** field may also include a member name or name pattern in parentheses. If a member or member pattern is specified here, the associated **Member** field must be blank.

U

Updates an existing criteria set from the template that it was created from.

In this field...

Enter these details...

Criteria set

Sequential data set name, or PDS and member name, of the existing criteria set you want to update. The **Data set name** field may also include a member name or name pattern in parentheses. If a member or member pattern is specified here, the associated **Member** field must be blank.



Note: This command ignores any template you specify in the **Template** field. Instead, it obtains the PDS and member of the template from the criteria set.

Use this command when minor changes have been made to the template that the criteria set was created from.

If significant changes have been made to the template, then the update process might not produce the expected results. In this case, use the **CT** command to recreate the criteria set from the template and then the **E** command to edit it.

Parent panels

- [Template/View/Criteria Set Menu panel on page 423](#)

Child panels

- [Criteria Member Selection panel on page 224](#)
- [Subset Selection panel on page 399](#)

Criteria Set Update Utility panel

The Criteria Set Update Utility panel allows you to update existing criteria sets either to the input data set or to an optional output data set.

You can:

- Use the template filters to select only criteria sets based on a specified template or a template that matches the pattern.
- Change the template data set used to update the criteria sets.
- Run the utility in batch or foreground.

Panel and field definitions

Figure 35. Criteria Update Utility panel

<u>P</u> rocess	<u>O</u> ptions	<u>H</u> elp
FM/IMS		Criteria Set Update Utility
Criteria:		
Data set name . . .	_____	
Member	_____	
Template filter . .	_____	
Output Criteria Set:		
Data set name . . .	_____	
Member mask	_____	
Template:		
Data set name . . .	_____	
Processing Options:		
Enter "/" to select option		
<input type="checkbox"/> Batch execution	<input type="checkbox"/> Replace member	
<input type="checkbox"/> Advanced member selection	<input type="checkbox"/> Specify Template data set	
<input type="checkbox"/> Skip member list	<input type="checkbox"/> Check mode - no update	
<input type="checkbox"/> Forced update	<input type="checkbox"/> Specify subsystem	
Command ==>		Scroll <u>P</u> A <u>G</u> E
F1=Help	F2=Split	F3=Exit
F9=Swap	F10=Actions	F12=Cancel
F4=CRetrieve	F7=Backward	F8=Forward

Criteria

Data set name

(Required) A fully-qualified or generic data set name used to identify the data set which must be partitioned.

In a generic data set name, use the percent sign (%) to represent a single character, and an asterisk (*) to represent any number of characters within a qualifier. Two asterisks (**) represent any number of characters within any number of qualifiers.

The TSO prefix (as defined for your user ID) is used as the high-level qualifier for any name that is not enclosed in quotation marks.

For performance reasons, you should qualify the data set name as much as you can.

You can combine the member name with the dataset name in the form *Data set name(Member)*.

Member

Name of a member of a partitioned data set. If you leave the member name blank, or specify a member name pattern, FM/IMS displays a member name list. You can then select the required member by entering S in the Select field for the appropriate member.

A member name pattern can consist of any characters that are valid in a member name and two special pattern characters, the asterisk (*) and the percent sign (%):

*

Represents any number of characters. As many asterisks as required can appear anywhere in a member name. For example, if you enter *d*, a list all members in the data set whose name contains "d" is displayed.

%

A place holding character that means a single character. As many percent symbols as necessary may appear anywhere in a member name. For example, if you enter: %%%%, a list of all members in the data set whose name is 4 characters in length is displayed.

Template filter

Enter up to four template member names or patterns to limit the selection and processing to those criteria that are based on one of the specified templates, or a template that matches one of the specified patterns.



Note: As the Template member name is the same as the name of the database, this is also a database filter.

Output Criteria Set

Data set name

(Optional) A fully-qualified or generic data set name used to identify the output data set which must be partitioned. If this field is not specified, then the update takes place on the input data set.

You can specify a generic data set name using the percent (%) sign and asterisk (*) as described for the criteria set data set name above.

The TSO prefix (as defined for your user ID) is used as the high-level qualifier for any name that is not enclosed in quotation marks. For performance reasons, you should qualify the data set name as much as you can.

You can combine the member name with the dataset name in the form *Data set name(Member)*.

Member mask

Specify a pattern to rename members in the output partitioned data set based upon the member names in the input partitioned data set. A member name pattern can consist of any characters that are valid in a member name and two special pattern characters: the asterisk (*) and the percent sign (%).

*

A place-holding character that means multiple characters with no change. Only one asterisk should appear in the mask. Any subsequent asterisk characters are treated as percent signs.

For example, if you enter:

```
ABC*
```

the renamed members will all begin with ABC followed by the remainder of the old member name.

%

A place-holding character that means a single character with no change. As many percent symbols as necessary may appear anywhere in a member name.

For example, if you enter:

```
%%%A*
```

the first 3 characters of the renamed members remain unchanged, the fourth character is replaced with the letter "A", and the remainder of the old member name remain unchanged.

Template

Data set name

This field is only used when the **Specify Template data set** option is selected. When this option is selected, the templates in the specified data set are used to update the criteria sets (rather than the template referenced in each criteria set) and, if the update is successful, the utility changes the template data set name in the criteria set to the specified data set name.

Processing Options:

Batch execution

Presents the JCL to run the function in batch. The JCL can be edited and submitted. You can use the Set Batch Job Card Information panel to tailor the default JOB card that FM/IMS uses to generate JCL.

Advanced member selection

Allows you to specify which members are to be processed based on member name, created date, last changed date, and the user ID by which the member was last updated. For each of these criteria, a mask or range of values can be entered.

Skip member list

Run without showing the member selection list. This option bypasses the member list panel and process all the qualifying members. If an error (like a duplicate output name) results from the specified parameters, then the member list panel is displayed with the errors highlighted.

Forced update

Performs the update even if no changes have been detected.

Replace member

Replaces like-named members in an output partitioned data set.

Specify template data set

Allows you to specify the Template data set that the utility uses to update the criteria sets.

Select this option if you want your criteria sets to be based on templates that are in the data set you specify in the Template data set name field. The specified template data set name is stored in the updated criteria sets and they are flagged as being based on a static template.

If the Specify subsystem option is also selected, only criteria sets that are based on static templates are updated in this way. Those that are based on dynamic templates are updated as described in the help for the Specify subsystem option.

When neither of these options are selected and the criteria set is based on a static template, the utility bases the criteria set on the template whose name is stored in the criteria set.

Specify subsystem

Select this option if you want your criteria sets to be based on *dynamic templates*. These are templates that are dynamically generated from data in an IMS™ catalog or DBD libraries.

If this option is selected, the IMS Subsystem Specification panel is displayed. Use this panel to specify the source of the data from which the template is generated. The name of the data source is stored in the updated criteria sets and they are flagged as being based on a dynamic template.

If the Specify Template data set option is also selected, only criteria sets that are based on dynamic templates are updated in this way. Those that are based on static templates are updated as described in the help panel for the Specify Template data set option.

When neither option is selected and the criteria set is based on a dynamic template, the utility bases the criteria set on a template that is generated from the data source that is specified in the criteria set.

Check mode - no update

Runs the function without saving the resulting members. Normally used to check for errors.

Parent panels

- [Template/View/Criteria Set Menu panel on page 423](#)

Child panels

- [Advanced Member Selection panel on page 192](#)
- [JCL Submission panel on page 331](#)
- [View Member Selection panel on page 428](#)

Data Set Selection panel

The Data Set Selection panel lists all data sets that match the data set name pattern provided in a data set name field. The panel title is preceded by the name of the field in which you entered the pattern.

Panel and field definitions

Figure 36.

Process	Options	Help
FM/IMS	DBDLIB #1 Data Set Selection	Row 00001 of 00009
Data Set Selection for FMN.REGTEST.IMS.DBDL**		
Data Set Name	Type	Volume Created
FMN.REGTEST.IMS.DBDL**	*	* * *
— FMN.REGTEST.IMS.DBDLIB	NVSAM	D\$FM06 2003.310
— FMN.REGTEST.IMS.DBDLIB.DUMMY	NVSAM	D\$FM08 2005.206
— FMN.REGTEST.IMS.DBDLIB.INFRONT	NVSAM	D\$FM11 2005.094
— FMN.REGTEST.IMS.DBDLIB.LESS	NVSAM	D\$FM14 2006.193
— FMN.REGTEST.IMS.DBDLIB.MORE	NVSAM	D\$FM14 2006.193
— FMN.REGTEST.IMS.DBDLIB.SEQ	NVSAM	D\$FM09 2008.196
— FMN.REGTEST.IMS.DBDLIB.V6	NVSAM	D\$FM06 2002.171
— FMN.REGTEST.IMS.DBDLIB2	NVSAM	D\$FM11 2008.183
— FMN.REGTEST.IMS.DBDLIB2.OLD	NVSAM	D\$FM02 2006.223
**** End of data ****		
Command ==>		
F1=Help	F2=Split	F3=Exit
F9=Swap	F12=Cancel	F4=CRetriev F7=Up
		Scroll PAGE
		F8=Down

Data Set Selection for

Indicates the pattern used in the data set name field.

Sel

Select field, in which you can enter to select your data set. While you can enter the in more than one field, only the first selected data set is processed.

Data Set Name

Lists the data sets that match your pattern.

Type

Lists the data set type for each data set displayed.

Volume

Lists the volume on which the data set is stored.

Created

Lists the creation data for each data set, in the format yyyy.ddd where ddd is the day number within the year (not the date). For example, 2003.036 is February 05, 2003.

Parent panels

All panels with a data set name field.

Related topics and examples

- [Accessing in BMP mode using a Static PSB on page 49](#)
- [Accessing in BMP mode using a Dynamic PSB on page 51](#)
- [Accessing in DLI mode using a Static PSB on page 52](#)
- [Accessing in DLI mode using a Dynamic PSB on page 55](#)

Database Data Set Display panel

The Database Data Set Display panel displays the names of the database data sets that the function will use.

The panel is displayed when, on the Browse Entry panel, Edit Entry panel, Extract Entry panel, Load Entry panel, Print Entry panel, Batch Edit Entry panel, or Batch Browse Entry panel, you specify:

- **Region type** of "DLI".
- **Skip DB data set panel** option not selected.
- Either a database that is a HALDB or an IMS subsystem that is defined as dynamic allocation only in the FM/IMS installation options module.

It is also displayed when, on the Delete/Define or Initialize Entry panel, you specify:

- The **Skip DB data set panel** option as not selected.
- Either a database that is a HALDB or an IMS subsystem that is defined as dynamic allocation only in the FM/IMS installation options module.

Panel and field definitions

Figure 37. Database Data Set Display panel

```

Process  Options  Help
-----
FM/IMS          Browse : Database Data Set Display

Subsystem IF32  Database DJ1E

DBD name  DD name  Data set name
DJ1E      DJ1E     'FM.XTEST.DB.DJ1E'
DJ2E      DJ2E     'FM.XTEST.DB.DJ2E'
DJ2F      DJ2F     'FM.XTEST.DB.DJ2F'
DJ3E      DJ3E     'FM.XTEST.DB.DJ3E'
DJ3F      DJ3F     'FM.XTEST.DB.DJ3F'
DJ1F      DJ1F     'FM.XTEST.DB.DJ1F'
****      End of data  ****

Press ENTER to confirm usage of the specified data set(s)
Command ==>
F1=Help      F2=Split      F3=Exit      F4=CRetrieval  F7=Backward  F8=Forward
F9=Swap      F10=Actions   F12=Cancel

```

Subsystem

The subsystem name you specified on the function's entry panel.

Database

The database name you specified on the function's entry panel.

DBD name

The names of these physical DBDs:

- Either the DBD for the database specified on the function's entry panel (if it is a physical DBD), or the physical DBDs that it references (if it is a logical DBD).
- The physical DBDs that are logically related to the physical DBDs specified in the above bullet.

DD name

The DD name for each database data set dynamically allocated by IMS.

Data set name

The names of the database data sets dynamically allocated by IMS. For HALDB databases, FM/IMS obtains the data set names from DBRC. For non-HALDB databases, FM/IMS obtains the data set names from the DFSMDA dynamic allocation members.

Verify that the database data sets listed are the ones you want the function to use.

To confirm usage of these data sets and to proceed to the next panel in the dialog, press Enter.

Parent panels

- [Batch Browse Entry panel on page 195](#)
- [Batch Edit Entry panel on page 201](#)
- [Browse Entry panel on page 214](#)
- [Delete/Define Entry panel on page 251](#)
- [Edit Entry panel on page 266](#)
- [Extract Entry panel on page 275](#)
- [Initialize Entry panel on page 318](#)
- [Load Entry panel on page 335](#)
- [Print Entry panel on page 351](#)

Child panels

- [Batch Browse Options panel on page 201](#)
- [Batch Edit Options panel on page 207](#)
- [Database Positioning panel on page 239](#)
- [JCL Submission panel on page 331](#)
- [Load Options panel on page 341](#)
- [Extract : To Data Set Specification panel on page 285](#)

Database Data Set Specification panel

On the Database Data Set Specification panel, you specify the database data sets that you want the function to use.

The panel is displayed when, on the Browse Entry panel, Edit Entry panel, Extract Entry panel, Load Entry panel, Print Entry panel, Batch Edit Entry panel, or Batch Browse Entry panel, you specify:

- **Region type** of "DLI".
- **Skip DB data set panel** option not selected.
- A database that is not a HALDB.
- An IMS subsystem that is not defined as dynamic allocation only in the FM/IMS installation options module.

It is also displayed when, on the Delete/Define Entry panel or the Initialize Entry panel, you specify:

- Skip DB data set panel option not selected.
- A database that is not a HALDB.
- An IMS subsystem that is not defined as dynamic allocation only in the FM/IMS installation options module.

Panel and field definitions

Figure 38. Database Data Set Specification panel

Process	Options	Help
FM/IMS	Edit : Database Data Set Specification	
Subsystem IF52 Database DJ1E		
DBD name	DD name	Data set name
DJ1E	DJ1E	'FMN. IMS. IVP. DB. DJ1E'
DJ2E	DJ2E	'FMN. IMS. IVP. DB. DJ2E'
DJ2F	DJ2F	'FMN. IMS. IVP. DB. DJ2F'
DJ3E	DJ3E	'FMN. IMS. IVP. DB. DJ3E'
DJ3F	DJ3F	'FMN. IMS. IVP. DB. DJ3F'
DJ1F	DJ1F	'FMN. IMS. IVP. DB. DJ1F'
**** End of data ****		
Processing Options:		
Fetch dsnames from		Enter "/" to select option
1	1. User profile	Save dsnames in profile
2	2. DFSMDA members	
Press ENTER to confirm usage of the specified data set(s)		
Command ==>		Scroll CSR
F1=Help	F2=Split	F3=Exit
F9=Swap	F10=Actions	F12=Cancel
F4=CRetriev	F7=Backward	F8=Forward

Subsystem

The subsystem name you specified on the selected function's Entry panel.

Database

The database name you specified on the function's entry panel.

DBD name

The names of these physical DBDs:

- Either the DBD for the database specified on the function's entry panel (if it is a physical DBD), or the physical DBDs that it references (if it is a logical DBD).
- The physical DBDs that are logically related to the physical DBDs specified in the above bullet.

ddname

The DD name for each database data set that the function uses.

Data set name

When the **Fetch dsnames from** option is set to "User profile", the panel displays the data set names that were saved in your user profile. See the description for the **Save dsnames in profile** option for more details.

When the **Fetch dsnames from** option is set to "DFSMDA members" and the RESLIB data sets for the specified subsystem have DFSMDA dynamic allocation members for the listed physical DBDs, the panel displays the database data sets names specified in these members.

If the displayed data set names are not the ones you want the function to use (or no data set names are displayed), type in the data set names that you want the function to use and press Enter.

To confirm usage of the displayed data set names and to proceed to the next panel in the dialog, press Enter once more.

Fetch dsnames from

This option allows you to select which data set names are displayed on the panel. Enter:

1. User profile

Display the data set names stored in your user profile.

2. DFSMDA members

Display the data set names specified in the DFSMDA dynamic allocation members.

When you first enter this panel, this option is set to the value you specified for the **Fetch DB dsnames from** option on the function's entry panel.

Save dsnames in profile

Select this option if you want the database data set names that are displayed on the panel to be saved in your user profile. The data set names are saved when you move forward in the dialog to the next panel. They are saved in an ISPF table that is keyed on the subsystem name, the DBD name and the DD name. Whenever the panel is redisplayed for the specified subsystem and database (or a logically-related database), these saved database data set names are displayed if the **Fetch dsnames from** option is set to User profile.

Parent panels

- [Batch Browse Entry panel on page 195](#)
- [Batch Edit Entry panel on page 201](#)
- [Browse Entry panel on page 214](#)
- [Delete/Define Entry panel on page 251](#)
- [Edit Entry panel on page 266](#)
- [Extract Entry panel on page 275](#)
- [Initialize Entry panel on page 318](#)
- [Load Entry panel on page 335](#)
- [Print Entry panel on page 351](#)

Child panels

- [Batch Browse Options panel on page 201](#)
- [Batch Edit Options panel on page 207](#)
- [Database Positioning panel on page 239](#)
- [JCL Submission panel on page 331](#)
- [Load Options panel on page 341](#)
- [Extract : To Data Set Specification panel on page 285](#)

Panel and field definitions

Figure 40. Database Positioning panel

Process	Options	Help				
FM/IMS		Edit : Database Positioning				
Subsystem	IF52	Database	DJ1E	Key sequence		Format <u>TABL</u>
View	C	Temporary		Key		
Cmd	SXE	Level	Segment	Description	len	Key value
	SX	1	SHIRE		20	
	X	2	SHIRENP		0	
	XE	2	LINKSUB		18
**** End of data ****						
Command ==>						Scroll <u>CSR</u>
F1=Help	F2=Split	F3=Exit	F4=CRetriev	F5=Key >=	F7=Backward	
F8=Forward	F9=Swap	F10=Actions	F12=Cancel			

Subsystem

The subsystem ID you specified on the Edit Entry panel.

Database

This displays the name of the DBD entered on the Edit Entry or Browse Entry panel. This line also contains the Key sequence for the following types of database: HSAM, SHSAM, HISAM, SHISAM, HIDAM, GSAM, INDEX, MSDB.

View

This displays the View data set and member being used. If you are not using a view on this session, this displays as None. If the view is generated from a template (a new view), the name displayed is "Temporary?". If this view has been changed (by line or primary commands), a **C** indicator is shown until the view is saved.

Cmd

The line command field. Line commands available on this panel are:

E (Edit)

Enter e in the Cmd field of the segment type you want to edit the view for. This is only available when a view is used.

K (Key value)

Enter k in the Cmd field of the segment type you want to display, to display the Key Specification panel. On this panel you can specify the key fields of all segment types in the hierarchical path of the segment type you selected.

S (Position)

Enter s in the Cmd field of the segment type you want to position on to begin retrieval of segments for the data display panels and specify the key values in the Key value field(s) for all the segment types in the hierarchical path of the segment occurrence you want. Pressing ENTER uses the entered specific key values as an equals search. When used with the GE command

(assigned by File Manager to function key F5), you can enter a partial key in the key value field. For example, entering a S in the Cmd field a M in the root segment key value field and press F5 to display segments starting from those whose root segments start with M. For database types that are not key-sequenced, you must enter a specific key at the root segment level (even when using the GE command), but you may enter a partial key at lower levels.

X (Select)

Enter x in the Cmd field of the segment type you want to alter the view to select or deselect. Again, this is only available if a view is being used.

Use this field to specify the position at which you want to start editing.

SXE

Denotes three columns of information:

S

Shown when the segment type is in the hierarchical path of the current position, is blank otherwise.

X

Is shown for those segments that are selected for display by the current view. If no view is used, all segments are considered selected.

E

Is shown for those segments that have selection expression or expressions in the current view.

Level

The hierarchical level of the segment type in the database.

Segment

The name of the segment type.

Description

If you are using a view, then this is the segment description (specified when you create a template). Otherwise, the field is blank.

Key len

The length of the key of the segment type.

Key value

When you return to this panel after editing a database, and the segment type is in the hierarchical path of the position where you finished editing, then this field contains the key value at that position. Otherwise, this field contains binary zeros.

When you first display this panel (before editing the database), if the database organization stores root segments in key sequence, then this field contains the key value of the first root segment in the database.

The key value is displayed as unformatted characters. Binary and packed decimal numeric field values are not displayed as their formatted numeric values, even if you are using a view.

You can issue the HEX ON command to display the hexadecimal contents of the key value in a format similar to that used within the editor, where the hexadecimal values are shown underneath the key characters.

If the key is longer than thirty characters, then its value wraps onto the next line on the panel.

Parent panels

- [Database Data Set Display panel on page 234](#)
- [Database Data Set Specification panel on page 236](#)
- [Browse Entry panel on page 214](#)
- [Edit Entry panel on page 266](#)
- [Secondary Index Selection panel on page 367](#)

Child panels

- [IMS data panel on page 309](#)
- [Segment Layout panel on page 370](#)
- [Segment Layout Selection panel on page 377](#)
- [Key Specification panel on page 332](#)

Related topics and examples

- [Determining your starting position via the Database Positioning panel on page 59](#)

Database Selection panel

The Database Selection panel is displayed when, on the Edit, Browse, Extract, Load, Print, Batch Edit or Batch Browse Entry panel, you specify:

- "Dynamic" for **PSB type**.
- Either no database name or a database name pattern.

It is also displayed when you specify either no database name, or a database name pattern, on the Delete/Define or Initialize Entry panel.

There are two versions of this panel. The version that is displayed depends on whether or not the subsystem you select on the entry panel uses IMS-managed ACBs. Each of these versions are discussed in turn.

Subsystem uses IMS-managed ACBs

If no database name is supplied, all the databases in the IMS catalog that the selected subsystem uses, are shown on the panel. If a database name pattern is supplied, all the databases in the IMS catalog with names that match the pattern are shown on the panel.

Panel and field definitions

Figure 41. Database Selection panel

Process	Options	Help
FM/IMS		Initialize : Database Selection
Subsystem IFG1		
Cmd	DB name	Timestamp
	AHRD#1	1524414432060
	AHRD#2	1524414432060
	AHRD#4	1524414432060
	AHRX#1	1524414432060
	AHRX#2	1524414432060
	AHRX#4	1524414432060
	ATRD#1	1524414432060
	ATRD#2	1524414432060
	ATRD#4	1524414432060
	ATRX2#1	1524414432060
	ATRX2#2	1524414432060
	ATRX2#4	1524414432060
	AUBD#1	1524414432060
	AUBD#2	1524414432060
Command ==>		
F1=Help	F2=Split	F3=Exit
F4=CRetriev	F5=Key >=	Scroll CSR
F8=Forward	F9=Swap	F10=Actions
F12=Cancel		F7=Backward

The panel displays the subsystem name you specified on the entry panel and these details for each database:

DB name

The name of the database.

Timestamp

The timestamp of its ACB in the active ACB library.

To select a database, type **S** in the **Cmd** field and press Enter.

Subsystem does not use IMS-managed ACBs

If no database name is supplied, all the DBDs in the DBD libraries for the selected subsystem are shown on the panel. If a database name pattern is supplied, all the databases with names that match the pattern are shown on the panel.

Panel and field definitions

Figure 42. Database Selection panel

Process	Options	Help							
FM/IMS			Database Selection						Row 00001 of 01313
DSNAME	FMN.REGTEST.IMS.DBDLIB								
Name	Prompt	Lib	Alias-of	Size	AC	AM	RM	---- Attribut	
*	*	*	*		*	*	*	*	
_____	#TRD	3		00000228	00	24	24		
_____	#TRX2	3		00000138	00	24	24		
_____	#UBD	3		00000240	00	24	24		
_____	#UBX	3		00000138	00	24	24		
_____	ABND	1		00000250	00	24	24		
_____	ABND#1	1		00000250	00	24	24		
_____	ABND#2	1		00000250	00	24	24		
_____	ABND#3	1		00000250	00	24	24		
_____	ABND#4	1		00000250	00	24	24		
_____	ACCTDB	1		00000360	00	24	24		
_____	ACT	3		00000130	00	24	24		
_____	AGCPDB01	3		00000450	00	24	24		
_____	AGCXDB01	3		00000240	00	24	24		
_____	AGCXDB02	3	AGCXDB01	00000240	00	24	24		
_____	AGCXDB03	3	AGCXDB01	00000240	00	24	24		
Command	==>							Scroll CSR	
F1=Help	F2=Split	F3=Exit	F4=CRetriev	F5=RFind				F7=Backward	
F8=Forward	F9=Swap	F10=Left	F11=Right	F12=Cancel					

For each database, the panel displays its name and other attributes of its DBD.

To select a database, type **S** in the **Cmd** field and press Enter.

For a detailed description of the panel fields and functionality, see the description of the Member Selection panel in the *User's Guide and Reference*.

Parent panels

- [Batch Browse Entry panel on page 195](#)
- [Batch Edit Entry panel on page 201](#)
- [Browse Entry panel on page 214](#)
- [Delete/Define Entry panel on page 251](#)
- [Edit Entry panel on page 266](#)
- [Extract Entry panel on page 275](#)
- [Initialize Entry panel on page 318](#)
- [Load Entry panel on page 335](#)
- [Print Entry panel on page 351](#)

Date/Time Attributes panel

This panel is used to define a field that contains date or time values (or both). The panel lists the formatting for the date and time field, data create and modify attributes, and data scrambling attributes. You can define the format in which the data and time data is stored, if necessary override the data type for the field, and modify the format used to display the date and time. You can also specify data create and field scrambling options.

Panel and field definitions

Figure 43. Date/Time Attributes panel

Process	Options	Help
File Manager		
Date/Time Attributes		
Command ==>		
Fixed Attributes:		
Field name	CHAR-DDMMYYYY	
Type	AN	
Start	10	
Length	8	
Internal Attributes:		
Format	DDMMYYYY	+
Type	—	
Output Attributes:		
Format	DD/MM/YYYY	+
Create/Modify Attributes:		
Base Date	20/10/2014	+
	(Use = for current date/time)	
Day Adjustment	_____	
Month Adjustment	_____	
Year Adjustment	_____	
Scrambling Options:		
Enter "/" to select option		
Random Range Start	_____	+
End	_____	+
F1=Help	F2=Split	F3=Exit
F9=Swap	F10=Left	F11=Right
	F4=Expand	F12=Cancel
	F5=RFind	F7=Up
		F8=Down

FM/IMS displays these fields on the Date/Time Attributes panel:

Internal attributes

Used to define how the date and time value is stored in the field.

Format

Specifies the format in which a date and time value is stored in the field. The format value can be a string containing picture characters supported by the Language Environment date and time callable services. For example if an 8 byte, external decimal field is used to store a date in the form of a 4 digit year value followed by a 2 digit month value followed by a 2 digit day value you would specify the format string as:

YYYYMMDD

You can also enter one of the following formats supported by File Manager:

CENTSECS

Time of day in hundredths of seconds

CBLDATE

COBOL date (the number of days since 31 December 1600)

CYDDD

Julian date with C as the century indicator (0 = 1900s, 1 = 2000s)

LILDATE

Lilian date (the number of days since 14 October 1582)

LILTIME

Date and time stored as the number of seconds since 00:00:00 14 October 1582.

MICSECS

Time of day in millionths of seconds.

MILLSECS

Time of day in thousandths of seconds.

STCK

Date and time stored as a TOD clock value.

STCKE

Date and time stored as an extended TOD clock value.

Type

Specifies a data type that overrides the data type defined in the field attributes. This is used when the field data type is not appropriate for the processing of the date and time value. For example if an alphanumeric field is used to store microsecond time values BI (binary) can be entered in the Type field to ensure File Manager performs valid processing of the time values.

Output attributes

Used to define how the date and time value is displayed.

Format

Specifies the format used to display the date and time values for this field. You enter the format as a string containing picture characters supported by the Language Environment date and time callable services. For example to display a date value as a string showing a 3 character day-of-week, a 3 character month, 2 digits for the day of the month, and 4 digits for the year you could specify the format string

```
Www Mmm DD, YYYY
```

When FM/IMS displays a date and time field in formatted mode, the output width for the field is set to the length of the specified output format.

Create/Modify Attributes

These define the field-specific attributes used by the data create and data copy functions when creating test data for records containing this field.

Base Date

Specifies a date value to be used when creating new data for this field. You enter a date value in the output format defined for this field. You can enter an = to indicate that the current date is to be used. When you press Enter this value is retrieved and replaces the = in the field. The value

retrieved is a constant, so that if a data create function is run later, the same value will always be used to populate the field.

You can enter * to indicate that the date at the time the data is created should be used to populate the field. Specifying * indicates a variable value for the field when a data create function is run, that value is the date on which the create function is executed.

Day Adjustment

Specifies a value to increment or decrement the day value in the base date. The value should consist of integers optionally preceded by the plus (+) or minus (-) character. The plus character indicates the day value should be incremented. The minus character indicates the day value should be decremented. If a plus or minus character is not specified a plus is assumed.

The increment or decrement value is applied to the day value stored in the field for the previous record. For example, a value of -1 indicates that each subsequent record should have a date value one day earlier than the date value stored in the previous record.

Month Adjustment

Specifies a value to increment or decrement the month value in the base date. The value should consist of integers optionally preceded by the plus (+) or minus (-) character. The plus character indicates the month value should be incremented. The minus character indicates the month value should be decremented. If a plus or minus character is not specified a plus is assumed.

The increment or decrement value is applied to the month value stored in the field for the previous record. For example, a value of +1 indicates that each subsequent record should have a date value one month later than the date value stored in the previous record.

Year Adjustment

Specifies a value to increment or decrement the year value in the base date. The value should consist of integers optionally preceded by the plus (+) or minus (-) character. The plus character indicates the year value should be incremented. The minus character indicates the year value should be decremented. If a plus or minus character is not specified a plus is assumed.

The increment or decrement value is applied to the year value stored in the field for the previous record. For example, a value of -1 indicates that each subsequent record should have a date value one year earlier than the date value stored in the previous record.

Scrambling Options

These options control field scrambling used during copy, import, or export functions to produce test data.

Random

If this option is selected File Manager performs random scrambling when copying values into this date and time field. For random scrambling the same input value will produce different output values on subsequent invocations. If this option is not selected and range Start and End values are specified File Manager performs repeatable scrambling for this date and time field.

Repeatable scrambling means the same input value will produce the same output value on subsequent invocations.

For both random and repeatable scrambling, the Start and End values define the range of acceptable date and time values that File Manager can store in this field.

Start

Specifies a date and time value that is the start of a range of scrambled values that can be stored in this field when copying data into this data set. You enter the date and time value in the output format defined for this field.

End

Specifies a date and time value that is the end of a range of scrambled values that can be stored in this field when copying data into this data set. You enter the date and time value in the output format defined for this field.

Parent panels

Child panels

DBD Information panel

This panel is displayed when you enter the DBD primary command.

Panel and field definitions

Figure 44. DBD Information panel

<u>P</u> rocess	<u>O</u> ptions	<u>H</u> elp						
FM/IMS			DBD Information					
Database	DJ1E							
Access	HIDAM							
	Segment			Key			Dataset	
Cmd	Number/Name/Level	Length	Start	Length	Parent	Group		
	**** Top of data ****							
	1 SHIRE	1 53	1	20		DJ1E		
	2 SHIRENP	2 11			SHIRE	DJ1E		
	3 LINKSUB	2 18	1	18	SHIRE			
	**** End of data ****							
Command ==>								
F1=Help	F2=Split	F3=Exit	F4=CRetrieval	F7=Backward	Scroll CSR			
F9=Swap	F10=Actions	F12=Cancel		F8=Forward				

FM/IMS displays these fields on the DBD Information panel:

Database

The name specified on the DBD statement in the DBDGEN for the database

Access

The DL/I access method for the database

Cmd

The line command field. Line commands available on this panel are:

S

The Segment Information panel for this segment is displayed.

Segment Number

The sequential number used to uniquely identify the segment in the database.

Segment Name

The name of the segment as defined in the DBD.

Segment Level

The hierarchical level number of the segment in the database.

Length

The segment length as defined in the DBD. FM/IMS displays the minimum and maximum lengths for variable length segments.

Key Start

The starting position of the segment's key field. This field is blank if the segment has no key.

Key Length

The length of the segment's key field. This field is blank if the segment has no key.

Parent

The name of the parent of the segment. This field is blank if the segment is the root segment for the database.

Data set Group

The ddname of the data set group where the segment is stored.

Parent panels

- All panels after the Entry panel for each function, displayed when the DBD primary command is entered (see [DBD primary command on page 449](#))

Child panels

- [Segment Information panel on page 369](#)

DBD Library List panel

The DBD Library List panel is displayed in the Template dialog (option 4.1) and in the Template Update Utility dialog (option 4.4).

On the DBD Library list panel, you specify the names of the DBD libraries that contain the database definitions (DBDs) that you want the function to use.

Template dialog

The panel is displayed in the Template dialog when, on the Template Entry panel, you specify:

- A template member that does not exist.
- A subsystem that does not use IMS-managed ACBs.

The panel is also displayed, if a DBD library list, rather than the name of an IMS catalog, is stored in the template that you specify and any of the following are true:

- One of the DBD libraries in the list is not cataloged.
- One of the DBDs that the function uses cannot be found in the DBD libraries.
- You issue the DBDLIST command on the Template Specification panel.

The function searches the specified libraries for a DBD for the database that the template is for and obtains a list of segment types in the database from the DBD that it finds. For a new template, this list is used to create the template's segment list. For an existing template, if the template's segment list is not the same as this list, the function updates the template's segment list to make it the same.

The DBD library list you specify is saved in the template and is used by subsequent updates.

When you issue the DBDLIST command, the panel displays the DBD library list that is currently stored in your template.

Template Update Utility dialog

The panel is displayed in the Template Update Utility dialog when the **Specify DBDLIB list** option is selected and the **Skip database segment list update** option is not selected. Both these options are on the Template Update Utility panel.

The utility uses the DBDs in the specified DBD libraries when either or both of these conditions are true:

- The **Specify IMS catalog** option is not selected.
- The DBDs that were used the previous time the template's segment list was updated came from DBD libraries rather than an IMS catalog.

When this is the case, the utility searches the specified libraries for a DBD for the database that the template is for and obtains a list of the segment types in the database from the DBD that it finds. If the template's segment list is not the same as this list, the utility updates the template's segment list to make it the same.

If the update of the template is successful, the utility saves the specified DBD library list in the template.

**Note:**

1. When the **Skip database segment list update** option is not selected, the **Specify IMS catalog** and the **Specify DBDLIB list** options are selected, and the DBDs that were used the previous time the template's segment list was updated came from an IMS catalog, the utility uses the DBDs in the IMS catalog specified on the IMS Catalog Specification panel.
2. When the **Skip database segment list update**, the **Specify IMS catalog** and the **Specify DBDLIB list** options are all not selected, the utility uses the DBDs in either the DBD library list stored in the template or the IMS catalog stored in the template.

Panel and field definitions

Figure 45. DBD Library List panel

<u>P</u> rocess	<u>O</u> ptions	<u>H</u> elp
FM/IMS		DBD Library List
DBD Library:		
Data set name	1	'FMN.REGTEST.IMS.DBDLIB'
	2	
	3	
	4	
	5	
	6	
Command ==> _		
F1=Help	F2=Split	F3=Exit
F10=Actions	F12=Cancel	F7=Backward
		F8=Forward
		F9=Swap

FM/IMS displays these fields on the DBD Library List panel:

Data set names

The names of one to six load libraries that contain the database definitions (DBDs) that you want FM/IMS to use.

Parent panels

- [Template Entry panel on page 409](#)
- [Template Specification panel on page 412](#)
- [Template Update Utility panel on page 418](#)

Delete/Define Entry panel

The Delete/Define Entry panel is the first panel in the Delete/Define dialog. It is displayed when you select option 1 (Delete/Define) on the Utility Menu panel.

On this panel, you specify:

- The name of the database whose data sets you want to delete and redefine.
- The ID of the IMS subsystem that the database whose data sets you want to delete and redefine is defined in.
- Whether you want the Delete/Define to obtain the database data set names from the user profile or from the DFSMDA dynamic allocation members.
- Whether or not you want to skip the display of the Database Data Set Specification/Display panel.

Panel and field definitions

Figure 46. Delete/Define Entry panel

<u>P</u> rocess	<u>O</u> ptions	<u>H</u> elp
FM/IMS		
Delete/Define Entry Panel		
IMS:		
Subsystem name . . .	<u>IF52</u>	
Database name . . .	<u>DJ1E</u>	
Processing Options:		
Fetch DB dsnames from		Enter "/" to select option
<u>1</u> 1. User profile		_ Skip DB data set panel
2. DFSMDA members		
Command ==>		
F1=Help	F2=Split	F3=Exit
F9=Swap	F10=Actions	F12=Cancel
	F4=CRetriev	F7=Backward
	F8=Forward	

IMS Subsystem Name

The ID of the IMS subsystem in which the database whose data sets you want to delete/define is defined.

FM/IMS searches the FM/IMS installation options module for the subsystem with the specified name. If you enter either no subsystem name or a subsystem name pattern, the Subsystem Selection panel is displayed.

You can select a subsystem from the list of subsystems displayed on that panel.

IMS Database name

The name of the database whose data sets you want to delete and redefine. When the database you specify is logically related to other databases, the Delete/Define also deletes and redefines the data sets of the logically related databases.

FM/IMS searches either an IMS catalog or DBD libraries for a DBD with the specified name. Which of these two sources is searched depends on whether or not the selected subsystem uses IMS-managed ACBs.

If the selected subsystem uses IMS-managed ACBs, then FM/IMS searches the IMS catalog that the subsystem uses.

Otherwise, FM/IMS searches user- or administrator-specified DBD libraries. The libraries that are searched depend on which subsystem you select, so they are called the DBD libraries for the selected subsystem.

The DBD libraries for the selected subsystem are displayed on the PSB and DBD Data Sets panel and may or may not be fixed by the FM/IMS administrator.

If the DBD libraries for the subsystem are fixed, the DBD Data set name fields on the PSB and DBD Data Sets panel are protected and you must use the DBD libraries that the administrator has specified. Otherwise, these fields are not protected and you are free to modify the list of DBD libraries that FM/IMS searches.

FM/IMS searches the DBD libraries in the order in which they are specified and uses the first DBD it finds with the specified name.

IMS requires these DBDs to be in at least one of the specified DBD libraries:

- The DBD for the database that you specify.
- The DBD for each database that is logically related to the database that you specify.

If you enter either no database name or a database name pattern, the Database Selection panel is displayed. You can select a database from the list of databases displayed on that panel.

Fetch DB dsnames from

If you select a database that is not a HALDB and an IMS subsystem that is not a dynamic allocation only subsystem, specify one of these options:

1. User profile

The Delete/Define deletes and redefines the database data sets whose names were saved in your user profile.

2. DFSMDA members

The Delete/Define deletes and redefines the database data sets specified in the DFSMDA dynamic allocation members.



Note: This field is ignored when you specify either:

- A database that is a HALDB, or
- An IMS subsystem that is defined as dynamic allocation only in the FM/IMS installation option module.

Skip DB data set panel

When selected, FM/IMS does not display the Database Data Set Specification or the Database Data Set Display panel.

Parent panels

- [Utility Menu panel on page 425](#)

Child panels

- [Database Data Set Specification panel on page 236](#)
- [Database Data Set Display panel on page 234](#)
- [JCL Submission panel on page 331](#)

Related topics and examples

- [Deleting and redefining your data sets on page 151](#)

DLI Mode Data Sets 1 panel

The DLI Mode Data Sets 1 panel allows you to view and modify the names of the DFSVSAMP, RESLIB and IMS macros data sets used by the FM/IMS functions when run in DLI mode.

The panel is displayed when option 2 is selected on the Subsystem Settings Menu. The Subsystem field displays the IMS subsystem ID you specified on the Subsystem Settings Menu.

The panel displays the data set names that an online FM/IMS function uses when a DLI region type is selected and this IMS subsystem ID is specified on the function's Entry panel.

The FM/IMS administrator may have fixed the values of some or all of the data set names displayed on the panel.

If a data set has been fixed, the panel field will be protected and you will not be able to change the specified value. If a data set has not been fixed, you can change the value that has been specified for it.

Enter the RESET command, to reset all the data set names on the panel to their subsystem defaults.

Enter the EXIT command (F3), to exit the panel saving the changes you have made.

Enter the CANCEL command (F12), to exit the panel without saving the changes you have made.

Panel and field definitions

Figure 47. DLI Mode Data Sets 1 panel

Process	Options	Help
FM/IMS		DLI Mode Data Sets 1
Subsystem IF52 IMS V13 NT Test		
DFSVSAMP:		
Data set name	. .	'IMSV13.IFB2.PROCLIB'
Member	DFSVMDB
RESLIB:		
Data set name #1		'IMSV1210.IF52.SDFSRESL'
Data set name #2		'IMSV1210.IF52.USERLIB3'
Data set name #3		'IMSV1210.IF52.USERLIB4'
Data set name #4		'IMSV1210.IF52.USERLIB5'
Data set name #5		'IMSV1210.IF52.USERLIB6'
Data set name #6		'IMSV1210.IF52.USERLIB'
IMS Macros:		
Data set name	. .	'IMS.V1210.SDFSMAc'
Command ==>		
F1=Help	F2=Split	F3=Exit
F9=Swap	F10=Actions	F12=Cancel
	F4=CRetrieve	F7=Backward
	F8=Forward	

Subsystem

Displays the IMS subsystem ID you specified on the Subsystem Settings Menu panel.

DFSVSAMP data set name

The name of the data set containing the parameters that define the IMS buffer subpools for OSAM and VSAM data sets. When a File Manager/IMS function is run in DLI mode, the specified data set is allocated to the DFSVSAMP DD.

If the specified data set is partitioned, specify the required member in the DFSVSAMP member field.

DFSVSAMP member

If the DFSVSAMP data set is partitioned, specify the member containing the parameters that define the IMS buffer subpools for OSAM and VSAM data sets. When a File Manager/IMS function is run in DLI mode, the specified member is allocated to the DFSVSAMP DD.

When the DFSVSAMP data set is partitioned, if you enter a pattern or blanks for the member name, a member selection list is displayed. You can select a member from this list.

If the DFSVSAMP data set is sequential, enter blanks for the member name.

RESLIB data sets

The names of the data sets containing the IMS SVC modules, the DFSMDA dynamic allocation members and the IMS exit routines. When a File Manager/IMS function is run in DLI mode, the specified data sets are allocated to the TASKLIB DD and those data sets that are APF authorized are allocated to the DFSRESLB DD.

IMS Macros data set name

The name of the IMS Macro library. FM/IMS functions running in DLI mode use the IMS macros in the specified library when generating a dynamic PSB.

Parent panels

- [Subsystem Settings Menu panel on page 404](#)

Child panels

- None.

DLI Mode Data Sets 2 panel

The DLI Mode Data Sets 2 panel allows you to view and modify the names of the RECON, ACBLIB, and IMS log data sets used by the FM/IMS functions when run in DLI mode.

The panel is displayed when option 3 is selected on the Subsystem Settings Menu. The Subsystem field displays the IMS subsystem ID you specified on the Subsystem Settings Menu.

The panel displays the data set names that an online FM/IMS function uses when a DLI region type is selected and this IMS subsystem ID is specified on the function's Entry panel.

The FM/IMS administrator may have fixed the values of some or all of the data set names displayed on the panel.

If a data set has been fixed, the panel field will be protected and you will not be able to change the specified value. If a data set has not been fixed, you can change the value that has been specified for it.

Enter the RESET command to reset all the data set names on the panel to their subsystem defaults.

Enter the EXIT command (F3), to exit the panel saving the changes you have made.

Enter the CANCEL command (F12), to exit the panel without saving the changes you have made.

Panel and field definitions

Figure 48. DLI Mode Data Sets 2 panel

Process	Options	Help
FM/IMS		DLI Mode Data Sets 2
Subsystem IF52 IMS V13 NT Test		
RECON:		
Primary data set name	.	_____
Secondary data set name	.	_____
Spare data set name	.	_____
ACBLIB:		
Data set name	.	_____ 'IMSV1210.IF52.ACBLIB'
IMS log:		
Data set name pattern	.	_____ &UID..FMNLOG.&YYMMDD..&HHMMSS..&DBNAME.
Command ==>		
F1=Help	F2=Split	F3=Exit
F9=Swap	F10=Actions	F12=Cancel
	F4=CRetrieve	F7=Backward
		F8=Forward

Subsystem

The IMS subsystem ID you specified on the Subsystem Settings Menu.

RECON Primary data set

If you want IMS to dynamically allocate the DBRC RECON data sets, leave this field blank. IMS allocates the RECON data sets specified in the DFSMDA dynamic allocation members when they are required.

If you want FM/IMS to allocate the DBRC RECON data sets, specify the name of the primary DBRC RECON data set that you want IMS to use. FM/IMS functions running in DLI mode allocate the specified data set to the RECON1 DD when it is required.

If you specify a primary RECON data set, you must also specify a secondary and a spare RECON data set.

RECON Secondary

If you want IMS to dynamically allocate the DBRC RECON data sets, leave this field blank. IMS allocates the RECON data sets specified in the DFSMDA dynamic allocation members when they are required.

If you want FM/IMS to allocate the DBRC RECON data sets, specify the name of the secondary DBRC RECON data set that you want IMS to use. FM/IMS functions running in DLI mode allocate the specified data set to the RECON2 DD when it is required.

If you specify a secondary RECON data set, you must also specify a primary and a spare RECON data set.

RECON Spare

If you want IMS to dynamically allocate the DBRC RECON data sets, leave this field blank. IMS allocates the RECON data sets specified in the DFSMDA dynamic allocation members when they are required.

If you want FM/IMS to allocate the DBRC RECON data sets, specify the name of the spare DBRC RECON data set that you want IMS to use. FM/IMS functions running in DLI mode allocate the specified data set to the RECON3 DD when it is required.

If you specify a spare RECON data set, you must also specify a primary and a secondary RECON data set.

ACBLIB Data set name

The staging ACBLIB data set name for the subsystem.

The data set is used by the Initialize function when a Fast Path database is specified. The DBFUMIN0 utility obtains information from the DBD member of the ACBLIB that was generated for the database you are initializing.

IMS log Data set name pattern

The name pattern used by FM/IMS functions to generate IMS log data set names.

The name pattern can consist of up to five qualifiers. For each qualifier, you can specify either the required character string or a symbol. The data set name is generated by replacing the symbols in the name pattern with their run-time values.

For the remainder of this entry, "the function" refers to the function that is to use the IMS log.

The name pattern supports these symbols:

&DBNAME.

The name of the primary database that the function accesses.

&PREFIX.

Either the user's TSO prefix (if the name is being generated in a TSO environment) or the value specified in the TSOPREFIX parameter (otherwise). The value may be null.

&FUNCOD.

The code for the function.

The following are the codes for the functions that may use an IMS log:

IE

Edit

IB

Browse

DIB

Initialize

IXB

Extract

ILB

Load

IPR

Print

IEB

Batch Edit

IBB

Batch Browse

&HHMMSS.

Thhmmss where hhmmss is the time of day that the IMS log data set name is generated expressed in hours (HH), minutes (MM) and seconds (SS).

&SSID.

The name of the IMS subsystem that the function is to access.

&UID.

Either &PREFIX. (if its value is not null) or the User ID (otherwise).

&USER.

User ID

&YYMMDD.

Dyymmdd where yymmdd is the date that the IMS log data set name is generated expressed as a 2-digit year (YY), month (MM) and day (DD).

Parent panels

- [Subsystem Settings Menu panel on page 404](#)

Child panels

- None.

DLI Mode Options panel

The DLI Mode Options panel allows you to view and modify selected options used by the FM/IMS functions when run in DLI mode.

The panel is displayed when option 4 is selected on the Subsystem Settings Menu. The Subsystem field displays the IMS subsystem ID you specified on the Subsystem Settings Menu.

The panel displays the options that an online FM/IMS function uses when a DLI region type is selected and this IMS subsystem ID is specified on the function's Entry panel.

The FM/IMS administrator may have fixed the values of some or all of the options displayed on the panel.

If an option has been fixed, the panel field will be protected and you will not be able to change the specified value. If an option has not been fixed, you can change the value that has been specified for it.

Enter the RESET command, to reset all the options on the panel to their subsystem defaults.

Enter the EXIT command (F3), to exit the panel saving the changes you have made.

Enter the CANCEL command (F12), to exit the panel without saving the changes you have made.

Panel and field definitions

Figure 49. DLI Mode Options panel

```

Process   Options   Help
-----
FM/IMS                      DLI Mode Options

Subsystem IF52  IMS V13 NT Test

Options:
  Enter "/" to select option
  _ Autosave

Checkpoint Frequencies:
  Edit . . . . . 5
  Change All/Repeat All 55
  Load . . . . . 155
  Batch Edit . . . . . 255

PSB Processing Options:
Browse      Extract      Print      Batch Browse
1 1. G      1 1. G      2 1. G      2 1. G
      2. GO      2. GO      2. GO      2. GO

Command ==>
F1=Help    F2=Split    F3=Exit    F4=CRetriev  F7=Backward  F8=Forward
F9=Swap    F10=Actions F12=Cancel
    
```

Subsystem

the IMS subsystem ID specified on the Subsystem Settings menu.

Autosave

Select this option if you want the automatic save function to be set on when you start an Edit session.

Edit Checkpoint Frequency

The number that specifies the frequency of the automatic save function when editing databases.

When Autosave is on, FM/IMS:

- Increments a count by one each time you press an action key and data changes have been requested.
- Issues a checkpoint when the count is equal to the number specified in this field.

The value must be in the range 1 to 99.

Change All/Repeat All Checkpoint Frequency

The number that specifies the frequency of the automatic save function during Change All and Repeat All operations.

When Autosave is on, FM/IMS:

- Increments a count by one each time a segment is updated during a Change All operation or inserted during a Repeat All operation.
- Issues a checkpoint when the count is equal to the number specified in this field.

The value must be in the range 1 to 9,999.

Load Checkpoint Frequency

The number that specifies the frequency of the automatic save function when running a File Manager/IMS Load job.

FM/IMS increments a count by one each time your Load job inserts or replaces a segment and issues a checkpoint when the count is equal to the number specified in this field.

The value must be in the range 1 to 99,999.

Batch Edit Checkpoint Frequency

The number that specifies the frequency of the automatic save function when running a Batch Edit job.

FM/IMS increments a count by one each time your Batch Edit job inserts, deletes or replaces a database segment and issues a checkpoint when the count is equal to the number specified in this field.

The value must be in the range 1 to 99,999.

Browse PSB Processing Option

The PSB Processing Option (PROCOPT) that dynamic PSBs generated for a Browse will use:

1 - PROCOPT=G

The Browse reads with integrity.

2 - PROCOPT=GO

The Browse reads without integrity.

Extract PSB Processing Option

The PSB Processing Option (PROCOPT) that dynamic PSBs generated for an Extract will use:

1 - PROCOPT=G

The Extract reads with integrity.

2 - PROCOPT=GO

The Extract reads without integrity.

Print PSB Processing Option

The PSB Processing Option (PROCOPT) that dynamic PSBs generated for a Print will use:

1 - PROCOPT=G

The Print reads with integrity.

2 - PROCOPT=GO

The Print reads without integrity.

Batch Browse PSB Processing Option

The PSB Processing Option (PROCOPT) that dynamic PSBs generated for a Batch Browse will use:

1 - PROCOPT=G

The Batch Browse reads with integrity.

2 - PROCOPT=GO

The Batch Browse reads without integrity.

Parent panels

- [Subsystem Settings Menu panel on page 404](#)

Child panels

- None.

DLI Mode Parameters panel

The DLI Mode Parameters panel allows you to view and modify the parameters that are passed to the IMS region controller when a File Manager/IMS function is run in DLI mode. It also allows you to view and modify the IMS log usage setting for functions using PSBs that have update intent.

The panel is displayed when option 1 is selected on the Subsystem Settings Menu. The Subsystem field displays the IMS subsystem ID you specified on the Subsystem Settings Menu.

The panel displays the parameters that an online FM/IMS function uses when a DLI region type is selected and this IMS subsystem ID is specified on the function's Entry panel.

The FM/IMS administrator may have fixed the values of some or all of the parameters displayed on the panel.

If a parameter has been fixed, the panel field is protected and you are not able to change the specified value. If a parameter has not been fixed, you can change the value that has been specified for it.

Enter the RESET command to reset all the parameters on the panel to their subsystem defaults.

Enter the EXIT command (F3), to exit the panel saving the changes you have made.

Enter the CANCEL command (F12), to exit the panel without saving the changes you have made.

Panel and field definitions

Figure 50. DLI Mode Parameters panel

Process	Options	Help
FM/IMS	DLI Mode Parameters	
Subsystem IF52 IMS V13 NT Test		
Options:		
DBRC	IRLM	IMS log (if PSB has update intent)
<u>1</u> 1. DBRC=Y	<u>1</u> 1. IRLM=Y	<u>2</u> 1. Keep
2. DBRC=N	2. IRLM=N	2. Keep when updates
3. DBRC=NULL	3. IRLM=NULL	3. Delete
		4. None
Enter "/" to select option		
/ Dynamic backout		
Parameters:		
IRLMNM . . . IRLM	GSGNAME . . . _____	TMINAME . . . _____
BUF _____	LOCKMAX . . . _____	
Command ==>		
F1=Help	F2=Split	F3=Exit
F9=Swap	F10=Actions	F12=Cancel
	F4=CRetrieve	F7=Backward
		F8=Forward

DBRC

Specify whether or not functions use Database Recovery Control (DBRC) when they are run in DLI mode:

1. DBRC=Y

Use DBRC.

2. DBRC=N

Do not use DBRC.

3. DBRC=NULL

DBRC is set according to the DBRC parameter in the installation default module DFSIDEF0.

Functions use DBRC, if the DFSIDEF0 module specifies DBRC=YES or DBRC=FORCE or if the DFSIDEF0 module is not found in the RESLIB data sets for the subsystem. Functions do not use DBRC if the DFSIDEF0 module specifies DBRC=NO.



Note: If this option is set to 2. DBRC=N and the DFSIDEF0 module specifies DBRC=FORCE, then functions terminate abnormally with IMS abend code 0044.

IRLM

Specify whether or not functions use an Internal Resource Lock Manager (IRLM) when they are run in DLI mode:

1. IRLM=Y

Use IRLM.

2. IRLM=N

Do not use IRLM.

3. IRLM=NULL

IRLM is set according to the IRLM and IRLMNM parameters in the IMSCTRL macro statement.

Functions use IRLM, if one of these conditions is true:

- The IMSCTRL macro statement specifies IRLM=Y.
- The IMSCTRL macro statement specifies an IRLMNM and does not specify IRLM=N.

Functions do not use IRLM, if one of these conditions is true:

- The IMSCTRL macro statement specifies IRLM=N.
- The IMSCTRL macro statement does not specify a value for IRLM and IRLMNM.

IMS log

Specify whether or not functions using PSBs that have update intent use an IMS log when they are run in DLI mode and, if they do use a log, whether or not the log is kept when the function ends.

1. Keep

Use an IMS log. Keep the log when the function ends.

2. Keep when updates

Use an IMS log. Keep the log if the function updates databases or does not end normally.

3. Delete

Use an IMS log. Only keep the log if the function does not end normally.

4. None

Do not use an IMS log.



Note: This option cannot be set to 4. None when the DBRC option is set to 1. DBRC=Y because DBRC requires the usage of an IMS log.

Dynamic backout

Select this option if you want:

- IMS to perform a dynamic backout when an IMS pseudo-abend occurs in a function running in DLI mode.
- To use the UNDO or CANCEL command when editing a database in DLI mode.

This option only takes effect if the IMS log option is set to 1. Keep, 2. Keep when updates, or 3. Delete.

IRLMNM

The name of the Internal Resource Lock Manager (IRLM) that the functions are to use. Functions that run in DLI mode pass the name to the IMS region controller when the IRLM option is set to 1. IRLM=Y or 3. IRLM=NULL.

When IRLM is used and you have not specified a name in this field, IMS uses the name specified in the IRLMNM parameter of the IMSCTRL macro, or IRLM, if that parameter is not specified.

GSGNAME

If the subsystem is part of a Remote Site Recovery (RSR) complex and the IMSCTRL macro statement does not specify a GSGNAME and you want any activity performed by the functions running in DLI mode to be tracked by RSR, enter the Global Service Group (GSG) name for the RSR complex.

If the subsystem is part of an RSR complex and the IMSCTRL macro statement specifies a GSGNAME and you don't want the activity of the functions running in DLI mode tracked, enter NONE.

Otherwise, do not specify a value for GSGNAME.

TMINAME

If the IMS subsystem is part of a Remote Site Recovery (RSR) complex and the activity performed by FM/IMS functions running in DLI mode is to be tracked by RSR, specify the Transport Manager Instance (TMI) name that the functions are to use.

When activity is tracked by RSR and you have not specified a name in this field, IMS uses the name specified in the TMINAME parameter of the IMSCTRL macro, or blanks, if that parameter is not specified.

BUF

Specify the number of 1K blocks to be used in calculating the size of the OSAM pool.

The value specified in this field is only used if the DFSVSAMP data set does not include any IOBF control statements.

LOCKMAX

Specify the maximum number of locks (in units of 1000) that a function is allowed to hold at one time.

The number you specify must be in the range 0 to 32767.

If 0 is specified, there is no limit on the number of locks the function can hold at one time.

If you leave the field blank, the LOCKMAX value specified on the PSBGEN statement is used or 0 (no limit), if the LOCKMAX parameter is not specified on the PSBGEN statement.

Parent panels

- [Subsystem Settings Menu panel on page 404](#)

Child panels

- None.

Edit Entry panel

The Edit Entry Panel is the first panel in the Edit dialog. It is displayed when you select option 2 (Edit) on the Primary Option Menu panel.

Panel and field definitions

Figure 51. Edit Entry panel

Process	Options	Help
FM/IMS		
Edit Entry Panel		
IMS:		
Subsystem name . . .	<u>IF52</u>	PSB name . . . <u>LA19D</u> (If static PSB)
Database name . . .	<u>DJ1E</u>	AGN name . . . _____ (If BMP)
View:		
Data set name . . .	_____	
Member	_____	
Processing Options:		
PSB type	Region type	Fetch DB dsnames from (if DLI)
<u>1</u> 1. Dynamic	<u>1</u> 1. DLI	<u>1</u> 1. User profile
2. Static	2. BMP	2. DFSMDA members
View usage		
<u>3</u> 1. New	Enter "/" to select option	
2. Existing	_ Secondary index (if dynamic PSB)	
3. None	_ Create audit trail	
	_ Skip DB data set panel (if DLI)	
Command ==>		
F1=Help	F2=Split	F3=Exit
F9=Swap	F10=Actions	F12=Cancel
	F4=CRetrieval	F7=Backward
		F8=Forward

IMS

Subsystem name

The ID of the IMS subsystem that the database you want to edit is defined in. FM/IMS searches the FM/IMS installation options module for the subsystem with the specified name. If you enter either no subsystem name or a subsystem name pattern, the Subsystem Selection panel is displayed. You can select a subsystem from the list of subsystems displayed on that panel.

PSB name

If you select "Static" for **PSB type**, specify the name of the PSB that you want the Edit to use. The PSB that you specify must have a PCB for the database you want to edit.

FM/IMS searches either an IMS catalog or PSB libraries for a PSB with the specified name. Which of these two sources is searched depends on whether or not the selected subsystem uses IMS-managed ACBs.

If the selected subsystem uses IMS-managed ACBs, then FM/IMS searches the IMS catalog that the subsystem uses.

Otherwise, FM/IMS searches user- or administrator-specified PSB libraries. The libraries that are searched depend on which subsystem you select, so they are called the PSB libraries for the selected subsystem.

The PSB libraries for the selected subsystem are displayed on the PSB and DBD Data Sets panel and may or may not be fixed by the FM/IMS administrator.

If the PSB libraries for the subsystem are fixed, the PSB Data set name fields on the PSB and DBD Data Sets panel are protected and you must use the PSB libraries that the administrator has specified. Otherwise, these fields are not protected and you are free to modify the list of PSB libraries that FM/IMS searches.

FM/IMS searches the PSB libraries in the order in which they are specified and uses the first PSB it finds with the specified name.

If you do not enter a PSB name or if you enter a PSB name pattern, the PSB Selection panel is displayed. You can select a PSB from the list of PSBs displayed on that panel.



Note: If you select "Dynamic" for **PSB type**, this field is ignored.

Database name

The name of the database that you want to edit.

FM/IMS searches either an IMS catalog or DBD libraries for a DBD with the specified name. Which of these two sources is searched depends on whether or not the selected subsystem uses IMS-managed ACBs.

If the selected subsystem uses IMS-managed ACBs, then FM/IMS searches the IMS catalog that the subsystem uses.

Otherwise, FM/IMS searches user- or administrator-specified DBD libraries. The libraries that are searched depend on which subsystem you select, so they are called the DBD libraries for the selected subsystem.

The DBD libraries for the selected subsystem are displayed on the PSB and DBD Data Sets panel and may or may not be fixed by the FM/IMS administrator.

If the DBD libraries for the subsystem are fixed, the DBD Data set name fields on the PSB and DBD Data Sets panel are protected and you must use the DBD libraries that the administrator has specified. Otherwise, these fields are not protected and you are free to modify the list of DBD libraries that FM/IMS searches.

FM/IMS searches the DBD libraries in the order in which they are specified and uses the first DBD it finds with the specified name.

The following applies to when you select "Dynamic" for **PSB type**:

- If you enter either no database name or a database name pattern, the Database Selection panel is displayed. You can select a database from the list of databases displayed on that panel.
- If the selected subsystem does not use IMS-managed ACBs, then IMS requires these DBDs to be in at least one of the specified DBD libraries:
 - The DBD for the database you want to edit.
 - The DBD for each database that is logically related to the database you want to edit.

The following applies to when you select "Static?" for **PSB type**:

- The PCB Selection panel is displayed when any one of these is true:
 - You enter no database name and there is more than one database PCB in the specified PSB.
 - You enter a database name and there is more than one PCB for the database in the PSB.
 - You enter a database name pattern and the PSB has PCBs for databases with names that match the pattern.

You can select a PCB from the list of database PCBs that is displayed on the PCB Selection panel.

- If the subsystem does not use IMS-managed ACBs, then IMS requires these DBDs to be in at least one of the specified DBD libraries:
 - The DBD for each database that is specified in the PSB.
 - The DBD for each database that is logically related to a database specified in the PSB.

AGN name

The Application Group Name (AGN) identifies a group of IMS resources. The name you specify is passed to the IMS region controller when you select BMP for the Region type.

If you select a subsystem that does not use AGNs, no AGN name should be entered.

If you select a subsystem that uses AGNs, specify an AGN that provides you with the access the Edit requires and that you have authority to use. (The BMP region that FM/IMS starts is only authorized to use the IMS resources that are associated with the specified AGN.)

The AGN Selection panel is displayed when all these conditions are true:

- A BMP region type is selected.
- The selected subsystem uses AGNs.

- AGNs for the selected subsystem are listed in the FM/IMS installation options module.
- Either no AGN name is entered or an AGN name pattern is entered and there are AGNs for the selected subsystem in the FM/IMS installation options module that match the pattern.

You can select an AGN from the list of AGNs that is displayed on the AGN Selection panel. If AGNs for the selected subsystem are not listed in the FM/IMS installation options module, you must specify the full name of the AGN.



Note: This field is ignored when you select DLI for the Region type.

View

Data set name

If you select "Existing" for the **View usage**, this is the name of the data set that contains the view that you want the Edit to use.



Note: If you select "New" or "None" for **View usage**, this field is ignored.

Member

If you select "Existing" for **View usage**, then:

- If the view that you want the Edit to use is in a PDS(E), specify the view member name in this field.
- If the view that you want the Edit to use is in a sequential data set, blank out this field.



Note: If you select "New" or "None" for **View usage**, this field is ignored.

PSB type

The type of PSB that the Edit uses to access the database:

1. Dynamic

The Edit uses a temporary PSB that it generates at the start of the dialog.

2. Static

The Edit uses an existing PSB you specify in the PSB name field.

Region type

The type of region that you want the Edit to run in:

1. DLI

For a DL/I batch processing region. You can use a DL/I batch processing region when the database is offline or there is data sharing support.

2. BMP

For a BMP region. You can use a BMP region when the database is online.

Fetch DB dsnames from (if DLI)

If you select "DLI" for **Region type**, a database that is not a HALDB, and an IMS subsystem that is not a dynamic allocation only subsystem:

1. User profile

Edit uses the database data sets whose names are saved in your user profile.

2. DFSMDA members

Edit uses the database data sets specified in the DFSMDA dynamic allocation members.



Note: This field is ignored when you specify any one of these:

- "BMP" for **Region type**.
- A database that is a HALDB.
- An IMS subsystem that is defined as dynamic allocation only in the FM/IMS installation option module.

View usage

Determines whether the Edit uses a new view, an existing view, or no view:

1. New

Select this option when you want Edit to use a new view.

The Edit creates a temporary view from a template for the specified database.

FM/IMS searches user or administrator-specified template libraries for the template. The template libraries that FM/IMS searches depends on which subsystem you select:

- If the template libraries for the specified subsystem are not fixed, FM/IMS searches the template libraries specified on the Template Data Sets panel.
- If the template libraries for the subsystem are fixed, FM/IMS searches the default template libraries for the subsystem (specified in the FM/IMS installation options module).

FM/IMS searches the template libraries in the order in which they are specified and uses the first template it finds with the specified database name.

2. Existing

Select this option when you want Edit to use an existing view. Edit uses the view specified in the View **Data set name** and **Member** fields.

3. None

Select this option when you do not want Edit to use a view.

Secondary index (if dynamic PSB)

Select this option if you have selected "Dynamic" for **PSB type** and you want to access the database by means of a secondary index.

If you select this option and the database has more than one secondary index, the Secondary Index Selection panel is displayed. You can select a secondary index from the list of secondary indexes displayed on that panel.



Note: This field is ignored when you select "Static" for **PSB type**.

Create audit trail

Select this option if you want FM/IMS to create an audit trail of the updates you make to the database during your Edit session.

This option allows you to request an audit trail when one is not required.



Note: The FM/IMS administrator may disable this option for some IMS subsystems or users, so the creation of an audit trail when one is not required may not always be possible.

Skip DB data set panel (if DLI)

Select this option if you do not want FM/IMS to display the Database Data Set Specification or the Database Data Set Display panel.

If this option is not selected and you select "DLI" for **Region type**, the Database Data Set Specification or the Database Data Set Display panel is displayed.



Note: This field is ignored when you select "BMP" for **Region type**.

Parent panels

- [Primary Option menu on page 346](#)

Child panels

- [AGN Selection panel on page 193](#)
- [Data Set Selection panel on page 233](#)
- [Database Data Set Display panel on page 234](#)
- [Database Data Set Specification panel on page 236](#)
- [PCB Selection panel on page 343](#)
- [PSB Selection panel on page 361](#)

- [Secondary Index Selection panel on page 367](#)
- [Subsystem Selection panel on page 401](#)
- [Database Selection panel on page 242](#)
- [View Member Selection panel on page 428](#)
- [Database Positioning panel on page 239](#)

Editor Options panel

Panel and field definitions

The Editor Options panel is displayed when you select option 5 from the Settings Menu.

The panel allows you to view and modify selected options used by the Edit and Browse functions.



Note: When you are editing or browsing data, you can use primary commands to change the settings of the Editor options. But these changed settings only remain in effect until the end of the Edit or Browse dialog. When you start a new Edit or Browse dialog, the settings you specified on this panel come into effect again.

Figure 52. Editor Options panel

```

Process  Options  Help
-----
FM/IMS                                     Editor Options

Initial Settings:
  Enter "/" to select option
  - Translate changed data to uppercase (CAPS ON)
  - Expose suppressed records (SHOW SUP ON)
  - Limit scope to current database record (SCOPE REC)
  - Show field reference numbers on SNGL displays (REF)
  - Show field picture clauses on SNGL displays (PIC)
  - Show record structure on SNGL displays (STR)
  / Show redefined fields on SNGL and TABL displays (RDF)
  - Show field type & length on SNGL displays (TYPE)
  - Show field start locations on SNGL displays (SLOC)
  / Show the CCSID associated with the field on SNGL displays (CCSID)
  - Left justify numerics on SNGL displays (JUST)
  - Prompt to save view when exiting edit/browse session
  / Use * (any segment type) as default on NEXT and PREVIOUS commands

Format
  1. Previous
  2. TABL
  3. SNGL
  4. CHAR
  5. HEX
  6. LHEX

Command ==>>
F1=Help      F2=Split    F3=Exit     F4=CRetriev  F7=Backward  F8=Forward
F9=Swap      F10=Actions F12=Cancel
    
```

Translate changed data to uppercase (CAPS ON)

Select to translate data entered into input fields into uppercase. Do not select this option if you want to enter lowercase or mixed-case data. Also affects the processing of CHANGE arguments.

Expose suppressed records (SHOW SUP ON)

Select to expose or show suppressed records. Selecting this option has the same effect as if the SHOW SUP ON command has been entered. If a SHOW command is entered during a File Manager session, it resets this option for the session.

Limit scope to current database record (SCOPE REC)

If selected, File Manager halts at the end of a database record when displaying segments. A notification panel is displayed before crossing database records when using the navigation commands NEXT and TWIN. The scope of the PREVIOUS command is limited to the beginning of the current database record. With SCOPE DB, File Manager presents segments from all database records (provided they meet any view criteria, if used).

Show field reference numbers on SNGL displays (REF)

Select to show the field reference numbers when using SNGL display or print format. If this option is not selected, the field reference numbers are not shown. The display of this field can also be set in the editor dialog by means of the REF command.

Show field picture clauses on SNGL displays (PIC)

Select when using SNGL display format to show the picture clause when using a template generated from a COBOL copybook and, for a template generated from a PL/I copybook, show the length and scale (if non-zero) for binary and packed fields. Also show the bit length for bit fields. If this option is not selected, the picture clause is not shown. The display of this clause can also be set in the editor dialog by means of the PIC command.

Show record structure on SNGL displays (STR)

Select to show the full structure of the template when using SNGL display or print format. If this option is not selected, full structure is not shown. The display of these fields can also be set in the editor dialog by means of the STR command.

Show redefined fields on SNGL and TABL displays (RDF)

Select to show any redefined fields when using SNGL or TABL display or print format. If this option is not selected, redefined fields are not shown unless the field has been specifically selected in the template. The display of these fields can also be set in the editor dialog by means of the RDF command.

Show field type & length on SNGL displays (TYPE)

Select to show the type and length values when using SNGL display or print format. If this option is not selected, the field type and length are not shown. The display of these fields can also be set in the editor dialog by means of the TYPE command.

Show field start locations on SNGL displays (SLOC)

Select to show the start location of each field when using SNGL display or print format. If this option is not selected, the start location of each field is not shown. The display of the start location can also be set in the editor dialog by means of the SLOC command.

Show the CCSID associated with fields on SNGL displays (CCSID)

Select to show the CCSID, if one has been assigned when using SNGL display or print format. If this option is not selected the CCSID column is not displayed. The display of these fields can also be set in the editor dialog by means of the CCSID command.

Left justify numerics on SNGL displays (JUST)

Select to left-justify numeric fields when using SNGL display or print format. If this option is not selected, numeric fields are displayed right-justified. The display justification of numeric fields can also be set in the editor dialog by means of the JUST command.

Prompt to save view when exiting edit/browse session

Select to issue a prompt for saving the view. If you select this option and you have selected options 1 or 2 for the View usage processing option, and the View was altered, the View Save panel is displayed to allow you to save your view when exiting the browse or edit session.

Use * (any segment type) as default on NEXT and PREVIOUS commands

When selected, allows the * parameter to be the default action for the NEXT and PREVIOUS navigation commands. When set on, or used on the commands, they will navigate to the next (or previous) available segment regardless of segment or layout type. When this option is not used, the current setting of the SHOW SUP value controls the operation of the NEXT and PREVIOUS commands.

Format

Sets the initial display format for a Browse or Edit session:

1. Previous

Use same format as specified in the previous Browse or Edit session. This is default.

2. TABL

TABL display format. For data that has not been formatted with a template, the IMS data panel is displayed in CHAR display format.

3. SNGL

SNGL display format. For data that has not been formatted with a template, the IMS data panel is displayed in CHAR display format.

4. CHAR

CHAR display format.

5. HEX

HEX display format.

6. LHEX

LHEX display format.

Parent panels

- [Settings Menu panel on page 397](#)

Child panels

- None.

Related topics and examples

- [Setting the initial display format on page 62](#)
- [Selecting a display format on page 61](#)
- [CAPS primary command on page 437](#)
- [JUST primary command on page 471](#)
- [NEXT primary command on page 479](#)
- [PIC primary command on page 483](#)
- [PREVIOUS primary command on page 483](#)
- [RDF primary command on page 485](#)
- [REFS primary command on page 486](#)
- [SCOPE primary command on page 492](#)
- [SHOW \(REC\) primary command on page 495](#)
- [SLOC primary command on page 495](#)
- [STR primary command on page 500](#)
- [TYPE primary command on page 502](#)

Extract Entry panel

The Extract Entry Panel is the first panel in the Extract dialog. It is displayed when you select option 3 (Extract) on the Utility Menu panel.

Panel and field definitions

Figure 53. Extract Entry panel

<u>P</u> rocess	<u>O</u> ptions	<u>H</u> elp
FM/IMS		
Extract Entry Panel		
IMS:		
Subsystem name . . .	<u>I</u> F52	PSB name . . . <u>L</u> A19D (If static PSB)
Database name . . .	<u>D</u> J1E	AGN name . . . _____ (If BMP)
Criteria:		
Data set name . . .	<u>'</u> FMN.REGTEST.IMS.CRITERIA' <u>'</u>	
Member	_____	
Processing Options:		
PSB type	Region type	Fetch DB dsnames from (if DLI)
<u>1</u> 1. Dynamic	<u>1</u> 1. DLI	<u>1</u> 1. User profile
2. Static	2. BMP	2. DFSMDA members
Criteria usage	Enter "/" to select option	
<u>2</u> 1. New	<u>-</u> Use key values	<u>/</u> Create extract template
2. Existing	<u>-</u> Edit criteria	<u>-</u> Skip DB data set panel (if DLI)
3. None	<u>-</u> Scramble	<u>-</u> SDEP in timestamp order
Command ==>		
F1=Help	F2=Split	F3=Exit
F9=Swap	F10=Actions	F12=Cancel
	F4=CRetriev	F7=Backward
		F8=Forward

IMS

Subsystem name

The ID of the IMS subsystem that the databases you want to extract data from are defined in. FM/IMS searches the FM/IMS installation options module for the subsystem with the specified name. If you enter either no subsystem name or a subsystem name pattern, the Subsystem Selection panel is displayed. You can select a subsystem from the list of subsystems displayed on that panel.

PSB name

If you select "Static" for **PSB type**, specify the name of the PSB that you want the Extract to use.

The PSB that you specify must have a PCB for the primary database of the Extract.

If you want your Extract to chase logical relationships, the PSB must also have a PCB for each database that is logically related to the primary database.

FM/IMS searches either an IMS catalog or PSB libraries for a PSB with the specified name. Which of these two sources is searched depends on whether or not the selected subsystem uses IMS-managed ACBs.

If the selected subsystem uses IMS-managed ACBs, then FM/IMS searches the IMS catalog that the subsystem uses.

Otherwise, FM/IMS searches user- or administrator-specified PSB libraries. The libraries that are searched depend on which subsystem you select, so they are called the PSB libraries for the selected subsystem.

The PSB libraries for the selected subsystem are displayed on the PSB and DBD Data Sets panel and may or may not be fixed by the FM/IMS administrator.

If the PSB libraries for the subsystem are fixed, the PSB Data set name fields on the PSB and DBD Data Sets panel are protected and you must use the PSB libraries that the administrator has specified. Otherwise, these fields are not protected and you are free to modify the list of PSB libraries that FM/IMS searches.

FM/IMS searches the PSB libraries in the order in which they are specified and uses the first PSB it finds with the specified name.

If you do not enter a PSB name or if you enter a PSB name pattern, the PSB Selection panel is displayed. You can select a PSB from the list of PSBs displayed on that panel.



Note: If you select "Dynamic" for **PSB type**, this field is ignored.

Database name

The name of the primary database of the Extract.

FM/IMS searches either an IMS catalog or DBD libraries for a DBD with the specified name. Which of these two sources is searched depends on whether or not the selected subsystem uses IMS-managed ACBs.

If the selected subsystem uses IMS-managed ACBs, then FM/IMS searches the IMS catalog that the subsystem uses.

Otherwise, FM/IMS searches user- or administrator-specified DBD libraries. The libraries that are searched depend on which subsystem you select, so they are called the DBD libraries for the selected subsystem.

The DBD libraries for the selected subsystem are displayed on the PSB and DBD Data Sets panel and may or may not be fixed by the FM/IMS administrator.

If the DBD libraries for the subsystem are fixed, the DBD Data set name fields on the PSB and DBD Data Sets panel are protected and you must use the DBD libraries that the administrator has specified. Otherwise, these fields are not protected and you are free to modify the list of DBD libraries that FM/IMS searches.

FM/IMS searches the DBD libraries in the order in which they are specified and uses the first DBD it finds with the specified name.

The following applies to when you select "Dynamic?" for **PSB type**:

- If you enter either no database name or a database name pattern, the Database Selection panel is displayed. You can select a database from the list of databases displayed on that panel.
- If the selected subsystem does not use IMS-managed ACBs, then IMS requires these DBDs to be in at least one of the specified DBD libraries:
 - The DBD for the primary database of the Extract .
 - The DBD for each database that is logically related to the primary database of the Extract.

The following applies to when you select "Static?" for **PSB type**:

- The PCB Selection panel is displayed when any one of these is true:
 - You enter no database name and there is more than one database PCB in the specified PSB.
 - You enter a database name and there is more than one PCB for the database in the PSB.
 - You enter a database name pattern and the PSB has PCBs for databases with names that match the pattern.

You can select a PCB from the list of database PCBs that is displayed on the PCB Selection panel.

- If the subsystem does not use IMS-managed ACBs, then IMS requires these DBDs to be in at least one of the specified DBD libraries:
 - The DBD for each database that is specified in the PSB.
 - The DBD for each database that is logically related to a database specified in the PSB.

AGN name

The Application Group Name (AGN) identifies a group of IMS resources. The name you specify is passed to the IMS region controller when you select BMP for the Region type.

If you select a subsystem that does not use AGNs, no AGN name should be entered.

If you select a subsystem that uses AGNs, specify an AGN that provides you with the access the Edit requires and that you have authority to use. (The BMP region that FM/IMS starts is only authorized to use the IMS resources that are associated with the specified AGN.)

The AGN Selection panel is displayed when all these conditions are true:

- A BMP region type is selected.
- The selected subsystem uses AGNs.
- AGNs for the selected subsystem are listed in the FM/IMS installation options module.
- Either no AGN name is entered or an AGN name pattern is entered and there are AGNs for the selected subsystem in the FM/IMS installation options module that match the pattern.

You can select an AGN from the list of AGNs that is displayed on the AGN Selection panel. If AGNs for the selected subsystem are not listed in the FM/IMS installation options module, you must specify the full name of the AGN.



Note: This field is ignored when you select DLI for the Region type.

Criteria

Data set name

If you select "Existing" for the **Criteria usage**, this is the name of the data set that contains the criteria that you want the Extract to use.



Note: If you select "New" or "None" for **Criteria usage**, this field is ignored.

Member

If you select "Existing" for **Criteria usage**, then:

- If the criteria that you want the Extract to use are in a PDS(E), specify the criteria member name in this field.
- If the criteria that you want the Edit to use are in a sequential data set, blank out this field.



Note: If you select "New" or "None" for **Criteria usage**, this field is ignored.

PSB type

The type of PSB that the Extract uses to access the databases:

1. Dynamic

The Extract uses a temporary PSB that it generates at the start of the batch job.

2. Static

The Extract uses an existing PSB you specify in the PSB name field.

Region type

The type of region that you want the Extract to run in:

1. DLI

For a DL/I batch processing region. You can use a DL/I batch processing region when the database is offline or there is data sharing support.

2. BMP

For a BMP region. You can use a BMP region when the database is online.

Fetch DB dsnames from (if DLI)

If you select "DLI" for **Region type**, a database that is not a HALDB, and an IMS subsystem that is not a dynamic allocation only subsystem:

1. User profile

Extract uses the database data sets whose names are saved in your user profile.

2. DFSMDA members

Extract uses the database data sets specified in the DFSMDA dynamic allocation members.



Note: This field is ignored when you specify any one of these:



- "BMP" for **Region type**.
- A database that is a HALDB.
- An IMS subsystem that is defined as dynamic allocation only in the FM/IMS installation option module.

Criteria usage

Determines whether the Extract uses a new criteria, existing criteria, or no criteria:

1. New

Select this option when you want Extract to use new criteria.

The Extract creates a temporary criteria set from a template for the specified database.

FM/IMS searches user or administrator-specified template libraries for the template. The template libraries that FM/IMS searches depends on which subsystem you select:

- If the template libraries for the specified subsystem are not fixed, FM/IMS searches the template libraries specified on the Template Data Sets panel.
- If the template libraries for the subsystem are fixed, FM/IMS searches the default template libraries for the subsystem (specified in the FM/IMS installation options module).

FM/IMS searches the template libraries in the order in which they are specified and uses the first template it finds with the specified database name.

FM/IMS starts the Criteria dialog where you can edit and save the temporary criteria set.

2. Existing

Select this option when you want Extract to use existing criteria. Extract uses the criteria set specified in the Criteria **Data set name** and **Member** fields.

3. None

Select this option when you do not want Extract to use criteria.

Use key values

Select this option if you want to specify the key values of the root segments of the records that are to be extracted.

If you select this option, the Extract Options panel is displayed. You specify the name of the data set that contains the key values that you want the Extract to use on that panel.

Edit criteria

Select this option if you have selected "Existing" for **Criteria usage** and you want to edit the criteria before you use them.

If you select this option, FM/IMS starts the Criteria dialog where you can edit and save the criteria specified in the Criteria **Data set name** and **Member** fields.



Note: This field is ignored when you select "New" or "None" for **Criteria usage**.

Create extract template

Select this option if you want either the Extract dialog or your Extract job to create a template for the Extract file. You can use this template to edit or view the records in the Extract file.

If you select this option, the Extract Options panel is displayed. You specify the name of the output Extract template data set and Extract template processing options on that panel.

Skip DB data set panel (if DLI)

Select this option if you do not want FM/IMS to display the Database Data Set Specification panel or the Database Data Set Display panel.

If this option is not selected and you select "DLI" for **Region type**, the Database Data Set Specification panel or the Database Data Set Display panel is displayed.



Note: This field is ignored when you select BMP for the Region type.

Scramble

Select this option to apply scrambling options that are defined in the associated template to the extracted data.

SDEP in timestamp order

Select this option if you are extracting data from a DEDB with Sequentially Dependent (SDEP) segments, the extracted SDEP segments are to be loaded into a database, and there is a requirement for the loaded SDEP segments to be in timestamp order.

If this option is not selected, all of the sequential dependents of a root segment are physically loaded together in the reverse sequence they were extracted.

When using DL/I calls to read SDEP segments, the sequence of the SDEP segments in the loaded database appear to be the same as their sequence in the database you extracted them from. However, when the DEDB is processed using the Sequential Dependent Scan Utility, you will find the SDEP segments are in a different sequence.



Note:



1. If you select this option, elapsed time and I/O for the Extract will be greater.
2. This field is ignored when the specified database does not have SDEP segments.

Parent panels

- [Utility Menu panel on page 425](#)

Child panels

- [AGN Selection panel on page 193](#)
- [Extract Options panel on page 282](#)
- [Database Data Set Display panel on page 234](#)
- [Database Data Set Specification panel on page 236](#)
- [PCB Selection panel on page 343](#)
- [PSB Selection panel on page 361](#)
- [Subsystem Selection panel on page 401](#)
- [Criteria Member Selection panel on page 224](#)
- [Database Selection panel on page 242](#)
- [Data Set Selection panel on page 233](#)
- [Extract : To Data Set Specification panel on page 285](#)

Extract Options panel

The Extract Options panel is displayed in the Extract dialog when either the **Use key values** or the **Create extract template** option is selected on the Extract Entry Panel.

On this panel, you specify:

- Whether or not you want to specify the key values of the root segments of the records that are to be extracted.
- When you are specifying key values, the name of the data set that contains the key values that you want the Extract to use.
- Whether or not you want a template for the Extract file.
- When you want a template for the Extract file:
 - Whether you want it to be created by the Extract dialog or your Extract job.
 - The data set in which you want the template stored.
- When you want the Extract dialog to create the template, whether you want to edit the template after it is created.

Panel and field definitions

Figure 54. Extract Options panel

Process	Options	Help
FM/IMS		
Extract Options		
Database DJ1E		
Key Values:		
Data set name . . .	_____	
Member	_____	
Extract Template:		
Data set name . . .	'JHELVON.TEMPLATE'	
Member	A05DEX	
Processing Options:		
Template create execution mode	Enter "/" to select option	
<u>1</u> 1. Foreground	Use key values	
2. Batch	<u>1</u> Edit extract template	
3. Skip		
Command ==> _____		
F1=Help	F2=Split	F3=Exit
F9=Swap	F10=Actions	F12=Cancel
F4=CRetriev	F7=Backward	F8=Forward

Key Values

Data set name

If you have selected the **Use key values** option, specify the name of the data set that contains the key values of the root segments of the records that you want extracted.



Note: This field is ignored when the **Use key values** option is not selected.

Member

If you have selected the **Use key values** option and the key values that you want the Extract to use are in a PDS(E), specify the Key Values member name. If you have selected the **Use key values** option and the key values that you want the Extract to use are in a sequential data set, blank out this field.



Note: This field is ignored when the **Use key values** option is not selected.

Extract Template

Data set name

If you have selected "Foreground" or "Batch" for **Template create execution mode**, specify the name of the data set in which you want the Extract template stored.



Note: This field is ignored when you select "Skip" for **Template create execution mode**.

Member

If you have selected "Foreground" or "Batch" for **Template create execution mode** and the Extract template data set that you specified is a PDS(E), specify the Extract template member.

If you select "Foreground" or "Batch" for **Template create execution mode** and the Extract template data set that you specified is a sequential data set, blank out this field.



Note: This field is ignored when you select "Skip" for the **Template create execution mode**.

Template create execution mode

1. Foreground

FM/IMS creates the template when you press Enter.

2. Batch

The extract job creates the Extract template. FM/IMS generates the keywords that your Extract job requires to create the Extract template.

3. Skip

Extract template is not created.

Use key values

If you select this option, the Extract uses the key values specified in the Key Values **data set name** and **Member** fields.

Edit extract template

Select this option if you have selected "Foreground" for **Template create execution mode** and you want to edit the Extract template.

FM/IMS displays the Record Type Selection panel where you can edit and then save the template.



Note: This field is ignored when you select "Batch" or "Skip" for **Template create execution mode**.

Parent panels

- [Extract Entry panel on page 275](#)
- [Database Data Set Specification panel on page 236](#)
- [Database Data Set Display panel on page 234](#)

Child panels

- [Extract : To Data Set Specification panel on page 285](#)

Extract : To Data Set Specification panel

The Extract : To Data Set Specification panel is displayed in the Extract dialog. You use it to specify the name of the data set that you want to save the extracted data in.

Panel and field definitions

Figure 55. Extract : To Data Set Specification panel

<u>P</u> rocess	<u>O</u> ptions	<u>H</u> elp
FM/IMS		Extract : To Data Set Specification
Extract to:		
Data set name . . .	'FMNUSER.EXTRACT.DJ1E'	
Disposition	NEW	(NEW or OLD)
Volume serial		(If not cataloged)
Device type	3390	(Generic unit or device address)
Allocation parameters (if disposition is NEW):		
Management class . .		(Blank for default management class)
Storage class		(Blank for default storage class)
Data class		(Blank for default data class)
Space units	CYL	(BLK, TRK, CYL, KB or MB)
Primary quantity . .	5	(in above units)
Secondary quantity .	1	(in above units)
Command ==>		
F1=Help	F2=Split	F3=Exit
F9=Swap	F10=Actions	F12=Cancel
	F4=CRetriev	F7=Backward
		F8=Forward

Extract to:

This area identifies the data set in which you want to store your extract data. This can be a new data set or it can already exist.

Data set name

The name of the data set that you want to store your extract data in.

Disposition

NEW

To allocate a new **Extract to** data set.

OLD

To allocate an existing **Extract to** data set with a disposition of OLD.

Volume serial

If the **Extract to** data set:

- exists and it is not cataloged, then enter the volume serial on which it resides.
- is to be created (disposition NEW) and you want it to reside on a specific volume, then specify the volume.

Device type

The generic unit on which you want the data set to reside.

If the disposition of the **Extract to** data set is NEW, then specify the following allocation parameters:

Allocation parameters (if disposition is NEW):

Management class

The management class that should be used to obtain the data management related information (migration, backup, and retention criteria) for the allocation of the data set.

If you want a non-SMS data set to be allocated, and you have not specified a management class in option 0.9 *"Output Data Set Allocation"*, then leave this field blank.

Storage class

The storage class that should be used to obtain the storage related information for the allocation of the data set.

If you want a non-SMS data set to be allocated, and you have not specified a management class in option 0.9 *"Output Data Set Allocation"*, then leave this field blank.

Data class

The data class that should be used to obtain the data related information (such as SPACE or LRECL) for the allocation of the data set.

If you want a non-SMS data set to be allocated, and you have not specified a management class in option 0.9 *"Output Data Set Allocation"*, then leave this field blank.

Space units

The units that the **Primary quantity** and the **Secondary quantity** are expressed in:

BLK

Blocks

TRK

Tracks

CYL

Cylinders

KB

Kilobytes

MB

Megabytes

Primary quantity

The primary allocation quantity, in the **Space units** previously specified.

Secondary quantity

The secondary allocation quantity, in the **Space units** previously specified.



Note: If no values are specified on the panel for SMS classes or Space parameters, then the Default SMS classes are used. If the Default SMS classes have not been set-up, you receive a JCL error upon submitting the extract JCL.

Parent panels

- [Database Data Set Display panel on page 234](#)
- [Database Data Set Specification panel on page 236](#)
- [Extract Entry panel on page 275](#)
- [Extract Options panel on page 282](#)

Child panels

- [JCL Submission panel on page 331](#)

Field Attributes panel - alphanumeric fields

This panel lists a field's formatting and data create attributes. You can modify the width of a field for TABL formatting, leading zero suppression for numeric fields. You can also specify data create attributes. The panel comes in two flavors, one for alphanumeric fields and one for numeric fields; this section describes the alphanumeric field version.

Panel and field definitions

Figure 56. Field Attributes panel - alphanumeric fields

Process	Options	Help
FM/IMS	Field Attributes	
Fixed Attributes:		
Field name	CONTRACTOR	
Type	AN	
Start	7	
Length	40	
Use Attributes:		
Heading	_____	
Output width	_____	
CCSID	_____	+
Create Attributes:		
Filler	_____	
Action	__	
Start character	__	
Pattern	_____	
Repeat user pattern	_____	YES or NO
Scrambling Options:		
Scramble Type	Enter "/" to select option	
1. Random	Value	Column In _____ Out _____
2. Repeatable Dsn	_____	
3. Translate	_____	
4. Exit	Col	Command _____
5. ODPP	1	_____ +
Command ==>		
F1=Help	F2=Split	F3=Exit F4=CRetriev F7=Backward F8=Forward
F9=Swap	F10=Actions	F12=Cancel

When the selected field is alphanumeric, the fields on the Field Attributes panel are:

Fixed attributes

Shows the fixed attributes of the field, such as field name, type, and length, and the starting position, relative to zero, of the field within the record.

These attributes are determined by copybook definitions or by the user-defined attributes in a dynamic template.

Use attributes

Used to specify certain display (or print) attributes used by edit, view, and print functions. For alphanumeric fields, the available use attributes are:

Output width

Number of character positions used by edit, view, compare and print functions to show this field in TABL display or print format. For alphanumeric fields, this value can range from 6 to either 30 or the field width + 10 (whichever is the greater).

The default output width is the maximum of the number of characters needed to show the field heading (or field name, if no heading is specified), and the number of characters needed to show the value of the field.

Heading

The alternate heading that replaces the field name on displays and reports.

CCSID

Specifies the CCSID to be associated with this field.

Length Field

Only shows for a segmented template and alphanumeric fields whose length does not exceed 4.

Each layout can have one field flagged as a length field. This tells File Manager to calculate the segment length based upon the value contained in the field.

You can enter one of the following values:

blank

This is not a length field.

1

The field value is the segment length.

2

The field value, plus the length of the field, is the segment length.

If a length field is not provided, the segment length is taken to be the 01 field length.

Create attributes

These define the field-specific attributes used by the data create functions when creating test data for records containing this field.

Filler

Specifies a value that is to be placed in each byte of the field before any other operation in the construction of the field. Can be one of:

char

A character such as 0 to be written in each byte.

X'cc'

A hexadecimal value, such as X'FF' to be written in each byte.

Default value is blank.

Action

Specifies how the contents of the field are to be varied for each record. Can be one of:

FX

The contents of the field are to remain fixed.

RA

The contents of the field are to be generated from characters selected at random from the specified pattern. A different set of characters is selected for each record.

RO

The contents of the field are to be rolled. The pattern you specify is shifted left one byte for each record until the first non-blank character of the pattern is in the first byte of the field. Then, the pattern is shifted right one byte for each output record until it returns to its original position in the field. RO can only be used with a user-supplied pattern, not with an IBM@-supplied pattern.

The pattern must start with a blank, or the result is the same as FX. The roll only occurs within the length of the pattern.

RP

The contents of the field are to be rippled. The pattern you specify is shifted left one byte for each record and the truncated character is appended to the right hand end of the pattern.

SL

The contents of the field are to be shifted left for each record. The pattern you specify is shifted left one character and filled to the right with a space. When all characters in the pattern have been shifted out, the original pattern is restored and the process is repeated.

SR

The contents of the field are to be shifted right for each record. The pattern you specify is shifted right one character and filled to the left with a space. When all characters in the pattern have been shifted out, the original pattern is restored and the process is repeated.

TL

The contents of the field are to be truncated on the left for each record. The pattern you specify is left truncated (the leftmost character replaced with a space) one character at a time until all characters in the pattern have been truncated. Then, the original pattern is restored and the process is repeated.

TR

The contents of the field are to be truncated on the right for each record. The pattern you specify is right truncated (the rightmost character replaced with a space) one character at a time until all characters in the pattern have been truncated. Then, the original pattern is restored and the process is repeated.

WV

The contents of the field are to be waved. The pattern you specify is shifted left one byte for each record until the first non-blank character of the pattern is in the first byte of the field. Then, the original pattern is restored and the process repeated. WV can only be used with a user-supplied pattern, not with an IBM®-supplied pattern.

The pattern must start with a blank, or the result is the same as FX. The roll only occurs within the length of the pattern.

Start character

Sets the starting character to be used when you specify an IBM®-supplied pattern (AL, AN, or CO) or a user-supplied pattern (with the exception of RO, WV, and FX). The specified character must be one of the characters in the IBM®-supplied pattern or user-supplied pattern.

Default: First character in IBM®-supplied pattern or user-supplied pattern.

Pattern

Specifies the pattern to be used when generating data for this field. You can specify either an IBM®-supplied pattern indicator or a user-supplied pattern. The user-supplied pattern can be either a character string or a hexadecimal string. A character string must be enclosed in quotation marks, while a hexadecimal string must be enclosed in quotation marks and be preceded by a X. The hexadecimal string must contain an even number of valid hexadecimal characters. The IBM®-supplied patterns you can specify are:

AL

Alphabetic - characters A-Z, inclusive.

AN

Alphanumeric - characters A-Z, 0-9 inclusive.

AX

Alphanumeric displayed in long hexadecimal.

CO

Collating sequence - all printable characters in the range X'40' - X'F9'.

If you provide a user-supplied pattern that is longer than the field, for actions other than RA and RP the pattern is first truncated on the right to fit the receiving field before the specified action is performed. For the RA action, characters are randomly selected from the entire user-supplied pattern. For the RP action, the entire pattern is rippled for each record before it is truncated to fit the receiving field. If you provide a user-supplied pattern that is shorter than the field, you can specify that you want the pattern to be repeated to fill the field.

Default: None

Repeat user pattern

Specify YES if you have provided a user-supplied pattern that is shorter than this field and you want the pattern to be repeated as many times as necessary to fill the field. By default, File Manager uses the fill character to pad the receiving field when the user-supplied pattern is shorter than the field. This option has no effect when the RA action is specified.



Note: IBM®-supplied patterns are always repeated in a field, as necessary.

Default: NO

Scrambling Options

These options control field scrambling used during a copy function to produce test data.

Scramble Type

Specify one of the following values:

Blank

No scrambling is performed. Value or range specifications are saved but ignored for the associated function.

1 (Random)

Performs random scrambling. The same input value produces different output values on subsequent invocations.

2 (Repeatable)

Performs repeatable scrambling. The same input value produces the same output value on subsequent invocations.

3 (Translate)

Performs translation. The value data set is searched to find a matching input value. If a match is found, then the output value is taken from the output column of the matching record.

4 (Exit)

Invokes a scrambling user exit. File Manager displays a panel where you can specify the user exit name and user exit parameters and options.

5 (ODPP)

Performs data scrambling by using the ODPP command that is specified in the adjacent command field. This is the Optim Data Privacy Provider command input area. The **Col** field is the left column position, which can be used to position to the error column when a syntax error occurs. Refer to the ODPP Syntax Guide for the command syntax. The ODPP **Command** is a scrollable field. Use the F10 and F11 keys to scroll left and right. Use the F4 key to expand the command into a separate

window. This option is only available if File Manager was customized to access ODP, and the environment is successfully initialized. For more information, see the *File Manager Customization Guide*.

Value

Select this option to provide values for the output field. The associated fields (**Column In**, **Out** and **Dsn**), in conjunction with the **Scramble Type**, determine the output value.

Column In

Defines the start location of the input field value on the value data set, and is used when the translate process is run during a copy operation to match the input field with a value on the value data set. The length of the field is set to the length of the input field that is mapped to this field during the copy process.



Note: This value is only required when you select the scramble type, **Translate**.

(Column) Out

Defines the start location of the output field value on the value data set, and is used as follows during a copy operation:

- For scramble type, **Translate**: If an input field value is matched on the value data set, then the corresponding output value is used.
- For scramble types, **Random** or **Repeatable**: The input value is used to randomly or repeatably select an output value from the value data set.

The length of the field is the current field length as displayed on this panel.



Note: This value is required when you select the scramble type, **Translate**. If you select **Random** or **Repeatable**, and also select **Value**, then the start location defaults to 1 if a value data set name (**Dsn**) has been provided.

Dsn

Defines the value data set. It can be any catalogued sequential, partitioned or VSAM data set containing data that is used to determine the output field value during a copy process.

When specifying the data set name, the following rules apply:

- In a generic data set name, use the percent sign (%) to represent a single character, and an asterisk (*) to represent any number of characters within one qualifier. Two asterisks (**) represent any number of characters within any number of qualifiers.
- The TSO prefix (as defined for your user ID) is used as the high-level qualifier for any name that is not enclosed in quotation marks.

- For performance reasons, you should qualify the data set name as much as you can.
- If the data set is partitioned, then you can provide a member name in the form *dsn(member)*. If you do not provide a member name, or you provide a generic member name, then a member selection list is displayed for you to select a member.

Parent panels

Child panels

Field Attributes panel - numeric field

This panel lists a field's formatting and data create attributes. You can modify the width of a field for TABL formatting, leading zero suppression for numeric fields. You can also specify data create attributes. The panel comes in two flavors, one for alphanumeric fields and one for numeric fields; this section describes the numeric field version.

Panel and field definitions

Figure 57. Field Attributes panel - numeric field

<u>P</u> rocess	<u>O</u> ptions	<u>H</u> elp
FM/IMS	Field Attributes	
Fixed Attributes:		
Field name	SERIAL-NO	
Type	ZD	
Start	47	
Length	6	
Use Attributes:		
Heading	_____	
Output width	_____	
Leading zeros	<u>NO</u>	YES or NO
Create Attributes:		
Start value	_____	
End value	_____	
Increment	_____	
Cycle	_____	
Scrambling Options:		
Scramble Type	Values	
1. Random	1. Range	Min _____ Max _____
2. Repeatable	2. Value	Column In _____ Out _____
3. Translate	Dsn	_____
4. Exit	Col	Command _____
5. ODPP	1	_____ +
Command ==> -----		
F1=Help	F2=Split	F3=Exit F4=CRetrieval F7=Backward F8=Forward
F9=Swap	F10=Actions	F12=Cancel

When the selected field is numeric, some fields differ to those displayed when the selected field is alphanumeric. Where the fields are different, the following definitions apply:

Use attributes

Used to specify certain display (or print) attributes used by edit, view, and print functions. For numeric fields, the available use attributes are:

Heading

The alternate heading that replaces the field name on displays and reports.

Output width

Number of character positions used by edit, view, and print functions to show this field in TABL display or print format. For numeric fields, from 6 to 30 (including a sign character and decimal point).

The default output width is the maximum of the number of characters needed to show the field heading (or field name, if no heading is specified), and the number of characters needed to show the value of the field.

Leading zeros

Specifies whether leading zeros are to be shown when this field is displayed or printed in SNGL or TABL display or print format. Specify YES if you want leading zeros shown. Specify NO if you want leading zeros replaced with blanks.

Default: NO

Length Field

Only shows for a segmented template and alphanumeric fields whose length does not exceed 4.

Each layout can have one field flagged as a length field. This tells File Manager to calculate the segment length based upon the value contained in the field.

You can enter one of the following values:

blank

This is not a length field.

1

The field value is the segment length.

2

The field value, plus the length of the field, is the segment length.

If a length field is not provided, the segment length is taken to be the 01 field length.

Create attributes

These define the field-specific attributes used by the data create functions when creating test data for records containing this field.



Note: The mantissa consists of an optional sign (+ or -) followed by 1 to 16 digits. The mantissa can also contain a decimal point. The exponent consists of the letter E, an optional sign (+ or 0), and 1 or 2 digits.

Start value

Specifies the initial value you want a field to contain, before being adjusted by the increment you specify.

The value must be a number that, when converted to the appropriate numeric data type, the field can hold, and, for a field with decimal places, must not specify more decimal integers than the number of decimal places in the field definition. If you specify a negative number, the sign is honored, even if the field is unsigned.

If the field is a floating-point field, the start value can be specified as a floating-point number consisting of a mantissa and an exponent (such as -1.14579E01).

Default: 0

End value

Specifies the maximum value (if the increment is a positive number) or minimum value (if the increment is a negative number) you want a field to contain.

The value must be a number that, when converted to the appropriate numeric data type, the field can hold, and, for a field with decimal places, must not specify more decimal integers than the number of decimal places in the field definition. If you specify a negative number, the sign is honored, even if the field is unsigned.

If the field is a floating-point field, the end value can be specified as a floating-point number consisting of a mantissa and an exponent (such as -01.14579E01).

Default: The largest positive or negative number the field can contain.

Increment

Specifies a positive or negative number by which you want the value in the field adjusted for each record (or cycle of records).

The increment must itself be a number that, when converted to the appropriate numeric data type, the field can hold, and, for a field with decimal places, must not specify more decimal integers than the number of decimal places in the field definition.

If the field is a floating-point field, the increment can be specified as a floating-point number consisting of a mantissa and an exponent (such as -1.14579E01).

For the first record (or cycle of records), the field is set to the start value you specify. For each subsequent record (or cycle of records), the increment is added to the value in the field. This

process continues as long as the calculated value in the field does not exceed the specified end value.

Default: 0

Cycle

Specifies the number of output records that are to be generated before the increment value is applied to the field value. For example, if you specify a field start value of 100, an increment value of 10, and a cycle value of 3, the field in the first 3 records contains 100, 110 in the next 3 records, 120 in the next 3 records, and so on.

If the cycle is 0, the value in the field is always set to the start value.

Scrambling Options

These options control field scrambling used during copy, import, or export functions to produce test data.

Scramble Type

Specify one of the following values:

Blank

No scrambling is performed. Value or range specifications are saved but ignored for the associated function.

1 (Random)

Performs random scrambling. The same input value produces different output values on subsequent invocations.

2 (Repeatable)

Performs repeatable scrambling. The same input value produces the same output value on subsequent invocations.

3 (Translate)

Performs translation. The value data set is searched to find a matching input value. If a match is found, then the output value is taken from the output column of the matching record.

4 (Exit)

Invokes a scrambling user exit. File Manager displays a panel where you can specify the user exit name and user exit parameters and options.

5 (ODPP)

Performs data scrambling by using the ODPP command that is specified in the adjacent command field. This is the Optim Data Privacy Provider command input area. The **Col** field is the left column position, which can be used to position to the error column when a syntax error occurs. Refer to the ODPP Syntax Guide for the command syntax. The ODPP **Command** is a scrollable field. Use the F10 and F11

keys to scroll left and right. Use the F4 key to expand the command into a separate window. This option is only available if File Manager was customized to access ODP, and the environment is successfully initialized. For more information, see the *File Manager Customization Guide*.



Note: For numeric fields, setting **Leading zeros** to YES causes leading zeros to be scrambled when random or repeatable scrambling (**Value** option blank) has been requested.

For example:

- With **Leading zeros** set to YES, 00123 may produce 56872 (zeros changed).
- With **Leading zeros** set to NO, 00123 may produce 00343 (zeros unchanged).

For repeatable scrambling, setting **Leading zeros** to YES guarantees a unique result.

Values

For numeric fields, you can provide these options to control the output for the selected scramble type:

Blank

File Manager determines the output value by performing either random or repeatable scrambling on the input value as determined by the scramble type.

1 (Range)

A range of values. You must provide a minimum and a maximum value that is valid for the field. During the copy operation, the scramble value generated is a number in the range provided. The minimum value must be less than the maximum value. The values provided must be between -2GB and +2GB.

2 (Value)

You provide values for the output field. The associated fields (**Column In**, **Out**, and **Dsn**), in conjunction with the scramble type, determine the output value.

Min

Minimum value. Must be less than the maximum value and greater than or equal to -2GB. When option 1 (Range) is selected, you must specify a value in this field.

Max

Maximum value. Must be greater than the minimum value and less than or equal to 2GB. When option 1 (Range) is selected, you must specify a value in this field.

Column In

Defines the start location of the input field value on the value data set, and is used when the translate process is run during a copy operation to match the input field with a value on the value data set. The length of the field is set to the length of the input field that is mapped to this field during the copy process.



Note: This value is only required when you select the scramble type, **Translate**.

(Column) Out

Defines the start location of the output field value on the value data set, and is used as follows during a copy operation:

- For scramble type, **Translate**: If an input field value is matched on the value data set, then the corresponding output value is used.
- For scramble types, **Random** or **Repeatable**: The input value is used to randomly or repeatably select an output value from the value data set.

The length of the field is the current field length as displayed on this panel.



Note: This value is required when you select the scramble type, **Translate**. If you select **Random** or **Repeatable**, and also select **Value**, then the start location defaults to 1 if a value data set name (**Dsn**) has been provided.

Dsn

Defines the value data set. It can be any catalogued sequential, partitioned or VSAM data set containing data that is used to determine the output field value during a copy process.

If the **Translate** scramble type is selected, then the data set must contain the input and output values in the locations provided in the input and output columns.

If the **Random** or **Repeatable** scramble type is selected, then the data set must contain the output value in the locations provided in the output column.



Note: This field is required when you select the **Translate** scramble type. If you select **Random** or **Repeatable**, and also select **Value**, then you can optionally provide a data set name. If you leave this field blank having selected **Value**, you are prompted to enter the value list to be stored in the template.

When specifying the data set name, the following rules apply:

- In a generic data set name, use the percent sign (%) to represent a single character, and an asterisk (*) to represent any number of characters within one qualifier. Two asterisks (**) represent any number of characters within any number of qualifiers.
- The TSO prefix (as defined for your user ID) is used as the high-level qualifier for any name that is not enclosed in quotation marks.
- For performance reasons, you should qualify the data set name as much as you can.
- If the data set is partitioned, then you can provide a member name in the form *dsn(member)*. If you do not provide a member name, or you provide a generic member name, then a member selection list is displayed for you to select a member.

Parent panels

- [Segment Layout panel on page 370](#)

Child panels

- None.

Field Information panel

This panel is displayed when you enter the FIELD primary command.

Panel and field definitions

Figure 58. Field Information panel

<u>P</u> rocess	<u>O</u> ptions	<u>H</u> elp				
FM/IMS		Field Information				
Database	DJ1E					
Segment	SHIRE					
Description						
Field	Characteristics	Start	Length	Type		
**** Top of data ****						
SHIREK	Sequence - Unique	1	20	Character		
**** End of data ****						
Command ==>						
F1=Help	F2=Split	F3=Exit	F4=CRetriev	F5=RFind	Scroll CSR	
F7=Backward	F8=Forward	F9=Swap	F12=Cancel	F6=Describe		

Database

Shows the name of the current database.

Segment

Shows the name of the current segment.

Description

Shows the description of the segment as entered on the Template Specification panel.

Field

Shows the name of the field as defined in the DBD for the database.

Characteristics

Shows one of the following to indicate the type of key field.

- Sequence - Unique
- Sequence - Multiple
- Secondary index source

This field is blank for a non-key field.

Start

Shows the starting position of the field.

Length

Shows the length of the field.

Type

Shows one of the following to indicate the data type for the field:

- Hexadecimal
- Packed decimal
- Character
- Binary full word
- Binary half word

Parent panels

- Can be invoked from all panels after the Entry panel for each function, by entering the FIELD primary command.

Child panels

- None.

Field Selection Criteria panel

The Field Selection Criteria panel and the Layout Identification Criteria panel are panels that are identical (except for their headings) that are displayed when you enter the relevant primary command from the View : Segment Layout or Template : Segment Layout panels. This panel is reached from the template only if the segment has multiple layouts. You use this panel to specify criteria "by field".

Panel and field definitions

Figure 59. Field Selection Criteria panel

Process	Options	Help
FM/IMS	Field Selection Criteria	Line 1 of 5
Cmd	Con (Field Name Op Value)
<->	-	<-----1-----2-----3-----> <-> <-----1-----2----->
***	****	Top of data ****
---	---	SUBURB-STREET
---	AND	SUB-STREET-KEY
---	AND	SUB-STREET-NAME
---	AND	SUFFIX
---	AND	DIRECTION
***	****	End of data ****
Command ==>		
F1=Help	F2=Split	F3=Exit
F7=Up	F8=Down	F9=Swap
F4=CRetriev	F5=RFind	F6=RunTemp
F10=Left	F11=Right	F12=Cancel
		Scroll HALF

Cmd

Prefix command area. These editor prefix commands are allowed: A, B, C, Cn, CC, D, Dn, DD, M, Mn, MM, O, On, OO, R, Rn, RR and RRn.

Con

Connectors - used to specify the AND/OR connectors. These are only relevant to lines containing segment selection expressions. The default value is **AND**. You can overtype the connectors with any of the following values:

Value entered

Resultant value

AND

AND

&

AND

OR

OR

|

OR



Note: Abbreviations are accepted. For example, if you overtype `AND` with `O`, it is changed to `OR`.

(

Left Parenthesis - parentheses must only be used on lines containing expressions. They are used to group criteria. The number of left parentheses must match the number of right parentheses.

Field Name

A non-editable field that displays the field names defined in the original copybook.



Note: If you are running a screen width of 115 or greater, the Field Name field can be displayed at the same time as the Start, Length and Type fields. However, at any width less than this, you need to toggle the display between Field Name and Start, Length and Type. The default display is Field Name. To toggle the display, enter the **FLDNAME** command or press F11.

Start

A non-editable field that displays the starting location of the fields, as defined in the original copybook.

Length

A non-editable field that displays the length of the fields, as defined in the original copybook.

Type

A non-editable field that displays the data type of the fields, as defined in the original copybook.

Op

Operator - used to create expressions. Valid operators are:

=, EQ

True if the terms are equal (numerically or when padded)

\=, \=, /=, NE

True if the terms are not equal (inverse of =)

>, GT

Greater than

<, LT

Less than

><, <>

Greater than or less than (same as not equal)

>=, GE

Greater than or equal to

\<, -<

Not less than

<=, LE

Less than or equal to

\>, ->

Not greater than

==

True if terms are strictly equal (identical)

\==, -==, /==

True if the terms are NOT strictly equal (inverse of ==)

>>

Strictly greater than

<<

Strictly less than

>>=

Strictly greater than or equal to

\<<, -<<

Strictly NOT less than

<<=

Strictly less than or equal to

RG

Range - value1 >= field <= value2

NR

Not in range - field < value1 or field > value2

CO

Contains one of the values specified

-CO

Does not contain one of the values specified.

NC

Numeric contains - a number is one of the values

-NC

Does not contain the specified number(s)

Value

Use this field to provide a character or numeric constant to be used for comparison in the expression. If the operator supports more than one value (for example, RG, CO) then use comma delimiters to provide separate values. When specifying values, the following rules apply:

Hexadecimal strings

A hexadecimal string must be in the form `'hhhhhh'x`. The value enclosed in quotation marks must be an even number of characters and contain valid hexadecimal characters (0123456789ABCDEF).

Binary strings

A binary string must be in the form `'nnnnnn'b`. The value enclosed in quotation marks must be a combination of 0 and 1s.

Numeric Operands

The value(s) specified for a numeric field type must be a valid number. Quoted values are not accepted.

Character strings

For nonnumeric types the value is automatically enclosed in quotation marks if you do not specify them. When specifying more than one value for operations other than RG and NR you must provide quotation marks for all the comma delimited values

Date strings

A date string must be in the form `d'xxxxxxxx'`. The string must be specified in the output format defined for the field.

The following is an example of a date value:

```
d'Jan 01, 2014'
```

where the output format is:

```
Mmm DD, YYYY
```

Time strings

A time string must be in the form `t'xxxxxxxx'`. The string must be specified in the output format defined for the field.

The following is an example of a time value:

```
t'15:30:00.000'
```

where the output format is:

```
HH:MI:SS.999
```



Note:



1. Date and time strings cannot be used with contains operators.
2. When used with range operators requiring two values the second value should be quoted, for example, `d'Jan 01, 2014', 'Dec 01, 2014'`.
3. Use `d=''` or `t=''` to retrieve the current date or time value in the output format.

)

Right Parenthesis - parentheses must only be used on lines containing expressions. They are used to group criteria. The number of left parentheses must match the number of right parentheses.

Parent panels

- [Segment Layout panel on page 370](#)

Child panels

- None.

IMS™ Catalog Specification panel

The IMS Catalog Specification panel is displayed in the Template dialog (option 4.1) and in the Template Update Utility dialog (option 4.4).

On the panel, you specify the IMS catalog that contains the database definitions (DBDs) that you want the function to use. You identify the IMS catalog that the function is to use by specifying the subsystem that uses it.

Template dialog

The panel is displayed in the Template dialog when the template specified on the Template Entry panel has an IMS catalog name stored in it rather than a DBD library list and any of the following are true:

- The ID of the subsystem used to identify the IMS catalog cannot be found in the FM/IMS installation options module.
- The specified subsystem does not use IMS-managed ACBs.
- One of the DBDs that the function uses cannot be found in the IMS catalog.
- You issue the SSID command on the Template Specification panel.

The function searches the IMS catalog for a DBD for the database that the template is for and obtains a list of the segment types in the database from the DBD that it finds. For a new template, this list is used to create the template's segment list. For an existing template, if the template's segment list is not the same as this list, the function updates the template's segment list to make it the same.

The ID of the subsystem that you specify is saved in the template and is used for subsequent updates.

When you issue the SSID command, the panel displays the ID of the subsystem that is currently stored in your template.

Template Update Utility dialog

The panel is displayed in the Template Update Utility dialog when the **Specify IMS catalog** option is selected and the **Skip database segment list update** option is not selected. Both these options are on the Template Update Utility panel.

The utility uses the DBDs in the specified IMS catalog when either or both of these conditions are true:

- The **Specify DBDLIB list** option is not selected.
- The DBDs that were used the previous time the template's segment list was updated came from an IMS catalog rather than DBD libraries.

When this is the case, the utility searches the specified IMS catalog for a DBD for the database that the template is for and obtains a list of the segment types in the database from the DBD that it finds. If the template's segment list is not the same as this list, the utility updates the template's segment list to make it the same.

If the update of the template is successful, the utility saves the name of the specified IMS catalog in the template.



Note:

1. When the **Skip database segment list update** option is not selected, the **Specify IMS catalog** and the **Specify DBDLIB list** options are selected, and the DBDs that were used the previous time the template's segment list was updated came from DBD libraries, the utility uses the DBDs in the libraries specified on the DBD Library List panel.
2. When the **Skip database segment list update**, the **Specify IMS catalog** and the **Specify DBDLIB list** options are all not selected, the utility uses the DBDs in either the DBD library list stored in the template or the IMS catalog stored in the template.

Panel and field definitions

Figure 60. IMS Catalog Specification panel

<u>P</u> rocess	<u>O</u> ptions	<u>H</u> elp
FM/IMS		IMS Catalog Specification panel
IMS catalog:		
Subsystem name	. . IFG1	
Command ==>		
F1=Help	F2=Split	F3=Exit
F10=Actions	F12=Cancel	F7=Backward F8=Forward F9=Swap

Subsystem name

Specify the ID of the subsystem that uses the IMS catalog that you want the function to get the DBDs from.

Only subsystems that use IMS-managed ACBs may be specified.

If you enter either no subsystem name or a subsystem name pattern, the Subsystem Selection panel is displayed. You can select a subsystem from the list of subsystems displayed on that panel.

Parent panels

- [Template Entry panel on page 409](#)
- [Template Specification panel on page 412](#)
- [Template Update Utility panel on page 418](#)

IMS™ Subsystem Specification panel

The IMS Subsystem Specification panel is displayed when the **Specify subsystem** option is selected on the View Update Utility panel or Criteria Set Update Utility panel.

When **Specify subsystem** is selected, the utility bases your views or criteria sets on templates that are dynamically generated from data in an IMS™ catalog or DBD libraries. Templates that are dynamically generated from data in an IMS™ catalog or DBD libraries are called *dynamic templates*.

On this panel, you specify where you want the utility to get the data from by selecting an IMS subsystem. The subsystem name is stored in the updated views and criteria sets and they are flagged as being based on a dynamic template.

If both the **Specify Template data set** and **Specify subsystem** options are selected, the utility only bases the view or criteria set on a dynamically generated template when it is currently based on a dynamic template. When the view or criteria set is based on a static template, the utility bases it on templates that are in the data set you specified in the Template data set name field.

When neither of these options are selected, the utility does the following.

- When the view or criteria set is based on a dynamic template, the utility bases it on a template that is dynamically generated from data in either the IMS catalog or DBD libraries that the subsystem specified in the view or criteria set uses.
- When the view or criteria set is based on a static template, the utility bases it on the template whose name is stored in the view or criteria set.

Panel and field definitions

Figure 61. IMS Subsystem Specification panel

Process	Options	Help
FM/IMS		IMS Subsystem Specification panel
IMS:	Subsystem name . . IFG1	
Command ==>	F1=Help	F2=Split F3=Exit F7=Backward F8=Forward F9=Swap
	F10=Actions	F12=Cancel

Subsystem name

Select an IMS™ subsystem to specify where you want the utility to get the data from. When IMS™ manages ACBs, the utility gets the data from the IMS™ catalog that the selected subsystem uses. When ACBs are managed by your installation, the utility gets the data from the DBD libraries for the selected subsystem.

If you enter either no subsystem name or a subsystem name pattern, the Subsystem Selection panel is displayed. You can select from the list of subsystems displayed on that panel.

Parent panels

- [Criteria Set Update Utility panel on page 229](#)
- [View Update Utility panel on page 429](#)

IMS data panel

This panel is displayed in the Browse and Edit dialogs after you have specified a starting position within the database on the Database Positioning or Key Specification panel.

The panel title includes the dialog type (Browse or Edit) and the database name. The panel displays data in the IMS database from the specified starting position. When you are in the Edit dialog, the panel allows you to update the data.

IMS data can be displayed in CHAR, HEX, LHEX, TABL, or SNGL format. [Figure 62: IMS data panel - CHAR format on page 310](#) through [Figure 67: IMS data panel - SNGL format on page 312](#) show the panel with the data in each of these formats.

Figure 66. IMS data panel - TABL format with SHOW SUP OFF

Process	Options	Help
FM/IMS	CHKPID FM000001 Autosave OFF SHOW SUP OFF Scope DB	Edit : IMS Database DJ1E Format <u>TABL</u>
Cmd Level Segment	SHIRE-NAME #3 AN 1:20	SHIRE-TYPE #4 AN 21:1 SHIRE-CODE1 #5 ZD 22:3 SHIRE-CODE2 #6 ZD 25:5
	<-----1-----> -	<--> <---->
	**** Top of window ****	
1	SHIRE DENMARK	1 305 244
2	SHIRENP 1 segment	
2	LINKSUB 18 segments	
1	SHIRE Key=ESPERANCE	Layout=SHIRE
2	SHIRENP 1 segment	
2	LINKSUB 22 segments	
1	SHIRE Key=EXMOUTH	Layout=SHIRE
2	SHIRENP 1 segment	
2	LINKSUB 2 segments	
1	SHIRE Key=FREMANTLE	Layout=SHIRE-CITY
2	SHIRENP 1 segment	
2	LINKSUB 9 segments	
1	SHIRE KALGOORLIE	1 605 0
2	SHIRENP 1 segment	
Command ==>	F2=Format F3=Exit F4=CRetrieve F5=RFind F6=RChange	Scroll CSR
F1=Help F7=Up	F8=Down F9=Swap F10=Left F11=Right	F12=Cancel

Figure 67. IMS data panel - SNGL format

Process	Options	Help
FM/IMS	CHKPID FM000001 Autosave OFF SHOW SUP ON Scope DB	Edit : IMS Database DJ1E Format <u>SNGL</u>
Segment SHIRE	Level: 1	
Concatenated key value: DENMARK		Top Line is 1 of 9
Current 01: SHIRE-TOWN		
Ref	Field	Typ Len Data
3	SHIRE-NAME	AN 20 K DENMARK
4	SHIRE-TYPE	AN 1 1
5	SHIRE-CODE1	ZD 3 305
6	SHIRE-CODE2	ZD 5 244
7	SHIRE-YEAR	BI 2 6280
8	SHIRE-BRICK	PD 8 606363187610
9	SHIRE-WOODEN	PD 8 2034233224332
10	SHIRE-SCHOOL	PD 4 3020312
11	SHIRE-GOLF	BI 2 12608
*** End of record ***		
Command ==>	F2=Format F3=Exit F4=CRetrieve F5=RFind F6=RChange	Scroll CSR
F1=Help F7=Up	F8=Down F9=Swap F10=Left F11=Right	F12=Cancel

Fields in Header area:

Title

The title of the panel; includes the name of the database that you are browsing or editing.

CHKPID

(Edit only) The checkpoint ID of the last checkpoint taken.

Autosave

(Edit only) The current setting of the Autosave option:

ON

The FM/IMS automatic checkpoint facility is turned on.

OFF

The FM/IMS automatic checkpoint facility is turned off.

To change this setting during an Edit session, use the AUTOSAVE primary command.

To change the initial setting for an Edit session, select or deselect the **Set AUTOSAVE ON** option on the DLI Mode Options panel (option 0.6.4) or the BMP Mode Options panel (option 0.7.2).

SHOW SUP

(Only when using a view) The current setting of the SHOW SUP option. The setting affects the display of suppressed segments when in CHAR, HEX, LHEX, and TABL format:

ON

There is one line for each suppressed segment occurrence. When in CHAR, HEX or LHEX display format, the data of suppressed segments is displayed in the data area just as it is for nonsuppressed segments. When in TABL format, the key of the suppressed segment is displayed in the data area.

OFF

The data of suppressed segments is not displayed. Suppressed segment occurrences are grouped together and are represented by shadow lines. When a shadow line represents just one segment occurrence, the key of the segment occurrence is displayed in the data area. When a shadow line represents more than one segment occurrence, the number of segment occurrences the shadow line represents is displayed in the data area. When more than one segment layout has been specified for a segment type, the layout of the suppressed segments is also displayed on the shadow line.

To change the setting during an Edit session, use the SHOW SUP primary command.

To change the initial setting for an Edit session, select or deselect the **Set SHOW SUP ON** option on the Editor Options panel (option 0.5).

Scope

The current setting of the scope option. The scope is the range over which:

- Commands operate
- Segments are retrieved for display

Scope can have the following values:

DB

The scope is the entire database.

REC

The scope is restricted to the current database record.

To change the setting during an Edit session, use the SCOPE primary command.

To change the initial setting for an Edit sessions, select or deselect the **Set SCOPE REC** option on the Editor Options panel (option 0.5).

Col

(CHAR, HEX and LHEX formats only) The leftmost data column that is currently displayed. You can scroll to a specific column (left or right) by typing a new value.

Format

The display format of the data. Either CHAR, HEX, LHEX, TABL, or SNGL. To change the display format, overwrite the first byte of the field with the first character of the desired format.

Segment

(SNGL format only) The name of the segment displayed on the panel.

Level

(SNGL format only) The hierarchical level of the segment in the database.

Concatenated key value

(SNGL format only) The concatenated key value of the displayed segment.

Current 01

(SNGL format only) The layout used to format the data of the segment.

Fields in Data area (CHAR, HEX, LHEX, and TABL formats):

Multiple segment occurrences are displayed. Each segment occurrence is displayed in a single line (CHAR, LHEX, and TABL formats), or on 3 lines (HEX format). For each segment, the following fields are displayed:

Cmd

The line command entry field. This panel supports the following line commands:

D

(Edit only) Deletes the segment occurrence and all its dependents.

FC, FH, and FL

- Scrolls the line to the top of the display
- When the line is a shadow line, makes the suppressed segments associated with the shadow line the currently formatted segment type
- Changes the display format to CHAR (FC), HEX (FH), or LHEX (FL)

FS, FT

(Only when using a view)

- Scrolls the line to the top of the display
- When the line is a shadow line, makes the suppressed segments associated with the shadow line the currently formatted segment type
- Changes the display format to SNGL (FS), or TABL (FT)

I, R

(Edit only) Displays either the Insert Root Segment panel (when entered against a root segment) or the Insert Segment panel (when entered against a nonroot segment). These panels allow you to insert a segment occurrence into the database.

K

Displays the Key Specification panel for the segment type of the occurrence against which you entered the command. This panel allows you to specify a new starting position in the database for the display of data.

RA

(Edit only) Displays either the Insert Root Segment panel (when entered against a root segment) or the Insert Segment panel (when entered against a nonroot segment). These panels allow you to insert a segment occurrence into the database and duplicate all of the dependent segments of the segment against which the command was issued under this new occurrence.

V

(Only when using a view) When entered against a shadow line, makes the suppressed segment associated with the shadow line the currently formatted segment type.

Level

The hierarchical level of the segment in the database.

Segment

The segment type.

Fields in Data area (SNGL format):

A single segment occurrence is displayed. FM/IMS associates a layout with the segment occurrence and the data is formatted into the fields of the layout. The layouts are defined in the view that you are using. The fields of the layout are displayed down the page. For each field, the following details are displayed in columns across the page:

CCSID

The CCSID if one has been assigned to the field in the template.

To display or hide the CCSID column, use the CCSID primary command. To change the initial setting for an Edit session, select or deselect the Show the CCSID on the Editor Options panel (option 0.5).

Ref

The field reference number that the view has assigned to the field.

To display or hide the field reference number, use the REFS primary command. To change the initial setting for an Edit session, select or deselect the Record formatting option **Field reference number** on the **Editor Options** panel (option 0.5).

Field

The level number and name of the field, together with other attributes such as REDEFINES, array sizes, and DEPENDING ON references.

To display or hide the structure information in the **Field** column, use the STR primary command. To change the initial setting for an Edit session, select or deselect the Record formatting option **Structure** on the **Editor Options** panel (option 0.5).

To display or hide the REDEFINES information (in the **Field** column) and the redefined fields, use the RDF primary command. To change the initial setting for an Edit session, select or deselect the Record formatting option **Redefined fields** on the **Editor Options** panel (option 0.5).

Typ

The data type for the field.

To display or hide the **Type** column, use the TYP primary command. To change the initial setting for an Edit session, select or deselect the Record formatting option **Field type and length values** on the **Editor Options** panel (option 0.5).

Start

The location within the layout of the start of the field.

To display or hide the **Start** column, use the SLOC primary command. To change the initial setting for an Edit session, select or deselect the Record formatting option **Start location** on the **Editor Options** panel (option 0.5).

Len

The length of the field.

To display or hide the **Length** column, use the TYP primary command (see **Typ** entry above).

Data

The data of the field in a display format.

Parent panels

- [Database Positioning panel on page 239](#)
- [Key Specification panel on page 332](#)

Child panels

- [Insert Root Segment panel on page 321](#)
- [Insert Segment panel on page 323](#)
- [Insert Segment Selection panel on page 329](#)

Related topics and examples

- [Accessing your databases on page 47](#)
- [RDF primary command on page 485](#)
- [REFS primary command on page 486](#)
- [SCOPE primary command on page 492](#)
- [SLOC primary command on page 495](#)
- [STR primary command on page 500](#)
- [TYPE primary command on page 502](#)

Initial Load Options panel

The Initial Load Options panel is displayed when you select Initial for the Load type on the Load Entry panel.

On this panel, you specify:

- The details of the data set that contains the data that you want loaded into your databases.
- Whether or not you want the generated JCL to include job steps that delete and redefine the database data sets.
- Whether or not you want the generated JCL to include a job step that creates an image copy job and submits it to the internal reader.
- When the JCL includes the image copy job step, the name of the PDS(E) that contains the image copy skeletons that you want the job step to use.

Panel and field definitions

Figure 68. Initial Load Options panel

<u>P</u> rocess	<u>O</u> ptions	<u>H</u> elp
FM/IMS	Initial Load Options	
Load From:		
Data set name . . .	_____	
Volume serial . . .	_____	(If not cataloged)
Device type	_____	(Generic unit or device address)
Image Copy Skeleton:		
Data set name . . .	_____	
Processing Options:		
Enter "/" to select option		
_	Delete/Define DB data sets	
_	Submit image copy	
Command ==>		
F1=Help	F2=Split	F3=Exit
F9=Swap	F10=Actions	F12=Cancel
	F4=CRetriev	F7=Backward
		F8=Forward

Load From

Data set name

The name of the sequential data set that contains the data that you want loaded into your databases.

Volume serial

If the Load From data set is not cataloged, the volume on which it resides.

Device type

The device type of the volume that contains the Load From data set.

Image Copy Skeleton

Data set name

If the **Submit image copy** option is selected, specify the PDS(E) that contains the image copy skeletons that you want the Load to use.



Note: This field is ignored when the **Submit image copy** option is not selected.

Delete/Define DB data sets

Select this option if you want the generated JCL to include job steps that delete and redefine the database data sets.

When included, these job steps precede all other steps in the Load job.

Submit image copy

Select this option if you want the generated JCL to include a job step that uses GENJCL.IC commands to generate an image copy job.

The generated image copy job is submitted to the internal reader.

Parent panels

- [Load Entry panel on page 335](#)
- [Database Data Set Specification panel on page 236](#)
- [Database Data Set Display panel on page 234](#)

Child panels

- [JCL Submission panel on page 331](#)

Initialize Entry panel

The Initialize Entry panel is the first panel in the Initialize dialog.

It is displayed when you select option 2 (Initialize) from the Utility Menu panel.

Panel and field definitions

Figure 69. Initialize Entry panel

Process	Options	Help
FM/IMS	Initialize Entry Panel	
IMS:		
Subsystem name . . .	IF52	
Database name . . .	DJ1E	
Image Copy Skeleton:		
Data set name . . .	_____	
Processing Options:		
Fetch DB dsnames from	Enter "/" to select option	
<u>1</u> 1. User profile	_ Delete/Define DB data sets	
2. DFSMDA members	_ Submit image copy	
	_ Skip DB data set panel	
Command ==>		
F1=Help	F2=Split	F3=Exit
F9=Swap	F10=Actions	F12=Cancel
	F4=CRetriev	F7=Backward
	F8=Forward	

IMS

Subsystem Name

The ID of the IMS subsystem that the database you want to initialize is defined in.

FM/IMS searches the FM/IMS installation options module for the subsystem with the specified name.

If you enter either no subsystem name or a subsystem name pattern, the Subsystem Selection panel is displayed. You can select a subsystem from the list of subsystems displayed on that panel.



Note: When the specified IMS subsystem only allows the use of a static PSB or BMP batch processing then only a Fast Path or a HALDB database can be specified in the Database name field. This is because to initialize a full function database requires the use of a dynamic PSB running in a DL/I batch processing region.

Database Name

The name of the database that you want to initialize. When the database is logically related to other databases, the Initialize also initializes the logically related databases.

FM/IMS searches either an IMS catalog or DBD libraries for a DBD with the specified name.

Which of these two sources is searched depends on whether or not the selected subsystem uses IMS-managed ACBs.

If the selected subsystem uses IMS-managed ACBs, then FM/IMS searches the IMS catalog that the subsystem uses.

Otherwise, FM/IMS searches user- or administrator-specified DBD libraries. The libraries that are searched depend on which subsystem you select, so they are called the DBD libraries for the selected subsystem.

The DBD libraries for the selected subsystem are displayed on the PSB and DBD Data Sets panel and may or may not be fixed by the FM/IMS administrator.

If the DBD libraries for the subsystem are fixed, the DBD Data set name fields on the PSB and DBD Data Sets panel are protected and you must use the DBD libraries that the administrator has specified. Otherwise, these fields are not protected and you are free to modify the list of DBD libraries that FM/IMS searches.

FM/IMS searches the DBD libraries in the order in which they are specified and uses the first DBD it finds with the specified name.

IMS requires the following DBDs to be in at least one of the specified DBD libraries:

- The DBD for the database that you specify.
- The DBD for each database that is logically related to the database that you specify.

If you enter either no database name or a database name pattern, the Database Selection panel is displayed. You can select a database from the list of databases displayed on that panel.

Image copy skeleton

Data set name

If you select the **Submit image copy** option, specify the PDS(E) that contains the image copy skeletons that you want the Initialize to use.



Note: This field is ignored when the **Submit image copy** option is not selected.

Fetch DB dsnames from

If you select a database that is not a HALDB and an IMS subsystem that is not a dynamic allocation only subsystem, specify either:

1. User profile

The Initialize uses the database data sets whose names were saved in your user profile.

2. DFSMDA members

The Initialize uses the database data sets specified in the DFSMDA dynamic allocation members.



Note: This field is ignored when you specify either:



- A database that is a HALDB.
- An IMS subsystem that is defined as dynamic allocation only in the FM/IMS installation option module.

Delete/Define DB data sets

Select this option if you want the generated JCL to include job steps that delete and redefine the database data sets. When included, these job steps precede all other steps in the Initialize job.

Submit image copy

Select this option if you want the generated JCL to include a job step that uses GENJCL.IC commands to generate an image copy job. The generated image copy job is submitted to the internal reader.

Skip DB data set panel

When selected, FM/IMS does not display the Database Data Set Specification or the Database Data Set Display panel.

Parent panels

- [Utility Menu panel on page 425](#)

Child panels

- [Database Data Set Display panel on page 234](#)
- [Database Data Set Specification panel on page 236](#)
- [JCL Submission panel on page 331](#)

Related topics and examples

- [Initializing an empty database on page 153](#)

Insert Root Segment panel

In an Edit session, FM/IMS displays the Insert Root Segment panel when you enter one of the following commands on the IMS Data panel:

- The REPEAT primary command, and the current segment is a root segment.
- The INSERT primary command, and the root segment is either specified in the INSERT primary command or selected on the Insert : Segment Selection panel.
- The I, R, or RA line command against a root segment.

You use this panel to:

- Insert a root segment (if it is invoked by the REPEAT or INSERT primary commands, or the I or R line commands).
- Insert a root segment and then duplicate all the dependent segments of the current segment under this new occurrence (if it is invoked by the REPEAT ALL primary command).
- Insert a root segment and then duplicate, under this new occurrence, all the dependent segments of the segment against which the line command was issued (if it is invoked by the RA line command).

Panel and field definitions

Figure 70.

Process		Options		Help	
FM/IMS		Insert Root Segment			
Database DJ1E		Segment SHIRE	Insert Format		SNGL

Data				Top Field is 1 of 11	
Ref	Field	Typ	Start	Len	Data
1	1 SHIRE-TOWN	AN	1	53	
2	2 SHIRE-KEY	AN	1	20	K
3	3 SHIRE-NAME	AN	1	20	K
4	2 SHIRE-TYPE	AN	21	1	
5	2 SHIRE-CODE1	ZD	22	3	0
6	2 SHIRE-CODE2	ZD	25	5	0
7	2 SHIRE-YEAR	BI	30	2	0
8	2 SHIRE-BRICK	PD	32	8	0
9	2 SHIRE-WOODEN	PD	40	8	0
10	2 SHIRE-SCHOOL	PD	48	4	0
11	2 SHIRE-GOLF	BI	52	2	0
**** End of record ****					
Command ==>				Scroll PAGE	
F1=Help	F3=Exit	F4=CRetriev	F5=RFind	F6=RChange	F7=Up
F8=Down	F9=Swap	F12=Cancel			

The panel has a Header area and a Data area.

Header area

These details are displayed in the Header area:

Database

The name of the database you are editing.

Segment

The name of the root segment, followed by the segment description (when available).

Insert Format

The display format for the Data area.

FM/IMS supports four display formats: CHAR, HEX, LHEX, and SNGL. SNGL is only supported when you are using a view.

The Insert Format used when the panel is first displayed depends on the current display format of the IMS Data panel.

When the current display format is CHAR, HEX, LHEX or SNGL, the Insert Format is set to the current display format.

When the current display format is TABL, the Insert Format is set to SNGL.

To change the display format of the Data area, update this field.

Data area

In the Data area, you specify the key and the data of the root segment you are inserting.

This is a scrollable area. To scroll it, issue the UP (F7) or DOWN (F8) commands.

The key and the data that is initially displayed in this area depends on the command used to invoke this panel:

- When the REPEAT primary command is used, the key and data of the current segment is displayed.
- When the R or RA line command is used, the key and data of the segment that the line command is entered against is displayed.
- When the INSERT primary command or the I line command is used, the initial display depends on whether or not you are using a view:
 - When you are not using a view, the key and the data is initialized to spaces.
 - When you are using a view, FM/IMS uses a segment layout when initializing the area. Numeric fields in the layout are set to zero and nonnumeric fields are set to spaces.

For the I line command, FM/IMS uses the layout of the segment occurrence that the line command is entered against.

For the INSERT primary command, FM/IMS uses the layout of the selected segment type or, if the segment type has multiple layouts, the selected segment layout.

When you have specified the key and data of the root segment you are inserting, press the Exit function key (F3) to insert the segment and return to the IMS Data panel.

To return to the IMS Data panel without inserting a segment, press the Cancel function key (F12).

Parent panels

- [IMS data panel on page 309](#)

Child panels

- None.

Insert Segment panel

In an Edit session, FM/IMS displays the Insert Segment panel when you enter one of the following commands on the IMS Data panel:

- The REPEAT primary command, and the current segment is not a root segment.
- The INSERT primary command, and a nonroot segment is either specified in the INSERT primary command or selected on the Insert : Segment Selection panel.
- The I, R, or RA line command against a nonroot segment.

You use this panel to:

- Insert a nonroot segment (if it is invoked by the REPEAT or INSERT primary commands, or the I or R line commands).
- Insert a nonroot segment and then duplicate all the dependent segments of the current segment under this new occurrence (if it is invoked by the REPEAT ALL primary command).
- Insert a nonroot segment and then duplicate, under this new occurrence, all the dependent segments of the segment against which the line command was issued (if it is invoked by the RA line command).

Panel and field definitions

Figure 71. Insert Segment panel

Process		Options		Help	
FM/IMS		Database DJ2E		Segment LETRBOX	
		Insert Segment		Insert Format SNGL	

Parent Keys				Line 1 of 2	
Lvl	Segment	Key field name	Type	Key value	Occur
1	SUBURB				
#2		2 SUBURB-NAME	AN	EAST PERTH	

Data				Top Field is 1 of 4	
Ref	Field	Typ	Len	Data	
1	1 LETTER-BOX	AN	34		
2	2 LETTER-BOX-KEY	AN	4	K	
3	3 POST-CODE	AN	4	K	
4	2 LOCATION	AN	30		
*** End of record ***					
Command ==>				Scroll CSR	
F1=HELP	F3=Exit	F4=CRetrie	F5=RFind	F6=RChange	F7=Up
F8=Down	F9=Swap	F10=Left	F11=Right	F12=Cancel	

The panel has three areas: a Header area, a Parent Keys area, and a Data area.

Header area

These details are displayed in the Header area:

Database

The name of the database you are editing.

Segment

The name of the segment type you are inserting, followed by the segment description (when available). The setting of this field depends on the command used to invoke this panel.

Insert Format

The display format for the Parent Keys area and Data area.

FM/IMS supports four display formats: CHAR, HEX, LHEX, and SNGL. SNGL is only supported when you are using a view.

The Insert Format used when the panel is first displayed depends on the current display format of the IMS Data panel.

When the current display format is CHAR, HEX, LHEX or SNGL, the Insert Format is set to the current display format.

When the current display format is TABL, the Insert Format is set to SNGL.

To change the display format of the Parent Keys area and Data area, update this field.



Note: The LHEX display format for the Parent Keys area is not currently supported. When you specify LHEX for **Insert Format**, FM/IMS displays the Parent Keys area in HEX display format.

Parent Keys area

In the Parent Keys area, you specify the parent segments of the segment you are inserting. The display format of this area depends on the value specified in the **Insert Format** field.

This is a scrollable area. To scroll it, place the cursor in the data portion of the area (below the column headers) and issue the UP (F7) or DOWN (F8) commands.

For each segment, type in the path to the segment that you are inserting. The following details are displayed:

Lvl

The hierarchical level of the segment type in the database.

Segment

The name of the segment type.

Key field name

When you are using the SNGL insert format and there is a layout that matches the key field of the segment type, the names of the fields in the segment layout that match the key field are displayed. If the key field is divided into several fields in the template, each subfield is displayed to form the whole key.

When you are not using the SNGL insert format or FM/IMS cannot find a layout to match the key field, the key field name specified in the DBD is displayed. Each key then only has one field associated with it.

Type

The data type of the key field. This can be:

AN

Alphanumeric (includes alphabetic and group items)

AX

Alphanumeric displayed in long hexadecimal.

BI

Binary

BT

Bit

DB

DBCS (PL/I)

FE

Floating point (external)

FP

Floating point (internal)

G

DBCS (COBOL)

PD

Packed decimal (internal decimal)

VB

Varying bit

VC

Varying character

VD

Varying DBCS (PL/I)

VG

Varying DBCS (COBOL)

ZA

Zoned Alphanumeric (COBOL & PL/I external edited) Edited picture definitions that do not fit the ZE definition

ZC

Z Character

ZD

Zoned Decimal (external decimal)

ZE

Zoned Edited (COBOL & PL/I external edited) Supports picture edit characters + - . V
9

ZG

Varying DBCS null terminated (COBOL)

Z2

Varying DBCS null terminated (PL/I)

U

Unformatted. The data type is unformatted when you are not using insert format SNGL, or when FM/IMS cannot find a layout that matches the key field of the segment type.

Use the following fields to specify the position in the database at which the segment is to be inserted. For each segment type in the path to the segment that you are inserting, you specify:

Key value

The key value of the segment. If the segment has no key, 'No key' is displayed and the field is protected.

Occur

The occurrence number of the segment. This field is only present when the segment type has a non-unique key or no key.

Data area

In the Data area, you specify the key and the data of the segment you are inserting. The display format of this area depends on the value specified in the Insert Format field.

This is a scrollable area. To scroll it, issue the UP (F7) or DOWN (F8) commands with the cursor outside the data portion of the Parent Keys area.

The key and the data that is initially displayed in this area depends on the command used to invoke this panel:

- When the REPEAT primary command is used, the key and data of the current segment is displayed.
- When the R or RA line command is used, the key and data of the segment that the line command is entered against is displayed.
- When the INSERT primary command or the I line command is used, the initial display depends on whether or not you are using a view:

- When you are not using a view, the key and the data is initialized to spaces.
- When you are using a view, FM/IMS uses a segment layout when initializing the area. Numeric fields in the layout are set to zero and nonnumeric fields are set to spaces.

For the I line command, FM/IMS uses the layout of the segment occurrence that the line command is entered against.

For the INSERT primary command, FM/IMS uses the layout of the selected segment type or, if the segment type has multiple layouts, the selected segment layout.

When you have specified the parent segments of the segment you are inserting in the Parent Keys area and the key and data of the segment in the Data area, press the Exit function key (F3) to insert the segment and return to the IMS Data panel.

To return to the IMS Data panel without inserting a segment, press the Cancel function key (F12).

Parent panels

- [IMS data panel on page 309](#)

Child panels

- None.

Insert Segment Layout Selection panel

In an Edit session, FM/IMS displays the Insert Segment Layout Selection panel when you issue the INSERT primary command for a segment type that has multiple layouts.

You use the panel to select the layout for the segment type that is to be inserted.

Panel and field definitions

Figure 72. Insert Segment Layout Selection panel

```

Process  Options  Help
-----
FM/IMS          Insert : Segment Layout Selection

Segment  SHIRE

Cmd  Segment layout name          Length
    SHIRE                          53
    SHIRE-TOWN                       53
    SHIRE-CITY                        53
    **** End of data ****

Command ==> _____ Scroll CSR

```

Parent panels

- [IMS data panel on page 309](#)

Child panels

- [Insert Root Segment panel on page 321](#)
- [Insert Segment panel on page 323](#)

Insert Segment Selection panel

In an Edit session, FM/IMS displays the Insert Segment panel when you enter the INSERT primary command (without a parameter) on the IMS Data panel.

You use this panel to select the segment type that is to be inserted.

Panel and field definitions

Figure 73. Insert Segment Selection panel

Process	Options	Help
FM/IMS		
Insert : Segment Selection		
Cmd	Level	Segment Description
-	1	SHIRE
-	2	SHIRENP
-	2	LINKSUB
**** End of data ****		
Command ==>		
F1=Help	F2=Split	F3=Exit
F9=Swap	F10=Actions	F12=Cancel
		F4=CRetriev
		F7=Backward
		Scroll PAGE
		F8=Forward

Parent panels

- [IMS data panel on page 309](#)

Child panels

- [Insert Root Segment panel on page 321](#)
- [Insert Segment panel on page 323](#)
- [Insert Segment Layout Selection panel on page 328](#)

ISPF Settings panel

You use the ISPF Settings panel to display and modify selected ISPF parameters.

Panel and field definitions

Figure 74. ISPF Settings panel

```

Log/List  Function keys  Colors  Environ  Workstation  Identifier  Help
-----
                                ISPF Settings
                                More:      +

Options
Enter "/" to select option
- Command line at bottom
┌ Panel display CUA mode
- Long message in pop-up
- Tab to action bar choices
- Tab to point-and-shoot fields
┌ Restore TEST/TRACE options
- Session Manager mode
┌ Jump from leader dots
- Edit PRINTDS Command
┌ Always show split line
- Enable EURO sign

Print Graphics
Family printer type 2
Device name . . . .
Aspect ratio . . . 0

General
Input field pad . . B
Command delimiter . i

Terminal Characteristics
Screen format  1. Data    2. Std    3. Max    4. Part

Terminal Type  3_   1. 3277    2. 3277A  3. 3278    4. 3278A
                5. 3290A    6. 3278T  7. 3278CF  8. 3277KN
                9. 3278KN 10. 3278AR 11. 3278CY 12. 3278HN
               13. 3278HO 14. 3278IS 15. 3278L2 16. BE163
               17. BE190 18. 3278TH 19. 3278CU 20. DEU78
               21. DEU78A 22. DEU90A 23. SW116 24. SW131
               25. SW500

Command ==>

```

Refer to the *ISPF User Guide Volume 1* for details of these fields.

Parent panels

- Options pull-down menu.

Child panels

- None.

JCL Submission panel

This is an ISPF edit session that displays the JCL generated by FM/IMS functions. You can modify the JCL before you submit it.

Panel and field definitions

Figure 75. Load JCL Submission panel

```

File Edit Edit Settings Menu Utilities Compilers Test Help
-----
EDIT          FMNUSER.SPFTEMP1.CNTL          Columns 00001 00072
***** ***** Top of Data *****
000001 //FMNUSER JOB (IMS,PE22),'FM/IMS SUBMITTED JOB',CLASS=A,
000002 //          MSGCLASS=X,MSGLEVEL=(1,1),NOTIFY=&SYSUID,REGION=0M
000003 //*
000004 //*          USED BY THE EXTRACT AND LOAD OPTION
000005 //*
000006 //SORTSTEP EXEC PGM=SORT
000007 //STEPLIB DD DSN=SYS1.SORTLIB,DISP=SHR
000008 //SYSOUT DD SYSOUT=*
000009 //SORTIN DD DSN=FMNUSER.EXTRACT.DJ2E,DISP=SHR
000010 //SORTOUT DD DSN=&&FMN1XTSD,
000011 //          LIKE=FMNUSER.EXTRACT.DJ2E,
000012 //          UNIT=SYSALLDA,
000013 //          DISP=(NEW,PASS)
000014 //SORTWK01 DD UNIT=SYSALLDA,
000015 //          SPACE=(CYL,(10,10)),
000016 //          DISP=(NEW,DELETE,DELETE)
000017 //SORTWK02 DD UNIT=SYSALLDA,

Command ==>
F1=Help      F2=Split    F3=Exit     F5=Rfind    F6=Rchange  Scroll PAGE
F8=Down     F9=Swap     F10=Left   F11=Right   F12=Cancel  F7=Up

```

Child panels

- None.

Key Specification panel

The Key Specification panel provides an alternative to the Database Positioning panel for specifying the position in the database at which you want to start editing.

This panel is displayed when:

- You enter **k** in the **Cmd** field of a segment type on the Database Positioning panel.
- You enter **k** in the **Cmd** field of a segment occurrence on the IMS data panel.
- You enter the KEY primary command on the IMS data panel.

You use this panel to specify the key of the segment type you have implicitly or explicitly selected.

Enter a key field value and relational operator to specify the starting point for a Database Browse or Database Edit.

Panel and field definitions

Figure 76. Key Specification panel

Process	Options	Help			
FM/IMS Edit : Key Specification					
Subsystem IF52 Database DJ1E					
Segment LINKSUB					
Lvl	Segment	Key field name	Type	RO	Key value
1	SHIRE			=	
	#2	2 SHIRE-KEY	AN		
	#3	3 SHIRE-NAME	AN		BROOME
2	LINKSUB			=	
	#1	1 SHIRE-SUBURB	AN		
	#2	2 SHIRE-SUB-KEY	AN		
**** End of data ****					
Command ==>					
F1=Help		F2=Split	F3=Exit	F4=CRetrieve	F7=Backward
F9=Swap		F10=Actions	F12=Cancel	Scroll PAGE F8=Forward	

Panel heading

Subsystem

The subsystem ID you specified on the Edit or Browse Entry panel.

Database

The name specified on the DBD statement in the DBDGEN for the database.

Segment

The name of the segment selected from the previous panel and the segment description if available.

Data area

Lvl

The level of the segment type in the database.

Segment

The name of the segments in the path down to the selected segment. This column also includes reference numbers for the key fields in each segment.

Key field name

The name of the key field if you are using a view and FM/IMS can match a layout to the key field. Otherwise, the database field name is displayed.

Type

The data type of the field:

AN

Alphanumeric

AX

Alphanumeric displayed in long hexadecimal.

BI

Binary

BT

Bit string decimal (external decimal)

FP

Floating point (internal or external)

PD

Packed decimal (internal decimal)

VB

Varying-length (VARYING) bit string

VC

Varying-length (VARYING) character string

VG

Varying-length (VARYING) graphic string

ZC

Null-terminated varying-length (VARYINGZ) character string

ZD

Zoned decimal (external decimal)

ZE

Zoned decimal edited

ZG

Null-terminated varying-length (VARYINGZ) graphic string

U

Unformatted

The field type is unformatted if you are not using a view or if FM/IMS cannot match a layout to key fields.

RO

The relational operator. Possible values are:

> or GT

Greater than.

>=, => or GE

Greater than or equal to.

= or EQ

Equal to.

< or LT

Less than.

<=, => or LE

Less than or equal to.

!=, =- or NE

Not equal to.

UQ

FM/IMS uses an unqualified SSA at this level (if the **Key value** field does contain a value, it is ignored).

Key value

You enter the value of the key field. FM/IMS starts the display from the first segment occurrence that matches the expression formed by the relational operator and the key value.



Note: The function used from this panel is Get Unique. As such, accessing a (P)HDAM database with a relational operator of '>' or '<' may not always give the expected result."

Parent panels

- When '**KEY**' command is issued on the [IMS data panel on page 309](#):
 - [Database Positioning panel on page 239](#)

Child panels

- [IMS data panel on page 309](#)

Load Entry panel

The Load Entry Panel is the first panel in the Load dialog. It is displayed when you select option 4 (Load) on the Utility Menu panel.

Panel and field definitions

Figure 77. Load Entry panel

Process	Options	Help
FM/IMS	Load Entry Panel	
IMS:		
Subsystem name . . .	<u>IF52</u>	PSB name . . . <u>LA19D</u> (If static PSB)
Database name . . .	<u>DJ1E</u>	AGN name . . . _____ (If BMP)
Processing Options:		
PSB type	Region type	Fetch DB dsnames from (if DLI)
<u>1</u> 1. Dynamic	<u>1</u> 1. DLI	<u>1</u> 1. User profile
2. Static	2. BMP	2. DFSMDA members
Load type	Enter "/" to select option	
- 1. No replace	- Skip DB data set panel (if DLI)	
2. Replace	- Do not override insert rules	
3. Initial		
Command ==>		
F1=Help	F2=Split	F3=Exit
F9=Swap	F10=Actions	F12=Cancel
	F4=CRetriev	F7=Backward
		F8=Forward

IMS

Subsystem name

The ID of the IMS subsystem that the databases you want to load are defined in. FM/IMS searches the FM/IMS installation options module for the subsystem with the specified name. If you enter either no subsystem name or a subsystem name pattern, the Subsystem Selection panel is displayed. You can select a subsystem from the list of subsystems displayed on that panel.

PSB name

If you select "Static" for **PSB type**, specify the name of the PSB that you want the Load to use. The PSB that you specify must have a PCB for all the databases you want to load.

FM/IMS searches either an IMS catalog or PSB libraries for a PSB with the specified name. Which of these two sources is searched depends on whether or not the selected subsystem uses IMS-managed ACBs.

If the selected subsystem uses IMS-managed ACBs, then FM/IMS searches the IMS catalog that the subsystem uses.

Otherwise, FM/IMS searches user- or administrator-specified PSB libraries. The libraries that are searched depend on which subsystem you select, so they are called the PSB libraries for the selected subsystem.

The PSB libraries for the selected subsystem are displayed on the PSB and DBD Data Sets panel and may or may not be fixed by the FM/IMS administrator.

If the PSB libraries for the subsystem are fixed, the PSB Data set name fields on the PSB and DBD Data Sets panel are protected and you must use the PSB libraries that the administrator has specified. Otherwise, these fields are not protected and you are free to modify the list of PSB libraries that FM/IMS searches.

FM/IMS searches the PSB libraries in the order in which they are specified and uses the first PSB it finds with the specified name.

If you do not enter a PSB name or if you enter a PSB name pattern, the PSB Selection panel is displayed. You can select a PSB from the list of PSBs displayed on that panel.



Note: If you select "Dynamic" for **PSB type**, this field is ignored.

Database name

The name of the primary database of the Load.

FM/IMS searches either an IMS catalog or DBD libraries for a DBD with the specified name. Which of these two sources is searched depends on whether or not the selected subsystem uses IMS-managed ACBs.

If the selected subsystem uses IMS-managed ACBs, then FM/IMS searches the IMS catalog that the subsystem uses.

Otherwise, FM/IMS searches user- or administrator-specified DBD libraries. The libraries that are searched depend on which subsystem you select, so they are called the DBD libraries for the selected subsystem.

The DBD libraries for the selected subsystem are displayed on the PSB and DBD Data Sets panel and may or may not be fixed by the FM/IMS administrator.

If the DBD libraries for the subsystem are fixed, the DBD Data set name fields on the PSB and DBD Data Sets panel are protected and you must use the DBD libraries that the administrator has specified. Otherwise, these fields are not protected and you are free to modify the list of DBD libraries that FM/IMS searches.

FM/IMS searches the DBD libraries in the order in which they are specified and uses the first DBD it finds with the specified name.

The following applies to when you select "Dynamic" for **PSB type**:

- If you enter either no database name or a database name pattern, the Database Selection panel is displayed. You can select a database from the list of databases displayed on that panel.
- If the selected subsystem does not use IMS-managed ACBs, then IMS requires these DBDs to be in at least one of the specified DBD libraries:

- The DBD for the primary database of the Load.
- The DBD for each database that is logically related to the primary database of the Load.

The following applies to when you select "Static" for **PSB type**:

- The PCB Selection panel is displayed when any one of these is true:
 - You enter no database name and there is more than one database PCB in the specified PSB.
 - You enter a database name and there is more than one PCB for the database in the PSB.
 - You enter a database name pattern and the PSB has PCBs for databases with names that match the pattern.

You can select a PCB from the list of database PCBs that is displayed on the PCB Selection panel.

- If the subsystem does not use IMS-managed ACBs, then IMS requires these DBDs to be in at least one of the specified DBD libraries:
 - The DBD for each database that is specified in the PSB.
 - The DBD for each database that is logically related to a database specified in the PSB.

AGN name

The Application Group Name (AGN) identifies a group of IMS resources. The name you specify is passed to the IMS region controller when you select BMP for the Region type.

If you select a subsystem that does not use AGNs, no AGN name should be entered.

If you select a subsystem that uses AGNs, specify an AGN that provides you with the access the Load requires and that you have authority to use. (The BMP region that FM/IMS starts is only authorized to use the IMS resources that are associated with the specified AGN.)

The AGN Selection panel is displayed when all these conditions are true:

- A BMP region type is selected.
- The selected subsystem uses AGNs.
- AGNs for the selected subsystem are listed in the FM/IMS installation options module.
- Either no AGN name is entered or an AGN name pattern is entered and there are AGNs for the selected subsystem in the FM/IMS installation options module that match the pattern.

You can select an AGN from the list of AGNs that is displayed on the AGN Selection panel. If AGNs for the selected subsystem are not listed in the FM/IMS installation options module, you must specify the full name of the AGN.



Note: This field is ignored when you select DLI for the Region type.

PSB type

The type of PSB that the Load uses to access the databases:

1. Dynamic

The Load uses a temporary PSB that it generates at the start of the batch job.

2. Static

The Load uses an existing PSB you specify in the PSB name field.

Region type

The type of region that you want the Load to run in:

1. DLI

For a DL/I batch processing region. You can use a DL/I batch processing region when the database is offline or there is data sharing support.

2. BMP

For a BMP region. You can use a BMP region when the database is online.

Fetch DB dsnames from (if DLI)

If you select "DLI" for **Region type**, a database that is not a HALDB, and an IMS subsystem that is not a dynamic allocation only subsystem:

1. User profile

Load uses the database data sets whose names are saved in your user profile.

2. DFSMDA members

Load uses the database data sets specified in the DFSMDA dynamic allocation members.



Note: This field is ignored when you specify any one of these:

- "BMP" for **Region type**.
- A database that is a HALDB.
- An IMS subsystem that is defined as dynamic allocation only in the FM/IMS installation option module.

Load type

1. No replace

The Load does not replace existing segments in the database. If you select this option, the Load only attempts to insert the segment. If the Insert call receives an II status code, the Load does not replace the existing segment in the database with the load segment.

2. Replace

The Load replaces existing segments in the database. If you select this option, the Load attempts to insert the segment as it does when option 1 is selected. However, if the Insert call receives an II status code, the Load replaces the existing segment in the database with the load segment.



Note: If a segment has a non-unique key or no key, existing segments in the database are not replaced. The load segments will be inserted even when there is an existing segment in the database with the same key.

3. Initial

Segments are loaded into a database using a load PSB (PROCOPT=L). Use this option for an initial load of a database. This option is only available when you select "Dynamic" for **PSB type** and "DLI" for **Region type**.

Skip DB data set panel (if DLI)

Select this option if you do not want FM/IMS to display the Database Data Set Specification or the Database Data Set Display panel.

If this option is not selected and you select "DLI" for **Region type**, the Database Data Set Specification or the Database Data Set Display panel is displayed.



Note: This field is ignored when you select "BMP" for **Region type**.

Do not override insert rules

Select this option if some of the segments you are loading have an insert rule of FIRST or HERE and you do not want the Load to override these insert rules. If you select this option, segments with no key or a non unique key are inserted according to the insert rule for the segment type.

If this option is not selected, segments with no key or a non unique key are inserted as the last occurrence - this is irrespective of the insert rule for the segment type.



Note: If you are using the Extract (IXB) and Load (ILB) to extract data from one database and load it into another, and you want the twin segments in the loaded database to be in the same sequence as they were in the extracted database, then do not select this option.

Parent panels

- [Utility Menu panel on page 425](#)

Child panels

- [AGN Selection panel on page 193](#)
- [Database Data Set Display panel on page 234](#)
- [Database Data Set Specification panel on page 236](#)
- [PCB Selection panel on page 343](#)
- [PSB Selection panel on page 361](#)
- [Subsystem Selection panel on page 401](#)
- [Database Selection panel on page 242](#)
- [Initial Load Options panel on page 317](#)
- [Load Options panel on page 341](#)

Load Options panel

Panel and field definitions

Figure 78. Load Options panel

Process	Options	Help
FM/IMS	Load Options	
Load From:		
Data set name . . .	_____	
Volume serial . . .	_____	(If not cataloged)
Device type	_____	(Generic unit or device address)
Command ==> _____		
F1=Help	F2=Split	F3=Exit
F9=Swap	F10=Actions	F12=Cancel
	F4=CRetriev	F7=Backward
		F8=Forward

Load from

Identifies the data set containing the data to be loaded into an IMS database.

Data set name

The name of the sequential data set that contains the data that you want loaded into your databases.

Volume serial

If the Load From data set is not cataloged, the volume on which it resides.

Device type

The device type of the volume that contains the Load From data set.

Parent panels

- [Database Data Set Display panel on page 234](#)
- [Database Data Set Specification panel on page 236](#)
- [Load Entry panel on page 335](#)

Child panels

- [JCL Submission panel on page 331](#)

Related topics and examples

- [Loading data on page 172](#)

Logical Relationship Information panel

The RELATED command provides information about the logical relationships that are defined for the current database.

Panel and field definitions

Figure 79. Logical Relationship Information panel

<u>P</u> rocess	<u>O</u> ptions	<u>H</u> elp						
FM/IMS		Logical Relationship Information						
Database	Segment	Related Database	Related Segment	Key Start	Length	I D R Rules	Relationship	
DJ1E	SHIRE			1	20	LLL, LAST		
	SHIRENP					LLL, LAST		
DJ2E	LINKSUB	DJ2E	INSHIRE	1	18		VIRT LOG CHILD	
	SUBURB			1	18	LLL, LAST		
	LINKSTR	DJ3E	INSUB	1	28		VIRT LOG CHILD	
	NSTREET			1	30	LLL, LAST		
	INSHIRE	DJ1E	LINKSUB	1	20	LLL, LAST	REAL LOG CHILD	
	LETRBOX			1	4	LLL, LAST		
Command ==>							Scroll <u>C</u> SR	
F1=Help	F2=Split	F3=Exit	F4=CRetriev	F7=Backward	F8=Forward			
F9=Swap	F10=Actions	F12=Cancel						

Database

The name of the current database and, when the current database is a physical database, the names of the logically related databases.

Segment

The names of the segments in the listed databases.

Related Database

The name of the database containing the related segment (see below).

Related Segment

For physical databases, the name of the logical parent of the segment. This field is blank if the segment is not a logical child.

For logical databases, the names of the physical segments that comprise the logical segment. For concatenated segments, two segment names are listed. A 'K' appearing after the segment indicates that the KEY operand was specified on the SOURCE= parameter of the SEGM statement. The absence of a 'K' indicates that the DATA operand was specified.

Key Start

The starting position of the segment's key field.

Key Length

The length of the segment's key field.

IDR Rules

The insert, delete and replace rules for the segment. FIRST, HERE and LAST indicate the insert position rules.

Relationship

Whether the segment is a real logical child or a virtual logical child.

REAL LOG CHILD

real logical child segment

VIRT LOG CHILD

virtual logical child segment

Parent panels

- Refer to [RELATED primary command on page 486](#).

Child panels

- None.

PCB Selection panel

The PCB Selection panel is displayed when, on a function's entry panel, you specify:

- "Static" for **PSB type**.
- One of these:

Processing OPTS

The processing options specified on the PSBGEN PCB statement.

Processing SEQ

The processing sequence (secondary index) that the PCB uses (blank if the PCB does not use a secondary index).

Usability note

If the function cannot use the PCB, this field gives the reason why it cannot be used. If the function can use the PCB, this field is left blank.

Reasons include:

Invalid PROCOPT

The function cannot be performed with the PCB's processing options.

LIST=NO PCB

PCB specifies LIST=NO - FM/IMS does not support PCBs that specify LIST=NO.

Read-only PCB

PCB is read-only - The function cannot be performed with a read-only PCB.

Non-insert PCB

PCB does not allow you to insert segments. The function cannot be performed with a PCB that does not allow segment insertion.

Non-replace PCB

PCB does not allow you to replace segments. The function cannot be performed with a PCB that does not allow segment replace.

No index edit

PCB is for an index database - Edit of an index database is not supported.

No HSAM edit

PCB is for an HSAM database - Edit of an HSAM database is not supported.

No SHSAM edit

PCB is for an SHSAM database - Edit of an SHSAM database is not supported.

No trm MSDB edit

PCB is for a terminal-related MSDB - Edit of a terminal-related MSDB is not supported.

No logical load

PCB is for a logical database - Load of a logical database is not supported.

No index load

PCB is for an index database - Load of an index database is not supported.

No alt seq load

PCB specifies an alternate processing sequence - Load using an alternate processing sequence is not supported.

To select a PCB, type `3` in the **Cmd** field and press Enter.

The **Cmd** field is protected when the function cannot use the PCB.

Parent panels

- [Batch Browse Entry panel on page 195](#)
- [Batch Edit Entry panel on page 201](#)
- [Browse Entry panel on page 214 \(Static PSB\)](#)
- [Edit Entry panel on page 266 \(Static PSB\)](#)
- [Extract Entry panel on page 275](#)
- [Load Entry panel on page 335](#)
- [Print Entry panel on page 351](#)

Child panels

- [Batch Browse Options panel on page 201](#)
- [Batch Edit Entry panel on page 201](#)
- [Database Data Set Display panel on page 234](#)
- [Database Data Set Specification panel on page 236](#)
- [Database Positioning panel on page 239](#)
- [Load Options panel on page 341](#)

Primary Option menu

FM/IMS menus and panels work the same way as ISPF. You navigate through the panels exactly as in ISPF.

The Primary Option menu is the first screen displayed when you enter FM/IMS. To leave it you select '**X**' (for eXit).

The '=' (equal sign) interprets your menu selection as if you were at the Primary Option menu, regardless of where you are within FM/IMS. So if you are in the Batch Edit Entry Panel (option 3.6), and you enter '=0.5' on the command line, then FM/IMS displays the Editor Options panel. And if you are browsing a data set (option 1), and you enter '=0.5', FM/IMS still displays the Editor Options panel. In particular, you can exit FM/IMS from anywhere within FM/IMS by entering '=X'.

Panel and field definitions

Figure 81. Primary Option menu

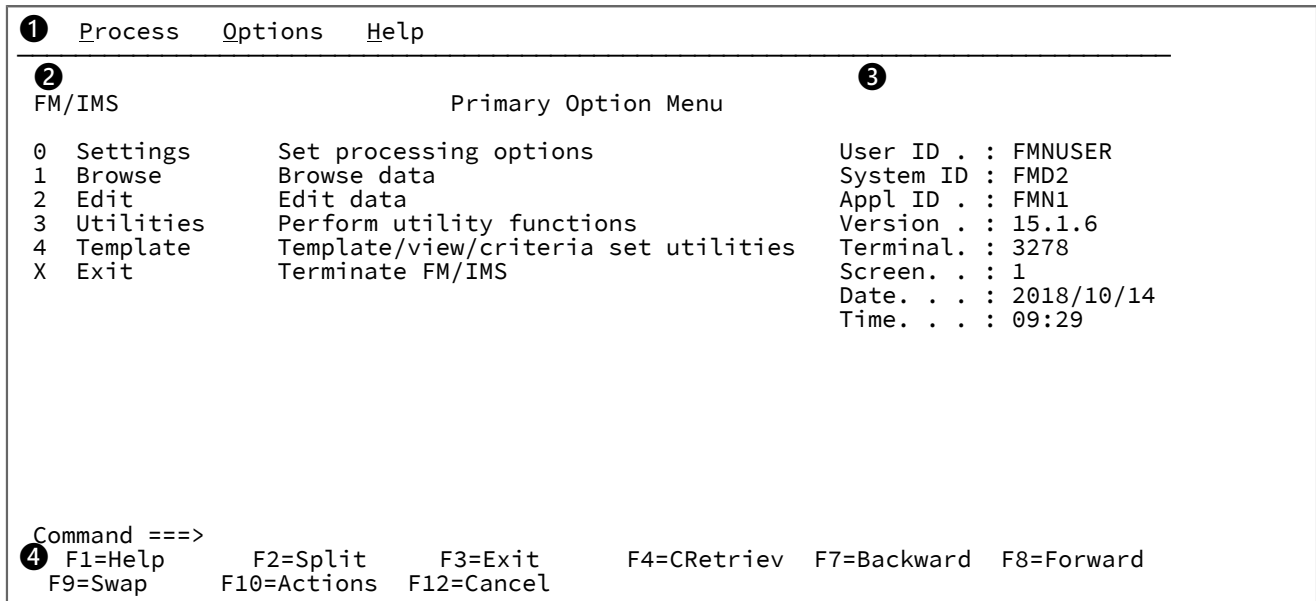

1 Action bar

The Action Bar contains a number of pull-down menus. These menus are available throughout FM/IMS. See [Action bar pull-down menus on page 347](#) for details.

2 Primary options

Lists the primary options available within FM/IMS. Selecting an option displays an Entry panel or a menu for the associated function.

3 Status area

Displays your session information.

4 Function keys

Lists the Function Keys that are active within the current panel.

Action bar pull-down menus

The Action Bar contains a number of pull-down menus. These menus are available throughout FM/IMS.

Process

The Process pull-down menu lists the processes available on your current panel. These options may change, depending upon which panel is being viewed.

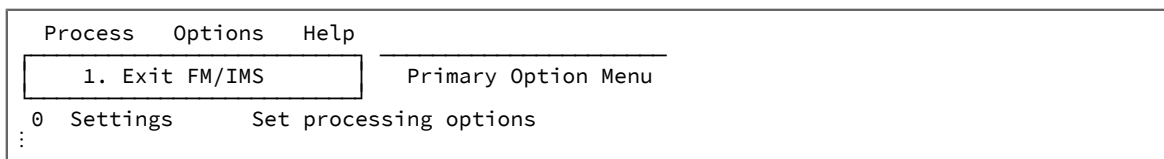

Options

The Options pull-down menu lists the choices available from the Settings menu, as well as providing access to the ISPF Settings panel.

See the *ISPF User's Guide Volume 1* for details about the ISPF Settings panel.

Process	Options	Help
FM/IMS	<ul style="list-style-type: none"> — 1. Print settings 2. System settings 3. Job card specifications 4. Compiler language selection 5. COBOL compiler specifications 6. HLASM compiler specifications 7. PL/I compiler specifications 8. Editor options 9. IMS subsystem settings 10. Temporary Data Set Allocations 11. Output Data Set Allocations 12. Trace options 13. ISPF settings 	<hr/> <pre> User ID . . : JHELVON System ID : FMD2 Appl ID . . : FMN1 Version . . : 15.1.6 Terminal. . : 3278 Screen. . . : 1 Date. . . . : 2013/10/14 Time. . . . : 09:35 </pre>
0	Setti	
1	Brows	
2	Edit	
3	Utili	
4	Templ	
X	Exit	

ies

Command ==>>
 F1=Help F2=Split F3=Exit F4=CRetriev F7=Backward F8=Forward
 F9=Swap F10=Actions F12=Cancel

Help

The Help pull-down menu lists the various ways in which you can enter the Tutorial Help system, as well as providing access to more FM/IMS information.

Process	Options	Help
FM/IMS	<ul style="list-style-type: none"> 1. Help for help... 2. Extended help... 3. Keys help... 4. Help index... 5. Tutorial... 6. About... 7. News about FM/IMS... 	<hr/> <pre> User ID . . : FMNUSER System ID : FMD2 Appl ID . . : FMN1 Version . . : 15.1.6 Terminal. . : 3278 Screen. . . : 1 Date. . . . : 2018/10/14 Time. . . . : 11:55 </pre>
0	Settings	S
1	Browse	B
2	Edit	E
3	Utilities	P
4	Templates	T
X	Exit	T

ies

Command ==>>
 F1=Help F2=Split F3=Exit F4=CRetriev F7=Backward F8=Forward
 F9=Swap F10=Actions F12=Cancel

1. Help for help

Displays the Help panel for the Tutorial Help system.

2. Extended help

Displays the Tutorial Help panel associated with the current FM/IMS panel (equivalent to pressing F1 from the FM/IMS panel). When on the Primary Options menu, this is the Tutorial Help Table of Contents panel.

3. Keys help

Displays help for the Function Keys that are active on the current FM/IMS panel.

4. Field help

Displays the field help.

5. Tutorial

Displays the Tutorial Help Table of Contents panel.

6. About

Displays the FM/IMS version and release information in a pop-up window.

7. News about FM/IMS

Displays general information about the current FM/IMS release.

Parent panels

ISPF Primary Option menu. See *z/OS ISPF User's Guide Vol 1*.

Child panels

- [Browse Entry panel on page 214](#)
- [Edit Entry panel on page 266](#)
- [Utility Menu panel on page 425](#)
- [Settings Menu panel on page 397](#)
- [Template/View/Criteria Set Menu panel on page 423](#)

Print Audit Trail panel

The Print Audit Trail panel is displayed when you select option 8 (Audit trail) on the Utility Menu.

It is used to produce an audit trail report or to generate the JCL for a job that produces an audit trail report.

Panel and field definitions

Figure 82. Print Audit Trail panel

```

Process  Options  Help
-----
FM/IMS                                     Print Audit Trail

Audit Trail:
  Data set name . . . 'FMNUSER.IMSAUDIT.D020927.T130548'
  Description . . . . 'EDIT THE SUBURB DATABASE'

Processing Options:
  Enter "/" to select option                Formatted display options
  / Formatted print                         2 1. Hex Format
  / Print only changed fields               - 2. Non-display Hex
  / Delete data set after printing          - Highlight changes
  / Browse report                           - Show key fields
  / Batch execution                         - Show committed updates only

Command ==>
F1=Help      F2=Split      F3=Exit      F4=CRetriev  F7=Backward  F8=Forward
F9=Swap      F10=Actions   F12=Cancel
    
```

Audit Trail

Data set name

This is the name of the data set that contains the audit trail that you want reported. This data set may have been created by a File Manager/IMS function or you may have to create it yourself by running a job that extracts FM/IMS audit log records from the SMF log data set. A sample job FMNSMFX is provided to help you do this. See the *Customization Guide* for more details.

Description

The audit trail description that is displayed at the beginning of the audit trail report. If the description contains embedded spaces it must be enclosed in quotation marks.

Processing Options

Enter "/" to select option

Formatted print

If you select this option, and the audit trail data set includes a template record, then the IMS segment data printed in the report is formatted according to the template.

If you do not select this option, or the audit log data set does not include a template record, then the IMS segment data printed in the report is not formatted.

Print only Changed Fields

If you select this option and the Formatted print option then, for IMS segments that are updated, only the fields that have changed are printed. If you do not select this option, then before and after images of all the fields are printed, irrespective of whether they have changed or not.



Note: FM/IMS always prints all the fields of inserted and deleted segments.

Delete data set after Printing

To delete the Audit Trail data set after the report has been produced.

Browse report

For foreground execution only, to automatically display the audit report after it has been produced.

Batch execution

To generate JCL for a job that produces the audit trail report.

Hex Format

To produce an UPDOWN hexadecimal display below the standard field display.

Non-display Hex

To produce an UPDOWN hexadecimal display below the standard field display only for fields that contain non-displayable \ characters.

Highlight changes

Highlight the changed fields. An asterisk is placed to left of the before data to indicate the field has been changed.

Show key fields

To display key fields even when **Print only changed fields** is selected. A "K" is printed to the left of key field names.

Show committed updates only

Select this option if you only want the committed updates to be reported. If this option is not selected, all the audit events in the audit log are reported. For an update function, checkpoints, rollbacks, and both committed and uncommitted database updates (inserts, deletes, and replaces) alike are reported. If this option is selected, FM/IMS only reports the database updates (inserts, deletes, and replaces) that were committed.

Parent panels

- [Utility Menu panel on page 425](#)

Child panels

- [JCL Submission panel on page 331](#)

Print Entry panel

The Print Entry Panel is the first panel in the Print dialog. It is displayed when you select option 5 (Print) on the Utility Menu panel.

Panel and field definitions

Figure 83. Print Entry panel

Process	Options	Help
FM/IMS		
Print Entry Panel		
IMS:		
Subsystem name . . .	<u>I</u> F52	PSB name . . . <u>L</u> A19D (If static PSB)
Database name . . .	<u>D</u> J1E	AGN name . . . _____ (If BMP)
View:		
Data set name . . .	_____	
Member	_____	
Processing Options:		
PSB type	Region type	Fetch DB dsnames from (if DLI)
<u>1</u> 1. Dynamic	<u>1</u> 1. DLI	<u>1</u> 1. User profile
2. Static	2. BMP	2. DFSMDA members
View usage	Print format	Enter "/" to select option
<u>3</u> 1. New	<u>-</u> 1. CHAR	<u>/</u> Skip DB data set panel (if DLI)
2. Existing	2. HEX	Edit view
3. None	3. SNGL	<u>-</u> Use key values
	4. TABL	
Command ==> _____ Scroll PAGE		
F1=Help	F2=Split	F3=Exit
F9=Swap	F10=Actions	F12=Cancel
	F4=CRetrieiv	F7=Backward
		F8=Forward

IMS

Subsystem name

The ID of the IMS subsystem that the database you want to print is defined in. FM/IMS searches the FM/IMS installation options module for the subsystem with the specified name. If you enter either no subsystem name or a subsystem name pattern, the Subsystem Selection panel is displayed. You can select a subsystem from the list of subsystems displayed on that panel.

PSB name

If you select "Static" for **PSB type**, specify the name of the PSB that you want the Print to use. The PSB that you specify must have a PCB for the database you want to print.

FM/IMS searches either an IMS catalog or PSB libraries for a PSB with the specified name. Which of these two sources is searched depends on whether or not the selected subsystem uses IMS-managed ACBs.

If the selected subsystem uses IMS-managed ACBs, then FM/IMS searches the IMS catalog that the subsystem uses.

Otherwise, FM/IMS searches user- or administrator-specified PSB libraries. The libraries that are searched depend on which subsystem you select, so they are called the PSB libraries for the selected subsystem.

The PSB libraries for the selected subsystem are displayed on the PSB and DBD Data Sets panel and may or may not be fixed by the FM/IMS administrator.

If the PSB libraries for the subsystem are fixed, the PSB Data set name fields on the PSB and DBD Data Sets panel are protected and you must use the PSB libraries that the administrator has specified. Otherwise, these fields are not protected and you are free to modify the list of PSB libraries that FM/IMS searches.

FM/IMS searches the PSB libraries in the order in which they are specified and uses the first PSB it finds with the specified name.

If you do not enter a PSB name or if you enter a PSB name pattern, the PSB Selection panel is displayed. You can select a PSB from the list of PSBs displayed on that panel.



Note: If you select "Dynamic" for **PSB type**, this field is ignored.

Database name

The name of the database that you want to print.

FM/IMS searches either an IMS catalog or DBD libraries for a DBD with the specified name. Which of these two sources is searched depends on whether or not the selected subsystem uses IMS-managed ACBs.

If the selected subsystem uses IMS-managed ACBs, then FM/IMS searches the IMS catalog that the subsystem uses.

Otherwise, FM/IMS searches user- or administrator-specified DBD libraries. The libraries that are searched depend on which subsystem you select, so they are called the DBD libraries for the selected subsystem.

The DBD libraries for the selected subsystem are displayed on the PSB and DBD Data Sets panel and may or may not be fixed by the FM/IMS administrator.

If the DBD libraries for the subsystem are fixed, the DBD Data set name fields on the PSB and DBD Data Sets panel are protected and you must use the DBD libraries that the administrator has specified. Otherwise, these fields are not protected and you are free to modify the list of DBD libraries that FM/IMS searches.

FM/IMS searches the DBD libraries in the order in which they are specified and uses the first DBD it finds with the specified name.

The following applies to when you select "Dynamic?" for **PSB type**:

- If you enter either no database name or a database name pattern, the Database Selection panel is displayed. You can select a database from the list of databases displayed on that panel.
- If the selected subsystem does not use IMS-managed ACBs, then IMS requires these DBDs to be in at least one of the specified DBD libraries:

- The DBD for the database you want to print.
- The DBD for each database that is logically related to the database you want to print.

The following applies to when you select "Static?" for **PSB type**:

- The PCB Selection panel is displayed when any one of these is true:
 - You enter no database name and there is more than one database PCB in the specified PSB.
 - You enter a database name and there is more than one PCB for the database in the PSB.
 - You enter a database name pattern and the PSB has PCBs for databases with names that match the pattern.

You can select a PCB from the list of database PCBs that is displayed on the PCB Selection panel.

- If the subsystem does not use IMS-managed ACBs, then IMS requires these DBDs to be in at least one of the specified DBD libraries:
 - The DBD for each database that is specified in the PSB.
 - The DBD for each database that is logically related to a database specified in the PSB.

AGN name

The Application Group Name (AGN) identifies a group of IMS resources. The name you specify is passed to the IMS region controller when you select BMP for the Region type.

If you select a subsystem that does not use AGNs, no AGN name should be entered.



Note: This field is ignored when you select "DLI" for **Region type**.

If you select a subsystem that uses AGNs, specify an AGN that provides you with the access the Print requires and that you have authority to use. (The BMP region that FM/IMS starts is only authorized to use the IMS resources that are associated with the specified AGN.)

The AGN Selection panel is displayed when all these conditions are true:

- A BMP region type is selected.
- The selected subsystem uses AGNs.
- AGNs for the selected subsystem are listed in the FM/IMS installation options module.
- Either no AGN name is entered or an AGN name pattern is entered and there are AGNs for the selected subsystem in the FM/IMS installation options module that match the pattern.

You can select an AGN from the list of AGNs that is displayed on the AGN Selection panel. If AGNs for the selected subsystem are not listed in the FM/IMS installation options module, you must specify the full name of the AGN.



Note: This field is ignored when you select DLI for the Region type.

View

Data set name

If you select "Existing" for the **View usage**, this is the name of the data set that contains the view that you want the Print to use.



Note: If you select "New" or "None" for **View usage**, this field is ignored.

Member

If you select "Existing" for **View usage**, then:

- If the view that you want the Print to use is in a PDS(E), specify the view member name in this field.
- If the view that you want the Print to use is in a sequential data set, blank out this field.



Note: If you select "New" or "None" for **View usage**, this field is ignored.

PSB type

The type of PSB that the Print uses to access the database:

1. Dynamic

The Print uses a temporary PSB that it generates at the start of the batch job.

2. Static

The Print uses an existing PSB you specify in the **PSB name** field.

Region type

The type of region that you want the Print to run in:

1. DLI

For a DL/I batch processing region. You can use a DL/I batch processing region when the database is offline or there is data sharing support.

2. BMP

For a BMP region. You can use a BMP region when the database is online.

Fetch DB dsnames from (if DLI)

If you select "DLI" for **Region type**, a database that is not a HALDB, and an IMS subsystem that is not a dynamic allocation only subsystem:

1. User profile

Print uses the database data sets whose names are saved in your user profile.

2. DFSMDA members

Print uses the database data sets specified in the DFSMDA dynamic allocation members.



Note: This field is ignored when you specify any one of these:

- "BMP" for **Region type**.
- A database that is a HALDB.
- An IMS subsystem that is defined as dynamic allocation only in the FM/IMS installation option module.

View usage

Determines whether the Print uses a new view, an existing view, or no view:

1. New

Select this option when you want the Print to use a new view.

The Print creates a temporary view from a template for the specified database.

FM/IMS searches user or administrator-specified template libraries for the template. The template libraries that FM/IMS searches depends on which subsystem you select:

- If the template libraries for the specified subsystem are not fixed, FM/IMS searches the template libraries specified on the Template Data Sets panel.
- If the template libraries for the subsystem are fixed, FM/IMS searches the default template libraries for the subsystem (specified in the FM/IMS installation options module).

FM/IMS searches the template libraries in the order in which they are specified and uses the first template it finds with the specified database name.

2. Existing

Select this option when you want the Print to use an existing view. Print uses the view specified in the View **Data set name** and **Member** fields.

3. None

Select this option when you do not want the Print to use a view.

Print format

The format used for the printed data.

1. CHAR

The data is printed in character format.

2. HEX

The data is printed in hexadecimal format.

3. SNGL

The data is printed in single format.

4. TABL

The data is printed in table format.

Skip DB data set panel (if DLI)

Select this option if you do not want FM/IMS to display the Database Data Set Specification or the Database Data Set Display panel.

If this option is not selected and you select "DLI" for **Region type**, the Database Data Set Specification or the Database Data Set Display panel is displayed.



Note: This field is ignored when you select "BMP" for **Region type**.

Edit view

Select this option if you have selected "Existing" for **View usage** and you want to edit the view before the Print uses it.

If you select this option, FM/IMS starts the View dialog where you can edit and save the view specified in the View data set and member fields.



Note: This field is ignored when you select "New" or "None" for **View usage**.

Use key values

Select this option if you want to specify the key values of the root segments of the records that are to be printed.

If you select this option, the Print Options panel is displayed. You specify the name of the data set that contains the key values that you want the Print to use on that panel.

Parent panels

- [Utility Menu panel on page 425](#)

Child panels

- [AGN Selection panel on page 193](#)
- [Data Set Selection panel on page 233](#)
- [Database Data Set Display panel on page 234](#)
- [Database Data Set Specification panel on page 236](#)
- [PCB Selection panel on page 343](#)
- [PSB Selection panel on page 361](#)
- [Subsystem Selection panel on page 401](#)
- [Database Selection panel on page 242](#)
- [View Member Selection panel on page 428](#)
- [JCL Submission panel on page 331](#)
- [Print Options panel on page 358](#)

Print Options panel

The Print Options panel is displayed in the Print dialog when the **Use key values** option is selected on the Print Entry Panel.

On this panel, you specify:

- Whether or not you want to specify the key values of the root segments of the records that are to be printed.
- When you are specifying key values, the name of the data set that contains the key values that you want the Print to use.

Panel and field definitions

Figure 84. Print Options panel

```

Process  Options  Help
-----
File Manager                Print Options
Database NHRD#3
Key Values:
  Data set name . . . 'JHELVON.NHRD#3.KEYSLIST'
  Member . . . . .
Processing Options:
  Enter "/" to select option
  / Use key values

Command ==> _
F1=Help      F2=Split      F3=Exit      F7=Backward  F8=Forward  F9=Swap
F10=Actions  F12=Cancel
    
```

Data set name

If you have selected the Use key values option, specify the name of the data set that contains the key values of the root segments of the records that you want printed. Note: This field is ignored when the Use key values option is not selected.

Member

If you have selected the Use key values option and the key values that you want the Print to use are in a PDS(E), specify the Key Values member name. If you have selected the Use key values option and the key values that you want the Print to use are in a sequential data set, blank out this field.



Note: This field is ignored when the Use key values option is not selected.

Use key values

If you select this option, the Print uses the key values specified in the Key Values data set name and Member fields.

Parent panels

- [Print Entry panel on page 351](#)

Child panels

- None

PSB and DBD Data Sets panel

The PSB and DBD Data Sets panel allows you to view and modify the names of the PSB and DBD data sets used by the FM/IMS functions.

The panel is displayed when, on the Subsystem Settings Menu panel, you select:

- Option 7
- A subsystem that does not use IMS-managed ACBs.

The **Subsystem** field displays the IMS subsystem ID you specified on the Subsystem Settings Menu.

The panel displays the data set names that an online FM/IMS function uses when this IMS subsystem ID is specified on the function's Entry panel.

The FM/IMS administrator may have fixed the values of some or all of the data set names displayed on the panel. If a data set has been fixed, the panel field is protected and you cannot change the specified value.

If a data set has not been fixed, you can change the value that has been specified for it.

To reset all the data set names on the panel to their subsystem defaults, enter the RESET command.

To exit the panel saving the changes you have made, enter the EXIT command (F3).

To exit the panel without saving the changes you have made, enter the CANCEL command (F12).

Panel and field definitions

Figure 85. PSB and DBD Data Sets panel

Process	Options	Help
FM/IMS	PSB and DBD Data Sets	
Subsystem IF52 IF52 - DYNAMIC, all unprotect		
PSB:		
Data set name #1	'FMN.REGTEST.IMS.PSBLIB'	
Data set name #2	'FMN.REGTEST.IMS.RFM0712.PSBLIB\$1'	
Data set name #3	'FMN.REGTEST.IMS.RFM0712.PSBLIB\$2'	
Data set name #4	'FMN.REGTEST.IMS.RFM0712.PSBLIB\$3'	
Data set name #5		
Data set name #6		
DBD:		
Data set name #1	'FMN.REGTEST.IMS.DBDLIB'	
Data set name #2	'FMN.REGTEST.IMS.DBDLIB2'	
Data set name #3	'FMN.REGTEST.IMS.RFM0712.DBDLIB\$1'	
Data set name #4	'FMN.REGTEST.IMS.RFM0712.DBDLIB\$2'	
Data set name #5	'FMN.REGTEST.IMS.RFM0712.DBDLIB\$3'	
Data set name #6	'FMN.REGTEST.IMS.RFM0712.DBDLIB\$4'	
Command ==>		
F1=Help	F2=Split	F3=Exit
F9=Swap	F10=Actions	F12=Cancel
	F4=CRetriev	F7=Backward
	F8=Forward	

PSB

The names of the load libraries that contain the Program Specification Blocks (PSBs) that you want FM/IMS and IMS to use. When a File Manager/IMS function that uses a static PSB is run, the specified libraries are allocated to the IMS DD.

DBD

The names of the load libraries that contain the database definitions (DBDs) that you want FM/IMS and IMS to use. When a File Manager/IMS function is run, the specified libraries are allocated to the IMS DD.

When the FM/IMS function uses a dynamic PSB, IMS requires the following DBDs to be in at least one of the specified DBD libraries:

- The DBD for the database you want to access.
- The DBD for each database that is logically related to the database you want to access.

When the FM/IMS function uses a static PSB, IMS requires the following DBDs to be in at least one of the specified DBD libraries:

- The DBD for each database that is specified in the PSB.
- The DBD for each database that is logically related to a database specified in the PSB.

Parent panels

- [Subsystem Settings Menu panel on page 404](#)

Child panels

- [Data Set Selection panel on page 233](#)

PSB Selection panel

The PSB Selection panel is displayed when, on the Edit, Browse, Extract, Load, Print, Batch Edit or Batch Browse Entry panel, you specify:

- "Static" for **PSB type**.
- Either no PSB name or a PSB name pattern.

There are two versions of this panel. The version that is displayed depends on whether or not the subsystem you select on the entry panel uses IMS-managed ACBs. Each of these versions are discussed in turn.

Subsystem uses IMS-managed ACBs

If no PSB name is supplied, all the PSBs in the IMS catalog that the selected subsystem uses, are shown on the panel. If a PSB name pattern is supplied, all the PSBs in the IMS catalog with names that match the pattern are shown on the panel.

Panel and field definitions

Figure 86. PSB Selection panel

Process	Options	Help
FM/IMS		PSB Selection
Subsystem	IFG1	
Cmd	PSB name	Timestamp
	PAHRD#1	1524414432060
	PAHRD#2	1524414432060
	PAHRD#4	1524414432060
	PATRD#1	1524414432060
	PATRD#2	1524414432060
	PATRD#4	1524414432060
	PAUBD#1	1524414432060
	PAUBD#2	1524414432060
	PAUBD#4	1524414432060
	PA03D#1	1524414432060
	PA03D#2	1524414432060
	PA03DQ#1	1524414432060
	PA05D	1524414432060
	PA07D	1524414432060
Command ==>		Scroll PAGE
F1=Help	F2=Split	F3=Exit
F4=CRetrieve	F5=RFind	F7=Backward
F8=Forward	F9=Swap	F10=Left
F11=Right	F12=Cancel	

The panel displays the subsystem name you specified on the entry panel and these details for each PSB:

PSB name

The name of the PSB.

Timestamp

The timestamp of its ACB in the active ACB library.

To select a PSB, type **S** in the **Cmd** field and press Enter.

Subsystem does not use IMS-managed ACBs

If no PSB name is supplied, all the PSBs in the PSB libraries for the selected subsystem are shown on the panel. If a PSB name pattern is supplied, all the PSBs with names that match the pattern are shown on the panel.

Figure 87. PSB Selection panel

Process	Options	Help							Row 00001 of 00456
FM/IMS		PSB Selection							
DSNAME	FMN.REGTEST.IMS.PSBLIB								
Name	Prompt	Lib	Alias-of	Size	AC	AM	RM	Attributes	
*	*	*	*		*	*	*	*	
— \$PA19D#7		2		000002C8	00	24	24		
— \$PA21D#7		2		00000378	00	24	24		
— \$PA23D#7		3		00000300	00	24	24		
— \$PA34D#7		4		00000318	00	24	24		
— XYZ00001		1		000000E0	00	24	24		
— XYZ0041		1		00000360	00	24	24		
— GSAPSB		1		000009A8	00	24	24		
— JPSBL		1		00000100	00	24	24		
— LA19D		1		000000F8	00	24	24		
— LA23D#1		1		00000170	00	24	24		
— LA23D#2		1		00000170	00	24	24		
— LA24D#1		1		00000170	00	24	24		
— LA24D#2		1		00000170	00	24	24		
— LA34D		1		00000148	00	24	24		
— LA34D9		1		000000F8	00	24	24		
Command ===>								Scroll PAGE	
F1=Help	F2=Split	F3=Exit	F4=CRetriev	F5=RFind	F7=Backward				
F8=Forward	F9=Swap	F10=Left	F11=Right	F12=Cancel					

The panel displays the name and other attributes of each PSB.

To select a PSB, type **S** in the **Cmd** field and press Enter.

For a detailed description of the panel fields and functionality, see the description of the Member Selection panel in the *User's Guide and Reference*.

Parent panels

- [Batch Browse Entry panel on page 195](#)
- [Batch Edit Entry panel on page 201](#)
- [Browse Entry panel on page 214](#)
- [Edit Entry panel on page 266](#)
- [Extract Entry panel on page 275](#)
- [Load Entry panel on page 335](#)
- [Print Entry panel on page 351](#)

Record Type Selection panel

The Record Type Selection panel is displayed when on the Extract Options panel you select:

- "Foreground" for the **Template create execution mode**.
- The **Edit extract template** option.

It allows you to edit and then save the template that the Extract dialog creates for the Extract file.

For information on the panel fields and functionality, see the description for the Record Type Selection panel in the *User's Guide and Reference*.

Panel and field definitions

Figure 88. Record Type Selection panel

Process	Options	Help			
FM/IMS			Record Type Selection	Line 1 of 6	
Processing Option: _ Template for segmented data					
Cmd	SIE	Field Name	Prompt	Offset	Length
		**** Top of data ****			
___	SI	HEADER_DYNAMIC		0	57
___	SI	HEADER1_STATIC		0	84
___	SI	HEADER2_STATIC		0	72
___	SI	A05D_A05SEG1_A05D_ROOT_SEGM		0	95
___	SI	A05D_A05SEG2_A05D_LEV2_SEGM		0	102
___	SI	A05D_A05SEG3_A05D_LEV3_SEGM		0	79
		**** End of data ****			
Command ==>					
F1=Help	F2=Split	F3=Exit	F4=CRetriev	F5=RFind	Scroll PAGE
F7=Up	F8=Down	F9=Swap	F12=Cancel	F6=RunTemp	

Parent panels

- [Extract Options panel on page 282](#)

Child panels

- Field Selection/Edit panel. See *User's Guide and Reference* for details.

Redefines / Range Specifications panel

FM/IMS displays the Redefines / Range Specifications panel when you enter the X line command in the prefix command field (**Cmd**) against a segment type on the Template Specification panel.

Panel and field definitions

Figure 89. Redefines / Range Specifications panel

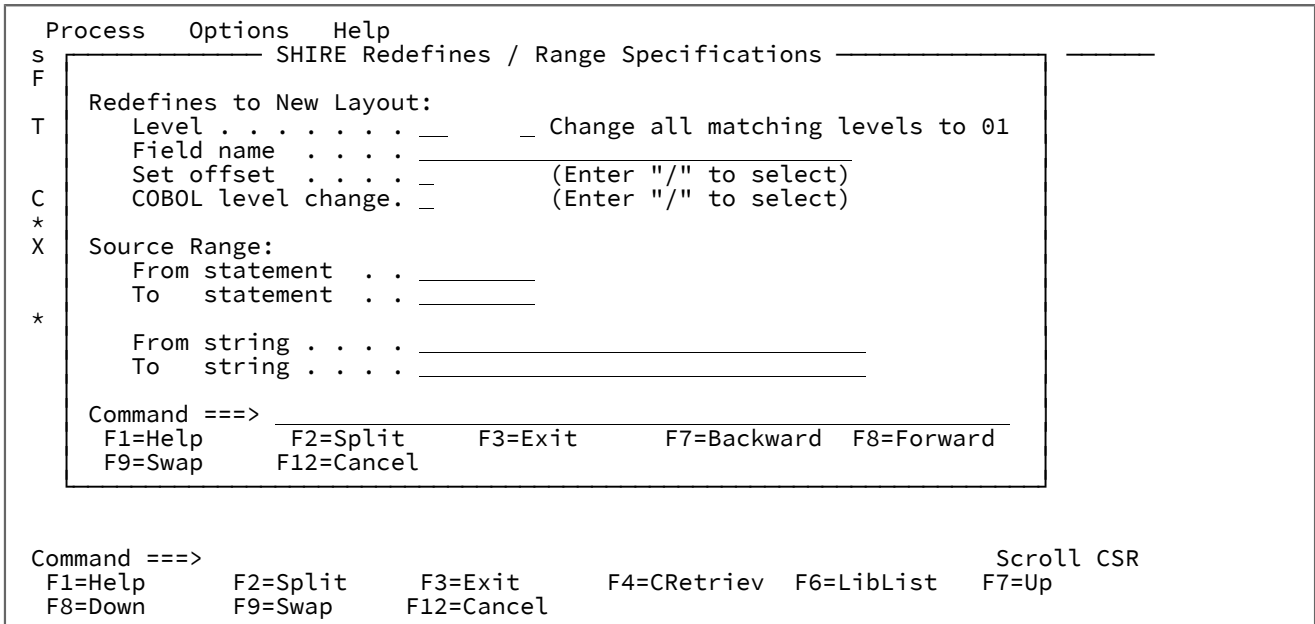

Redefines to New Layout

Use the following fields to direct FM/IMS to generate multiple record layouts for a source that contains many record definitions within one level-1 structure:

Level

Source level value used to identify REDEFINES or UNION-level clauses that are to generate new record layouts. This value is used when you have a structure that has defined multiple layouts using COBOL REDEFINES or PL/I unions. FM/IMS creates a separate record layout for each REDEFINES clause at the given level. After the first matching REDEFINES is found, FM/IMS creates new layouts for the latter and subsequent REDEFINES clauses for the same level and start location. Header and trailing data items are included in each record layout.

Change all matching levels to 01

As an alternative to specifying the source level (**Level**), you can select this option by typing a "/" to change all matching levels to 01. This changes the source before compile so that all matching levels are changed to 01. This is a COBOL only option and should be used with care as it can alter a structure from its intended programmable form.

Field name

Specifies the target field name of a REDEFINES clause or the field name with a UNION clause that is used to identify the REDEFINES or UNION statements that are to be used to direct FM/IMS to create new layouts. This is an alternative way of identifying REDEFINES and UNION statements that require new layouts to be generated. If you specify both **Level** and **Field Name** values, FM/IMS checks both when generating new layouts.

Set offset

When selected (by typing a "/"), FM/IMS adjusts the offset value for each layout so that the starting location is the REDEFINES or UNION field start location. Use this option when your record layouts do not include the header data items in the structure. You can only specify this option in conjunction with the previous fields.

COBOL level change**Source Range**

Specify the following fields to direct FM/IMS to extract a subset of the copybook to be compiled into the template:

From statement

Start source line number. This tells FM/IMS the starting statement for extract. If not specified, the default start location is statement 1.

To statement

End source line number. This tells FM/IMS the ending statement for extract. If not specified, the default end location is the last source statement.

From string

FM/IMS searches each source statement for the specified string and the first statement with a matching string starts the extract process. If you specify a "from statement", then the first statement that matches either the **From statement** value or contains the **From string** value begins the extract.

To string

FM/IMS searches each source statement for the specified string and the first statement with a matching string ends the extract process. If you specify a "to statement", then the first statement that matches either the **To statement** value or contains the **To string** value ends the extract.

Parent panels

- [Template Specification panel on page 412](#)

Child panels

- None.

Relationship Criteria panel

When you select the relationship criteria subset for editing, FM/IMS displays the Relationship Criteria panel: On this panel, you can exclude or limit the number of segment occurrences extracted from logically related databases.

Panel and field definitions

Figure 90. Relationship Criteria panel

Process	Options	Help						
FM/IMS		Relationship Criteria						
Criteria		FMN. IMS. IVP. CRITERIA (SUBURB)						
Template		FMN. IMS. IVP. TEMPLATE (DJ2E)						
Default max relationship occurrences to pursue		(Blank for no limit)						
Cmd	Sel	Source DBD	Source segment	Target DBD	Relationship type	Max occurrences to pursue per DB record		
*	*	DJ2E	LINKSTR	DJ3E	Bidirectional	2		
*	*	DJ2E	INSHIRE	DJ1E	Bidirectional	1		
		DJ3E	INSUB	DJ2E	Bidirectional	1		
		DJ1E	LINKSUB	DJ2E	Bidirectional	1		
**** End of data ****								
Command ==>		F1=Help		F2=Split	F3=Exit	F4=CRetriev	F6=Describe	Scroll CSR
		F8=Forward		F9=Swap	F10=Actions	F12=Cancel	F7=Backward	

This panel lists all the logical relationships that are defined for all of these databases:

- The primary database
- Databases that are linked to the primary database via logical relationships

For each relationship, the panel displays:

Criteria

Displays the name of the data set containing the criteria set that is being edited.

Template

Displays the name of the partitioned data set containing the template associated with this criteria set.

Default max relationship occurrences to pursue

Enter the maximum number of target database records you want selected per source database record. The value specified is used for any **Max occurrences to pursue per DB record** fields that are left blank.

Cmd

In the **Cmd** field for a relationship, enter **S** to toggle the selection of the relationship for processing. If you deselect a relationship, then none of the related segment occurrences are extracted.

Sel

Contains an asterisk (*) if the relationship is selected for processing. Otherwise, blank.

Source DBD

The DBD name of the database that contains the relationship's source (or child) segment.

Source segment

The logical relationship's child segment

Target DBD

The DBD name of the database that is the target (or parent) of the logical relationship.

Relationship type

Unidirectional - When the logical relationship links the source and target segments in one direction.

Bidirectional - When the logical relationship links the source and target segments in both directions, establishing a two-way path.

Max occurrences to pursue per DB record

Enter the maximum number of target database records you want selected per source database record. If you leave this field blank, then FM/IMS uses the value specified in the **Default max relationship occurrences to pursue** field.

Parent panels

- [Subset Selection panel on page 399](#)

Child panels

- None.

Secondary Index Selection panel

The Secondary Index Selection panel is displayed when, on the Browse or Edit Entry panel, you select:

- The **Secondary index** option
- "Dynamic" for **PSB type**.
- A database that has more than one secondary index.

This panel displays all the secondary indexes for the selected database.

Panel and field definitions

Figure 91. Edit : Secondary Index Selection panel

Process	Options	Help	
FM/IMS		Edit : Secondary Index Selection	
Subsystem IF32		Database FMDB1	
Cmd	Secondary index	Target segment	Source segment Search fields
	FMIX1	ROOTSEG	DEPSEGM SECURITY
	FMIX2	ROOTSEG	ROOTSEG LASTNAME
	FMIX3	ROOTSEG	DEPSEGM2 ENVIRON CLASS
	FMIX4	DEPSEGM	DEPSEGM DEPKEY
S	FMIX5	ROOTSEG	ROOTSEG TOPILSE NERIEN SNORE TTERE NBAAT
**** End of data ****			
Command ==>			
F1=Help	F2=Split	F3=Exit	F4=CRetrieval F7=Backward Scroll CSR
F9=Swap	F10=Actions	F12=Cancel	F8=Forward

Subsystem

The subsystem ID you specified on the Browse or Edit Entry panel.

Database

The name of the database you specified on the Browse or Edit Entry panel.

Cmd

The line command field.

Secondary index

The name of the secondary index.

Target segment

The segment that the index segment points to.

Source segment

The segment containing the source fields from which the index is constructed.

Search fields

The search fields of the secondary index.

A Fast Path secondary index (FPSI) may have multiple secondary index segments defined. When an FPSI has multiple secondary index segments, the search fields for each secondary index segment are displayed on separate lines.

Parent panels

- [Browse Entry panel on page 214](#)
- [Edit Entry panel on page 266](#)

Child panels

- [Database Data Set Specification panel on page 236](#)
- [Database Data Set Display panel on page 234](#)
- [Database Positioning panel on page 239](#)

Segment Information panel

This panel is displayed when you enter the SEGMENT primary command.

Panel and field definitions

Figure 92. Segment Information panel

<u>P</u> rocess	<u>O</u> ptions	<u>H</u> elp	
FM/IMS			Segment Information
Database		DJ1E	
Segment		SHIRE	
Description			
Number		1	
Parent			
Level		1	
Dataset Group		DJ1E	
Key Start		1	
Key Length		20	
Segment Length		53	FIXED
Processing Options		A	
Command ==>			Scroll <u>P</u> AGE
F1=Help	F2=Split	F3=Exit	F4=CRetriev F7=Backward F8=Forward
F9=Swap	F10=Actions	F12=Cancel	

FM/IMS displays these fields on the Segment Information panel:

Database

shows the name of the current database.

Segment

shows the name of the current segment.

Description

shows the description of the segment as entered on the Template Specification panel.

Number

shows the segment code which uniquely identifies the segment in the database.

Parent

shows the name of the segment which is the immediate parent of the current segment. This field is blank if the current segment is the root segment.

Level

shows the hierarchical level number of the segment in the database.

Data set Group

shows the ddname of the data set group where the segment is stored.

Key Start

shows the starting position of the segment's key field. This field is blank if the field is non-keyed.

Key Length

shows the length of the segment's key field. This field is blank if the field is non-keyed.

Segment Length

shows the segment length as defined in the DBD. FM/IMS displays the minimum and maximum lengths for variable length segments. The value **FIXED** or **VARIABLE** is displayed to indicate the format of the segment.

Processing Options

shows the IMS processing options for the segment for the browse/edit session.

On the Segment Information panel, you can press Enter to display the Field Information panel.

Parent panels

- Refer to [SEGMENT primary command on page 492](#)

Child panels

- [Field Information panel on page 300](#)

Segment Layout panel

The Segment Layout panel is used to edit the details of a selected segment layout in a Template, View or Criteria.

The panel is displayed when:

- You select a segment type for edit on the Database Positioning panel, Segment Selection panel, or Template Specification panel and the segment type has only one layout.
- You select a segment layout for edit on the Segment Layout Selection panel.

You can use the Template : Segment Layout panel to:

- Set the order of fields using a sequence number
- Specify expressions for layout identification
- Modify the offset value for a layout
- View and print the 01 layout

You can use the View : Segment Layout panel or Criteria : Segment Layout panel to:

- Select fields for display
- Edit field formatting and create attributes
- Specify expressions for layout identification
- Modify the offset value for a layout
- View and print the 01 layout

Panel and field definitions

Figure 93. Segment Layout panel

Process		Options		Help									
FM/IMS		Criteria : Segment Layout		Line 1 of 9									
Criteria New				Subset									
Template FMN. IMS. IVP. TEMPLATE(DJ1E)				Segment SHIRE									
----- Criteria - Enter 1 or 2 to view/specify expression by field -----													
1	Id :	#4='0'			+								
2	Sel:				+								
Offset 0													
Cmd	Seq	SHC	Ref	Field Name	Picture	Type	Start	Length					
				**** Top of data ****									
---	---		1	1 SHIRE		AN	1	53					
---	---		2K	2 SHIRE-KEY		AN	1	20					
---	---		3K	3 SHIRE-NAME	X(20)	AN	1	20					
---	---		4	2 SHIRE-TYPE	X(1)	AN	21	1					
---	---		5	2 SHIRE-CODE1	9(3)	ZD	22	3					
---	---		6	2 SHIRE-CODE2	9(5)	ZD	25	5					
---	---		7	2 SHIRE-ROAD	S9(15)	PD	30	8					
---	---		8	2 SHIRE-RIVER	S9(15)	PD	38	8					
---	---		9	2 SHIRE-BRIDGE	S9(15)	PD	46	8					
Command ==>						Scroll		CSR					
F1=Help		F2=Split		F3=Exit		F4=Expand		F5=RFind		F7=Up		F8=Down	
F9=Swap		F10=Left		F11=Right		F12=Cancel							

Criteria/View

The name of the data set containing the criteria set or view being edited. (Not displayed on the Template : Segment Layout panel.)

Subset

A number or letter assigned by FM/IMS to identify the criteria subset (Criteria : Segment Layout panel only).

It has one of the following values:

R

The relational criteria subset

1 to 255

The field criteria subsets.

Template

The name of the partitioned data set that holds the underlying template.

Segment

The name of the segment displayed.

Offset

The current offset value for all fields in the layout.

1 Id

Used to specify the identification criteria that File Manager should use to identify this layout. (Editable on the Template : Segment Layout panel. Displayed as read-only on the View or Criteria : Segment Layout panels, when the segment has multiple layouts; not displayed on these panels when there is only one layout for the segment).

On the Template : Segment Layout panel, enter 1 to display the Layout Identification Criteria panel and specify the criteria by field, or type a free form REXX expression in the adjacent field. You can scroll to the right or left within the field, using the Right (F11) or Left (F10) function keys, or you can expand the field, using the Expand function key (F4).

Specifying criteria by field or by free form REXX expression is mutually exclusive. If you enter criteria by field, any free form REXX expression entered in the adjacent field is replaced by the new criteria and the field becomes protected. You cannot manually edit this expression. To restore the ability to create a freeform REXX expression for layout identification, you need to clear any criteria entered in the Layout Identification Criteria panel.

2 Sel (or 1 Sel if 1 Id is not displayed)

Used to specify the segment selection criteria that File Manager should use to select segments for processing (not available on the Template : Segment Layout panel, editable on the View or Criteria : Segment Layout panels).

You can use this field to limit the segments of a selected layout that you want to process. When a segment type has multiple layouts, the field selection criteria for the layouts are ORed to give the field selection criteria for the segment type. The field selection criteria for the segment types of the database are ANDed to give the field selection criteria for the view. The field selection criteria for the view are then used in conjunction with the settings of the Sel field on the following panels to select segment occurrences and fields for processing. If you do not provide any segment selection criteria, all segments with this layout are selected for processing when the layout itself has been selected for processing.

Enter 2 (or 1 if **1 Id** is not displayed) to display the Field Selection Criteria panel and specify the criteria by field, or type a free form REXX expression in the adjacent field. You can scroll to the right or left within the field, using the Right (F11) or Left (F10) function keys, or you can expand the field, using the Expand function key (F4).

Specifying criteria by field or by free form expression is mutually exclusive. If you enter criteria by field, any free form REXX expression entered in the adjacent field is replaced by the new criteria and the field becomes protected. You cannot manually edit this expression. To restore the ability to create a freeform REXX expression, you need to clear any criteria entered in the Field Selection Criteria panel.

Cmd

Prefix command area - used to enter a template editor prefix command. (Not displayed on the Template : Segment Layout panel.)

You can type prefix commands in multiple Cmd fields and then execute all the commands in one action, by pressing Enter. Line commands available on this panel are:

DT (date/time)

Displays the Date/Time Attributes panel. You can use the Date/Time Attributes panel to define or change:

- The internal format used to store the date and time value.
- An alternate data type used for date and time processing.
- The output format used to display the date and time value.
- Values used when creating new records and modifying copied records.
- Options for scrambling the date and time values from copied records.

E (edit)

Displays the Field Attributes panel for this field. You can use the Field Attributes panel to specify:

- For a numeric field, whether you want leading zero suppression when the field is displayed on the screen or printed using the SNGL or TABL display or print formats.
- Alternative headings.
- Width of columns on TABL format displays.
- Create data attributes.

H (hold)

Sets Hold status for a single field or, if the field is already in Hold status, removes the Hold.

In TABL display format, as you scroll left or right those fields are always displayed on the left of the panel. In SNGL display format, as you scroll up or down those fields are always displayed at the top of the panel.

Hn

Sets Hold status for *n* fields. If any of the fields are already in Hold status, the Hold status is removed.

HH

Selects a block of fields to have the Hold status set. If any of the fields are already in Hold status, the Hold status is removed. Use the HH prefix command to mark the start and end of the block of fields.

S (select)

Selects a single field for processing or, if the field is already selected for processing, deselects it. If you select multiple fields for processing using the S prefix command, the fields are displayed in the order they appear in the panel.

Sn

Selects *n* fields for processing or, if any of the fields are already selected for processing, deselects them.

S*

Selects all fields from the current field to the end of the list for processing or, if any of the fields are already selected for processing, deselects them. If you want to exclude just a few fields, you can use S* to explicitly select all the fields, then use S to deselect the fields you want to exclude.

SS

Selects a block of fields for processing or, if any of the fields are already selected for processing, deselects them. Use the SS prefix command to mark the start and end of the block of fields.

X

Toggle between a display type of AN (character) and AX (long hexadecimal). This command has no effect on non-alphanumeric fields.

Xn

Perform the X command against all fields from the current field for *n* fields.

X*

Perform the X command against all fields from the current field to the end of the list.

XX

Perform the X command against a block of fields. Use the XX prefix command to mark the start and end of the block of fields.

Seq

Sets the order of the fields to appear in the template.

SHC

Shows the field status:

S

The field has been selected for processing. The field is selected for processing if the segment occurrence is selected for processing.

H

The field has been selected to be held on the Edit or Browse display. Held fields appear, in sequence number order, on the extreme left of the display in table mode. Scrolling left or right has no effect on the position of these fields (they remain in place, while other, non-held fields change position).

C

Create data attributes have been defined for the field. (Note that data create patterns are not currently used by any FM/IMS functions.)

Ref

The field reference number assigned by FM/IMS to the field name. All fields in a segment layout have a number. Use the number to reference a field in layout identification criteria and field selection criteria. The reference number may be suffixed with a key indicator:

K

The field is a key (or part of a key).

S (Uppercase S)

The field is a secondary index search field.

s (lowercase s)

The field is a secondary index subsequence field.

Field name

The level-number and the name of the field as given in the COBOL or PL/I segment layout. Various other attributes such as redefines, array sizes, depending on references are also be displayed as part of the name.

Picture

Shows the picture clause for COBOL and for PL/I. Shows the length and scale (if non zero) for binary and packed fields. Also shows the bit length for bit fields.

Type

The data type of the field:

AN

Alphanumeric

AX

Alphanumeric displayed in long hexadecimal.

BI

Binary

BT

Bit string decimal (external decimal)

DT

Date/Time

FP

Floating point (internal or external)

PD

Packed decimal (internal decimal)

VB

Varying-length (VARYING) bit string

VC

Varying-length (VARYING) character string

VG

Varying-length (VARYING) graphic string

ZC

Null-terminated varying-length (VARYINGZ) character string

ZD

Zoned decimal (external decimal)

ZE

Zoned decimal edited

ZG

Null-terminated varying-length (VARYINGZ) graphic string

Start

The column at which the field starts. For variable located fields, the start column is calculated using the maximum length of the field.

Length

The length of the field. For a level-01 field with a layout of variable-length, the length shown is the maximum length of the layout.

For a criteria set, the only relevant area on this panel is the **Field Selection Criteria**, which you use to specify which segments of this type and layout are extracted. (The **Cmd** and **Seq** fields have no effect on the criteria set.)

Parent panels

- [Database Positioning panel on page 239](#)
- [Segment Layout Selection panel on page 377](#)
- [Segment Selection panel on page 379](#)

Child panels

- [Field Attributes panel - alphanumeric fields on page 287](#)
- [Field Attributes panel - numeric field on page 294](#)

Segment Layout Selection panel

The Segment Layout Selection panel is displayed when a segment type is selected for editing on the Database Positioning panel, Segment Selection panel or Template Specification panel and multiple layouts have been specified for the segment type.

On this panel you can:

- Specify the segment layout you want to edit
- Modify the offset value
- View the layout lengths and expression indicator

This panel displays a list of the layouts that have been specified for the segment type.

Panel and field definitions

Figure 94. Segment Layout Selection panel

<u>P</u> rocess	<u>O</u> ptions	<u>H</u> elp			
FM/IMS	Criteria : Segment Layout Selection		Line 1 of 3		
Criteria	New				
Template	FMN.IMS.IVP.TEMPLATE(DJ1E)				
Subset					
Segment	SHIRE				
Cmd	SIE	Segment layout name	Prompt	Offset	Length
		**** Top of data ****			
___	SI	SHIRE		0	53
___	SI	SHIRE-TOWN		0	53
___	SI	SHIRE-CITY		0	53
		**** End of data ****			
Command	===>				Scroll <u>C</u> SR
F1=Help	F2=Split	F3=Exit	F4=CRetriev	F5=RFind	F6=Describe
F7=Up	F8=Down	F9=Swap	F12=Cancel		

Criteria/View

The name of the data set containing the criteria set or view being edited. This field name changes according to the function in use and is not displayed when editing a template.

Template

The name of the partitioned data set that holds the underlying template.

Subset*

Displays the FM/IMS subset identifier. Description text for the subset may be entered or modified. Applicable to the Criteria : Segment Layout Selection panel only.

Segment

The name of the segment type selected for editing.

Cmd

Prefix command area - used to enter a template editor prefix command. You can type prefix commands in multiple Cmd fields and then execute all the commands in one action, by pressing Enter. Line commands available on this panel are:

S

Toggles the selection of a segment layout for processing.

Deselecting a segment layout affects the entire criteria set. If you deselect a segment layout in a subset, then segments of that type and that layout are not processed.

Even when a segment type is deselected, its field selection criteria are still used to determine whether hierarchically related segments are processed.

E

Display the Segment Layout panel, so that you can edit field selection and expression criteria.

SIE

Select/Identification/Expression column.



Note: On the Template Specification panel, this column contains "S" only, as templates do not hold identification or selection criteria.

S

Indicates that the segment layout has been selected for processing.

I

Indicates that a segment identification expression has been defined for the segment layout.

E

Indicates that a segment selection expression has been defined for the segment layout.

Segment layout name

The level-01 item name.

Prompt

Indicates when the segment layout has been edited within the current session.

Offset

Displays the current offset for each segment type. You can overwrite the value in this column to change the offset for each segment layout, or you can enter the OFFSET primary command to change the offset value for one or more layouts.

Length

The length of the field. For a level-01 field with a layout of variable-length, the length shown is the maximum length of the layout.

Parent panels

- [Database Positioning panel on page 239](#)
- [Segment Selection panel on page 379](#)
- [Template Specification panel on page 412](#)

Child panels

- [Segment Layout panel on page 370](#)

Segment Selection panel

The Segment Selection panel is displayed when:

- You edit a view on the View Entry panel, or
- You edit a criteria set on the Criteria Set Entry panel.

Panel and field definitions

Figure 95. Segment Selection panel

<u>P</u> rocess	<u>O</u> ptions	<u>H</u> elp				
FM/IMS			View : Segment Selection			
View C			FMN. IMS. IVP. VIEW(DJ1EVJU)			
Template			FMN. IMS. IVP. TEMPLATE(DJ1E)			
Cmd	Sel	Level	Segment	Description		
*		1	SHIRE			
*		2	SHIRENP			
*		2	LINKSUB			
**** End of data ****						
Command ==>						Scroll <u>C</u> SR
F1=Help	F2=Split	F3=Exit	F4=CRetriev	F5=RFind	F6=Describe	
F7=Up	F8=Down	F9=Swap	F10=RunTemp	F12=Cancel		

The panel lists all the segment types in the template that the view was created from. (If the template has changed, and you have not updated the view from the template, then the view might not be holding the right segment types.)

For each segment type the following fields are displayed:

View

This displays the name of data set containing the view being edited. If the view has changed from the one stored, then C (for Changed) appears before the view data set name.

Template

This displays the name of the partitioned data set containing the template from which the view was created.

C

When a view is changed but still not saved, position 8 in the heading displays a C.

Cmd

The line command field. Line commands available on this panel are:

Snn

Select *Snn* segments for processing or if any of these segments are already selected for processing, deselect them.

S*

Select all segments from the current segment to the end of the list or if any of these segments are already selected for processing, deselect them.

SS

Select a block of segments for processing or if any of these segments are already selected for processing, deselect them.

Sel

An asterisk (*) shows the segment is selected for display, provided it satisfies the field selection criteria. If the field is blank, then the segment is not displayed.

Level

The hierarchical level of the segment type in the database.

Segment

The name of the segment.

Description

The segment description, as entered on the Template Specification panel.

To toggle selecting a segment for display, enter S in the **Cmd** field against the segment type, and press Enter.

If you enter S against more than one segment type, FM/IMS toggles the selection of the segment type line by line.

To edit a segment, enter E in the **Cmd** field against the segment type, and press Enter. FM/IMS then displays:

- The Segment Layout Selection panel is displayed if the segment type has more than one layout
- The Segment Layout panel is displayed if the segment type has one layout

Batch Submission Job Statement Information:

The JCL job card information that is used when FM/IMS functions generate batch jobs.

Parent panels

- [Settings Menu panel on page 397](#)

Child panels

- None.

Set COBOL Processing Options panel

The Set COBOL Processing Options panel is displayed when you select option 2 from the Set Language and Compiler Specifications menu.

The panel allows you to specify:

- Selected COBOL compiler options that FM/IMS uses when it builds templates from COBOL copybooks.
- Up to 5 pseudo-text character strings that you want replaced in your COBOL copybooks.
- The replacement pseudo-text character strings for the character strings you want replaced.
- The maximum return code that FM/IMS accepts from the COBOL compiler when building a template.

Enter the RESET command to reset all the options on the panel to the installation defaults.

Enter the EXIT command (F3) to exit the panel saving the changes you have made.

Enter the CANCEL command (F12) to exit the panel without saving the changes you have made.

Panel and field definitions

Figure 97. Set COBOL Processing Options panel

Process	Options	Help
FM/IMS	Set COBOL Processing Options	
COBOL Replacing Options:		
	From string	To string
1.		by
2.		by
3.		by
4.		by
5.		by
COBOL Compiler Options:		
	Enter "/" to select option	
	<input type="checkbox"/> DBCS	<input type="checkbox"/> Decimal-point is comma
	<input type="checkbox"/> Arith(extend)	<input type="checkbox"/> Mixed case field names
Additional options -----		
	Maximum Return Code to be accepted from compiler <u>04</u> (0-99)	
Command ==>		
F1=Help	F2=Split	F3=Exit
F9=Swap	F10=Actions	F12=Cancel
	F4=CRetriev	F7=Backward
	F8=Forward	

COBOL Replacing Options

"From" and "To" pseudo-text character strings for the REPLACING phrase of the COPY compiler-directing statement.

If your COBOL copybooks contain characters that you want to remove or replace with other characters before compiling the copybooks into templates, then use these replacing options.

For example, if your copybooks contain text that you want to change before compiling, then specify `==INREC==` as a "From" string and `==AUDIT-RECORD==` as the matching "To" string.

For details on specifying "From" and "To" strings for COPY REPLACING, see the *IBM COBOL Language Reference*.

COBOL Compiler Options

Compiler options to be used when compiling COBOL copybooks into a template:

DBCS

If selected, use the DBCS compiler option. Otherwise, use NODBCS.

Decimal-point is comma

Uses the "Decimal-point is comma" SPECIAL-NAMES paragraph when compiling COBOL copybooks.

Arith(extend)

Uses the Arith(extend) COBOL compile option when compiling COBOL copybooks.

Mixed case field names

Retains the original case of the field name as coded in the COBOL copybook.

Additional options

Additional COBOL compiler options which are added via the CBL statement when a COBOL compile is run to build or update a template. These options are validated during the compile process. To avoid compile errors ensure that the syntax is correct and that any additional data sets required by these options are allocated before invoking File Manager.

Maximum Return Code

Sets the maximum warning/error code accepted from the compiler, when compiling a copybook. Any code higher than specified causes File Manager to display a pop-up panel, in which you can review the compilation and decide about future processing.

For details on the effect of these compiler options, see the *IBM COBOL Programming Guide for OS/390 & VM*.

Parent panels

- [Set Language and compiler specifications panel on page 385](#)

Child panels

- None.

Set HLASM Processing Options panel

The Set HLASM Processing Options panel is displayed when you select option 3 from the Set Language and Compiler Specifications menu.

The panel allows you to specify:

- Selected HLASM compiler options that FM/IMS uses when it builds templates from HLASM copybooks and source.
- The maximum return code that FM/IMS accepts from the HLASM compiler when building a template.

Enter the RESET command to reset all the options on the panel to the installation defaults.

Enter the EXIT command (F3) to exit the panel saving the changes you have made.

Enter the CANCEL command (F12) to exit the panel without saving the changes you have made.

Panel and field definitions

Figure 98. Set HLASM Processing Options panel

Process	Options	Help
FM/IMS	Set HLASM Processing Options	
HLASM Compiler Options:		
Enter "/" to select option		
- DBCS		
- NOALIGN		
Additional options -----		
Maximum Return Code to be accepted from compiler <u>04</u> (0-99)		
Command ==>		
F1=Help	F2=Split	F3=Exit
F9=Swap	F10=Actions	F12=Cancel
F4=CRetriev	F7=Backward	F8=Forward

HLASM Compiler Options

You can select these HLASM compiler options:

DBCS

To use the DBCS HLASM compiler option when compiling HLASM copybooks and source.

NOALIGN

To use the NOALIGN HLASM compiler option when compiling HLASM copybooks and source.

Additional options

Additional HLASM compiler options which are added via the *PROCESS statement when the assembler is run to build or update a template. These options are validated during the assembly process. To avoid assembly errors please ensure the syntax is correct.

Maximum Return Code

The maximum warning or error code received from compiler when compiling a copybook. Any code higher than that specified stops the current FM function.

Parent panels

- [Set Language and compiler specifications panel on page 385](#)

Child panels

- None.

Set Language and compiler specifications panel

The Set Language and compiler specification menu is displayed when you select option 4 from the Settings Menu.

On this menu, you select the compiler related settings panel that you require.

Panel and field definitions

Figure 99. Set Language and compiler specifications panel

<u>P</u> rocess	<u>O</u> ptions	<u>H</u> elp
FM/IMS	Set Language and compiler specifications	
1	LANG	Compiler language selection
2	COBOL	COBOL compiler specifications
3	HLASM	HLASM compiler specifications
4	PL/I	PL/I compiler specifications
Command ==>		
F1=Help	F2=Split	F3=Exit
F9=Swap	F10=Actions	F12=Cancel
	F4=CRetriev	F7=Backward
		F8=Forward

Parent panels

- [Settings Menu panel on page 397](#)

Child panels

- [Compiler Language Selection panel on page 220](#)
- [Set COBOL Processing Options panel on page 382](#)
- [Set HLASM Processing Options panel on page 384](#)
- [Set PL/I Processing Options panel on page 389](#)

Set Output Data Set Allocation Options panel

The Set Output Data Set Allocation Options panel is displayed when you select option 8 from the Settings Menu.

The panel allows you to specify selected allocation parameters for these FM/IMS output and work data sets:

Audit Log

The user's audit log data set created by FM/IMS functions when audit logging is required (or requested by the user) and the FM/IMS administrator has specified that audit log records are to be written to this data set.

Print

The print output created by FM/IMS functions.

Trace

The Trace data set created or updated when the DEBUG ON command is issued.

IMS log

The IMS log data set used by functions using PSBs that have update intent when they are run in DLI mode and the IMS log option on the DLI Mode Parameters panel is set to 1. Keep, 2. Keep when updates or 3. Delete.

Extract Keys

The data set created when the XKEY command is issued during a Browse or Edit.

Logical Keys

A VSAM work data set containing the logically related keys to be processed by the Extract function.

Root Keys

A VSAM work data set containing the root keys of the primary and logically related databases that have been processed by the Extract function.

Enter the RESET command to reset all the parameters on the panel to the installation defaults.

Enter the EXIT command (F3) to exit the panel saving the changes you have made.

Enter the CANCEL command (F12) to exit the panel without saving the changes you have made.

Panel and field definitions

Figure 100. Set Output Data Set Allocation Options panel

<u>P</u> rocess	<u>O</u> ptions	<u>H</u> elp					
FM/IMS Set Output Data Set Allocation Options							
Data set	Space Units	Primary Quantity	Secondary Quantity	Management Class	Storage Class	Data Class	Device Type
Audit Log	<u>CYL</u>	<u>16</u>	<u>8</u>	_____	_____	_____	<u>SYSALLDA</u>
Print	<u>CYL</u>	<u>64</u>	<u>32</u>	_____	_____	_____	<u>SYSALLDA</u>
Trace	<u>TRK</u>	_____	_____	_____	_____	_____	_____
IMS log	<u>TRK</u>	<u>20</u>	<u>20</u>	_____	_____	_____	<u>SYSALLDA</u>
Extract Keys	<u>CYL</u>	<u>1</u>	<u>1</u>	_____	_____	_____	<u>SYSALLDA</u>
Logical Keys	<u>CYL</u>	<u>10</u>	<u>10</u>	_____	_____	_____	Volume (NonSMS) <u>SYSALLDA</u>
Command ==>							
F1=Help	F2=Split	F3=Exit	F4=CRetriev	F6=Reset	F7=Backward		
F8=Forward	F9=Swap	F10=Actions	F12=Cancel				

Space Units

Defines the unit of primary and secondary space to be allocated.

BLK

Block of average size.

KB

Kilobyte, a kilobyte is 1024 bytes.

MB

Megabyte, a megabyte is 1048576 bytes.

TRK

Track of a direct access storage device (DASD).

CYL

Cylinder of a DASD.

Primary Quantity

Amount of DASD space to be used for primary space allocation. The range depends on the space unit specified and the DASD device type.

Secondary Quantity

Amount of DASD space to be used for secondary space allocation. The range depends on the space unit specified and the DASD device type.

Management Class

Name of a management class defined in your Storage Management System (SMS) installation. Do not enter a value on a system without SMS.

Storage Class

Name of a storage class defined in your Storage Management System (SMS) installation. Do not enter a value on a system without SMS.

Data Class

Name of a data class defined in your Storage Management System (SMS) installation. Do not enter a value on a system without SMS.

Device Type

Specifies the device type of the volume to contain the data set. Enter an IBM device type or a generic device name that is supported by your system.

Volume Serial

Serial number of the volume which is to contain the extract VSAM work data set. This field should only be used for sites without SMS-controlled data sets as SMS overrides this value.

Parent panels

- [Settings Menu panel on page 397](#)

Child panels

- None.

Set PL/I Processing Options panel

The Set PL/I Processing Options panel is displayed when you select option 4 from the Set Language and Compiler Specifications menu.

The panel allows you to specify:

- Selected PL/I compiler options that FM/IMS uses when it builds templates from PL/I copybooks.
- The maximum return code that FM/IMS accepts from the PL/I compiler when building a template.

Enter the RESET command to reset all the options on the panel to the installation defaults.

Enter the EXIT command (F3) to exit the panel saving the changes you have made.

Enter the CANCEL command (F12), to exit the panel without saving the changes you have made.

Panel and field definitions

Figure 101. Set PL/I Processing Options panel

<u>P</u> rocess	<u>O</u> ptions	<u>H</u> elp
FM/IMS	Set PL/I Processing Options	
PL/I Compiler Options:		
Enter "/" to select option		
<u>_</u> GRAPHIC	<u>_</u> UNALIGNED	
<u>_</u> 63 bit binary	<u>_</u> 31 digit decimal	
Additional options _____		
Maximum Return Code to be accepted from compiler <u>04</u> (0-99)		
Command ==>		
F1=Help	F2=Split	F3=Exit
F9=Swap	F10=Actions	F12=Cancel
F4=CRetriev	F7=Backward	F8=Forward

PL/I Compiler Options

Compiler options to be used when compiling PL/I copybooks into a template:

GRAPHIC

If selected, use the GRAPHIC compiler option. Otherwise, use NOGRAPHIC.

63 bit binary

If selected, use the LIMITS(FIXEDBIN(63)) compiler option. Otherwise, use LIMITS(FIXEDBIN(31)).

UNALIGNED

DEFAULT RANGE (*) UNALIGNED; when compiling PL/I copybooks. This changes the default for structure alignments.

31 digit decimal

If selected, use the LIMITS(FIXEDDEC(31)) compiler option. Otherwise, use LIMITS(FIXEDDEC(15)).

Additional options

Additional PL/I compiler options which are added via the *PROCESS statement when a PL/I compile is run to build or update template. These options are validated during the compile process. To avoid compile errors ensure that the syntax is correct and that any additional data sets required by these options are allocated before invoking File Manager.

Maximum Return Code

Sets the maximum warning/error code accepted from the compiler, when compiling a copybook. Any code higher than specified causes File Manager to display a pop-up panel, in which you can review the compilation and decide about future processing.

For details on the effect of these compiler options, see the *IBM VisualAge PL/I for OS/390 Programming Guide*.

Parent panels

- [Settings Menu panel on page 397](#)

Child panels

- None.

Set Print Processing Options panel

The Set Print Processing Options panel is displayed when you select option 1 from the Settings Menu.

The panel allows you to view and modify selected options for the print output that the File Manager functions produce.

Panel and field definitions

Figure 102. Set Print Processing Options panel

FM/IMS		Set Print Processing Options	
Print Options:			
Output destination	Record length	Enter "/" to select option	
<u>1</u> 1. SYSPRINT	<u>2</u> 1. 80	/	Page skip
2. Terminal	2. 132	/	Wide print
3. Data set		/	Translate non-printable chars
4. REXX		/	Uppercase message text
		/	Data prefix
		/	Header page
Data set DISP	Dump format		
<u>2</u> 1. OLD	<u>1</u> 1. Updown		
2. MOD	2. Across		
Data set name . . .	JHELVON.FMN.LIST		
Output class . . .	A		
Lines per page . . .	50		
Record limits . . .	(1,*) (n,m) n=begin column, m=end column		
Command ==> -----			
F1=Help	F2=Split	F3=Exit	F4=CRetriev
F6=Reset	F7=Backward		
F8=Forward	F9=Swap	F10=Actions	F12=Cancel

FM/IMS can produce the following types of print output:

- Audit trail report.
- Extract report.
- Load report.
- Data printed by the DPRINT command, while browsing or editing data.
- Data printed by the utility functions: Print, Batch Edit or Batch Browse.

Unless otherwise specified, the following options apply to all types of printoutput—except for the Utility functions.

Output destination

Specifies where print output is sent, except for batch execution.

SYSPRINT

Send print output to the current SYSPRINT allocation.

Terminal

Send print output to the TSO terminal.

Data set

Output is accumulated in the print data set specified in the **Data set name** field. This data set can be browsed using the PB command, or sent for printing to the JES spool queue with class specified in the **Output class** field using the PRINT command while browsing.

REXX

Send output to a REXX stem variable. Each line corresponds to a variable named FILEM.*nnn*. FILEM.0 contains the line count.

When you use the PRINT primary command in Print Browse (option 3.9), or if you specify batch execution in a File Manager panel, then print output is always sent to a SYSOUT class.

Record length

Specifies the line length of print output.

80

The line length of print output is 80 characters, suitable for a terminal.

132

The line length of print output is 132 characters, suitable for a printer.



Note: Record length is not applicable when:

- The data is printed in TABL format, or
- You specify the wide format for the compare output listing

In either of the above cases, when data is printed the line length is determined from the number and size of fields printed. If this length is greater than the record length specified for the data set, the print line is truncated. The maximum print line length is 32760.

Data set DISP

Specifies the disposition of a print data set.

OLD

The print data set is cleared before each print operation, and print output is written from the beginning of the data set.

MOD

Default setting. Print output is appended to the existing print data set.

Dump format

Specifies the format of hexadecimal print output (for example, when you use Tape Print with **Print format** set to HEX). For an example of each format, see [Selecting a display format on page 61](#).

Across

Display hexadecimal digits as 2 groups of 4 full words (resulting in 32 hexadecimal digits) followed by the EBCDIC character display to the right of the hexadecimal display. For example:

LVL	Segment	Description	Concatenated Key									
001	SUBURB		BEACONSFIELD									
000000	C2C5C1C3	D6D5E2C6	C9C5D3C4	40404040	4040F6F1	F6F240C2	F2F5F2F0	F0F1F5C6	*BEACONSFIELD	6162	B2520015F*	
000020	D9C5D4C1	D5E3D3C5	40404040	40F0F0F2	F3F2F0F4	F1F1F5F4	F6C2C3D5	C6C4	*REMAN TLE	002320411546BCNFD	*	

Updown

Under each EBCDIC character, vertically stack the two digits of its hexadecimal value. The most significant digit is displayed above the least significant digit. For example:

LVL Segment	Description	Concatenated Key
001	SUBURB	BEACONSFIELD
	CHAR	BEACONSFIELD 6162 B2520015FREMANTLE 002320411546BCNFD
	ZONE	CCCCDECCDC444444FFFF4CFFFFFFFCDCEDC444444FFFFFFFFFFFFCCDCC
	NUMR	2513652695340000006162022520015695415335000000232041154623564
		01---+-----1---+-----2---+-----3---+-----4---+-----5---+-----6---

Page skip

If selected, print output from each function begins on a new page.

Wide print

If selected, for to-be-allocated (new) print output datasets (online) or for SYSPRINT allocation (in batch), File Manager uses the maximum record length/blocksize of 32756/32760 and record format of VBA.

If not selected, for to-be-allocated (new) print output datasets (online) or for SYSPRINT allocation (in batch), File Manager uses the record length/blocksize of 133/137 and record format of VBA.



Note: This setting only applies when the output dataset is newly-allocated during execution. It is ignored for pre-allocated print output datasets.

Translate non-printable chars

Specifies how File Manager should translate non-printable characters.

If selected, non-printable characters are translated to blanks using a translate table.

If not selected, no translation is performed. Use PRTRANS=OFF to support special print chains. This may make printing faster.

For instructions on altering the print translate table, see the *File Manager Customization Guide*.

Uppercase message text

All message text is translated to uppercase.

Data prefix

If selected, when data is printed in CHAR or LHEX print format, record header information (for example, record number and length) is included in character-format print output.

If not selected, you can specify DATAHDR=NO to left-justify the data in the print output, without header information.

Header page

If selected, a header page (a title page with File Manager on it) is included in the print output.

If you specified the **Output destination** as **2** (Terminal), then the header page is not included in the print output, even if you have selected this option.

Data set name

If you specified the **Output destination** as **3** (Data set), then after you enter the PRINT command while executing the Print Browse (PB) function, File Manager sends print output to this temporary data set.

The default is *userid.FMN.LIST*, unless changed in your File Manager installation.

Output class

The class of the JES spool queue to be used when the PRINT command is issued while browsing the temporary print data set.

Lines per page

Specifies the number of lines printed on each page of print output. You can specify a value from 1 to 999. The default is 60.

Record limits

When data is printed in CHAR or LHEX print format, limits print output for each record (or OAM object).

(1,*)

The entire record (or block) is printed.

(n,m)

Print output is limited to the data from columns (bytes) *n* through *m*. An asterisk (*) specified for *m* indicates the end of the record.

LVL Segment	Description	Concatenated Key									
001	SUBURB	BEACONSFIELD									
000000	C2C5C1C3	D6D5E2C6	C9C5D3C4	40404040	4040F6F1	F6F240C2	F2F5F2F0	F0F1F5C6	*BEACONSFIELD	6162	B2520015F*
000020	D9C5D4C1	D5E3D3C5	40404040	40F0F0F2	F3F2F0F4	F1F1F5F4	F6C2C3D5	C6C4	*REMANTLE	002320411546BCNFD	*

Parent panels

- [Settings Menu panel on page 397](#)

Child panels

- None.

Set Temporary Data Set Allocation Options panel

The Set Temporary Data Set Allocation Options panel is displayed when you select option 7 from the Settings Menu.

The panel allows you to specify selected allocation parameters for temporary data sets created by FM/IMS functions.

Enter the RESET command to reset all the parameters on the panel to the installation defaults.

Enter the EXIT command (F3) to exit the panel saving the changes you have made.

Enter the CANCEL command (F12) to exit the panel without saving the changes you have made.

Panel and field definitions

Figure 103. Set Temporary Data Set Allocation Options panel

Process	Options	Help
FM/IMS	Set Temporary Data Set Allocation Options	
Temporary data set allocation defaults:		
Unit	SYSALLDA	leave blank for default
Data class	_____	leave blank for default
Storage class	_____	leave blank for default
Management class	_____	leave blank for default
Default High Level Qualifiers:		
Temporary Data Sets	_____	HLQ (opt. &USER/&PREFIX)
Command ==>		
F1=Help	F2=Split	F3=Exit
F4=CRetriev	F6=Reset	F7=Backward
F8=Forward	F9=Swap	F10=Actions
F12=Cancel		

Temporary data set allocation defaults

Unit

Can be one of these:

- A 3-digit hexadecimal device number.
- A 4-digit hexadecimal device number prefixed with a slash (/).
- Device type (generic name).
- Group name (installation-defined symbolic name).

Data class

Name of a data class defined in your Storage Management System (SMS) installation. Do not enter a value on a system without SMS.

Storage class

Name of a storage class defined in your Storage Management System (SMS) installation. Do not enter a value on a system without SMS.

Management class

Name of a management class defined in your Storage Management System (SMS) installation. Do not enter a value on a system without SMS.

Default High Level Qualifiers

Temporary Data Sets

Can be any multi-level qualifier, which is used by File Manager as the high-level qualifier (HLQ) in names of created datasets. You can use these symbols as part of the HLQ:

&USER

Represents the user ID.

&PREFIX

Represents the TSO prefix.

The default is none (unless changed in your File Manager installation).

Parent panels

- [Settings Menu panel on page 397](#)

Child panels

- None.

Set Trace options panel

The Set Trace Options panel is displayed when you select option 9 from the Settings Menu.

The panel allows you to view and modify parameters that control the Trace output produced by FM/IMS when it is run in debug mode.

Enter the RESET command to reset all the parameters on the panel to the installation defaults.

Enter the EXIT command (F3) to exit the panel saving the changes you have made.

Enter the CANCEL command (F12) to exit the panel without saving the changes you have made.

Panel and field definitions

Figure 104. Set Trace options panel

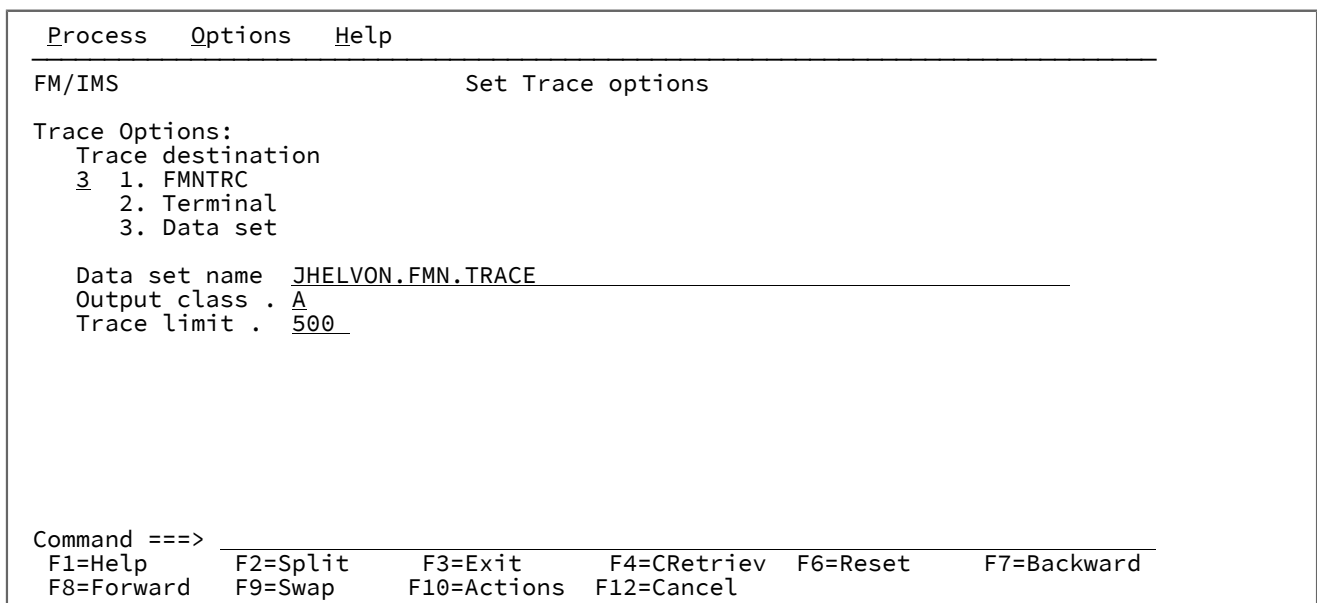

Trace destination

Specifies where FM/IMS debug trace output is to be sent:

FMNTRC

Send trace output to the current FMNTRC allocation.

Terminal

Send trace output to the terminal.

Data set

Send trace output to the temporary data set specified in the **Data set name** field.

Data set name

The temporary trace data set where FM/IMS trace output is directed when you select "Data set" for **Trace destination**.

Output class

The class of the JES spool queue to be used when the PRINT command is issued while browsing the temporary trace data set.

Trace limit

When run in debug mode, FM/IMS writes the Trace output to a buffer (as for normal debug mode), but the buffer is only written to the Trace destination, if FM/IMS abnormally terminates.

This field specifies the number of Trace statements that are retained in the buffer. If you specify a value of zero, background debug mode is turned off.

Parent panels

[Settings Menu panel on page 397](#)

Child panels

None.

Related topics and examples**Settings Menu panel**

The Settings Menu panel is displayed when you select option 0 from the Primary Options Menu.

On this menu, you select the settings panel that you require.

Panel and field definitions

Figure 105. Settings menu

Process	Options	Help
FM/IMS		Settings Menu
1	Print	Print settings
2	System	System settings
3	Batch	Job card specifications
4	Compiler	Language and compiler specifications
5	EDIT	Editor options
6	Subsystem	IMS subsystem settings
7	Temporary	Temporary Data Set Allocations
8	Output	Output Data Set Allocations
9	Trace	Trace options
Command ==>		
F1=Help	F2=Split	F3=Exit
F9=Swap	F10=Actions	F12=Cancel
	F4=CRetriev	F7=Backward
		F8=Forward

1 Print

Displays the Set Print Processing Options panel.

2 System

Displays the System Settings panel.

3 Batch

Displays the Set Batch Job Card Information panel.

4 Compiler

Displays the Set Language and compiler specifications panel.

5 EDIT

Displays the Editor Options panel.

6 Subsystem

Displays the Subsystem Settings Menu panel.

7 Temporary

Displays the Set Temporary Data Set Allocation Options panel

8 Output

Displays the Set Output Data Set Allocation Options panel.

9 Trace

Displays the Set Trace options panel.

Parent panels

- [Primary Option menu on page 346](#)

Child panels

Panel	Action
Set Print Processing Options panel on page 390	Option 1
System Settings panel on page 406	Option 2
Set Batch Job Card Information panel on page 381	Option 3
Set Language and compiler specifications panel on page 385	Option 4
Editor Options panel on page 272	Option 5
Subsystem Settings Menu panel on page 404	Option 6
Set Temporary Data Set Allocation Options panel on page 394	Option 7
Set Output Data Set Allocation Options panel on page 386	Option 8
Set Trace options panel on page 396	Option 9

Subset Selection panel

The Subset Selection panel is displayed when:

- You edit a criteria set on the Criteria Set Entry panel.
- You select on the Extract Entry panel either the **Edit Criteria** option and "Existing" for **Criteria usage**, or "New" for **Criteria usage**.

The Subset Selection panel displays a list of the criteria subsets in the specified criteria set.

Panel and field definitions

Figure 106. Subset Selection panel

```

Process  Options  Help
-----
FM/IMS          Criteria : Subset Selection

Criteria FMN.IMS.IVP.CRITERIA(SHIRE)
Template FMS.IMS.IVP.TEMPLATE(DJ1E)
          Sub
Cmd  Sel  set  Criteria subset description
-   *   R   Relationship criteria
-   *   1   ccc
-   **** End of data ****

Command ==> _____ Scroll PAGE
F1=Help      F2=Split    F3=Exit     F4=CRetriev F6=Describe F7=Backward
F8=Forward   F9=Swap     F10=Actions F12=Cancel
    
```

Criteria

This displays the name of data set containing the criteria set being edited.

Template

This displays the name of the partitioned data set containing the template that the template was created from.

For the each criteria subset, these fields are displayed:

Sel

Has one of two values:

*

indicates that the criteria subset is selected for processing, that is, the criteria specified are used to select segment occurrences for extraction.

Blank

otherwise.

Subset

A number or letter assigned by FM/IMS to identify the criteria subset. It has one of the following values:

R

for the relational criteria subset.

1 to 255

for the field criteria subsets.

Criteria subset description

For field criteria subsets, this is the description provided on the Segment Selection panel. FM/IMS provides a description for the relationship criteria subset.

Cmd

The line commands available on this panel are:

s

Select. Select or deselect the criteria subset for processing. The Sel field for the criteria subset changes to * if the subset has been selected, or blank if it has been deselected.

e

Edit. Edit the criteria subset. This allows you to edit the extract selection criteria in this criteria subset. For the relationship criteria subset, the Relationship Criteria panel is displayed. For field criteria subsets, the Segment Selection panel is displayed.

i

Insert. Create a new field criteria subset. The Segment Selection panel is displayed.

d

Delete. Delete the criteria subset from the extract criteria set.

r

Repeat. Repeat the criteria subset.

Parent panels

- [Criteria Set Entry panel on page 226](#)
- [Extract Entry panel on page 275](#)

Child panels

- [Relationship Criteria panel on page 365](#)
- [Segment Selection panel on page 379](#)

Subsystem Selection panel

The Subsystem Selection panel is displayed when you enter either no subsystem name or a subsystem name pattern on these panels:

- Browse Entry panel
- Edit Entry panel
- Delete/Define Entry panel
- Initialize Entry panel
- Extract Entry panel

- Load Entry panel
- Print Entry panel
- Batch Edit Entry panel
- Batch Browse Entry panel
- Subsystem Settings Menu panel

If no subsystem name is supplied, all IMS subsystems specified in the FM/IMS installation options module are shown on the panel. If a subsystem name pattern is supplied, all IMS subsystems specified in the FM/IMS installation options module that have a name matching the pattern are shown on the panel.

Panel and field definitions

Figure 107. Subsystem Selection panel

<u>P</u> rocess	<u>O</u> ptions	<u>H</u> elp						
FM/IMS			Browse : Subsystem Selection					
Cmd	SSID	Status	IMS VER	Read Only	PSB Types	Region Types	AGNs Used	Description
___	IFA2	ACTIVE	10	N	BOTH	BOTH	N	IFA2 v10 any PSB all unprotect
___	IFB2	ACTIVE	10	N	BOTH	BOTH	N	IFB2 v10 any PSB
___	IF32	ACTIVE	10	N	BOTH	BOTH	N	IF32 v10 DYN PSB all unprotect
___	IF22	ACTIVE	10	N	BOTH	BOTH	N	IF22 v10 STAT PSB all protect
___	IFC2	INACT.		N	BOTH	BOTH	N	IFC2 v11 any PSB all unprotect
___	IFD2	INACT.		N	BOTH	BOTH	N	IFD2 v11 any PSB all protect
___	IFE2	ACTIVE	12	N	BOTH	BOTH	N	IFE2 v12 any PSB all protect
___	IF52	ACTIVE	9	N	BOTH	BOTH	N	IF52 - BOTH all unprotect
___	IF42	ACTIVE	9	N	BOTH	BOTH	N	IF42 - BOTH, not protected
___	IF12	ACTIVE	11	N	BOTH	BOTH	N	IF12 - IMSV11 - DBRC=FORCE
****			End of data ****					
Command ==>								Scroll PAGE
F1=Help	F2=Split	F3=Exit	F4=CRetrie	F7=Backward	F8=Forward			
F9=Swap	F10=Actions	F12=Cancel						

Cmd

Selection entry field.

To select a subsystem, enter **s** in the **Cmd** field and press Enter. You can only select a subsystem for:

- Edit, Delete/Define, Initialize, Load and Batch Edit when the subsystem has not been defined as read only.
- A function that runs in BMP mode when the subsystem is active and has not been defined as DLI mode only.
- A function that runs in DLI mode when the subsystem has not been defined as BMP mode only.
- A function that uses a dynamic PSB when the subsystem has not been defined as static PSB only.
- A function that uses a static PSB when the subsystem has not been defined as dynamic PSB only.
- The BMP mode settings panels when the subsystem has not been defined as DLI mode only.

- The DLI mode settings panels when the subsystem has not been defined as BMP mode only.



Note: The **Cmd** field is protected when you are not allowed to select the subsystem.

SSID

The IMS subsystem ID. The subsystem ID is highlighted when when you are allowed to select the subsystem.

Status

The current status of the subsystem. The subsystem can be ACTIVE or INACTIVE.

IMS VER

The version of IMS that the subsystem runs. The version number is only displayed when the current status of the subsystem is active.

Read Only

Whether or not the subsystem has been defined as read only in the FM/IMS installation options module (Y or N respectively). FM/IMS prevents you from selecting a read only subsystem for Edit, Delete/Define, Initialize, Load and Batch Edit.



Note: A subsystem can be defined as read only for one region type (DLI or BMP) and not read only for the other.

PSB Types

The PSB types that you can use to access databases in the subsystem:

BOTH

You can use both dynamic and static PSBs.

STAT

You can only use static PSBs.

DYN

You can only use dynamic PSBs.

FM/IMS prevents you from selecting:

- A static PSB only subsystem for a function that uses a dynamic PSB.
- A dynamic PSB only subsystem for a function that uses a static PSB.

The PSB types you can use to access a subsystem in BMP mode may be different from the PSB types you can use to access the subsystem in DLI mode.

Region Types

The region types you can use to access databases in the subsystem:

BOTH

You can use both BMP and DLI regions.

BMP

You can only use BMP regions.

DLI

You can only use DLI regions.

FM/IMS prevents you from selecting:

- A BMP mode only subsystem for a function that runs in DLI mode.
- A BMP mode only subsystem for a DLI mode settings panel.
- A DLI mode only subsystem for a function that runs in BMP mode.
- A DLI mode only subsystem for a BMP mode settings panel.

AGNs Used

Whether or not the subsystem uses AGNs to secure dependent regions (Y or N respectively).

Description

The subsystem description as specified in the FM/IMS installation options module.

Use the REFRESH primary command to refresh the statuses of the listed subsystems.

Parent panels

- [Batch Browse Entry panel on page 195](#)
- [Batch Edit Entry panel on page 201](#)
- [Subsystem Settings Menu panel on page 404](#)
- [Browse Entry panel on page 214](#)
- [Delete/Define Entry panel on page 251](#)
- [Edit Entry panel on page 266](#)
- [Extract Entry panel on page 275](#)
- [Initialize Entry panel on page 318](#)
- [Load Entry panel on page 335](#)
- [Print Entry panel on page 351](#)

Subsystem Settings Menu panel

The Subsystem Settings Menu is displayed when you select option 6 from the Settings Menu.

On this menu, you specify:

- The subsystem settings panel that you require.
- The ID of the IMS subsystem that you want the settings for.

Panel and field definitions

Figure 108. Subsystem Settings Menu panel

Process	Options	Help
FM/IMS Subsystem Settings Menu		
DLI mode settings		
1	Parameters	Parameters passed to the IMS region controller
2	Data sets 1	DFSVSAMP, RESLIB and IMS macros data set names
3	Data sets 2	RECON, ACBLIB and IMS log data set names
4	Options	Autosave, checkpoint frequencies and PROCOPTs
BMP mode settings		
5	Parameters	Parameters passed to the IMS region controller
6	Options	Autosave, checkpoint frequencies and PROCOPTs
DLI and BMP mode settings		
7	Data sets 1	PSB and DBD data set names
8	Data sets 2	Template data set names
IMS Subsystem Name		<u>IF52</u>
Command ==>		
F1=Help	F2=Split	F3=Exit
F9=Swap	F10=Actions	F12=Cancel
F4=CRetrieve	F7=Backward	F8=Forward

On the Command line, enter:

1 for the DLI Mode Parameters panel

The DLI Mode Parameters panel allows you to view and modify the parameters that are passed to the IMS region controller when a File Manager/IMS function is run in DLI mode.

2 for the DLI Mode Data Sets 1 panel

The DLI Mode Data Sets 1 panel allows you to view and modify the names of the DFSVSAMP, RESLIB, and IMS macros data sets used by the FM/IMS functions when run in DLI mode.

3 for the DLI Mode Data Sets 2 panel

The DLI Mode Data Sets 2 panel allows you to view and modify the names of the RECON, ACBLIB, and IMS log data sets used by the FM/IMS functions when run in DLI mode.

4 for the DLI Mode Options panel

The DLI Mode Options panel allows you to view and modify selected options used by the FM/IMS functions when run in DLI mode.

5 for the BMP Mode Parameters panel

The BMP Mode Parameters panel allows you to view and modify the parameters that are passed to the IMS region controller when a File Manager/IMS function is run in BMP mode.

6 for the BMP Mode Options panel

The BMP Mode Options panel allows you to view and modify selected options used by the FM/IMS functions when run in BMP mode.

7 for the PSB and DBD Data Sets panel

The PSB and DBD Data Sets panel allows you to view and modify the names of the PSB and DBD data sets used by the FM/IMS functions.

8 for the Template Data Sets panel

The Template Data Sets panel allows you to view and modify the names of the Template data sets used by the FM/IMS functions.

IMS Subsystem Name

Enter the ID of the IMS subsystem that you want the settings for. If the field is blanked out or a pattern is entered and there are subsystem names in the FM/IMS installation options module that match the pattern, the Subsystem Selection panel is displayed. You can select a subsystem from the list of subsystems displayed on that panel.

Parent panels

- [Settings Menu panel on page 397](#)

Child panels

- None.

System Settings panel

The Systems Settings panel allows you to view and modify selected options used by the FM/IMS functions.

The panel is displayed when you select option 2 from the Settings Menu.

The FM/IMS administrator may have fixed the values of some or all of the options displayed on the panel. If an option has been fixed, the panel field is protected and you cannot change the specified value.

If an option has not been fixed, you can change the value that has been specified for it.

Enter the RESET command to reset all the options on the panel to the installation defaults.

Enter the EXIT command (F3) to exit the panel saving the changes you have made.

Enter the CANCEL command (F12) to exit the panel without saving the changes you have made.

Panel and field definitions

Figure 109. System Settings panel

Process	Options	Help
FM/IMS	System Settings	
Options:		
Enter "/" to select option		
_ Fast PSB validation		
Editor choice for viewing/editing members and output data		
1 1. ISPF editor		
2. File Manager base editor		
Parameters:		
Pad character	_____ (Character or hex value)
Default CCSID	0_____
Command ==>		
F1=Help	F2=Split	F3=Exit
F9=Swap	F10=Actions	F12=Cancel
F4=CRetrieve	F7=Backward	F8=Forward

Options:

Fast PSB validation

Select this option if you use static PSBs with a large number of PCBs and you experience poor response times when you press Enter on the Edit, Browse, Extract, Load, Print, Batch Edit or Batch Browse Entry panels.

To fully validate the PSB that you specify, FM/IMS loads the DBD for each PCB that is in the PSB. This may result in poor response times.

When this option is selected, FM/IMS does not load the DBD for each PCB in the PSB. If you are attempting to use an invalid PSB and this option is selected, you may get an IMS abend when connecting to IMS (rather than a File Manager/IMS error message when the option is not selected). But apart from the improved response time, most users will not notice any difference between the two settings.

Editor choice for viewing/editing members and output data

The editor that you want FM/IMS to invoke:

- When you select a member for edit, view or browse.
- When you view generated output.

1. ISPF editor

FM/IMS invokes the ISPF editor.

2. File Manager Base component editor

FM/IMS invokes the File Manager Base component editor.

Parameters:

Pad character

This value is used for padding segments when you are not using a View and you are expanding the length of a variable length segment or inserting a new segment. It can be a single character or a hexadecimal value (enter an X followed by two hexadecimal characters enclosed in single quotation marks, for example, X'00').

In SNGL or TABL display format, the segment is always padded with `x'00'` (null) characters.

Default CCSID

Specify the CCSID to be used as the default CCSID for the FM/IMS batch print function IPR.

Parent panels

- [Settings Menu panel on page 397](#)

Child panels

- None.

Template Data Sets panel

The Template Data Sets panel allows you to view and modify the names of the Template data sets used by the FM/IMS functions.

The panel is displayed when option 8 is selected on the Subsystem Settings Menu panel.

The **Subsystem** field displays the IMS subsystem ID you specified on the Subsystem Settings Menu panel.

The panel displays the data set names that an online FM/IMS function uses when this IMS subsystem ID is specified on the function's Entry panel.

The FM/IMS administrator may have fixed the values of some or all of the data set names displayed on the panel. If a data set has been fixed, the panel field is protected and you cannot change the specified value.

If a data set has not been fixed, you can change the value that has been specified for it.

To reset all the data set names on the panel to their subsystem defaults, enter the RESET command.

To exit the panel saving the changes you have made, enter the EXIT command (F3).

To exit the panel without saving the changes you have made, enter the CANCEL command (F12).

Panel and field definitions

Figure 110. Template Data Sets panel

Process	Options	Help
FM/IMS	Template Data Sets	
Subsystem IF52 IF52 - DYNAMIC, all unprotect		
Template:		
Data set name #1	'FMN.REGTEST.IMS.TEMPLATE.PLI'	
Data set name #2	'FMN.REGTEST.IMS.TEMPLATE.COBOL'	
Data set name #3	'FMN.REGTEST.IMS.TEMPLATE'	
Data set name #4	'FMN.REGTEST.IMS.RFM0712.TEMPL8\$1'	
Data set name #5	'FMN.REGTEST.IMS.RFM0712.TEMPL8\$2'	
Data set name #6	'FMN.REGTEST.IMS.RFM0712.TEMPL8\$3'	
Command ==>		
F1=Help	F2=Split	F3=Exit
F9=Swap	F10=Actions	F12=Cancel
	F4=CRetrieve	F7=Backward
	F8=Forward	

Template

The names of the libraries that contain the templates that you want the FM/IMS functions to use.

Parent panels

- [Subsystem Settings Menu panel on page 404](#)

Template Entry panel

The Template Entry Panel is the first panel in the Template dialog. It is displayed when you select option 1 (Templates) from the Template/View/Criteria Set Menu.

The Template dialog allows you to create or update templates for your IMS databases.

On this panel, you specify:

- Either the name of the partitioned data set that contains the template that you want to update, or the name of the partitioned data set in which you want a new template stored.
- Either the name of an existing template member that you want to update, or the name of a new member in which you want a new template stored.
- (If you specify a new member) Either the IMS catalog or the DBD libraries that you want the Template function to get the DBDs from.



Note: A template for an IMS database can only be stored in a partitioned data set (PDS or PDSE). It is stored in a member with the same name as the database.

Panel and field definitions

Figure 111. Template Entry panel

<u>P</u> rocess	<u>O</u> ptions	<u>H</u> elp
FM/IMS		
Template Entry Panel		
Template:		
Data set name . . . 'FMN.IMS.IVP.TEMPLATE'		
Member		
IMS:		
Subsystem name . . IFG1		
Command ==>		
F1=Help	F2=Split	F3=Exit
F9=Swap	F10=Actions	F12=Cancel
F4=CRetriev	F7=Backward	F8=Forward

Template

Data set name

Either the name of the PDS(E) in which you want a new template stored, or the name of the PDS(E) that contains the template that you want to update.

Member

Either the name of an existing template member that you want to update, or the name of a nonexistent member of the Template data set. If you specify a nonexistent member, the Template dialog creates a template for the database with the specified name and stores it in a new member with the specified name.

If you enter either no member name or a member name pattern, the Template Member Selection panel is displayed. You can select a template from the list of templates displayed on that panel.

Subsystem name

If you specify a template member that does not exist, use this field to specify either the IMS catalog or the DBD libraries that you want the Template function to get the DBDs from.

If you specify a subsystem that uses IMS-managed ACBs, then the function gets the DBDs from the IMS catalog that the subsystem uses.

If you specify a subsystem that does not use IMS-managed ACBs, then the function gets the DBD libraries for the specified subsystem and displays them on the DBD Library List panel. You can use the DBD libraries that are displayed on that panel or update the list as required.

If you enter either no subsystem name or a subsystem name pattern, the Subsystem Selection panel is displayed. You can select a subsystem from the list of subsystems displayed on that panel.



Note: This field is ignored when you specify an existing template member.

Parent panels

- [Template/View/Criteria Set Menu panel on page 423](#)

Child panels

- [Copybook Library List panel on page 222](#)
- [DBD Library List panel on page 250](#)
- [IMS Catalog Specification panel on page 306](#)
- [Template Specification panel on page 412](#)

Template Member Selection panel

The Template Member Selection panel is displayed when you specify either no template member name or a template member pattern on the Template Entry, View Entry, Criteria Set Entry, or the Template Update Utility panel.

If no template member name is supplied, all the members in the template data set are shown on the panel. If a template member pattern is supplied, all the members with names that match the pattern are shown on the panel.

To select a criteria member, type `s` in the **Cmd** field and press Enter.

When the selection list is for the field on the Template, View, or Criteria Set Entry panel, you can only select one member. When the selection list is for the field on the Template Update Utility panel, you can select multiple members.

The panel also allows you to:

- Select the member attributes that are displayed.
- Select the order in which the member attributes are displayed.
- Specify the width of the column used to display each member attribute.
- Sort the member list by any of the displayed member attributes.
- Use member attribute patterns to filter the member list.
- Browse or view the member.

When the selection list is for the field on the Template Update Utility panel, you can also use the template editor to edit and save the displayed template members.

For a detailed description of the panel fields and functionality, see "Member Selection panel" in the *User's Guide and Reference*.

Panel and field definitions

Figure 112. Template Member Selection panel

Process Options Help									
FM/IMS		Template Member List						Row 00001 of 00134	
DSNAME	FM.XTEST.TEMPLATE	Name	Prompt	Typ	Created	Updated	Lang	Ver	Descri
*	*	*	*	*	*	*	*	*	*
_____		ABND		TP	2006/04/11	2008/03/16	18:50:20	COBOL	2
_____		AHRD		TP	2009/07/28	2009/07/28	21:47:53	COBOL	2
_____		ATRD		TP	2009/08/12	2009/08/12	14:55:48	COBOL	2
_____		AUBD		TP	2009/03/04	2010/01/20	11:33:28	COBOL	2
_____		AXXD		TP	2008/09/24	2008/09/24	16:35:21	COBOL	2
_____		A00D		TP	2010/05/10	2010/05/10	15:37:52	COBOL	2
_____		A01D		TP	2005/06/22	2008/03/16	18:50:23	COBOL	2
_____		A02D		TP	2005/08/29	2008/03/16	18:50:24	COBOL	2
_____		A03D		TP	2009/10/15	2009/10/15	11:35:43	COBOL	2
_____		A04D		TP	2009/10/08	2009/10/08	16:34:09	PL/I	2
_____		A05D		TP	2006/03/21	2008/10/06	18:18:49	PL/I	2
_____		A08D		TP	2005/10/24	2009/10/08	13:41:39	PL/I	2
_____		A12D		TP	2005/11/30	2008/04/03	09:12:30	COBOL	2
_____		A13D		TP	2005/12/08	2010/05/31	12:57:58	COBOL	2
_____		A14D		TP	2005/12/20	2010/05/31	12:58:00	COBOL	2
_____		A15D		TP	2005/12/20	2010/05/31	12:58:02	COBOL	2
_____		A16D		TP	2006/01/31	2010/05/31	13:09:56	PL/I	2
_____		A17D		TP	2006/02/02	2010/05/31	13:09:57	PL/I	2
_____		A18D		TP	2006/02/09	2008/09/30	17:37:43	PL/I	2
_____		A19D		TP	2006/02/06	2010/05/31	12:58:04	COBOL	2
_____		A23D		TP	2006/03/09	2010/05/31	12:58:08	COBOL	2
_____		A24D		TP	2006/03/09	2009/08/12	16:47:54	COBOL	2
_____		A25D		TP	2006/03/14	2010/05/31	12:58:11	COBOL	2

Command ==> Scroll PAGE

F1=Help	F2=Split	F3=Exit	F4=CRetrieval	F5=RFind	F7=Backward
F8=Forward	F9=Swap	F10=Left	F11=Right	F12=Cancel	

Parent panels

- [Advanced Member Selection panel on page 192](#)
- [Template Update Utility panel on page 418](#)
- [Template Entry panel on page 409](#)
- [View Entry panel on page 425](#)
- [Criteria Set Entry panel on page 226](#)

Child panels

- [JCL Submission panel on page 331](#)
- [Template Specification panel on page 412](#)

Template Specification panel

The Template Specification panel is displayed after the Template data set name and member is entered on the Template Entry Panel.

When you specify a non-existent template member or an old version of the template that does not contain the library information, the DBD Library List panel and Copybook Library List panel are displayed prior to the display of the Template Specification panel.



Note: Older templates will be automatically updated to the new format if a cancel is not issued. Existing templates will be updated automatically if the segments defined in the template don't match the segments defined in the DBD.

The Template Specification panel displays a list of the segment types in the DBD and their corresponding copybooks that define the segment layouts.

On this panel, you can:

- Specify one or more copybooks to describe the layouts for any segment.
- Specify whether an 01 should be inserted for any given copybook.
- Update the template.
- Edit the template for a given segment.

Panel and field definitions

Figure 113. Template Specification panel

Process		Options		Help			
FM/IMS		Template Specification					
Template FMN.IMS.IVP.TEMPLATE(DJ1F)							
Cmd	RI	Segment	Layout member	Lib	Segment description	01	Field name
***	****	Top of data		****			
---	I	SHIRE	SHIRE	1		N	
---	I	SHIRENP	SHIRENP	1		N	
---	I	LINKSUB	LINKSUB	1		N	
***	****	End of data		****			
Command ==>						Scroll CSR	
F1=Help	F2=Split	F3=Exit	F4=CRetriev	F6=Describe	F7=Backward		
F8=Forward	F9=Swap	F10=Actions	F12=Cancel				

For each segment type, you enter a member name of a copybook and, optionally, a description:

Template

This displays the name of the partitioned data set where the template being created is to be stored.

Cmd

Prefix command field. Segment header rows are rows that contain a non-blank segment value. These rows cannot be deleted or moved. You cannot insert a row before the first segment header row. Available commands are:

E

Create (if necessary) the template and edit it.

A

Identifies the row after which data is to be moved or copied.

B

Identifies the row before which data is to be moved or copied.

C

Copy one row.

Cn

Copy *n* rows.

CC

Copy block of rows. Marks the start and end of the block.

D

Delete one row.

Dn

Delete *n* rows.

DD

Delete block of rows. Marks the start and end of the block.

E

Edit the segment layout.

I

Insert one empty row.

In

Insert *n* empty rows.

M

Move one row.

Mn

Move *n* rows.

MM

Move block of rows. Marks the start and end of the block.

O

Overlay one row.

On

Overlay *n* rows.

OO

Overlay block of rows. Marks the start and end of the block.

R

Repeat row once.

Rn

Repeat row *n* times.

RR

Repeat block of rows. Marks the start and end of the block.

RRn

Repeat block of rows *n* times. Marks the start and end of the block.

S

Edit the copybook member. (For copybooks managed by other library products, view is substituted). This allows you to specify the criteria that identify the layout occurrences of this segment type or view the layouts of the segment types.

If the segment type to be edited has multiple layouts, FM/IMS displays the Segment Layout Selection panel. If the segment type has only one layout, FM/IMS displays the Segment Layout panel.

U

Update and edit the segment layout to which this copybook belongs.

V

View the copybook member.

X

Displays the Redefines / Range Specifications panel.

R

This column contains the value “R” if redefines or range parameters have been specified for the corresponding layout member.

I

This column contains:

Blank

When a new template is being created.

I

When the template has been created, the I value is only displayed on segment header rows when one of these conditions is true:

- Only one layout has been specified for the segment.
- Criteria have been provided for each layout for a given segment.

Segment

This is a display field. This is the name of a segment type within the DBD.

Layout member

The member name of the copybook containing the layout (or layouts) for the segment type.

To select a member from a concatenated list of members in the (up to six) partitioned data sets that you specified on the previous panel, either type a pattern in this field or leave it blank.



Tip: If the copybook members and segment types have matching names, then (if you are using a terminal emulator that supports a “*clipboard*”) you can select the names in the **Segment** fields, copy them to the clipboard, then paste them into the **Layout member** fields.

Segment description

On most panels where FM/IMS displays the name of the segment type, FM/IMS also displays this description. Entering a description is optional.

Lib

The sequence number of the library, relative to one, within the library list from which the copybook was selected.

01

Insert COBOL level-01 indicator. Can be:

Y

Instructs File Manager to insert an 01 for this copybook. For COBOL copybooks the inserted 01 is ignored if the copybook already contains an 01.



Note: This may cause compile errors for PL/I copybooks where an 01 is not required.

N

Instructs File Manager not to insert an 01 for this copybook. This is the default.

Field name

An optional field containing the name to be included in the generated 01 statement for the copybook. If you do not specify a name, File Manager generates one in the format “*FMNnnnn*”, where FMN is a constant and *nnnn* is a number starting at 1.

Parent panels

- [Template Entry panel on page 409](#)
- [Template Member Selection panel on page 411](#)

Child panels

- [Redefines / Range Specifications panel on page 363](#)
- [Segment Layout panel on page 370](#)
- [Segment Layout Selection panel on page 377](#)

Template Update : New Database Segments panel

When the DBD that a template is built from is modified to include new segment types, you need to provide the following information when you use the Template Update Utility to update the template:

- The names of all the new segment types in the DBD, and
- For each new segment type, the name of a copybook member that describes the segment layout.

You specify this information on the New Database Segment panel.

This panel is displayed when, on the Template Update Utility panel, the **New database segments** option is selected and the **Skip database segment list update** option is not selected.

Panel and field definitions

Figure 114. Template Update : New Database Segments panel

Process	Options	Help
FM/IMS	Template Update : New Database Segments	
	New segment	Layout member
1	<u>SHIRENP</u>	<u>SHIRENP</u>
2	<u>LINKSUB</u>	<u>LINKSUB</u>
3	_____	_____
4	_____	_____
5	_____	_____
6	_____	_____
7	_____	_____
8	_____	_____
9	_____	_____
10	_____	_____
11	_____	_____
12	_____	_____
Command ==> _____		
F1=Help	F2=Split	F3=Exit
F9=Swap	F10=Actions	F12=Cancel
	F4=CRetrieve	F7=Backward
		F8=Forward

New segment

The names of all the new segment types in the databases whose templates you are updating.

Layout member

For each new segment type, the name of a copybook member that describes its layout.



Note: If there are more than twelve new database segment types, use the batch execution to generate JCL which you can modify to add more segment-copybook pairs.

Parent panels

- [Template Update Utility panel on page 418](#)

Child panels

- [Advanced Member Selection panel on page 192](#)
- [JCL Submission panel on page 331](#)
- [Template Member Selection panel on page 411](#)

Template Update Utility panel

The Template Update Utility panel allows you to update an existing template either to the input data set or to an optional output data set.

You can:

- Use the copybook filters to select only templates referencing specified copybooks or copybook patterns.
- Change the copybook library data sets used to build the templates.
- Change the DBD data set used to build the template.
- Run the utility in batch or foreground.

Panel and field definitions

Figure 115. Template Update Utility panel

<u>P</u> rocess	<u>O</u> ptions	<u>H</u> elp
FM/IMS		Template Update Utility
Template:		
	Data set name .	'FMN.IMS.IVP.TEMPLATE'
	Member	
	Copybook filter	
Output Template:		
	Data set name .	
	Member mask . .	
Processing Options:		
	Enter "/" to select option	
-	Batch execution	- Replace member
-	Advanced member selection	- Specify copylib list
-	Skip member list	- Specify DBDLIB list
-	Skip database segment list update	- Specify IMS catalog
-	New database segments	- Check mode - no update
-	Preserve copybook library	- Forced update
Command ==>		
F1=Help	F2=Split	F3=Exit
F9=Swap	F10=Actions	F12=Cancel
	F4=CRetrieval	F7=Backward
		F8=Forward

Template

Data set name

(Required) A fully-qualified or generic data set name used to identify the data set which must be partitioned.

In a generic data set name, use the percent sign (%) to represent a single character, and an asterisk (*) to represent any number of characters within a qualifier. Two asterisks (**) represent any number of characters within any number of qualifiers.

The TSO prefix (as defined for your user ID) is used as the high-level qualifier for any name that is not enclosed in quotation marks.

For performance reasons, you should qualify the data set name as much as you can.

You can combine the member name with the dataset name in the form *Data set name(Member)*.

Member

Name of a member of a partitioned data set. If you leave the member name blank, or specify a member name pattern, FM/IMS displays a member name list. You can then select the required member by entering S in the Select field for the appropriate member.

A member name pattern can consist of any characters that are valid in a member name and two special pattern characters, the asterisk (*) and the percent sign (%):

*

Represents any number of characters. As many asterisks as required can appear anywhere in a member name. For example, if you enter *d*, a list all members in the data set whose name contains "d" is displayed.

%

A place holding character that means a single character. As many percent symbols as necessary may appear anywhere in a member name. For example, if you enter: %%%%, a list of all members in the data set whose name is 4 characters in length is displayed.

Copybook filter

Up to four member names or patterns to be used as a filter so that only templates referencing those copybooks, or copybooks that match the member patterns are selected for processing.

Output Template

Data set name

(Optional) A fully-qualified or generic data set name used to identify the output data set which must be partitioned. If this field is not specified, then the update takes place on the input data set.

You can specify a generic data set name using the percent (%) sign and asterisk (*) as described for the template data set name above.

The TSO prefix (as defined for your user ID) is used as the high-level qualifier for any name that is not enclosed in quotation marks. For performance reasons, you should qualify the data set name as much as you can.

You can combine the member name with the dataset name in the form *Data set name(Member)*.

Member mask

Specify a pattern to rename members in the output partitioned data set based upon the member names in the input partitioned data set. A member name pattern can consist of any characters that are valid in a member name and two special pattern characters: the asterisk (*) and the percent sign (%).

*

A place-holding character that means multiple characters with no change. Only one asterisk should appear in the mask. Any subsequent asterisk characters are treated as percent signs.

For example, if you enter:

```
ABC*
```

the renamed members will all begin with ABC followed by the remainder of the old member name.

%

A place-holding character that means a single character with no change. As many percent symbols as necessary may appear anywhere in a member name.

For example, if you enter:

```
%%%A*
```

the first 3 characters of the renamed members remain unchanged, the fourth character is replaced with the letter "A", and the remainder of the old member name is unchanged.

Processing Options:

Batch execution

Presents the JCL to run the function in batch. The JCL can be edited and submitted. You can use the Set Batch Job Card Information panel to tailor the default JOB card that FM/IMS uses to generate JCL.

Advanced member selection

Allows you to specify which members are to be processed based on member name, created date, last changed date, and the user ID by which the member was last updated. For each of these criteria, a mask or range of values can be entered.

Skip member list

Run without showing the member selection list. This option bypasses the member list panel and process all the qualifying members. If an error (like a duplicate output name) results from the specified parameters, then the member list panel is displayed with the errors highlighted.

Skip database segment list update

Skips updating the database segment lists in the templates. Select this option when there are no changes to the list of segment names specified in the DBDs that the templates are built from. When this option is selected, the DBDs that the templates are built from are not loaded or processed, resulting in improved performance.

New database segments

Select this option if one or more of the templates being processed are built from DBDs that have new segments. If you select this option and the **Skip database segment list update** option is not selected, the New Database Segments panel is displayed where you can specify the layout members for each of the new segments.

Preserve copybook library

Ensures that, if a copybook still exists in the library that it was previously found in and that library is in the list that the update is using, then that version of the copybook is used.

If you do not select this option, or the copybook no longer exists in the library it was previously found in, or that library is not in the list the update is using, then the utility searches the libraries in the order they are listed and uses the first version of the copybook that it finds.

Replace member

Replaces like-named members in an output partitioned data set.

Specify copylib list

Select this option if you want to specify the copybook libraries that the utility uses to build the templates.

If this option is selected, the Copybook Library List panel is displayed where you can specify the required copybook libraries. The copybook library list is stored in the updated template.

If this option is not selected, the utility uses the copybook library list stored in the template.

Specify DBDLIB list

Select this option if you want to specify the DBD libraries that the utility gets the DBDs from.

If this option is selected and the **Skip database segment list update** option is not selected, the DBD Library List panel is displayed. Use this panel to specify the required DBD libraries. The DBD library list is stored in the updated template.

If the **Specify IMS catalog** option is also selected, the utility only gets the DBDs from the specified DBD libraries when the DBDs that were used when the template's database segment list was last updated came from DBD libraries. When they came from an IMS™ catalog, the utility gets the DBDs from the specified IMS™ catalog.

When none of these options is selected and the DBDs that were used when the template's database segment list was last updated came from DBD libraries, the utility gets the DBDs from the DBD library list in the template.

Specify IMS catalog

Select this option if you want to specify the IMS™ catalog that the utility gets the DBDs from.

If this option is selected and the **Skip database segment list update** option is not selected, the IMS Catalog Specification panel is displayed. Use this panel to select the required IMS™ catalog. The SSID for the selected IMS™ catalog is stored in the updated template.

If the Specify DBDLIB list option is also selected, the utility only gets the DBDs from the specified IMS catalog when the DBDs that were used when the template's database segment list was last updated came from an IMS™ catalog. When they came from DBD libraries, the utility gets the DBDs from the specified DBD libraries.

When none of these options is selected and the DBDs that were used when the template's database segment list was last updated came from an IMS™ catalog, the utility gets the DBDs from the IMS™ catalog whose SSID is stored in the template.



Note: Only subsystems that use IMS-managed ACBs may be specified on the IMS Catalog Specification panel.

Check mode - no update

Runs the function without saving the resulting members. Normally used to check for errors.

Forced update

Performs the update even if no changes have been detected.



Note: When the **Skip database segment list update**, the **Specify IMS catalog** and the **Specify DBDLIB list** options are all not selected, the utility uses the DBDs in either the DBD library list stored in the template or the IMS catalog stored in the template.

Parent panels

- [Template/View/Criteria Set Menu panel on page 423](#)

Child panels

- [Advanced Member Selection panel on page 192](#)
- [DBD Library List panel on page 250](#)
- [IMS Catalog Specification panel on page 306](#)
- [JCL Submission panel on page 331](#)
- [Template Member Selection panel on page 411](#)
- [Template Update : New Database Segments panel on page 417](#)

Template/View/Criteria Set Menu panel

The Template/View/Criteria Set Menu panel is displayed when you select option 4 from the Primary Option Menu. From this menu you select a template, view or criteria set function.

Panel and field definitions

Figure 116. Template/View/Criteria Set Menu panel

Process	Options	Help
FM/IMS		Template/View/Criteria Set Menu
1	Templates	Create or update template
2	Views	Create, edit, or update view
3	Criteria Sets	Create, edit or update criteria set
4	Template update	Update template(s) utility
5	View update	Update view(s) utility
6	Criteria update	Update criteria set(s) utility
Command ==>		
F1=Help	F2=Split	F3=Exit
F9=Swap	F10=Actions	F12=Cancel
	F4=CRetriev	F7=Backward
		F8=Forward

1 Templates

Displays the Template Entry panel.

2 Views

Displays the View Entry panel.

3 Criteria Sets

Displays the Criteria Set Entry panel.

4 Template update

Displays the Template Update Utility panel.

5 View update

Displays the View Update Utility panel.

6 Criteria update

Displays the Criteria Set Update Utility panel.

Parent panels

- [Primary Option menu on page 346](#)

Child panels

- [Criteria Set Entry panel on page 226](#)
- [Criteria Set Update Utility panel on page 229](#)
- [Template Entry panel on page 409](#)
- [Template Update Utility panel on page 418](#)

- [View Entry panel on page 425](#)
- [View Update Utility panel on page 429](#)

Utility Menu panel

The Utility Menu panel is displayed when you select option 3 from the Primary Option Menu. From this menu you select a File Manager/IMS utility.

Panel and field definitions

Figure 117. Utility Menu panel

<u>P</u> rocess	<u>O</u> ptions	<u>H</u> elp
FM/IMS		Utility Menu
1	Delete/Define	Delete/Define database data sets
2	Initialize	Initialize Database
3	Extract	Extract data from database
4	Load	Load database
5	Print	Print data in batch
6	Batch Edit	Edit data in batch
7	Batch Browse	Browse data in batch
8	Audit trail	Print Audit Trail
Command ==>		
F1=Help	F2=Split	F3=Exit
F9=Swap	F10=Actions	F12=Cancel
	F4=CRetrieve	F7=Backward
		F8=Forward

Parent panels

- [Primary Option menu on page 346](#)

Child panels

- [Batch Browse Entry panel on page 195](#)
- [Batch Edit Entry panel on page 201](#)
- [Delete/Define Entry panel on page 251](#)
- [Extract Entry panel on page 275](#)
- [Initialize Entry panel on page 318](#)
- [Load Entry panel on page 335](#)
- [Print Audit Trail panel on page 349](#)
- [Print Entry panel on page 351](#)

View Entry panel

To create, update or edit views, select option 4.2 (Templates then Views) from the Primary Option menu. FM/IMS displays the View Entry panel:

Panel and field definitions

Figure 118. View Entry panel

Process	Options	Help
FM/IMS		View Entry Panel
CT	Create view from template	E Edit view
CM	Create view from model	U Update view from template
Template:		
	Data set name . 'FMN.IMS.IVP.TEMPLATE'	
	Member DJ1E	
View:		
	Data set name . 'FMN.IMS.IVP.VIEW'	
	Member DJ1EVJU	
Model view:		
	Data set name .	
	Member	
Command ==> ct		
F1=Help	F2=Split	F3=Exit
F9=Swap	F10=Actions	F12=Cancel
	F4=CRetriev	F7=Backward
		F8=Forward

To use this panel, first decide on the command you want to use, then fill in the required fields (described for each command, in the following list), then type the command on the command line and press Enter:

CT

Creates a new view from a template.

In this field...

Enter these details...

Template

The name of the partitioned data set that holds the template to be used to create the view.

View

Sequential data set name, or PDS and member name, where you want to save the new view. The

Data set name field may also include a member name or name pattern in parentheses. If the member is specified here, the associated **Member** field must be blank.

CM

Creates a new view by copying an existing ("*model*") view.

In this field...

Enter these details...

Model view

Sequential data set name, or PDS and member name, of the view you want to copy (use as a "*model*" for the new view). The **Data set name** field may also include a member name or name pattern in parentheses. If the member is specified here, the associated **Member** field must be blank.

View

Sequential data set name, or PDS and member name, where you want to save the new view. The **Data set name** field may also include a member name or name pattern in parentheses. If the member is specified here, the associated **Member** field must be blank.

E

Edits the view.

In this field...

Enter these details...

View

Sequential data set name, or PDS and member name, of the view you want to edit. The **Data set name** field may also include a member name or name pattern in parentheses. If the member is specified here, the associated **Member** field must be blank.

U

Updates an existing view from the template that it was created from.

In this field...

Enter these details...

View

Sequential data set name, or PDS and member name, of the existing view you want to update. The **Data set name** field may also include a member name or name pattern in parentheses. If the member is specified here, the associated **Member** field must be blank.



Note: This command ignores any template you specify in the **Template** field. Instead, it obtains the PDS and member of the template from the view.

Use this command when minor changes have been made to the template that the view was created from.

If significant changes have been made to the template, then the update process might not produce the expected results. In this case, use the **CT** command to recreate the view from the template and then the **E** command to edit it.

If you enter the name of a partitioned data set in the **View**, **Model view** or **Template** fields, but you leave the member name blank (or specify a pattern), then FM/IMS displays a member selection list.

Parent panels

- [Template/View/Criteria Set Menu panel on page 423](#)

Child panels

- [Segment Selection panel on page 379](#)

View Member Selection panel

The View Member Selection panel is displayed when you specify either no view member name, or a view member pattern on the Browse Entry, Edit Entry, Print Entry, Batch Edit Entry, Batch Browse Entry, View Entry, or View Update Utility panel.

If no view member name is supplied, all the members in the view data set are shown on the panel. If a view member pattern is supplied, all the members with names that match the pattern are shown on the panel.

To select a criteria member, type **s** in the **Cmd** field and press Enter.

When the selection list is for the field on the Browse, Edit, Print, Batch Edit, Batch Browse, or View Entry panel, you can only select one member. When the selection list is for the field on the View Update Utility panel, you can select multiple members.

The panel also allows you to:

- Select the member attributes that are displayed.
- Select the order in which the member attributes are displayed.
- Specify the width of the column used to display each member attribute.
- Use member attribute patterns to filter the member list.
- Browse or view the member.

When the selection list is for the field on the View Update Utility panel, you can also use the view editor to edit and save the displayed view members.

For a detailed description of the panel fields and functionality, see "Member Selection panel" in the *User's Guide and Reference*.

Panel and field definitions

Figure 119. View Member Selection panel

Process		Options		Help							
FM/IMS		View Member List						Row 00001 of 00122			
DSNAME	FM.XTEST.VIEW										
	Name	Prompt	Typ	Created	Updated	Lang	Ver	Descri	▶		
	*	*	*	*	*	*	*	*			
_____	#TEST1		VW	2008/07/07	2009/03/17	09:15:07	COBOL	2			
_____	#TEST2		VW	2008/07/07	2009/03/17	09:15:07	COBOL	2			
_____	#TEST3		VW	2008/07/07	2009/03/17	09:15:07	COBOL	2			
_____	#TEST4		VW	2008/07/07	2009/03/17	09:15:07	COBOL	2			
_____	@@@		VW	2006/03/09	2006/03/14	16:06:28	COBOL	2			
_____	@@@@		VW	2009/07/24	2009/08/15	15:05:45	COBOL	2			
_____	AHRD#VJU		VW	2009/07/28	2009/07/28	21:47:53	COBOL	2			
_____	AHRD#1V		VW	2008/07/02	2009/03/16	10:03:39	PL/I	2			
_____	AHRD#236		VW	2008/07/02	2008/07/07	18:31:50	PL/I	2			
_____	ANLIM1		VW	2001/11/01	2001/11/01	09:06:22	COBOL	1			
_____	ATRD#SS1		VW	2008/07/02	2008/07/07	18:32:32	PL/I	2			
_____	ATRD#SS2		VW	2008/07/02	2008/07/07	18:32:32	PL/I	2			
_____	ATRD#SS3		VW	2008/07/02	2008/07/07	18:32:32	PL/I	2			
_____	ATRD#SS4		VW	2008/07/02	2008/07/07	18:32:32	PL/I	2			
_____	ATRD#V1		VW	2008/07/02	2008/07/07	18:32:32	PL/I	2			
_____	ATRD#V3		VW	2008/07/02	2008/07/07	18:32:32	PL/I	2			
_____	ATRD#V91		VW	2008/07/02	2008/07/07	18:32:32	PL/I	2			
_____	ATRD#V92		VW	2008/07/02	2008/07/07	18:32:32	PL/I	2			
_____	ATRD#4VX		VW	2008/07/02	2009/06/29	16:57:06	PL/I	2			
_____	ATRDV99		VW	2009/08/12	2009/08/12	14:55:48	COBOL	2			
_____	AUBD#V1		VW	2008/07/07	2010/01/20	11:30:50	COBOL	2			
_____	AUBD#V2		VW	2008/07/07	2010/01/20	11:30:50	COBOL	2			
_____	AUBD#V3		VW	2008/07/02	2010/07/02	13:02:26	PL/I	2			
Command ===>								Scroll PAGE			
F1=Help	F2=Split	F3=Exit	F4=CRetriev	F5=RFind	F7=Backward						
F8=Forward	F9=Swap	F10=Left	F11=Right	F12=Cancel							

Parent panels

- [Advanced Member Selection panel on page 192](#)
- [View Entry panel on page 425](#)
- [View Update Utility panel on page 429](#)
- [Browse Entry panel on page 214](#)
- [Edit Entry panel on page 266](#)
- [Print Entry panel on page 351](#)
- [Batch Edit Entry panel on page 201](#)
- [Batch Browse Entry panel on page 195](#)

Child panels

- [JCL Submission panel on page 331](#)

View Update Utility panel

The View Update Utility panel allows you to update existing views either to the input data set or to an optional output data set.

You can:

- Use the template filters to select only views based on a specified template or a template that matches the pattern.
- Change the template data set used to update the views.
- Run the utility in batch or foreground.

Panel and field definitions

Figure 120. View Update Utility panel

Process	Options	Help
FM/IMS View Update Utility		
View:		
Data set name . . .	'FMN.IMS.IVP.VIEW'	
Member	DJ1E*	
Template filter . .		
Output View:		
Data set name . . .		
Member mask		
Template:		
Data set name . . .		
Processing Options:		
Enter "/" to select option		
<input type="checkbox"/> Batch execution	<input type="checkbox"/> Replace member	
<input type="checkbox"/> Advanced member selection	<input type="checkbox"/> Specify Template data set	
<input type="checkbox"/> Skip member list	<input type="checkbox"/> Check mode - no update	
<input type="checkbox"/> Forced update	<input type="checkbox"/> Specify subsystem	
Command ==>		
F1=Help	F2=Split	F3=Exit
F9=Swap	F10=Actions	F12=Cancel
	F4=CRetrieval	F7=Backward
		F8=Forward
		Scroll PAGE

View

Data set name

(Required) A fully-qualified or generic data set name used to identify the data set which must be partitioned.

In a generic data set name, use the percent sign (%) to represent a single character, and an asterisk (*) to represent any number of characters within a qualifier. Two asterisks (**) represent any number of characters within any number of qualifiers.

The TSO prefix (as defined for your user ID) is used as the high-level qualifier for any name that is not enclosed in quotation marks.

For performance reasons, you should qualify the data set name as much as you can.

You can combine the member name with the dataset name in the form *Data set name(Member)*.

Member

Name of a member of a partitioned data set. If you leave the member name blank, or specify a member name pattern, FM/IMS displays a member name list. You can then select the required member by entering S in the Select field for the appropriate member.

A member name pattern can consist of any characters that are valid in a member name and two special pattern characters, the asterisk (*) and the percent sign (%):

*

Represents any number of characters. As many asterisks as required can appear anywhere in a member name. For example, if you enter `*d*`, a list all members in the data set whose name contains "d" is displayed.

%

A place holding character that means a single character. As many percent symbols as necessary may appear anywhere in a member name. For example, if you enter: `%%%`, a list of all members in the data set whose name is 4 characters in length is displayed.

Template filter

Enter up to four template member names or patterns to limit the selection and processing to those views that are based on one of the specified templates, or a template that matches one of the specified patterns.



Note: As the Template member name is the same as the name of the database, this is also a database filter.

Output View

Data set name

(Optional) A fully-qualified or generic data set name used to identify the output data set which must be partitioned. If this field is not specified, then the update takes place on the input data set.

You can specify a generic data set name using the percent (%) sign and asterisk (*) as described for the view data set name above.

The TSO prefix (as defined for your user ID) is used as the high-level qualifier for any name that is not enclosed in quotation marks. For performance reasons, you should qualify the data set name as much as you can.

You can combine the member name with the dataset name in the form *Data set name(Member)*.

Member mask

Specify a pattern to rename members in the output partitioned data set based upon the member names in the input partitioned data set. A member name pattern can consist of any characters that are valid in a member name and two special pattern characters: the asterisk (*) and the percent sign (%).

*

A place-holding character that means multiple characters with no change. Only one asterisk should appear in the mask. Any subsequent asterisk characters are treated as percent signs.

For example, if you enter:

```
ABC*
```

the renamed members will all begin with ABC followed by the remainder of the old member name.

%

A place-holding character that means a single character with no change. As many percent symbols as necessary may appear anywhere in a member name.

For example, if you enter:

```
%%%A*
```

the first 3 characters of the renamed members remain unchanged, the fourth character is replaced with the letter "A", and the remainder of the old member name is unchanged.

Template

Data set name

This field is only used when the **Specify Template data set** option is selected. When this option is selected, the templates in the specified data set are used to update the views (rather than the template referenced in each view) and, if the update is successful, the utility changes the template data set name in the view to the specified data set name.

Processing Options:

Batch execution

Presents the JCL to run the function in batch. The JCL can be edited and submitted. You can use the Set Batch Job Card Information panel to tailor the default JOB card that FM/IMS uses to generate JCL.

Advanced member selection

Allows you to specify which members are to be processed based on member name, created date, last changed date, and the user ID by which the member was last updated. For each of these criteria, a mask or range of values can be entered.

Skip member list

Run without showing the member selection list. This option bypasses the member list panel and process all the qualifying members. If an error (like a duplicate output name) results from the specified parameters, then the member list panel is displayed with the errors highlighted.

Forced update

Performs the update even if no changes have been detected.

Replace member

Replaces like-named members in an output partitioned data set.

Specify template data set

Allows you to specify the Template data set that the utility uses to update the views.

Select this option if you want your views to be based on templates that are in the data set you specify in the Template data set name field. The specified template data set name is stored in the updated views and they are flagged as being based on a static template.

If the Specify subsystem option is also selected, only views that are based on static templates are updated in this way. Those that are based on dynamic templates are updated as described in the help for the Specify subsystem option.

When neither of these options are selected and the view is based on a static template, the utility bases the view on the template whose name is stored in the view.

Specify subsystem

Select this option if you want your views to be based on *dynamic templates*. These are templates that are dynamically generated from data in an IMS™ catalog or DBD libraries.

If this option is selected, the IMS Subsystem Specification panel is displayed. Use this panel to specify the source of the data from which the template is generated. The name of the data source is stored in the updated views and they are flagged as being based on a dynamic template.

If the Specify Template data set option is also selected, only views that are based on dynamic templates are updated in this way. Those that are based on static templates are updated as described in the help panel for the Specify Template data set option.

When neither option is selected and the view is based on a dynamic template, the utility bases the view on a template that is generated from the data source that is specified in the view.

Check mode - no update

Runs the function without saving the resulting members. Normally used to check for errors.

Parent panels

- [Template/View/Criteria Set Menu panel on page 423](#)

Child panels

- [Advanced Member Selection panel on page 192](#)
- [JCL Submission panel on page 331](#)
- [View Member Selection panel on page 428](#)

Chapter 11. Commands

This chapter describes the syntax, parameters and operation of the primary and line commands that can be used in various FM/IMS panels. Within each command description, the panels and functions in which the command is available are listed. Where a command has differing functionality on different panels, an explanation of how the command operates in each context is provided.

Primary commands are entered on the Command line of a panel. Some primary commands have equivalent function keys and, where applicable, the default settings for these keys are listed. However, because keylists can be customized through ISPF, your function key settings may differ from those described in this document.

Where the syntax allows you to specify more than one operand, you can use either a blank or a comma as a separator between each operand.

For example, both of the following commands are correct:

```
SORT NAME LIB  
SORT NAME,LIB
```

ABOUT primary command

The ABOUT command displays the current File Manager version number and the PTF number of the File Manager IMS component in a window. The pop-up also shows the copyright information and any notes that are shipped with the product.

Syntax

▶▶ ABOUT ▶◀

Availability

- Available on all panels

Related tasks and examples

- [VER primary command on page 505](#)
- [Checking your FM/IMS version on page 28](#)

AUTOSAVE primary command (Edit only)

The AUTOSAVE primary command turns the FM/IMS automatic checkpoint facility ON or OFF.

Syntax

▶▶ AUTosave { ON / OFF } ▶◀

ON

When AUTOSAVE is on, FM/IMS increments a count by 1 each time you press an action key (for example, Enter, a scroll key such as F8 or F7, and so on) and data changes have been requested. Editing changes are automatically committed to the database when the value of the counter reaches the value specified in the Edit Checkpoint Frequency field on the DLI Mode Options panel (option 0.6.4) or on the BMP Mode Options panel (option 0.7.2), or when the number of changes resulting from a CHANGE ALL command reaches the value specified in the Change All Checkpoint Frequency field.

OFF

Editing changes are saved in memory as you work, but are not committed to the database until you issue a SAVE command, or exit from the Database Positioning panel, or until the buffers become full.

AUTOSAVE ON or OFF can be set in DLI Mode Options panel (option 0.6.4) or in the BMP Mode Options panel (option 0.7.2). and in the installation macro FMN1POPI.



Note: AUTOSAVE ON is the default.

Availability

- [IMS data panel on page 309](#)

Related tasks and examples

- [Committing changes to your database on page 131](#)
- [Editor Options panel on page 272](#)

BOTTOM primary command

On the IMS Data panel, when using CHAR, HEX, LHEX or TABL display modes, the BOTTOM primary command scrolls to the last segment in the database (or, if you are using a view, the last selected segment in the database). In other panels, where the display exceeds one screen height, the BOTTOM command scrolls to the bottom of the current panel. You can abbreviate the BOTTOM command.

Syntax

▶▶ Bottom ▶▶

In Edit or Browse multi-segment display modes (CHAR, HEX, LEX or TABL), this might move the sliding window. That is, if you enter the TOP command to move to the top of the sliding window, then you enter the BOTTOM command, then you enter TOP again, the top of the sliding window might no longer be at the same segment as before.

Availability

- On all panels where the display exceeds one page.

Related tasks and examples

- [Scrolling to see data on page 68](#)
- [How the sliding window affects scrolling and database position on page 71](#)

CANCEL primary command

The CANCEL primary command (F12) exits a panel without saving any changes to the panel variables.

If used on the Database Positioning panel when you are in Edit, the CANCEL primary command discards any editing changes that have been processed but not yet committed to the database via a SAVE command or the AUTOSAVE function.

If used on the IMS Data panel when you are in Edit, the CANCEL primary command returns you to the Database Positioning panel, but does NOT discard the changes you have made. To discard editing changes, you must CANCEL from the Database Positioning panel and you are asked to confirm that you want to discard those changes.



Note:

1. Changes to data are only processed when you press Enter or issue a command. If you overwrite some data but do not press Enter or issue any other command before you CANCEL, these changes are not processed and are discarded when you exit from the IMS Data panel.
2. To backout changes while in the IMS Data panel, use the UNDO command.

QUIT is a synonym for CANCEL.

Syntax

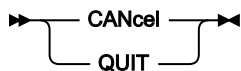

Issuing the CANCEL command on the Database Positioning panel backs out all your editing changes since the last checkpoint. This is provided that you are editing in BMP mode or, if you are editing in DLI mode, the following conditions are true:

- The IMS log option on the DLI Mode Parameters panel is set to 1. Keep, 2. Keep when updates or 3. Delete.
- The Dynamic backout option on the DLI Mode Parameters panel is selected.
- The Edit is using either a dynamic PSB or a static PSB that has an IO PCB.

If you are editing in DLI mode and one or more of these conditions is not true, FM/IMS issues an error message.

If you press ENTER (to confirm the cancel request), FM/IMS:

- Issues a ROLB call which backs out the changes since the last checkpoint.
- EXITS the Database Positioning panel.

If you enter the END or EXIT command, FM/IMS returns to the Database Positioning panel.



Note: FM/IMS does not save data until you exit the Database Positioning panel unless you issue the SAVE primary command.

Availability

- All panels.

Related tasks and examples

- [END primary command on page 453](#)
- [QUIT primary command on page 485](#)
- [SAVE primary command \(Edit only\) on page 491](#)
- [UNDO primary command on page 503](#)
- [Exiting from FM/IMS on page 30](#)

CAPS primary command

The CAPS or CAPS ON commands instruct FM/IMS to convert fields or segments to uppercase, when a subsequent data change takes place. The change affects either the field in which the change is entered or the entire segment, depending upon the current display format:

- In CHAR, HEX or LHEX display format, the entire segment is translated to uppercase.
- In SNGL or TABL display format, only the current field is translated to uppercase.

Any CAPS command temporarily overrides the current setting of the **Translate data in data area to uppercase on input** field in the Edit/Browse Options panel.

Syntax



ON

Turns the "convert to uppercase" feature on for the current editing session.

OFF

Turns the "convert to uppercase" feature off for the current editing session.

Availability

- [IMS data panel on page 309](#)
- [Database Positioning panel on page 239](#)

- [Key Specification panel on page 332](#)
- [Insert Segment panel on page 323](#)

Related tasks and examples

- [Editor Options panel on page 272](#)

CCSID primary command

In an editor session, the CCSID command toggles on and off the display of the CCSID assigned to each field, if applicable, when using SNGL display format.

Syntax

Figure 121. Syntax

▶▶ CCSID ◀◀

Availability

- [IMS data panel on page 309](#)

Related tasks and examples

- [Selecting a display format on page 61](#)
- [Editor Options panel on page 272](#)

CE (Find Error) primary command

The CE (Change Error) primary command allows you to change numeric fields flagged as being in error (all asterisks in the field display) to a specific numeric value.

The find argument for the CE command is assumed to be a numeric field in error.

The CE command is only valid in SNGL or TABL display formats, when in edit or view.

For details on limiting the columns, fields or records searched by the CE command, see [Limiting the search in FIND or CHANGE on page 139](#).

Syntax

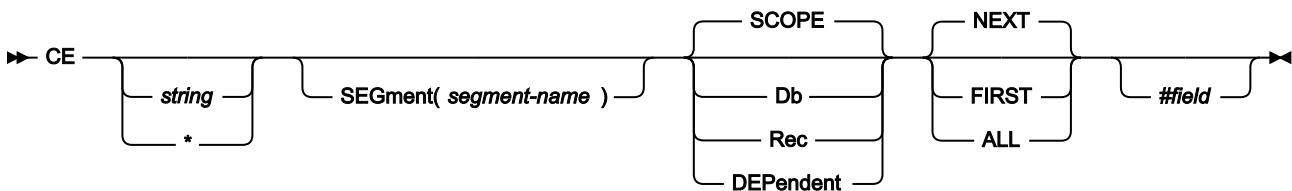

string

A numeric value used to replace the invalid numeric value.

*** (asterisk)**

When used in place of the replacement string, uses the replacement string specified on the previous CE or CHANGE command as the replacement string. CE with no parameters, following a CE or CHANGE with a replacement string, acts the same as `CE *`.

segment-name

When the SEGMENT parameter is specified, the search is restricted to occurrences of the segment type, *segment-name*. The parameter is only permitted when SHOW SUP is on, or when you are not using a view.

SCOPE

Search range is the current scope.

DB

Search the entire database.

REC

Search is restricted to the current database record.

DEPENDENT

Search is restricted to the dependents of the current segment. The parameter is only permitted when SHOW SUP is on, or when you are not using a view.

NEXT

Searches forwards from the cursor position (if the cursor is within the data portion of the screen), or from the beginning of the topmost record displayed on the screen, for the next occurrence of an invalid numeric field.

If the next occurrence of the string is in an excluded record and you do not limit the search to not-excluded records, only the first excluded record containing the string is shown.

FIRST

Searches from the top of data for the first occurrence of an invalid numeric field.

ALL

Searches forwards from the top of data. Same as FIRST except that ALL also displays the total number of invalid numeric fields in the records searched.

#field

A field reference, specifying the field to be included in the search. For example: `#3`.

Availability

- [IMS data panel on page 309](#)

Related tasks and examples

- [Finding invalid data on page 137](#)

CHANGE primary command (Edit only)

The CHANGE primary command finds and changes one or more occurrences of a character string (or field value) in the data being edited.

When one or more occurrences of a string are found, FM/IMS places the cursor immediately after the first occurrence. If necessary, it scrolls the data to bring the string into view.

For date and time fields that are displayed using the output format defined in the view, FM/IMS searches the displayed values for *string1* and if found replaces *string1* with *string2* in the displayed value.

When you are using a view, the setting of the SHOW SUP command affects the segments that are searched. With SHOW SUP OFF, only those segments matching the current segment type and layout are searched. With SHOW SUP ON, the search is not limited to segments of the current segment type and layout.

The CHANGE primary command does not change an occurrence of a string when any part of the string is in the key field of the segment.

FM/IMS places the cursor immediately after the first occurrence of the string. If necessary, it scrolls the data to bring the string into view.

The CX command displays an Extended Command Entry panel, in which you can enter long arguments that may not fit on the Command line.

Syntax

Figure 122. CHANGE syntax in edit

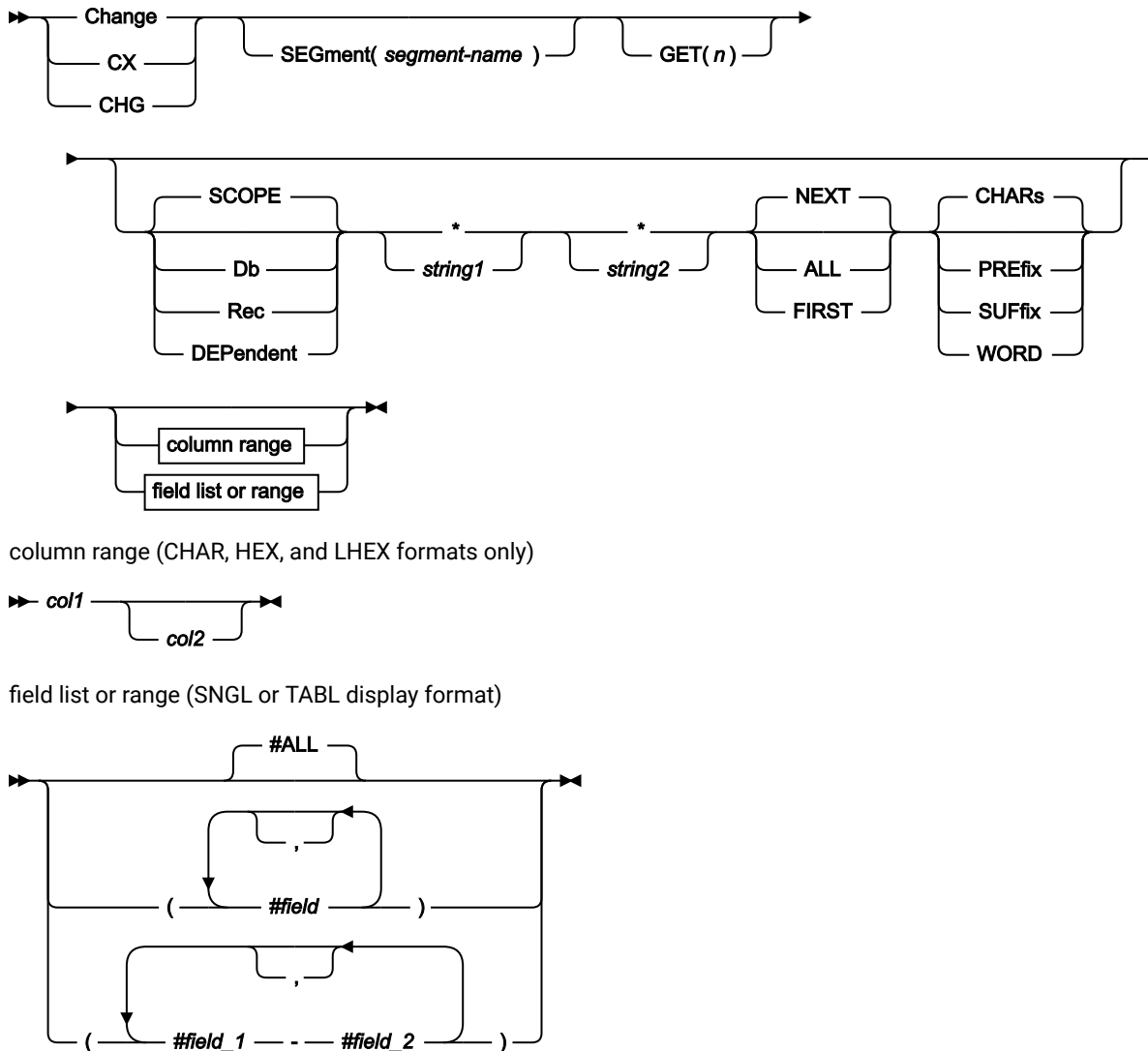

You can specify parameters in any order.

segment-name

When the **SEGMENT** parameter is specified, the search is restricted to occurrences of the segment type, *segment-name*. The parameter is only permitted when **SHOW SUP** is on, or when you are not using a view.

GET(n)

Limits the number of segments searched to *n*.

SCOPE

Search range is the current scope.

DB

Search the entire database.

REC

Search is restricted to the current database record.

DEPENDENT

Search is restricted to the dependents of the current segment. The parameter is only permitted when SHOW SUP is on, or when you are not using a view.

* (asterisk)

When used in place of the search string, uses the search string specified on the previous CHANGE command as the search string.

When used in place of the replacement string, uses the replacement string specified on the previous CHANGE command as the replacement string.

The position of the * is important for CHANGE. If it is positioned before a string, it indicates the previous search argument; that is, it is treated as the first string. If a string is found prior to the *, then it is treated as the second string (the change argument), taking the change argument from the previous CHANGE command. To use both the previous search string and the previous change string, specify `CHANGE * *`.

string1

The string to be searched for, which can be up to 100 characters long.

The string can be:

- A character string not starting or ending with a single quotation mark and not containing any embedded blanks or commas. The case of the string is ignored. Uppercase and lowercase representations of the same character match.

For example:

```
CHANGE before after
```

changes the strings *“before”*, *“Before”*, and *“BEFORE”*.

- A character string enclosed in single quotation marks. The string can contain blanks and commas. The case of the string is ignored. The string can be a null string (`''`). If *string1* is a null string, then *string2* is inserted at the current column position.
- C followed by a character string enclosed in quotation marks (C'Frog'), or a character string enclosed in quotation marks followed by c ('Frog'C). The string can contain blanks and commas. The string must match exactly (including case).
- P preceded or followed by a picture string enclosed in single or double quotation marks to describe a type of string to be found rather than the exact characters. It can contain blanks, alphabetic and numeric characters which represent themselves, or any of the special characters listed here, each of which represents a class of characters:

=	Any character.
@	Alphabetic characters.
#	Numeric characters.
\$	Special characters.
& notsym;	Non-blank characters.
.	Invalid characters.
-	Non-numeric characters.
<	Lowercase alphabets.
>	Uppercase alphabets.

When this notation is used, numeric, bit and unicode fields (for SNGL and TABL display formats) are excluded from the search process.

- X followed by a hexadecimal string enclosed in single quotation marks (`x'c1c2'`).
- A numeric value (SNGL or TABL display format only). The algebraic value of *string1* must match the algebraic value of the numeric field. The lengths (number of digits) of *string1* and of the numeric field are not significant. Similarly, the data type of the numeric field is not significant. For example, a string of 123 matches a packed-decimal field containing 00123 or a floating-point field containing 1.230E+02. An unsigned value in *string1* is considered to be positive.
- A DBCS string or a mixed DBCS and non-DBCS string. If the Shift-out (x'0E') is the first character of the argument, it is stripped off prior to searching for the string. If shift-in (X'0F') is the last character of the argument, it is stripped off prior to searching for the string.

string2

The string used to replace *string1*, which can be up to 100 characters long.

The string can be:

- A character string not starting or ending with a single quotation mark and not containing any embedded blanks or commas. If CAPS ON is in effect, then *string2* is translated to uppercase.
- A character string enclosed in single quotation marks. The string can contain blanks and commas. Case is respected and retained unless CAPS ON is in effect, in which case *string2* is translated to uppercase. The string can be a null string (').
- C followed by a character string enclosed in quotation marks (C'Frog'), or a character string enclosed in quotation marks followed by c ('Frog'C). The string can contain blanks and commas. Case is respected and retained. The string can be a null string (c').
- A DBCS or a mixed DBCS and non-DBCS string. The shift-out (X'0E') and shift-in (X'0F') at the start and end of the string are adjusted in such a way that the integrity of the DBCS data is not compromised.
- P preceded or followed by a picture string enclosed in single or double quotation marks to describe the change to be made. You can change characters from uppercase to lowercase or from lowercase to uppercase, or leave the field the same using these string special characters.

=

Any character.

<

Lowercase alphabets.

>

Uppercase alphabets.

Examples of picture strings used with the CHANGE command:

```
c p'. ' x'00'
```

Change next invalid character to hex x'00'.

```
c p'###' 100
```

Change next 3-digit number to 100.

```
c all 73 80 p'=' " "
```

Put blanks in columns 73 to 80.

```
c all p'-' 1 10 "0"
```

Change all non-numeric characters in columns 1 to 10 into the char "0".

```
c p'<' p'>'
```

Change any lowercase to uppercase.

```
c p'a>' p'=<'
```

Change character a, any uppercase to character a, lowercase.

```
c p'>' '᳚'
```

Change any uppercase to "not sign" (note: "not sign" has no special meaning in a "to" string).

`c p'<# ' p'>='`

Change any lowercase, any number to upper case, the number found.

When this notation is used, numeric, bit and unicode fields (for SNGL and TABL display formats) are excluded from the search process.

- X followed by a hexadecimal string enclosed in single quotation marks (`X'C1C2'`). If CAPS ON is in effect, then all hexadecimal representations of lowercase characters are translated to their equivalent uppercase characters.
- A numeric value (SNGL or TABL display format only).
- A DBCS string or a mixed DBCS and non-DBCS string. The shift-out (X'0E') and shift-in (X'0F') at the start and end of the string are adjusted in such a way that the DBCS data integrity is not compromised.

NEXT

The CHANGE command searches for the next occurrence of the string, *string1*, in the search range, starting at the cursor location (if the cursor is within the data portion of the display), or at the top of the displayed page (if the cursor is outside the data portion of the display).

If *string1* is found, FM/IMS changes it to *string2* and places the cursor immediately after *string2*.

If *string1* is not found by the end of the search range, or if the cursor location is after the last segment in the search range, FM/IMS displays a message indicating that the end of the search range has been reached and redisplay the page that was displayed prior to the search. To resume the search from the top of the search range, use the RFIND (F5) primary command or the RCHANGE (F6) primary command.

FIRST

The CHANGE command searches for the first occurrence of the string, *string1*, in the search range, starting at the beginning of the first segment in the search range.

If *string1* is found, FM/IMS changes it to *string2* and places the cursor immediately after *string2*.

If *string1* is not found in the search range, FM/IMS displays a message indicating that the string was not found and redisplay the page that was displayed prior to the search.

ALL

The CHANGE command searches for all occurrences of the string, *string1*, in the search range, starting at the beginning of the first segment in the search range and continuing to the end of the search range.

If *string1* is found one or more times, FM/IMS:

- Changes all occurrences of *string1* to *string2*.
- Places the cursor immediately after the first changed occurrence.
- Displays a message indicating how many times the string was changed.

If *string1* is not found in the search range, FM/IMS displays a message indicating that the string was not found and redisplay the page that was displayed prior to the search.

CHARS

Matches the search string anywhere in the data.

PREFIX

Matches the search string wherever it appears as a prefix in the data. To be a prefix, the matched text must be preceded by a non-alphanumeric character or be the start of a line or field, and must be followed by an alphanumeric character.

SUFFIX

Matches the search string wherever it appears as a suffix in the data. To be a suffix, the matched text must be preceded by an alphanumeric character, and must be followed by a non-alphanumeric character or be the end of a line or field.

WORD

Matches the search string wherever it appears as a word in the data. To be a word, the matched text must be preceded by a non-alphanumeric character or be the start of a line or field, and must be followed by a non-alphanumeric character or be the end of a line or field.

col1

The starting column of the search. If *col1* is specified without *col2*, *string1* must start in *col1* to be found. If both *col1* and *col2* are specified, *string1* must be completely contained within the designated columns.



Note: When column ranges are specified and the data is displayed in SNGL or TABL formats, the search is performed in the order that the data occurs, which may not be the order in which the fields are displayed. Numeric field values are not considered in this type of search.

When column ranges are specified, then a string comparison is performed, even for numeric fields.

col2

The ending position of the search. If *col2* is larger than the segment size, the segment size is used.

#ALL

Each field is searched according to its template attributes.

#field

The field reference number for a field in the layout for the current segment type. Used in SNGL or TABL format to limit the search to the specified field or fields within the currently displayed segment type.

To specify more than one field reference, they must be either enclosed in parentheses (optionally separated by commas), or separated by commas but without any intervening spaces. For example, (*#17 #22*), (*#17, #22*), and *#17,#22* are valid field reference specifications.

For alphanumeric fields, the string is found if it is completely contained within one of the designated fields. For example: `CHANGE DB ALL xxxx yyyy #5,#6` finds and changes all segments of the current type containing "xxxx" within either of the fields with field references #5 and #6.

For numeric fields, the string is found if the value of either of the numeric fields is equal to the value specified by the string.

The field reference number is relevant to the layout of the segment being searched during the change operation. Hence, when using a field reference number and SHOW SUP ON is in effect (segments are not grouped), this may result in changing data in fields you did not expect when the fields specified are not common between layouts.

For example, `CHANGE DB ALL 123 256 #8,#9` finds and changes all segments of the current (numeric or character) type:

- Containing the value 123 in either of the numeric fields with field references #8 and #9.
- Containing the string 123 in either of the character fields with field references #8 and #9

If the argument is a DBCS string, only data between a shift-out and shift-in is searched for a match. For example, if your search string was `x'0E40400F'` (that is, shift-in blank blank shift-out), the CHANGE command would not find two consecutive blanks in non DBCS data.

#field_1

The first field reference of a range of fields. It cannot be subscripted. If the `#field_1` field reference value is less than the lowest displayed field reference value, the lowest displayed field reference value is used.

#field_2

The last field reference of a range of fields. It cannot be subscripted. If the `#field_2` field reference value is greater than the highest displayed field reference value, the highest displayed field reference value is used.

The `#field_1` and `#field_2` field reference values must be separated by a hyphen (-). Spaces are permitted between the hyphen and the field reference values.

If `#field_1` is a higher value than `#field_2`, the search process reverses the operands.

Availability

- Edit only
- [IMS data panel on page 309](#)

Related tasks and examples

[Figure 123: Extended Command Entry pop-up panel for the CHANGE command on page 448](#) shows the Extended Command Entry pop-up panel for the CHANGE command. In this example, any occurrences of the string "The Cappuccino Strip" in FM/IMS are to be changed to the string "LONG AND WINDING ROAD".

Figure 123. Extended Command Entry pop-up panel for the CHANGE command

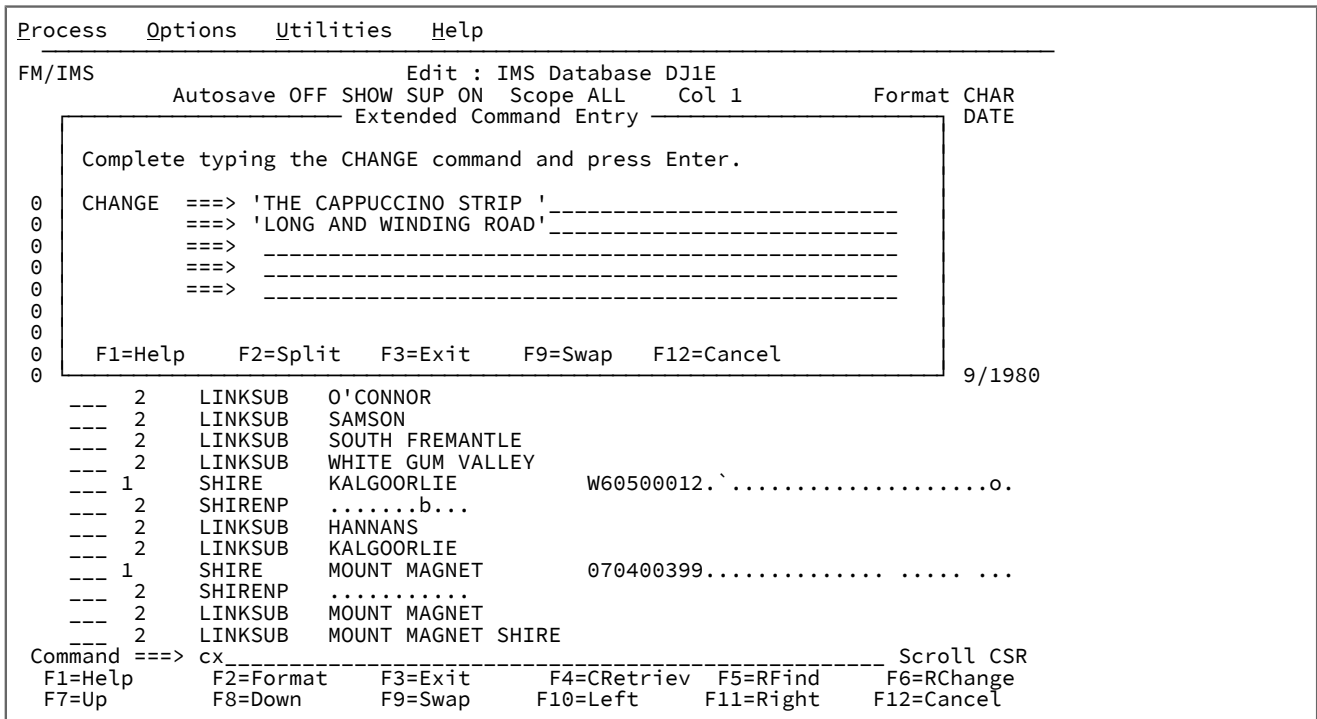

CHILD primary command

The CHILD primary command allows you to change your position in the database from the current segment to any dependent segment of the current segment.

Syntax

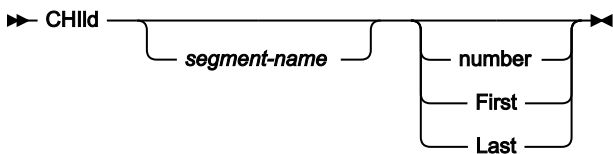

segment-name

The name of the segment type to which you want to scroll. The segment type must be one of the segment types defined in the DBD to be a hierarchical dependent of the current segment.

 **Note:**

1. If FM/IMS doesn't find an exact match for *segment-name* within the DBD, it searches the list of segments in the DBD to determine if any of the segment names contain the value entered. The first segment name that contains a match is used with the CHILD command. For example:



Availability

- All panels within the Browse, Edit, Utilities (except Audit trail) and Template/View/Criteria Set dialogs, except the initial Entry panel for each function.

DBDLIST primary command

The DBDLIST command allows you to view and modify the DBD library list specified in the template you are editing. The command is available on the Template Specification panel when the template specifies a DBD library list rather than an IMS catalog.

When you issue the command, FM/IMS displays the DBD Library List panel.

Syntax

▶ DBDLIST ◀

Availability

- [Template Specification panel on page 412](#).

DELETE primary command (Edit only)

The DELETE primary command deletes the current segment and all of its dependent segments from the database.

Syntax

▶ DELete ◀

After a segment and its children are deleted, the next segment in the hierarchical sequence becomes the current segment.

Availability

- [IMS data panel on page 309](#)
- Not active in ZOOM mode.

DOWN primary command

The DOWN primary command scrolls forward through the segments in the database (in multi-segment display).

The DOWN primary command scrolls forward through the data of the current segment (in single-segment display).

Syntax

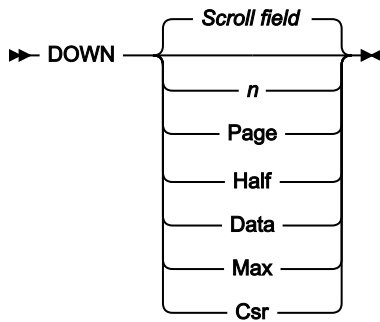

Scroll field

Scrolls down according to the value indicated in the **Scroll field**.

num_lines

Scrolls down the specified number of lines.

Page

Scrolls down one screen page.

Data

Scrolls down one line less than a screen page of data.

Half

Scrolls down half a screen page of data.

Max

Scrolls to the end of the database.

Csr

Scrolls down to the cursor position if the cursor is within the data area of the IMS Data panel, otherwise one screen page.

Availability

- On all panels when the display exceeds one page.

Related tasks and examples

Examples

`DOWN 8`

Scrolls down 8 lines.

`DOWN`

Scrolls down the number of lines indicated by the **Scroll field**.

DOWN M

Scrolls down to the last page of data.

DPRINT primary command

The DPRINT primary command prints the data in the database segments that are available to the browse or edit session. The output for the data print function is determined by the current settings of the print options.

Syntax

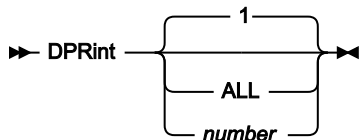

1

Print the segment at the current position.

ALL

Print all segments from the current position in the database to the end of the database.

number

Print the next *number* of segments from the current position in the database.

The format of the printed output is determined by the current display format:

CHAR

Segments are printed in character mode.

HEX

Segments are printed in three lines.

LHEX

The SET DUMP option determines how the data is printed. The value ACROSS produces a system dump format. The value UPDOWN produces a File Manager/IMS HEX format with a character line over two hexadecimal lines.

TABL

FM/IMS prints the segments in columns with field or heading names as column headers and the data formatted according to the field types. The display might be truncated in this format depending on the current print width.

SNGL

The left hand side of the printout contains the field or header names. The right hands side contains the field values formatted according to the field type.

If a view is associated with the database, the segment selection criteria are applied when selecting the segments to be printed.

DPRINT takes no account of whether the current panel is zoomed or not. So if you are displaying a zoomed TABL format, which is the same as a zoomed SNGL format, DPRINT still prints using the TABL format. Nor does DPRINT take into account the current SHOW ([SHOW \(REC\) primary command on page 495](#)) settings, which means that the DPRINT output might include segments not currently displayed on the IMS data panel.

When the format is TABL or SNGL, DPRINT uses view information to format and include or exclude fields.

Availability

- [IMS data panel on page 309](#)

Related tasks and examples

- [Print \(IPR\) on page 579](#)

EDIT primary command

The EDIT primary command edits the template built from the specified copybooks. If changes have been made, a compile and update is performed.

The EDIT primary command is equivalent to using the E prefix command against the first segment on the current display.

Syntax

▶ EDIT ◀

Availability

- [Figure 113: Template Specification panel on page 413](#)

END primary command

The END primary command exits from the current panel and stores any editing changes made to data in memory and any changes made to panel values (such as the names of data sets or selected options) in your ISPF profile. Where exiting the current panel completes the editing of a data set, the END command also saves the changes to file. For example, using the END command in the IMS data panel saves any changes to file; using END on a “nested? template editing panel, such as the Field Attributes panel, stores changes in memory (these changes are not written to file until you end the entire template editing session).

The END command is synonymous with the EXIT command.

Syntax

▶ END ◀
 ▶ EXIT ◀

Availability

Available on all panels.

Related tasks and examples

- [Navigating in FM/IMS on page 31](#)

FE (Find Error) primary command

The FE (Find Error) primary command finds the next occurrence of a “*field in error*” in the data being edited or browsed.

Syntax

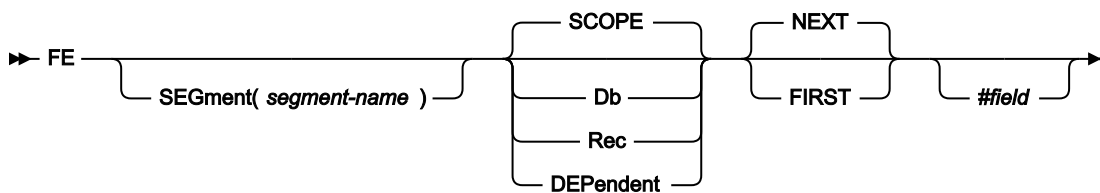

segment-name

The name of the segment type to which the search is limited. If the SEGMENT operand is not specified, then all segment types are searched.

SCOPE

Search range is the current scope.

DB

Search the entire database.

REC

Search is restricted to the current database record.

DEPENDENT

Search is restricted to the dependents of the current segment.

NEXT

The search starts at the current cursor location and proceeds forward to find the next occurrence of a not allowed value.

FIRST

The search starts at the top of the sliding window and proceeds forward to the first occurrence of a not allowed value.

#field

A field reference, specifying the field to be included in the search. For example: #3.

FE finds field values that do not conform to the appropriate COBOL or PL/I PICTURE clause. For numeric fields, any value that does not conform to the field's data type is not allowed.

FE finds not allowed values in currently formatted segments or shadow segments, regardless of the current format.

Availability

- FE is only active when you are using a view.

FIELD primary command

The FIELD primary command displays information regarding each field defined in the DBD for the specified segment.

Syntax

▶ FIELD — *segment-name* ▶
 FLD

Availability

- On all panels when the display exceeds one page.
- On the Segment Information panel, place the cursor on the first character of the segment name and press Enter.

FIND primary command

The FIND primary command finds and displays the next, first, or previous occurrence of a character string (or field value) in the data being edited or browsed.

When an occurrence of the string is found, FM/IMS places the cursor at the beginning of the string. If necessary, it scrolls the data to bring the string into view. All occurrences of the string on the displayed page are highlighted.

For date and time fields that are displayed using the output format defined in the view, FM/IMS searches the displayed values for the string specified with the FIND command.

When you are using a view, the setting of the SHOW SUP command affects the segments that are searched. With SHOW SUP OFF, only those segments matching the current segment type and layout are searched. With SHOW SUP ON, the search is not limited to segments of the current segment type and layout.

To repeat a FIND with the same parameters, press the RFIND function key (F5), or enter the RFIND primary command.

If you enter `FIND *`, then the FIND is repeated with the same string argument, but with all other parameters set to their default value. You can supply particular parameter values if you wish, for example `FIND * PREFIX`.

The FX command displays the Extended Command Entry panel in which you can enter long arguments that may not fit on the Command line.

Syntax

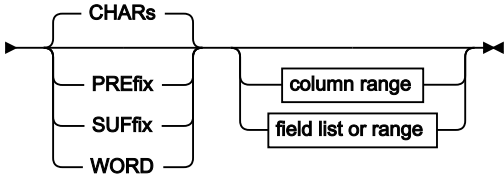
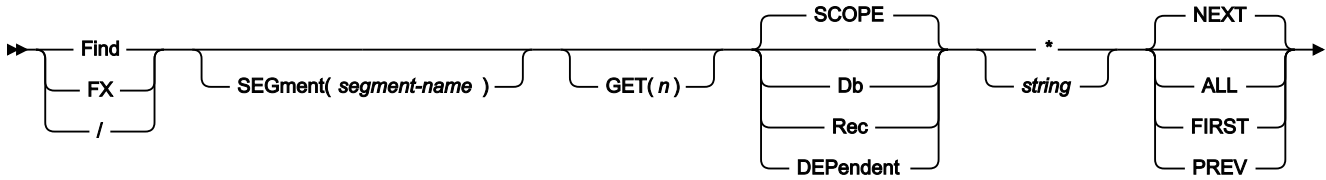

column range (CHAR, HEX, and LHEX formats only)

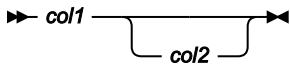

field list or range (SNGL or TABL display format)

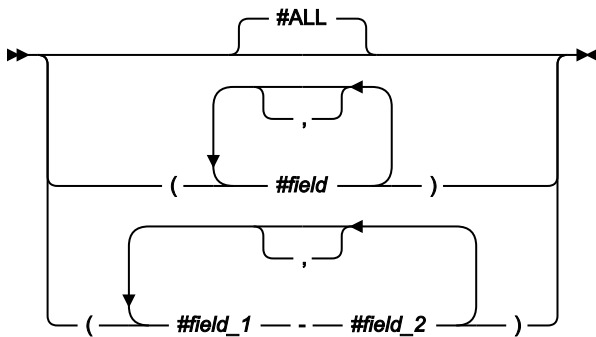

You can specify the parameters in any order.

segment-name

When the SEGMENT parameter is specified, the search is restricted to occurrences of the segment type, *segment-name*. The parameter is only permitted when SHOW SUP is on, or when you are not using a view.

GET(n)

Limits the number of segments searched to *n*.

SCOPE

Search range is the current scope.

DB

Search the entire database.

REC

Search is restricted to the current database record.

DEPENDENT

Search is restricted to the dependents of the current segment. The parameter is only permitted when SHOW SUP is on, or when you are not using a view.

*** (asterisk)**

Uses the search string specified on the previous FIND command as the search string.

string

The string being searched for. The string can be:

- No more than 50 characters long, unless Find extended is used, in which case the limit is 100.
- An empty string (not specified). The search string specified on the previous FIND or CHANGE command is used as the search string.



Note: A FIND ALL with no search string specified performs a RESET FIND, turning off any highlighting from previous FIND or CHANGE commands.

- A character string not starting or ending with a single quotation mark and not containing any embedded blanks or commas. The case of the string is ignored. Uppercase and lowercase representations of the same character match. For example `Mixed` matches `MIXED`.
- A character string enclosed in single quotation marks. The string can contain blanks and commas. The case of the string is ignored.
- C followed by a character string enclosed in quotation marks (C'Frog'), or a character string enclosed in quotation marks followed by c ('Frog'C). The string can contain blanks and commas. The string must match exactly (including case).
- P preceded or followed by a picture string enclosed in single or double quotation marks to describe a type of string to be found rather than the exact characters. It can contain blanks, alphabetic and numeric characters which represent themselves, or any of the special characters listed here, each of which represents a class of characters:

=

Any character.

@

Alphabetic characters.

#

Numeric characters.

\$

Special characters.

& notsym;

Non-blank characters.

- . Invalid characters.
- Non-numeric characters.
- < Lowercase alphabets.
- > Uppercase alphabets.

Examples of picture strings used with the FIND command:

`find p'.' 73 80`

Find invalid characters in columns 73 to 80.

`find p'###'`

Find 3-digit number (for example, 101 but not 99).

`find '@1'p 1`

Find label a1,b1,c1, (and so on) in column 1.

`find p'<'`

Find lowercase alphabetic character.

`find p'~' 72`

Find non-blank character in column 72.

When this notation is used, numeric, bit and unicode fields (for SNGL and TABL display formats) are excluded from the search process.

- X followed by a hexadecimal string enclosed in single quotation marks (`x'c1c2'`).
- A numeric value (SNGL or TABL display format only). The algebraic value of *string* must match the algebraic value of the numeric field. The lengths (number of digits) of *string* and of the numeric field are not significant. Similarly, the data type of the numeric field is not significant. For example, a string of 123 matches a packed-decimal field containing 00123 or a floating-point field containing 1.230E+02. An unsigned value in *string* is considered to be positive.

NEXT

The FIND command searches for the next occurrence of the string, *string*, in the search range, starting at the cursor location (if the cursor is within the data portion of the display), or at the top of the displayed page (if the cursor is outside the data portion of the display).

If *string* is not found by the end of the search range, or if the cursor location is after the last segment in the search range, FM/IMS displays a message indicating that the end of the search range has been reached and

redispays the page that was displayed prior to the search. To resume the search from the top of the search range, use the RFIND (F5) primary command.

FIRST

The FIND command searches for the first occurrence of the string, *string*, in the search range, starting at the beginning of the first segment in the search range.

If *string* is not found in the search range, FM/IMS displays a message indicating that the string was not found and redispays the page that was displayed prior to the search.

ALL

The FIND command searches for all occurrences of the string, *string*, in the search range, starting at the beginning of the first segment in the search range and continuing to the end of the search range.

If *string* is found one or more times, FM/IMS places the cursor at the beginning of the first occurrence and displays a message indicating how many times the string was found.

If *string* is not found in the search range, FM/IMS displays a message indicating that the string was not found and redispays the page that was displayed prior to the search.

PREV

The FIND command searches for the previous occurrence of the string, *string*, starting at the cursor location (if the cursor is within the data portion of the display), or at the end of the segment preceding the first segment being displayed (if the cursor is outside the data portion of the display).

If the top of the search range is in the sliding window, the FIND command searches to the top of the search range. If the top of the search range is not in the sliding window, the FIND command only searches to the top of the window.



Note: When you reach the top of the search range or the top of the window, the RFIND (F5) command does not resume searching from the bottom of the search range.

CHARS

Matches the search string anywhere in the data.

PREFIX

Matches the search string wherever it appears as a prefix in the data. To be a prefix, the matched text must be preceded by a non-alphanumeric character or be the start of a line or field, and must be followed by an alphanumeric character.

SUFFIX

Matches the search string wherever it appears as a suffix in the data. To be a suffix, the matched text must be preceded by an alphanumeric character, and must be followed by a non-alphanumeric character or be the end of a line or field.

WORD

Matches the search string wherever it appears as a word in the data. To be a word, the matched text must be preceded by a non-alphanumeric character or be the start of a line or field, and must be followed by a non-alphanumeric character or be the end of a line or field.

col1

The starting position of the search. If *col1* is specified without *col2*, *string* must start in *col1* to be found. If both *col1* and *col2* are specified, *string* must be completely contained with the designated columns.



Note:

1. You can only specify column ranges when data is in CHAR, HEX, or LHEX formats. You cannot specify column ranges when data is formatted using TABL or SNGL format.
2. When column ranges are specified and the data is displayed in SNGL or TABL formats, the search is performed in the order that the data occurs, which may not be the order that fields are displayed in. Numeric field values are not considered in this type of search.

When column ranges are specified, then a string comparison is performed, even for numeric fields.

col2

Indicates the ending position of the search.



Note: If *col2* is larger than the segment size, the segment size is used.

#ALL

Each field is searched according to its template attributes.

#field

The field reference number for a field in the layout. This applies to TABL and SNGL format.

To specify more than one field reference, they must be either enclosed in parentheses (optionally separated by commas), or separated by commas but without any intervening spaces. For example, (#17 #22), (#17, #22), and #17,#22 are valid field reference specifications.

For alphanumeric fields, the string is found if it is completely contained within one of the designated fields. For example: **FIND ALL xxx #5,#6** finds all segments of the currently formatted type containing "xxx" within either of the fields with field references #5 and #6.

For numeric fields, the string is found if the value of either of the numeric fields is equal to the value specified by the string.

For example, **FIND ALL 123 #8,#9** finds all segments of the currently formatted (numeric or character) type:

- Containing the value 123 in either of the numeric fields with field references #8 and #9
- Containing the string 123 in either of the character fields with field references #8 and #9

#field_1

The first field reference of a range of fields. It cannot be subscripted. If the #field_1 field reference value is less than the lowest displayed field reference value, the lowest displayed field reference value is used.

#field_2

The last field reference of a range of fields. It cannot be subscripted. If the #field_2 field reference value is greater than the highest displayed field reference value, the highest displayed field reference value is used.

The #field_1 and #field_2 field reference values must be separated by a hyphen (-). Spaces are permitted between the hyphen and the field reference values.

If #field_1 is a higher value than #field_2, the search process reverses the operands.

Figure 124. Extended Command Entry pop-up panel for the FIND command showing contiguous nature of entry lines

```

Process  Options  Utilities  Help
-----
FM/IMS          Edit : IMS Database DJ1E
Autosave OFF SHOW SUP ON Scope ALL Col 1 Format CHAR DATE
Extended Command Entry
Complete typing the FIND command and press Enter.
0  FIND      ==> 'THE EXTENDED FIND CAN BE USED TO SEARCH FOR STRIN
0  ==> GS UP TO 100 CHAR LONG' PREV_____
0  ==> _____
0  ==> _____
0  ==> _____
0  ==> _____
0  F1=Help   F2=Split  F3=Exit   F9=Swap   F12=Cancel
0  9/2020
0  --- 2 LINKSUB O'CONNOR
0  --- 2 LINKSUB SAMSON
0  --- 2 LINKSUB SOUTH FREMANTLE
0  --- 2 LINKSUB WHITE GUM VALLEY
0  --- 1 SHIRE KALGOORLIE W60500012.`.....o.
0  --- 2 SHIRENP .....b...
0  --- 2 LINKSUB HANNANS
0  --- 2 LINKSUB KALGOORLIE
0  --- 1 SHIRE MOUNT MAGNET 070400399.....
0  --- 2 SHIRENP .....
0  --- 2 LINKSUB MOUNT MAGNET
0  --- 2 LINKSUB MOUNT MAGNET SHIRE
Command ==> fx
F1=Help F2=Format F3=Exit F4=CRetrie F5=RFind F6=RChange Scroll CSR
F7=Up F8=Down F9=Swap F10=Left F11=Right F12=Cancel

```

If the MAXGN option has been set to a nonzero value at your installation, FM/IMS counts the number of segments read during the search and displays the Search Interrupt window when the count equals the value specified for MAXGN. The Search Interrupt window gives you the option of continuing or discontinuing the search. If you elect to continue the search and the search is not over when a further MAXGN segments have been read, the Search Interrupt window is redisplayed and you have the option once again of continuing or discontinuing the search.

There are two variants of the Search Interrupt window. [Figure 125: Search Interrupt panel - search string not found on page 462](#) shows the window that is displayed when no instances of the search argument have been found. You have three options:

- To continue the search.
- To discontinue the search and display data from the position prior to the search.
- To discontinue the search and display data from the current search position.

Figure 125. Search Interrupt panel - search string not found

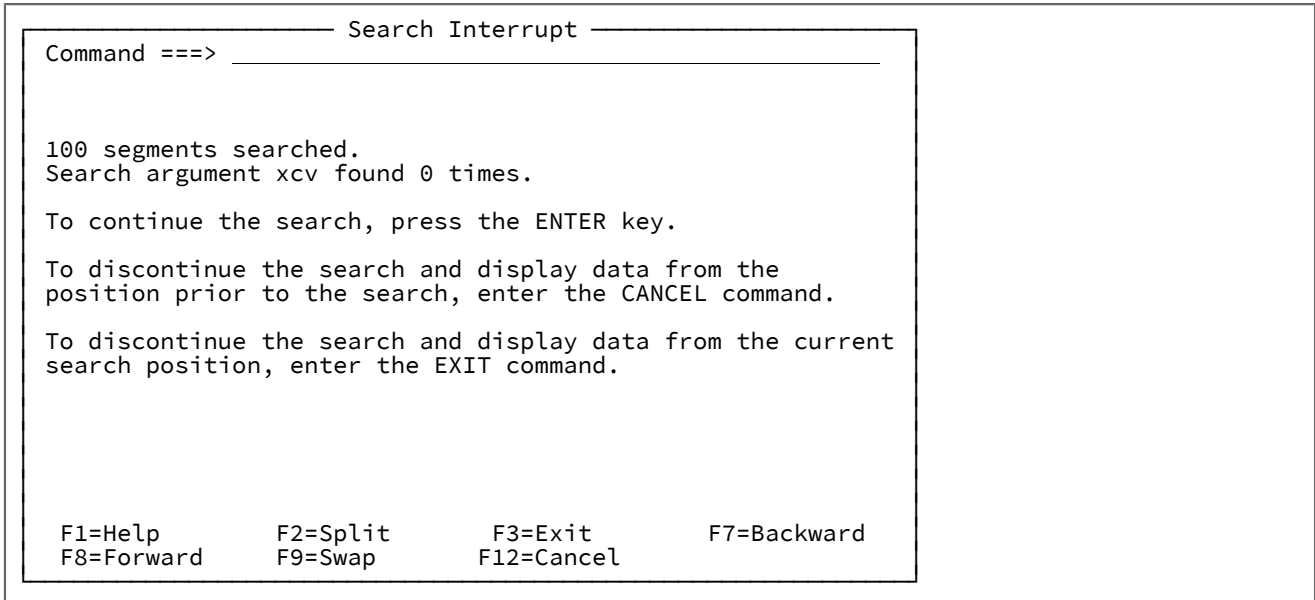

For FIND...ALL requests, the search is not over when one instance of the search argument is found.

[Figure 126: Search Interrupt panel - search string found on page 463](#) shows the window that is displayed when instances of the search argument have already been found. If you elect to discontinue the search when instances of the search argument have already been found, FM/IMS will display data from the position of the first instance of the search argument, as it would if the search had run to its completion.

Figure 126. Search Interrupt panel - search string found

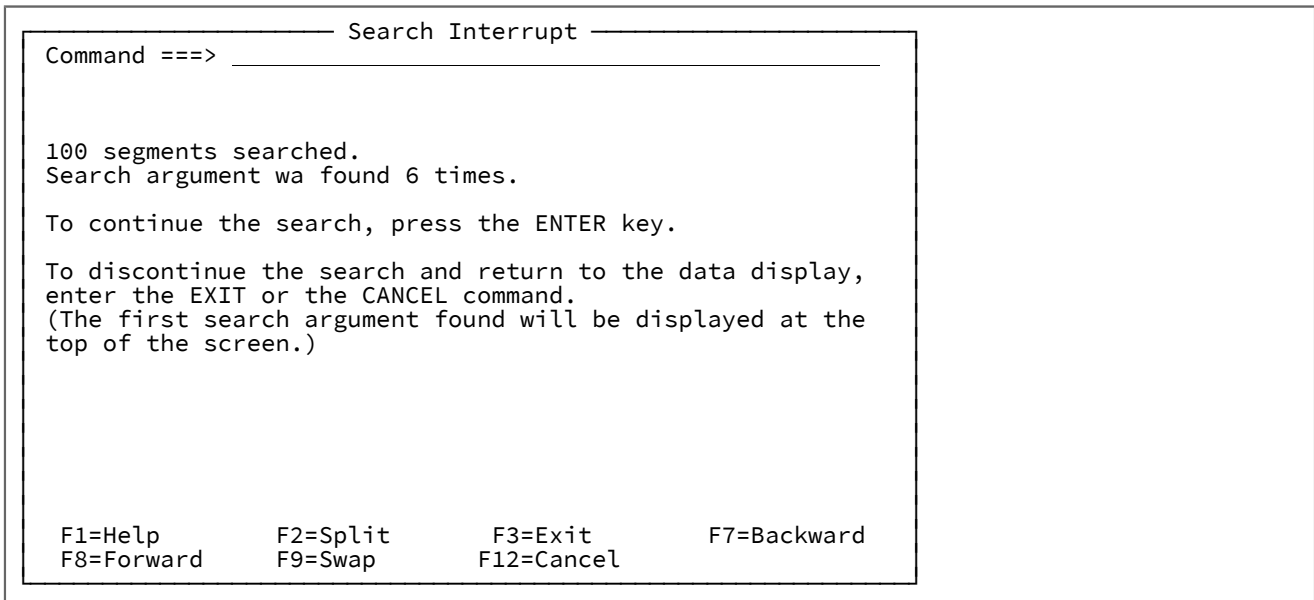

Availability

- [IMS data panel on page 309](#)

Related tasks and examples

The FIND command can be entered using any abbreviation of the command (for example, F or FI), or by entering the forward slash ("/") character.

[Figure 124: Extended Command Entry pop-up panel for the FIND command showing contiguous nature of entry lines on page 461](#) shows the Extended Command Entry pop-up panel for the FIND command. In this example, FM/IMS finds any previous occurrences of a long string.

FMAP primary command

The FMAP command can be used to edit or view a field in a record using another template. If the field being mapped is shorter than the template mapping a warning message is issued when data is changed and any data which is beyond the end of the mapped field is ignored. The data type of the field being mapped is ignored.

The record containing the field to be mapped must be at the top of the screen or the cursor may be positioned on the record when the FMAP command is issued. The record must be a selected record.

If the field identification parameter is not specified and the cursor is positioned on a field that field is used. Otherwise a Field List Selection panel is displayed.

If the template name is no specified a panel is displayed where this information can be supplied.

Syntax

Figure 127. Syntax

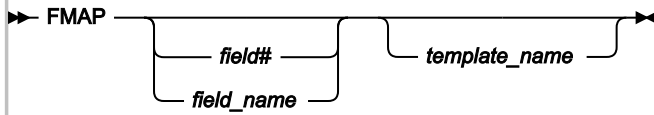

field#

The reference number of the field to be mapped.

field_name

The name of the field to be mapped. The name may be qualified.

template_name

The name of the template to be used to map the field. A partially or fully qualified data set name together with the member name can be specified.

Availability

- [IMS data panel on page 309](#)

Related tasks and examples

- [Selecting a display format on page 61](#)
- [Editor Options panel on page 272](#)

FORMAT primary command

The FORMAT primary command is used to change the current display format without having to overtype the **FORMAT** field.

Syntax

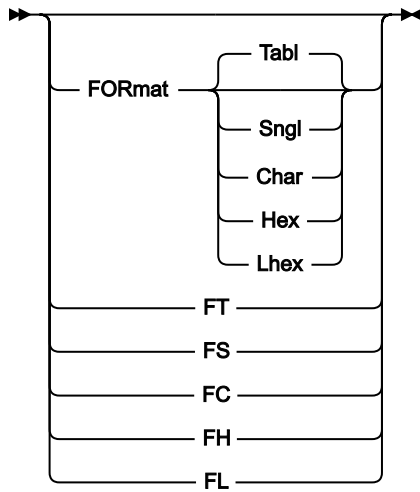

TABL, FT

Change format to TABL mode. Only available if a view has been used.

SNGL, FS

Change format to SNGL mode. Only available if a view has been used.

CHAR, FC

Change format to CHAR mode.

HEX, FH

Change format to HEX mode.

LHEX, FL

Change format to LHEX mode.

Availability

The abbreviated forms of the FORMAT primary command are also available as line commands. The default value for the target format depends on the current display mode. If you are in SNGL format, the default is TABL mode. If you are in TABL format, the default is SNGL mode.

Using one of the above as a line command against a displayed segment occurrence is effectively the same as scrolling that segment to the top of the display, issuing a view for that line (if it is other than the current layout) and changing format.

FREE primary command

The FREE command removes any scrolling lock on one or more fields of a segment layout. You can issue the command on the IMS data panel when the display format is SNGL or TABL.

You can set scrolling locks with the HOLD editor primary command or by using the H prefix command in the template editor.

Syntax

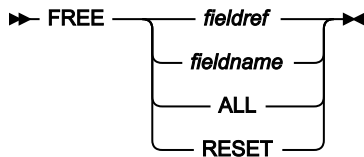

fieldref

A single field reference (for example, #1), a range (for example, #2-#5), or a list of single field references and ranges separated by spaces (for example, #1 #4 #6-#7). A single field specification is #*n*; *n* is a positive integer and cannot exceed the number of fields in the template that is being processed.

fieldname

The name of a field in the template, which is optionally preceded by the pound symbol (#). Use #ALL and #RESET to avoid any syntactical ambiguity with command keywords.

ALL

Removes all scrolling locks.

RESET

Removes all scrolling locks.

Availability

IMS data panel on page 309 when the display format is SNGL or TABL.

Related tasks and examples

- [HOLD primary command on page 469](#)
- [ORDER primary command on page 481](#)

GE primary command

The GE primary command has been added to the Database Positioning panel to specify that the positioning logic is to use a Greater than or Equal to search for the specified key values.

Syntax

▶ GE ◀

The GE command allows the user to specify that the positioning logic is to use a Greater than or Equal to search the specified key values. If you press Enter from the database positioning panel it attempts an equal key search.



Note: The keylist for the positioning panel has been modified to associate function key 5 with the GE command.



For HDAM databases, the root key value is always searched for in equals mode.

Availability

- [Database Positioning panel on page 239](#)

HEX primary command

The HEX primary command sets or resets the hexadecimal display format.

Syntax

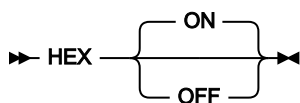

(no parameter)

Toggles the correct hexadecimal-display status. That is, it turns hexadecimal display ON if currently OFF, and turns hexadecimal display OFF if currently ON.

ON

Display the hexadecimal representation of the data vertically (three lines per byte).

OFF

Display the data in character format.

Availability

- [IMS data panel on page 309](#)
- [Database Positioning panel on page 239](#)

Related tasks and examples

The effect of issuing the HEX command depends upon the current display format when you issue the command, as follows:

- When the current display format is CHAR, HEX or LHEX:

HEX ON

Changes the display format to HEX. This is equivalent to entering HEX in the **Format** field.

HEX OFF

Changes the display format to CHAR. This is equivalent to entering CHAR in the **Format** field.

- When the current display format is SNGL or TABL:

HEX ON

Changes the display of each field to show the vertical hexadecimal representation of each field in the two lines immediately below the formatted field.

HEX OFF

Changes the display back to standard SNGL or TABL format, without hexadecimal representations.

For example, if you are browsing data in TABL display format and your display looks something like this:

Shire Name	Type	Code1	Code2	SHIRE-ROAD
#3	#4	#5	#6	#7
AN 1:20	AN 21: ZD 22: ZD 25:			PD 30:8
<---+---1--->	-	<-->	<---+>	<---+---1---+>
SHARK BAY	0	804	139	2322240304
WYALKATCHEM	0	431	124	100110022

then issuing the command HEX ON causes the hexadecimal representation to be displayed:

Shire Name	Type	Code1	Code2	SHIRE-ROAD
#3	#4	#5	#6	#7
AN 1:20	AN 21: ZD 22: ZD 25:			PD 30:8
<---+---1--->	-	<-->	<---+>	<---+---1---+>
SHARK BAY	0	804	139	2322240304
ECCDD4CCE444444	F	FFF	FFFF	00032434
281920218000000	0	804	00139	0022200C
WYALKATCHEM	0	431	124	100110022
EECDCECCD4444	F	FFF	FFFF	00010102
681321338540000	0	431	00124	0000102C

HIDE primary command

The HIDE command removes one or more fields from the data display. You can issue the command on the IMS data panel when the display format is SNGL or TABL.

You can display a hidden field by using the SHOW (FLD) editor primary command or by using the S prefix command in the template editor.

Syntax

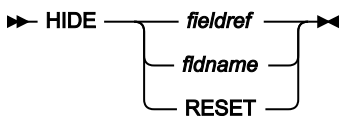

fieldref

A single field reference (for example, #1), a range (for example, #2-#5), or a list of single field references and ranges separated by spaces (for example, #1 #4 #6-#7). A single field specification is #n; n is a positive integer and cannot exceed the number of fields in the template that is being processed.

fldname

The name of a field in the template, which is optionally preceded by the pound symbol (#). Use #RESET to avoid any syntactical ambiguity with command keywords.

RESET

Shows all fields.

Availability

[IMS data panel on page 309](#) when the display format is SNGL or TABL.

Related tasks and examples

[SHOW \(FLD\) primary command on page 494](#)

HIERARCH primary command

The HIERARCH primary command displays a graphical representation of the structure of the database being edited or browsed.

Syntax

► Hlerarch ◄

Availability

- All panels within the Browse, Edit, Utilities (except Audit trail) and Template/View/Criteria Set dialogs, except the initial Entry panel for each function.

Related tasks and examples

On the Database Hierarchy panel, you can tab to one of the segments and press Enter to display the Segment Information panel.

HOLD primary command

The HOLD command sets a scrolling lock on one or more fields of a segment layout. In TABL display format, when scrolling left or right, held fields are fixed on the left in the order specified in the template. In non-structured SNGL display format, when scrolling up or down, held fields are fixed at the top in the order specified in the template.

You can issue the command on the IMS data panel when the display format is SNGL or TABL.

You can remove scrolling locks with the FREE editor primary command or by using the H prefix command in the template editor.

Syntax

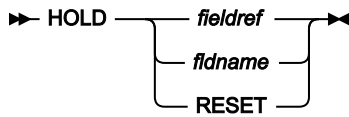

fieldref

A single field reference (for example, #1), a range (for example, #2-#5), or a list of single field references and ranges separated by spaces (for example, #1 #4 #6-#7). A single field specification is #*n*; *n* is a positive integer and cannot exceed the number of fields in the template that is being processed.

fldname

The name of a field in the template, which is optionally preceded by the pound symbol (#). Use #RESET to avoid any syntactical ambiguity with command keywords.

RESET

Removes all scrolling locks.

Availability

[IMS data panel on page 309](#) when the display format is SNGL or TABL.

Related tasks and examples

- [FREE primary command on page 465](#)
- [ORDER primary command on page 481](#)

INSERT primary command (Edit only)

The INSERT primary command inserts an occurrence of a segment type into the database.

Syntax

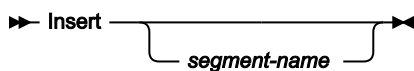

segment-name

The segment type you want to insert. If you do not specify this parameter, FM/IMS displays the Insert : Segment Selection panel. You can select a segment type from the list of segment types displayed on this panel.

When the INSERT primary command is issued and an insert of the specified segment type is permitted, FM/IMS displays either the Insert Root segment panel (if the specified segment is a root segment) or the Insert Segment panel (if the specified segment is not a root segment).

On the Insert Segment panel, the **Key value** fields in the Parent Keys area are displayed with either the key of the parent of the current segment (if the parent is in the path of the current segment) or low values (if the parent is not in the path of the current segment).

On the Insert Segment panel and the Insert Root Segment panel, the fields in the Data area are initialized to spaces when you are not using a view. When you are using a view, FM/IMS uses a segment layout when initializing the fields of the Data area. Numeric fields in the layout are set to zero, and nonnumeric fields are set to spaces.

Update the key and data fields with the values required for the segment you want to insert. FM/IMS:

- Calls IMS to insert the specified segment occurrence
- Returns to the IMS Data panel, redisplaying the page that was previously displayed

To return to the IMS Data panel without inserting a segment occurrence, press the Cancel key (F12).

You cannot insert a segment when:

- The PCB being used to edit the database does not have the necessary processing option to insert the segment
- The PCB being used to edit the database uses a secondary index and the segment is either the target of the secondary index or a parent of the target segment.
- The segment is a concatenated segment that does not have *data* sensitivity for both the logical child and the destination parent.
- The insert may result in a duplicate segment in a unique secondary index and a duplicate segment will cause a U0828 abend.

If any of the above conditions hold true for the current segment type, the INSERT command issues a diagnostic and does not display the Insert Root Segment panel or the Insert Segment panel.

Availability

- Edit only
- [IMS data panel on page 309](#) (except when in ZOOM mode)

JUST primary command

In a Browse or Edit session, this command temporarily sets numeric fields to left justified when in SNGL display mode.

Syntax

► JUST ◄

JUST

Toggle command that sets numeric fields to left or right justified when in SNGL display mode.

Availability

- [IMS data panel on page 309](#)

Related tasks and examples

- [Selecting a display format on page 61](#)
- [Editor Options panel on page 272](#)

KEY primary command

The KEY primary command displays the Key Specification panel where you enter key values for segments and thus change the current position in the database.

The Key Specification panel displays key values based on the current hierarchical path and segment position. The panel is initialized with the key values for the segments in the current hierarchical path. You can modify the key values for those segments in the hierarchical path.

After processing of the Key Specification panel is completed, FM/IMS redisplay the IMS Data panel where the KEY command was entered. The segment that satisfies the key values entered on the Key Specification panel becomes the current segment.

Syntax

► KEY segment-name ►

Availability

segment-name

The name of the segment type that you want to display in the Key Specifications panel. The segment type must be one of the segment types defined in the DBD to be the hierarchical path (parent or child) of the current segment. Alternatively it may be specified as *, which has the same meaning as not specifying it.

If *segment name* is not specified (or is specified as *), scrolling is restricted to the first hierarchical child segment type under the current segment.



Note:

1. If FM/IMS doesn't find an exact match for *segment-name* within the DBD, it searches the list of segments in the DBD to determine if any of the segment names contain the value entered. The first segment name that contains a match is used with the KEY command. For example:

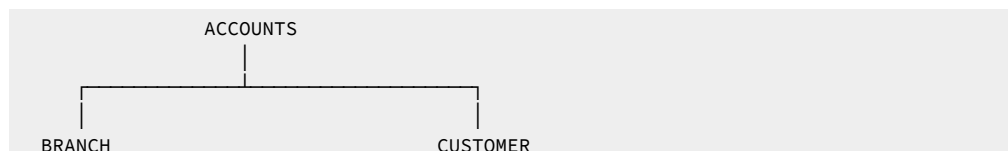



CUSTADDR

Entering 'KEY CUST' would display the CUSTOMER segment in the Key Specifications panel but would not find the CUSTADDR segment. However, you could enter 'KEY ADDR' and this would retrieve the next occurrence of the CUSTADDR segment in the database.

2. If the specified segment occurrence is not found, the current database position is unchanged and the following message is displayed: **Invalid segment name**

- [IMS data panel on page 309](#)
- [Database Positioning panel on page 239](#)
- Not active in ZOOM mode.

LEFT primary command

In multi-segment display, the LEFT primary command scrolls towards the beginning of the data for the displayed segments.

The LEFT primary command is not active in SNGL format.

Syntax

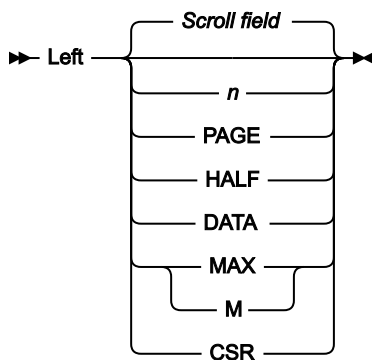

n

Scrolls left *n* columns.

CSR

Scrolls left to the cursor position.

DATA

In TABL display format, acts the same as **PAGE**. In other display formats, scrolls left one column less than a page of data.

HALF

Scrolls left half a page of data.

MAX

In CHAR, HEX or LHEX display format, scrolls to leftmost column. In TABL display format, scrolls to the leftmost field.

PAGE

Scrolls left one page of data.

Scroll field

Scrolls left by the amount indicated in the **Scroll field**. This is the default if no parameter is used. Entering a parameter other than MAX in the scroll field changes the scroll field default. If MAX is entered, the scroll field reverts to the previous setting after the command is issued.

Availability

- On all panels where the display exceeds the width of one page.

Related tasks and examples

[RIGHT primary command on page 490](#)

LHEX primary command

The LHEX command displays the data for one or more fields in long hexadecimal format. In LHEX format, each character is shown as two hexadecimal characters that are displayed from left to right. For example, '1' appears as 'F1' in LHEX format. Only character fields are affected.

You can issue the command on the IMS data panel when the display format is SNGL or TABL.

Syntax

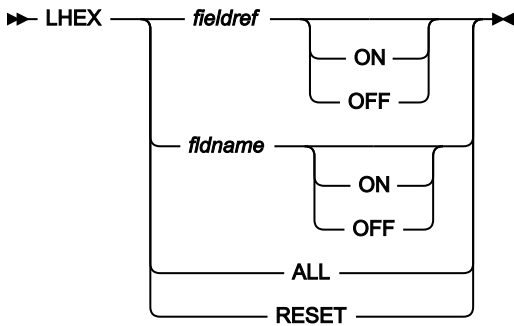

fieldref

A single field reference (for example, #1), a range (for example, #2-#5), or a list of single field references and ranges separated by spaces (for example, #1 #4 #6-#7). A single field specification is #n; n is a positive integer and cannot exceed the number of fields in the template that is being processed.

fldname

The name of a field in the template, which is optionally preceded by the pound symbol (#). Use #ALL and #RESET to avoid any syntactical ambiguity with command keywords.

OFF | ON

Turns the LHEX format on or off. If you omit this parameter, the LHEX command acts as a toggle; the field's current LHEX display status is reversed.

ALL

Displays all fields in long hexadecimal format.

RESET

Displays all fields in the default format.

Availability

[IMS data panel on page 309](#) when the display format is SNGL or TABL.

Related tasks and examples

- [HEX primary command on page 467](#)

LIBLIST primary command

The LIBLIST command allows you to view and modify the copybook library list specified in the template you are editing.

When you issue the command, FM/IMS displays the Copybook Library List panel.

The Template function (option 4.1) searches the specified libraries for the layout members you specify on the Template Specification panel.

The Copybook library list you specify is saved in the template and is used for subsequent updates.

Syntax

►► LIBLIST ◀◀

Availability

- [Template Specification panel on page 412](#)

Related tasks and examples

[Creating a template on page 82](#)

LOCATE primary command

Use the LOCATE primary command to:

- Position a scrollable formatted display at the field that matches the supplied *field-name*. The display is positioned on the field that contains the supplied string.
- Search the current primary sort order column for a matching string, in member selection panels.

LOCATE command with scrollable formatted data

In SNGL format, the display is scrolled down such that the matching field is the first field displayed in the scrollable area.

In TABL format, the display is scrolled right such that the matching is the leftmost field displayed in the scrollable area.

Scrolls to the specified segment or field.

Syntax

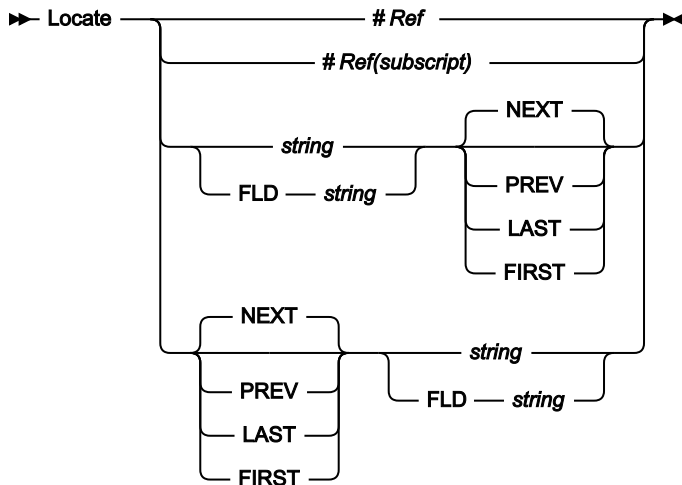

LOCATE command in member selection panels

In member selection panels, the LOCATE command searches the current primary sort order column for a matching string to the string entered with the command. The LOCATE command positions to the top of the display the column value either equal to, or closest value less than or greater than depending on the sort order.

Figure 128. Syntax in Member Selection List



LOCATE command in the Template Specification panel

In the Template Specification panel, the LOCATE command searches the list of the segment names and positions to the first segment name that matches the entered string.

Figure 129. Syntax in the Template Specification panel

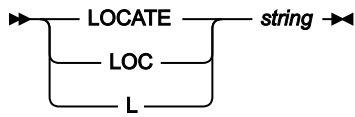
**#Ref**

The field reference number of the field that you want to locate. Applies when the field is not an item in an array.

For example:

```
L #3
```

Available in SNGL or TABL display format only.

#Ref(subscript)

The field reference number and occurrence of the field that you want to locate. Applies when the field is an item in an array. You must specify a subscript in parentheses to identify the occurrence that you want to locate.

If your field is part of a multi-dimensional array, you must specify a subscript for each dimension in the array.

For example:

```
L #7(5)
```

```
L #9(2,3)
```

Available in SNGL or TABL display format only.

string

The name (or part of the name) of the field that you want to locate. This string can occur anywhere in the field name. For example:

```
L SAL
```

or

```
L ARY
```

locates a field named "SALARY".

Available in SNGL or TABL display format only.

FLD string

Indicates to FM/IMS that the string following the FLD keyword is the name or part of the name of the field that you want to locate. This is used to resolve any ambiguity that may exist between field names and other command parameters. For example, if your field name contained the # symbol (for example #Items), the command `L #Items` would result in an error, as FM/IMS is expecting the # symbol to be followed by a numerical field reference number. Using the command `L FLD #Items` resolves this problem.

Available in SNGL or TABL display format only.

NEXT

Finds the next occurrence of the field name, to the right (TABL display) or down (SNGL display) from the cursor location. Must be used in conjunction with *string* or *FLD string*, in any order. For example:

```
L NEXT SAL
```

or

```
L SAL NEXT
```

Available in SNGL or TABL display format only.

PREV

Finds the previous occurrence of the field name, to the left (TABL display) or up (SNGL display) from the cursor location. Must be used in conjunction with *string* or FLD *string*, in any order. For example:

```
L PREV SAL
```

or

```
L SAL PREV
```

Available in SNGL or TABL display format only.

LAST

Finds the last occurrence of the field name, regardless of the cursor location. Must be used in conjunction with *string* or FLD *string*, in any order. For example:

```
L LAST SAL
```

or

```
L SAL LAST
```

Available in SNGL or TABL display format only.

FIRST

Finds the first occurrence of the field name, regardless of the cursor location. Must be used in conjunction with *string* or FLD *string*, in any order. For example:

```
L FIRST SAL
```

or

```
L SAL FIRST
```

Available in SNGL or TABL display format only.

Availability

- [IMS data panel on page 309](#)
- [Database Positioning panel on page 239](#)
- Member selection panels.

LZERO primary command

The LZERO primary command toggles the global leading zero setting for the template.

If global leading zeros is set to `ON`, then the default leading zero setting for applicable numeric fields is `YES`, and a status indicator **LZERO** appears on the current panel.

If global leading zeros is set to `OFF`, then the default leading zero setting for applicable numeric fields is `NO`, and the status indicator is cleared.

Syntax

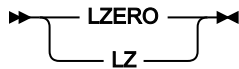

Availability

- [Segment Layout panel on page 370](#) (for a Template or View)

NEXT primary command

The NEXT primary command uses the parameters supplied to scroll the current database position to the next occurrence of a segment type.

Syntax

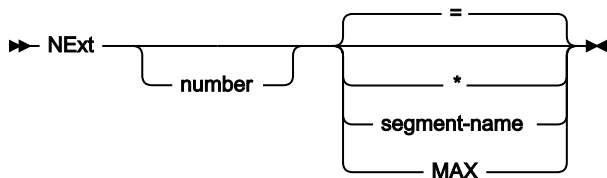

number

The *number* of segment occurrences you move forward.

=

Behavior depends on the current SHOW command settings.

If the current setting is **SHOW SUP OFF**, FM/IMS scrolls forward to the nth occurrence of the same segment and layout type (the currently formatted segment type).

If the current setting is **SHOW SUP ON**, FM/IMS scrolls forward to the nth occurrence of the same segment type as the current segment, regardless of the layout type.



Note: = is the default unless the **Use * (any segment type) as default on NEXT and PREVIOUS commands** field in the Editor Options panel (option 0.5) has been selected.

*

Ignore the current SHOW command settings and move forward the *number* of segment occurrences irrespective of segment type.



Note: This can be made the default behavior by selecting the **Use * (any segment type) as default on NEXT and PREVIOUS commands** field in the Editor Options panel (option 0.5).

segment-name

Move forward to the nth occurrence of specified segment type.



Note:

1. If FM/IMS doesn't find an exact match for *segment-name* within the DBD, it searches the list of segments in the DBD to determine if any of the segment names contain the value entered. The first segment name that contains a match is used with the NEXT command. For example:

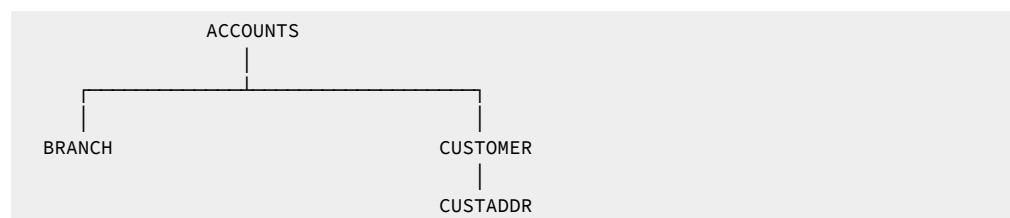

Entering 'NEXT CUST' would position on the next occurrence of the CUSTOMER segment in the database but would not find the CUSTADDR segment. However, you could enter 'NEXT ADDR' and this would retrieve the next occurrence of the CUSTADDR segment in the database.

2. If the specified segment occurrence is not found, the current database position is unchanged and the following message is displayed: **Invalid segment name**

MAX

Scrolls to last segment. You can also enter MAX in the scroll field and then enter the NEXT command.



Note: The scroll field does not change the default to MAX.

Availability

- [IMS data panel on page 309](#)

Related tasks and examples

[PREVIOUS primary command on page 483](#)

OFFSET primary command

If an OFFSET primary command is applied when an offset has already been supplied in the template, the offset value overwrites the offset value provided in the template.

Syntax

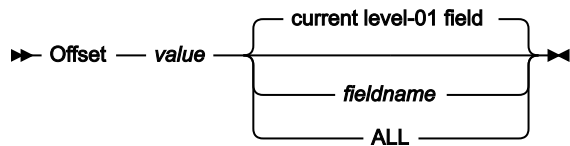

value

The offset value.

fieldname

The level-1 field name to which the offset is applied.

Defaults to the currently displayed level-01 field.

ALL

The offset value applies to all the layouts described in the currently loaded template.

Availability

- The Offset primary command only applies to template editing when you have multiple layouts.

Comments

None.

ORDER primary command

The ORDER command sets the display order for one or more fields in TABL and SNGL display format.

Held fields are ordered in relation to other held fields. Unheld fields are ordered in relation to other unheld fields.

You can also specify a display order by typing a number in the SEQ column using the template editor.

Syntax

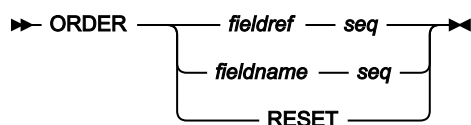

fieldref

A single field reference (for example, #1), a range (for example, #2-#5), or a list of single field references and ranges separated by spaces (for example, #1 #4 #6-#7). A single field specification is #*n*; *n* is a positive integer and cannot exceed the number of fields in the template that is being processed.

fldname

The name of a field in the template, which is optionally preceded by the pound symbol (#). Use #RESET to avoid any syntactical ambiguity with command keywords.

seq

A positive integer that indicates the relative order for the field among other ordered fields.

RESET

Displays all fields in the default order.

Availability

[IMS data panel on page 309](#) when the display format is SNGL or TABL.

Related tasks and examples

- [FREE primary command on page 465](#)
- [HOLD primary command on page 469](#)

PARENT primary command

The PARENT primary command changes your position in the database from the current segment to any other segment occurrence in the hierarchical path to the current segment.

Syntax

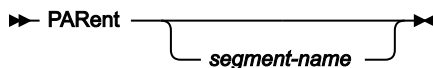

segment-name

The name of the segment type you want to position on. The segment type must be a parent of the current segment type but it does not have to be an immediate parent.

When *segment-name* is not specified, the PARENT command positions on the immediate parent of the current segment.

When the PARENT command is issued and the current segment is a root segment, FM/IMS displays a message and does not change the current segment position.

Availability

- [IMS data panel on page 309](#)
- Not active in ZOOM mode.

Related tasks and examples

[ROOT primary command on page 491](#)

PIC primary command

In a Browse or Edit session, this command temporarily turns on or off the Picture clause when in SNGL display mode. Also shows the length and scale (if non zero) for binary and packed fields and the bit length for bit fields.

Syntax

►► PIC ◄◄

PIC

Toggle command that shows or hides the Picture clause information when in SNGL display mode.

Availability

- [IMS data panel on page 309](#)

Related tasks and examples

- [Selecting a display format on page 61](#)
- [Editor Options panel on page 272](#)

PREVIOUS primary command

The PREVIOUS primary command uses the parameters supplied to scroll the current database position to the previous occurrence of a segment type.

Syntax

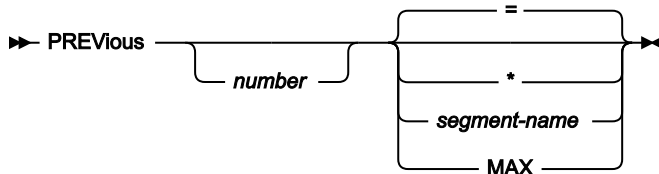

number

The *number* of segment occurrences you move back.

=

Behavior depends on the current SHOW command settings.

If the current setting is **SHOW SUP OFF**, FM/IMS scrolls back to the *nnnth* occurrence of the same segment type from the current database position (that is, the currently formatted segment type).

If the current setting is **SHOW SUP ON**, FM/IMS scrolls back the *number* of segment occurrences regardless of the segment type.

*

An * ignores the current SHOW command settings and move back the *number* of segment occurrences irrespective of segment type.



Note: An = is the default unless the option Use * (any segment type) as default on NEXT and PREVIOUS commands, set in option 0.5 (Editor Options).

segment-name

Move back to the nth occurrence of specified segment type.



Note:

1. If FM/IMS doesn't find an exact match for *segment-name* within the DBD, it searches the list of segments in the DBD to determine if any of the segment names contain the value entered. The first segment name that contains a match is used with the PREV command. For example:

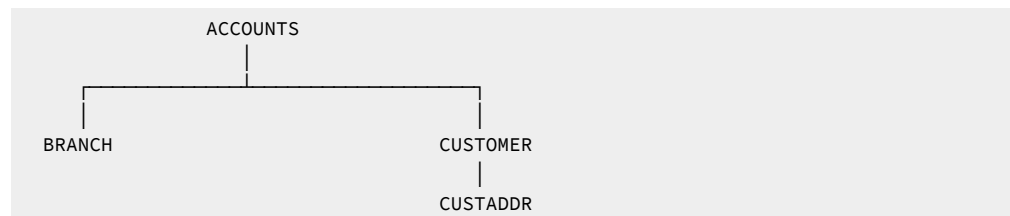

Entering 'PREV CUST' would position on the previous occurrence of the CUSTOMER segment in the database but would not find the CUSTADDR segment. However, you could enter 'PREV ADDR' and this would retrieve the previous occurrence of the CUSTADDR segment in the database.

2. If the specified segment occurrence is not found, the current database position is unchanged and the following message is displayed: **Invalid segment name**
3. If a sliding window is used the following message is displayed: **Segment not in window**
4. If a sliding window has been used for the edit/browse display, the current top of the window is the limit to which the PREVIOUS command can move the database position.

MAX

Scrolls to first segment. You can also enter MAX in the scroll field and then enter the NEXT command.



Note: The scroll field does not change the default to MAX.

Availability

- [IMS data panel on page 309](#)

Related tasks and examples

[NEXT primary command on page 479](#)

QUIT primary command

The QUIT command is synonymous with the CANCEL command.

RCHANGE primary command

The RCHANGE primary command repeats the change performed by the previous CHANGE primary command.

All options specified on the original CHANGE command (such as CHILD, SEGMENT, and GET(n)) still apply to RCHANGE. With GET(n), a new record range is started with an RCHANGE command.

Syntax

► RCHANGE ◄

Availability

RCHANGE is not applicable if CHANGE was entered with the ALL parameter.

Related tasks and examples

- [CHANGE primary command \(Edit only\) on page 440](#)

RDF primary command

In a Browse or Edit session, this command shows or hides the Redefines information.

Syntax

► RDF ◄

RDF

Toggle command that shows or hides the Redefines information and redefines fields when in SNGL display mode and shows or hides the redefines fields when in TABL display mode.

Availability

- [IMS data panel on page 309](#)

Related tasks and examples

- [Selecting a display format on page 61](#)
- [Editor Options panel on page 272](#)

REFRESH primary command

In member selection panels, the REFRESH primary command re-reads the directory and displays the current member list.

Syntax

▶ REFRESH ◀

Availability

- [Specifying a Library data set on page 32](#)

REFS primary command

The REFS primary command turns on or off the display of the Field Reference column, when in SNGL display mode.

Syntax

▶ REFS ◀

REFS

Toggle command that shows or hides the Field Reference column when in SNGL display mode.

Availability

- [IMS data panel on page 309](#)

Related tasks and examples

- [Selecting a display format on page 61](#)
- [Editor Options panel on page 272](#)

RELATED primary command

The RELATED primary command displays information regarding logical relationships defined for the current database.

Syntax

▶ RELated ◀

Availability

- All panels within the Browse, Edit, Utilities (except Audit trail) and Template/View/Criteria Set dialogs, except the initial Entry panel for each function.

Related tasks and examples

- [Logical Relationship Information panel on page 342](#)

REPEAT primary command (Edit only)

The REPEAT primary command inserts a single segment occurrence or an entire substructure into the database.

Syntax

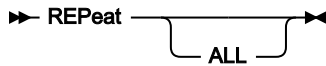

Use the REPEAT command with no parameter to insert a single occurrence of the current segment type into the database.

Use the REPEAT ALL command to insert an occurrence of the current segment type into the database and to duplicate all of the dependent segments of the current segment under this new occurrence.

When the REPEAT or REPEAT ALL command is issued, and an insert of the current segment type is permitted, FM/IMS displays either the Insert Root Segment panel (if the current segment is a root segment) or the Insert Segment panel (if the current segment is not a root segment).

On the Insert Segment panel, the **Key value** fields in the Parent Keys area are displayed with the keys of the parents of the current segment.

On the Insert Segment panel and the Insert Root Segment panel, the key and data of the current segment are displayed in the Data area.

Update the key and data fields with the values required for the segment you want to insert, then press the Exit function key (F3). FM/IMS:

- Calls IMS to insert the specified segment occurrence
- If it is a REPEAT ALL, duplicates all of the dependents of the current segment under the new occurrence
- Returns to the IMS Data panel, redisplaying the page that was previously displayed

To return to the IMS Data panel without inserting any segment occurrences, press the Cancel key (F12).

You cannot insert a segment when:

- The PCB being used to edit the database does not have the necessary processing option to insert the segment, or
- The PCB being used to edit the database uses a secondary index and the segment is either the target of the secondary index or a parent of the target segment, or
- The segment is a concatenated segment that does not have *data* sensitivity for both the logical child and the destination parent, or
- The insert may result in a duplicate segment in a unique secondary index and a duplicate segment would cause a U0828 abend.

If any of the above conditions hold true for the current segment type, the REPEAT command issues a diagnostic and does not display the Insert Root Segment panel or the Insert Segment panel.

Availability

- Edit only
- [IMS data panel on page 309](#) (except when in ZOOM mode)

Related tasks and examples

- [INSERT primary command \(Edit only\) on page 470](#)
- [Insert Root Segment panel on page 321](#)
- [Insert Segment panel on page 323](#)

RESET primary command

The RESET command “cleans up” the displayed data.

Syntax

Figure 130. Syntax (for Browse)

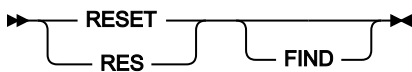

Figure 131. Syntax (for Edit)

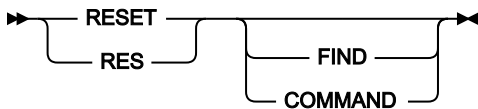

Figure 132. Syntax (for member selection panels)

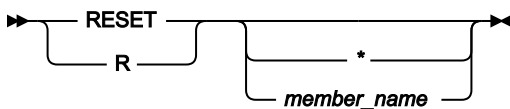

Figure 133. Syntax (for options panels)

➤ RESET ➤

COMMAND

Resets all pending line commands.

FIND

Removes highlighting from strings or numeric values found by the FIND command.

*

Specifies that all members in the list are to be deselected.

member_name

Specifies that the named member is to be deselected. Can be a member name pattern, so that all members with a matching name are deselected.

Entering a RESET command without any parameters resets everything.

RESET in member selection panels

In member selection panels the RESET command resets values entered in the prefix area that have not yet been processed and also in the **Prompt** field. You can specify a member name or a member pattern to limit the scope of the command to matching member names. If you do not specify any member name or pattern, all prefix commands are removed.

In the options panels, the RESET command resets the options displayed on the panel to the default options defined in the File Manager options module.

Availability

- [BMP Mode Options panel on page 209](#)
- [BMP Mode Parameters panel on page 212](#)
- [DLI Mode Data Sets 1 panel on page 254](#)
- [DLI Mode Data Sets 2 panel on page 256](#)
- [DLI Mode Options panel on page 259](#)
- [DLI Mode Parameters panel on page 262](#)
- [Set Print Processing Options panel on page 390](#)
- [Set Temporary Data Set Allocation Options panel on page 394](#)
- [System Settings panel on page 406](#)

RFIND primary command

The RFIND primary command repeats the search performed by the previous FIND primary command.

All options specified on the original FIND command (such as CHILD, SEGMENT, and GET(n)) still apply to RFIND. With GET(n), a new record range is started with an RFIND command.

Syntax

➤ RFIND ➤

Availability

RFIND works from the cursor position. When you use the RFIND function key (F5), your cursor remains in the body of the data and you can easily move to the next incidence of *string* by pressing the key. However, if you type the RFIND command on the Command line, you need to reposition your cursor on the last incidence of *string* and then press Enter, in order to find the next incidence.

Related tasks and examples

- [FIND primary command on page 455](#)

RIGHT primary command

The RIGHT primary command (in multi-segment display), scrolls toward the end of the data for the displayed segments.

The RIGHT primary command (in SNGL format) is not active.

Syntax

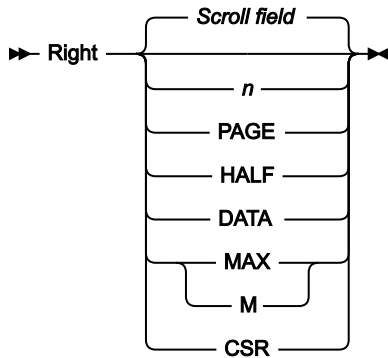

Scroll field

Scrolls right by the amount indicated in the **Scroll field**. This is the default if no parameter is used. Entering a parameter other than MAX in the scroll field changes the scroll field default. If MAX is entered, the scroll field reverts to the previous setting after the command is issued.

number

Scrolls right *number* of columns.

PAGE

Scrolls right one screen page.

DATA

Scrolls right one column less than a screen page of data. For TABL mode this is the same as PAGE.

HALF

Scrolls right half a screen page of data.

MAX

In CHAR, HEX or LHEX display format, scrolls to rightmost column. In TABL display format, scrolls to the rightmost field.

CSR

Scroll right to the cursor position if the cursor is within the data, otherwise one screen page.

Availability

- On all panels when the display exceeds the width of the page.

Related tasks and examples

[LEFT primary command on page 473](#)

ROOT primary command

The ROOT primary command changes your position in the database from the current segment to either the root segment in the current hierarchical path or to the first root segment in the database.

Syntax



If the FIRST operand is specified, then the ROOT command repositions on the first root segment in the database. Otherwise the ROOT command positions on the root segment in the current hierarchical path.

Availability

- [IMS data panel on page 309](#)
- Not active in ZOOM mode.

Related tasks and examples

- [PARENT primary command on page 482](#)

SAVE primary command (Edit only)

The SAVE primary command makes FM/IMS immediately issue a checkpoint (CHKP) call. The checkpoint call requests to have all segment updates currently in buffers written to the database data sets.

Syntax

►► SAve ◄◄

When a static PSB with no IO PCB is used to edit a database, the SAVE command is not active.

Availability

- Edit only.

Related tasks and examples

- [AUTOSAVE primary command \(Edit only\) on page 434](#)

SCOPE primary command

In an Edit or Browse session, the "scope" is the range over which:

- Commands operate
- Segments are retrieved for display

The SCOPE primary command allows you to change the scope to either the current database record or the entire database.

Syntax

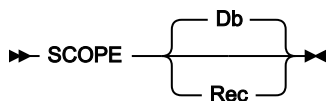

DB

The scope of command operation is the entire database. In multi-segment displays, scrolling takes you to the end of the database.

REC

The scope of command operation is restricted to the current database record. In multi-segment displays, scrolling only takes you to the end of the database record.

When this option is active, only the NEXT primary command and the TWIN primary command issued against a root segment allow you to cross into another database record. For these commands, a pop-up panel is displayed when you reach a database record boundary. The pop-up panel gives you the option of crossing into another database record or canceling the command.

To change the initial scope setting for an Edit or Browse session, select or deselect the **Set SCOPE REC** option on the Editor Options panel (option 0.5).

Availability

- [Database Positioning panel on page 239](#)
- [Key Specification panel on page 332](#)
- [IMS data panel on page 309](#) (except when in ZOOM mode)

SEGMENT primary command

The SEGMENT primary command displays information about a segment defined as part of the current database.

Syntax

►► SEGment — *segment-name* ◄◄

Availability

- All panels after the 'Entry' panel for each function.
- Not active in ZOOM mode

Availability

- All panels within the Browse, Edit, Utilities (except Audit trail) and Template/View/Criteria Set dialogs, except the initial Entry panel for each function.

SEGSTATS primary command

The SEGSTATS primary command lists statistics for the records included in the current Edit or Browse session.

Syntax

▶▶ SEGStats ◀◀

Availability

- [IMS data panel on page 309](#)

Related tasks and examples

- [Listing statistics for the current Browse or Edit session on page 81](#)

SELECT ALL primary command

The SELECT ALL primary command is used to select or deselect all of the segments from the Database Positioning, Segment Selection and Segment Layout panels.

Syntax

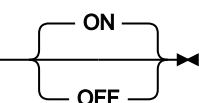
▶▶ SElect ALL  ◀◀

The diagram shows the text 'SElect ALL' followed by a horizontal line. Above the line is the word 'ON' and below the line is the word 'OFF'. A large curly bracket spans across both 'ON' and 'OFF', indicating a choice between the two options. The line ends with a double arrowhead pointing to the right.

ON

Selects all segments for processing.

OFF

Deselects all segments for processing.



Note: If all fields are deselected on the 'View: Segment Layout panel' or the 'Field Selection/Edit panel', then FM/IMS acts in the default way. That is it regards all elementary items to be selected.

Availability

- [Database Positioning panel on page 239](#)
- [Segment Layout Selection panel on page 377](#)
- [Segment Selection panel on page 379](#)

SHOW (FLD) primary command

The SHOW (FLD) command adds one or more hidden fields to the data display.

You can issue the command on the IMS data panel when the display format is SNGL or TABL.

You can hide a field from display by using the HIDE editor primary command or by using the S prefix command in the template editor.

Syntax

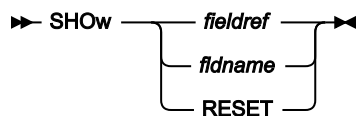

fieldref

A single field reference (for example, #1), a range (for example, #2-#5), or a list of single field references and ranges separated by spaces (for example, #1 #4 #6-#7). A single field specification is #*n*; *n* is a positive integer and cannot exceed the number of fields in the template that is being processed.

fldname

The name of a field in the template, which is optionally preceded by the pound symbol (#). Use #RESET to avoid any syntactical ambiguity with command keywords.

RESET

Shows all fields.

Availability

[IMS data panel on page 309](#) when the display format is SNGL or TABL.

Related tasks and examples

- [HIDE primary command on page 468](#)
- [SHOW \(REC\) primary command on page 495](#)

SHOW (REC) primary command

The SHOW primary command is applicable to IMS data panels that show different segment types, when a view is associated with the database. The command controls the display of lines for segments that are:

- Suppressed (not of the currently formatted segment type)
- Not matched (satisfy the selection criteria for a segment layout, but have a length that differs from the segment layout)

Syntax

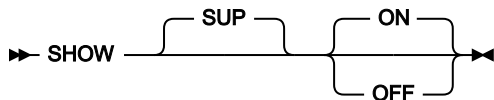

SUP

Pertains to suppressed segments.

OFF

Display suppressed segments as shadow lines.

ON

Show the specified types of segments in addition to segments currently shown.

Availability

- [IMS data panel on page 309](#) (except when in ZOOM mode)

SHOWCOB primary command

The SHOWCOB command displays details showing which COBOL compiler is currently being used.

Syntax

```
▶▶ SHOWCOB ▶▶
```

Availability

Available on all panels

Related tasks and examples

- [Checking which COBOL compiler you're using on page 29](#)

SLOC primary command

In a Browse or Edit session, this command temporarily displays or hides the Start location of each field when in SNGL display mode.

Syntax

▶ SLOC ◀

SLOC

Toggle command that shows or hides the Start location of each field when in SNGL display mode.

Availability

- [IMS data panel on page 309](#)

Related tasks and examples

- [Selecting a display format on page 61](#)
- [Editor Options panel on page 272](#)

SORT primary command

The SORT command changes the order of the data you are viewing. It can be used in Member selection panels.

SORT command in member selection panels

In member selection panels, the SORT primary command sorts the displayed members by any two fields displayed on the member list (apart from the line command field and **Prompt** field). Valid sort fields are the column headings of the member list statistics fields.



Note: For CARMA directory lists, only name and lib columns are supported.

The following syntax for the SORT command applies to PDSs with formatted records.

Figure 134. Syntax: member selection panels, formatted records

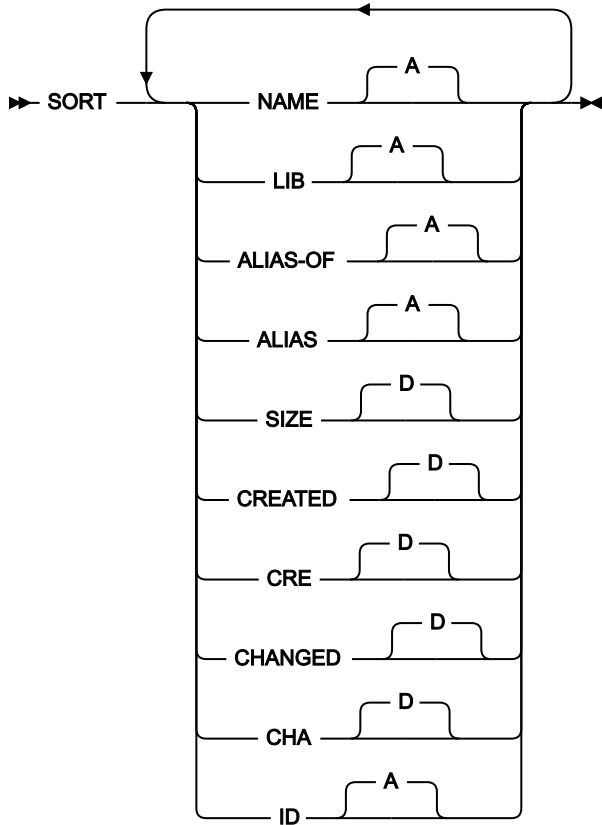
**NAME**

Sorted by member name.

LIB

Sorted by library directory number.

ALIAS-OF

Sorted by alias name.

ALIAS

Sorted by alias name.

SIZE

Sorted by number of statements in the members for members stored with ISPF statistics.

CREATED

Sorted by creation date.

CRE

Sorted by creation date.

CHANGED

Sorted by dates and times members were last changed.

CHA

Sorted by dates and times members were last changed.

ID

Sorted by user ID.

The following syntax for the SORT command applies to PDSs with unformatted records (RECFM=U) such as load libraries.
 Figure 135. Syntax: member selection panels, unformatted records

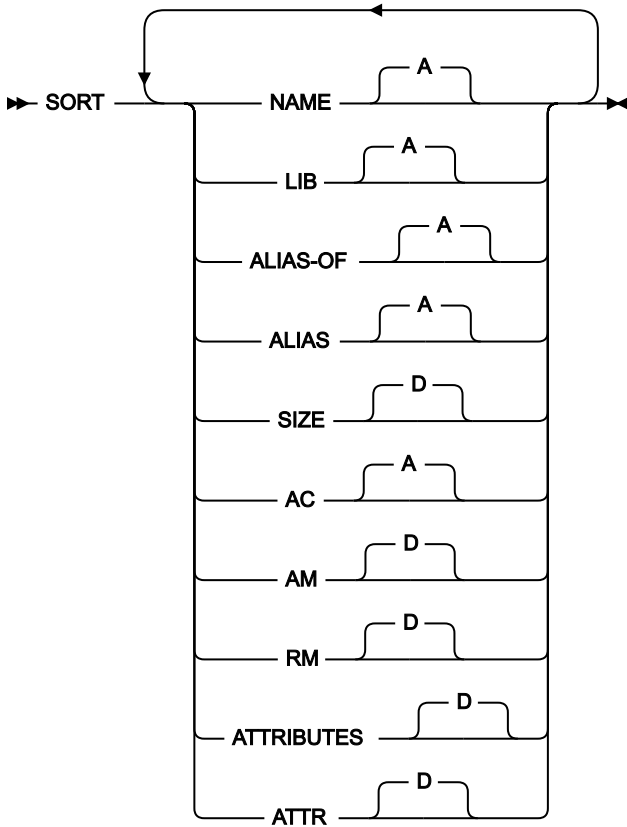

NAME

Sorted by member name.

LIB

Sorted by library directory number.

ALIAS-OF

Sorted by alias name.

ALIAS

Sorted by alias name.

SIZE

Sorted by the hexadecimal value for the load module size.

AC

Sorted by authorization code.

AM

Sorted by AMODE binder value.

RM

Sorted by RMODE binder value.

ATTRIBUTES

Sorted by attribute values determined by binder.

ATTR

Sorted by attribute values determined by binder.

The following syntax for the SORT command applies to PANVALET members.

Figure 136. Syntax: member selection panels, PANVALET members

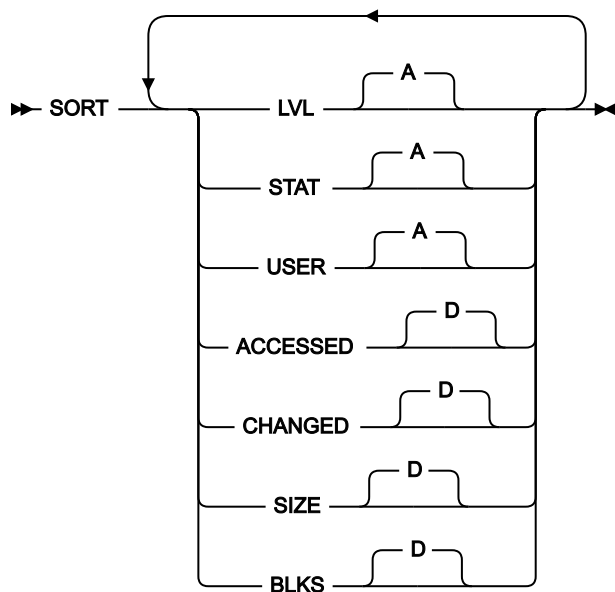
**LVL**

Sorted by member level.

STAT

Sorted by member status.

USER

Sorted by user code.

ACCESSED

Sorted by last access date.

CHANGED

Sorted by last changed date.

SIZE

Sorted by number of statements.

BLKS

Sorted by number of blocks.

Related tasks and examples

- [Specifying a Library data set on page 32](#)

Availability

- [PSB Selection panel on page 361](#)

SSID primary command

The SSID command allows you to view and modify the IMS catalog specified in the template you are editing. The command is available on the Template Specification panel when the template specifies an IMS catalog rather than a DBD library list.

When you issue the command, FM/IMS displays the IMS Catalog Specification panel.

▶▶ **SSID** ◀◀

Availability

- [Template Specification panel on page 412.](#)

STR primary command

In a Browse or Edit session, this command temporarily displays or hides the template structure information (field/element level) when in SNGL display mode.

Syntax

▶▶ **STR** ◀◀

STR

Toggle command that shows or hides the template structure information for each field when in SNGL display mode.

Availability

- [IMS data panel on page 309](#)

Related tasks and examples

- [Selecting a display format on page 61](#)
- [Editor Options panel on page 272](#)

TOP primary command

The TOP primary command scrolls to the top of the selected 'view' of the database. If in CHAR mode, paging down through the segments the TOP command displays the segments from the original start of the display, not necessarily the start of the database. In SNGL mode, the TOP command brings you back to the first position of the displayed segment.

Syntax

►- TOP -►

Availability

- On all panels where the display exceeds one page.

TPRINT primary command

The TPRINT primary command prints the current Segment Layout for the template or view being edited.

Syntax

►- TPrint -►

Availability

- [Segment Layout panel on page 370](#) (for a Template or View)

TWIN primary command

The TWIN primary command repositions on an occurrence of the current segment type under the same parent.

Syntax

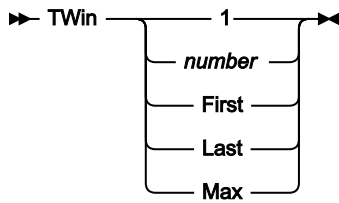

number

must be a positive integer which is used to request repositioning by skipping the next *number* occurrences of the current segment type under the current parent.

If the *number* is greater than the number of remaining occurrences of the current segment type, the following message is displayed:

```
"SEGMENT TWIN BOUNDARY"
```

and you are repositioned at the hierarchical boundary.

First

requests repositioning on the first occurrence of the current segment type under the current parent.

Last

requests repositioning on the last occurrence of the current segment type under the current parent.

Max

also requests repositioning on the last occurrence of the current segment type under the current parent.

Availability

- [IMS data panel on page 309](#) (except when in ZOOM mode)

TYPE primary command

In a Browse or Edit session, this command temporarily displays or hides the Type and Length columns when in SNGL display mode.

Syntax

```
▶ TYPE ◀
```

TYPE

Toggle command that shows or hides the Type and Length columns for each field when in SNGL display mode.

Availability

- [IMS data panel on page 309](#)

Related tasks and examples

- [Selecting a display format on page 61](#)
- [Editor Options panel on page 272](#)

UNDO primary command

The UNDO primary command allows you to roll back all your editing changes since the last checkpoint.

Syntax

▶— UNDO —◀

Issuing the UNDO command on the IMS data panel backs out all your editing changes since the last checkpoint. This is provided that you are editing in BMP mode or, if you are editing in DLI mode, the following conditions are true:

- The IMS log option on the DLI Mode Parameters panel is set to 1. Keep, 2. Keep when updates, or 3. Delete.
- The Dynamic backout option on the DLI Mode Parameters panel is selected.
- The Edit is using either a dynamic PSB or a static PSB that has an IO PCB.

If you are editing in DLI mode and one or more of these conditions is not true, FM/IMS issues an error message.

Availability

- [IMS data panel on page 309](#)

UP primary command

The UP primary command (in multi-segment display), scrolls backwards through the segments in the database.

The UP primary command (in single-segment display), scrolls backwards through the data of the current segment.

Syntax

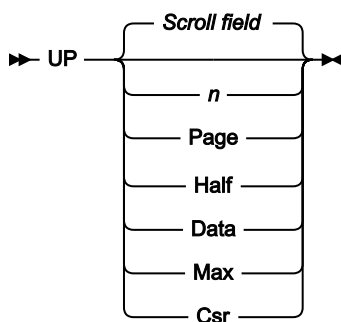

nnnn

Scroll up *nnnn* lines.

Csr

Scroll up to the cursor position.

Data

Scroll up one line less than a page of data.

Half

Scroll up half a page of data.

Max

Scroll to top of file. This has the same effect as the TOP command.

Page

Scroll up one page of data.

Scroll field

Scroll up by the amount indicated in the **Scroll** field. This is the default if no parameter is used.

Availability

Available on all panels where the display exceeds one page.

Related tasks and examples

`UP 15`

Scrolls up 15 lines.

`U`

Scrolls up the number of lines indicated by the **Scroll** field.

`UP DATA`

Scrolls up one line less than a page of data.

UPDATE primary command

The UPDATE primary command compiles the specified copybook and either updates an existing template or creates a new template.

Syntax

► UPDATE ◄

Availability

- [Figure 113: Template Specification panel on page 413](#)
- [Template Specification panel on page 412](#)

VER primary command

The VER command displays the File Manager release and PTF level, and indicates whether or not FM/IMS is APF-authorized.

If the VER command already exists in the ISPF command table at your site, you can use the LVL synonym to perform the same task.

Syntax

```
▶ VER ▶
  LVL
```

Availability

Available on all panels

Related tasks and examples

- [ABOUT primary command on page 434](#)
- [Checking your FM/IMS version on page 28](#)

VIEW primary command

The VIEW primary command changes the display from one segment type to another. You can either change the current segment (the one at the top of the page) or you can place the cursor on the segment you want to change and press Enter.

Syntax

```
▶ VIEW ▶
```

Availability

Available on all database display panels when a view is used.

Related tasks and examples

[Working with Templates and Views on page 82](#)

VSAVE primary command

The VSAVE primary command can be issued from the Database Positioning panel or from the Data Display panel to save the current view. If this is a new view, a window is displayed to prompt for the data set and member name.

Syntax

```
▶ VSAVE ▶
```

Availability

- [IMS data panel on page 309](#)
- [Database Positioning panel on page 239](#)

WIDTH primary command

The WIDTH command sets the display width for one or more fields in TABL display format.

You can issue the command on the IMS data panel when the display format is TABL.

You can also specify a display width by specifying a value in the output width field on the field attributes panel in the template editor. Use the E prefix command to access the field attributes panel.

Syntax

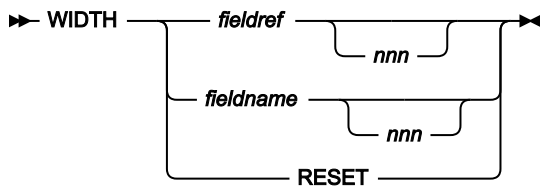

fieldref

A single field reference (for example, #1), a range (for example, #2-#5), or a list of single field references and ranges separated by spaces (for example, #1 #4 #6-#7). A single field specification is #*n*; *n* is a positive integer and cannot exceed the number of fields in the template that is being processed.

fldname

The name of a field in the template, which is optionally preceded by the pound symbol (#). Use #RESET to avoid any syntactical ambiguity with command keywords.

nnn

A positive integer that represents the desired display width for the fields. If this parameter is omitted, the display width is reset to the default value. The minimum value of *nnn* is 6. The maximum value of *nnn* depends on the data type:

Data type	Maximum value of <i>nnn</i>
Binary integer	30
Binary floating point	35
Packed decimal	45
Other data types	If the value of the display length is less than 20, the maximum value of <i>nnn</i> is 30. Otherwise, the maxi-

Data type	Maximum value of <i>nnn</i>
	Maximum value of <i>nnn</i> is the value of the display length plus 10.

RESET

Resets the display width of all fields to their default values.

Availability

[IMS data panel on page 309](#) when the display format is TABL.

Related tasks and examples

- [Field Attributes panel - alphanumeric fields on page 287](#)
- [Field Attributes panel - numeric field on page 294](#)

XKEY primary command

The XKEY primary command creates a data set containing the keys of all root segments from the current position. You can use this data set on the Extract (option 3.3) panel to extract segments.

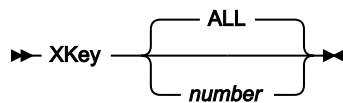
Syntax**ALL**

The keys of all root segments between the current position and end of file is output to the key extract file.

number

The keys of every *number* root segment between the current position and end of file is output to the key extract file.

The allocation attributes for the data set created by the XKEY command are defined on the Output Data Set Allocation (option 0.9) panel.

The format for the name of the XKEY data set is:

```
userid.XKEY.Dyyymmdd.Thhmmss.dbd_name.
```

Availability

- [IMS data panel on page 309](#)

Related tasks and examples

- [Extracting data on page 156](#)

ZOOM primary command

The ZOOM primary command (in CHAR, HEX, and LHEX display formats), limits the display to just one segment, showing you all of the data in the segment without having to scroll left or right.

The ZOOM primary command (in SNGL and TABL display formats), zooming in shows all fields in the segment presented in SNGL display format, rather than only those fields selected by the view.

You can either ZOOM in on the current segment (the one at the top of the page) or you can place the cursor on the segment you want to ZOOM in on and press Enter.

To zoom back out to the display format that was current prior to zooming in, enter the ZOOM command again.

Syntax

► ZOOM ◄

Availability

- [IMS data panel on page 309](#)

Using primary commands

When browsing

When you are browsing or editing data, you can enter Primary Commands on the Command line of the IMS data panels to perform the following functions:

Action

Command

Scroll the data

- [BOTTOM primary command on page 435](#)
- [DOWN primary command on page 450](#)
- [LEFT primary command on page 473](#)
- [NEXT primary command on page 479](#)
- [PREVIOUS primary command on page 483](#)
- [RIGHT primary command on page 490](#)
- [TOP primary command on page 501](#)
- [UP primary command on page 503](#)

Scroll to a particular segment number or text

[LOCATE primary command on page 476](#)

Find a string

[FIND primary command on page 455](#)

[RFIND primary command on page 489](#)

Turn off highlighting of found strings

[RESET primary command on page 488](#)

Find fields in error

[FE \(Find Error\) primary command on page 454](#)

Show shadow lines

[SHOW \(REC\) primary command on page 495](#)

Zoom in to see all of one segment

[ZOOM primary command on page 508](#)

View suppressed segments

[VIEW primary command on page 505](#)

Display data in hexadecimal format

[HEX primary command on page 467](#)

Display the Field Reference

[REFS primary command on page 486](#)

Display the template structure information

[STR primary command on page 500](#)

Display the Field Type

[TYPE primary command on page 502](#)

Adjust position within the database and all scroll commands

[CHILD primary command on page 448](#)

[KEY primary command on page 472](#)

[PARENT primary command on page 482](#)

[ROOT primary command on page 491](#)

[TWIN primary command on page 501](#)

Display or print the database

[DBD primary command on page 449](#)

[DPRINT primary command on page 452](#)

[FIELD primary command on page 455](#)

[HIERARCH primary command on page 469](#)

[SEGMENT primary command on page 492](#)

[SEGSTATS primary command on page 493](#)

Issue ROLB call

[CANCEL primary command on page 436](#)

[QUIT primary command on page 485](#)

[UNDO primary command on page 503](#)

Save a temporary view

[HEX primary command on page 467](#)

Select or deselect

[SELECT ALL primary command on page 493](#)

Specify the positioning logic

[GE primary command on page 466](#)

Change the current display format

[FORMAT primary command on page 464](#)

Create data set with the keys of all root segments

[XKEY primary command on page 507](#)

When editing

When you are *editing* data, you can enter Primary Commands on the Command Line of the IMS data panel to perform the following functions:

Action

Command

Find and replace a string

[CHANGE primary command \(Edit only\) on page 440](#)

[RCHANGE primary command on page 485](#)

[FE \(Find Error\) primary command on page 454](#)

Delete and insert segments

[DELETE primary command \(Edit only\) on page 450](#)

[INSERT primary command \(Edit only\) on page 470](#)

[REPEAT primary command \(Edit only\) on page 487](#)

Displays information about logical relationships

[RELATED primary command on page 486](#)

Cancel pending line commands and remove find highlighting

[RESET primary command on page 488](#)

[SAVE primary command \(Edit only\) on page 491](#)

Differences between primary commands when editing and browsing

These primary commands, available in both Browse and Edit, have the following additional features in Edit:

CANCEL, END and QUIT

In Browse, CANCEL, END and QUIT are synonymous. In Edit, END automatically saves changes before ending the edit session, while CANCEL and QUIT end the edit session without saving changes; if you have made any changes, FM/IMS displays a message box asking you to confirm that you want to discard those changes.

Line commands

This section describes the line commands that are available within the browse and edit functions of FM/IMS. These commands are only available from a multi-segment display.

D (Delete - Edit only)

The D line command deletes a segment and all its dependent segments.

FC, FH, FL, FS, FT (Format)

Using one of the above as a line command against a displayed segment occurrence is effectively the same as scrolling that segment to the top of the display, issuing a view for that line (if it is other than the current layout) and changing format.

I (Insert - Edit only)

Using the I line command you can insert an occurrence of the segment type displayed on the line where the command was entered.

FM/IMS displays the Insert Segment panel where you can enter key values for segments in the hierarchical path to the segment being inserted. The Insert Segment panel is initialized with the key values for the segments in the hierarchical path for the selected segment.

After the insertion of the segment is completed, FM/IMS returns to the IMS Data panel, redisplaying the page that was previously displayed.

K (Key)

Using the K line command you can change your current position in the database to another segment occurrence.

FM/IMS displays the Key Specification panel where you can enter key values for each segment in the hierarchical path to the segment where the K line was entered. The Key Specification panel is initialized with the key values for the segments in the hierarchical path.

You can only reposition on another occurrence of the same segment type as the segment where the K command was entered.

After the Key Specification panel is processed, FM/IMS redisplay the IMS Data panel, positioned on the segment which matches the concatenated key entered on the Key Specification panel.

R (Repeat - Edit only)

Using the R line command you can repeat an occurrence of the segment type displayed on the line where the command was entered.

FM/IMS displays the Insert Segment panel where you can enter key values for segments in the hierarchical path to the segment being repeated. The Insert Segment panel is initialized with the key values for the segments in the hierarchical path up to and including the selected segment.

After the segment has been inserted in the database, FM/IMS returns to the IMS Data panel redisplaying the panel that was previously displayed.

RA (Repeat All - Edit only)

Using the RA line command you can repeat hierarchical substructures in the database. The segment displayed on the line on which the RA command is entered is the parent of the substructure to be repeated.

FM/IMS displays the Insert Segment panel where you can enter key values for segments in the hierarchical path to the segment that is the parent of the substructure. The Insert Segment panel is initialized with the key values for the segments in the hierarchical path up to and including the parent of the substructure. You can also enter data for the segment that becomes the parent of the new substructure. The data for the child segments in the new substructure is copied from the children under the segment where the RA line command was entered. When all modifications are done, and the Exit function key (F3) is entered, the new segments are inserted. Any violation of IMS rules results in a pop-up panel with the appropriate status code.

After the new parent and its substructure have been inserted in the database, FM/IMS returns to the IMS data panel redisplaying the panel that was previously displayed.

V (View)

When you associate a view with a database, FM/IMS displays segments of one layout. You can enter the V line command against a segment that has been suppressed from display, and the segment (and all segments of the same layout type) are displayed. They become currently formatted segments. All other segments then become shadow lines.

Chapter 12. Batch reference

This chapter describes the FM/IMS batch functions. FM/IMS provides batch functions to:

- Update templates
- Update views
- Update criteria sets
- Extract data from your IMS databases
- Load your IMS databases
- Print data from your IMS databases
- Edit data in your IMS databases (Batch edit)
- View data in your IMS database (Batch browse)
- Initialize your IMS database

How to use this reference chapter

This chapter lists the FM/IMS batch functions.

The following subsections are supplied, where relevant, for each function:

Purpose

A short summary of what you can do with the function.

Usage notes

A more detailed explanation of the function.

Return Codes

Lists the return codes that are specific to the function.

Related functions

Other functions that are related in some way.

Syntax

A syntax diagram, followed by a parameter list. The parameter list describes the parameter, and shows (where appropriate) its maximum value and default value.

If you specify parameters that are not relevant to the function, FM/IMS ignores them. If you specify the same parameter more than once, FM/IMS uses the first value that you specify.

For information on how to read a syntax diagram, see [How to read syntax diagrams on page xi](#).

Batch example

A listing of a sample batch job.

Reports

A sample listing of any report or reports produced by the batch JCL.

IMS Template Update (ITU)

Purpose

You can use this utility to:

- Update templates with the latest copybook or DBD definitions.
- Create new templates based upon existing templates.

Usage notes

- Template members selected for processing can be filtered by specifying copybook names or masks so that only templates referencing those copybooks are included.

Related functions

ICU

IMS Criteria sets update

IVU

IMS Views update

Figure 137. Syntax

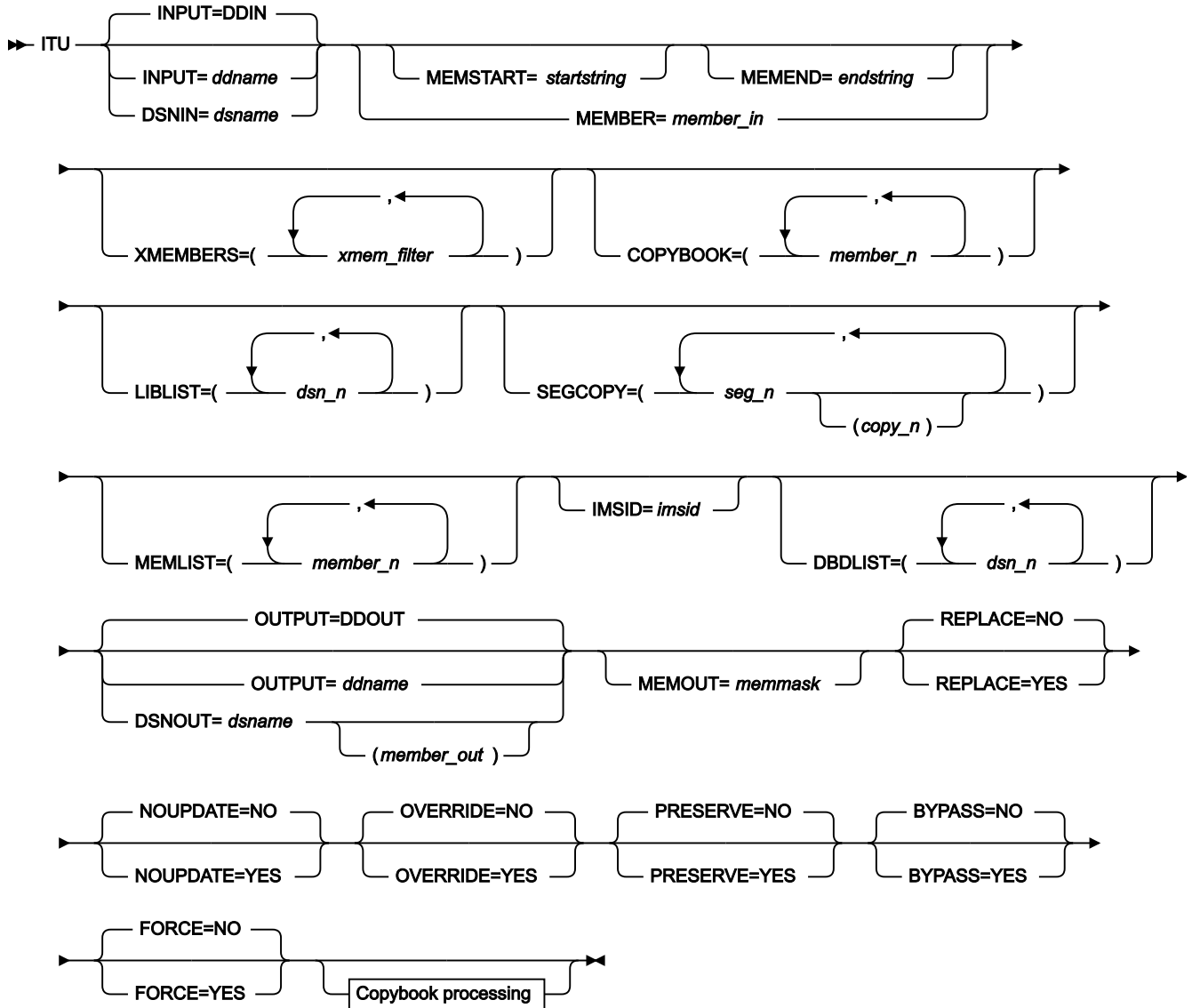

Copybook processing

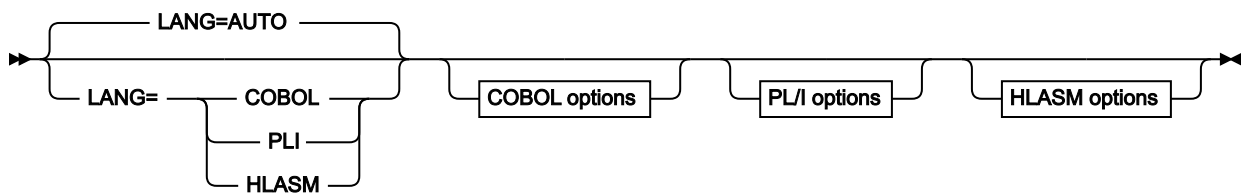

COBOL options

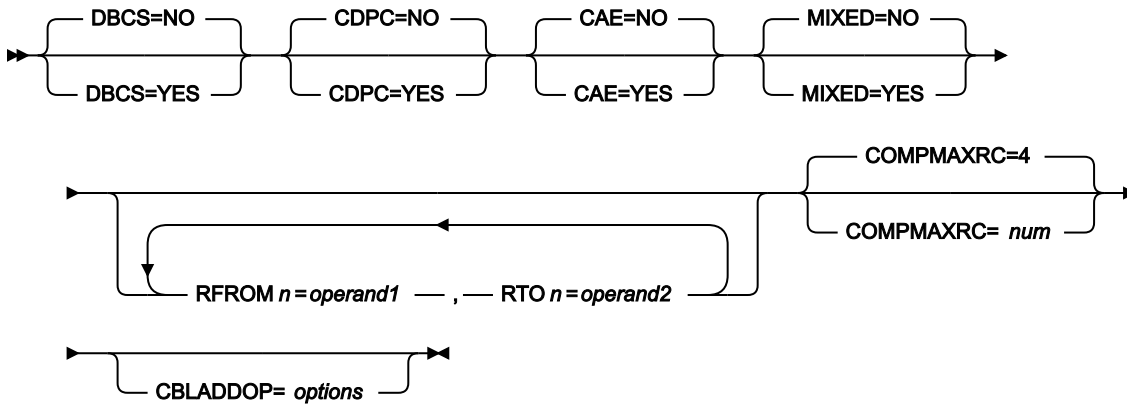

PL/I options

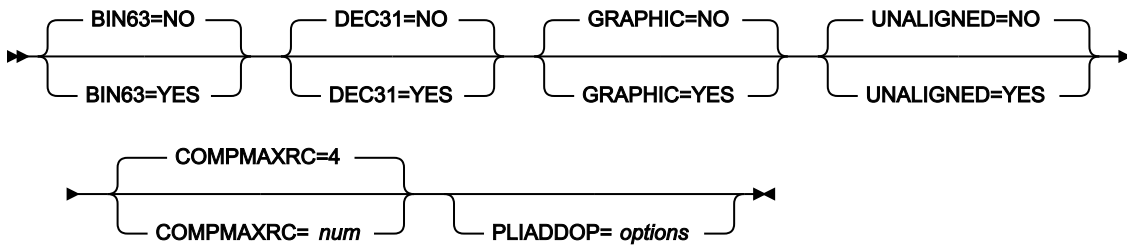

HLASM options

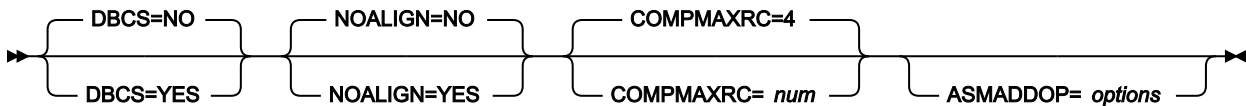

INPUT=ddname

Identifies the DD statement for the data set that contains the templates you want the utility to process. You can specify a PDS(E) or a concatenated PDS(E). The default DD name, DDIN, is used when you do not specify the INPUT or DSNIN parameters.

If the OUTPUT and DSNOUT parameters are not specified, the utility updates the selected members of the specified data set.

DSNIN=dsname

The name of the data set that contains the templates that you want the utility to process.

MEMBER=member_in

Specify the members of the input template data set that you want the utility to process. You can specify a member name (if there is only one member that you want the utility to process) or a member name pattern representing one or more members of the input Template data set.

A member name pattern can consist of any characters that are valid in a member name and two special pattern characters: the asterisk (*) and the percent symbol (%).

*

represents any number of characters. As many asterisks as required can appear anywhere in a member name pattern. For example, if you enter a member name pattern of `*d*`, all members in the PDS whose name contains "d" are processed.

%

is a place holding character that means a single character. As many percent symbols as necessary can appear anywhere in a member name pattern. For example, if you enter a member name pattern of `%%%`, all members in the PDS whose name is four characters in length are processed.

MEMSTART=*startstring*

Is used to specify the start of a range of member names to be included. If MEMSTART is specified but MEMEND is omitted, all members of the PDS(E) from the *startstring* value onwards are included. *startstring* can have the same values, including wild cards, as for the *member-in* parameter of the MEMBER keyword.

MEMEND=*endstring*

Is used to specify the end of a range of member names to be included. If MEMEND is specified but MEMSTART is omitted, all members of the PDS(E) up to the *endstring* value onwards are included. *endstring* can have the same values, including wild cards, as for the *member_in* parameter of the MEMBER keyword.

XMEMBERS

Provides a way to exclude from processing library members that would otherwise be selected using the MEMSTART, MEMEND, and MEMBER options.

xmem_filter

A member name filter identifying one or more members that are to be excluded from processing. A filter can be a member name pattern representing multiple members.

To specify a member name filter containing lowercase characters, use a character string in the format `c'string'`. Filter values can also be specified as hexadecimal strings in the format `x'hex-digits'`.

COPYBOOK

When this parameter is specified, the utility restricts the templates that are processed to those that include the copybooks that you specify in this parameter. You can specify a list that includes copybook member names and copybook member patterns. A template is only processed if it includes a copybook that is either specified in the list or matches a copybook member pattern specified in the list.

member_n

A copybook member name or member pattern. Generic name masks are not allowed.

LIBLIST

Allows you to specify a list of up to twelve copybook libraries that contain the copybooks that you want the utility to use.

When the LIBLIST parameter is specified, the utility uses the layout members in the specified copybook libraries to build the template (rather than the layout members in the copybook libraries referenced in the template). So to avoid update errors, you need to ensure that all the layout members referenced in all the templates that the utility is updating are available in the libraries you specify. If the update using the specified copybook libraries is successful, the utility changes the copybook library list in the template to the specified library list.

dsn_n

The name of the copybook library to be searched. Generic name masks are not allowed.

SEGCOPY

When the DBD that a template is built from is modified to include new segment types, you need to provide the following information in the SEGCOPY parameter:

- The names of all the new segment types in the DBD, and
- For each new segment type, the name of a copybook member that describes the segment layout.

seg_n

The names of all the new segment types in the databases whose templates you are updating.

copy_n

For each new segment type, the name of a copybook member that describes its layout.

MEMLIST

Allows you to specify a list of member names with optional associated output template names. If you do not specify the associated template name, FM/IMS uses the input member name or the name as identified by the MEMOUT mask, *memmask*.

member_n

The name of the member to be processed. Generic name masks are allowed.

template_n

The name of the template after it has been copied to the output data set. If unspecified, the output template is not renamed.

IMSID

Allows you to specify the IMS catalog that contains the database definitions (DBDs) that you want the utility to use. You identify the IMS catalog that the function is to use by specifying the subsystem that uses it.

The utility uses the DBDs in the specified IMS catalog when BYPASS=YES is not specified and either or both of these conditions are true:

- The DBDLIST parameter is not specified.
- The DBDs that were used the previous time the template's segment list was updated came from an IMS catalog rather than DBD libraries.

When this is the case, the utility searches the specified IMS catalog for a DBD for the database that the template is for and obtains a list of the segment types in the database from the DBD that it finds. If the template's segment list is not the same as this list, the utility updates the template's segment list to make it the same.

If the update of the template is successful, the utility saves the name of the specified IMS catalog in the template.



Note: When the DBDLIST, IMSID and BYPASS parameters are not specified, the utility uses the DBDs in either the DBD library list stored in the template or the IMS catalog stored in the template.

DBDLIST

Allows you to specify a list of up to 6 DBD libraries that contain the database definitions (DBDs) that you want the utility to use.

The utility uses the DBDs in the specified DBD libraries when BYPASS=YES is not specified and either or both of these conditions are true:

- The IMSID parameter is not specified.
- The DBDs that were used the previous time the template's segment list was updated came from DBD libraries rather than an IMS catalog.

When this is the case, the utility searches the specified libraries for a DBD for the database that the template is for and obtains a list of the segment types in the database from the DBD that it finds. If the template's segment list is not the same as this list, the utility updates the template's segment list to make it the same.

If the update of the template is successful, the utility saves the specified DBD library list in the template.



Note: When the DBDLIST, IMSID and BYPASS parameters are not specified, the utility uses the DBDs in either the DBD library list stored in the template or the IMS catalog stored in the template.

DSNOUT=*dsname*

Specifies the name of the data set in which you want the updated templates stored. The data set you specify must be a PDS(E). You can further qualify this data set, as follows:

(*member-out*)

Where *member-out* is the member of the specified PDS(E) in which you want the updated template stored.

MEMOUT=*memmask*

When a number of input members have been specified, you can specify a member name pattern for the output templates, allowing you to rename your templates as they are created. The member name pattern can consist

of any characters that are valid in a member name and two special pattern characters: the asterisk (*) and percent sign (%).

Asterisk (*)

The asterisk is a place-holding character that means multiple characters with no change. Only one asterisk should appear in the mask. Any subsequent asterisk characters are treated as percent signs. For example, if you enter:

```
ABC*
```

The renamed members all begin with ABC followed by the remainder of the old member name.

Percent sign (%)

The percent sign is a place-holding character that means a single character with no change. As many percent symbols as necessary may appear anywhere in a member name. For example, if you enter:

```
%%%A*
```

The 1st 3 characters of the renamed members remain unchanged, the 4th character is replaced with the letter "A" and the remainder of the old member name remains unchanged.

REPLACE

Specifies whether or not FM/IMS replaces like-named templates in an output PDS(E).

NO

Like-named templates in the output PDS(E) are not replaced.

YES

Like-named templates in the output PDS(E) are replaced.

NOUPDATE

Specifies whether or not FM/IMS writes back updates to the data set.

NO

Updates are written back to the data set.

YES

Updates are not written back to the data set.

OVERRIDE

Specifies whether or not FM/IMS overrides any compile options found in the template with the compiler options found in the parameter list.

NO

Compile options found in the template are not overwritten with the compiler options found in the parameter list.

YES

Compile options found in the template are overwritten with the compiler options found in the parameter list.

PRESERVE

Specifies whether or not FM/IMS uses the current version of the copybook.

NO

FM/IMS searches for the first version of the copybook.

YES

FM/IMS uses the current version of the cookbook, provided the copybook still exists in the library it was previously found in, and the library is in the list the update process is using.

FM/IMS searches for the first version of the copybook in the order the libraries are listed if one of these conditions applies:

- NO has been specified for this option.
- The copybook no longer exists in the library it was previously found in.
- The library is not in the list the update process is using.

FORCE

Specifies whether or not FM/IMS updates the template when changes to the segment list or segment layouts are detected.

NO

If no changes to the segment list or segment layouts are detected during the update process, the update will not take place.

YES

FM/IMS updates the template, even when no changes to the segment list or segment layouts are detected.

BYPASS

Specifies whether or not FM/IMS checks the DBD for any changes to the segment name list. If the DBDs for the databases whose templates you are updating have not had segment types added or removed since the last time the templates were updated, you can specify BYPASS=NO.

NO

FM/IMS does not check the DBD for any changes to the segment name list.

YES

FM/IMS checks the DBD for changes to the segment name list and, if there are changes, updates the template to reflect these changes.

Compiler options

FM/IMS uses the following options when OVERRIDE=YES is specified:

LANG

Determines whether FM/IMS automatically detects the copybook language or interprets the language as COBOL, PL/I, or HLASM.

AUTO

Automatically detect whether the copybook language is COBOL or PL/I, and invoke the appropriate compiler. If the compilation results in a return code greater than 4, then invoke the compiler for the other language. If the second compilation also results in a return code greater than 4, then retry the first compiler and report the compilation errors. If FM/IMS successfully creates a template (despite the compilation errors), then continue processing with the template.

COBOL

Invoke the COBOL compiler to create a template from the copybook. (Do not invoke the PL/I compiler, even if the COBOL compilation results in errors.)

PLI

Invoke the PL/I compiler to create a template from the copybook. (Do not invoke the COBOL compiler, even if the PL/I compilation results in errors.)

HLASM

Invoke the HLASM compiler to create a template from the copybook.

COBOL options

The following options are used to compile a COBOL copybook into a template:

DBCS=YES

Use the DBCS compiler option.

DBCS=NO

Use the NODBCS compiler option.

For details on the effect of the DBCS and NODBCS compiler options, see the *IBM COBOL Programming Guide for OS/390 & VM*.

CDPC=NO

Do not use the COBOL SPECIAL-NAMES paragraph "Decimal-point is comma".

CDPC = YES

Use the COBOL SPECIAL-NAMES paragraph "Decimal-point is comma".

CAE=NO

Do not use the COBOL compile option ARITH(EXTEND).

CAE = YES

Use the COBOL compile option ARITH(EXTEND).

MIXED = NO

Field names stored in the template in uppercase.

MIXED = YES

Field names stored in the template in the original case as coded in the COBOL copybook.

RFROM1 RT01 ... RFROM5 RT05

Up to five pairs of "From?" and "To?" pseudo-text character strings for the COBOL REPLACE compiler-directing statement.

If your COBOL copybooks contain characters that you want to remove or replace with other characters before compiling the copybooks into templates, then use these replacing options.

For example, if your copybooks contain colon characters (:) that you want to remove before compiling, then specify '====' as *operand1* and '===== ' as *operand2*.

For details on specifying "From?" and "To?" strings for COBOL REPLACE, see the *IBM COBOL Language Reference*.

COMPMAXRC

Sets the maximum acceptable return code for a copybook compile. A return code higher than the specified level causes the function to stop. Default is 4.

CBLADDOP

Additional COBOL compiler options which are included in a CBL statement when compiling COBOL copybooks.

PL/I options

The following options are used to compile a PL/I copybook into a template:

BIN63=YES

Use the LIMITS(FIXEDBIN(63)) compiler option.

BIN63=NO

Use the LIMITS(FIXEDBIN(31)) compiler option.

DEC31=YES

Use the LIMITS(FIXEDDEC(31)) compiler option.

DEC31=NO

Use the LIMITS(FIXEDDEC(15)) compiler option.

GRAPHIC=YES

Use the GRAPHIC compiler option.

GRAPHIC=NO

Use the NOGRAPHIC compiler option.

UNALIGNED=YES

Use the DEFAULT RANGE (*) UNALIGNED, language statement to change the default alignment.

UNALIGNED=NO

Use the PL/I default.

COMPMAXRC

Sets the maximum acceptable return code for a copybook compile. A return code higher than the specified level causes the function to stop. Default is 4.

PLIADDOP

Additional PL/I compiler options which are included in a *PROCESS statement when compiling PL/I copybooks.

For details on the effect of these compiler options, see the *IBM VisualAge PL/I for OS/390 Programming Guide*.

HLASM options

The following options are used to compile an Assembler copybook into a template:

DBCS=YES

Use the DBCS compiler option.

DBCS=NO

Use the NODBCS compiler option.

NOALIGN=YES

Use the NOALIGN compiler option.

NOALIGN=NO

Use the ALIGN compiler option.

COMPMAXRC

Sets the maximum acceptable return code for a copybook compile. A return code higher than the specified level causes the function to stop. Default is 4.

ASMADDOP

Additional HLASM compiler options which are included in a *PROCESS statement when compiling COPY and MACRO members.

For details on the effect of these compiler options, see the *HLASM V1R6 Programmer's Guide*.

Batch example

```
//FMBAT EXEC PGM=FMNIMS
//STEPLIB DD DSN=FMN.SFMNMOD1,DISP=SHR
//SYSPRINT DD SYSOUT=*
//IDIOPTS DD DSN=FMN.IDIOPTS,DISP=SHR
//FMNIMSIN DD *
$$FILEM ITU DSNIN=FMN.IMS.IVP.TEMPLATE,
$$FILEM MEMBER=DJ%E,
$$FILEM MEMLIST=(DJ1E,
$$FILEM          DJ2E),
$$FILEM DBDLIST=(FMN.IMS.IVP.DBDLIB),
$$FILEM DSNOUT=FMN.IMS.IVP.TEMPLATE.MORE,
$$FILEM REPLACE=YES
```

Update report

IBM File Manager for z/OS IMS Component

Template Update Report

Template	New name	Type	Status
DJ1E		Template	Replaced
DJ2E		Template	Old template requires LIBLIST

FMN1495I 2 members read 0 Updated 0 Not changed 1 Replaced 1 Errors

Report fields

Template

This is the name of the template.

Lib

When there is more than one input library, this column shows the library number from which the template came. This column will only be present if there is more than one template input library.

New name

This is the new output template name if the template was renamed during the update process.

Status

A value from the status table. See [Table 2: Batch update status and action on page 525](#).

Table 2. Batch update status and action

Status	Explanation	Action
Updated	The template was successfully updated.	None
Not Replaced	The template exists in the output data set and the replace option is NO.	Specify replace and rerun if required.

Table 2. Batch update status and action (continued)

Status	Explanation	Action
Replaced	The template exists in the output data set and has been successfully updated with replace option YES.	None.
Compile Error	Unable to compile the copybooks associated with the template.	Rerun using option 4.4 in foreground for the failing template and look at the compile listing produced.
Corrupt Template	The internal format of the template is corrupted. This could have occurred because the template has been modified outside of File Manager.	This is an internal error. If the template has not been modified then keep a copy of it and contact IBM® Support.
SYSLIB not found <i>syslib</i>	The syslib referenced in the template could not be found.	Rerun the update in foreground using option 4.1 which will list the SYSLIBs which you can then modify. Alternatively provide LIBLIST=(dsn1,dsn2...) parameter to identify the current location for the copybooks.
SYSLIB invalid attrs <i>syslib</i>	The syslib referenced in the template has invalid attributes for the language type for this template.	Change the syslib reference using option 4.1 or LIBLIST parameter.
Copybook not found name	The copybook name could not be located in the current libraries.	Provide the data set containing the referenced copybook using either 4.1 or the LIBLIST parameter.
Storage exhausted	File Manager ran out of storage during processing	Increase the region size.
No copybooks in libraries	The library list provided either from the template or override has no copybooks.	Rerun the update in foreground using option 4.1 which will list the SYSLIBs which you can then modify. Alternatively provide LIBLIST=(dsn1,dsn2...) parameter to identify the current location for the copybooks.
Not a valid template	The type of template is not valid for update processing.	This is an internal error that should never occur. Contact IBM® Support.
Duplicate name	The output template name has already been referenced by another template during update.	Correct parameters so that there are no duplicate names being saved.

Table 2. Batch update status and action (continued)

Status	Explanation	Action
Not found	The template member referenced could be not be found on the input data set.	Correct the input parameters to point to the right data set or member name.
Save error	The updated template could not be saved	Normally a space problem—check the output data set (or input data set if an output data set was not provided) and increase the size.
Update check successful	The update would have been a success, except that you ran with <code>NOUPDATE=YES</code> specified. This means that no updates were done.	None.
Updating of criteria failed	The update was not performed because fields that were previously referenced in criteria could not be found in the current versions of the copybooks.	Rerun the update in foreground using option 4.1. This should allow you to correct the expressions that have been invalidated as a result of your copybook changes.
Segment without layouts	The corresponding copy books for a given segment did not produce a layout.	Rerun the update in foreground using option 4.1. This should allow you to view the copybooks for each segment and determine which copybooks do not contain data layouts.
Old template requires liblist	The template you are trying to update is an old template that does not contain the copybook libraries required for the update process.	You need to provide a LIBLIST parameter for batch to provide the copybook data sets. Using option 4.4 you can provide the copybook data sets via the entry panel.
DBD initialization failed	The DBD referenced in the template could not be loaded properly. The DBD data set and member name will be listed with the status.	Investigate why the DBD data set and member listed in the message are incorrect. Use DBDLIST or option 4.1 online to change the DBD library referenced by the template.
Template allocate error	The corresponding template data set for a view or criteria could not be allocated for the update process.	Check the data set name. Use the TPLIST parameter or option 4.2/4.3/4.4 to update the originating template data set.
DBD not found <i>member_name</i>	The DBD for this template could not be found in the specified DBD library.	Ensure that a DBD <i>member_name</i> can be found in the DBDLIST libraries if specified or the DBD library associated with this template.
Template not found <i>member_name</i>	The template for this view or criteria set could not be found either in the specified template library.	Ensure that a template <i>member_name</i> can be found the TPLIST libraries if specified or the original template data set used to create the view or criteria set.

IMS View Update (IVU)

Purpose

You can use this utility to:

- Update one or more views.
- Create views based upon existing views.

Usage notes

- You can filter the views selected for processing by providing the originating template member names or masks.

Related functions

ITU

IMS Template Update

ICU

IMS Criteria sets Update

Figure 138. Syntax

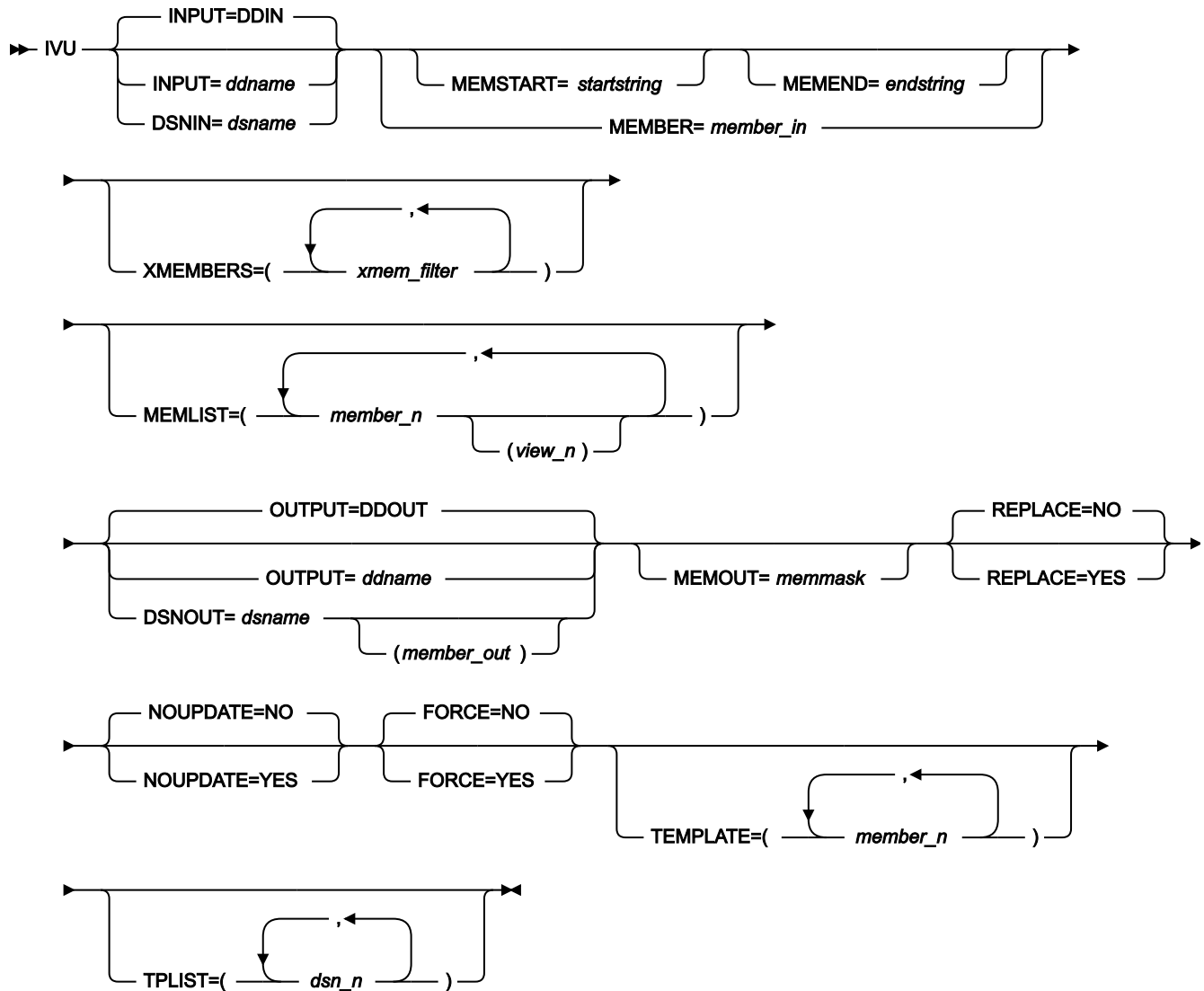
**INPUT=ddname**

Identifies the DD statement for the data set that contains the views you want the utility to process. You can specify a PDS(E), a concatenated PDS(E), or a sequential data set. The default DD name, DDIN, is used when you do not specify the INPUT or DSNIN parameters. If the OUTPUT and DSNOUT parameters are not specified, the utility updates the selected members of the specified data set or the specified sequential data set.

DSNIN=dsname

The name of the data set that contains the view or views that you want the utility to process.

MEMBER=member_in

When the input view data set is a PDS(E) or a concatenated PDS(E), specify the members of the data set that you want the utility to process. You can specify a member name (if there is only one member that you want the utility to process) or a member name pattern representing one or more members of the input view data set.

A member name pattern can consist of any characters that are valid in a member name and two special pattern characters: the asterisk (*) and the percent symbol (%).

*

represents any number of characters. As many asterisks as required can appear anywhere in a member name pattern. For example, if you enter a member name pattern of `*d*`, all members in the PDS whose name contains "d" are processed.

%

is a place holding character that means a single character. As many percent symbols as necessary can appear anywhere in a member name pattern. For example, if you enter a member name pattern of `%%%%`, all members in the PDS whose name is four characters in length are processed.

member_in is ignored if the data set is not a PDS(E).

MEMSTART=*startstring*

Is used to specify the start of a range of member names to be included. If MEMSTART is specified but MEMEND is omitted, all members of the PDS(E) from the *startstring* value onwards are included. *startstring* can have the same values, including wild cards, as for the *member-in* parameter of the MEMBER keyword.

MEMEND=*endstring*

Is used to specify the end of a range of member names to be included. If MEMEND is specified but MEMSTART is omitted, all members of the PDS(E) up to the *endstring* value onwards are included. *endstring* can have the same values, including wild cards, as for the *member_in* parameter of the MEMBER keyword.

XMEMBERS

Provides a way to exclude from processing library members that would otherwise be selected using the MEMSTART, MEMEND, and MEMBER options.

xmem_filter

A member name filter identifying one or more members that are to be excluded from processing. A filter can be a member name pattern representing multiple members.

To specify a member name filter containing lowercase characters, use a character string in the format `c'string'`. Filter values can also be specified as hexadecimal strings in the format `x'hex-digits'`.

MEMLIST

Allows you to specify a list of member names with optional associated output view names. If you do not specify the associated view name, FM/IMS uses the input member name or the name as identified by the MEMOUT mask, *memmask*.

member_n

The name of the member to be processed. Generic name masks are allowed.

view_n

The name of the view after it has been copied to the output data set. If unspecified, the output view is not renamed.

OUTPUT=ddname

Identifies the DD statement for the data set in which you want the updated views stored. The data set you specify must be a PDS(E) or a sequential data set. This parameter does not support concatenated data sets. If the OUTPUT and DSNOUT parameters are not specified, the utility stores the updated views in the data sets specified in the INPUT or DSNIN parameter.

DSNOUT=dsname

Specifies the name of the data set in which you want the updated views stored. The data set you specify must be a PDS(E) or a sequential data set. If it is a PDS(E), you can further qualify this data set, as follows:

(*member-out*)

Where *member-out* is the member of the specified PDS(E) in which you want the updated view stored.

MEMOUT=memmask

When a number of input members have been specified, you can specify a member name pattern for the output views, allowing you to rename your views as they are created. The member name pattern can consist of any characters that are valid in a member name and two special pattern characters: the asterisk (*) and percent sign (%).

Asterisk (*)

The asterisk is a place-holding character that means multiple characters with no change. Only one asterisk should appear in the mask. Any subsequent asterisk characters are treated as percent signs. For example, if you enter:

```
ABC*
```

The renamed members all begin with ABC followed by the remainder of the old member name.

Percent sign (%)

The percent sign is a place-holding character that means a single character with no change. As many percent symbols as necessary may appear anywhere in a member name. For example, if you enter:

```
%%%A*
```

The 1st 3 characters of the renamed members remain unchanged, the 4th character is replaced with the letter "A" and the remainder of the old member name remains unchanged.

REPLACE

Specifies whether or not FM/IMS replaces like-named views in an output PDS(E).

NO

Like-named views in the output PDS(E) are not replaced.

YES

Like-named views in the output PDS(E) are replaced.

NOUPDATE

Specifies whether or not FM/IMS writes back updates to the data set.

NO

Updates are written back to the data set.

YES

Updates are not written back to the data set.

FORCE

Specifies whether or not FM/IMS updates the view when the template it was created from has not changed.

NO

If the template that the view was created from has not changed, the update will not take place.

YES

FM/IMS updates the view, even if no change has been made to the template it was created from.

TEMPLATE

When this parameter is specified, the utility restricts the views that are processed to those that are built from the templates that you specify in this parameter. You can specify a list that includes template member names and template member patterns. A view is only processed if it is built from a template member that is either specified in the list or matches a template member pattern specified in the list.

member_n

A template member name or member pattern.

TPLIST

When this parameter is specified, the templates in the specified data sets are used to update the views (rather than the template referenced in each view) and, if the update is successful, the utility changes the template data set name in the view to the name of the data set which contains the template that the utility used.

dsn_n

The name of a template data set that you want the utility to use. Generic name masks are not allowed.

Batch example

```
//FMBAT EXEC PGM=FMNIMS
//STEPLIB DD DSN=FMN.SFMNMOD1,DISP=SHR
//SYSPRINT DD SYSOUT=*
//IDIOPTS DD DSN=FMN.IDIOPTS,DISP=SHR
```

```
//FMNIMSIN DD *
$$FILEM IVU DSNIN=FMN.IMS.IVP.VIEW,
$$FILEM MEMBER=D*,
$$FILEM MEMLIST=(DJ2EVJU),
$$FILEM TPLIST=(FMN.IMS.IVP.TEMPLATE.MORE),
$$FILEM DSNOUT=FMN.IMS.IVP.VIEW.MORE,
$$FILEM REPLACE=YES
```

Update report

```
IBM File Manager for z/OS IMS Component

      Template Update Report

Template      New name   Type      Status
-----
DJ2EVJU              View      Updated

FMN1494I 1 members read 1 Updated 0 Not changed 0 Not replaced 0 Errors
```

Report fields

Template

This is the name of the view.

Lib

When there is more than one input library, this column shows the library number from which the view came.

This column will only be present if there is more than one view input library.

New name

This is the new output view name if the view was renamed during the update process.

Status

A value from the status table - see [Table 2: Batch update status and action on page 525](#).

Criteria set update (ICU)

The ICU (IMS Criteria set Update) function provides you with the ability to update criteria sets using a batch process.

Purpose

You can use this utility to:

- Update one or more criteria sets.
- Create criteria sets based upon existing existing criteria sets.

Usage notes

- You can filter the criteria sets selected for processing by providing the originating template member names or masks.

Related functions

ITU

IMS Template Update

IVU

IMS Views Update

Figure 139. Syntax

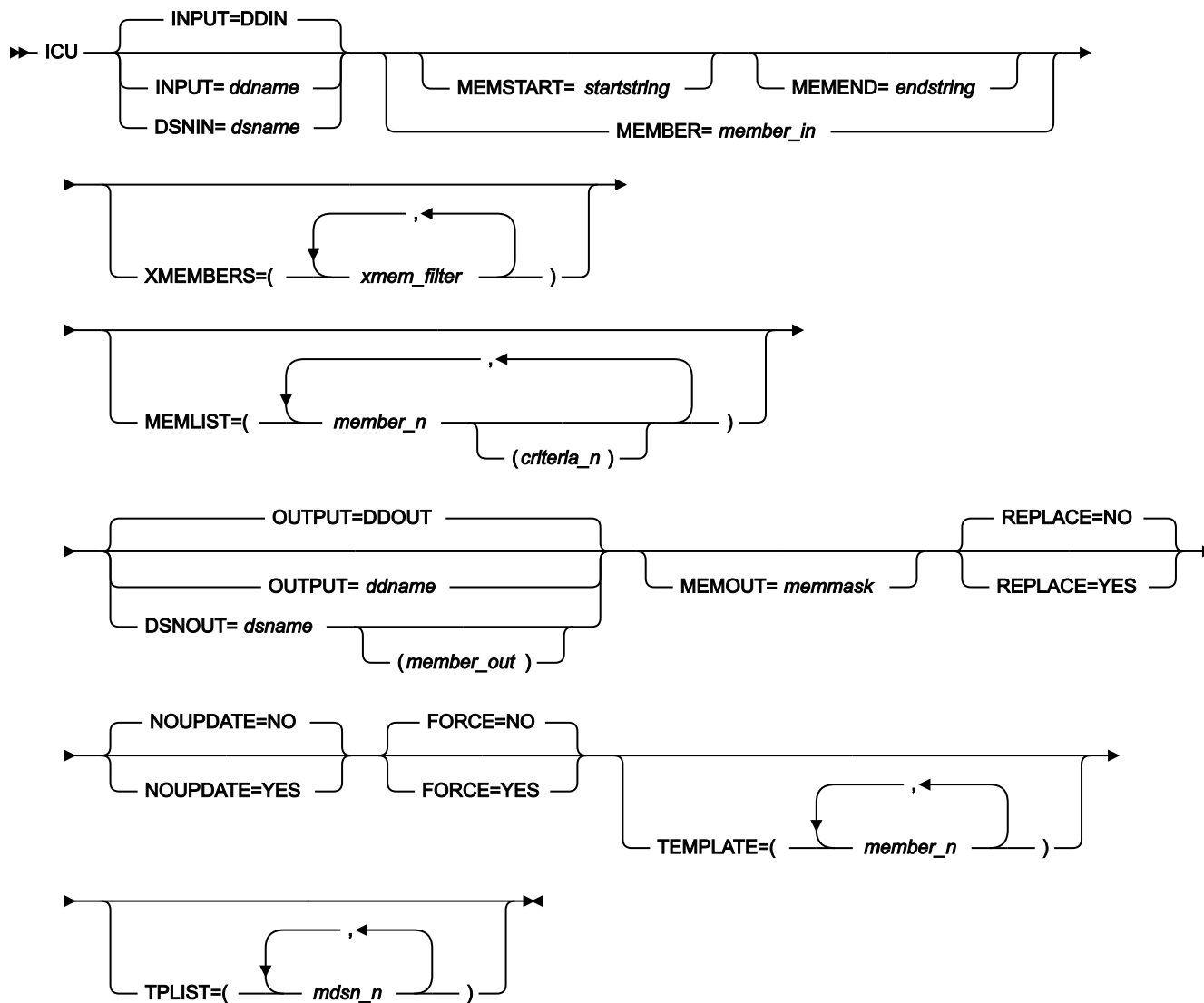

INPUT=ddname

Identifies the DD statement for the data set that contains the criteria sets you want the utility to process. You can specify a PDS(E), a concatenated PDS(E) or a sequential data set. The default DD name, DDIN, is used when you do not specify the INPUT or DSNIN parameters. If the OUTPUT and DSNOUT parameters are not

specified, the utility updates the selected members of the specified data set or the specified sequential data set.

DSNIN=*dsname*

The name of the data set that contains the criteria set or criteria sets that you want the utility to process.

MEMBER=*member_in*

When the input criteria data set is a PDS(E) or a concatenated PDS(E), specify the members of the data set that you want the utility to process. You can specify a member name (if there is only one member that you want the utility to process) or a member name pattern representing one or more members of the input criteria data set.

A member name pattern can consist of any characters that are valid in a member name and two special pattern characters: the asterisk (*) and the percent symbol (%).

*

represents any number of characters. As many asterisks as required can appear anywhere in a member name pattern. For example, if you enter a member name pattern of *d*, all members in the PDS whose name contains "d" are processed.

%

is a place holding character that means a single character. As many percent symbols as necessary can appear anywhere in a member name pattern. For example, if you enter a member name pattern of %%%%, all members in the PDS whose name is four characters in length are processed.

member_in is ignored if the data set is not a PDS(E).

MEMSTART=*startstring*

Is used to specify the start of a range of member names to be included. If MEMSTART is specified but MEMEND is omitted, all members of the PDS(E) from the *startstring* value onwards are included. *startstring* can have the same values, including wild cards, as for the *member-in* parameter of the MEMBER keyword.

MEMEND=*endstring*

Is used to specify the end of a range of member names to be included. If MEMEND is specified but MEMSTART is omitted, all members of the PDS(E) up to the *endstring* value onwards are included. *endstring* can have the same values, including wild cards, as for the *member_in* parameter of the MEMBER keyword.

XMEMBERS

Provides a way to exclude from processing library members that would otherwise be selected using the MEMSTART, MEMEND, and MEMBER options.

xmem_filter

A member name filter identifying one or more members that are to be excluded from processing.
A filter can be a member name pattern representing multiple members.

To specify a member name filter containing lowercase characters, use a character string in the format `c'string'`. Filter values can also be specified as hexadecimal strings in the format `x'hex-digits'`.

MEMLIST

Allows you to specify a list of member names with optional associated output criteria set names. If you do not specify the associated criteria set name, FM/IMS uses the input member name or the name as identified by the MEMOUT mask, *memmask*.

member_n

The name of the member to be processed. Generic name masks are allowed.

criteria_n

The name of the criteria set after it has been copied to the output data set. If unspecified, the output criteria set is not renamed.

OUTPUT=*ddname*

Identifies the DD statement for the data set in which you want the updated criteria sets stored. The data set you specify must be a PDS(E) or a sequential data set. This parameter does not support concatenated data sets. If the OUTPUT and DSNOUT parameters are not specified, the utility stores the updated criteria sets in the data sets specified in the INPUT or DSNIN parameter.

DSNOUT=*dsname*

Specifies the name of the data set in which you want the updated criteria sets stored. The data set you specify must be a PDS(E) or a sequential data set. If it is a PDS(E), you can further qualify this data set, as follows:

(member-out)

Where *member-out* is the member of the specified PDS(E) in which you want the updated criteria set stored.

MEMOUT=*memmask*

When a number of input members have been specified, you can specify a member name pattern for the output criteria sets, allowing you to rename your criteria sets as they are created. The member name pattern can consist of any characters that are valid in a member name and two special pattern characters: the asterisk (*) and percent sign (%).

Asterisk (*)

The asterisk is a place-holding character that means multiple characters with no change. Only one asterisk should appear in the mask. Any subsequent asterisk characters are treated as percent signs. For example, if you enter:

```
ABC*
```

The renamed members all begin with ABC followed by the remainder of the old member name.

Percent sign (%)

The percent sign is a place-holding character that means a single character with no change. As many percent symbols as necessary may appear anywhere in a member name. For example, if you enter:

```
%%%A*
```

The 1st 3 characters of the renamed members remain unchanged, the 4th character is replaced with the letter "A" and the remainder of the old member name remains unchanged.

REPLACE

Specifies whether or not FM/IMS replaces like-named criteria sets in an output PDS(E).

NO

Like-named criteria sets in the output PDS(E) are not replaced.

YES

Like-named criteria sets in the output PDS(E) are replaced.

NOUPDATE

Specifies whether or not FM/IMS writes back updates to the data set.

NO

Updates are written back to the data set.

YES

Updates are not written back to the data set.

FORCE

Specifies whether or not FM/IMS updates the criteria set when the template it was created from has not changed.

NO

If the template that the criteria set was created from has not changed, the update will not take place.

YES

FM/IMS updates the criteria set, even if no change has been made to the template that it was created from..

TEMPLATE

When this parameter is specified, the utility restricts the criteria sets that are processed to those that are built from the templates that you specify in this parameter. You can specify a list that includes template member names and template member patterns. A criteria set is only processed if it is built from a template member that is either specified in the list or matches a template member pattern specified in the list.

member_n

A template member name or member pattern.

TPLIST

When this parameter is specified, the templates in the specified data sets are used to update the criteria sets (rather than the template referenced in each criteria set) and, if the update is successful, the utility changes the template data set name in the criteria set to the name of the data set which contains the template that the utility used.

dsn_n

The name of a template data set that you want the utility to use. Generic name masks are not allowed.

Batch example

In this example, a criteria set is updated, removing a segment from the DBD.

```
//FMBAT EXEC PGM=FMNIMS
//STEPLIB DD DSN=FMN.SFMNMOD1,DISP=SHR
//SYSPRINT DD SYSOUT=*
//IDILOPTS DD DSN=FMN.IDILOPTS,DISP=SHR
//FMNIMSIN DD *
$$FILEM ICU DSNIN=FMN.IMS.IVP.CRITERIA,
$$FILEM MEMBER=DJ1E*,
$$FILEM MEMLIST=(DJ1ESS),
$$FILEM TPLIST=(FMN.IMS.IVP.TEMPLATE.LESS),
$$FILEM DSNOUT=FMN.IMS.IVP.CRITERIA.LESS,
$$FILEM REPLACE=YES
```

Update report

```
Update report

IBM File Manager for z/OS  IMS Component

      Template Update Report

Template      New name      Type      Status
-----
DJ1ESS              Criteria  Replaced

FMN1494I 1 members read 0 Updated 1 Not changed 1 Replaced 0 Errors
```

Report fields**Template**

This is the name of the criteria set.

Lib

When there is more than one input library, this column shows the library number from which the criteria set came. This column will only be present if there is more than one criteria set input library.

New name

This is the new output criteria set name if the criteria set was renamed during the update process.

Status

A value from the status table - see [Table 2: Batch update status and action on page 525](#).

Extract (IXB)**Purpose**

The Extract dialog generates JCL that runs the Extract (IXB) function. This function extracts all segments or selected segments from a database, and saves them to a sequential data set. You can edit the JCL and IXB input parameters before you submit the job, or you can create your own batch job to run the Extract function.

Usage notes

The Extract JCL generated by FM/IMS has the following flows:

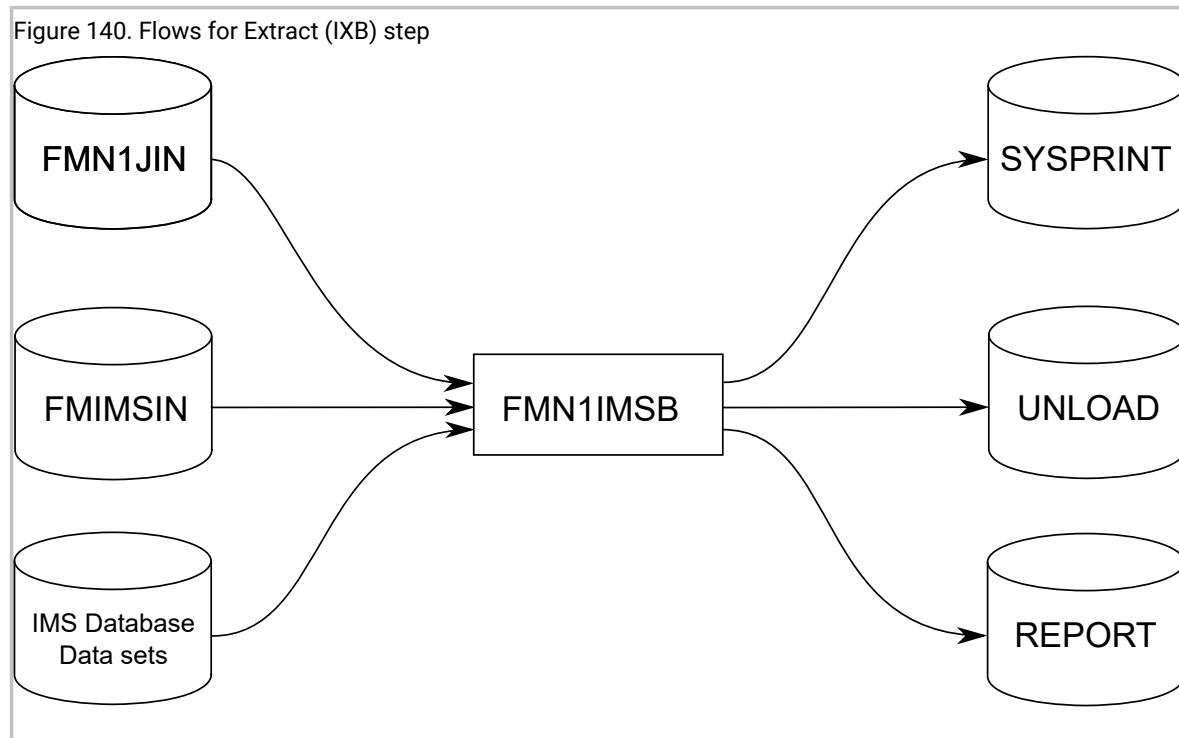
**FMN1JIN**

Points to the FM/IMS skeleton library. This DD statement is only used when you extract data from HALDB databases.

FMNIMSIN

Contains the control statements for the Extract. These control statements are discussed below.

REPORT

Defines the output data set for the Database Extract Summary report.

IMS database data sets

In DLI mode, FM/IMS includes DDs for each of the IMS database data sets associated with the IMS database being extracted. If the database has logical relationships, the data sets for the logically related databases also need to be included.

UNLOAD

Defines the output data set for the IMS segments that the function extracts. For the file layout, see [Extract data layout on page 564](#).

SYSPRINT

Defines the output data set for the messages that the Extract issues.

FMNIMSIN control statements

You use the FMNIMSIN control statements to specify:

- If the Extract is to run in a BMP or DLI region.
- Whether to use a static PSB, or if FM/IMS is to generate a dynamic PSB to extract the IMS data.
- Whether a Keys file is used to perform a partial Extract.
- Whether selection criteria have been specified to perform a partial Extract.

If the database contains logical relationships, the criteria can be used to determine the logical relationships that are to be chased.

Each line in FMNIMSIN starts with a \$\$FILEM and the first line contains the parameter IXB to specify that FM/IMS is performing an Extract.

```
$$FILEM IXB REGNTYPE=DLI,  
$$FILEM     PSBTYPE=DYNAMIC,  
$$FILEM     DBDDSN=FMN.IMS.IVP.DBDLIB,  
. . .  
. . .
```

Figure 141. Syntax

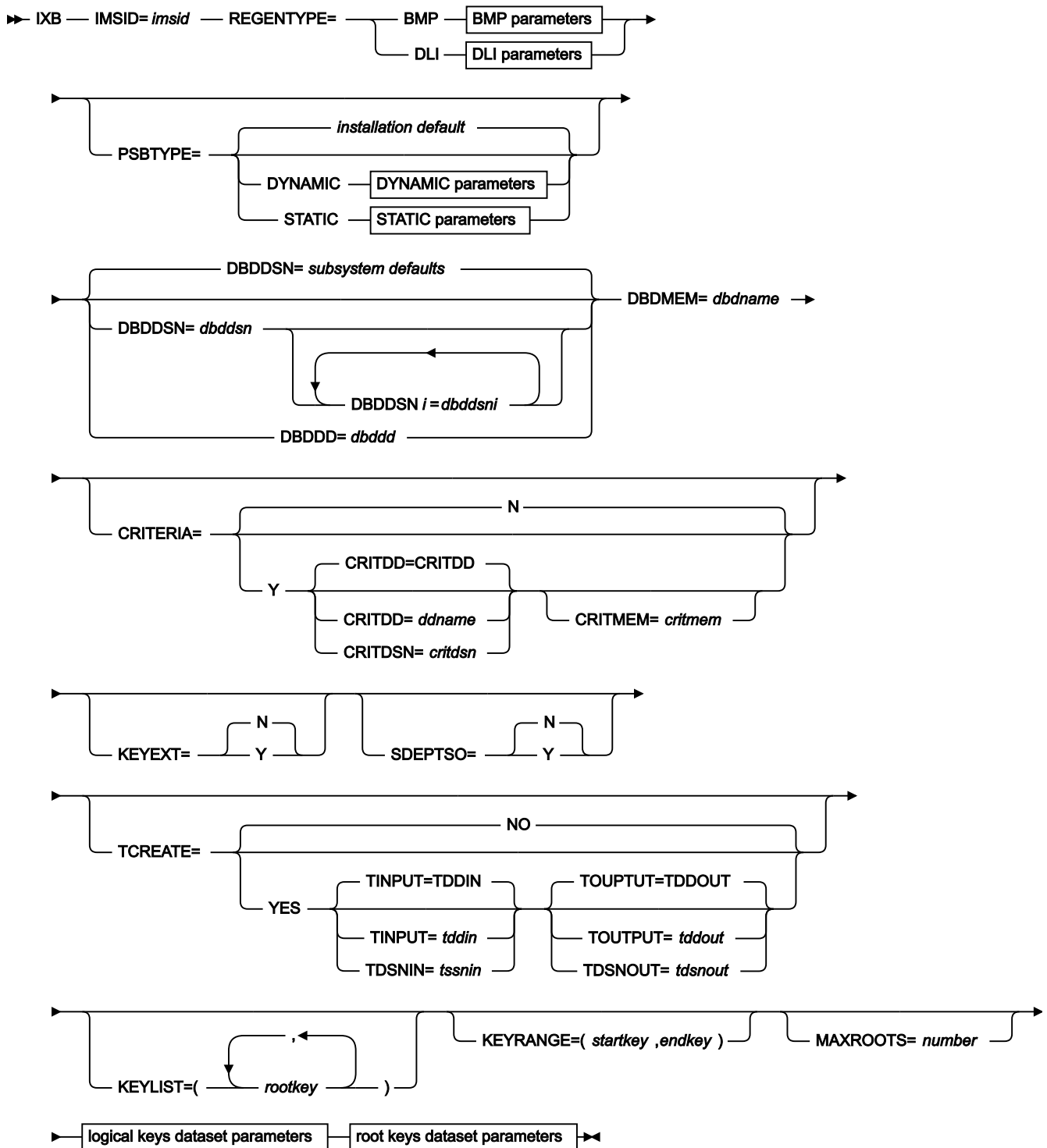

BMP parameters

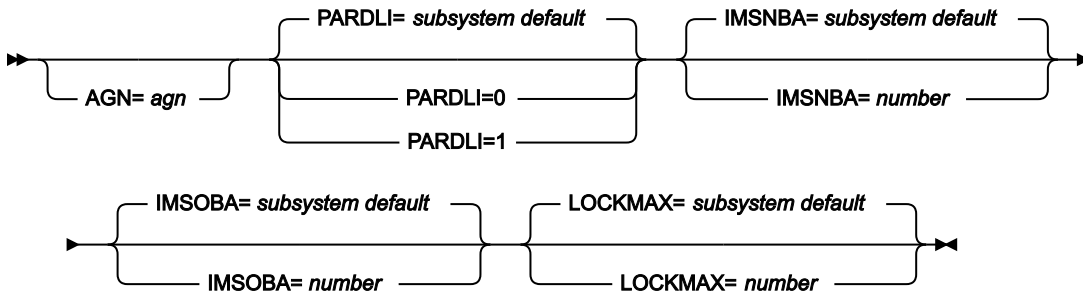

DLI parameters

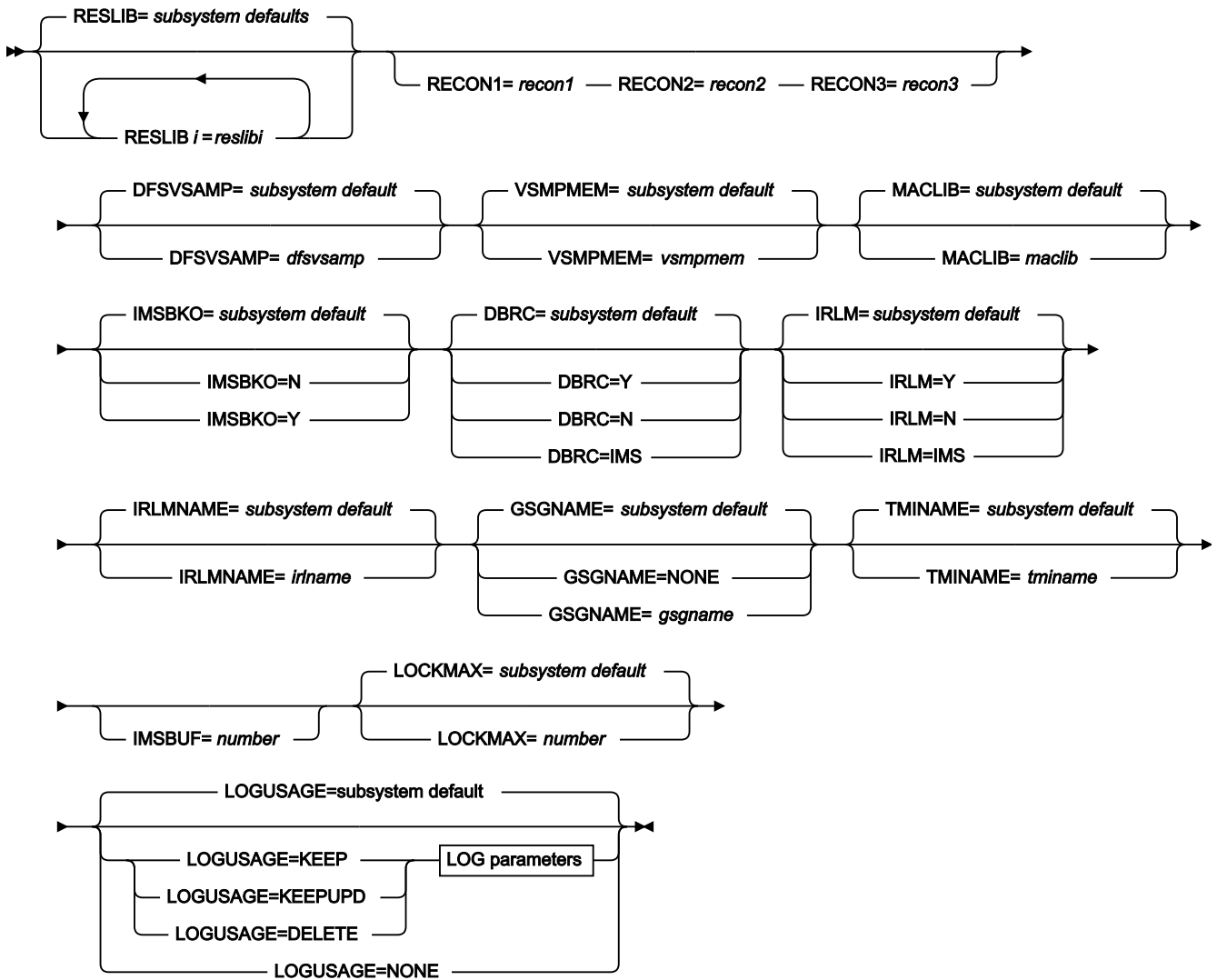

LOG parameters

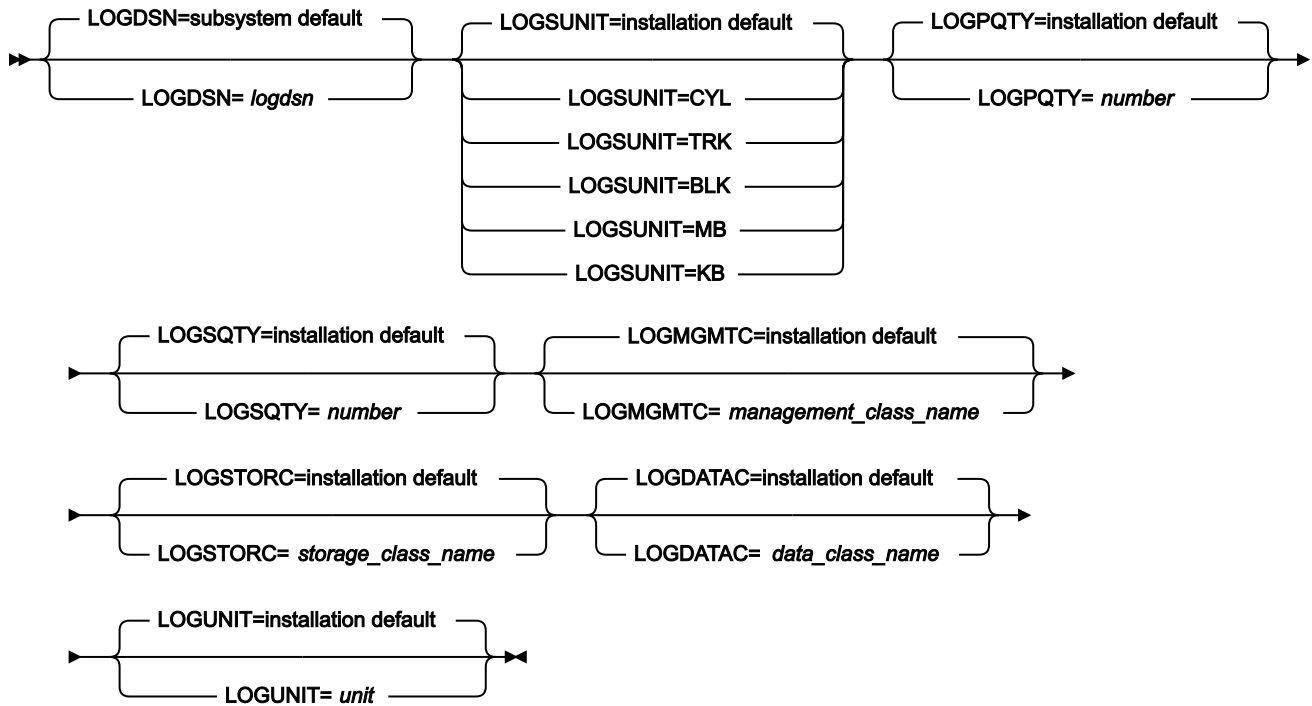

DYNAMIC parameters

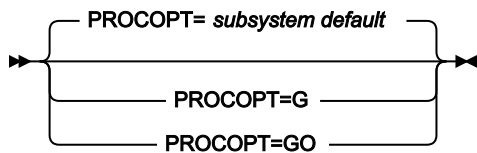

STATIC parameters

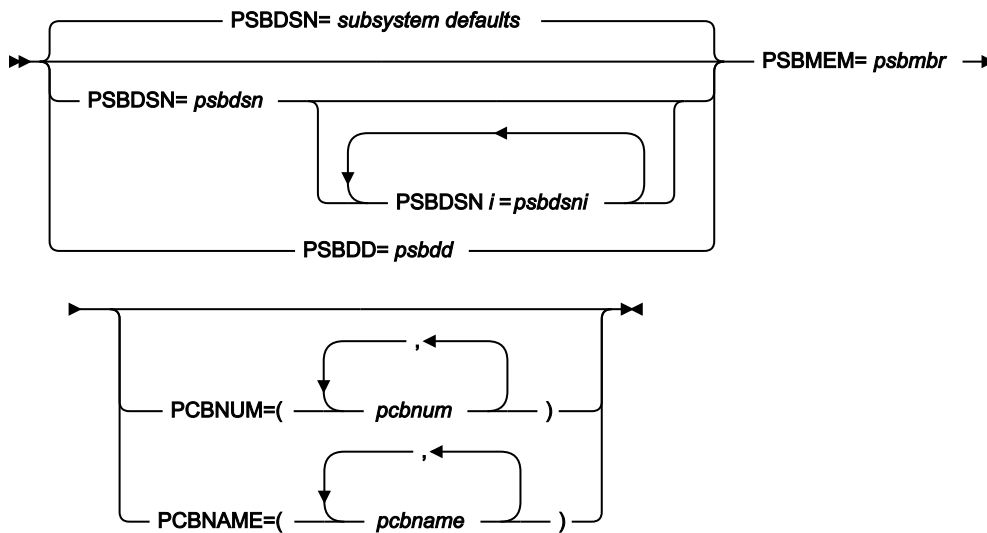

Logical keys dataset parameters

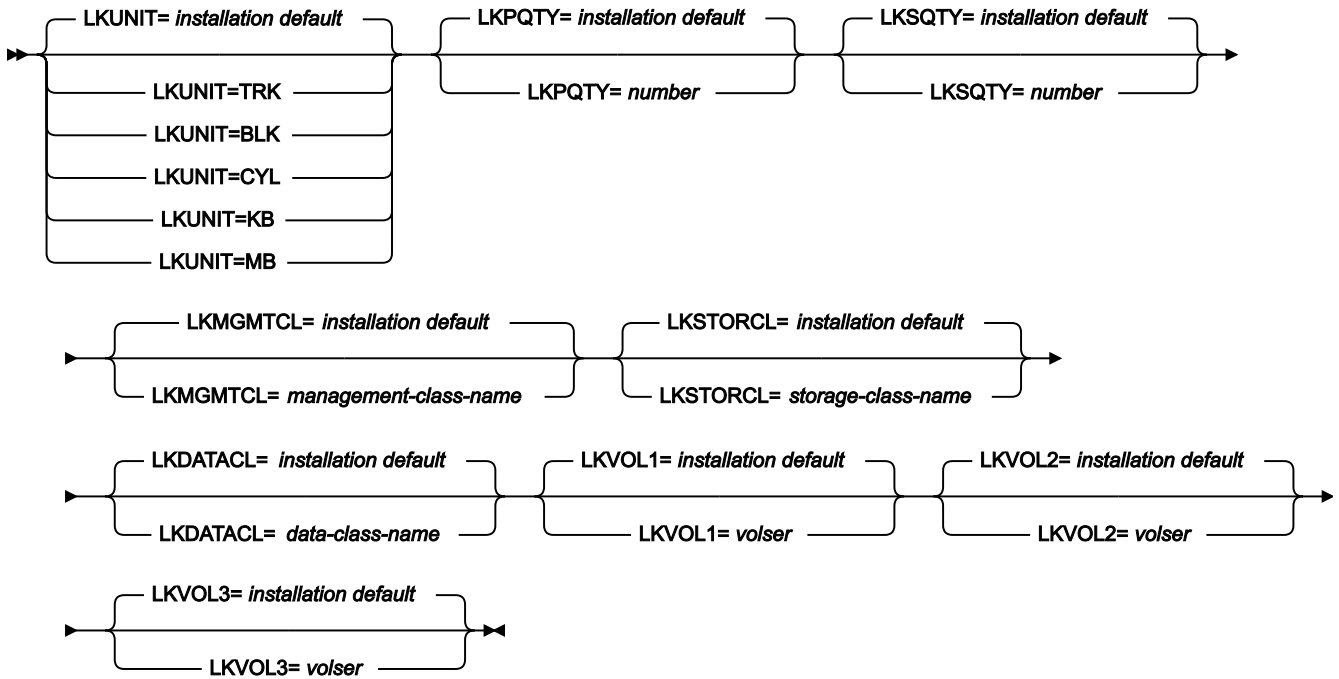

Root keys dataset parameters

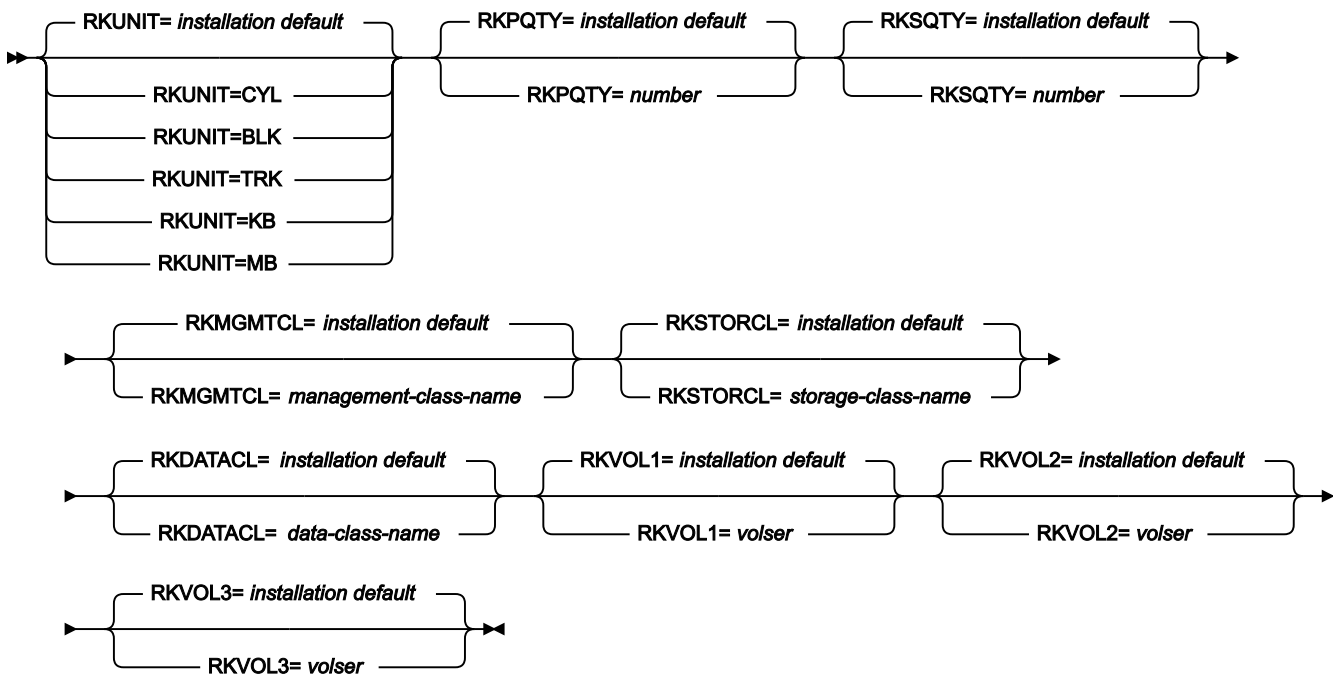

IMSid=imsid

The 4-character ID of the IMS subsystem in which the databases you want to access are defined.



Note: If REGNTYPE=DLI is specified and the FM/IMS installation options module specifies COMPAT=Y, then this is an optional parameter. Otherwise, it is a required parameter.

REGNTYPE

Required parameter. Specifies the type of region that you want the function to run in.

BMP

For a BMP region. You can use a BMP region when the database is online.

DLI

For a DL/I batch processing region. You can use a DL/I batch processing region when the database is offline, or there is data sharing support.

PSBTYPE

Optional parameter. Specifies the type of PSB that the function uses to access the databases.

If you do not specify this parameter, FM/IMS uses the *installation* default specified in the FM/IMS installation option module. The FM/IMS administrator specifies the installation defaults at installation time.

DYNAMIC

The function uses a temporary PSB that is generated when it is started and deleted when it finishes.

STATIC

The function uses an existing PSB generated by the database administrator. Details of which PSB to use must be specified in the STATIC parameters.

DBDDSN=*dbdsn* and DBDDSN*i*=*dbdsni* (*i*= 2 to 6)

The DBDDSN parameters are used when the IMSID parameter specifies a subsystem that does not use IMS-managed ACBs.

Optional parameters. The names of the load libraries that contain the database definitions (DBDs) that you want the function to use. The specified libraries are allocated to the IMS DD.

When PSBTYPE=DYNAMIC is specified, IMS requires these DBDs to be in at least one of the specified DBD libraries:

- The DBD for the database specified in the DBDMEM parameter.
- The DBD for each database that is logically related to the database specified in the DBDMEM parameter.

When PSBTYPE=STATIC is specified, IMS requires these DBDs to be in at least one of the specified DBD libraries:

- The DBD for each database that is specified in the PSB.
- The DBD for each database that is logically related to a database specified in the PSB.

The value of *i* must start at 2, and then increment by 1 up to a maximum value of 6. Thus

```
DBDDSN2=dbddsn2 DBDDSN3=dbddsn3 DBDDSN4=dbddsn4
```

is acceptable, but

```
DBDDSN2=dbddsn2 DBDDSN4=dbddsn4
```

is not, because the value "3" is missing.



Note: When the IMSID parameter specifies a subsystem that uses IMS-managed ACBs, the function gets the DBDs from the IMS catalog that the subsystem uses, and these parameters are ignored.

If you do not specify the DBDDSN parameter, FM/IMS uses

- The *subsystem* default for the parameter (if you have specified the IMSID parameter)
- The *installation* default for the parameter (if you have not specified the IMSID parameter).

The FM/IMS administrator specifies the subsystem and installation defaults at installation time.

DBDDD=dbddd

Use the **DBDDD** parameter when the IMSID parameter specifies a subsystem that does not use IMS-managed ACBs.

The **DBDDD** parameter provides an alternative way of specifying the DBD libraries that the function is to use.

Optional parameter. The name of the DD statement that allocates the DBD libraries that you want the function to use. Include this DD statement in the JCL that you submit. You can specify any valid ddname except for IMS which is reserved for use by FM/IMS.



Note: When the IMSID parameter specifies a subsystem that uses IMS-managed ACBs, the function gets the DBDs from the IMS catalog that the subsystem uses, and the **DBDDD** parameter is ignored.

DBDMEM=dbdname

Required parameter. The name of the primary database of the function.

CRITERIA

Optional parameter. Specifies whether or not the Extract uses selection criteria.

N

The Extract does not use selection criteria.

Y

The Extract uses selection criteria. If Y is specified, you must specify the criteria set that the extract is to use as outlined in the CRITDD, CRITDSN and CRITMEM entries below.

CRITDD=ddname

Identifies the DD statement for the sequential data set or PDS(E) and member that contains the criteria you want your Extract to use. The default is CRITDD.

CRITDSN=critdsn

The name of the data set that contains the criteria that you want your Extract to use. You may specify a sequential data set or a PDS(E). If you specify a PDS(E), the parameter may also include a member name in parentheses.

CRITMEM=critmem

Required when the CRITDSN or CRITDD parameter specifies a PDS(E) and does not specify the member. Specifies the member of the PDS(E) that contains the criteria you want your Extract to use.



Note: The parameters DSNCRIT and MEMCRIT will continue to be supported for backward compatibility.

KEYEXT

Optional parameter. Specifies whether or not the Extract is restricted to those records that are specified in a key values data set.

N

The Extract does not use a key values data set.

Y

The Extract uses a key values data set. The key values data set contains the key values of the root segments of the records that you want extracted.

You specify the key values data set in the KEYSFILE DD statement. You may specify a sequential data set or a PDS(E) member.

SDEPTSO

This option is only applicable for DEDBs with Sequential Dependent (SDEP) segments. Specifies whether or not FM/IMS is to write the SDEP timestamp to the unload file.

N

Default value. All of the sequential dependents of a root segment are physically loaded together in the reverse sequence they were read during the Extract process. This restores the SDEP segments so that, when reading them using DLI calls, the database looks the same. However

when the DEDB database is processed using the Sequential Dependent Scan Utility, the order of the segments could be different.

Y

FM/IMS is to write the SDEP timestamp to the unload file. When loading the DEDB database, the sequential dependent segments are restored in their original entry sequence order. This causes an increase in elapse time and I/O for the Extract job.

TCREATE

Specifies whether an extract template is created during the batch extract process.

N

Do not create a template during the batch extract process.

Y

Create a template during the batch extract process.

TINPUT=*tddin*

Identifies the DD statement for a PDS(E) or a concatenated PDS(E) that contains the template for the database specified in the DBDMEM parameter and templates for all the databases that are logically related to the database specified in the DBDMEM parameter.

TDSNIN=*tddsnin*

Specifies the name of the PDS(E) that contains the template for the database specified in the DBDMEM parameter and templates for all the databases that are logically related to the database specified in the DBDMEM parameter.

TOUTPUT=*tddout*

Identifies the DD statement for either the sequential data set or the PDS(E) member in which you want the Extract template stored.

TDSNOUT=*tdsnout*

Specifies the name of either the sequential data set or the PDS(E) member in which you want the Extract template stored.

KEYLIST(*rootkey1,rootkey2,...*)

Optional parameter. Specifies a list of the root segment key values of the database records that you want extracted. If the length of a root key value is less than the key length of the root segment, then the function considers it to be the first part of the key and extracts all those database records with root key values that match the partial key value.

KEYRANGE(*startkey,endkey*)

Optional parameter. Specifies the start and the end of a range of root key values. The function extracts those database records that have a root key value in the specified range.

startkey

The start of the range of the root key values. If the length of the *startkey* value is less than the key length of the root segment then the function appends low values (X'00') to the specified value.

endkey

The end of the range of the root key values. If the length of the *endkey* value is less than the key length of the root segment then the function appends high values (X'FF') to the specified value.

MAXROOTS=*number*

Optional parameter. Limits the number of database records that the function extracts. When this parameter is specified, the function counts the number of database records that it has extracted and terminates when it reaches the specified limit.

BMP parameters

The BMP parameters are used when the function is run in BMP mode (REGNTYPE=BMP).

Where indicated, if you omit a parameter, FM/IMS uses:

- The *subsystem* default for the parameter (if you have specified the IMSID parameter)
- The *installation* default for the parameter (if you have not specified the IMSID parameter)

The FM/IMS administrator specifies the subsystem and installation defaults at installation time.

AGN=*agn*

If the subsystem specified in the IMSID parameter uses AGNs, then this is a required parameter. Otherwise, this parameter should not be specified. Specify an AGN that provides you with the access your function requires and that you have authority to use. (The BMP region that FM/IMS starts is only authorized to use the IMS resources that are associated with the specified AGN.)

PARDLI

Optional parameter. Specifies the parallel DL/I option that the function is to use.

0

DL/I processing is performed in the BMP region.

1

All DL/I processing for the BMP is performed in the IMS control region.

PARDLI=1 prevents control region system 113 abends resulting from system X22 abends in the BMP region. However, if PARDLI=1, then parallel DL/I is disabled. This can degrade performance.

IMSNBA=*number*

Optional parameter. Specifies the number of Fast Path database buffers to be made available in the Common Service Area when a Fast Path region is activated. The number specified is used by

the function when it accesses Fast Path databases. The number you specify must be in the range 1 to 9999.

IMSOBA=number

Optional parameter. Specifies the number of additional page-fixed buffers to be made available to a Fast Path region if the normal allotment (specified in the IMSNBA parameter) is used. The number specified is used by the function when it accesses Fast Path databases. The number you specify must be in the range 1 to 9999.

LOCKMAX=number

Optional parameter. Specifies the maximum number of locks (in units of 1000) that the function is allowed to hold at one time. The number you specify must be in the range 0 to 32767. If 0 is specified, there will be no limit on the number of locks the function can hold at one time.

DLI parameters

The DLI parameters are used when the function is run in DLI mode (REGNTYPE=DLI).

Where indicated, if you omit a parameter, FM/IMS uses:

- The *subsystem* default for the parameter (if you have specified the IMSID parameter)
- The *installation* default for the parameter (if you have not specified the IMSID parameter)

The FM/IMS administrator specifies the subsystem and installation defaults at installation time.

RESLIB_{*i*}=reslib_{*i*} (*i*=1 to 6)

Specifies the names of the data sets containing the IMS SVC modules, the DFSMDA dynamic allocation modules and the IMS exit routines. The specified data sets are allocated to the TASKLIB DD and those data sets that are APF-authorized are allocated to the DFSRESLB DD. Optional parameter.

The value of *i* must start at 1, and then increment by 1 up to a maximum value of 6. Thus

```
RESLIB1=reslib1 RESLIB2=reslib2 RESLIB3=reslib3
```

is acceptable, but

```
RESLIB1=reslib1 RESLIB3=reslib3
```

is not, because the value "2" is missing.

RECON1=recon1

Optional parameter. If you want IMS to dynamically allocate the DBRC RECON data sets, do not specify this parameter. IMS allocates the RECON data sets specified in the DFSMDA dynamic allocation modules when they are required. If you want FM/IMS to allocate the DBRC RECON data sets, specify the name of the primary DBRC RECON data set that you want IMS to use. FM/IMS

allocates the specified data set to the RECON1 DD when it is required. If you specify the RECON1 parameter, you must also specify the RECON2 and RECON3 parameters.

RECON2=recon2

Optional parameter. If you want IMS to dynamically allocate the DBRC RECON data sets, do not specify this parameter. IMS allocates the RECON data sets specified in the DFSMDA dynamic allocation modules when they are required. If you want FM/IMS to allocate the DBRC RECON data sets, specify the name of the secondary DBRC RECON data set that you want IMS to use. FM/IMS allocates the specified data set to the RECON2 DD when it is required. If you specify the RECON2 parameter, you must also specify the RECON1 and RECON3 parameters.

RECON3=recon3

Optional parameter. If you want IMS to dynamically allocate the DBRC RECON data sets, do not specify this parameter. IMS allocates the RECON data sets specified in the DFSMDA dynamic allocation modules when they are required. If you want FM/IMS to allocate the DBRC RECON data sets, specify the name of the spare DBRC RECON data set that you want IMS to use. FM/IMS allocates the specified data set to the RECON3 DD when it is required. If you specify the RECON3 parameter, you must also specify the RECON1 and RECON2 parameters.

DFSVSAMP=*dfsvsamp*

Optional parameter. Specifies the name of the data set containing the parameters that define the IMS buffer subpools for OSAM and VSAM data sets. The specified data set is allocated to the DFSVSAMP DD. If the specified data set is partitioned, specify the required member in the VSMPMEM parameter.

VSMPMEM=*vsmpmem*

Optional parameter. When the DFSVSAMP data set that the function is to use is a PDS(E), VSMPMEM specifies the member of that data set containing the parameters that define the IMS buffer subpools for OSAM and VSAM data sets. The specified member is allocated to the DFSVSAMP DD. If the DFSVSAMP data set is sequential, do not specify this parameter.

MACLIB=*maclib*

Optional parameter. Specifies the name of the IMS macro library. FM/IMS uses the IMS macros in the specified library when generating a dynamic PSB.

IMSBKO

Optional parameter. Specifies whether or not a dynamic backout is to be performed when an IMS pseudoabend occurs.

N

A dynamic backout is not performed when an IMS pseudoabend occurs.

Y

A dynamic backout is performed when an IMS pseudoabend occurs.

This parameter only takes effect when the function is running with an IMS log data set.

DBRC

Optional parameter. Specifies whether or not the function is to use Database Recovery Control (DBRC):

Y

Use DBRC.

N

Do not use DBRC.

IMS

DBRC is set according to the DBRC parameter in the installation default module DFSIDEF0. The function uses DBRC if the DFSIDEF0 module specifies DBRC=YES or DBRC=FORCE or if the DFSIDEF0 module is not found in the RESLIB data sets for the subsystem. The function does not use DBRC if the DFSIDEF0 module specifies DBRC=NO.

IRLM

Optional parameter. Specifies whether or not the function uses an Internal Resource Lock Manager (IRLM).

Y

Use IRLM.

N

Do not use IRLM.

IMS

IRLM is set according to the IRLM and IRLMNM parameters in the IMSCTRL macro statement. The function uses IRLM, if one of these conditions is true:

- The IMSCTRL macro statement specifies IRLM=Y.
- The IMSCTRL macro statement specifies an IRLMNM and does not specify IRLM=N.

The function does not use IRLM if one of these conditions is true:

- The IMSCTRL macro statement specifies IRLM=N.
- The IMSCTRL macro statement does not specify a value for IRLM and IRLMNM.

IRLMNAME=*irlm_name*

Optional parameter. Specifies the 4-byte z/OS subsystem name assigned to the Internal Resource Lock Manager (IRLM). The function passes the name to the IMS region controller when IRLM=Y or IRLM=IMS is specified.

RSR

No longer used by FM/IMS but is retained for compatibility. FM/IMS accepts RSR=Y or RSR=N.

GSGNAME

If the IMS subsystem `imsid` is part of a Remote Site Recovery (RSR) complex and the `GSGNAME` has not been specified in the `IMSCTRL` macro statement or the FM/IMS installation options module, and you want any activity performed by the function to be tracked by RSR, specify the Global Service Group (GSG) name for the RSR complex.

If the IMS subsystem is part of an RSR complex and the `GSGNAME` has been specified in the `IMSCTRL` macro statement or the FM/IMS installation options module and you do not want the activity of the function to be tracked, specify `NONE`.

Otherwise, do not specify this parameter.

TMINAME=*tminame*

Optional parameter. If the IMS subsystem is part of a Remote Site Recovery (RSR) complex and you want the activity performed by the function tracked by RSR, specify the Transport Manager Instance (TMI) name that the function is to use.

IMSBUF=*number*

Optional parameter. Specifies the number of 1K blocks to be used in calculating the size of the OSAM pool. The value specified in this field is only used if the `DFSVSAMP` data set does not include any IOBF control statements.

LOCKMAX=*number*

Optional parameter. Specifies the maximum number of locks (in units of 1000) that the function is allowed to hold at one time. The number you specify must be in the range 0 to 32767. If 0 is specified, there will be no limit on the number of locks the function can hold at one time.

LOGUSAGE

Optional parameter. If the function is to use a PSB that has update intent, use this parameter to specify whether or not the function is to use an IMS log and, if it is to use an IMS log, whether or not to keep the log when the function ends.

KEEP

Use an IMS log. Keep the log when the function ends.

KEEPUPD

Use an IMS log. Keep the log if the function updates databases or does not end normally.

DELETE

Use an IMS log. Only keep the log if the function does not end normally.

NONE

Do not use an IMS log.

LOG parameters

The LOG parameters are used when all of these conditions are true:

- The function is to use a PSB that has update intent.
- The LOGUSAGE parameter is set to KEEP, KEEPUPD or DELETE.
- The parameter has not been fixed by the FM/IMS administrator.
- The job step does not include an IEFORDER DD or the FM/IMS administrator has set UIEFORDER to N.

When you omit a parameter FM/IMS uses the installation default specified in the FM/IMS installation option module (except for the LOGDSN parameter).

LOGDSN

Optional parameter. Specifies the name pattern that the function uses to generate the name of the IMS log data set that it dynamically allocates.

If you do not specify this parameter, FM/IMS uses the *subsystem* default for the parameter (if you have specified the IMSID parameter), or the *installation* default for the parameter (if you have not specified the IMSID parameter). The FM/IMS administrator specifies the subsystem and installation defaults at installation time.

The name pattern can consist of up to five qualifiers. For each qualifier, you can specify either the required character string or a symbol. The data set name is generated by replacing the symbols in the name pattern with their run-time values.

The parameter supports these symbols:

&DBNAME.

The name of the primary database that the function accesses.

&PREFIX.

The value specified in the TSOPREFIX parameter (if specified) or null (otherwise).

&FUNCOD.

The code for the function. The following are the codes for the functions that support this parameter:

DIB

Initialize

IXB

Extract

ILB

Load

IPR

Print

IEB

Batch Edit

IBB

Batch Browse

&HHMMSS.

Thhmmss where hhmmss is the time of day that the IMS log is created expressed in hours (HH), minutes (MM) and seconds (SS).

&SSID.

The name of the IMS subsystem that the function is to access.

&UID.

Either &PREFIX. (if its value is not null) or the User ID (otherwise).

&USER.

User ID

&YYMMDD.

Dyymmdd where yymmdd is the date that the IMS log is created expressed as a 2-digit year (YY), month (MM) and day (DD).

LOGSUNIT

The unit of the primary (LOGPQTY) and secondary (LOGSQTY) space allocation:

CYL

Specifies that the space be allocated in cylinders.

TRK

Specifies that the space be allocated in tracks.

BLK

Specifies that the space be allocated in blocks.

MB

Specifies that the space be allocated in megabytes.

KB

Specifies that the space be allocated in kilobytes.

LOGPQTY

The primary space allocation for the IMS log data set.

LOGSQTY

The secondary space allocation for the IMS log data set.

LOGMGMTC

The management class for the IMS log data set.

LOGSTORC

The storage class for the IMS log data set.

LOGDATAAC

The data class for the IMS log data set.

LOGUNIT

The device type of the volume on which the IMS log data set is to reside.

DYNAMIC parameters

The DYNAMIC parameters are used when the function uses a dynamic PSB (PSBTYPE=DYNAMIC).

PROCOPT

Optional parameter. Specifies the PSB processing option (PROCOPT) that the dynamic PSB uses to read the database.

G

The function reads with integrity.

GO

The function reads without integrity.

If you omit this parameter, FM/IMS uses:

- The *subsystem* default for the parameter (if you have specified the IMSID parameter)
- The *installation* default for the parameter (if you have not specified the IMSID parameter)

The FM/IMS administrator specifies the subsystem and installation defaults at installation time.

STATIC parameters

The STATIC parameters are used when the function uses a static PSB (PSBTYPE=STATIC).

PSBDSN=*psbdsn* and PSBDSN*i*=*psbdsni* (i = 2 to 6)

The PSBDSN parameters are used when the IMSID parameter specifies a subsystem that does not use IMS-managed ACBs.

Optional parameters. The names of the load libraries that contain the Program Specification Block (PSB) that you want the function to use. The specified libraries are allocated to the IMS DD.

If you specify the PSBDSN parameter but not the PSBDSN*n* parameters, the PSBDSN parameter may also include the member name in parentheses.

The value of *i* must start at 2, and then increment by 1 up to a maximum value of 6. Thus

```
PSBDSN2=psbdsn2 PSBDSN3=psbdsn3 PSBDSN4=psbdsn4
```

is acceptable, but

```
PSBDSN2=psbdsn2 PSBDSN4=psbdsn4
```

is not, because the value “3” is missing.



Note: When the IMSID parameter specifies a subsystem that uses IMS-managed ACBs, the function gets the PSBs from the IMS catalog that the subsystem uses, and these parameters are ignored.

If you omit this parameter, FM/IMS uses:

- The *subsystem* default for the parameter (if you have specified the IMSID parameter)
- The *installation* default for the parameter (if you have not specified the IMSID parameter)

The FM/IMS administrator specifies the subsystem and installation defaults at installation time.

PSBDDD=*psbdd*

Use the **PSBDD** parameter when the IMSID parameter specifies a subsystem that does not use IMS-managed ACBs.

The **PSBDD** parameter provides an alternative way of specifying the PSB libraries that the function is to use.

Optional parameter. The name of the DD statement that allocates the PSB libraries that you want the function to use. Include this DD statement in the JCL that you submit. You can specify any valid ddname.



Note: When the IMSID parameter specifies a subsystem that uses IMS-managed ACBs, the function gets the PSBs from the IMS catalog that the subsystem uses, and the **PSBDD** parameter is ignored.

PSBMEM=*psbmb*

Required when a member name has not been specified in the PSBDSN parameter. The name of the PSB that you want the function to use.

The PSB that you specify must have a PCB for the database specified in the DBDMEM parameter.

**Note:**

1. When the PSB is used for an Extract and you want the Extract to chase logical relationships, the PSB must also have a PCB for each database that is logically related to the database specified in the DBDMEM parameter.
2. When the PSB is used for a Load, the PSB must have a PCB for all the databases you want to load.

PCBNUM=*pcbnum*

When the specified PSB has multiple PCBs for the database specified in the DBDMEM parameter, you specify in this parameter which PCB you want the function to use. You do this by specifying the ordinal number that indicates the position of the PCB in the PSB. So, if you want the function to use the first database PCB in the PSB, you specify 1. If you want the function to use the second database PCB in the PSB, you specify 2, and so on.



Note: If the PSB is for an Extract or a Load and there are multiple PCBs for one or more of the databases that are logically related to the database specified in the DBDMEM parameter, you must also specify the PCBs you want the function to use when accessing these logically related databases.

PCBNAME=*pcbname*

This parameter provides you with an alternative way of specifying the PCBs that you want the function to use. In this parameter, you specify the name of the PCB that you want the function to use.

Logical keys data set parameters

The logical keys data set is a VSAM work data set for the keys of the logically related segments that are to be processed by the Extract. These optional parameters allow you to specify allocation parameters for this data set.

When you omit a parameter FM/IMS uses the installation default specified in the FM/IMS installation option module (except for the LOGDSN parameter).

LKUNIT

Defines the unit of the primary and secondary space allocation:

TRK

Specifies that the space be allocated in tracks.

BLK

Specifies that the space be allocated in blocks.

CYL

Specifies that the space be allocated in cylinders.

KB

Specifies that the space be allocated in kilobytes.

MB

Specifies that the space be allocated in megabytes.

LKPQTY

Specifies the primary space allocation for the data set.

LKSQTY

Specifies the secondary space allocation for the data set.

LKMGMTCL

Specifies a management class for the data set. Do not specify this parameter on a system without SMS.

LKSTORCL

Specifies a storage class for the data set. Do not specify this parameter on a system without SMS.

LKDATACL

Specifies a data class for the data set. Do not specify this parameter on a system without SMS.

LKVOL n

(Where n is a number in the range 1 to 3.) Specifies the serial number of the volume that the data set is to be placed on. Use on systems without SMS.

Root keys data set parameters

The root keys data set is a VSAM work data set for the root keys of the primary and logically related databases that have been processed by the Extract. These optional parameters allow you to specify allocation parameters for this data set.

When you omit a parameter FM/IMS uses the installation default specified in the FM/IMS installation option module (except for the LOGDSN parameter).

RKUNIT

Defines the unit of the primary and secondary space allocation:

TRK

Specifies that the space be allocated in tracks.

BLK

Specifies that the space be allocated in blocks.

CYL

Specifies that the space be allocated in cylinders.

KB

Specifies that the space be allocated in kilobytes.

MB

Specifies that the space be allocated in megabytes.

RKPQTY

Specifies the primary space allocation for the data set.

RKSQTY

Specifies the secondary space allocation for the data set.

RKMGMTCL

Specifies a management class for the data set. Do not specify this parameter on a system without SMS.

RKSTORCL

Specifies a storage class for the data set. Do not specify this parameter on a system without SMS.

RKDATACL

Specifies a data class for the data set. Do not specify this parameter on a system without SMS.

RKVOL n

(Where n is a number in the range 1 to 3.) Specifies the serial number of the volume that the data set is to be placed on. Use on systems without SMS.

Database Extract Summary report

Figure 142. Database Extract Summary

IBM File Manager for z/OS IMS Component		Page 1
Database Extract Summary		Date: 2013-05-27
		Time: 15.36.25
Extract from		
IMS subsystem:	IFA2	
Primary database:	DJ2E	
Extract to data set:	FMN.IMS.EXTRACT.DJ2E	
Processing Options		
PSB type:	Static	
Region type:	DLI	
Use criteria:	Y	
Use key values:	Y	
Criteria set:	FMN.IMS.CRITERIA(DJ2E#CRT)	
Key values data set:	FMN.XKEY.DJ2E	
Key Value Counts		
Number read:	6	
Number not found:	0	
PSB name:	PUPA	
PSB library:	FMN.IMS.IVP.PSBLIB	
DBD		
Data set name 1:	FMN.IMS.IVP.DBDLIB	
Data set name 2:	IMSV1210.FMI.DBDLIB	
Databases Data Sets		
DBD name	DD name	Data set name

DJ2E	DJ2E	FMN.IMS.IVP.DB.DJ2E
DJ2F	DJ2F	FMN.IMS.IVP.DB.DJ2F
DJ3E	DJ3E	FMN.IMS.IVP.DB.DJ3E
DJ3F	DJ3F	FMN.IMS.IVP.DB.DJ3F
DJ1E	DJ1E	FMN.IMS.IVP.DB.DJ1E
DJ1F	DJ1F	FMN.IMS.IVP.DB.DJ1F

IMS Subsystem

The name of the IMS subsystem that the databases are defined in.

Primary Database

The name of the primary database of the Extract.

Extract to data set

The name of the data set in which the extracted data is stored.

PSB type

The type of PSB that the Extract used to access the databases:

Dynamic

The Extract used a temporary PSB that it generated at the start of the batch job.

Static

The Extract used an existing PSB.

Region type

The type of region that the Extract ran in.

DLI

The Extract ran in a DL/I batch processing region.

BMP

The Extract ran in a BMP region.

Use criteria

Whether or not the Extract used a criteria set.

Use key values

Whether or not the Extract was limited to specified root key values or a root key range.

SDEP timestamp order

When the primary database has a sequentially dependent (SDEP) segment, whether or not the timestamp for the SDEP segments is included in their extract records.

Criteria set

The name of the data set that contains the criteria set that the Extract used.

Key values data set

The name of the data set that contains the key values of the root segments of the records that were extracted.

Key value counts

Number read

The number of keys specified in the Key values data set and/or the KEYLIST parameter.

Number not found

The number of specified keys for which the root segment wasn't found. The SYSPRINT output lists the key values that were not found.

PSB name

(When the PSB type is Static) The name of the PSB that the Extract used.

PSB library

(When the PSB type is Static) The name of the library containing the PSB that the Extract used.

DBD Data set names

The names of the DBD libraries used by the Extract.

Database Data Sets

(When the Region type is DLI) the database data sets that the Extract used.

DBD name

This column contains the name of the primary database and the names of the databases that are logically related to the primary database.

DD name

The DD names for each database specified in the DBD name column.

Data set name

The data set that was allocated to the specified DD name.

Database Extract Statistics report

Figure 143. Database Extract Statistics

Database Extract Statistics Report								
Database	Segment	Level	-Segm Length-		--Number of Segments Extracted--		Total	Logically Related DB
			Min	Max	Phase 1	Phase 2		
DJ2E	SUBURB	01	62	62	6	77	83	
	LINKSTR	02	28	28	509	3517	4026	DJ3E
	NSTREET	02	30	30	3	28	31	
	INSHIRE	02	20	20	6	77	83	DJ1E
	LETRBOX	02	34	34	2	28	30	
Subtotal	DJ2E				526	3727	4253	
DJ3E	STREET	01	32	32	0	3048	3048	
	INSUB	02	18	18	0	4026	4026	DJ2E
Subtotal	DJ3E				0	7074	7074	
DJ1E	SHIRE	01	53	53	0	10	10	
	SHIRENP	02	11	11	0	10	10	
	LINKSUB	02	18	18	0	85	85	DJ2E
Subtotal	DJ1E				0	105	105	
Grand total					526	10906	11432	

Phase 1 = Extract using keys Phase 2 = Resolution of logical relationships
 *** End of IMS Extract Report ***

The following is a description of each column in this report.

Database

This column contains the name of the primary database and the names of the databases that are logically related to the primary database.

Segment

This column contains the names of the segments in the primary and logically related databases.

Level

The level of the segment.

Segm Length**Min**

The minimum length of the segment as defined in the DBD.

Max

The maximum length of the segment as defined in the DBD.

For fixed-length segments, the minimum length and maximum length will be the same.

Number of Segments Extracted

Phase 1

The number of segment occurrences extracted during phase 1 of the Extract. Phase 1 is that part of the extract that precedes the resolution (or chasing) of logical relationships.

Phase 2

The number of segment occurrences extracted when resolving (or chasing) logical relationships.

Total

The total number of segments occurrences extracted.

Logically Related DB

The database in which this segment's logical parent resides.

The following is a description of the rows in this report.

Subtotal

These rows contain totals for each database:

Phase 1

The total number of segment occurrences extracted from the database during phase 1.

Phase 2

The total number of segment occurrences extracted from the database during phase 2.

Total

The total number of segment occurrences extracted from the database.

Grand total

This row contains the totals for the listed databases:

Phase 1

The total number of segment occurrences extracted from the listed databases during phase 1.

Phase 2

The total number of segment occurrences extracted from the listed databases during phase 2.

Total

The total number of segment occurrences extracted from the listed databases.

Extract data layout

The data extracted from IMS is written to a flat file, with the following layout characteristics:

Header record

The header stores information required by FM/IMS when reloading the data. It comes in two formats: a Dynamic PSB header record; and a Static PSB header record:

Dynamic PSB header record

This record is the first line in the extract file, and has the following format:

Table 3. Dynamic PSB header record structure

Columns	Field	Description
1-8	Sort field	All columns set to low values (x'00'), so that when the file is sorted, the header record remains the first record
9-15	Product code	Set to "FM/IMS"
16-25	Version number	Set to current FM/IMS version
26	Reserved	
27-28	Extract record prefix length	This is calculated in the extract record format as $x=33+\max_ckeylen-1$
29-30	Maximum concatenated key length	
31-46	Date/time	Date and time that the extract file was created
47	EOR	End of record - reserved

Static PSB header record(s)

When using a Static PSB in the extract process, the header records created may span several lines. They are distinguished from the segment records by having 0 in the logical order number field (column 1-2). The first header record has the format:

Table 4. Static PSB first header record structure

Columns	Field	Description
1-9	Sort field	All columns set to low values (x'00'), so that when the file is sorted, the header record remains the first record (this is one byte longer than the sort field in the Dynamic header record)
10-16	Product code	Set to "FM/IMS"

Table 4. Static PSB first header record structure (continued)

Columns	Field	Description
17-26	Version number	Set to current FM/IMS version
27	Reserved	
28-29	Extract record prefix length	This is calculated in the extract record format as $x=34+\text{max_ckeylen}-1$
30-31	Maximum concatenated key length	
32-47	Date/time	Date and time that the extract file was created
48-59	PSB Type	Set to "STATIC PSB"
60-73	Index	If the PSB did not use a secondary index, this field is blank. Otherwise, it is the word "INDEX", followed by the DBD name of the index.
74	EOR	End of record - reserved

After the first header record, a Static PSB extract has additional header records to store information about the PSB used during the extract. Each record includes the list of SENSEGs for each of the databases included in the extract. These records have the format:

Table 5. Static PSB subsequent header record structure

Columns	Field	Description
1-2	Sort field	All columns set to low values (x'00'), so that when the file is sorted, the header record remains the first record
3-4	Header sequence number	To order the additional header records during sort
5-8	Reserved	Set to low values (x'00')
9-16	Header DBD name	DBD of one of the databases involved in the extract
17-??	SENSEG list	Variable length; 8 bytes per senseg

IMS segment record

The IMS segment records have the following format:

Table 6. IMS segment record structure

Columns	Field	Description
1-2	Logical number order	Used to sort the file, so logical children are inserted after logical parents. This is "01" for normal segments, "02" for logical children and either dependent segments.
3-4	Database number	The PCB number used to extract the data, for logical relationships the primary database specified on the Extract panel has a value of 1. Logically related databases have a value of 2, 3, and so on.
5-8	Extract order	Order in which the IMS segments were extracted by FM/IMS
9-16	DBD name	DBD of one of the databases involved in the extract
17-18	Segment code	
19-26	Segment name	
27-28	Reserved	Set to low values (x'00')
29-32	Concatenated key length	Actual concatenated key length for this segment
33-??	Concatenated key	
??-??	IMS segment data	This starts at 33+Max concatenated key length

Example

Here is an example of an Extract using key values and criteria. The Extract is run in DLI mode and uses a static PSB.

```
//FMNIXTRT 'Static PSB extract'
//*
//FILEMAN EXEC PGM=FMN1IMSB
//STEPLIB DD DSN=FMN.SFMNMOD1,DISP=SHR
//SYSPRINT DD SYSOUT=*,RECFM=FBA,LRECL=133
//FMNTSPRT DD SYSOUT=*
//FMN1JIN DD DISP=SHR,DSN=FMN.SFMNSLIB
//FMNIMSIN DD *
$$$FILEM IXB REGNTYPE=DLI,
$$$FILEM PSBTYPE=STATIC,
$$$FILEM PSBDSN=FMN.IMS.IVP.PSBLIB,
$$$FILEM PSBMEM=PUPA,
$$$FILEM PCBNUM=(3,2,1),
$$$FILEM DBDDSN=FMN.IMS.IVP.DBDLIB,
$$$FILEM DBDDSN2=IMSV1210.FMI.DBDLIB,
$$$FILEM DBDMEM=DJ2E,
$$$FILEM CRITERIA=Y,
$$$FILEM IMSID=IFA2,
$$$FILEM RESLIB1=IMSVA10.IFA2.SDFSRESL,
$$$FILEM RESLIB2=IMSVA10.IFA2.USERLIB,
```

```

$$$FILEM    DBRC=IMS,
$$$FILEM    IRLM=N,
$$$FILEM    DFSVSAMP=IMSVA10.IFB2.PROCLIB,
$$$FILEM    VSMPMEM=DFSVSMDB,
$$$FILEM    LKUNIT=CYL,
$$$FILEM    LKPQTY=20,
$$$FILEM    LKSQTY=20,
$$$FILEM    RKUNIT=CYL,
$$$FILEM    RKPQTY=20,
$$$FILEM    RKSQTY=20,
$$$FILEM    KEYEXT=Y
/*
//REPORT DD SYSOUT=*
//KEYSFILE DD DSN=FMN.XKEY.DJ2E,DISP=SHR
//UNLOAD DD DSN=FMN.IMS.EXTRACT.DJ2E,
// DISP=(,CATLG,DELETE),
// SPACE=(CYL,(1,1,0),RLSE),
// DCB=(RECFM=VB,LRECL=00150,BLKSIZE=0)
/* -----
/* -- Database data sets --
/* -----
//DJ2E DD DSN=FMN.IMS.IVP.DB.DJ2E,DISP=SHR
//DJ2F DD DSN=FMN.IMS.IVP.DB.DJ2F,DISP=SHR
//DJ3E DD DSN=FMN.IMS.IVP.DB.DJ3E,DISP=SHR
//DJ3F DD DSN=FMN.IMS.IVP.DB.DJ3F,DISP=SHR
//DJ1E DD DSN=FMN.IMS.IVP.DB.DJ1E,DISP=SHR
//DJ1F DD DSN=FMN.IMS.IVP.DB.DJ1F,DISP=SHR

```

Load (ILB)

Purpose

The Load dialog generates JCL that runs the Load (ILB) function. This function loads previously extracted data from a sequential data set into a database. You can edit the JCL and ILB input parameters before you submit the job, or you can create your own batch job to run the ILB function.

Usage notes

The Load JCL generated by FM/IMS consists of several steps depending on the parameters you have selected. The steps are:

- Delete/Define of the Database data sets. See [Note 1 on page 569](#).
- DBRC step to initialize the HALDB databases. Only included if the database is a HALDB. See [Note 1 on page 569](#) and [Note 2 on page 569](#).
- IMS PREREORG step to obtain the DBD logical and secondary index information. See [Note 1 on page 569](#) and [Note 2 on page 569](#).
- Step to sort the Load data into the correct order.
- FM/IMS step to load the IMS data. This is described in more detail below.
- IMS Prefix Resolution step to resolve the IMS pointers for logical relationships and secondary indexes. See [Note 1 on page 569](#) and [Note 2 on page 569](#).
- IMS secondary index unload step. See [Note 1 on page 569](#) and [Note 2 on page 569](#).

- IMS secondary index reload step. See Note 1 on page 569 and Note 2 on page 569.
- IMS prefix update step. See Note 1 on page 569 and Note 2 on page 569.



Note:

1. This step is only included if you are loading using a dynamic PSB in DLI mode, have a load type of "Insert-Load PSB (If DLI)" and on the Load options panel specified "Delete/Define IMS data sets".
2. For more information on this step, see the *IMS Utilities Reference: Database and Transaction Manager*.

FM/IMS Load step description

The FM/IMS Load step has the following flows:

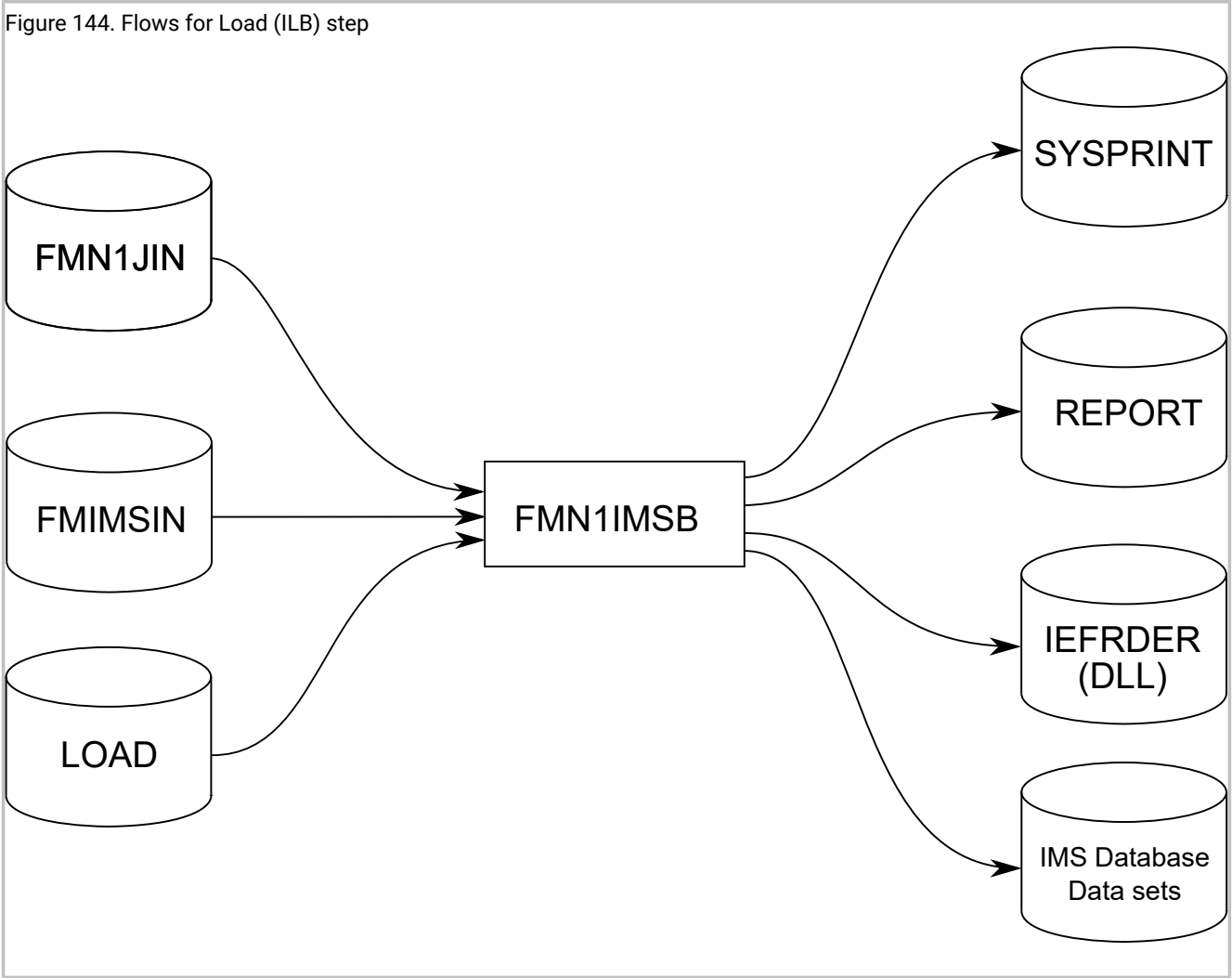

FMN1JIN

Points to the FM/IMS skeleton library. This DD statement is only used when you are loading data into HALDB databases.

FMNIMSIN

Contains the control statements for the Load. These control statements are discussed below.

REPORT

Defines the output data set for the Database Load Summary report.

IMS database data sets

In DLI mode, FM/IMS includes DDs for each of the IMS database data sets associated with the IMS database being loaded. If the database has logical relationships, the data sets for the logically related databases need to be included.

LOAD

Contains the IMS segments that are to be loaded by the function. In the job generated by FM/IMS, this is a temporary data set created by the sort step.

SYSPRINT

Defines the output data set for:

- The messages that the Load issues.
- The Load Diagnostic report that lists the IMS segments that could not be loaded.

IEFRDER

Defines the IMS log data sets that the Load is to use. Only required when running in DLI mode.

FMNIMSIN control statements

You use the FMNIMSIN control statements to specify:

- If the Load is to run in a BMP or DLI region.
- Whether to use a static PSB, or if FM/IMS is to generate a dynamic PSB to load the IMS data.
- How the data is to be loaded.
- Load checkpoint frequency.

Each line in FMNIMSIN starts with a `$$FILEM` and the first line contains the parameter `ILB` to specify that FM/IMS is performing a Load.

```
$$FILEM ILB REGNTYPE=DLI,  
$$FILEM PSBTYPE=DYNAMIC,  
$$FILEM DBDDSN=FMN.IMS.IVP,DBDLIB,  
. . .  
. . .
```

Figure 145. Syntax

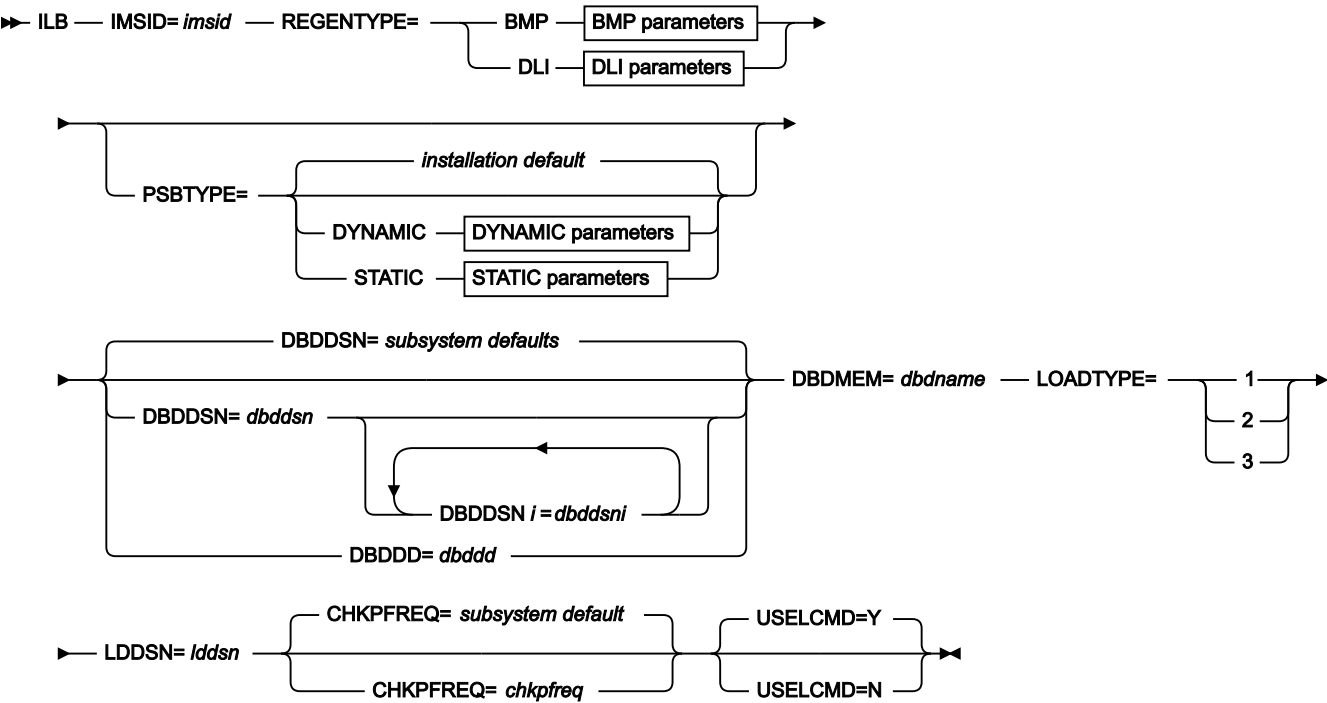

BMP parameters

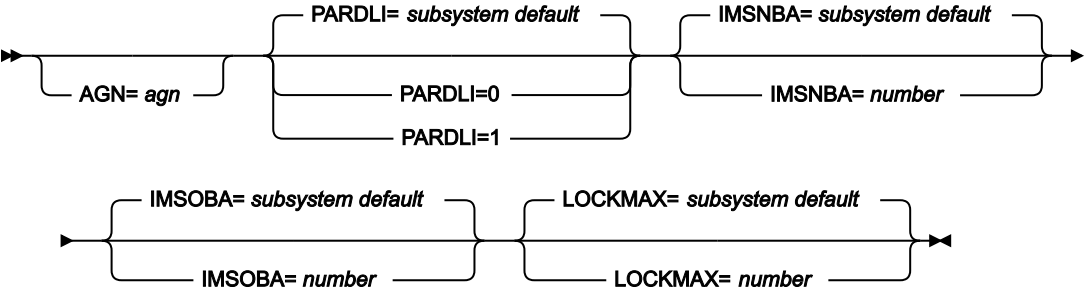

DLI parameters

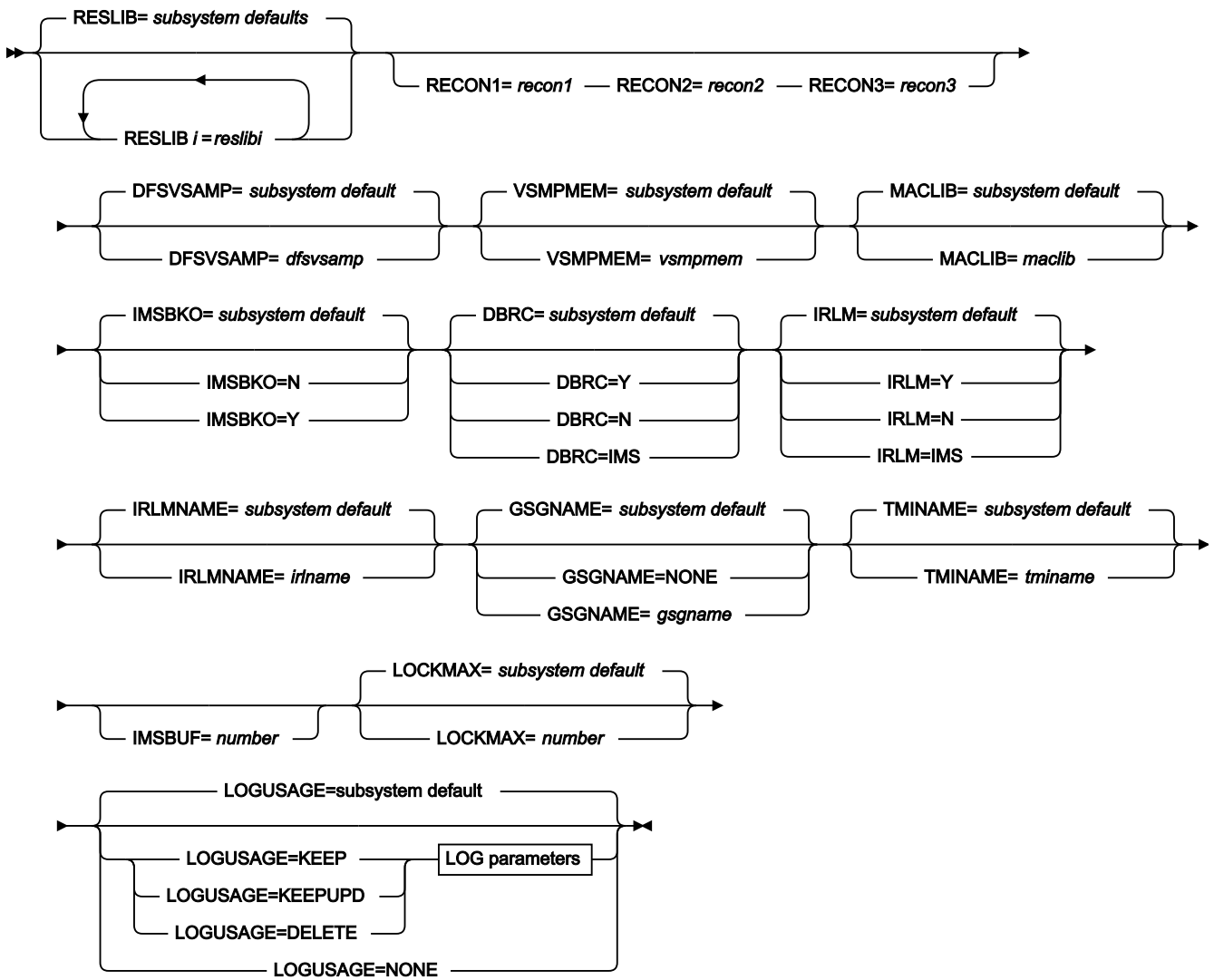

LOG parameters

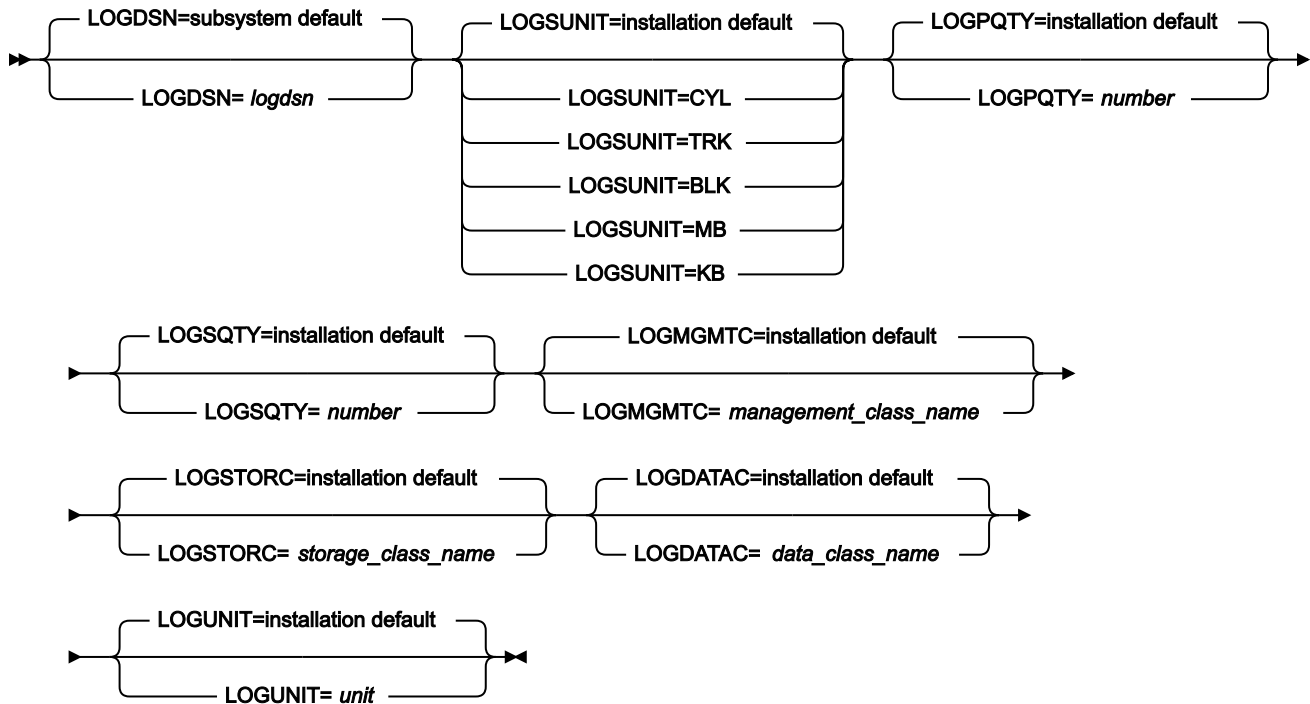

STATIC parameters

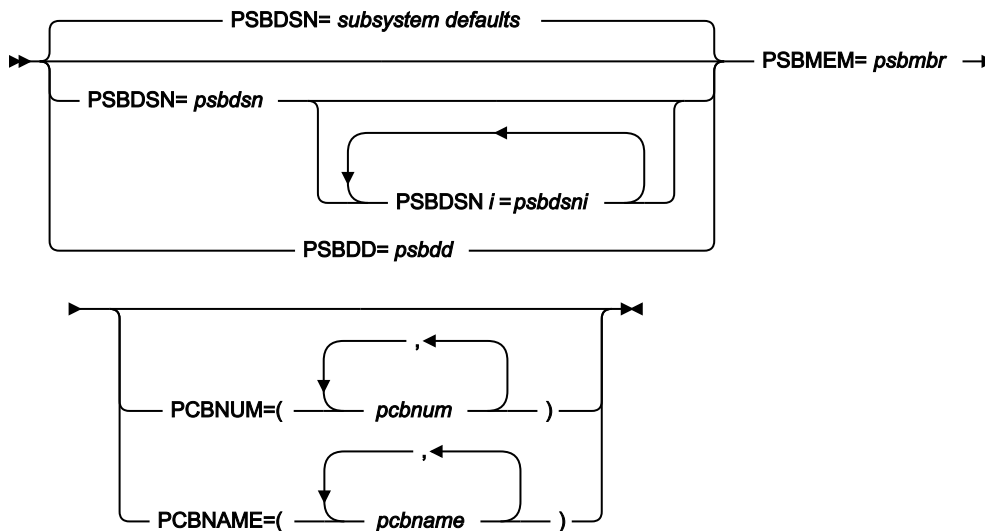

The LOADTYPE, LDDSN, CHKPFREQ and USELCMD parameters are described here. All the other parameters in this syntax diagram can also be specified for the Extract (IXB) function. For a description of these common parameters, see [Extract \(IXB\) on page 539](#).

LOADTYPE

Required parameter. Specifies:

- Whether or not the Load replaces existing segments in the database.
- Whether or not the load uses a load PCB.

1

Specifies that the Load is not to replace existing segments in the database. If you select this option, the load only attempts to insert the segment. If the insert call receives an II status code, the Load does not replace the existing segment in the database with the load segment.

2

Specifies that the Load is to replace existing segments in the database. If you select this option, the Load attempts to insert the segment, as it does when option 1 is selected. However, if the insert call receives an II status code, the Load replaces the existing segment in the database with the load segment. Note that if a segment has a non-unique key or no key, existing segments in the database are not replaced. The load segments are inserted even when there is an existing segment in the database with the same key.

3

Specifies that the Load uses a load PCB (PROCOPT=L/ LS) to load the segments into the database. Use this option for an initial load of a database.



Note: This option is only available when you specify PSBTYPE=DYNAMIC and REGNTYPE=DLI.

LDDSN=lddsn

Required parameter. The name of the data set that contains the data that you want loaded.

CHKPFREQ

Optional parameter. Specifies the frequency of the automatic save function during the Load; that is, the Load checkpoint frequency. FM/IMS:

- Increments a count by 1 each time the Load inserts or replaces a segment.
- Issues a checkpoint when the count is equal to the Load checkpoint frequency.

The valid range is 1 to 99999.

If you do not specify this parameter, FM/IMS uses

- The *subsystem* default for the parameter (if you have specified the IMSID parameter)
- The *installation* default for the parameter (if you have not specified the IMSID parameter).

The FM/IMS administrator specifies the subsystem and installation defaults at installation time.

USELCMD

Optional parameter. This option is only applicable when some of the segments you are loading have an insert rule of FIRST or HERE. Specifies whether or not the Load is to override these insert rules.

Y

Segments with no key or a non unique key are inserted as the last occurrence - this is irrespective of the insert rule for the segment type.

N

Segments with no key or a non unique key are inserted according to the insert rule for the segment type.



Note: If you are using the Extract (IXB) and Load (ILB) to extract data from one database and load it into another, and you want the twin segments in the loaded database to be in the same sequence as they were in the extracted database, then specify USELCMD=Y.

Database Load Statistics report

Figure 146. Database Load Statistics

IBM File Manager for z/OS IMS Component		Page 1	
Database Load Diagnostic Report		Date: 2004-03-24	Time: 12.56.51
Error Message/Concatenated Key	① DBD	② Segment	③ Level
Error when inserting segment - status code II FREMANTLE CDCDCEDC4444444444 695415335000000000	DJ2E	SUBURB	1 ④
Error when inserting segment - status code II FREMANTLE FREMANTLE BRIDGE CDCDCEDC4444444444CDCDCEDC4CDCCC4444444444444444 695415335000000000695415335029947500000000000000	DJ2E	NSTREET	2 ④

Here is a description of the columns of this report:

①

The DBD name of each database that was loaded.

The primary database is listed first.

②

The level of the segment type in the database hierarchy.

③

The name of the segment.

④

The diagnostic message.

Diagnostic messages consist of a message code, a short descriptive text and the IMS status code.

5

The concatenated keys of the segment occurrences for which this diagnostic message was issued.

Database Load Summary report

Figure 147. Database Load Summary

IBM File Manager for z/OS IMS Component		Database Load Summary	Page 1
			Date: 2013-05-27
			Time: 16.05.12
Load from:	FMNUSER.EXTRACT.DJ2E		
Load			
IMS subsystem:	IFA2		
Primary database:	DJ2E		
Processing Options			
PSB type:	Dynamic		
Region type:	DLI		
Load type:	Replace		
IMS log:	Keep		
DBD			
Data set name 1:	FMN.IMS.IVP.DBDLIB		
Database Data Sets			
	DBD name	DD name	Data set name

	DJ2E	DJ2E	FMN.IMS.IVP.DB.DJ2E
	DJ2F	DJ2F	FMN.IMS.IVP.DB.DJ2F
	DJ3E	DJ3E	FMN.IMS.IVP.DB.DJ3E
	DJ3F	DJ3F	FMN.IMS.IVP.DB.DJ3F
	DJ1E	DJ1E	FMN.IMS.IVP.DB.DJ1E
	DJ1F	DJ1F	FMN.IMS.IVP.DB.DJ1F

Load from

The name of data set that contains the data that was loaded.

IMS Subsystem

The name of the IMS subsystem that the databases are defined in.

Primary Database

The name of the primary database of the Load.

PSB type

The type of PSB that the Load used to access the databases:

Dynamic

The Load used a temporary PSB that it generated at the start of the batch job.

Static

The Load used an existing PSB.

Region type

The type of region that the Load ran in.

DLI

The Load ran in a DL/I batch processing region.

BMP

The Load ran in a BMP region.

Load Type**No replace**

The Load did not replace existing segments in the database.

Replace

The Load replaced existing segments with the load segment.

Initial

The Load used a load PSB (PROCOPT=L).

IMS log

(When the Region type is DLI)

None

The Load did not use an IMS log data set.

Keep

The Load used an IMS log data set and this data set was kept.

Delete

The Load used an IMS log data set but if the Load ended normally this data set was deleted.

PSB name

(When the PSB type is Static) The name of the PSB that the Load used.

PSB library

(When the PSB type is Static) The name of the library containing the PSB that the Load used.

DBD Data set names

The names of the DBD libraries used by the Load.

Database Data Sets

(When the Region type is DLI) the database data sets that the Load used.

DBD name

This column contains the name of the primary database and the names of the databases that are logically related to the primary database.

DD name

The DD names for each database specified in the DBD name column.

Data set name

The data set that was allocated to the specified DD name.

Database Load Diagnostic report

Figure 148. Database Load Diagnostic Report

IBM File Manager for z/OS IMS Component		Page 1	
Database Load Diagnostic Report		Date: 2004-03-24	Time: 12.56.51
Error Message/Concatenated Key	1 DBD	2 Segment	3 Level
Error when inserting segment - status code II FREMANTLE CDCDCDEDC4444444444 5 69541533500000000000	DJ2E	SUBURB	1 4
Error when inserting segment - status code II FREMANTLE FREMANTLE BRIDGE CDCDCDEDC4444444444CDCDCDEDC4CDCDC44444444444444 5 695415335000000000695415335029947500000000000000	DJ2E	NSTREET	2 4

1

The DBD name of each database that was loaded.

The primary database is listed first.

2

The level of the segment type in the database hierarchy.

3

The name of the segment.

4

The diagnostic message.

Diagnostic messages consist of a message code, a short descriptive text and the IMS status code.

5

The concatenated keys of the segment occurrences for which this diagnostic message was issued.

Example

Here is an example of a load of an IMS database in DLI mode using a static PSB.

```
//FMNLOAD 'Static PSB load'
//*
//FILEMAN EXEC PGM=FMN1IMSB
//STEPLIB DD DSN=FMN.SFMNMOD1,DISP=SHR
//SYSPRINT DD SYSOUT=*,RECFM=FBA,LRECL=133
//FMNTSPRT DD SYSOUT=*
//FMNIJIN DD DISP=SHR,DSN=FMN.SFMNSLIB
//FMNIMSIN DD *
$$$FILEM ILB REGNTYPE=DLI,
$$$FILEM PSBTYPE=STATIC,
$$$FILEM PSBDSN=IMSV1210.FMI.PSBLIB,
$$$FILEM PSBMEM=PUPA,
$$$FILEM PCBNUM=(3,2,1),
$$$FILEM LOADTYPE=2,
$$$FILEM LDDSN=FMN.IMS.EXTRACT.DJ2E,
$$$FILEM DBDDSN=FMN.IMS.IVP.DBDLIB,
```

```

$$FILEM      DBDDSN2=IMSV1210.FMI.DBDLIB,
$$FILEM      DBDMEM=DJ2E,
$$FILEM      IMSID=IF42
/*
//LOAD       DD DSN=&&FMN1XTSD,DISP=SHR
//IEFRDER    DD DSN=FMN.IMSLOG.D060713.T120159.DJ2E,
//           UNIT=SYSALLDA,
//           SPACE=(TRK,(20,150),RLSE),
//           DCB=(RECFM=VB,LRECL=6140,BLKSIZE=6144),
//           DISP=(NEW,DELETE,CATLG)
/* -----
/* -- Database data sets --
/* -----
//DJ2E DD DSN=FMN.IMS.IVP.DB.DJ2E,DISP=OLD
//DJ2F DD DSN=FMN.IMS.IVP.DB.DJ2F,DISP=OLD
//DJ3E DD DSN=FMN.IMS.IVP.DB.DJ3E,DISP=OLD
//DJ3F DD DSN=FMN.IMS.IVP.DB.DJ3F,DISP=OLD
//DJ1E DD DSN=FMN.IMS.IVP.DB.DJ1E,DISP=OLD
//DJ1F DD DSN=FMN.IMS.IVP.DB.DJ1F,DISP=OLD
//ENDRC      ENDIF
/*

```

Print (IPR)

Purpose

Prints either all the segments in an IMS database, or only those segments selected by the view you specify. You can choose to print the segments in CHAR, HEX, SNGL or TABL format (similar to the display formats in the FM/IMS editor under ISPF).

Usage notes

The Print JCL generated by FM/IMS has the following flows.

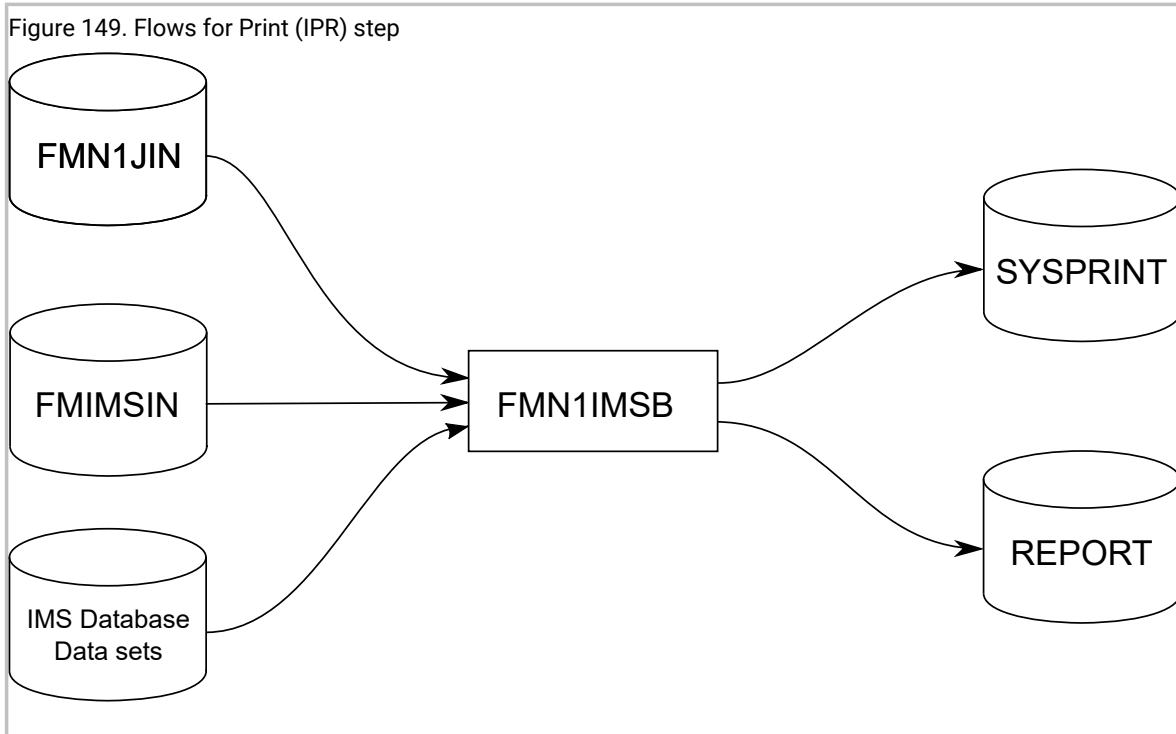

FMN1JIN

Points to the FM/IMS skeleton library. This DD statement is only used when you are printing data from HALDB databases.

FMNIMSIN

Contains the control statements for the Print. These control statements are discussed below.

IMS database data sets

In DLI mode, FM/IMS includes DDs for each of the IMS database data sets associated with the IMS database being printed. If the database has logical relationships, the data sets for the logically related databases need to be included.

SYSPRINT

Defines the output data set for:

- The messages that the Print issues.
- The printed IMS segments.

REPORT

Defines the output data set for the Database Print Summary and Database Print Statistics Report.

FMNIMSIN control statements

You use the FMNIMSIN control statements to specify:

- If the Print is to run in a BMP or DLI region.
- Whether to use a static PSB or if FM/IMS is to generate a dynamic PSB to print the IMS data.
- The format the IMS segments are printed in (CHAR, HEX, SNGL, or TABL).
- The FM/IMS view to be used when printing the IMS segments. Selection criteria (if specified) are used to determine the IMS segment to be printed. When printing in SNGL or TABL format, FM/IMS uses the fields to format the IMS segment.

Each line in FMNIMSIN starts with a \$\$FILEM and the first line contains the parameter IPR to specify that FM/IMS is performing a Print.

```
$$FILEM IPR REGNTYPE=DLI,  
$$FILEM PSBTYPE=DYNAMIC,  
$$FILEM DBDDSN=FMN.IMS.IVP.DBDLIB,  
. . .
```

Figure 150. Syntax

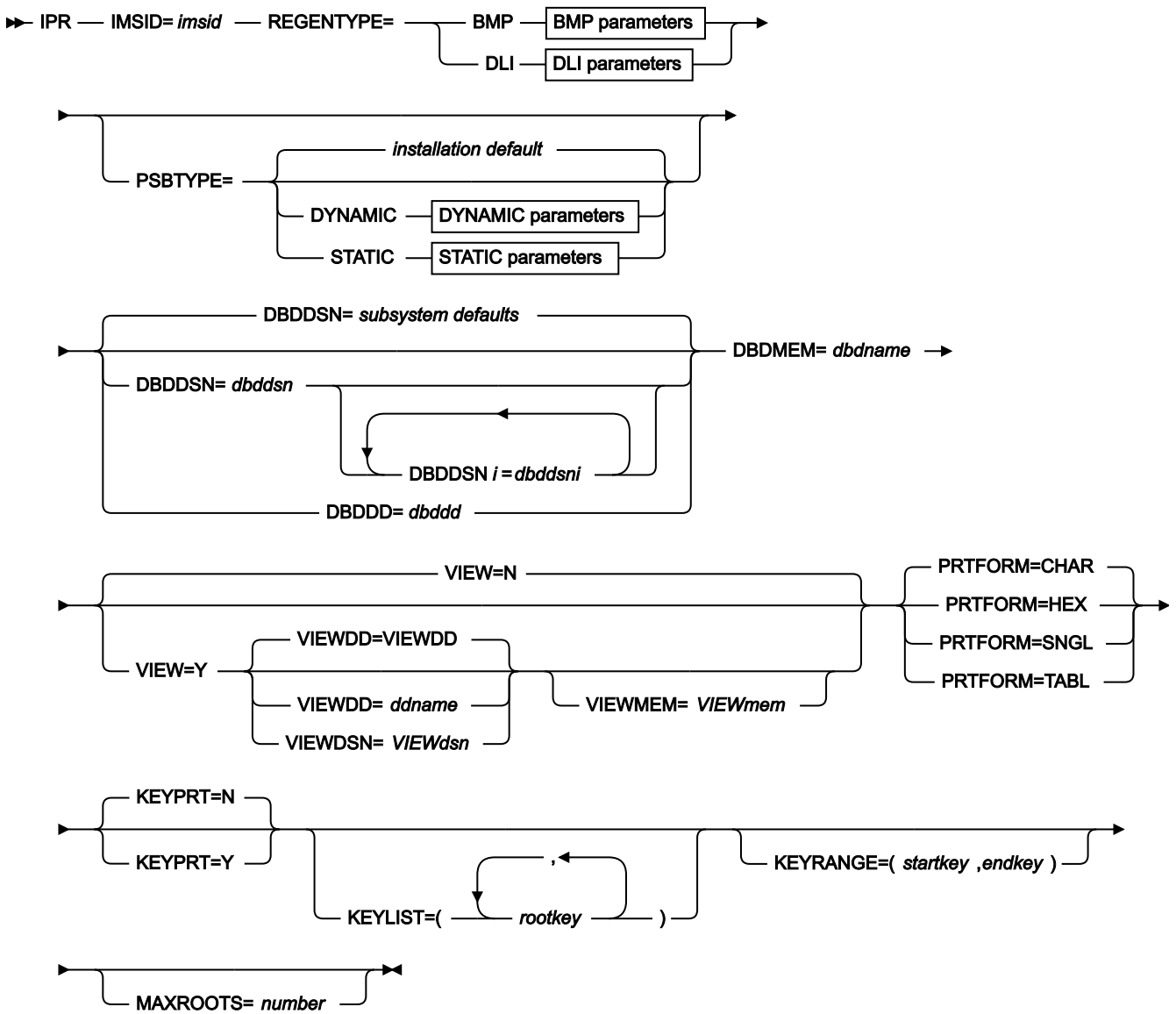

BMP parameters

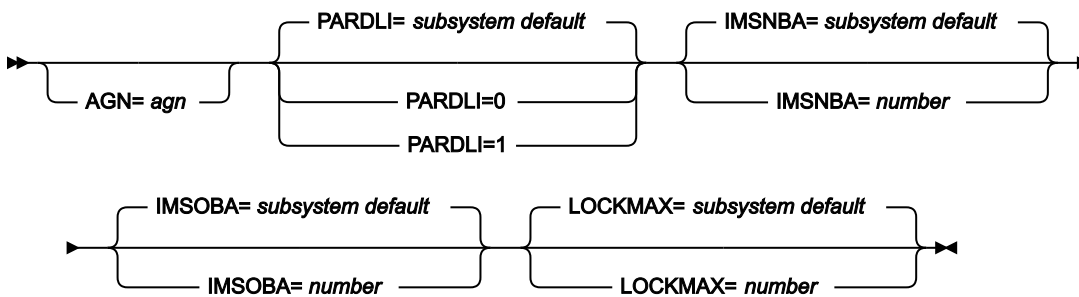

DLI parameters

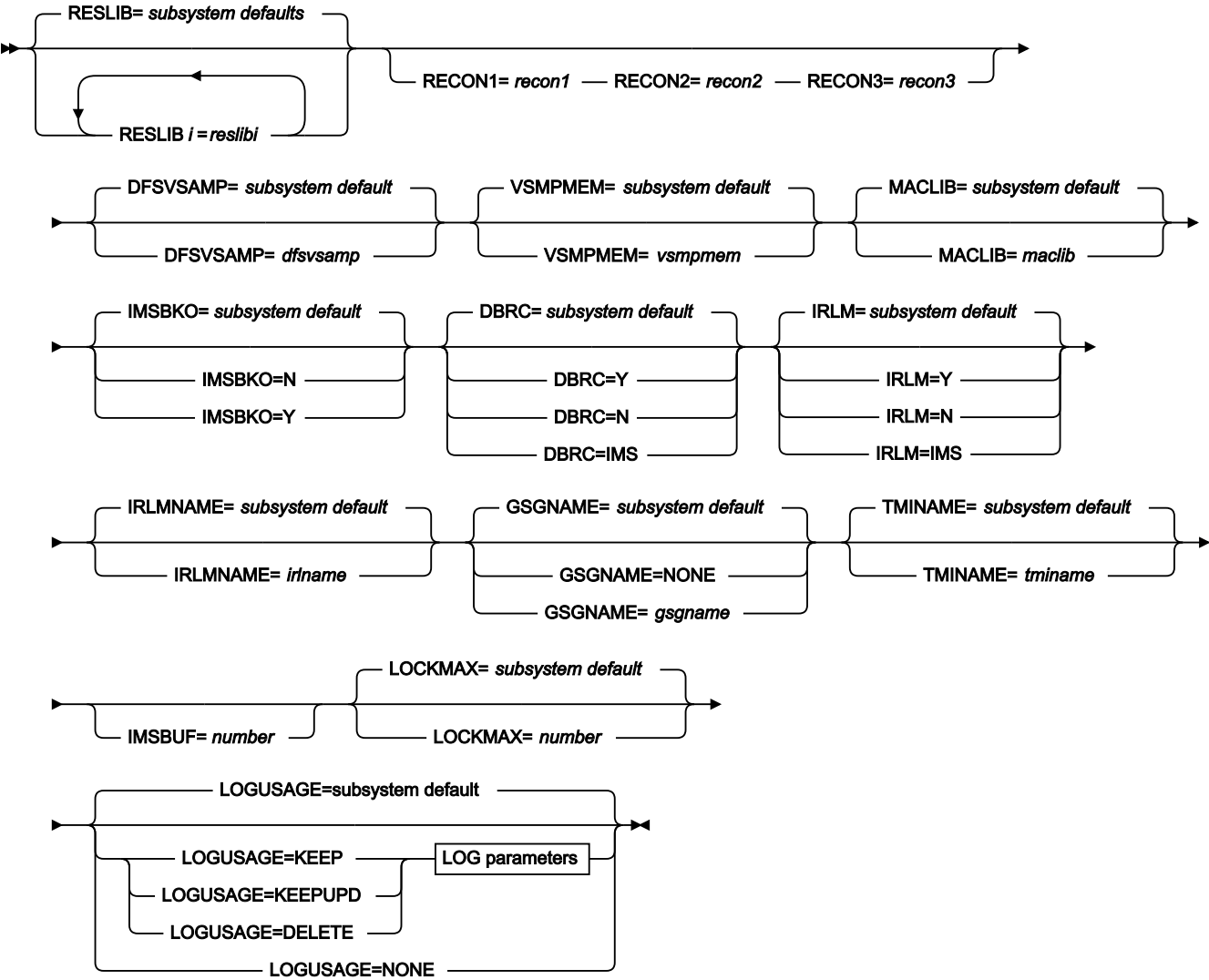

LOG parameters

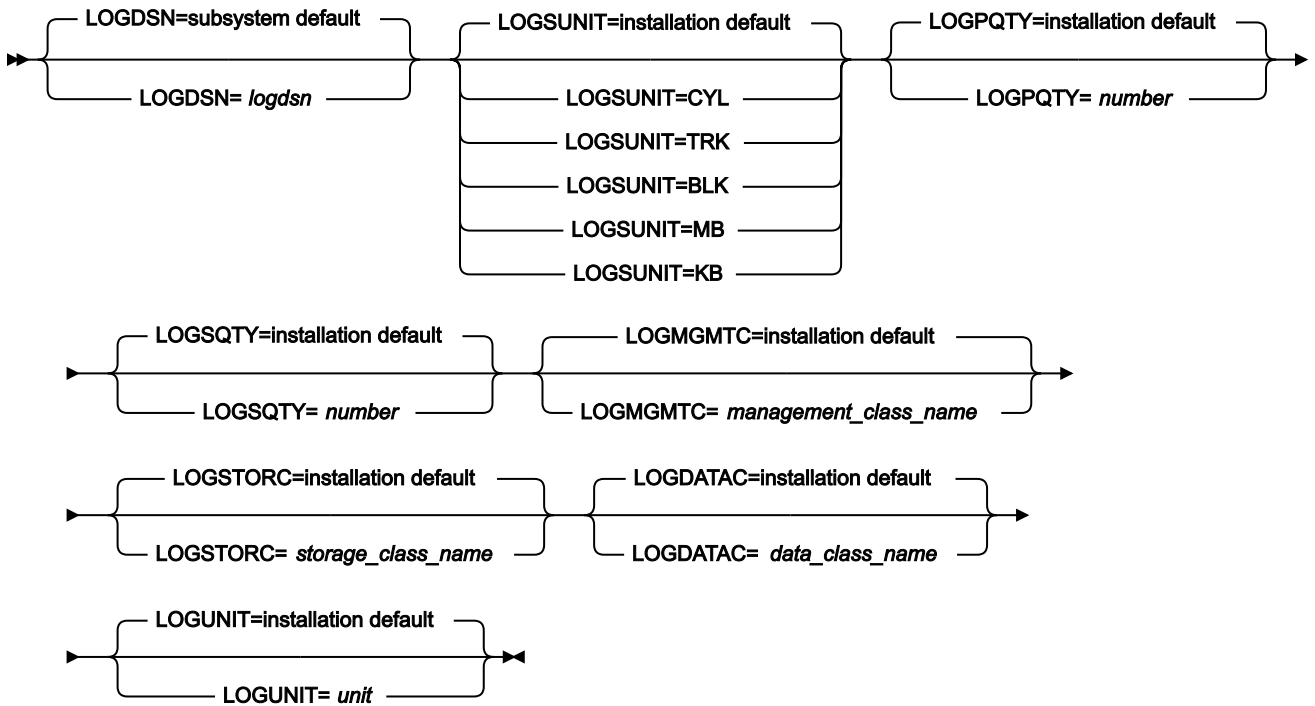

DYNAMIC parameters

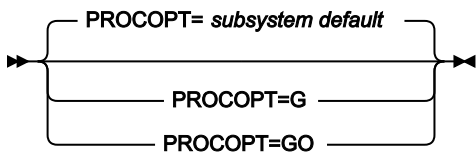

STATIC parameters

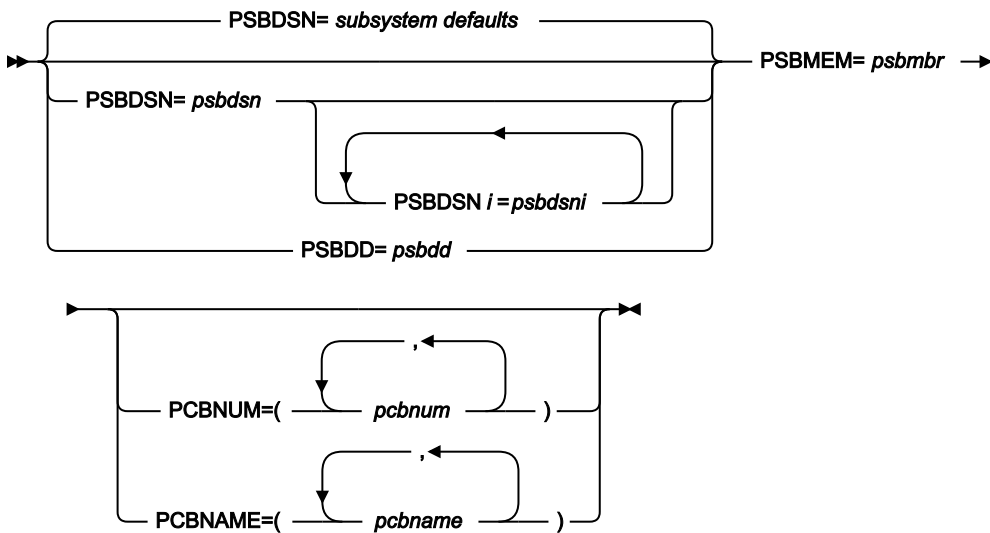

The VIEW, VIEWDD, VIEWDSN, VIEWMEM and PRTFORM parameters are described here. All the other parameters in this syntax diagram can also be specified for the Extract (IXB) function. For a description of these common parameters, see [Extract \(IXB\) on page 539](#) for details.

VIEW

Optional parameter. Specifies whether or not the Print uses a view.

N

The Print does not use a view.

Y

The Print uses a view. If Y is specified, you must specify the view that is to be used as outlined in the VIEWDD, VIEWDSN and VIEWMEM entries:

VIEWDD=ddname

Identifies the DD statement for the sequential data set or PDS(E) and member that contains the view you want your Print to use. The default is VIEWDD.

VIEWDSN=viewdsn

The name of the data set that contains the view that you want your Print to use. You may specify a sequential data set or a PDS(E). If you specify a PDS(E), the parameter may also include a member name in parentheses.

VIEWMEM=viewmem

Required when the VIEWDSN or VIEWDD parameter specifies a PDS(E) and does not specify the member. Specifies the member of the PDS(E) that contains the view you want your Print to use.

PRTFORM

Required parameter. Specifies the format in which the data is to be printed:

CHAR

Prints the data in character format.

HEX

Prints the data in hexadecimal "updown" format. This format uses three lines; one for the character, one for the zone digit, and one for the numeric digit of each byte.

SNGL

Prints the data in SNGL format. This format splits the data into fields and uses a separate line for each field. Only available when you are using a view.

TABL

Prints the data in a tabular format. Splits the data into fields and arranges the fields in columns. Only available when you are using a view.

KEYPRT

Optional parameter. Specifies whether or not the Print is restricted to those records that are specified in a key values data set.

N

The Print does not use a key values data set.

Y

The Print uses a key values data set. The key values data set contains the key values of the root segments of the records that you want printed.

You specify the key values data set in the KEYSFILE DD statement.

You may specify a sequential data set or a PDS(E) and member.

KEYLIST(*rootkey1,rootkey2,...*)

Optional parameter. Specifies a list of the root segment key values of the database records that you want printed. If the length of a root key value is less than the key length of the root segment, then the function considers it to be the first part of the key and prints all those database records with root key values that match the partial key value.

KEYRANGE(*startkey,endkey*)

Optional parameter. Specifies the start and the end of a range of root key values. The function prints those database records that have a root key value in the specified range.

startkey

The start of the range of the root key values. If the length of the *startkey* value is less than the key length of the root segment then the function appends low values (X'00') to the specified value.

endkey

The end of the range of the root key values. If the length of the *endkey* value is less than the key length of the root segment then the function appends high values to the specified value.

MAXROOTS=*number*

Optional parameter. Limits the number of database records that the function prints. When this parameter is specified, the function counts the number of database records that it has printed and terminates when it reaches the specified limit.

Database Print Summary

IBM File Manager for z/OS IMS Component		Page 1
Database Print Summary		Date: 2013-05-28
		Time: 14.07.11
Print from		
IMS subsystem:	IFA2	
Database:	DJ2E	
Processing Options		
PSB type:	Static	
Region type:	DLI	
Print format:	TABL	
Use view:	Y	

```

Use key values:      Y
View data set:      FMN.IMS.VIEW(DJ2E#V1)
Key values data set: FMN.XKEY.DJ2E
Key Value Counts
  Number read:      6
  Number not found: 0
PSB name:           PUPA
PSB library:        FMN.IMS.IVP.PSBLIB
DBD
  Data set name 1:  FMN.IMS.IVP.DBDLIB
  Data set name 2:  IMSV1210.FMI.DBDLIB
Database Data Sets:
  DBD name  DD name  Data set name
-----
  DJ2E      DJ2E      FMN.IMS.IVP.DB.DJ2E
  DJ2F      DJ2F      FMN.IMS.IVP.DB.DJ2F
  DJ3E      DJ3E      FMN.IMS.IVP.DB.DJ3E
  DJ3F      DJ3F      FMN.IMS.IVP.DB.DJ3F
  DJ1E      DJ1E      FMN.IMS.IVP.DB.DJ1E
  DJ1F      DJ1F      FMN.IMS.IVP.DB.DJ1F

```

IMS Subsystem

The name of the IMS subsystem that the database is defined in.

Database

The name of the database that was printed.

PSB type

The type of PSB that the Print used to access the database:

Dynamic

The Print used a temporary PSB that it generated at the start of the batch job.

Static

The Print used an existing PSB.

Region type

The type of region that the Print ran in.

DLI

The Print ran in a DL/I batch processing region.

BMP

The Print ran in a BMP region.

Print format**CHAR**

The data is printed in character format.

Non-printable characters are printed as spaces.

HEX

The data is printed in hexadecimal format.

SNGL

The data is printed in SNGL display format.

TABL

The data is printed in TABL display format.

Use view

Whether or not the Print used a view.

Use key values

Whether or not the Print was limited to specified root key values or a root key range.

View data set

The name of the data set that contains the view that the Print used.

Key values data set

The name of the data set that contains the key values of the root segments of the records that were printed.

Key value counts

Number read

The number of keys specified in the Key values data set and/or the KEYLIST parameter.

Number not found

The number of specified keys for which the root segment wasn't found. The SYSPRINT output lists the key values that were not found.

PSB name

(When the PSB type is Static) The name of the PSB that the Print used.

PSB library

(When the PSB type is Static) The name of the library containing the PSB that the Print used.

DBD Data set names

The names of the DBD libraries used by the Print.

Database Data Sets

(When the Region type is DLI) the database data sets that the Print used.

DBD name

This column contains the name of the database that was printed and the names of the databases that are logically related to the printed database.

DD name

The DD names for each database specified in the DBD name column.

Data set name

The data set that was allocated to the specified DD name.

Database Print Statistics Report

Database Print Statistics Report					
Database	Segment	Level	-Segm Length-		Segments Printed
			Min	Max	
DJ2E	SUBURB	01	62	62	6
	LINKSTR	02	28	28	509
	NSTREET	02	30	30	3
	INSHIRE	02	20	20	6
	LETRBOX	02	34	34	2
Grand total DJ2E					526

Here is a description of each column in this report.

Database

This column contains the name of the database that was printed.

Segment

This column contains the names of the segments in the database that was printed.

Level

The level of the segment.

Segm Length

Min

The minimum length of the segment as defined in the DBD.

Max

The maximum length of the segment as defined in the DBD.

For fixed-length segments, the minimum length and maximum length will be the same.

Segments Printed

The number of segment occurrences that the function printed.

The Grand total is the total number of segment occurrences printed.

Example

Here is an example of a Print using key values and a view. The Print is run in DLI mode and uses a static PSB. The segments are printed in TABL format.

```
//FMNIPRNT 'Static PSB Print'
//*
//FILEMAN EXEC PGM=FMN1IMSB
//STEPLIB DD DSN=FMN.SFMNMOD1,DISP=SHR
//SYSPRINT DD SYSOUT=*,RECFM=FBA,LRECL=133
//FMNTSPRT DD SYSOUT=*
//FMN1JIN DD DISP=SHR,DSN=FMN.SFMNSLIB
```

```

//FMNIMSIN DD *
$$FILEM IPR REGNTYPE=DLI,
$$FILEM PSBTYPE=STATIC,
$$FILEM PSBDSN=FMN.IMS.IVP.PSBLIB,
$$FILEM PSBMEM=PUPA,
$$FILEM PCBNUM=(3,2,1),
$$FILEM DBDDSN=FMN.IMS.IVP.DBDLIB,
$$FILEM DBDDSN2=IMSV1210.FMI.DBDLIB,
$$FILEM DBDMEM=DJ2E,
$$FILEM IMSID=IFA2,
$$FILEM RESLIB1=IMSV10.IFA2.SDFSRESL,
$$FILEM RESLIB2=IMSV10.IFA2.USERLIB,
$$FILEM DBRC=IMS,
$$FILEM IRLM=N,
$$FILEM DFSVSAMP=IMSV10.IFB2.PROCLIB,
$$FILEM VSMPMEM=DFSVSMDB,
$$FILEM VIEW=Y,
$$FILEM KEYPRT=Y,
$$FILEM PRTFORM=TABL
/*
//VIEWDD DD DSN=FMN.IMS.VIEW(DJ2E#V1),DISP=SHR
//REPORT DD SYSOUT=*
//KEYSFILE DD DSN=FMN.XKEY.DJ2E,DISP=SHR
/* -----
/* -- Database data sets --
/* -----
//DJ2E DD DSN=FMN.IMS.IVP.DB.DJ2E,DISP=SHR
//DJ2F DD DSN=FMN.IMS.IVP.DB.DJ2F,DISP=SHR
//DJ3E DD DSN=FMN.IMS.IVP.DB.DJ3E,DISP=SHR
//DJ3F DD DSN=FMN.IMS.IVP.DB.DJ3F,DISP=SHR
//DJ1E DD DSN=FMN.IMS.IVP.DB.DJ1E,DISP=SHR
//DJ1F DD DSN=FMN.IMS.IVP.DB.DJ1F,DISP=SHR

```

Batch Edit (IEB)

Purpose

Runs a REXX procedure that can contain both standard REXX statements and the following FM/IMS batch functions.

DELIMS

Delete an IMS segment

GETIMS

Retrieve an IMS segment

ISRTIMS

Insert an IMS segment

PRINT

Print an IMS segment

REPLIMS

Update an IMS segment

SAVEIMS

Commits the data to the IMS database and frees IMS resource. After SAVEIMS is issued, the position in the database is lost

SETRC

Sets the job step return code

VIEWIMS

Create a view for later use, or load an existing view (that you can then use with the GETIMS function to retrieve a segment).

VIEWPOSN

Positions on an IMS segment so that the next GETIMS (with USING_VIEW) retrieves segments starting at this point.

Usage notes

The REXX functions are available only in REXX procedures that you use with IEB.

Some of these functions pass values to, or read from, the following REXX variables:

INREC, OUTREC

The GETIMS function retrieves a segment, and passes the contents of the segment to both INREC and OUTREC. Use INREC as a reference variable only, and do not update it. You can update OUTREC, and use it as the contents of a new segment that you insert with the ISRTIMS function, or you can use it with the REPLIMS function to replace the contents of an existing segment.

FMSTATUS

Contains the DL/I status code from the previous DELIMS, GETIMS, ISRTIMS or REPLIMS function call. For a description of DL/I status code values, see *IMS Messages and Codes*.

FMCONKEY, FMSEGNM

Contains the concatenated key (FMCONKEY) or name (FMSEGNM) of the segment deleted, retrieved, inserted or replaced by the previous DELIMS, GETIMS, ISRTIMS or REPLIMS function call.

FMNDBDNM

Contains the DBD name. (However, this variable is null until you call a DELIMS, GETIMS, ISRTIMS or REPLIMS function.)

When using the Rexx function EXECIO, ensure that you code the command "ADDRESS MVS" before the EXECIO, otherwise you get an RC-3 executing the REXX.

These REXX variable names must be specified in all uppercase.

For all IEB functions:

The string of keywords and keyword values for each IEB function statement MUST be enclosed in single quotation marks. For statements requiring more than one line, each line must be enclosed in single quotation marks with the end quotation mark followed by a comma to indicate the continuation to the next line.

For IEB functions DELIMS, GETIMS, ISRTIMS and REPLIMS :

Where a field_value variable is specified for a #field_name or #field_ref keyword, the field_value variable may be enclosed in single or double quotation marks or may be specified without quotation marks.

For IEB function VIEWIMS:

Field selection_criteria are specified as REXX expressions. The selection_criteria expression should NOT be enclosed within single or double quotation marks.

The Batch Edit JCL generated by FM/IMS has the following flows:

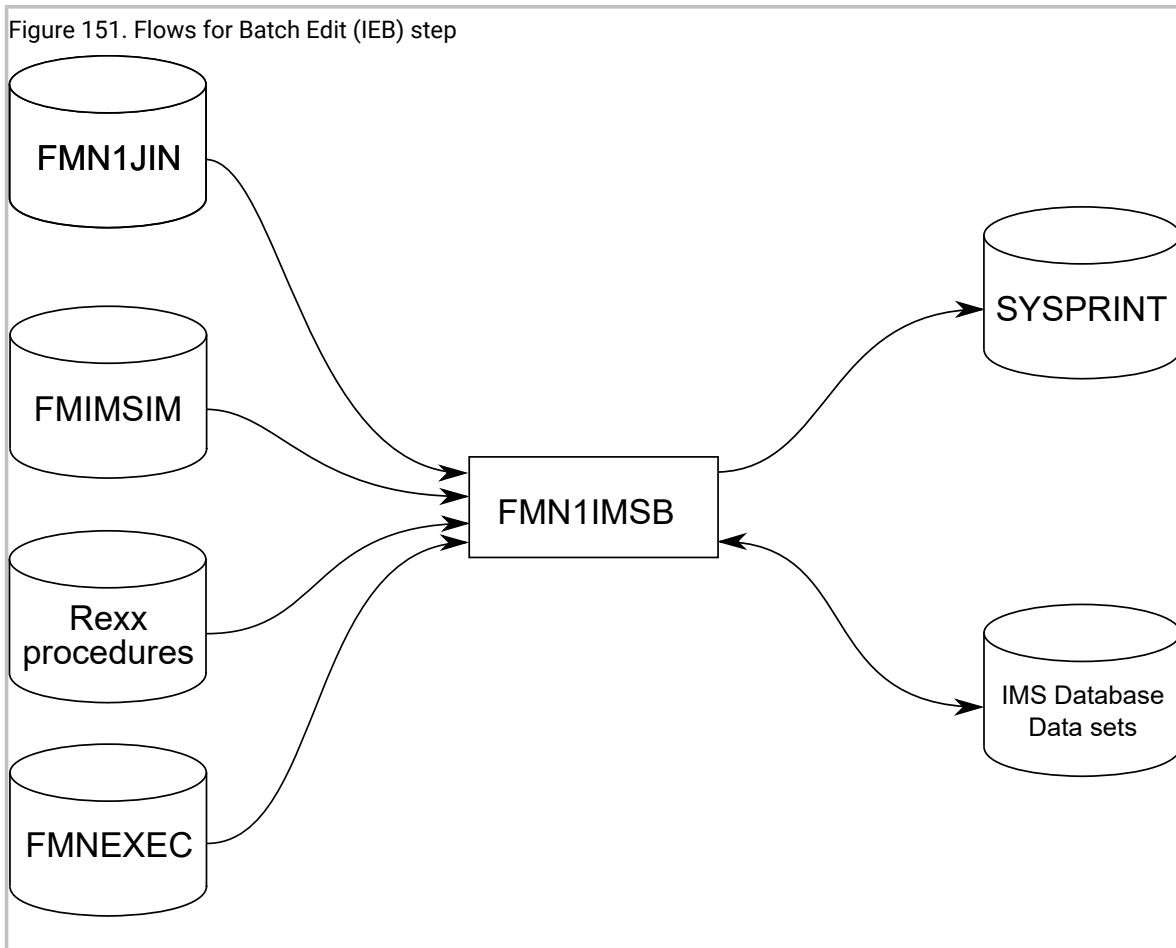

FMN1JIN

Points to the FM/IMS skeleton library. This DD statement is only used when you are editing HALDB databases.

FMNIMSIN

Contains the control statements for the batch edit. These control statements are discussed below.

IMS database data sets

In DLI mode, FM/IMS includes DDs for each of the IMS database data sets associated with the IMS database being maintained. If the database has logical relationships, the data sets for the logically related databases need to be included.

SYSPRINT

This contains the FM/IMS messages that were issued by FM/IMS while running the IEB REXX procedure.

REXX Procedure

A REXX exec which is to be run to maintain the IMS database in batch. This exec consists of standard REXX statements combined with FM/IMS IEB calls to allow a user to read and update IMS segments.

In FMNIMSIN, if PROC=* is specified in the REXX procedure, the REXX procedure is specified instream after the PROC=* parameter.

In FMNIMSIN, if PROC=<member> is specified, REXX procedure <member> found in the FMNEXEC library is run.

FMNEXEC

This contains the member that is to be run if PROC=<member> is specified in the FMNIMSIN parameters.

FMNIMSIN control statements

You use the FMNIMSIN control statements to specify:

- If the Batch Edit is to run in a BMP or DLI region.
- Whether to use a static PSB, or if FM/IMS is to generate a dynamic PSB to maintain the IMS data.
- Whether the IEB REXX procedure to be run is instream (PROC=*), or can be found in the library specified on the FMNEXEC DD.

Each line in FMNIMSIN starts with a \$\$FILEM and the first line contains the parameter IEB to specify that FM/IMS is performing Batch Edit.

```
$$FILEM IEB REGNTYPE=DLI,
$$FILEM PSBTYPE=DYNAMIC,
```

```

$$FILEM DBDDSN=FMN. IMS. IVP. DBDLIB,
. . .
    
```

Figure 152. Syntax

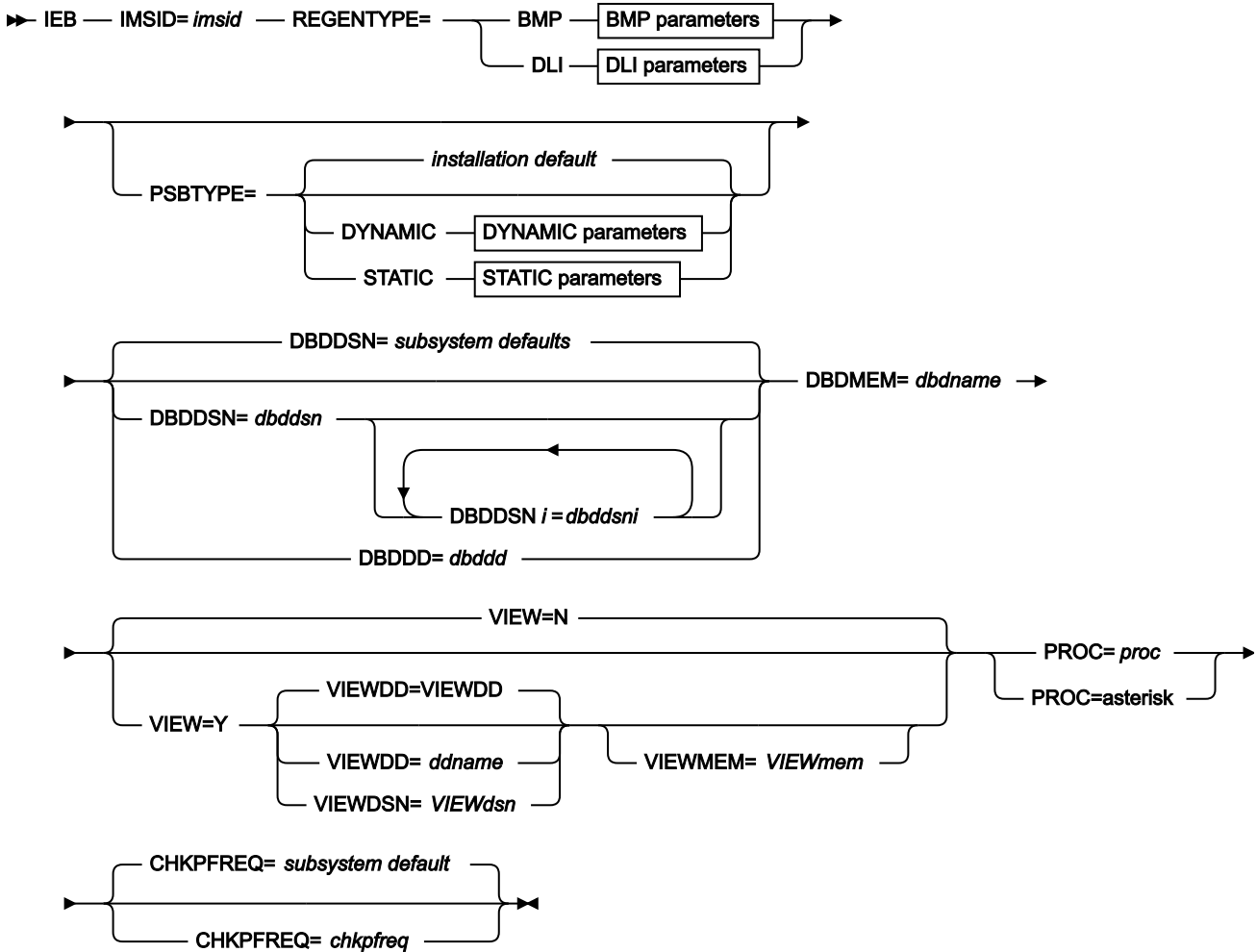

BMP parameters

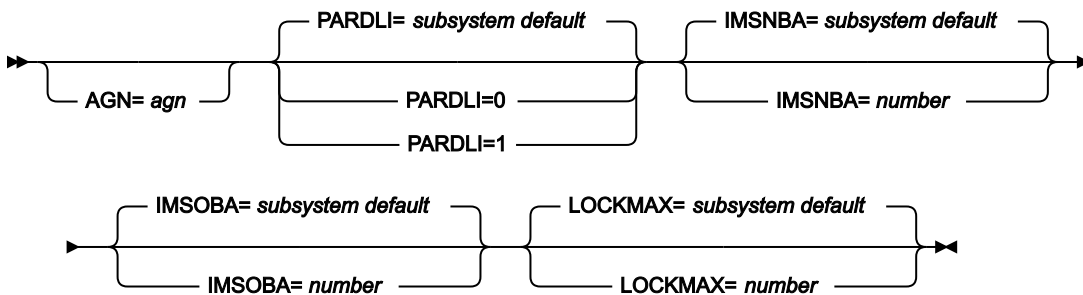

DLI parameters

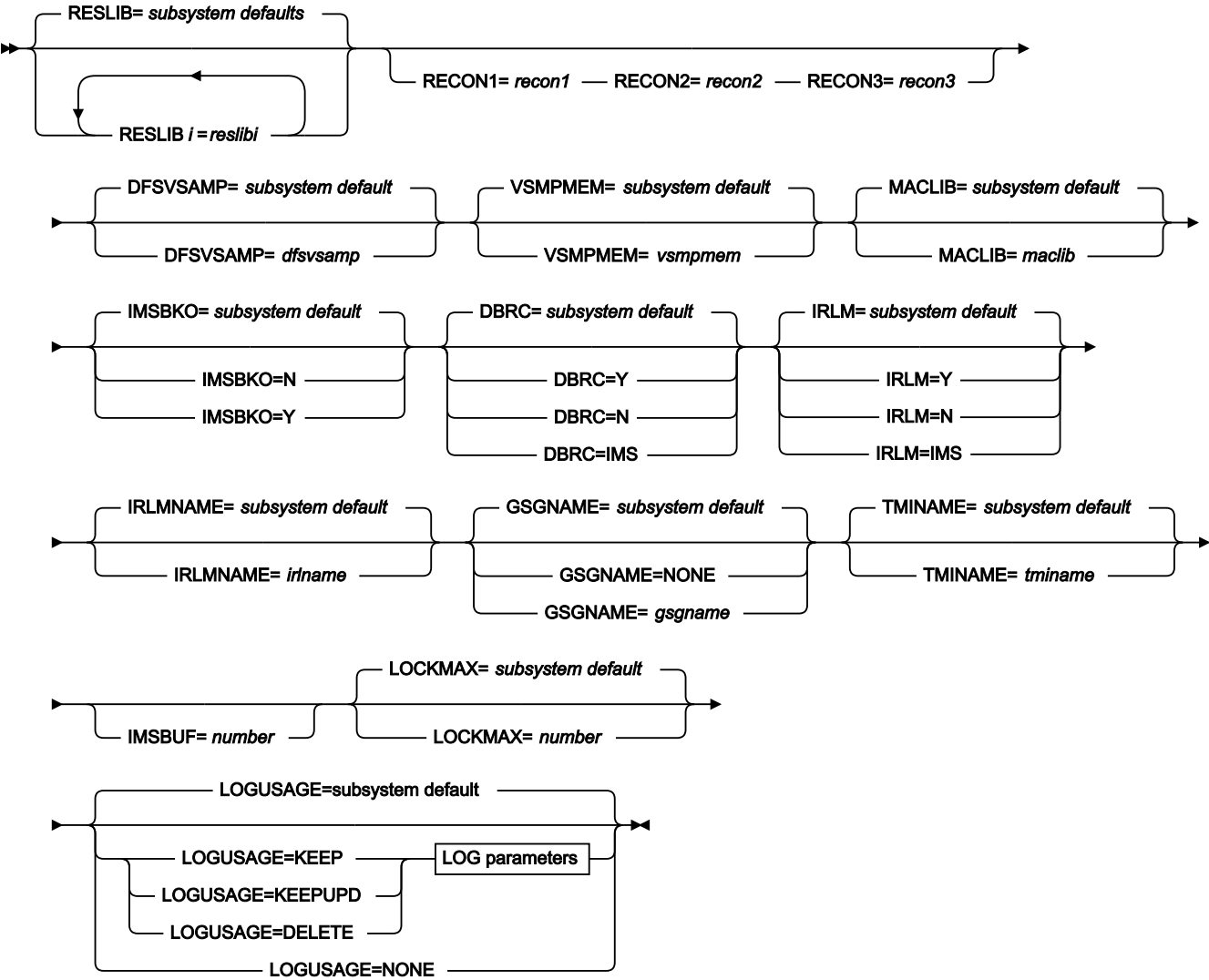

LOG parameters

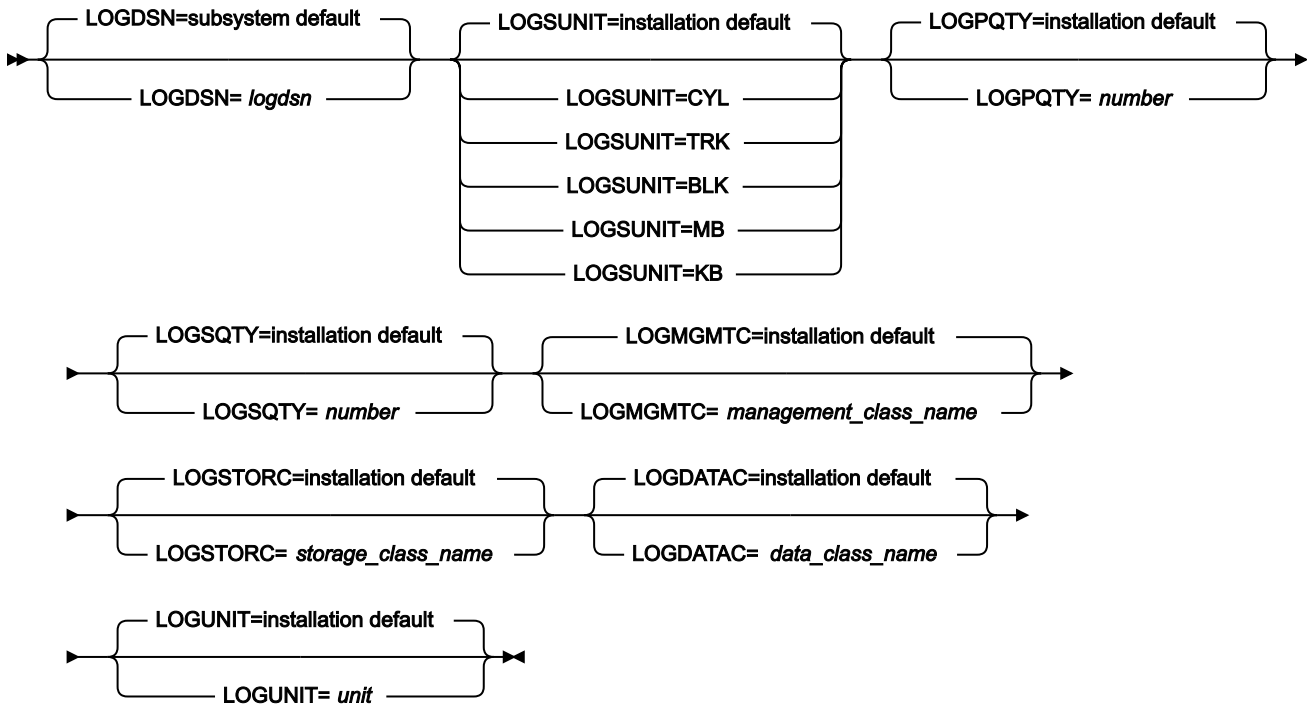

STATIC parameters

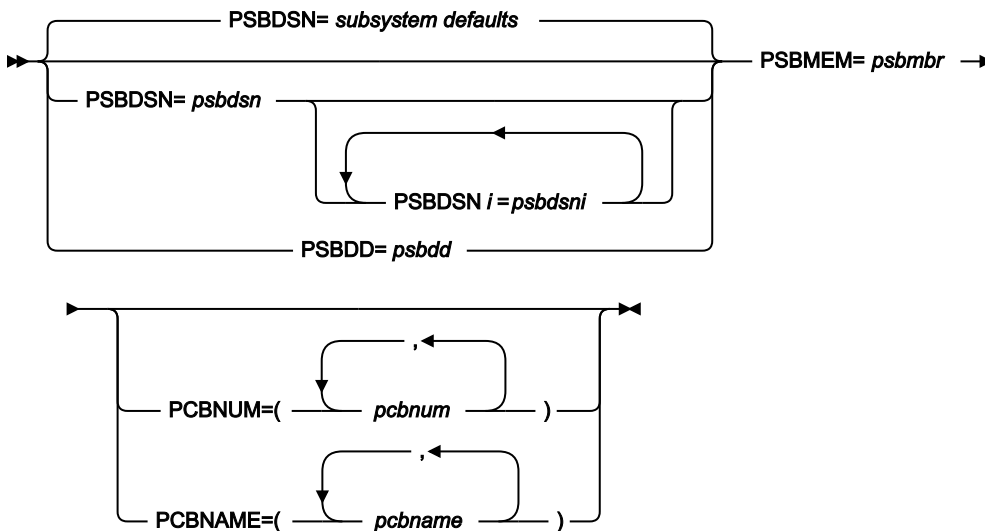

The VIEW, VIEWDD, VIEWDSN, VIEWMEM, CHKPFREQ and PROC parameters are described here. All the other parameters in this syntax diagram can also be specified for the Extract (IXB) function. For a description of these common parameters, see [Extract \(IXB\) on page 539](#).

CHKPFREQ= *chkpfreq*

Optional parameter. Specifies the frequency of the automatic save function during the Batch Edit; that is, the Batch Edit checkpoint frequency. FM/IMS:

- Increments a count by 1 each time the Batch Edit inserts, deletes, or replaces a segment.
- Issues a checkpoint when the count is equal to the Batch Edit checkpoint frequency.

The valid range is 1 to 99999.

VIEW

Optional parameter. Specifies whether or not the Batch Edit uses a view.

N

The Batch Edit does not use a view.

Y

The Batch Edit uses a view. If Y is specified, you must specify the view that is to be used as outlined in the VIEWDD, VIEWDSN, and VIEWMEM entries.

VIEWDD=ddname

Identifies the DD statement for the sequential data set or PDS(E) and member that contains the view you want the Batch Edit to use. The default is VIEWDD.

VIEWDSN=viewdsn

The name of the data set that contains the view that you want your Batch Edit to use. You may specify a sequential data set or a PDS(E). If you specify a PDS(E), the parameter may also include a member name in parentheses.

VIEWMEM=viewmem

Required when the VIEWDSN or VIEWDD parameter specifies a PDS(E) and does not specify the member. Specifies the member of the PDS(E) that contains the view you want the Batch Edit to use.

PROC=proc

Required parameter. Valid values are:

The name of a PDS(E) member

The name of the PDS(E) member containing the REXX procedure that you want the Batch Edit to use.

You specify the PDS(E) containing this member in the FMNEXEC DD statement. The JCL for the Batch Edit must include this DD statement.

An asterisk (*)

Indicates that the REXX procedure is inline.

The procedure is read from SYSIN immediately after the FMNIMSIN control statements. The inline procedure is terminated by a record containing a slash and a plus sign (/+) in columns 1 - 2.

REXX IEB calls

The REXX procedure that FM/IMS invokes uses standard TSO/E REXX.

However, you can call IEB functions to be able to retrieve, update, and print IMS segments. You can also create a File Manager/IMS view for use in the IEB procedure.

In the REXX procedure, you use GETIMS calls to retrieve segments from the IMS database. You have the option of using:

- GETIMS calls with the USING _VIEW clause (Retrieval using a view).

FM/IMS uses the selection criteria specified in the view to retrieve the relevant segment.

- GETIMS calls without the USING_VIEW clause (Retrieval without a view).

You have to navigate the database by issuing GETIMS call to retrieve the relevant segments. This method is similar to issuing IMS calls in a program; you need to determine how the segments are to be retrieved.

But FM/IMS does not allow you to use GETIMS calls with the USING_VIEW clause and GETIMS calls without the USING_VIEW clause in the same REXX procedure.

Retrieval using a view

The following IEB calls are available when processing the database using a view.

DELIMS calls (Delete an IMS segment)

This IEB call deletes the current segment and must be preceded by a GETIMS function call with the USING_VIEW parameter.

►► **DELIMS** — (SEGMENT= *delsegm*) ►◄

delsegm

The name of the segment you want to delete.

If FM/IMS encounters an unavailable HALDB partition or DEDB area, the DELIMS function receives a return code of 8 and the ISPF variable FMSTATUS indicates an IMS status code of:

FH

Unavailable DEDB area

BA

Unavailable HALDB partition

Returns zero if successful, otherwise nonzero. If DELIMS is unsuccessful, then you can check the DL/I status code in the FMSTATUS REXX variable to determine the cause of failure.

IEB example using DELIMS

```
:
$$FILEM IEB
```

```

:
$$FILEM PROC=*
filerc = VIEWIMS('TPLDSN=FMN.IMS.IVP.TEMPLATE')
/* Delete Segment at the current position */
filerc = GETIMS('SEGMENT=NSTREET NEXT')
filerc = DELIMS('SEGMENT=NSTREET')...

```

GETIMS CALL (Retrieve an IMS segment)

This IEB call retrieves the next segment selected by the view, skipping any intervening segments that are not selected by the view.

Figure 153. Syntax (using a view)

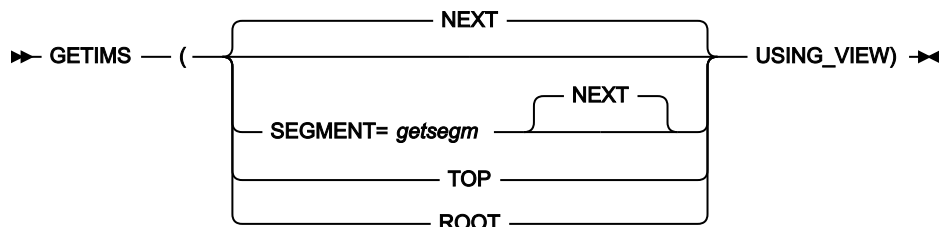

getsegm

The name of the segment you want to retrieve. If you also specify CHILD, then GETIMS retrieves the next hierarchically-dependent segment with this name. Otherwise, the default value is NEXT, and GETIMS retrieves the next segment with this name, regardless of hierarchy.

NEXT

Retrieves the next segment in the database that matches the criteria specified in the view.

ROOT

Retrieves the root segment in the hierarchical path of the current segment. If you use specify ROOT with USING_VIEW, and the root segment is not selected by the view, then ROOT retrieves the first selected segment after that root segment.

TOP

Without USING_VIEW, TOP retrieves the first root segment in the database. With USING_VIEW, TOP retrieves the first segment in the database that is selected by the view; this is not necessarily a root segment.

USING_VIEW

Restricts GETIMS to retrieving segments that are selected by the view, which you must have already loaded by calling the VIEWIMS function before this call to GETIMS.

Returns zero if successful, otherwise nonzero. A return code of 4 indicates that the GETIMS('NEXT USING_VIEW') reached the end of the database.

If FM/IMS encounters an unavailable HALDB partition or DEDB area, the GETIMS function receives a return code of 8 and the ISPF variable FMSTATUS indicates an IMS status code of:

FH

Unavailable DEDB area

BA

Unavailable HALDB partition

For nonzero return codes other than 4, check the DL/I status code in the FMSTATUS REXX variable to determine the cause of failure.

If successful, GETIMS passes the contents of the retrieved segment to the INREC and OUTREC REXX variables.

You can use GETIMS either with or without a view. If you use a view, then GETIMS only retrieves segments selected by the view. For example, GETIMS('NEXT USING_VIEW') retrieves the next segment selected by the view, skipping any intervening segments that are not selected by the view.

IEB example using GETIMS USING_VIEW

```
:  
$$FILEM IEB  
:  
$$FILEM PROC=*  
filerc = VIEWIMS('TPLDSN=FMN.IMS.IVP.TEMPLATE')  
/* Retrieve the next IMS segment from the view */  
filerc = GETIMS('NEXT USING_VIEW')
```

ISRTIMS CALL (Insert an IMS segment)

This IEB call inserts an IMS segment.

Figure 154. Syntax

►► ISRTIMS — (SEGMENT= *inssegm* →

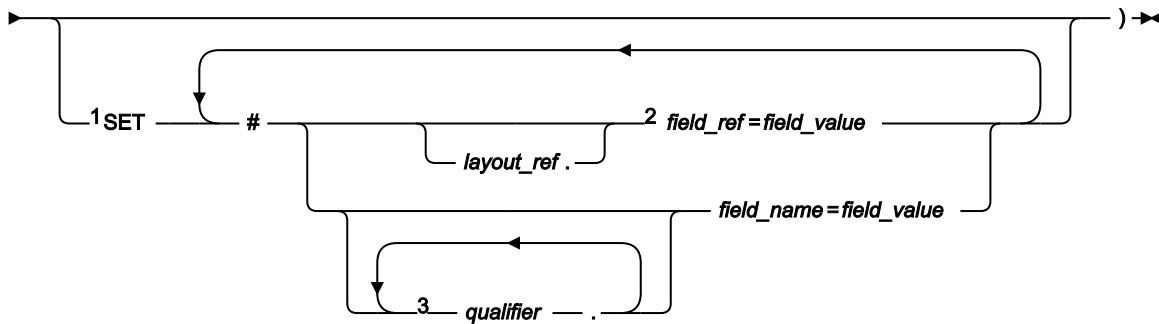

Notes:

- ¹ To use *field_ref* or *field_name*, you must have already loaded a view by preceding this function call with a call to VIEWIMS.
- ² Specification of a *field_ref* without qualification of a *layout_ref* results in the *field_ref* being associated with the first layout for the *inssegm* segment.
- ³ To fully qualify a *field_name*, the layout name must be the first *qualifier* specified. If the layout name is not specified, FM/IMS searches all the layouts for the *inssegm* segment in relative order until the group qualifiers and *field_name* are found. If not found, an error message is displayed and processing terminates.

field_name

A field name.

field_ref

A field reference number of the field within the layout. This can be obtained by printing the view/template using the VIEWIMS DESCRIBE clause or browsing the view/template online.

field_value

The value of the field specified by *field_ref* or *field_name*.

inssegm

The name of the segment you want to insert. This must be a child of the current segment.

layout_ref

The relative number of layout within a segment. This can be obtained by printing the view/template using the VIEWIMS DESCRIBE clause.

qualifier

One or more qualifiers that identify the field name (*field_name*). The first qualifier is the segment layout name. Subsequent qualifiers (if any) are the group fields used to identify the specified field name. Omitting the layout name or group fields causes FM/IMS to search the segment layouts for the specified qualifiers and field name.



Note: The layout names and group fields can be obtained by printing the view/template using the VIEWIMS DESCRIBE clause or browsing the view/template online.

Returns zero if successful, otherwise nonzero.

If FM/IMS encounters an unavailable HALDB partition or DEDB area, the DELIMS function receives a return code of 8 and the ISPF variable FMSTATUS indicates an IMS status code of:

FH

Unavailable DEDB area

BA

Unavailable HALDB partition

To use OUTREC as the contents of the new segment, omit the SET clause. If you are inserting a variable-length segment, then the first two bytes of OUTREC must specify the length of the segment. Otherwise, use the SET clause to specify the field values for the new segment.

IEB example using ISRTIMS

```

:
$$FILEM IEB
:
$$FILEM PROC=*
filerc = VIEWIMS('TPLDSN=FMN.IMS.IVP.TEMPLATE')
filerc = GETIMS('SEGMENT=SUBURB NEXT USING_VIEW')

/* Insert using OUTREC */
OUTREC = "FLOREAT RESERVE"
filerc = ISRTIMS('SEGMENT=NSTREET')

/* Insert using SET */

filerc = ISRTIMS('SEGMENT=NSTREET ',
                ' SET #2=FLOREAT PARK ')
    
```

PRINT CALL (Print an IMS segment)

This function prints the current segment in the format specified.

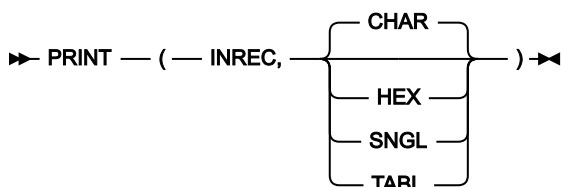

Returns zero if successful, otherwise nonzero.

Prints the segment contents stored in the INREC variable, in one of the following formats:

CHAR

Prints the segment as it is stored on the IMS database.

HEX

Prints three lines of data. The first line shows the character representation of each byte. The second and third lines show the hexadecimal value of each byte.

SNGL

Prints the segment split into individual fields down the report.

TABL

Prints the segment split into individual fields across the report.

The INREC variable contains the data of the current segment.

To print in SNGL or TABL format, you must have already loaded a view, by preceding this function call with a call to VIEWIMS.

IEB example using PRINT

```

:
$$FILEM IEB
:
$$FILEM      PROC=*

filerc = VIEWIMS('TPLDSN=FMN.IMS.IVP.TEMPLATE')

filerc = GETIMS('SEGMENT=SUBURB ',
               ' WHERE SEGMENT=SUBURB #SUBURB-NAME=CITY BEACH')
PRINT(INREC,CHAR)
PRINT(INREC,HEX)
PRINT(INREC,SNGL)
PRINT(INREC,TABL)
/+
:

```

REPLIMS CALL (Replace an IMS segment)

This IEB call replaces the current segment and must be preceded by a GETIMS function call with the USING_VIEW parameter.

Figure 155. Syntax

► REPLIMS — (SEGMENT= *repsegm* →

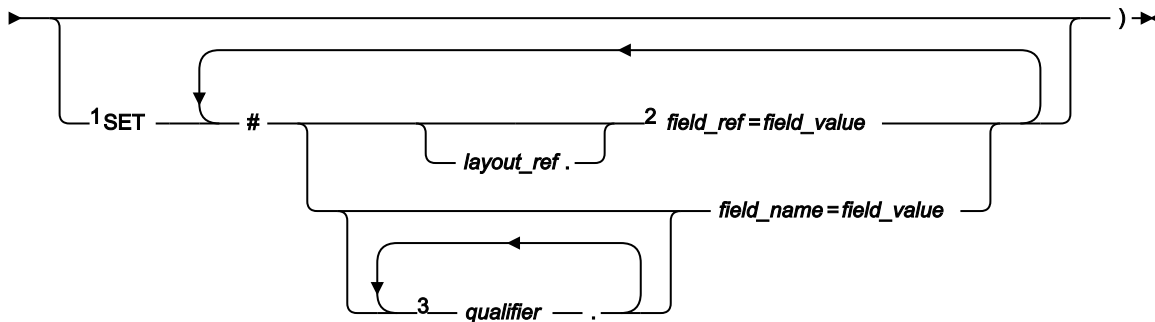

Notes:

¹ To use *field_ref* or *field_name*, you must have already loaded a view by preceding this function call with a call to VIEWIMS.

² Specification of a *field_ref* without qualification of a *layout_ref* results in the *field_ref* being associated with the current layout for the *repsegm* segment.

³ To fully qualify a field name, the layout name must be the first *qualifier* specified. If the layout name is not specified, FM/IMS searches the current the layout for the *repsegm* segment being replaced. If the group qualifiers and field name are not found, FM/IMS searches all the layouts for the *repsegm* segment in relative order until the group qualifiers and field name are found. If not found, an error message is displayed and processing terminates.

field_name

A field name.

field_ref

A field reference number of the field within the layout. This can be obtained by printing the view/template using the VIEWIMS DESCRIBE clause or browsing the view/template online.

field_value

The value of the field specified by *field_ref* or *field_name*.

layout_ref

The relative number of layout within a segment. This can be obtained by printing the view/template using the VIEWIMS DESCRIBE clause.

qualifier

One or more qualifiers that identify the field name (*field_name*). The first qualifier is the segment layout name. Subsequent qualifiers (if any) are the group fields used to identify the specified field name. Omitting the layout name or group fields causes FM/IMS to search the current *repsegm* segment layout for the specified qualifiers and field name. If not found, then all *repsegm* segment layouts are searched for the specified qualifiers and field name.



Note: The layout names and group fields can be obtained by printing the view/template using the VIEWIMS DESCRIBE clause or browsing the view/template online.

repsegm

The name of the segment you want to replace.

Returns zero if successful, otherwise nonzero.

If FM/IMS encounters an unavailable HALDB partition or DEDB area, the DELIMS function receives a return code of 8 and the ISPF variable FMSTATUS indicates an IMS status code of:

FH

Unavailable DEDB area

BA

Unavailable HALDB partition

To replace the current contents of the segment with the contents of the OUTREC variable, omit the SET clause. If you are replacing a variable-length segment, then the first two bytes of OUTREC must specify the length of the segment. Otherwise, use the SET clause to specify replacement field values for the segment.

When you use OUTREC, you replace the entire contents of the segment. When you use the SET clause, you can replace only the field values that you specify; other field values remain unchanged.

IEB example using REPLIMS

```

:
$$FILEM IEB
:
$$FILEM PROC=*
filerc = VIEWIMS('TPLDSN=FMN.IMS.IVP.TEMPLATE')
filerc = GETIMS('SEGMENT=SUBURB NEXT USING_VIEW')

/* Replace a segment using OUTREC */
OUTREC = OVERLAY('6168',outrec,19)
filerc = REPLIMS('SEGMENT=SUBURB')

/* Replace a segment using SET */
rtrc=REPLIMS('SEGMENT=SUBURB ',
            'SET #POST-CODE=6168')
```

SETRC CALL (Set Job Step return code)

The IEB call sets the Job Step return code to the value specified. It does not cause FM/IMS to exit the REXX procedure. The format of the call is:

Figure 156. Syntax

►► SETRC (rc) ◄◄

rc

Return code.

IEB example using SETRC

```
RTRC=GETIMS(USING_VIEW)
IF RTRC<>0 THEN DO
  SETRC(21)
  EXIT
END
```

VIEWIMS CALL (Load or create a view)

Figure 157. Syntax (to load an existing view or template)

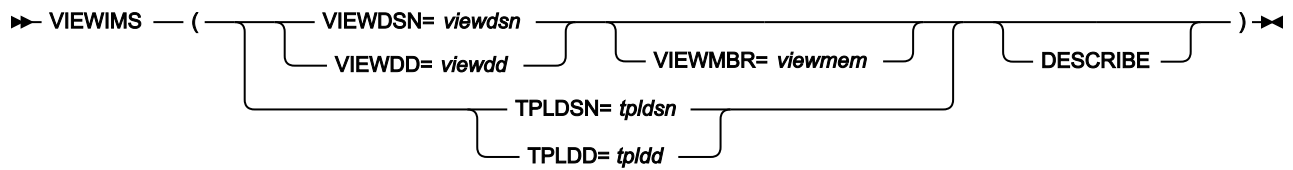
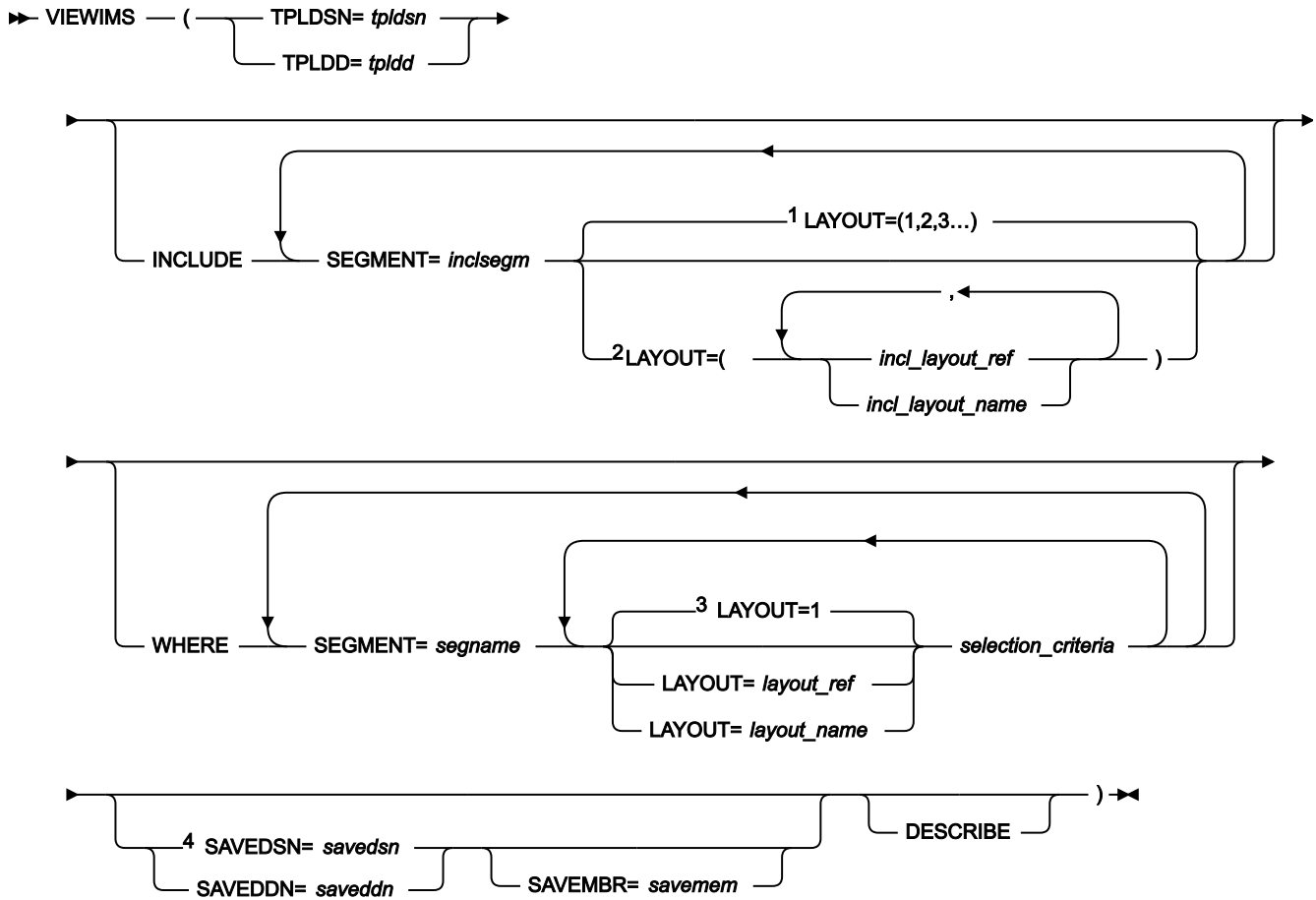

Figure 158. Syntax (to create a new view from an existing template)



Notes:

- ¹ If no layout parameter is specified, all layouts for *inclsegm* are selected.
- ² If only one *incl_layout_ref* or *incl_layout_name* is specified, the parentheses are not required.
- ³ If no layout parameter is specified, then the selection criteria applies to the first layout for the *segname* segment.
- ⁴ The old format of SAVE is still supported (`SAVE DSN=savedsn` or `SAVE DDN=saveddn` with, optionally, `MBR=savembr`).

If you specify the DESCRIBE parameter, then VIEWIMS prints a report showing the structure of the view or template for each segment in the database.

incl_layout_name

The name of the *inclsegm* segment layout to be selected in the view. You can obtain this by printing the view/template with the VIEWIMS DESCRIBE clause or browsing the view/template online.

incl_layout_ref

The relative number of the layout within the *inclsegm* segment that is selected in the view. You can obtain this by printing the view/template with the VIEWIMS DESCRIBE clause.

inclsegm

The name of a segment to be included in the view.

If you call the GETIMS function with the USING_VIEW parameter, then only the segment that is included in the view is retrieved. If you omit the INCLUDE clause entirely, all segments are included in the view.

layout_name

The name of the layout within the *segname* segment to which the selection criteria are to apply. This can be obtained by printing the view/template using the VIEWIMS clause or browsing the view/template online.

layout_ref

The relative number of the layout within a segment to which the selection criteria are to apply. This can be obtained by printing the view/template using the VIEWIMS DESCRIBE clause.

savedd

The DDNAME containing the data set into which the view is to be saved. If the data set is a PDS, you must also specify the SAVEMBR=*savemem* parameter.

savedsn

The name of the data set into which the view is to be saved. If the data set is a PDS, you must also specify the MBR=*savemem* parameter.

savemem

The member of the PDS specified by the DSN, SAVEDSN, DDN, or SAVEDDN parameter into which the view is to be saved.

segname

The name of a segment for which you want to specify field selection criteria.

selection_criteria

Field selection criteria for the *segname* segment. Determines which segment occurrences are retrieved by calls to the GETIMS function with the USING_VIEW parameter.

For details on specifying field selection criteria, see [Specifying field selection criteria on page 115](#).

tpldd

The DDNAME containing the template data set that is used as a basis to create a view. The template for the DBD must have already been created online in FM/IMS.

tpldsn

The name of the data set containing the template that is used as a basis to create a view. The template for the DBD must have already been created on-line in FM/IMS.

viewdd

The DDNAME containing one of the following:

- The sequential data set containing the view.
- The PDS containing the view. You then specify the member name in *viewmem*.

viewdsn

One of:

- The name of the sequential data set containing the view.
- The name of the PDS containing the view. (You then specify the member name in *viewmem*.)

viewmem

The member name of the view.

IEB example using VIEWIMS

```

:
$$FILEM IEB
:
$$FILEM    PROC=*
rtrc=VIEWIMS('TPLDSN=FMN.IVS.IVP.TEMPLATE ',
'SAVE      DSN=FMN.IVS.IVP.VIEW MBR=ZZ999 ',
           'INCLUDE  SEGMENT=SUBURB ',
           '          SEGMENT=LINKSTR ',
           'WHERE    SEGMENT=SUBURB substr(#2,1,1)=F ',
           '          SEGMENT=LINKSTR #4=ST ',
           'DESCRIBE')
/+
:

```

VIEWPOSN CALL (Position on an IMS segment)

This IEB call positions on an IMS segment so that the next GETIMS (with USING_VIEW) retrieves segments starting at this point.

Figure 159. Syntax

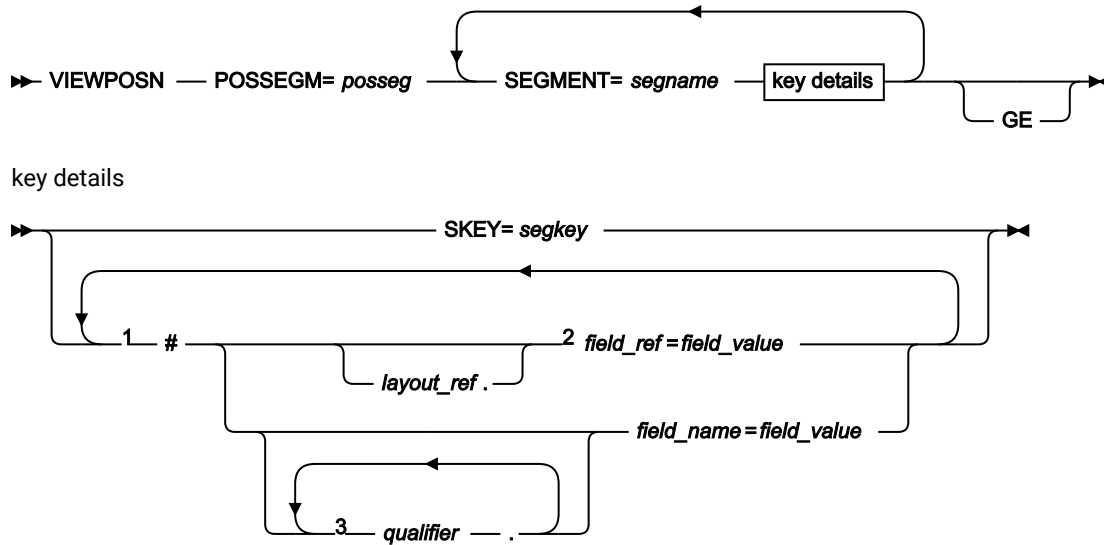

Notes:

- ¹ To use *field_ref* or *field_name*, you must have already loaded a view by preceding this function call with a call to VIEWIMS.
- ² Specification of a *field_ref* without qualification of a *layout_ref* results in the *field_ref* being associated with the first layout for the *segname* segment.
- ³ To fully qualify a *field_name*, the layout name must be the first *qualifier* specified. If the layout name is not specified, FM/IMS searches all the layouts for the *segname* segment in relative order until the group qualifiers and *field_name* are found. If not found, an error message is displayed and processing terminates.

field_name

A field name.

field_ref

A field reference number of the field within the layout. This can be obtained by printing the view/template using the VIEWIMS DESCRIBE clause or browsing the view/template online.

field_value

The value of the field specified by *field_ref* or *field_name*.

layout_ref

The relative number of layout within a segment. This can be obtained by printing the view/template using the VIEWIMS DESCRIBE clause.

posseg

The name of the segment you want to position on.

qualifier

One or more qualifiers that identify the field name (*field_name*). The first qualifier is the segment layout name. Subsequent qualifiers (if any) are the group fields used to identify the specified field name. Omitting the layout name or group fields causes FM/IMS to search the segment layouts for the specified qualifiers and field name.



Note: The layout names and group fields can be obtained by printing the view/template using the VIEWIMS DESCRIBE clause or browsing the view/template online.

segname

The name of a segment in the hierarchical path of the segment you want to position on.

Returns zero if successful, otherwise nonzero.

If FM/IMS encounters an unavailable HALDB partition or DEDB area, the DELIMS function receives a return code of 8 and the ISPF variable FMSTATUS indicates an IMS status code of:

FH

Unavailable DEDB area

BA

Unavailable HALDB partition

To replace the current contents of the segment with the contents of the OUTREC variable, omit the SET clause. If you are inserting a variable-length segment, then the first two bytes of OUTREC must specify the length of the segment.

IEB example using VIEWPOSN

```

:
$$FILEM IEB
:
$$FILEM PROC=*
filerc = VIEWIMS('TPLDSN=FMN.IMS.IVP.TEMPLATE')
filerc = VIEWPOSN('POSSEGM=NSTREET ',
                  'SEGMENT=SUBURB #SUBURB-NAME=CITY BEACH ',
                  'SEGMENT=NSTREET #2=FLOREAT BEACH ')

filerc = GETIMS(NEXT USING_VIEW)

```

Retrieval without a view

The following calls are available when processing the database without using a view.

A view may be loaded to allow the WHERE clause to specify key fields or to print the database in SNGL or TABL format, but the GETIMS call is issued without the USING_VIEW parameter.

DELIMS CALL (Delete an IMS segment)

This IEB call deletes the current segment.

Purpose

To delete an IMS segment

Usage notes

The DELIMS inbuilt FM/IMS REXX function can be used to:

- delete the current segment.
- delete a particular segment by specifying a where clause.

Figure 160. Syntax

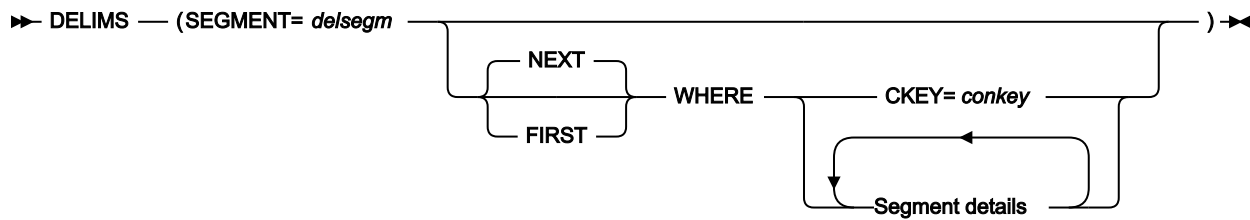

Segment details

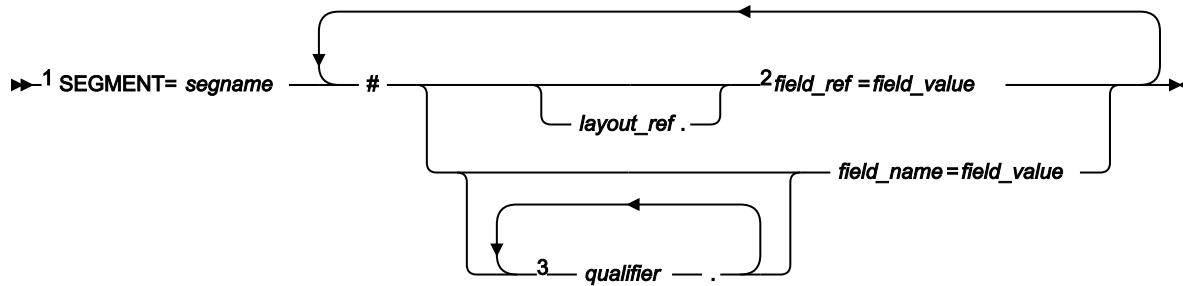

Notes:

- ¹ To use *field_ref* or *field_name*, you must have already loaded a view by preceding this function call with a call to VIEWIMS.
- ² Specification of a *field_ref* without qualification of a *layout_ref* results in the *field_ref* being associated with the first layout for the *delsegm* segment.
- ³ To fully qualify a *field_name*, the layout name must be the first *qualifier* specified. If the layout name is not specified, FM/IMS searches all the layouts for the *delsegm* segment in relative order until the group qualifiers and *field_name* are found. If not found, an error message is displayed and processing terminates.

conkey

The concatenated key of the segment you want to delete.

If you specify the concatenated key of a segment that you have already deleted, then DELIMS produces a nonzero return code, and does not delete any segment.

delsegm

The name of the segment you want to delete.

field_name

The name of a key field in the *segname* segment, as specified in the template or view.

field_ref

The reference number of a key field in the *segname* segment, as specified in the template or view. This can be obtained by printing the view/template using the VIEWIMS DESCRIBE clause or browsing the view/template online.

field_value

The value of the key field specified by *field_ref* or *field_name*.

FIRST

Deletes the first segment in the database that satisfies the WHERE clause.

layout_ref

The relative number of layout within *segname* segment. This can be obtained by printing the view/template using the VIEWIMS DESCRIBE clause.

NEXT

Deletes the next segment in the database after the current segment that satisfies the WHERE clause.

qualifier

One or more qualifiers that identify the field name (*field_name*). The first qualifier is the segment layout name. Subsequent qualifiers (if any) are the group fields used to identify the specified field name. Omitting the layout name or group fields causes FM/IMS to search the segment layouts for the specified qualifiers and field name.



Note: The layout names and group fields can be obtained by printing the view/template using the VIEWIMS DESCRIBE clause or browsing the view/template online.

segname

The name of a segment in the hierarchical path of the segment that you want to delete.

If FM/IMS encounters an unavailable HALDB partition or DEDB area, the DELIMS function receives a return code of 8 and the ISPF variable FMSTATUS indicates an IMS status code of:

FH

for an unavailable DEDB area.

BA

an unavailable HALDB partition.

Returns zero if successful, otherwise nonzero. If DELIMS is unsuccessful, then you can check the DL/I status code in the FMSTATUS REXX variable to determine the cause of failure.

To delete the current segment, omit the WHERE clause. Otherwise, use the WHERE clause to identify the segment you want to delete.

IEB example using DELIMS

```
:  
$$FILEM IEB  
:  
$$FILEM PROC=*  
filerc = VIEWIMS('TPLDSN=FMN.IMS.IVP.TEMPLATE')  
/* Delete Segment at the current position */  
filerc = GETIMS('SEGMENT=NSTREET NEXT')  
filerc = DELIMS('SEGMENT=NSTREET')  
/* Delete Segment using a where Clause */  
filerc = DELIMS('SEGMENT=NSTREET '  
                ' WHERE SEGMENT=SUBURB #SUBURB-NAME=CITY BEACH',  
                'SEGMENT=NSTREET #2=FLOREAT BEACH ')  
/+  
:
```

GETIMS CALL (Retrieve an IMS segment)

Figure 161. Syntax (without a view)

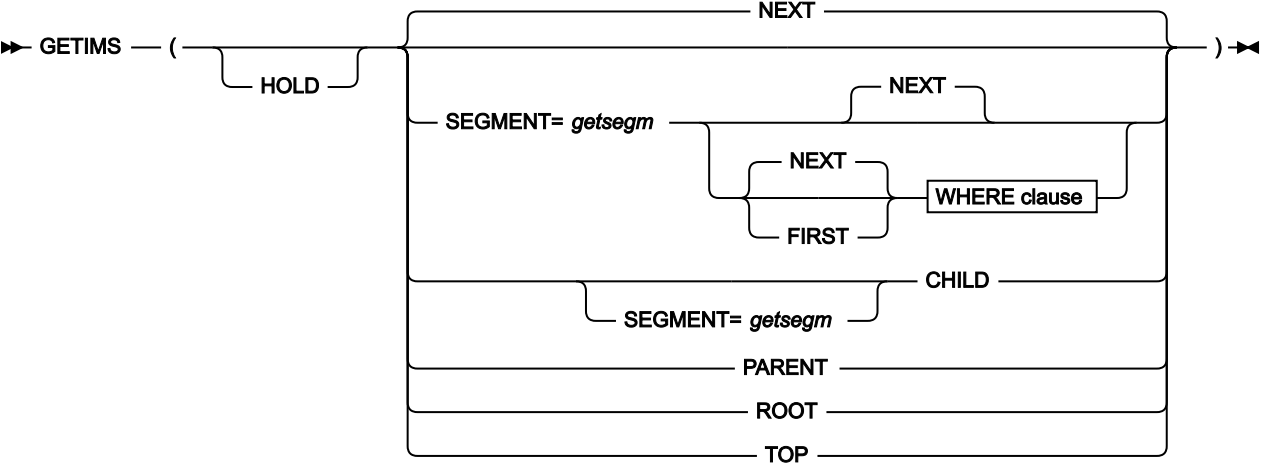

WHERE clause

WHERE →

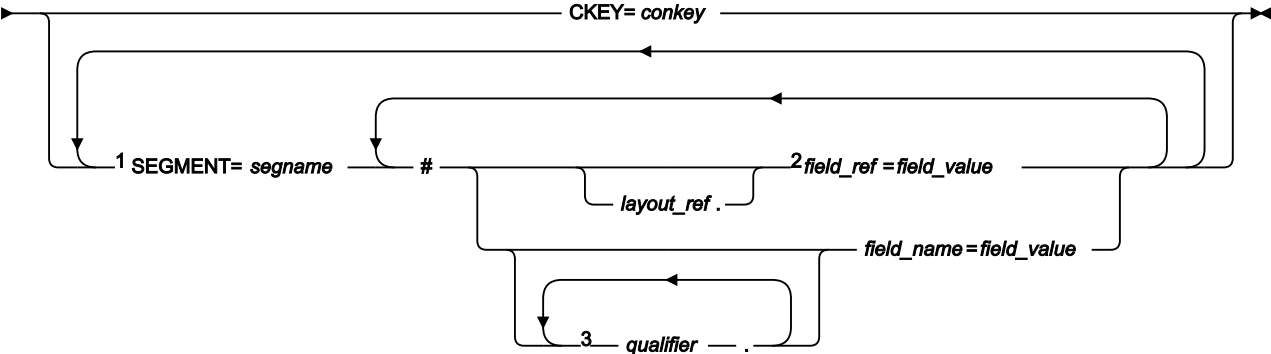

Notes:

- ¹ To use *field_ref* or *field_name*, you must have already loaded a view by preceding this function call with a call to VIEWIMS.
- ² Specification of a *field_ref* without qualification of a *layout_ref* results in the *field_ref* being associated with the first layout for the *segname* segment.
- ³ To fully qualify a *field_name*, the layout name must be the first *qualifier* specified. If the layout name is not specified, FM/IMS searches all the layouts for the *segname* segment in relative order until the group qualifiers and *field_name* are found. If not found, an error message is displayed and processing terminates.

CHILD

Retrieves the next segment in the hierarchical path of the current segment. If you also specify SEGMENT=*getsegm*, then GETIMS retrieves the next segment of that name in the hierarchical path of the current segment.

conkey

The concatenated key of the segment you want to retrieve.

field_name

The name of a key field in the segname segment, as specified in the template or view. This can be obtained by printing the view/template using the VIEWIMS DESCRIBE clause or browsing the view/template online.

field_ref

A field reference number of the field within the layout. This can be obtained by printing the view/template using the VIEWIMS DESCRIBE clause or browsing the view/template online.

field_value

The value of the key field specified by *field_ref* or *field_name*.

FIRST

Retrieves the first segment in the database that satisfies the WHERE clause.

getsegm

The name of the segment you want to retrieve. If you also specify CHILD, then GETIMS retrieves the next hierarchically dependent segment with this name. Otherwise, the default value is NEXT, and GETIMS retrieves the next segment with this name, regardless of hierarchy.

HOLD

Retrieves the segment with a hold. Code this parameter when the GETIMS call is followed by a REPLIMS call without a WHERE clause, or a DELIMS call without a WHERE clause.

If the segment or one of its parents has a nonunique key or no key, this parameter is mandatory. Without it, the REPLIMS call or DELIMS call fails. The REPLIMS call or DELIMS call will not fail if the segment and its parents have unique keys but, if you do code it, your EXEC executes less DL/I calls and runs more efficiently.

layout_ref

The relative number of layout within *segname* segment. This can be obtained by printing the view/template using the VIEWIMS DESCRIBE clause.

NEXT

Retrieves the next segment in the database after the current segment.

PARENT

Retrieves the parent segment of the current segment.

If the current segment is a root segment, then GETIMS retrieves that same segment. To avoid looping in this situation, you can use the FMSEGNM REXX variable to check the name of the current segment.

qualifier

One or more qualifiers that identify the field name (*field_name*). The first qualifier is the segment layout name. Subsequent qualifiers (if any) are the group fields used to identify the specified field name. Omitting the layout name or group fields causes FM/IMS to search the segment layouts for the specified qualifiers and field name.



Note: The layout names and group fields can be obtained by printing the view/template using the VIEWIMS DESCRIBE clause or browsing the view/template online.

ROOT

Retrieves the root segment in the hierarchical path of the current segment.

segname

The name of a segment in the hierarchical path of the segment that you want to retrieve.

TOP

Retrieves the first root segment in the database.

Returns zero if successful, otherwise nonzero. A return code of 4 indicates that a segment was not found for one of the following reasons:

- The segment specified by the WHERE clause does not exist.
- GETIMS('NEXT') reached the end of the database.
- GETIMS('CHILD') reached the end of the hierarchical path (current segment has no children).

If FM/IMS encounters an unavailable HALDB partition or DEDB area, the GETIMS function receives a return code of 8 and the ISPF variable FMSTATUS will indicate an IMS status code of:

FH

an unavailable DEDB area

BA

an unavailable HALDB partition

For nonzero return codes other than 4, check the DL/I status code in the FMSTATUS REXX variable to determine the cause of failure.

If successful, GETIMS passes the contents of the retrieved segment to the INREC and OUTREC REXX variables.

IEB example using GETIMS

```

:
$$FILEM IEB
:
$$FILEM      PROC=*

filerc = VIEWIMS('TPLDSN=FMN.IMS.IVP.TEMPLATE')
```

```

filerc = GETIMS('NEXT')
filerc = GETIMS()

filerc = GETIMS('SEGMENT=NSTREET ',
               ' WHERE SEGMENT=SUBURB #SUBURB-NAME=CITY BEACH ',
               'SEGMENT=NSTREET #2=FLOREAT BEACH ')

filerc = GETIMS('SEGMENT=NSTREET ',
               ' WHERE CKEY=CITY BEACH      FLOREAT BEACH ')

/+
:

```

ISRTIMS CALL (Insert an IMS segment)

Figure 162. Syntax

► ISRTIMS — (SEGMENT= *inssegm* →

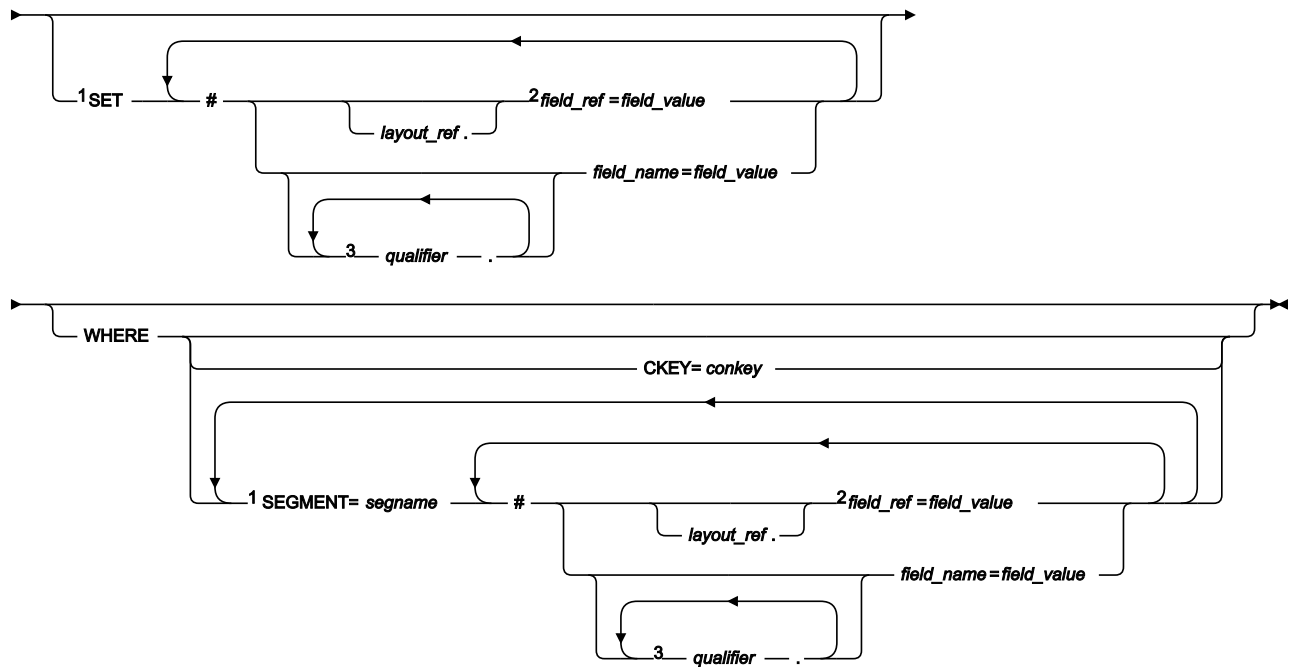

Notes:

- ¹ To use *field_ref* or *field_name*, you must have already loaded a view by preceding this function call with a call to VIEWIMS.
- ² Specification of a *field_ref* without qualification of a *layout_ref* results in the *field_ref* being associated with the first layout for the *inssegm* segment if specified on the SET clause, or the *segname* segment if specified on the WHERE clause.
- ³ To fully qualify a *field_name*, the layout name must be the first *qualifier* specified. If the layout name is not specified, FM/IMS searches all the layouts for the segment in relative order until the group qualifiers and *field_name* are found. If not found, an error message is displayed and processing terminates.

conkey

The concatenated key of the parent of the segment you want to insert.

field_name

A field name.

field_ref

A field reference number of the field within the layout. This can be obtained by printing the view/template using the VIEWIMS DESCRIBE clause or browsing the view/template online.

field_value

The value of the field specified by *field_ref* or *field_name*.

inssegm

The name of the segment you want to insert. This must be a child of the segment that you specify in the WHERE clause, or, if you omit the WHERE clause, a child of the current segment.

layout_ref

The relative number of layout within *segname* segment. This can be obtained by printing the view/template using the VIEWIMS DESCRIBE clause.

qualifier

One or more qualifiers that identify the field name (*field_name*). The first qualifier is the segment layout name. Subsequent qualifiers (if any) are the group fields used to identify the specified field name. Omitting the layout name or group fields causes FM/IMS to search the segment layouts for the specified qualifiers and field name.



Note: The layout names and group fields can be obtained by printing the view/template using the VIEWIMS DESCRIBE clause or browsing the view/template online.

segname

The name of a segment in the hierarchical path of the parent of the segment that you want to insert.

Returns zero if successful, otherwise nonzero.

If FM/IMS encounters an unavailable HALDB partition or DEDB area, the ISRTIMS function receives a return code of 8 and the ISPF variable FMSTATUS indicates an IMS status code of:

FH

an unavailable DEDB area

BA

an unavailable HALDB partition

To insert a new child segment under the current segment, omit the WHERE clause. Otherwise, use the WHERE clause to identify the parent of the new child segment that you want to insert.

To use OUTREC as the contents of the new segment, omit the SET clause. If you are inserting a variable-length segment, then the first two bytes of OUTREC must specify the length of the segment.

Otherwise, use the SET clause to specify the field values for the new segment.

IEB example using ISRTIMS

```

:
$$FILEM IEB
:
$$FILEM PROC=*

filerc = VIEWIMS('TPLDSN=FMN.IMS.IVP.TEMPLATE')

filerc = GETIMS('NEXT')
filerc = GETIMS('SEGMENT=SUBURB ',
                ' WHERE SEGMENT=SUBURB #SUBURB-NAME=CITY BEACH')

/* Insert using OUTREC */

OUTREC = "FLOREAT RESERVE"
filerc = ISRTIMS('SEGMENT=NSTREET')

/* Insert using SET */

filerc = ISRTIMS('SEGMENT=NSTREET ',
                ' SET #2=FLOREAT RESERVE ',
                ' WHERE SEGMENT=SUBURB #SUBURB-NAME=CITY BEACH')

/+
:

```

PRINT CALL (Print an IMS segment)

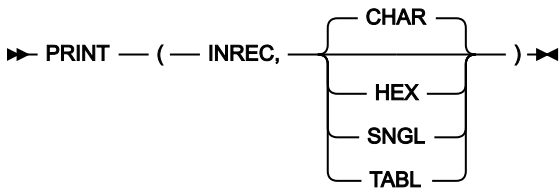

Returns zero if successful, otherwise nonzero.

Prints the segment contents stored in the INREC variable, in one of the following formats:

CHAR

Prints the segment as it is stored on the IMS database.

HEX

Prints three lines of data. The first line shows the character representation of each byte. The second and third lines show the hexadecimal value of each byte.

SNGL

Prints the segment split into individual fields down the report.

TABL

Prints the segment split into individual fields across the report.

The INREC variable contains the data of the current segment.

To print in SNGL or TABL format, you must have already loaded a view, by preceding this function call with a call to VIEWIMS.

IEB example using PRINT

```

:
$$FILEM IEB
:
$$FILEM      PROC=*

filerc = VIEWIMS('TPLDSN=FMN.IMS.IVP.TEMPLATE')

filerc = GETIMS('SEGMENT=SUBURB ',
               ' WHERE SEGMENT=SUBURB #SUBURB-NAME=CITY BEACH')
PRINT(INREC,CHAR)
PRINT(INREC,HEX)
PRINT(INREC,SNGL)
PRINT(INREC,TABL)
/+
:

```

REPLIMS CALL (Replace an IMS segment)

Figure 163. Syntax

►► REPLIMS — (SEGMENT= *repsegm* →

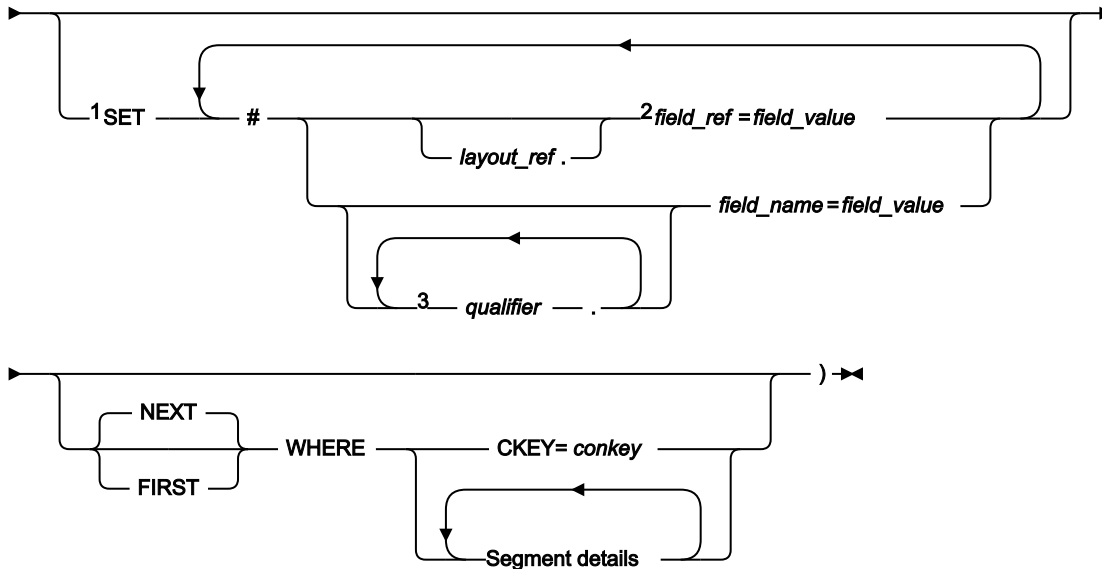

Segment details

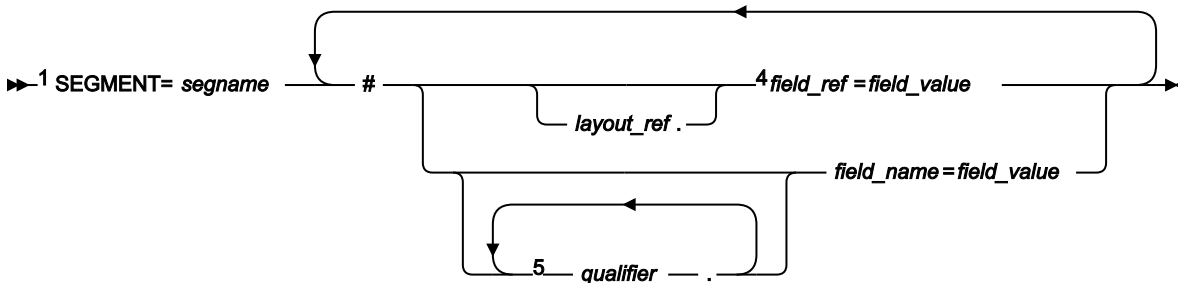

Notes:

- ¹ To use *field_ref* or *field_name*, you must have already loaded a view by preceding this function call with a call to VIEWIMS.
- ² Specification of a *field_ref* without qualification of a *layout_ref* results in the *field_ref* being associated with the current layout for the *repsegm* segment that is being replaced
- ³ To fully qualify a field name, the layout name must be the first *qualifier* specified. If the layout name is not specified, FM/IMS searches the current the layout for the *repsegm* segment being replaced. If the group qualifiers and field name are not found, FM/IMS searches all the layouts for the *repsegm* segment in relative order until the group qualifiers and field name are found. If not found, an error message is displayed and processing terminates.
- ⁴ Specification of a *field_ref* without qualification of a *layout_ref* results in the *field_ref* being associated with the first layout for the *segname* segment.
- ⁵ To fully qualify a field name, the layout name must be the first *qualifier* specified. If the layout name is not specified, FM/IMS searches all the layouts for the *segname* segment in relative order until the group qualifiers and field name are found. If not found, an error message is displayed and processing terminates.

conkey

The concatenated key of the segment you want to update.

field_name

A field name.

field_ref

A field reference number of the field within the layout. This can be obtained by printing the view/template using the VIEWIMS DESCRIBE clause or browsing the view/template online.

field_value

The value of the field specified by *field_ref* or *field_name*.

FIRST

Replaces the first segment in the database that satisfies the WHERE clause.

layout_ref

The relative number of layout within *segname* segment. This can be obtained by printing the view/template using the VIEWIMS DESCRIBE clause.

NEXT

Replaces the next segment in the database after the current segment that satisfies the WHERE clause.

qualifier

One or more qualifiers that identify the field name (*field_name*). The first qualifier is the segment layout name. Subsequent qualifiers (if any) are the group fields used to identify the specified field name.

Omitting the layout name or group fields causes FM/IMS:

- For the SET clause, to search the current *repsegm* segment layout for the specified qualifiers and field name. If not found, then all *repsegm* segment layouts are searched for the specified qualifiers and field name.
- For the WHERE clause, to search all the *segname* segment layouts for the specified qualifiers and field name.



Note: The layout names and group fields can be obtained by printing the view/template using the VIEWIMS DESCRIBE clause or browsing the view/template online.

repsegm

The name of the segment you want to update.

segname

The name of a segment in the hierarchical path of the segment that you want to update.

Returns zero if successful, otherwise nonzero.

If FM/IMS encounters an unavailable HALDB partition or DEDB area, the REPLIMS function receives a return code of 8 and the ISPF variable FMSTATUS indicates an IMS status code of:

FH

an unavailable DEDB area

BA

an unavailable HALDB partition

To update the contents of the current segment, omit the WHERE clause. Otherwise, use the WHERE clause to identify the segment you want to update.

To replace the current contents of the segment with the contents of the OUTREC variable, omit the SET clause. If you are inserting a variable-length segment, then the first two bytes of OUTREC must specify the length of the segment.

Otherwise, use the SET clause to specify replacement field values for the segment.

When you use OUTREC, you replace the entire contents of the segment. When you use the SET clause, you can replace only the field values that you specify; other field values remain unchanged.

IEB example using REPLIMS

```

:
$$FILEM IEB
:
$$FILEM      PROC=*

filerc = VIEWIMS('TPLDSN=FMN.IMS.IVP.TEMPLATE')

filerc = GETIMS('SEGMENT=SUBURB ',
                ' WHERE SEGMENT=SUBURB #SUBURB-NAME=CITY BEACH')

/* Replace a segment using OUTREC */
/* or */
OUTREC = OVERLAY('6168',outrec,19)
filerc = REPLIMS('SEGMENT=SUBURB')
/* or */
/* Replace a segment using SET */

rtrc=REPLIMS('SEGMENT=SUBURB ',
             'SET #POST-CODE=6168',
             ' WHERE SEGMENT=SUBURB #SUBURB-NAME=CITY BEACH')

/+
:

```

SAVEIMS CALL (Commit IMS changes)

Figure 164. Syntax

►► SAVEIMS() ◄◄

Notes:

Returns zero if successful, otherwise nonzero.

IEB example using SAVEIMS

```

:
$$FILEM IEB
:
$$FILEM      PROC=*

filerc = GETIMS('SEGMENT=SUBURB NEXT',

OUTREC = OVERLAY('1968',outrec,19)
filerc = REPLIMS('SEGMENT=SUBURB')
filerc = SAVEIMS()
:

```

SETRC CALL (Set Job Step return code)

The IEB call sets the Job Step return code to the value specified. It does not cause FM/IMS to exit the REXX procedure.

The format of the call is:

Figure 165. Syntax

► SETRC (*rc*) ◄

rc

Return code.

IEB example using SETRC

```

RTRC=GETIMS(USING_VIEW)
IF RTRC<>0 THEN DO
  SETRC(21)
  EXIT
END

```

VIEWIMS CALL (Load or create a view)

Figure 166. Syntax (to load an existing view or template)

► VIEWIMS ((VIEWDSN= *viewdsn* | VIEWDD= *viewdd* | VIEWMBR= *viewmem* | DESCRIBE | TPLDSN= *tpldsn* | TPLDD= *tpldd*)) ◄

Figure 167. Syntax (to create a new view from an existing template)

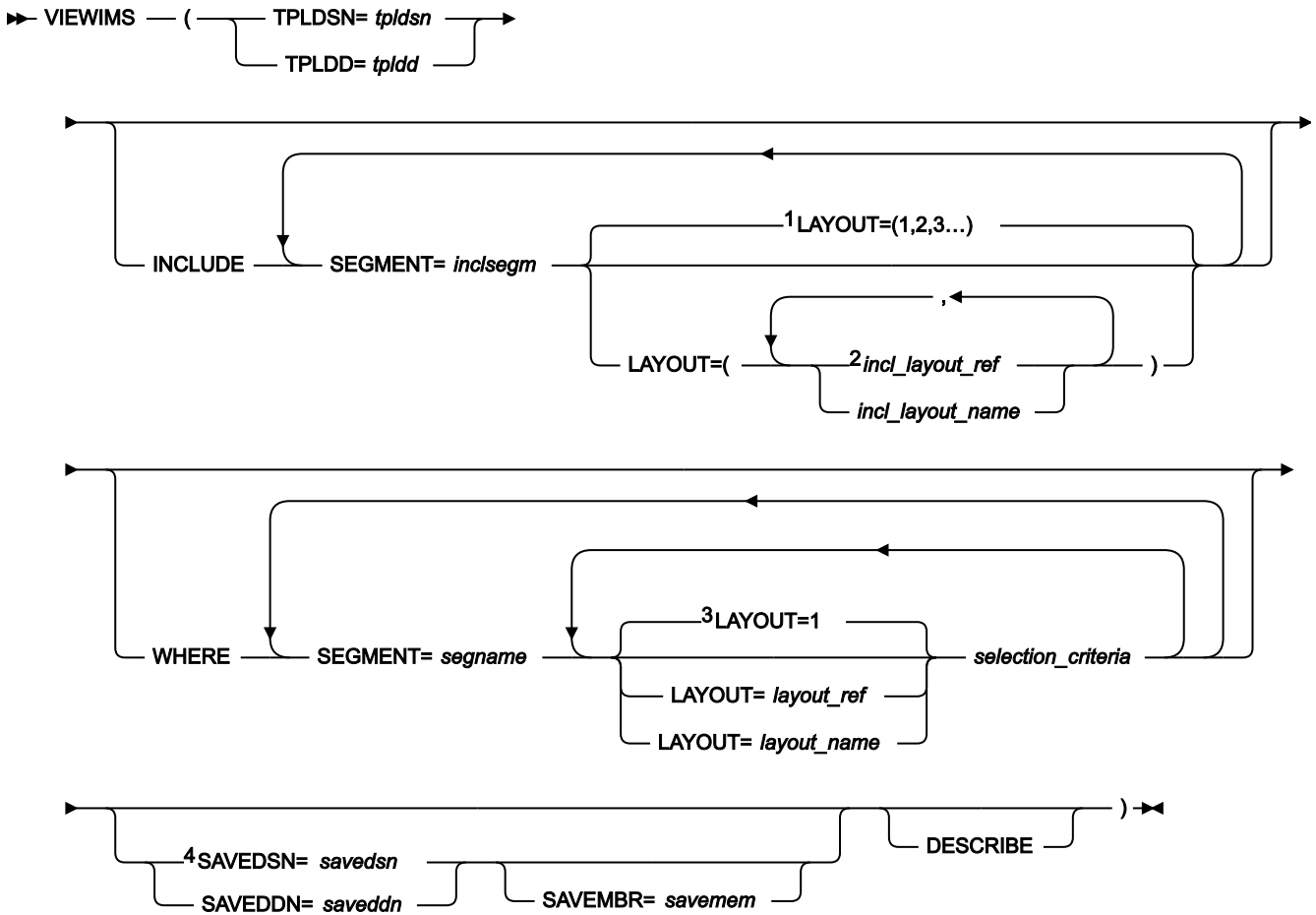

Notes:

- ¹ If no layout parameter is specified, all layouts for *inclsegm* are selected.
- ² If only one *incl_layout_ref* or *incl_layout_name* is specified, the parentheses are not required.
- ³ If no layout parameter is specified, then the selection criteria applies to the first layout for the *segname* segment.
- ⁴ The old format of SAVE is still supported (SAVE DSN=*savedsn* or SAVE DDN=*saveddn* with, optionally, MBR=*savembr*).

If you specify the DESCRIBE parameter, then VIEWWIMS prints a report showing the structure of the view or template for each segment in the database.

incl_layout_name

The name of the *inclsegm* segment layout to be selected in the view. You can obtain this by printing the view/template with the VIEWWIMS DESCRIBE clause or browsing the view/template online.

incl_layout_ref

The relative number of the layout within the *inclsegm* segment that is selected in the view. You can obtain this by printing the view/template with the VIEWWIMS DESCRIBE clause.

inclsegm

The name of a segment to be included in the view.

If you call the GETIMS function with the USING_VIEW parameter, only the segment that is included in the view is retrieved. If you omit the INCLUDE clause entirely, all segments are included in the view.

layout_name

The name of the layout within the *segname* segment to which the selection criteria are to apply. This can be obtained by printing the view/template using the VIEWIMS clause or browsing the view/template online.

layout_ref

The relative number of the layout within a segment to which the selection criteria are to apply. This can be obtained by printing the view/template using the VIEWIMS DESCRIBE clause.

savedd

The DDNAME containing the data set into which the view is to be saved. If the data set is a PDS, you must also specify the SAVEMBR=*savemem* parameter.

savedsn

The name of the data set into which the view is to be saved. If the data set is a PDS, you must also specify the MBR=*savemem* parameter.

savemem

The member of the PDS specified by the DSN, SAVEDSN, DDN, or SAVEDDN parameter into which the view is to be saved.

segname

The name of a segment for which you want to specify field selection criteria.

selection_criteria

Field selection criteria for the *segname* segment. Determines which segment occurrences are retrieved by calls to the GETIMS function with the USING_VIEW parameter.

For details on specifying field selection criteria, see [Specifying field selection criteria on page 115](#).

tpldd

The DDNAME containing the template data set that is used as a basis to create a view. The template for the DBD must have already been created on-line in FM/IMS.

tpldsn

The name of the data set containing the template that is used as a basis to create a view. The template for the DBD must have already been created on-line in FM/IMS.

viewdd

The DDNAME containing one of the following:

- The sequential data set containing the view.
- The PDS containing the view. You then specify the member name in *viewmem*.

viewdsn

One of:

- The name of the sequential data set containing the view.
- The name of the PDS containing the view. (You then specify the member name in *viewmem*.)

viewmem

The member name of the view.

IEB example using VIEWIMS

```

:
$$FILEM IEB
:
$$FILEM      PROC=*
rtrc=VIEWIMS('TPLDSN=FMN.IMS.IVP.TEMPLATE ',
  'SAVE      DSN=FMN.IMS.IVP.VIEW MBR=ZZ999 ',
              'INCLUDE  SEGMENT=SUBURB ',
              '          SEGMENT=LINKSTR ',
              'WHERE    SEGMENT=SUBURB substr(#2,1,1)=F ',
              '          SEGMENT=LINKSTR #4=ST ',
              'DESCRIBE')
/+
:

```

Example

Here is an example of maintaining an IMS database in DLI mode using a static PSB.

```

//FMNIEDIT 'Static PSB edit'
//*
//FILEMAN  EXEC PGM=FMN1IMSB
//STEPLIB DD DSN=FMN.SFMNMOD1,DISP=SHR
//SYSPRINT DD SYSOUT=*,RECFM=FBA,LRECL=133
//FMNTSPRT DD SYSOUT=*
//FMNIJIN  DD DISP=SHR,DSN=FMN.SFMNSLIB
//FMNIMSIN DD *
$$FILEM IEB REGNTYPE=DLI,
$$FILEM   PSBTYPE=STATIC,
$$FILEM   PSBDSN=IMSV1210.FMI.PSBLIB,
$$FILEM   PSBMEM=PUPA,
$$FILEM   PCBNUM=(3,2,1),
$$FILEM   DBDDSN=FMN.IMS.IVP.DBDLIB,
$$FILEM   DBDDSN2=IMSV1210.FMI.DBDLIB,
$$FILEM   DBDMEM=DJ2E,
$$FILEM   IMSID=IF42,
$$FILEM   PROC=*
filerc = VIEWIMS('TPLDSN=FMN.IMS.IVP.TEMPLATE')
filerc = VIEWPOSN('POSSEGM=NSTREET ',
                  'SEGMENT=SUBURB #SUBURB-NAME=CITY BEACH ',
                  'SEGMENT=NSTREET #2=FLOREAT BEACH ')

```

```

filerc = GETIMS(NEXT USING_VIEW)

/* Insert an NSTREET segment using SET */
filerc = ISRTIMS('SEGMENT=NSTREET ',
                ' SET #2=FLOREAT PARK ')

/+
/*
/** -----
/** -- Database data sets                               --
/** -----
//DJ2E DD DSN=FMN.IVS.IVP.DB.DJ2E,DISP=SHR
//DJ2F DD DSN=FMN.IVS.IVP.DB.DJ2F,DISP=SHR
//DJ3E DD DSN=FMN.IVS.IVP.DB.DJ3E,DISP=SHR
//DJ3F DD DSN=FMN.IVS.IVP.DB.DJ3F,DISP=SHR
//DJ1E DD DSN=FMN.IVS.IVP.DB.DJ1E,DISP=SHR
//DJ1F DD DSN=FMN.IVS.IVP.DB.DJ1F,DISP=SHR

```

General tips for using the REXX functions defined by IEB and IBB

Rather than repeating this information under each function description, here are some general tips:

What is the "current" segment?

Several of the function descriptions refer to the "current" segment. This is the segment most recently retrieved, inserted or replaced by a GETIMS, ISRTIMS or REPLIMS function.

Locating a segment by specifying its key values

With the DELIMS, GETIMS, ISRTIMS and REPLIMS functions, you can use a WHERE clause to locate a segment according to its key values. On the WHERE clause, you can specify one of:

- A complete concatenated key as a single parameter, CKEY.
- The segment names and key fields for one or more levels in the hierarchical path of the segment you want, as separate parameters.

For example, given the following segment hierarchy:

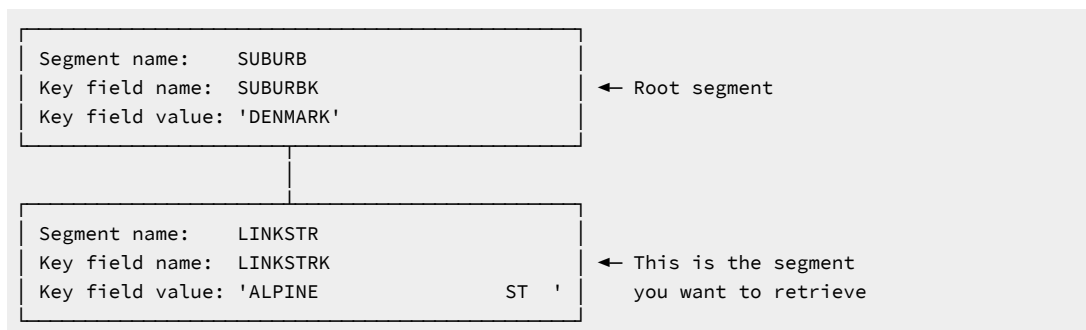

then you would specify:

```

GETIMS('SEGMENT=LINKSTR ',
      'WHERE SEGMENT=SUBURB #SUBURBK=DENMARK ',
      'SEGMENT=LINKSTR #LINKSTRK=ALPINE          ST')

```

You do not have to specify all the segments in the hierarchical path. If, for example, there is only one LINKSTR segment with the key 'ALPINE ST ' in the entire database, you can specify:

```
GETIMS('SEGMENT=LINKSTR',
      'WHERE SEGMENT=LINKSTR #LINKSTRK=ALPINE          ST')
```

If 'ALPINE ST ' is the first or only LINKSTR segment under the SUBURB segment with a key of DENMARK, you can specify:

```
GETIMS('SEGMENT=LINKSTR',
      'WHERE SEGMENT=SUBURB #SUBURBK=DENMARK')
```

You can specify the fields using either the field names (as in the previous examples) or their reference numbers (such as #1, #2). Field values can be placed directly after the equals (=) sign or inside quotation marks after the = sign. Quotation marks are required if the field value contains leading or trailing spaces which would otherwise be ignored. In this way:

```
GETIMS('SEGMENT=LINKSTR',
      'WHERE SEGMENT=LINKSTR #LINKSTRK=ALPINE          ST')
```

and

```
GETIMS('SEGMENT=LINKSTR',
      'WHERE SEGMENT=LINKSTR #LINKSTRK=  ALPINE          ST  ')
```

are evaluated as identical, but

```
GETIMS('SEGMENT=LINKSTR',
      'WHERE SEGMENT=LINKSTR #LINKSTRK="  ALPINE          ST  "')
```

is evaluated differently.

To list these reference numbers, you can use either the FM/IMS ISPF panels to browse the template for this DBD, or the VIEWIMS DESCRIBE REXX function with IEB.

You can mix field names and reference numbers in the same WHERE clause.

Before you can use this type of WHERE clause, you must call the VIEWIMS function, and load a template or view that matches the DBD you are using. This enables the WHERE clause to match the field names or reference numbers with the appropriate fields in the IMS segments.

When the WHERE clause is on a GETIMS, DELIMS or REPLIMS call, you may specify the FIRST parameter or NEXT parameter before it. When the FIRST parameter is specified, the call locates the first segment in the database that satisfies the WHERE clause. When the NEXT parameter is specified, the call locates the next segment in the database after the current segment that satisfies the WHERE clause. The default is NEXT.

When the WHERE clause is on an ISRTIMS call, the call locates the first segment in the database that satisfies the WHERE clause.

Referring to a previous current segment

The FMCONKEY REXX variable contains the concatenated key of the segment deleted, retrieved, inserted or replaced by the previous DELIMS, GETIMS, ISRTIMS or REPLIMS function call. Similarly, the FMSEGNM REXX variable contains the name of that segment.

If you need to use the FMCONKEY and FMSEGNM values later, you can save them in your own defined variables. These user defined variables can then be used with the SEGMENT and CKEY parameters.

Use of the filerc variable

A variable called 'filerc' is used in several examples. This method is used to get hold of the REXX return code which can be used for testing. You can call the variable any valid REXX name. You can use different names for different statements or you do not need to use a variable at all if you are not going to use the return code.

This variable does not hold the DL/I status code. FMSTATUS is designed for this purpose.

Batch Browse (IBB)

Purpose

Runs a REXX procedure that can display or print segments from a data base. In addition to using any other valid REXX in this procedure, IBB defines some new REXX functions that you can use to retrieve or print segments, or to create a view.

Usage notes

For general tips for using IBB, see [General tips for using the REXX functions defined by IEB and IBB on page 629](#). For note about the use of the filerc variable, see [Use of the filerc variable on page 631](#).

The Batch Browse JCL generated by FM/IMS has the following flows:

Figure 168. Flows for Batch Browse (IBB) step

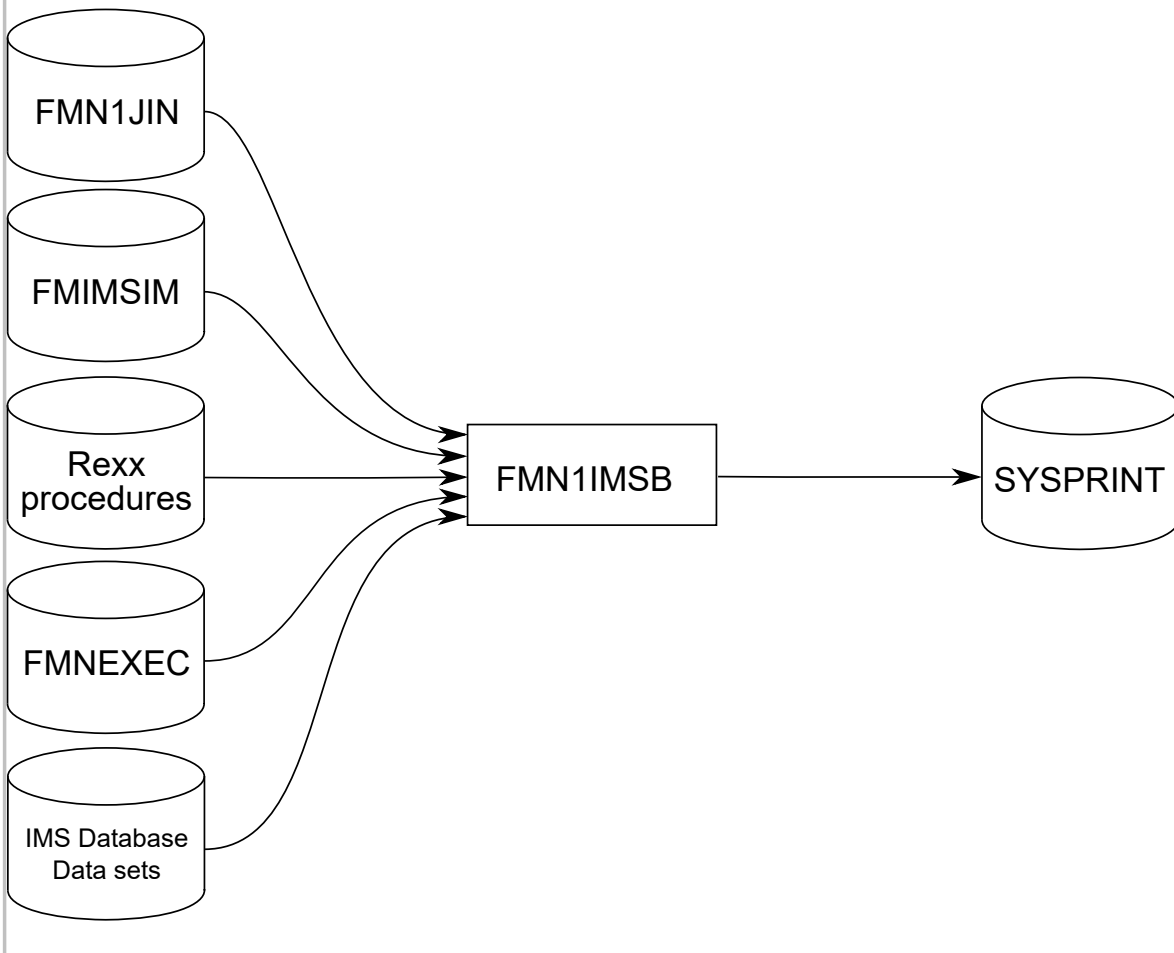

FMN1JIN

Points to the FM/IMS skeleton library. This DD statement is only used when you are browsing HALDB databases.

FMNIMSIN

Contains the control statements for the batch browse. These control statements are discussed below.

IMS database data sets

In DLI mode, FM/IMS includes DDs for each of the IMS database data sets associated with the IMS database being maintained. If the database has logical relationships, the data sets for the logically related databases need to be included.

SYSPRINT

This contains the FM/IMS messages that were issued by FM/IMS while running the IEB REXX procedure.

REXX Procedure

A REXX exec which is to be run to view the IMS database in batch. This exec consists of standard REXX statements combined with FM/IMS IEB calls to allow you to read the IMS segments.

In FMNIMSIN, if PROC=* is specified, then the REXX procedure is specified instream after the PROC=* parameter.

In FMNIMSIN, if PROC=<member> is specified, then the REXX procedure <member> found in the FMNEXEC library is run.

FMNEXEC

This contains the member that is run if PROC=<member> is specified in the FMNIMSIN parameters.

FMNIMSIN control statements

You use the FMNIMSIN control statements to specify:

- If the Batch Browse is to run in a BMP or DLI region.
- Whether to use a static PSB, or if FM/IMS is to generate a dynamic PSB to view the IMS data.
- Whether the IBB REXX procedure to be run is instream (PROC=*), or can be found in the library specified on the FMNEXEC DD.

Each line in FMNIMSIN starts with a \$\$FILEM and the first line contains the parameter IBB to specify that FM/IMS is performing Batch Browse.

```

$$FILEM IBB REGNTYPE=DLI,
$$FILEM PSBTYPE=DYNAMIC,
$$FILEM DBDDSN=FMN.IMS.IVP.DBDLIB,
. . .

```

Figure 169. Syntax

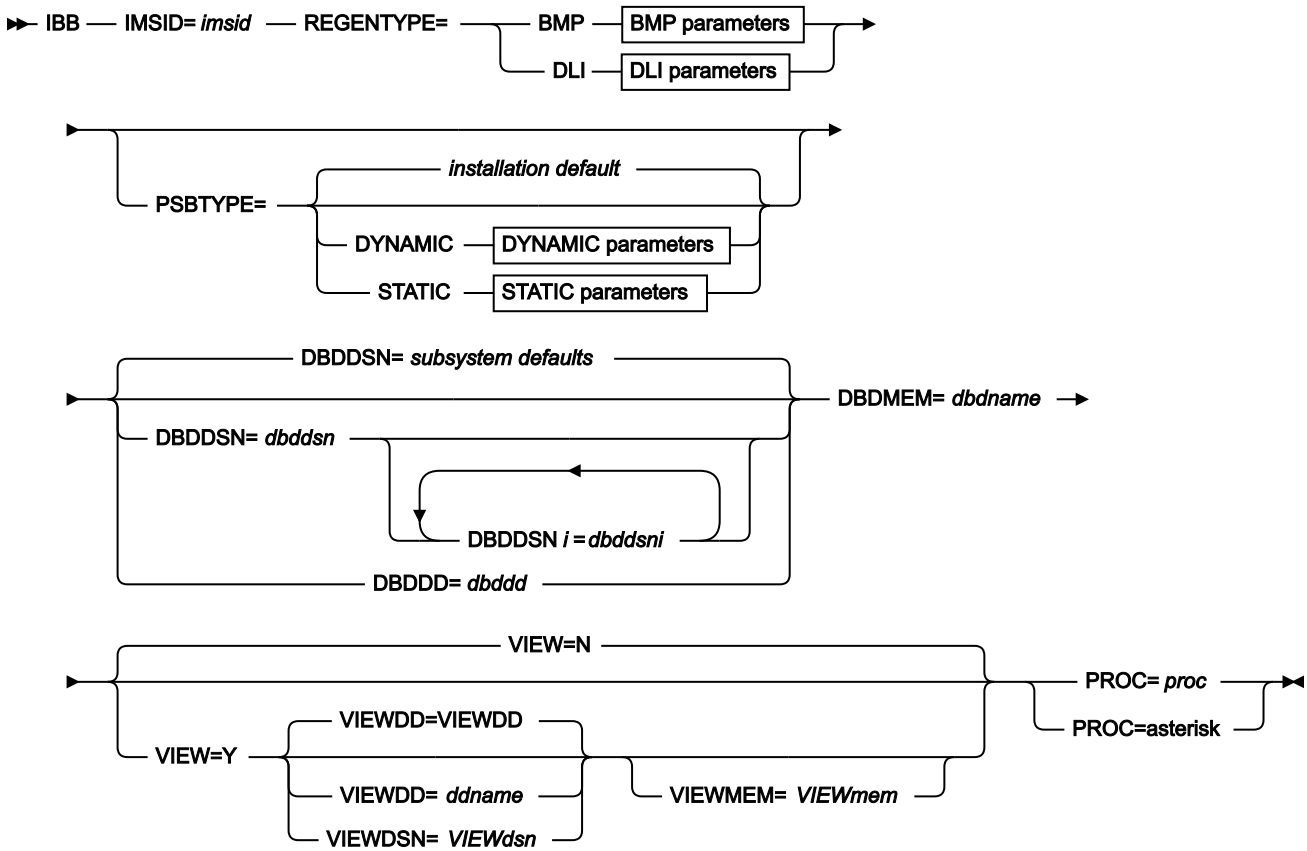

BMP parameters

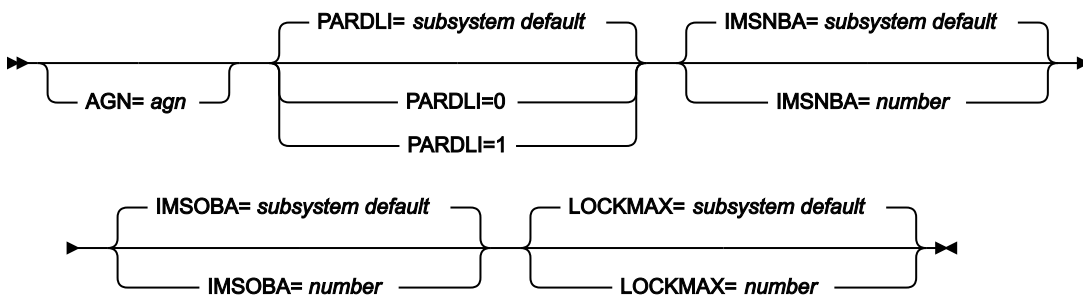

DLI parameters

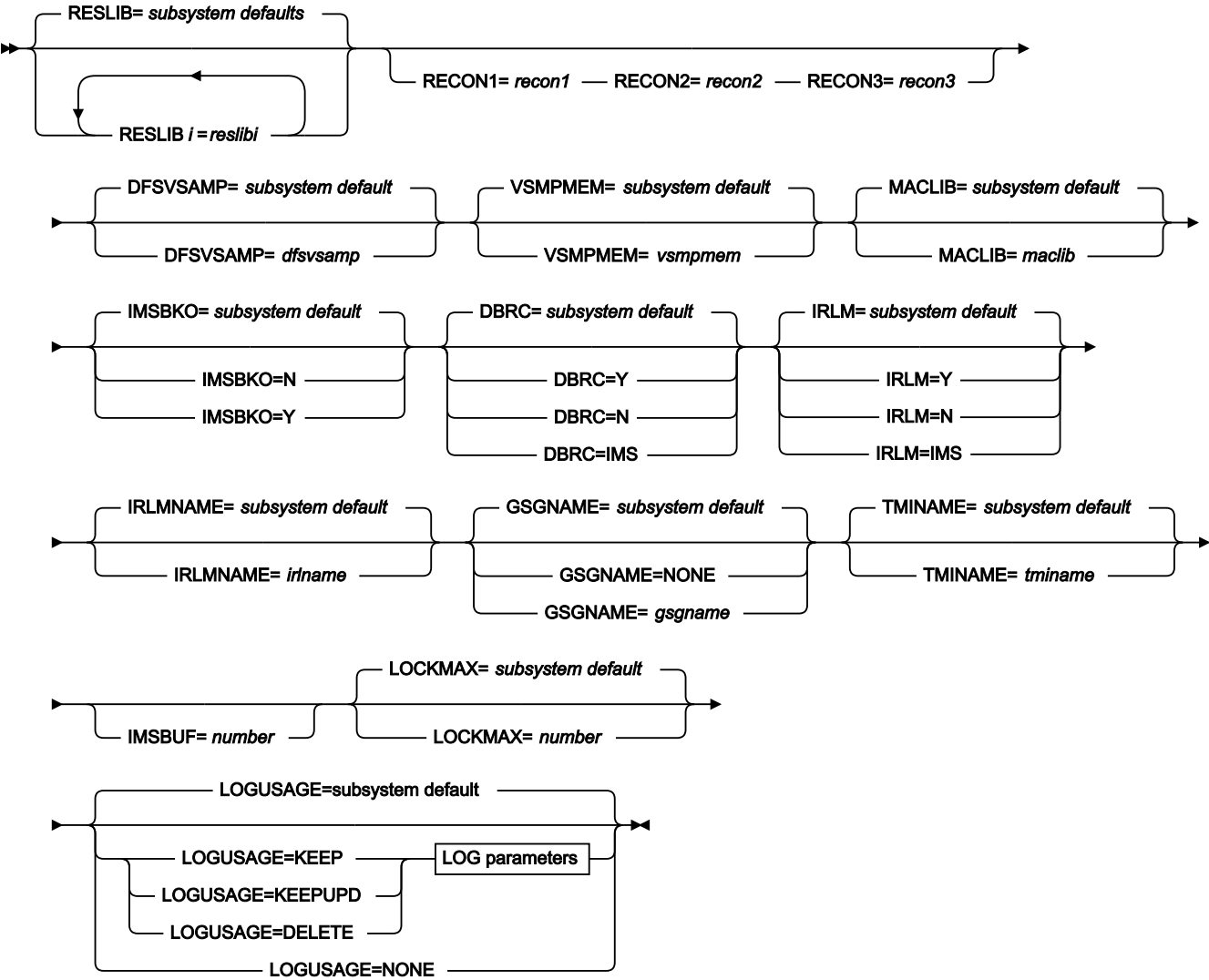

LOG parameters

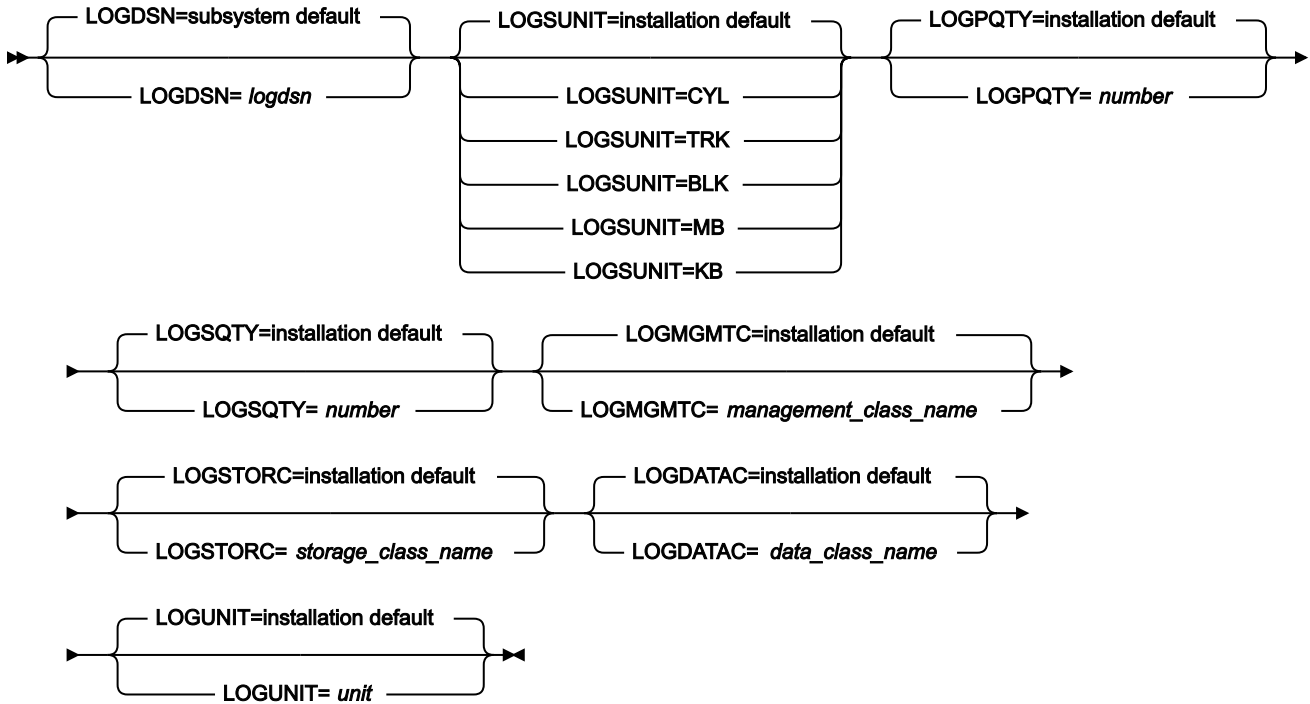

DYNAMIC parameters

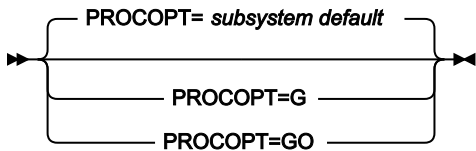

STATIC parameters

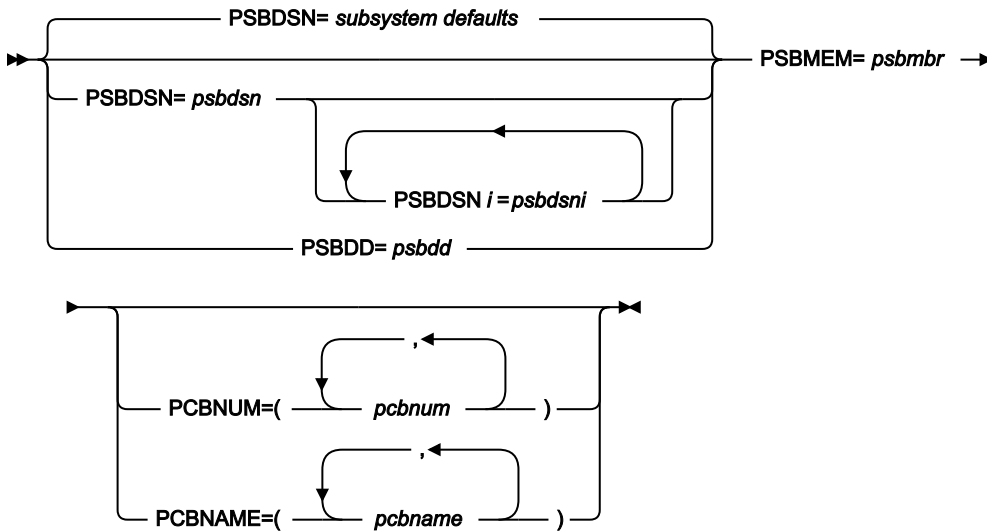

The VIEW, VIEWDD, VIEWDSN, VIEWMEM, and PROC parameters are described here. All the other parameters in this syntax diagram can also be specified for the Extract (IXB) function. For a description of these common parameters, see [Extract \(IXB\) on page 539](#).

VIEW

Optional parameter. Specifies whether or not the Batch Browse uses a view.

N

The Batch Browse does not use a view.

Y

The Batch Browse uses a view. If Y is specified, you must specify the view that is to be used as outlined in the VIEWDD, VIEWDSN, and VIEWMEM entries.

VIEWDD=ddname

Identifies the DD statement for the sequential data set or PDS(E) and member that contains the view you want the Batch Browse to use. The default is VIEWDD.

VIEWDSN=viewdsn

The name of the data set that contains the view that you want your Batch Browse to use. You may specify a sequential data set or a PDS(E). If you specify a PDS(E), the parameter may also include a member name in parentheses.

VIEWMEM=viewmem

Required when the VIEWDSN or VIEWDD parameter specifies a PDS(E) and does not specify the member. Specifies the member of the PDS(E) that contains the view you want the Batch Browse to use.

PROC=proc

Required parameter. Valid values are:

The name of a PDS(E) member

The name of the PDS(E) member containing the REXX procedure that you want the Batch Browse to use.

You specify the PDS(E) containing this member in the FMNEXEC DD statement. The JCL for the batch edit must include this DD statement.

An asterisk (*)

Indicates that the REXX procedure is inline.

The procedure is read from SYSIN immediately after the FMNIMSIN control statements. The inline procedure is terminated by a record containing a slash and a plus sign (/+) in columns 1 - 2.

REXX IBB calls

The REXX procedure that FM/IMS invokes uses standard TSO/E REXX.

However, you can call IBB functions to be able to retrieve and print the IMS segments. You can also create FM/IMS view for use in the IBB REXX procedure.

When running this REXX procedure and calling IBB functions, you process the database either using a File Manager/IMS view or by issuing IMS calls. FM/IMS does not allow you to swap between using a view and not using a view.

By referencing or creating a view using the IBB VIEWIMS function and issuing a GETIMS with the USING_VIEW parameter, FM/IMS uses the selection criteria specified in the view to retrieve the relevant segment.

When not using a view, you have to navigate the database by issuing a GETIMS call to retrieve the relevant segments. This method is similar to issuing IMS calls in a program. You need to determine how the segments are to be retrieved.

Retrieval using a view

The following IBB calls are available when processing the database using a view. The syntax is the same as for Batch Edit.

GETIMS CALL (Retrieve an IMS segment)

See [GETIMS CALL \(Retrieve an IMS segment\) on page 599](#).

PRINT CALL (Print an IMS segment)

See [PRINT CALL \(Print an IMS segment\) on page 602](#).

SETRC CALL (Set Job Step return code)

See [SETRC CALL \(Set Job Step return code\) on page 605](#).

VIEWIMS CALL (Load or create a view)

See [VIEWIMS CALL \(Load or create a view\) on page 606](#).

VIEWPOSN CALL (Position on an IMS segment)

See [VIEWPOSN CALL \(Position on an IMS segment\) on page 609](#).

Retrieval without a view

The following IBB calls are available when processing the database without using a view. The syntax is the same as for Batch Edit, except where noted.

A view may be loaded to allow the WHERE clause to specify key fields, or to print the database in SNGL or TABL format but the GETIMS call is issued without the USING_VIEW parameter.

GETIMS CALL (Retrieve an IMS segment)

The same as for Batch Edit, except that the HOLD parameter is not available. See [GETIMS CALL \(Retrieve an IMS segment\) on page 615](#).

PRINT CALL (Print an IMS segment)

See [PRINT CALL \(Print an IMS segment\) on page 620](#).

SETRC CALL (Set Job Step return code)

See [SETRC CALL \(Set Job Step return code\) on page 625](#).

VIEWIMS CALL (Load or create a view)

See [VIEWIMS CALL \(Load or create a view\)](#) on page 625.

Example

Here is an example of maintaining an IMS database in DLI mode using a static PSB.

```

FMNIBRWS 'Static PSB browse'
/**
//FILEMAN EXEC PGM=FMN1IMSB
//STEPLIB DD DSN=FMN.SFMNMOD1,DISP=SHR
//SYSPRINT DD SYSOUT=*,RECFM=FBA,LRECL=133
//FMNTSPRT DD SYSOUT=*
//FMN1JIN DD DISP=SHR,DSN=FMN.SFMNSLIB
//FMNIMSIN DD *
$$FILEM IBB REGNTYPE=DLI,
$$FILEM PSBTYPE=STATIC,
$$FILEM PSBDSN=IMSV1210.FMI.PSBLIB,
$$FILEM PSBMEM=PUPA,
$$FILEM PCBNUM=(3,2,1),
$$FILEM DBDDSN=FMN.IMS.IVP.DBDLIB,
$$FILEM DBDDSN2=IMSV1210.FMI.DBDLIB,
$$FILEM DBDMEM=DJ2E,
$$FILEM IMSID=IF42,
$$FILEM PROC=*
filerc = VIEWIMS('TPLDSN=FMN.IMS.IVP.TEMPLATE')
filerc = VIEWPOSN('POSSEGM=NSTREET ',
                  'SEGMENT=SUBURB #SUBURB-NAME=CITY BEACH ',
                  'SEGMENT=NSTREET #2=FLOREAT BEACH ')

Do while filerc=0
  filerc = GETIMS(NEXT USING_VIEW)
  PRINT(INREC,TABL)
END

/+
/*
/* -----
/* -- Database data sets --
/* -----
//DJ2E DD DSN=FMN.IMS.IVP.DB.DJ2E,DISP=SHR
//DJ2F DD DSN=FMN.IMS.IVP.DB.DJ2F,DISP=SHR
//DJ3E DD DSN=FMN.IMS.IVP.DB.DJ3E,DISP=SHR
//DJ3F DD DSN=FMN.IMS.IVP.DB.DJ3F,DISP=SHR
//DJ1E DD DSN=FMN.IMS.IVP.DB.DJ1E,DISP=SHR
//DJ1F DD DSN=FMN.IMS.IVP.DB.DJ1F,DISP=SHR

```

Initialize (DIB)**Purpose**

The Initialize dialog generates JCL that runs the Initialize (DIB) function. The Initialize function initializes databases.

Usage notes

The Batch database initialization JCL created by FM/IMS has the following flows:

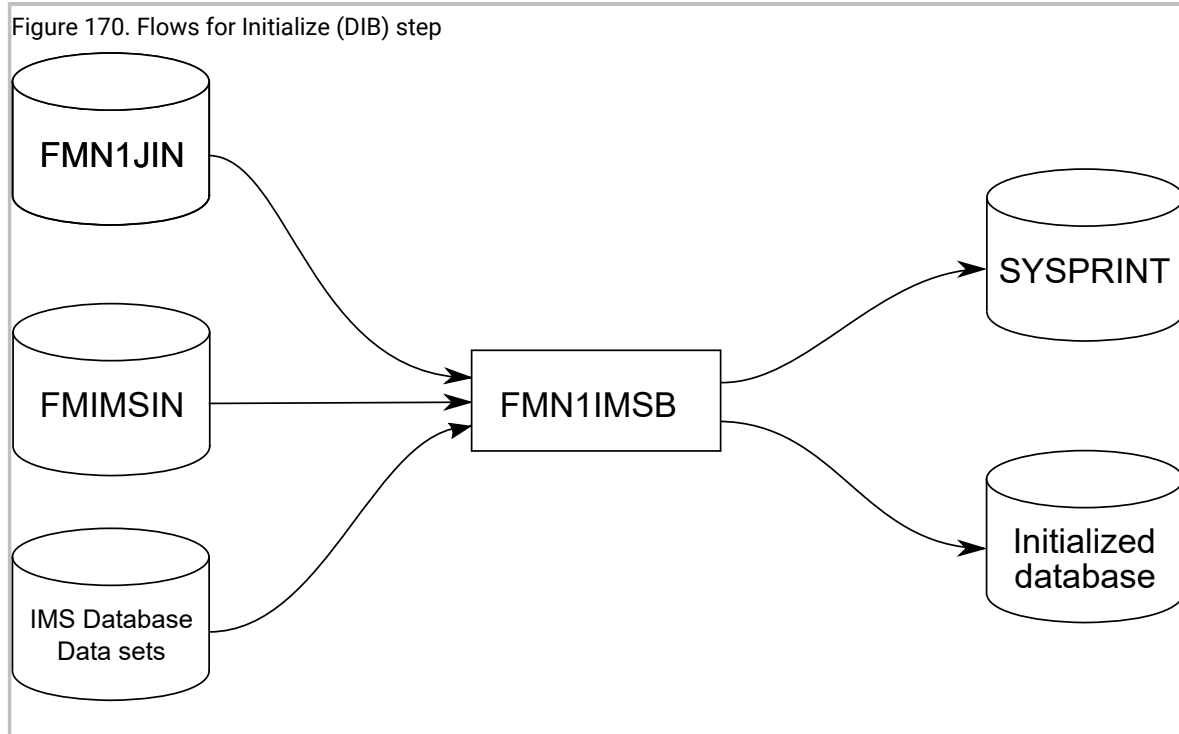

FM/IMS can initialize the IMS database data sets associated with an IMS database.

If you select Delete/Define IMS data sets on the Initialize Entry panel FM/IMS retrieves the data set information of the data sets listed on the Database Data Set Specification panel and builds JCL to delete or define these data sets.

The Initialize utility can be executed for these types of IMS databases:

Full function

- HDAM, Hierarchical Direct Access Method
- HIDAM, Hierarchical Index Direct Access Method
- HISAM, Hierarchical Index Sequential Access Method
- SHISAM, Simple Hierarchical Index Sequential Access Method
- HSAM, Hierarchical Sequential Access Method
- SHSAM, Simple Hierarchical Sequential Access Method

The Initialize process for a full function database depends on whether the database has secondary indexes, logical relationships or neither.

The simplest steps to initialize a full function database are:

1. Database initialization, insert a dummy segment.
2. Delete the dummy segment.

If the database has logical relationships the steps are:

1. Delete work datasets.
2. IMS Preorganisation Utility (DFSURPR0)
3. Database initialization, insert a dummy segment
4. IMS Database Prefix Resolution Utility (DFSURG10)
5. IMS Database Prefix Update Utility (DFSURGP0)
6. Delete the dummy segment.
7. Delete work datasets.

If the database has secondary indexes the steps are:

1. 1. Delete work datasets.
2. IMS Preorganisation Utility (DFSURPR0)
3. Database initialization, insert a dummy segment.
4. IMS Database Prefix Resolution Utility (DFSURG10)
5. HISAM Reorganization Unload Utility (DFSURUL0)
6. HISAM Reorganisation Load Utility (DFSURRL0)
7. Delete the dummy segment.
8. Delete work datasets.

Fast Path

- DEDB, Data Entry Database (Fast Path)

For a **DEDB** the IMS Utility DBFUMIN0 is used to initialize the areas.

HALDBs

- PHDAM, Partitioned Hierarchical Direct Access Method (HALDB)
- PHIDAM, Partitioned Hierarchical Index Direct Access Method (HALDB)

For a **HALDB** database the steps to initialize the database are:

1. Delete Work data sets.
2. Set the master HALDB database to PINIT (DSPURX00).
3. Initialize the HALDB partitions: IMS Preorganisation Utility (DFSURPR0)
4. Generate IMS image copy (DSPURX00) only if "Submit image copy" has been selected.
Please note that the HALDB partitions are not available until an image copy has been run.
5. Delete Work data set.

FMNIMSIN

Contains the control statements for the Initialize. These control statements are discussed below.

IMS database data sets

In DLI mode, FM/IMS includes DDs for each of the IMS database data sets associated with the IMS database being printed. If the database has logical relationships, the data sets for the logically related databases need to be included.

SYSPRINT

This contains the FM/IMS messages that were issued by FM/IMS while extracting the IMS data, as well as the printed IMS segments.

FMN1JIN

Points to the FM/IMS skeleton library. This DD statement is only used when you are initializing HALDB databases.

FMNIMSIN control statements

You use the FMNIMSIN control statements to specify the databases the function is to initialize. The function can only be run in DLI mode, and always uses a dynamic PSB.

Each line in FMNIMSIN starts with a \$\$FILEM and the first line contains the parameter DIB to specify that FM/IMS will initialize a database.

```
$$FILEM DIB REGNTYPE=DLI,  
  $$FILEM DBDDSN=FMN.IMS.IVP.DBDLIB,  
  . . .
```

Figure 171. Syntax

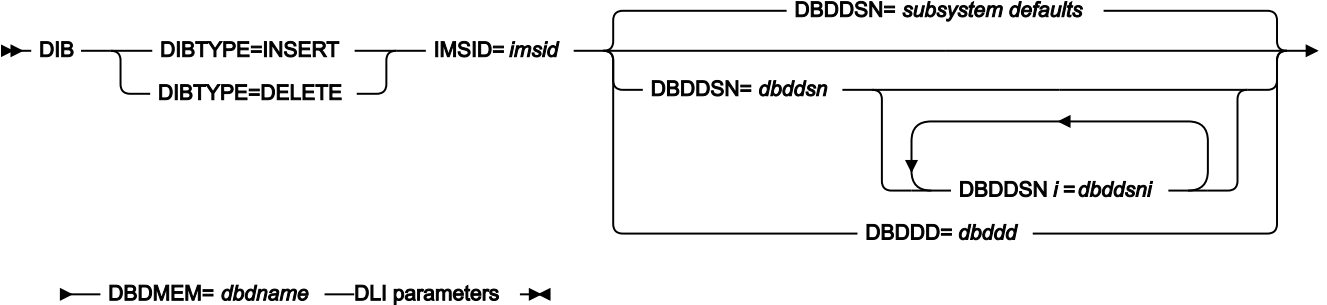

DLI parameters

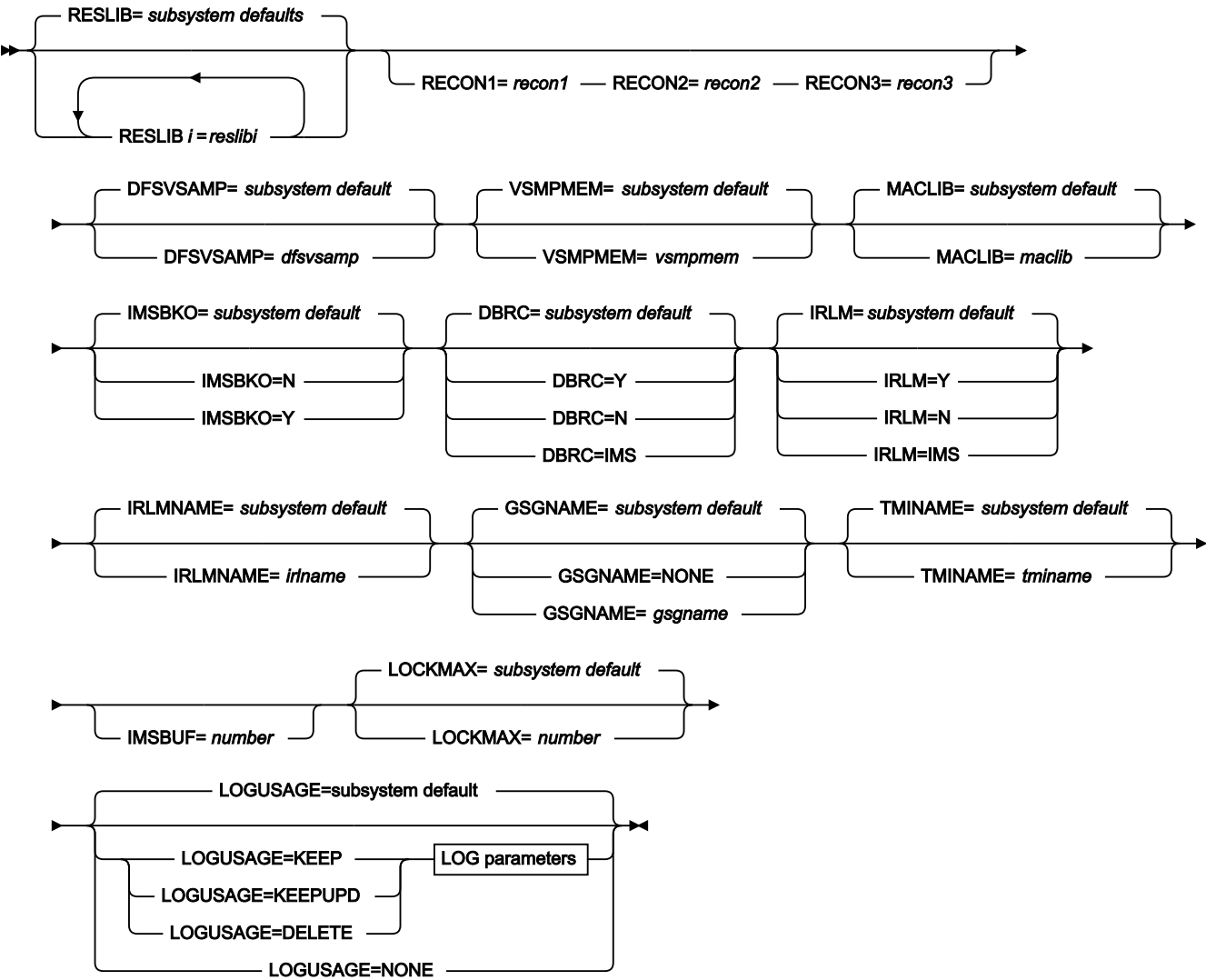

LOG parameters

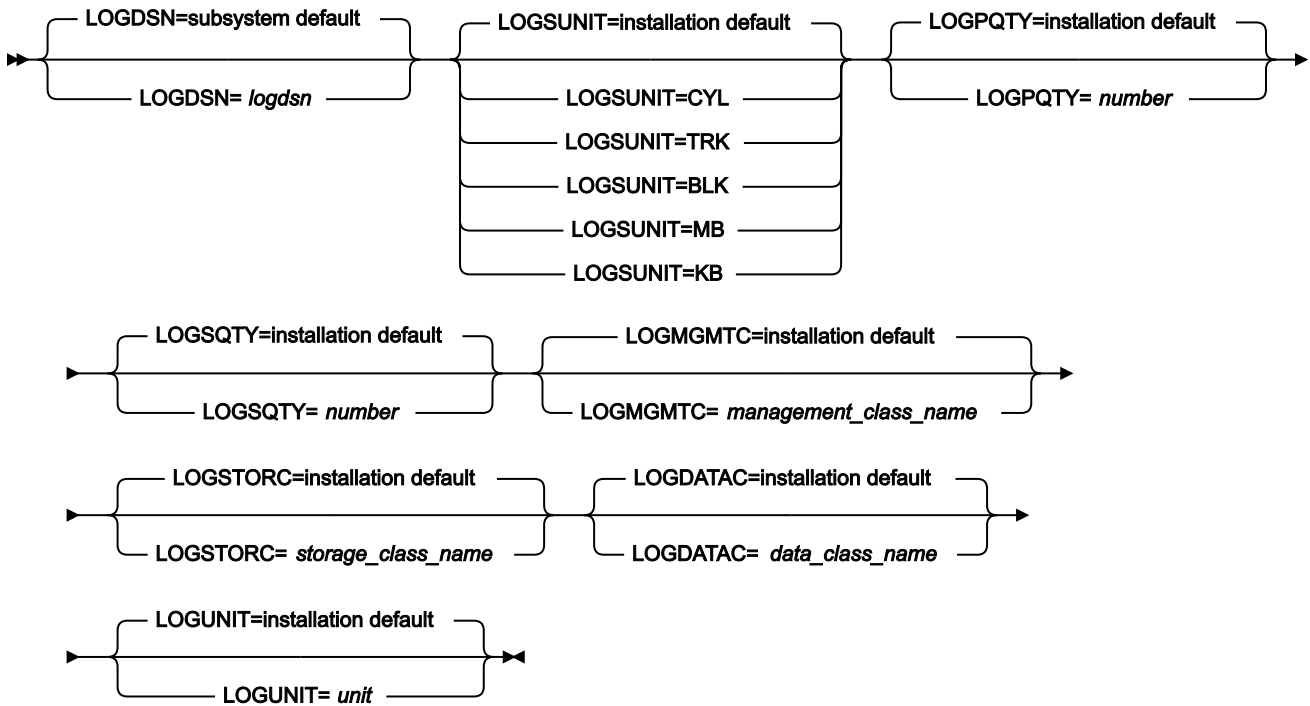

The DIBTYPE parameter is described here. For a description of the other common parameters in this syntax diagram, see [Extract \(IXB\) on page 539](#).

DIBTYPE

The Initialize step to be run.

INSERT

Specifies a step that inserts a dummy segment into the database.

DELETE

Specifies a step that deletes the dummy segment from the database.



Note: To successfully run the Initialize (DIB) function the specified IMS subsystem must allow the use of both dynamic PSBs and DL/I batch processing regions.

Example

Here is an example of the generated JCL for initializing a HDAM/OSAM database without logical relations or secondary indexes. You can also initialize such databases and all necessary JCL will be generated.

```

//* -----
//*
//*      Delete/Define Database Data Sets
//*
//* -----

```

```

//*
//PSDELETE EXEC PGM=IEFBR14
//HDOU DD DSN=FMN.IMS.HDOU,
//      DISP=(OLD,DELETE)
//*
//PSALLOC EXEC PGM=IEFBR14
//HDOU DD DSN=FMN.IMS.HDOU,
//      DISP=(NEW,CATLG,DELETE),
//      SPACE=(TRK,(1,1)),
//      DCB=(RECFM=FBS,LRECL=2048,BLKSIZE=2048),
//      DSORG=PS,
//      MGMTCLAS=MCFM,
//      UNIT=3390,
//      STORCLAS=SCFM
/*
/*
/* -----
/*
/*      LOAD - INSERT DUMMY RECORDS
/*
/* -----
/*
//TESTRC   IF (RC LE 4) THEN
//FILEMAN  EXEC PGM=FMN1IMSB
//STEPLIB DD DSN=FMN.SFMNMOD1,DISP=SHR
//SYSPRINT DD SYSOUT=*,RECFM=FBA,LRECL=133
//FMNTSPRT DD SYSOUT=*
//FMN1JIN DD DSN=FMN.SFMNSLIB,DISP=SHR
//SYSTEM  DD SYSOUT=*
//FMNIMSIN DD *
$$$FILEM DIB DIBTYPE=INSERT,
$$$FILEM DBDDSN=FMN.IMS.IVP.DBDLIB,
$$$FILEM DBDMEM=HDOU,
$$$FILEM IMSID=IF52
/*
//IEFRDER DD DUMMY
/* -----
/* -- Database datasets --
/* -----
//HDOU DD DSN=FMN.IMS.HDOU,DISP=SHR
//ENDRC   ENDIF
/*
/* -----
/*
/*      DELETE DUMMY RECORDS
/*
/* -----
/*
//TESTRC   IF (RC LE 4) THEN
//FILEMAN  EXEC PGM=FMN1IMSB
//STEPLIB DD DSN=FMN.SFMNMOD1,DISP=SHR
//SYSPRINT DD SYSOUT=*,RECFM=FBA,LRECL=133
//FMNTSPRT DD SYSOUT=*
//FMN1JIN DD DSN=FMN.SFMNSLIB,DISP=SHR
//SYSTEM  DD SYSOUT=*
//FMNIMSIN DD *
$$$FILEM DIB DIBTYPE=DELETE,
$$$FILEM DBDDSN=FMN.IMS.IVP.DBDLIB,

```

```

$$$FILEM      DBDMEM=HDOU,
$$$FILEM      IMSID=IF52
/*
//IEFRDER DD DSN=&&LOGD,
//          UNIT=SYSALLDA,
//          SPACE=(TRK,(20,20),RLSE),
//          DCB=(RECFM=VB,LRECL=6140,BLKSIZE=6144),
//          DISP=(NEW,DELETE,DELETE)
/* -----
/* -- Database data sets --
/* -----
//HDOU DD DSN=FMN.IMS.HDOU,DISP=SHR
/*
//ENDRC      ENDIF
    
```

Print Audit Report (AUD)

Purpose

Produce an audit trail report.

Usage Notes

You must specify the name of the audit trail data set from which you want to produce a report.

Options

You can choose between printing an unformatted report or, if the audited function used a template, a report formatted according to the template you used. You can also specify whether or not you want the audit trail data set to be deleted after printing. You can provide a description to help to identify the audit trail report.

Related functions

None.

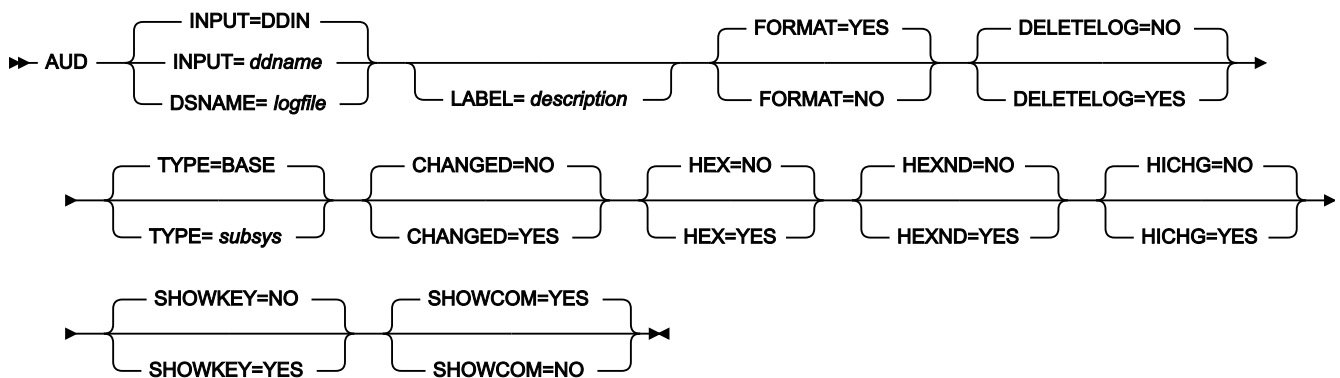

INPUT=*ddname*

Defines a reference to a DD or TSO ALLOC statement for the input data set or HFS file. The default is DDIN.

DSNAME=*logfile*

Specifies the name of the audit trail data set.

LABEL=Description

Optional description of the audit trail. The specified text is displayed at the start of the report. Must be enclosed in quotation marks if it contains blanks.

FORMAT

Determines the formatting of the audit trail report.

YES

Default. If the audit log data set includes a template record, the IMS segment data printed in the report is formatted according to the template. If the audit log data set does not include a template record, the IMS segment data printed in the report is not formatted.

NO

The IMS segment data printed in the report is not formatted.

DELETEDLOG

Determines whether or not the audit trail data set is deleted after printing. DELETEDLOG is not allowed for log data sets allocated using a DD statement.

NO

Default. The audit trail data set is not deleted.

YES

The audit trail data set is deleted after the report is printed.

TYPE

Always specify IMS.

CHANGED**NO**

Default. All the fields of an updated IMS segment are printed.

YES

Only IMS segment fields that are changed are printed.

HEX=YES

Produces an UPDOWN hexadecimal display below the standard field display.

HEXND=YES

Produces an UPDOWN hexadecimal display below the standard field display only for fields that contain non displayable characters.

HICHG=YES

Highlights the changed fields. An asterisk is placed to the left of the "before" data to indicate the field has been changed.

SHOWKEY=YES

Displays key fields even when CHANGED=YES has been selected. A "K" is printed to the left of key field names. For a KSDS data set, a key field is any elementary field that intersects, or is contained in, the key area.



Note: This does not apply to Db2® audit reports.

SHOWCOM

Controls whether or not uncommitted updates, checkpoints and rollbacks are reported.

NO

All the audit events in the audit log are reported. For an update function, checkpoints, rollbacks, and both committed and uncommitted database updates (inserts, deletes and replaces) are reported.

YES

FM/IMS only reports the database updates (inserts, deletes, and replaces) that were committed.

Examples

Note: The following two examples are reports for the same audit trail.

Example 1: An unformatted audit report where all the audit events in the audit log are reported (SHOWCOM=NO).

```
//FMBAT EXEC PGM=FILEMGR
//STEPLIB DD DSN=FMN.SFMNMOD1,DISP=SHR
//SYSPRINT DD SYSOUT=*
//IDIOPTS DD DSN=FMN.IDIOPTS,DISP=SHR
//SYSIN DD *
$$FILEM AUD ,
$$FILEM TYPE=IMS,
$$FILEM FORMAT=NO,
$$FILEM SHOWCOM=NO,
$$FILEM LABEL='EDIT THE SUBURB DATABASE',
$$FILEM DSNAME='FMNUSER.IMSAUDIT.D101104.T121752'
```

Figure 172. Unformatted audit report where all the audit events in the audit log are reported (Part 1 of 2)

```

IBM File Manager for z/OS IMS Component      Audit Trail Report
                                           Audit Trail Number 1

Subsystem: IF52
Database:  DJ2E

Audit Trail:
Data set name:  FMNUSER.IMSAUDIT.D101104.T121752
Description:    EDIT THE SUBURB DATABASE

0Audit trail number 1:
Function:       Edit
User ID:        FMNUSER
MVS system ID: FMD2
IMS subsystem:  IF52
Database:       DJ2E
DBD library:    FMN.REGTEST.IMS.DBDLIB
PSB type:       Dynamic
Region type:    DLI
Template:       FMN.REGTEST.IMS.TEMPLATE.PLI(DJ2E)

0Event number 1:  DL/I batch processing program started on 10/11/0

0Event number 2:  Checkpoint FM00001 taken on 10/11/04 at 12.17.5
Updates since audit event 1 have been committed.

0Event number 3:  Segment replaced on 10/11/04 at 12.18.59
Segment name:    SUBURB Level: 1
Concatenated key: KORRELOCKING

0          Segment          1          2          3          4
Status  Start Length 123456789012345678901234567890123456789012345678
-----
0BEFORE    1      62 KORRELOCKING      6485 K6420174WYALKATCHEM 010
          DDDDCDDCDDC444444FFFF4DFFFFFFFEECDCECCD444FFF
          269953632957000000648502642017468132133854000010
          CHANGED *****-----*****

0AFTER          KORRELOCKING      6399 K6420174WYALKATCHEM 010
          DDDDCDDCDDC444444FFFF4DFFFFFFFEECDCECCD444FFF
          269953632957000000639902642017468132133854000010
          CHANGED *****-----*****

0Event number 4:  Segment deleted on 10/11/04 at 12.19.52
Segment name:    LETRBOX Level: 2
Concatenated key: KORRELOCKING      6967

0          Segment          1          2          3          4
Status  Start Length 123456789012345678901234567890123456789012345678
-----

```

Example 2: A formatted audit report where only committed updates are reported (SHOWCOM=YES).

```
//FMBAT EXEC PGM=FILEMGR
//STEPLIB DD DSN=FMN.SFMNMOD1,DISP=SHR
//SYSPRINT DD SYSOUT=*
//IDIOPTS DD DSN=FMN.IDIOPTS,DISP=SHR
//SYSIN DD *
$$$FILEM AUD ,
$$$FILEM TYPE=IMS,
$$$FILEM FORMAT=YES,
$$$FILEM HICHG=YES,
$$$FILEM SHOWCOM=YES,
$$$FILEM LABEL='EDIT THE SUBURB DATABASE',
$$$FILEM DSNAME='FMNUSER.IMSAUDIT.D101104.T121752'
```

Figure 174. Formatted audit report where only committed updates are reported (Part 1 of 2)

```
IBM File Manager for z/OS IMS Component      Audit Trail Report
                                           Audit Trail Number 1

Subsystem: IF52
Database:  DJ2E

Audit Trail:
Data set name:  FMNUSER.IMSAUDIT.D101104.T121752
Description:    EDIT THE SUBURB DATABASE

@Audit trail number 1:
Function:       Edit
User ID:        FMNUSER
MVS system ID: FMD2
IMS subsystem:  IF52
Database:       DJ2E
DBD library:    FMN.REGTEST.IMS.DBDLIB
PSB type:       Dynamic
Region type:    DLI
Template:       FMN.REGTEST.IMS.TEMPLATE.PLI(DJ2E)

@Event number 1:  DL/I batch processing program started on 10/11/0

@Event number 2:  Segment replaced on 10/11/04 at 12.18.59
Segment name:     SUBURB Level: 1
Concatenated key: KORRELOCKING

@
Segment          1          2          3          4
Status  Start Length 12345678901234567890123456789012345678
-----
1 SUBURB                AN    62
2 SUBURB_NAME           AN    18  KORRELOCKING
2 POST_CODE             ZD    4*  6485
2 SUBURB_TYPE           AN     1
2 PUBLIC_PHONE          AN     4  K642
2 DISTANCE_2_PERTH     ZD     4   174
2 CLOSEST_CENTRE       AN    14  WYALKATCHEM
2 DISTANCE_2_CENTRE    ZD     3   10
2 MAP_REFERENCE        AN     9
3 LATITUDE_DEGREE      ZD     2   31
3 LATITUDE_MINUTE      ZD     2   12
3 LONGITUDE_DEGREE     ZD     3  117
3 LONGITUDE_MINUTE     ZD     2   28
2 ACRONYM              AN     5  KORRE
```

Figure 175. Formatted audit report where only committed updates are reported (Part 2 of 2)

```

0** End of Segment Structure - Length = 62

0Event number 3:      Segment deleted on 10/11/04 at 12.19.52
  Segment name:      LETRBOX Level: 2
  Concatenated key:  KORRELOCKING      6967

0      Segment          1      2      3      4
Status  Start Length 123456789012345678901234567890123456789012345678
-----
1 LETTER_BOX          AN      34
2 KEY                 AN      34
3 POST_CODE           AN      4 6967
3 LOCATION            AN     30 WAY OUT IN THE BUSH

0** End of Segment Structure - Length = 34

1IBM File Manager for z/OS IMS Component      Audit Trail Report
                                           Audit Trail Number 1

Subsystem: IF52
Database:  DJ2E

0Event number 4:      DL/I batch processing program ended on 10/11/04

0Audit trail number 1 statistics:
  Segments replaced:  1
  Segments inserted:  0
  Segments deleted:   1
  Total DB changes:   2
  Records skipped:    0

0End of audit trail number 1

-Audit trail report summary:
  No. of audit trails: 1
  Print format:        FORMATTED
  Lines per page:      60
  Changed fields only: NO
    
```

Appendix A. Messages

Messages issued by FM/IMS have a unique alphanumeric identifier with the format:

```
FMNxannn
```

where:

x

Is equal to I or B.

a

Is an alphabetic character.

nnn

Is a 3-digit number.

When the message is issued by a batch function, the identifier is printed in front of the text of the message.

When the message is issued by an online function, the identifier is not displayed with the message. However, you can obtain the identifier of a message by typing `MSGID` on the command line and pressing Enter. This command causes the message identifier of the last message issued to be displayed on your screen.

Many of the online messages comprise a short message and long message. The short message is displayed in the upper right-hand corner of the panel. The long message is only displayed if you press the F1 key when the short message is displayed.

In this section, selected messages with the format `FMNIannn` are listed in alphanumeric order. For details about messages with the format `FMNBannn`, see the chapter "File Manager messages" in the *File Manager User's Guide and Reference*.

For each message, the information provided comprises:

- The message identifier.
- The text of the message.
- An explanation of the message.
- The required user response.

When the message comprises a short message and a long message, the text of the two messages is separated by a hyphen. Messages can contain one or more variables. Variables are preceded by an ampersand (&).

File Manager IMS Messages

FMNIA005

DFSMDA dynamic allocation member for database &DBNAME not found in the RESLIB data sets for subsystem &SSID.

Explanation: Could not find a DFSMDA dynamic allocation member for database &DBNAME in the RESLIB data sets for subsystem &SSID. If the subsystem specified on the dialog entry panel has been defined as dynamic allocation only, the

message is displayed on the dialog entry panel. Otherwise, the message is displayed on the Database Data Set Specification panel.

User response: Ask the database administrator for the name of the data set that contains the dynamic allocation members for subsystem &SSID and include this data set name in the list of RESLIB data sets for subsystem &SSID on the DLI Mode Data Sets 1 panel (option 0.6.2). If the RESLIB data set name fields are protected, inform the FM/IMS administrator, and he will add the data set name to the FMN1POPI macro statement for the subsystem, and then re-assemble and link-edit the FM/IMS installation options module. Alternatively, if the subsystem has not been defined as dynamic allocation only, and you know the names of the database data sets that are to be used, you may enter the database data set names on the Database Data Set Specification pane, and press Enter.

FMNIA006

DB data set &DSN dynamic allocation error; DYNALLOC reason code is X'&RSN'.

Explanation: An attempt to allocate database data set &DSN failed. X'&RSN' is the error reason code that the DYNALLOC macro returned.

User response: For an explanation of the DYNALLOC error reason code, see the *z/OS MVS Programming: Authorized Assembler Services Guide*. Use this information to determine why the data set could not be allocated.

FMNIA010

Key change ignored - One or more key fields were overtyped. All changes on those lines have been ignored.

Explanation: The REPL DL/I call does not support the modification of key fields in a segment, so when a key field is overtyped, the Editor ignores the change. The Editor also ignores any other changes made on that line, restoring the line to how it was before it was overtyped.

User response: Check the lines that were overtyped and, when necessary, retype the required changes; this time avoiding overtyping a key field.

FMNIA011

Not VSAM - The DBD specifies VSAM for the access method.

Explanation: The specified data set is a non-VSAM data set, but the DBD specifies VSAM for the access method, so only VSAM data sets can be specified.

User response: Obtain from the database administrator the correct database data set name.

FMNIA012

Not OSAM - The DBD specifies OSAM for the access method.

Explanation: The specified data set is a non-OSAM data set, but the DBD specifies OSAM for the access method, so only OSAM data sets can be specified.

User response: Obtain from the database administrator the correct database data set name.

FMNIA013

Assembly of dynamic PSB failed with return code &RC.

Explanation: The PSBGEN assembly step for the dynamic PSB your batch function was generating, failed with a return code of &RC.

User response:

Add the following DD statement to the JCL and rerun the job:

```
//FMN1PRT1 DD SYSOUT=*
```

The job output will include the PSBGEN assembly listing. Use the assembly listing to determine the cause of the problem.

FMNIA014

Bind of dynamic PSB failed with return code &RC.

Explanation: The PSBGEN bind step for the dynamic PSB your batch function was generating, failed with a return code of &RC.

User response:

Add the following DD statement to the JCL and rerun the job:

```
//FMN1PRT2 DD SYSOUT=*
```

The job output will include the PSBGEN bind listing. Use the bind listing to determine the cause of the problem.

FMNIA015

IMS read failed - An attempt to read an IMS segment has failed. The function has been terminated.

Explanation: An attempt to retrieve an IMS segment failed. The failure was due to an IMS abend, or to system I/O, or security errors, encountered during the execution of the I/O requests.

User response: See the message issued prior to this message for detailed information on the cause of the failure.

FMNIA016

IMS status code AI - A data management open error occurred.

Explanation: A DL/I call that FM/IMS issued received a status code of AI, indicating that a data management open error occurred.

User response:

Read the AI status code explanation in *IMS Utilities Reference: Database and Transaction Manager*. Message DFS0730I, when issued, gives the cause of the OPEN failure. Search for this message in either:

- The job log output from the failed job (if the function is a batch function run in DLI mode);
- The job log for your TSO/E session (if the function is an online function run in DLI mode);
- The job log for the control region or DLI/SAS region (if the function is run in BMP mode); or
- The z/OS system log (batch or online function run in BMP or DLI mode).

For an explanation of the reason codes appearing in message DFS0730I, see the description of this message in *IMS Messages and Codes Vol 1*.

FMNIA017

Invalid DBD - Member &DBNAME of DBD library &DSN does not contain a valid DBD for database &DBNAME.

Explanation: FM/IMS requires a DBD for the specified database (&DBNAME). FM/IMS searches user, or administrator, specified DBD libraries for the DBD. Which DBD libraries FM/IMS searches depends on which subsystem you select. The DBD libraries that FM/IMS searches are listed on the PSB and DBD Data Sets panel (option 0.6.7). FM/IMS searches these libraries in the order in which they are listed, and uses the first member it finds with the specified database name (&DBNAME). FM/IMS found member &DBNAME in DBD library &DSN, but cannot use it because it does not contain a valid DBD for database &DBNAME.

User response: Either replace member &DBNAME in DBD library &DSN with a DBD for database &DBNAME, or update the list of DBD libraries on the PSB and DBD data sets panel to only include DBD libraries with valid DBDs. You will only be able to update the list when the DBD libraries for the subsystem are not fixed. When the DBD libraries for the subsystem are fixed, the DBD Data set name panel fields are protected and only the FM/IMS administrator can update the list.

FMNIA018

Invalid PSB - Member &PSBNAME of PSB library &DSN does not contain a valid PSB.

Explanation: FM/IMS searches user, or administrator, specified PSB libraries for a PSB with the specified name (&PSBNAME). Which PSB libraries FM/IMS searches depends on which subsystem you select. The PSB libraries that FM/IMS searches are listed on the PSB and DBD Data Sets panel (option 0.6.7). FM/IMS searches these libraries in the order in which they are listed, and uses the first member it finds with the specified PSB name (&PSBNAME). FM/IMS found member &PSBNAME in PSB library &DSN, but cannot use it because it does not contain a valid PSB.

User response: Either replace member &PSBNAME in PSB library &DSN with a valid PSB, or update the list of PSB libraries on the PSB and DBD data sets panel to only include PSB libraries with valid PSBs. You will only be able to update the list when the PSB libraries for the subsystem are not fixed. When the PSB libraries for the subsystem are fixed, the PSB Data set name panel fields are protected and only the FM/IMS administrator can update the list.

FMNIA019

Not a loadlib - The data set must be a load library.

Explanation: Self explanatory.

User response: Specify a load library.

FMNIA020

Edit of an index database is not supported.

Explanation: The specified database is an index database. FM/IMS does not support the edit of an index as a separate database.

User response: If you just want to view the index database, use the Browse function.

FMNIA021

Template for database not in data set &DSN.

Explanation: The template library (&DSN) specified in the TPLDSN parameter (on the VIEWIMS call), or allocated to the DD specified in the TPLDD parameter (also on the VIEWIMS call), does not have a template for the database that the batch function is accessing.

User response: Either use option 4.1 to create a template for the database and save it in data set &DSN, or specify a different template library that has a template for the database.

FMNIA023

Not an IMS template/view/criteria set - There is a Base template/DB2 template/view/criteria set/unknown object in this member/data set - not an IMS template/view/criteria set as is required.

Explanation: Self explanatory.

User response: Specify a member or data set that contains the required object.

FMNIA024

No secondary indexes - There are no secondary indexes defined for this database.

Explanation: You have requested access to the database via a secondary index, but the database does not have any secondary indexes.

User response: Blank out the Secondary index option field.

FMNIA026

IMS access denied - The IMS Initialization Exit has denied you access to the requested IMS resources.

Explanation: You are not authorized to access the requested IMS resources. The IMS Initialization exit denied you access.

User response: If you believe you should be authorized to access the IMS resources, ask the FM/IMS security administrator for the required access.

FMNIA027

Access denied - The Database Data Set Allocation Exit denied your access to this database data set.

Explanation: You are not authorized to access this database data set. The Database Data Set Allocation exit denied you access.

User response: If you believe you should be authorized to access this database data set, ask the FM/IMS security administrator for access to it.

FMNIA029

IMS log data set &DSN dynamic allocation error; DYNALLOC reason code=X'&RSN'.

Explanation: An attempt to allocate IMS log data set &DSN failed. X'&RSN' is the error reason code that the DYNALLOC macro returned.

User response: For an explanation of the DYNALLOC error reason code, see *z/OS MVS Programming: Authorized Assembler Services Guide*. Use this information to determine why the data set could not be allocated.

FMNIA030

DFSVSAMP data set &DSN dynamic allocation error; DYNALLOC reason code=X'&RSN'.

Explanation: An attempt to allocate the DFSVSAMP data set &DSN failed. X'&RSN' is the error reason code that the DYNALLOC macro returned.

User response: For an explanation of the DYNALLOC error reason code, see *z/OS MVS Programming: Authorized Assembler Services Guide*. Use this information to determine why the data set could not be allocated.

FMNIA031

There is a Base template/IMS template/DB2 template/view/criteria set/unknown object in &DSN/&DSN(&MBR) - not an IMS template/view/criteria set as is required.

Explanation:

The Print, Extract, Batch Edit, and Batch Browse functions issue this message. When the message is issued by the Print function, the data set &DSN, or data set and member &DSN(&MBR), are specified in the VIEWDSN and VIEWMEM parameters, or in the VIEWDD DD statement. When the message is issued by the Extract function, the data set &DSN, or data set and member &DSN(&MBR), are specified in the CRITDSN and CRITMEM parameters, or in the CRITDD DD statement. When the message is issued by the Batch Edit or Batch Browse function, the data set &DSN, or data set and member &DSN(&MBR), can be specified in a number of places:

- If it is an IMS template that is required, the data set &DSN is specified in the TPLDSN parameter on the VIEWIMS call, or in the TPLDD DD statement.
- If it is a view that is required, the data set &DSN, or data set and member &DSN(&MBR), are specified in either the VIEWDSN and VIEWMEM parameters on the VIEWIMS call, the VIEWDSN and VIEWMEM parameters in the FMNIMSIN input, or the VIEWDD DD statement.

User response: Specify a data set, or a data set and member, that contains the required object.

FMNIA032

Create failed - Create failed because DBDLIB &DSN is not a PDS(E). Use option 4.1 or option 4.4 to update the DBDLIBs specified in the template.

Explanation: The CT command (Create view/criteria set from template) failed because one of the DBDLIB data sets (&DSN) specified in the template is not a PDS(E).

User response: Use option 4.1, or option 4.4, to correct the DBDLIB library list specified in the template.

FMNIA033

Create failed - Create failed because DBDLIB &DSN is not a load library. Use option 4.1 or option 4.4 to update the DBDLIBs specified in the template.

Explanation: The CT command (Create view/criteria set from template) failed because one of the DBDLIB data sets (&DSN) specified in the template is not a load library.

User response: Use option 4.1, or option 4.4, to correct the DBDLIB library list specified in the template.

FMNIA034

Create failed - Create failed because DBDLIB &DSN was not found in the catalog. Use option 4.1 or option 4.4 to update the DBDLIBs specified in the template.

Explanation: The CT command (Create view/criteria set from template) failed because one of the DBDLIB data sets (&DSN) specified in the template was not found in the catalog.

User response: Use option 4.1, or option 4.4, to correct the DBDLIB library list specified in the template.

FMNIA035

Invalid template - Found member &DBNAME in Template library &DSN. Expected it to be a template for database &DBNAME, but it was a Base template/DB2 template/view/criteria set/unknown object.

Explanation: Because you have selected 'New' for View or Criteria usage, the function attempts to create a view, or criteria set, from a template for the specified database (&DBNAME). FM/IMS searches user, or administrator, specified template libraries for the template. Which template libraries FM/IMS searches depends on which subsystem you select. The template libraries that FM/IMS searches are listed on the Template Data Sets panel (option 0.6.8). FM/IMS searches these libraries in the order in which they are specified, and uses the first member it finds with the specified database name (&DBNAME). FM/IMS found a member with the specified database name, but cannot use it because it is not a template.

User response: Either replace member &DBNAME in the Template library &DSN with a template for database &DBNAME, or update the list of Template libraries on the Template Data Sets panel to only include Template libraries with valid templates. You will only be able to update the list when the Template libraries for the subsystem are not fixed. When the template libraries for the subsystem are fixed, the Template Data Set name panel fields are protected, and only the FM/IMS administrator can update the list.

FMNIA036

RESLIB &DSN allocate error - DYNALLOC rc = X'&RSN'. (RESLIB specified in FMN1POPI macro).

Explanation: An attempt to allocate RESLIB data set &DSN failed. X'&RSN' is the error reason code that the DYNALLOC macro returned. This message is only issued when a BMP region type is selected. In this case, FM/IMS obtains the RESLIB data set names from the FM/IMS installation options module.

User response: For an explanation of the DYNALLOC error reason code, see the *z/OS MVS Programming: Authorized Assembler Services Guide*. Use this information to determine why the data set could not be allocated. If the list of RESLIB data sets that the function uses has to be altered, inform the FM/IMS administrator, and he will make the necessary changes to the FMN1POPI macro statement for the subsystem and then reassemble, and link-edit, the installation options module.

FMNIA037

RESLIB &DSN allocate error - DYNALLOC rc = X'&RSN'. (RESLIB specified in option 0.6.2)

Explanation:

An attempt to allocate RESLIB data set &DSN failed. X'&RSN' is the error reason code that the DYNALLOC macro returned. This message is only issued when a DLI region type is selected. In this case, FM/IMS obtains the RESLIB data set names from one of the following:

- The RESLIB data set name fields on the DLI Mode Data Sets 1 panel (when the function is Edit or Browse).
- The RESLIB parameters specified in the FMNIMSIN input (when the function is a batch function and the RESLIB parameters are specified in the FMNIMSIN input).
- The FM/IMS installation options module (when the function is a batch function and the RESLIB parameters are not specified in the FMNIMSIN input).

User response: For an explanation of the DYNALLOC error reason code, see the *z/OS MVS Programming: Authorized Assembler Services Guide*. Use this information to determine why the data set could not be allocated. If the list of RESLIB data sets that the function uses has to be altered:

- Modify the RESLIB data set names on the DLI Mode Data Set 1 panel (Edit or Browse function); or
 - Modify the RESLIB parameters in the FMNIMSIN input (batch functions).
-

FMNIA038

No database PCBs - The PSB cannot be used because it does not have any database PCBs.

Explanation: You have specified a PSB that does not have any database PCBs. The function can only use PSBs that have database PCBs.

User response: Specify a PSB that has one or more database PCBs.

FMNIA039

No PCBs for database - The PSB does not have any PCBs for database &DBNAME.

Explanation: You cannot use the specified PSB to access database &DBNAME because the PSB does not have any PCBs for the database.

User response: If you want to access database &DBNAME, specify a PSB that has a PCB for this database.

FMNIA040

View saved - The view has been saved in the specified data set.

Explanation: Self explanatory.

User response: No action is required.

FMNIA041

View created - View created and saved in the specified view data set.

Explanation: Self explanatory.

User response: No action is required.

FMNIA043

Invalid options module - Invalid FM/IMS installation options module - no IMS subsystems were found in the module.

Explanation: Self explanatory.

User response: Report this problem to the FM/IMS administrator.

FMNIA044

No matches - No subsystems in the FM/IMS installation options module match the specified pattern.

Explanation: You specified a pattern in the IMS Subsystem Name field, and no subsystems specified in the FM/IMS installation options module match this pattern.

User response: For a list of all the subsystems specified in the FM/IMS installation options module, blank out the IMS subsystem name field and press Enter.

FMNIA045

Subsystem not found - The requested subsystem was not found in the FM/IMS installation options module.

Explanation: The specified subsystem has not been included in the FM/IMS installation options module.

User response: If you want FM/IMS functions to have access to this subsystem, ask the FM/IMS administrator to add the subsystem to the FM/IMS installation options module.

FMNIA046

Subsystem not active - The requested subsystem is not currently active.

Explanation: The specified subsystem is not active, so you cannot access it in BMP mode.

User response: Contact the system administrator to determine why the subsystem is not active or, if you are permitted to do so, access the subsystem in DLI mode.

FMNIA047

Invalid value for parameter AGN. Patterns are not permitted.

Explanation: The AGN parameter specifies a pattern. This parameter does not support patterns.

User response: If REGNTYPE is set to BMP, and the subsystem specified in the IMSID parameter uses AGNs, specify an AGN that you have authority to use and that will provide the batch function with the access that it requires. Otherwise, remove the AGN parameter from the FMNIMSIN input.

FMNIA048

Invalid value for parameter IMSID. Patterns are not permitted.

Explanation: The IMSID parameter specifies a pattern. This parameter does not support patterns.

User response: Specify the ID of the IMS subsystem that the database you want to access is defined in.

FMNIA049

IMS subsystem &SSID is not active.

Explanation: The subsystem specified in the IMSID parameter (&SSID) is not active, so you cannot access it in BMP mode.

User response: Contact the system administrator to determine why the subsystem is not active or, if you are permitted to do so, access the subsystem in DLI mode.

FMNIA051

AGN required - The IMS subsystem uses AGNs and AGNs for the subsystem are not listed in the FM/IMS installation options module. So you must enter an AGN name.

Explanation: AGN selection is only available when AGNs for the subsystem are listed in the FM/IMS installation options module.

User response: Specify an AGN that you have authority to use, and that will provide the function with the access that it requires.

FMNIA052

No subsystem selected - No subsystem was selected on the Subsystem Selection panel.

Explanation: IMS Subsystem Name is a required field, and you did not select a subsystem.

User response: If you want to move forward in the dialog, you must either select a subsystem on the Subsystem Selection panel, or specify a subsystem in the IMS Subsystem Name field.

FMNIA053

Status refreshed - The status of the listed IMS subsystems has been refreshed.

Explanation: FM/IMS has rechecked the status of the listed IMS subsystems, and refreshed the status fields on the screen.

User response: No action is required.

FMNIA054

AGNs not used - The subsystem does not use AGNs. Leave field blank.

Explanation: You have specified an AGN, and the subsystem does not use AGNs.

User response: Blank out the AGN field (online functions), or remove the AGN parameter from the FMNIMSIN input (batch functions).

FMNIA055

AGN pattern not allowed - AGNs for the subsystem are not listed in the FM/IMS installation options module. So you must enter the full AGN name.

Explanation: Self explanatory.

User response: Specify an AGN that you have authority to use, and that will provide the function with the access that it requires.

FMNIA056

View not replaced - The view was not saved and the existing data was not replaced.

Explanation: Because you pressed the EXIT or CANCEL key on the View Replace pop-up panel, the view was not saved, and the existing data was not replaced.

User response: No action is required.

FMNIA057

DBD &DBNAME not found - Logically related DBD &DBNAME not found in the DBD libraries for subsystem (&SSID)

Explanation:

FM/IMS requires the following DBDs to be in at least one of the DBD libraries for the specified subsystem &SSID:

- The DBD for the database you specified.
- The DBD for each database that is logically related to the database you specified.

Database &DBNAME is logically related to the database you specified, but its DBD was not found in the DBD libraries for subsystem &SSID.

User response: The DBD libraries for subsystem &SSID are specified on the PSB and DBD Data Sets panel (option 0.6.7). Either include a DBD for database &DBNAME in one of the DBD libraries listed on that panel, or update this list to include a DBD library that has a DBD for database &DBNAME. You will only be able to update the list when the DBD libraries for the subsystem are not fixed. When the DBD libraries for the subsystem are fixed, the DBD data set names panel fields are protected, and only the FM/IMS administrator can update the list.

FMNIA058

IMS MACLIB &DSN dynamic allocation error - DYNALLOC reason code is X'&RSN'.

Explanation: An attempt to allocate IMS MACLIB &DSN failed. X'&RSN' is the error reason code that the DYNALLOC macro returned.

User response: For an explanation of the DYNALLOC error reason code, see the *z/OS MVS Programming: Authorized Assembler Services Guide*. Use this information to determine why the data set could not be allocated.

FMNIA061

Data set in use - Allocation of data set failed because data set is in use by another user or job.

Explanation: An attempt to allocate this database data set failed. The dynamic allocation request failed because the data set is allocated to another user, or job, and its usage attribute conflicts with your request.

User response: To obtain a list of the jobs and users allocated to the data set, attempt to edit the data set (use ISPF option 2 "Edit", or ISPF option 3.4 "Data Set List Utility"), and when ISPF issues the message 'Data set in use', enter the HELP command (F1) twice, and ISPF will display the required information on the Data Set Contention panel.

FMNIA062

Load of DBD &DBNAME failed with abend code &CC and reason code &RSN.

Explanation: An attempt to load DBD &DBNAME failed. &CC is the abend code for the abend that would have been issued had there not been error recovery. &RSN is the reason code associated with the abend code.

User response: For an explanation of the abend and associated reason code, see *z/OS MVS System Codes*. Use this information to determine why the DBD could not be loaded.

FMNIA063

Load of PSB &PSBNAME failed with abend code &CC and reason code &RSN.

Explanation: An attempt to load PSB &PSBNAME failed. &CC is the abend code for the abend that would have been issued had there not been error recovery. &RSN is the reason code associated with the abend code.

User response: For an explanation of the abend and associated reason code, see *z/OS MVS System Codes*. Use this information to determine why the PSB could not be loaded.

FMNIA064

Database mismatch - Found member &DBNAME1 in Template library &DSN. Expected it to be a template for database &DBNAME1, but it was a template for database &DBNAME2. You cannot use this template to browse/edit/extract/ or print database &DBNAME1.

Explanation: Because you have selected 'New' for View, or Criteria usage, the function attempts to create a view, or criteria set, from a template for the specified database (&DBNAME1). FM/IMS searches user, or administrator, specified template libraries for the template. Which template libraries FM/IMS searches depends on which subsystem you select. The template libraries that FM/IMS searches are listed on the Template Data Sets panel (option 0.6.8). FM/IMS searches these libraries in the order in which they are specified, and uses the first member it finds with the specified database name (&DBNAME1). FM/IMS found a member with the specified database name (&DBNAME1), but cannot use it because it is not a template for database &DBNAME1.

User response:

Do one of the following:

- Delete member &DBNAME1 from the Template library &DSN, and then, using option 4.1, create a template for database &DBNAME1 and save it in the Template library &DSN.
 - Update the list of Template libraries on the Template Data Sets panel to only include Template libraries with valid templates. You will only be able to update the list when the Template libraries for the subsystem are not fixed. When the Template libraries for the subsystem are fixed, the Template data set name panel fields are protected, and only the FM/IMS administrator can update the list.
-

FMNIA066

Create/Edit failed - Create/Edit failed because DBD &DBNAME was not found in the DBD libraries specified in the template/view/criteria set.

Explanation: One of the following failures occurred:

1. The CT command (Create view/criteria set from template) failed because the DBD for database &DBNAME (that is, the database the template is for) was not found in the DBD libraries specified in the template.
2. The CM command (Create view/criteria set from model) failed because the DBD for database &DBNAME (that is, the database the model view/criteria set is for) was not found in the DBD libraries specified in the model view/criteria set.
3. The Edit view/criteria set failed because the DBD for database &DBNAME (that is, the database the view/criteria set is for) was not found in the DBD libraries specified in the view/criteria set.

User response: A different response is required for failure 1 than for failure 2 and 3. For failure 1, first you need to determine which DBD libraries are specified in the template. To determine this, use option 4.1. If you specify the Template data set name and member on the Template Entry panel and press Enter, the DBD Library List panel is displayed. The panel displays a list of the DBD libraries specified in the template. There are two ways you can proceed from here. Either:

1. Include a DBD for database &DBNAME in one of the DBD libraries listed on that panel, or
2. Update this list to include a DBD library that has a DBD for database &DBNAME.

To save the template, press Enter, followed by the Exit key. Either of these actions will resolve this problem. The remainder of the text describes the response for failure 2 and 3. For failure 2, the view/criteria set refers to the model view/criteria set. For failure 3, the view/criteria set refers to the view/criteria set you attempted to edit:

- Update the view/criteria set from the template it is based on. To update the view, use the U command on the View Entry panel (option 4.2). To update the criteria set, use the U command on the Criteria Set Entry panel (option 4.3). If the view/criteria set was based on the latest version of the template, FM/IMS issues message FMNIA083 'Update not required - View/Criteria set did not require any updates from the template it was created from. The template is in data set member &DSN. Otherwise, FM/IMS updates the view/criteria set and issues message FMNIA082/FMNIA131 'View /Criteria set updated - View/Criteria set has received updates from the template it was created from. The template is in data set member &DSN. Take note of the template data set name and member (&DSN) specified in these messages.
- If the update was required, the update may have resolved the problem. Issue the CM or E command again to see if it has.
- If the problem still exists, you need to determine which DBD libraries are specified in the template that the view/criteria set is based on. That is, the template in &DSN. To determine this, use Option 4.1. If you specify the template data set name and member on the Template Entry panel and press Enter, the DBD Library List panel is displayed. This panel displays a list of the DBD libraries specified in the template.

There are two ways you can proceed from here. Either include a DBD for database &DBNAME in one of the DBD libraries listed on that panel, or do the following:

- Update this list to include a DBD library that has a DBD for database &DBNAME.
- To save the template, press Enter, followed by the Exit key. Then update the view/criteria set from the template as you did before.

Either of these actions will resolve this problem.

FMNIA067

Create/Edit failed - Create/Edit failed because member &DBNAME of DBDLIB &DSN does not contain a valid DBD for database &DBNAME.

Explanation: One of the following failures occurred:

1. The CT command (Create view/criteria set from template) failed.
 2. The CM command (Create view/criteria set from model) failed.
 3. The E command (Edit view/criteria set) failed.
- For failure 1, &DBNAME is the name of the database the template is for and &DSN is a DBD library specified in the template. FM/IMS searches the DBD libraries specified in the template for member &DBNAME. This member is found in the DBD library &DSN, but it does not contain a valid DBD for database &DBNAME, so the command fails.
 - For failure 2, &DBNAME is the name of the database the model view/criteria set is for and &DSN is a DBD library specified in the model view/criteria set. FM/IMS searches the DBD libraries specified in the model view/criteria set for member &DBNAME. This member is found in the DBD library &DSN, but it does not contain a valid DBD for database &DBNAME, so the command fails.
 - For failure 3, &DBNAME is the name of the database the view/criteria set is for and &DSN is a DBD library specified in the view/criteria set. FM/IMS searches the DBD libraries specified in the view/criteria set for member &DBNAME. This member is found in the DBD library &DSN, but it does not contain a valid DBD for database &DBNAME, so the command fails.

User response: Either replace the member with a valid DBD for database &DBNAME, or do the following:

- For failure 1, use options 4.1, or 4.4, to correct the DBD library list specified in the template.

The remainder of the text describes the response for failure 2 and 3. For failure 2, the view or criteria set refers to the model view or criteria set. For failure 3, the view or criteria set refers to the view or criteria set you attempted to edit:

- Update the view or criteria set from the template it is based on. To update the view, use the U command on the View Entry panel (option 4.2). To update the criteria set, use the U command on the Criteria Set Entry panel (option 4.3). If the view or criteria set was based on the latest version of the template, FM/IMS issues message "FMNIA083" ([FMNIA083 on page 668](#)). Otherwise, FM/IMS updates the view or criteria set and issues message "FMNIA082" ([FMNIA082 on page 668](#)) or message "FMNIA131" ([FMNIA131 on page 674](#)). Take note of the template data set name, and member (&DSN), specified in these messages.
- If the update was required, the update may have resolved the problem. Issue the CM, or E, command again to see if it has.
- If the problem still exists, specify the template data set name, and member (&DSN), on the Template Entry panel (option 4.1), and press Enter; the DBD Library List panel is displayed. This panel displays a list of the DBD libraries specified in the template.
 - Update this list to only include DBD libraries with valid DBDs.
 - To save the template, press Enter, followed by the Exit key. Then update the view or criteria set from the template as you did before.

These actions will resolve this problem.

FMNIA068

&PARM data set &DSN is not partitioned.

Explanation: The data set &DSN specified in parameter &PARM is not partitioned. You must specify a PDS(E) in this parameter.

User response: Specify a PDS(E).

FMNIA069

The ACBGEN that builds the blocks for the dynamic PSB failed with return code &RC.

Explanation: The ACBGEN for the dynamic PSB your batch function was generating failed with a return code of &RC.

User response: The job SYSPRINT output will include the ACBGEN listing. Use the ACBGEN listing to determine the cause of the problem.

FMNIA070

No dynamic PSB available - All the dynamic PSB names available to this BMP are currently in use.

Explanation: There are a finite number of dynamic PSB names available for use by concurrent FM/IMS functions run in BMP mode. Currently, they are all being used.

User response: Try again later. If you get this message frequently, notify the FM/IMS administrator.

FMNIA071

ATTACH of IMS control region program failed with return code &RC.

Explanation: An attempt to attach the IMS region controller failed with a return code of &RC.

User response: For an explanation of the ATTACH macro return codes, see *z/OS MVS Programming: Authorized Assembler Services Guide*. Check the z/OS system log for error messages issued during the processing of the ATTACH macro.

FMNIA072

Segment not found - No &SEGNAME segment occurrence with the specified key values was found.

Explanation: FM/IMS issued a GU call for a &SEGNAME segment occurrence, but the call received a GE status code. IMS returns this status code when it cannot find a segment that satisfies the segment search arguments (SSAs) specified in the call.

User response: No action is required.

FMNIA073

Call to DL/I failed with status code &SC.

Explanation: A DL/I database retrieval call received a status code of &SC.

User response: For an explanation of the status code, see *IMS Messages and Codes Vol 4*. Use this information to determine why the retrieval call received a bad status code.

FMNIA075

RECON1/RECON2/RECON3 data set &DSN dynamic allocation error; DYNALLOC reason code='X'&RSN'.

Explanation: An attempt to allocate RECON data set &DSN failed. X'&RSN' is the error reason code that the DYNALLOC macro returned.

User response: For an explanation of the DYNALLOC error reason code, see *z/OS MVS Programming: Authorized Assembler Services Guide*. Use this information to determine why the data set could not be allocated.

FMNIA077

Edit of an HSAM database is not supported.

Explanation: The specified database is an HSAM database. FM/IMS does not support the edit of HSAM databases because IMS does not support the Delete (DLET) and Replace (REPL) calls. And Insert (ISRT) calls are only allowed when the database is being loaded.

User response: If you want to update this database, it must be reloaded.

FMNIA078

Edit of an SHSAM database is not supported.

Explanation: The specified database is an SHSAM database. FM/IMS does not support the edit of SHSAM databases because IMS does not support the Delete (DLET) and Replace (REPL) calls. And Insert (ISRT) calls are only allowed when the database is being loaded.

User response: If you want to update this database, it must be reloaded.

FMNIA081

Invalid value - Specify one of the following relational operators: EQ GT GE LE NE UQ = > < >= <= !=

Explanation: The message is issued on the Key Specification panel when an invalid value is entered in one of the RO (Relational Operator) fields. The values specified in these fields are used when building the SSAs for the GU call that the panel issues.

User response: When you want an unqualified SSA at this level, specify UQ in the field. Otherwise, specify the relational operator you want the SSA to use.

FMNIA082

View updated - View has received updates from the template it was created from. The template is in data set member &DSN.

Explanation: The template that the view was created from had been modified since the view was last updated, so the view has been updated as you requested. The template that the view was created from is in data set member &DSN.

User response: No action is required.

FMNIA083

Update not required - View/Criteria set did not require any updates from the template it was created from. The template is in data set member &DSN.

Explanation: You requested an update of the view/criteria set, but the update was not performed because it was not required. The update is only performed when the template that the view/criteria set was created from has been modified. The template that the view was created from is in data set member &DSN.

User response: No action is required.

FMNIA084

Criteria not replaced - The criteria set was not saved and the existing data was not replaced.

Explanation: You pressed the EXIT or CANCEL key on the Criteria Replace pop-up panel, so the criteria set was not saved, and the existing data was not replaced.

User response: No action is required.

FMNIA085

&PARM data set &DSN is not a load library.

Explanation: The data set &DSN specified in parameter &PARM is not a load library. You must specify a load library in this parameter.

User response: Specify a load library.

FMNIA086

&PARM data set &DSN was not found in the catalog.

Explanation: The data set &DSN specified in parameter &PARM was not found in the catalog. You must specify a cataloged data set.

User response: Specify a cataloged data set.

FMNIA087

DBDMEM member &MBR was not found in the specified DBD libraries.

Explanation: The member &MBR specified in parameter DBDMEM was not found in the DBD libraries specified in the DBDDSN, DBDDSN2, DBDDSN3, DBDDSN4, DBDDSN5, and DBDDSN6 parameters.

User response: Specify a DBD library that has the required DBD member.

FMNIA093

Criteria set created - Criteria set created and saved in the specified criteria data set.

Explanation: Self explanatory.

User response: No action is required.

FMNIA094

Only 255 criteria subsets are allowed

Explanation: An attempt to create a new field criteria subset, or repeat an existing field criteria subset, failed because the criteria set would exceed the maximum allowable number of field criteria subsets. 255 is the maximum number of field criteria subsets that a criteria set is allowed to have.

User response: None.

FMNIA095

Criteria set saved - Criteria set has been saved in the criteria data set.

Explanation: Self explanatory.

User response: No action is required.

FMNIA100

Load of a logical database is not supported.

Explanation: The specified database is a logical database. FM/IMS does not support the load of logical databases.

User response: Load the data into the physical databases.

FMNIA101

Load of an index database is not supported.

Explanation: The specified database is an index database. IMS does not support the load of an index as a separate database.

User response: Load the data into the indexed databases; IMS takes care of the indexes.

FMNIA102

Invalid for Fast Path - Fast Path databases can only be processed in a BMP region.

Explanation: The specified database is a Fast Path database. Fast Path databases cannot be processed in DL/I batch regions.

User response: Select BMP for the Region type.

FMNIA103

No segment layout selected

Explanation: The Segment Layout Selection panel was displayed because the segment that you selected has multiple segment layouts. You did not select a segment layout on that panel.

User response: If you want to insert the segment that you selected, you must select the segment layout that you want the insert to use.

FMNIA104

Load of an MSDB database is not supported.

Explanation: The specified database is an MSDB database. FM/IMS does not support the load of MSDB databases.

User response: Use the MSDB Maintenance utility (DBFDBMA0) to create a z/OS sequential data set for an initial load of the MSDB database. For information on how to do this see *IMS Utilities Reference: Database and Transaction Manager*.

FMNIA105

The Load file does not contain a valid header record.

Explanation: Self explanatory.

User response: Check that you have included a header record in the Load file. If you have, check that the data in this record is correctly formatted. For information on the layout of the header record, see [Extract data layout on page 564](#). Alternatively, you can get the Extract dialog, or Extract job, to create a template for the Load file. The template provides you with the correct layout for the header record. Using this template when you edit the header record will reduce the effort required to format the data.

FMNIA109

DSPURX00 call failed to obtain the ddnames and data set names for DB &DBNAME. The DBRC command received return code &RC.

Explanation:

The batch function you ran calls the Database Recovery Control Utility (DSPURX00) to obtain the ddnames and data set names for:

- The HALDB database you specified; and
- All HALDB databases that are logically related to the HALDB database you specified

The call that was attempting to obtain the ddnames, and data set names for database &DBNAME, failed with a return code of &RC.

User response: Add the following DD statement to the JCL and rerun the job:

```
//FMN1DPRT DD SYSOUT=*
```

The job output will include the DBRC listing. Use the listing to determine the cause of the problem.

FMNIA111

Press ENTER to confirm usage of the specified data set(s).

Explanation: Self explanatory.

User response: Check the displayed database data set names. If they are the data sets that you want the function to use, press Enter.

FMNIA112

Recall failed - Data set is migrated or archived and the recall of the data set failed.

Explanation: The data set that you specified is migrated or archived. FM/IMS attempted to recall this data set, but the recall failed.

User response: See the DFHSM (or equivalent product) messages issued prior to this message for detailed information on the cause of the failure.

FMNIA114

Edit/Browse active - FM/IMS supports only one Edit/Browse dialog per user.

Explanation: You have selected the Edit or Browse dialog, but you are already running an Edit or Browse dialog on another logical screen. FM/IMS supports only one Edit/Browse dialog per user.

User response: Exit the active Edit/Browse dialog and then try again. If you receive this message when you have no active Edit/Browse dialogs on any of your logical screens, log off and then log back on.

FMNIA115

Extract dialog active - FM/IMS supports only one Extract dialog per user.

Explanation: You have selected the Extract dialog, but you are already running an Extract dialog on another logical screen. FM/IMS supports only one Extract dialog per user.

User response: Exit the active Extract dialog and then try again. If you receive this message when you have no active Extract dialogs on any of your logical screens, log off and then log back on.

FMNIA116

Load dialog active - FM/IMS supports only one Load dialog per user.

Explanation: You have selected the Load dialog, but you are already running a Load dialog on another logical screen. FM/IMS supports only one Load dialog per user.

User response: Exit the active Load dialog and then try again. If you receive this message when you have no active Load dialogs on any of your logical screens, log off and then log back on.

FMNIA117

Template dialog active - FM/IMS supports only one Template dialog per user.

Explanation: You have selected the Template dialog, but you are already running a Template dialog on another logical screen. FM/IMS supports only one Template dialog per user.

User response: Exit the active Template dialog and then try again. If you receive this message when you have no active Template dialogs on any of your logical screens, log off and then log back on.

FMNIA118

View dialog active - FM/IMS supports only one View dialog per user.

Explanation: You have selected the View dialog, but you are already running a View dialog on another logical screen. FM/IMS supports only one View dialog per user.

User response: Exit the active View dialog and then try again. If you receive this message when you have no active View dialogs on any of your logical screens, log off and then log back on.

FMNIA119

Criteria dialog active - FM/IMS supports only one Criteria dialog per user.

Explanation: You have selected the Criteria Set dialog, but you are already running a Criteria Set dialog on another logical screen. FM/IMS supports only one Criteria Set dialog per user.

User response: Exit the active Criteria Set dialog and then try again. If you receive this message when you have no active Criteria Set dialogs on any of your logical screens, log off and then log back on.

FMNIA121

XKEY data set &DSN created.

Explanation: You issued the XKEY command on an IMS data panel. This is a request to create a data set that contains the keys of all the root segments between the current position and the end of the database, or the keys of every nth root segment between the current position and the end of the database. This message is issued when the XKEY data is successfully created.

User response: No action is required.

FMNIA122

Edit of a logical database with KEY-only segments is not supported.

Explanation: You specified a logical database. Its DBD specifies KEY sensitivity for both the logical child and destination parent of a concatenated segment or KEY sensitivity for a nonconcatenated segment. FM/IMS does not support the Edit of logical databases with such segments.

User response: No action is required.

FMNIA123

REPEAT/INSERT not allowed - REPEAT/INSERT of a concatenated segment is only supported when DATA sensitivity has been specified for both the logical child and the destination parent.

Explanation: You have requested the insertion of a concatenated segment into the logical database. However, FM/IMS did not attempt to insert the segment, because the DBD does not specify DATA sensitivity for both the logical child and the destination parent of the concatenated segment. IMS only supports the insertion of a concatenated segment when the DBD specifies DATA sensitivity for both parts of the concatenated segment.

User response: No action is required.

FMNIA124

No logical relationships - No relationship criteria exist because the database has no logical relationships.

Explanation: You issued the E line command against the relationship criteria subset. This is a request to edit the relationship criteria. However, the request cannot be honored because there are no relationship criteria. Only databases with logical relationships have relationship criteria, and this database has no logical relationships.

User response: No action is required.

FMNIA125

IMS log data set deleted - The IMS log data set &DSN has been deleted.

Explanation: The IMS log data set that the Edit session used (&DSN) has been deleted. The data set is deleted when the Edit session ends normally, and you select Delete for the IMS log option on the Edit Entry panel.

User response: No action is required.

FMNIA126

IMS log data set kept - The IMS log data set &DSN has been kept.

Explanation: The IMS log data set that the Edit session used (&DSN) has been kept. The data set is kept when you select Keep for the IMS log option on the Edit Entry panel. It is also kept when the Edit session does not end normally.

User response: No action is required.

FMNIA127

Chkpt &ID taken - A checkpoint with ID &ID was written to the IMS log.

Explanation: This message is issued when you issue the SAVE command on the Database Positioning panel. It is also issued when the Database Positioning panel is first displayed if, as is normally the case, FM/IMS takes a checkpoint at the start of the Edit session. With one exception, checkpoint messages are not issued on the IMS data panel. The checkpoint ID in the CHKPT field is incremented when a checkpoint is taken, so they are not required on that panel. The exception occurs when checkpoints are taken during a Change All, or Repeat All, operation.

User response: No action is required.

FMNIA128

Delete unsuccessful - The Delete was unsuccessful because the GET HOLD call failed to retrieve the segment.

Explanation:

You issued the D line command, but the attempt to delete the segment on that line was unsuccessful because the GET HOLD call failed. Depending on the status code that the GET HOLD call receives, FM/IMS either displays a pop-up panel, or issues a message before it issues this message.

- If the GET HOLD call receives the GE status code, then the Segment Update/Delete Warning pop-up panel is displayed.
- If the GET HOLD call receives the FH or BA status code, then the Unavailable Segment Warning pop-up panel is displayed.
- Otherwise, a message is issued that tells you the status code that the GET HOLD call received.

User response: See the previous message pop-up panel for information on the cause of this failure.

FMNIA129

No segments selected - View must have at least one segment selected

Explanation: You attempted to save or use a view that has all its segments deselected. A view that has all its segments deselected would not return any segments, so FM/IMS does not allow you to do this.

User response: Select at least one segment.

FMNIA130

Invalid command syntax - The DEPENDENT, SEGMENT and REC parameters are not supported in ZOOM mode.

Explanation: You issued a FIND, or CHANGE, command with the DEPENDENT, SEGMENT, or REC parameter when in ZOOM mode. The DEPENDENT, SEGMENT, and REC parameters are not supported in ZOOM mode.

User response: Get out of ZOOM mode, then issue the command again. To get out of ZOOM mode, press the EXIT key or the CANCEL key, or issue the ZOOM command.

FMNIA131

Criteria set updated - Criteria set received updates from the template it was created from. The template is in data set member &DSN.

Explanation: The template that the criteria set was created from had been modified since the criteria set was last updated, so the criteria set was updated as you requested. The template that the criteria set was created from is in data set member &DSN.

User response: No action is required.

FMNIA132

Checkpoint &ID taken. Uncommitted changes made during this Edit session have been saved.

Explanation: Some database changes that you made during this Edit session had not been committed when you used the EXIT key to leave the Database Positioning panel. Because you pressed the EXIT key, the uncommitted changes were saved.

User response: No action is required.

FMNIA133

DBD member not found - The DBD for database &DBNAME not found in the DBD libraries for subsystem &SSID.

Explanation: FM/IMS requires the DBD for the specified database (&DBNAME), but it was not found in the DBD libraries for the specified subsystem (&SSID).

User response: The DBD libraries for subsystem &SSID are specified on the PSB and DBD Data Sets panel (option 0.6.7). Either include a DBD for database &DBNAME in one of the DBD libraries listed on that panel, or update this list to include a DBD library that has a DBD for database &DBNAME. You will only be able to update the list when the DBD libraries for the subsystem are not fixed. When the DBD libraries for the subsystem are fixed, the DBD data set names panel fields are protected, and only the FM/IMS administrator can update this list.

FMNIA134

No segments selected - Criteria subset must have at least one segment selected.

Explanation: You attempted to exit the criteria subset with all its segments deselected. A subset with all its segments deselected would not return any segments, so FM/IMS does not allow you to do this.

User response: Pressing the CANCEL key will allow you to exit, but the changes you have made to the subset will not be saved. If you want your changes to be saved when you exit, select at least one segment, then press the EXIT key.

FMNIA135

No layouts selected - Criteria subset must have at least one segment layout selected.

Explanation: You attempted to exit the criteria subset with all its segment layouts deselected. A subset with all its segment layouts deselected would not return any segments, so FM/IMS does not allow you to do this.

User response: Pressing the CANCEL key will allow you to exit, but the changes you have made to the subset will not be saved. If you want your changes to be saved when you exit, select at least one segment layout, then press the EXIT key.

FMNIA136

The PCB you are using does not allow segment insertion.

Explanation: You have issued the INSERT primary command, but the PCB that you are using does not allow segment insertion.

User response: Use a PCB that allows segment insertion.

FMNIA137

Missing segments - Database &DBNAME has segments that are not defined in the template.

Explanation: The DBD that this template is based on has segments that are not defined in this template. Updating the template will rectify this. FM/IMS will not allow you to use this template to create views, or criteria sets, until you have updated it.

User response: Using option 4.1, or option 4.4, update the template.

FMNIA138

Missing segments - Database &DBNAME has segments that are not defined in the view/criteria set. Update the view/criteria set and, if this fails to remedy the problem, update the template &DSN that the view/criteria set was created from then update the view/criteria set again.

Explanation: &DBNAME is the name of the database that the view or criteria set is for. The DBD for this database has segment types that are not defined in the view or criteria set.

User response: Use View update (option 4.5) to update the view, using the IMS template that the view was created from. If after successful completion the IMS segments are still missing, you will need to update the IMS template &DSN to include the new IMS segments using Templates (option 4.1). Repeat the process of updating the view using View update (option 4.5).

FMNIA139

Warning: The view/criteria set was not based on the latest version of the template it was created from.

Explanation: A batch function issues this warning message when it determines that the view/criteria set is not based on the latest version of the template it was created from. The batch function ignores this error and continues processing.

User response: Check the output from the job. Update the view/criteria set. To update a view use either option 4.2, or option 4.5. To update a criteria set, use option 4.3, or option 4.6.

FMNIA149

CANCEL not active - The CANCEL command is not active because no IMS log data set was allocated at the start of the Edit session.

Explanation: Some database changes that you made during this Edit session have not been committed. You issued the CANCEL command on the Database Positioning panel, which indicates that you want these changes backed out. However, IMS cannot back out these changes, because an IMS log was not allocated at the start of the Edit session.

User response: If you want the option of discarding your uncommitted changes when editing in DLI mode, you must select Keep, or Delete, for the IMS log option on the Edit Entry panel.

FMNIA150

CANCEL not active - The CANCEL command is not active because your Edit session did not request dynamic backout.

Explanation: Some database changes that you made during this Edit session have not been committed. You issued the CANCEL command on the Database Positioning panel, which indicates that you want these changes backed out. However, IMS cannot back out these changes, because your Edit session did not request dynamic backout.

User response: If you want the option of discarding your uncommitted changes when editing in DLI mode, you must select the Dynamic backout option on the DLI Mode Parameters panel. What you are specifying on this panel is the subsystem setting for the Dynamic backout option, so ensure that it is selected for each subsystem that you require it for.

FMNIA152

RESLIB &DSN not found. Correct the RESLIBx parameter for subsystem &SSID in FMN1POPT.

Explanation: The function attempted to use the default RESLIB data sets for subsystem &SSID. However, one of these data sets (&DSN) could not be found. The default RESLIB data sets are specified in the FM/IMS installation options module.

User response: Ask the FM/IMS administrator to correct the RESLIB parameter on the FMN1POPI macro statement for subsystem &SSID, and then reassemble and link-edit the FM/IMS installation options module.

FMNIA153

RESLIB &DSN not a loadlib. Correct the RESLIBx parameter for subsystem &SSID in FMN1POPT.

Explanation: The function attempted to use the default RESLIB data sets for subsystem &SSID. However, one of these data sets (&DSN) is not a load library. The default RESLIB data sets are specified in the FM/IMS installation options module.

User response: Ask the FM/IMS administrator to correct the RESLIB parameter on the FMN1POPI macro statement for subsystem &SSID, and then reassemble and link-edit the FM/IMS installation options module.

FMNIA154

RESLIB &DSN for &SSID not found. Correct the data set name on the DLI Mode Data Sets 1 panel.

Explanation: The function attempted to use the RESLIB data sets for subsystem &SSID, specified on the DLI Mode Data Sets 1 panel. However, one of these data sets (&DSN) could not be found.

User response: Correct the data set name on the DLI Mode Data Sets 1 panel (option 0.6.2).

FMNIA155

DOPT ACBLIB &DSN not found. Correct the DYNACB parameter for subsystem &SSID in FMN1POPT.

Explanation: The function attempted to use the DOPT ACBLIB data set (&DSN) for subsystem &SSID. However, the data set could not be found. The DOPT ACBLIB data set is specified in the FM/IMS installation options module.

User response: Ask the FM/IMS administrator to correct the DYNACB parameter on the FMN1POPI macro statement for subsystem &SSID, and then reassemble and link-edit the FM/IMS installation options module.

FMNIA156

CANCEL not active - The CANCEL command is not active because the PSB that your Edit is using has no IO PCB.

Explanation: Some database changes that you made during this Edit session have not been committed. You issued the CANCEL command on the Database Positioning panel, which indicates that you want these changes backed out. However, IMS cannot back out these changes because the PSB that your Edit is using has no IO PCB.

User response: If you want the option of discarding your uncommitted changes when editing in DLI mode, you must use a PSB that has an IO PCB.

FMNIA158

No PCB selected - A PCB is required and no PCB has been selected.

Explanation: You left the PCB Selection panel without selecting a PCB.

User response: If you want to use the PSB that you specified, you must either select one of the PCBs displayed on the PCB Selection panel, or specify in the Database name field, the name of a database that the PSB can give you access to.

FMNIA159

DBD &DBNAME not found - This PSB has a PCB for the database &DBNAME and its DBD was not found in the DBD libraries for subsystem &SSID.

Explanation: FM/IMS requires the DBD for each database specified in the PSB to be in the DBD libraries for the specified subsystem (&SSID). The PSB has a PCB for database &DBNAME, but the DBD for database &DBNAME was not found in the DBD libraries for subsystem &SSID.

User response: The DBD libraries for subsystem &SSID are specified on the PSB and DBD Data Sets panel (option 0.6.7). Either include a DBD for database &DBNAME in one of the DBD libraries listed on that panel, or update this list to include a DBD library that has a DBD for database &DBNAME. You will only be able to update the list when the DBD libraries for the subsystem are not fixed. When the DBD libraries for the subsystem are fixed, the DBD data set names panel fields are protected, and only the FM/IMS administrator can update the list.

FMNIA162

Not a DLI region PSB - PSB cannot be used in DLI mode because it has a PCB for a Fast Path database.

Explanation: You have selected DLI for the Region type. However, the PSB that you specified cannot be used when the function is run in a DL/I batch processing region because it has a PCB for a Fast Path database.

User response: Select BMP for the Region type or use another PSB.

FMNIA163

PSB &PSBNAME has only one DB PCB and the PCB is read-only; the function cannot be performed with a read-only PCB.

Explanation: The PSB that you have specified (&PSBNAME) has only one DB PCB. The function you are using cannot use this PCB because it requires update access to databases, and the PCB only provides read access.

User response: Use a PSB with a PCB that provides update access to the database that you want the function to process.

FMNIA170

PCB for database &DBNAME has PROCOPT=&OPT; the function cannot be performed with a read-only PCB.

Explanation: The PSB that you have specified has only one PCB for the database that you specified (&DBNAME). The function you are using cannot use this PCB because it requires update access to this database, and the PCB only provides read access.

User response: Use a PSB with a PCB that provides update access to the database.

FMNIA171

SAVE not active - the SAVE command is not active because the PSB that your Edit is using has no IO PCB.

Explanation: You issued the SAVE command. This is a request to save all your uncommitted database changes. To do this FM/IMS issues a checkpoint call. However, a checkpoint cannot be taken because the PSB your Edit is using has no IO PCB.

User response: Your changes are saved when you return to the Edit Entry panel. This is the only way you can save your changes when the PSB has no IO PCB. If you want to use the SAVE command when editing in DLI mode, you must use a PSB that has an IO PCB.

FMNIA172

&CMD not active - &CMD command is not active when in ZOOM mode.

Explanation: You are in ZOOM mode and the command you issued (&CMD) is not supported in ZOOM mode.

User response: Get out of ZOOM mode, then issue the command again. To get out of ZOOM mode, press the EXIT key, or CANCEL key, or issue the ZOOM command.

FMNIA173

Segment not a parent - The segment name specified in the PARENT command must be the name of a parent of the current segment type.

Explanation: You issued the PARENT command. The PARENT command changes your position from the current segment occurrence, to a parent of the current segment occurrence. However, the segment name you specified in the PARENT command is not the name of a parent of the current segment type.

User response: Specify the name of a parent of the current segment type.

FMNIA174

Child not found - The requested child segment occurrence was not found.

Explanation: You issued the CHILD command. The CHILD command allows you to change your position from the current segment occurrence to any of its dependent segment occurrences. However, FM/IMS could not find the child segment occurrence that you requested.

User response: No action is required.

FMNIA176

Segment not found - No segment was found that has keys greater than or equal to the specified key values.

Explanation: FM/IMS issued a GU call for the segment you selected on the Database Positioning panel, but the call received a GE status code. IMS returns this status code when it cannot find a segment that satisfies the segment search arguments (SSAs) specified in this call. The following describes the SSAs used in the call:

- There was an SSA for the selected segment, and an SSA for each of its parents.
- If the Key Value field for a segment in the path so defined contained spaces or low values, then an unqualified SSA was used at that level.
- If the Key Value field for the root segment did not contain spaces, or low values, and you are accessing the database via a secondary index, then the SSA at the root level has a qualification statement that specifies the secondary index key field, a greater-than-or-equal-to relational operator, and the specified key value.
- Otherwise, the SSA has a qualification statement that specifies the key field of the segment, a greater-than-or-equal-to relational operator, and the specified key value.

These SSAs are used when you press the GE (Greater than or Equal to) key, and the root segments of the database are in key, or a secondary processing, sequence.

User response: No action is required.

FMNIA177

Segment not found - No segment was found that has a root key equal to the specified root key value and dependent segment keys greater than or equal to the specified dependent segment key values.

Explanation: FM/IMS issued a GU call for the dependent segment you selected on the Database Positioning panel, but the call received a GE status code. IMS returns this status code when it cannot find a segment that satisfies the segment search arguments (SSAs) specified in this call. The following describes the SSAs used in the call:

- There was an SSA for the selected segment, and an SSA for each of its parents.
- If the Key Value field for a segment in the path so defined contained spaces, or low values, then an unqualified SSA was used at that level.
- If the Key Value field for the root segment did not contain spaces, or low values, then the SSA at the root level has a qualification statement that specifies the root key field, an equal-to relational operator, and the specified key value.
- If the Key Value field for a dependent segment did not contain spaces, or low values, then the SSA for the dependent segment has a qualification statement that specifies the key field of the segment, a greater-than-or-equal-to relational operator, and the specified key value.

These SSAs are used in the call when you press the GE (Greater than or Equal to) key, and the root segments of the database are not in key, or a secondary processing, sequence.

User response: No action is required.

FMNIA178

Segment not found - No segment was found with the specified key values.

Explanation: FM/IMS issued a GU call for the segment you selected on the Database Positioning panel, but the call received a GE status code. IMS returns this status code when it cannot find a segment that satisfies the segment search arguments (SSAs) specified in this call. The following describes the SSAs used in the call:

- There was an SSA for the selected segment, and an SSA for each of its parents.
- If the Key Value field for a segment in the path so defined contained spaces, or low values, then an unqualified SSA was used at that level.
- If the Key Value field for the root segment did not contain spaces, or low values, and you are accessing the database via a secondary index, then the SSA at the root level has a qualification statement that specifies the secondary index key field, an equal-to relational operator, and the specified key value.
- Otherwise, the SSA has a qualification statement that specifies the key field of the segment, an equal-to relational operator, and the specified key value.

These SSAs are used in the call when you press the Enter key on the Database Positioning panel.

User response: No action is required.

FMNIA179

Segment not found - No root segment was found with the specified key value. FM/IMS did not search for a root segment with a key greater than or equal to the specified key value because the root segments are not in key sequence.

Explanation: FM/IMS issued a GU call for the root segment you selected on the Database Positioning panel, but the call received a GE status code. IMS returns this status code when it cannot find a segment that satisfies the segment search arguments (SSAs) specified in this call. The following describes the SSAs used in the call:

- If the Key Value field for the root segment contained spaces, or low values, then an unqualified SSA was used at the root level.
- Otherwise, the SSA, at the root level, has a qualification statement that specifies the root key field of the segment, an equal-to relational operator, and the specified key value.

This message is only issued when you select a root segment, you press the GE (Greater than or Equal to) key, and the root segments of the database are not in key, or a secondary processing, sequence.

User response: No action is required.

FMNIA181

EDIT not active - The Edit line command is only active when the Edit or Browse is using a view.

Explanation: You issued the E (Edit) line command on the Database Positioning panel. This is a request to edit a segment in the view that your Edit or Browse is using. However, your request cannot be honored because the Edit or Browse is not using a view.

User response: If you want the Edit/Browse to use a view, return to the Edit/Browse Entry panel and select New, or Existing, for the View usage.

FMNIA184

SELECT not active - The SELECT command is only active when the Edit or Browse is using a view.

Explanation: You issued the SELECT primary, or line, command on the Database Positioning panel. This is a request to select or deselect segments in the view that your Edit or Browse is using. However, your request cannot be honored because the Edit or Browse is not using a view.

User response: If you want the Edit/Browse to use a view, return to the Edit/Browse Entry panel and select New, or Existing, for the View usage.

FMNIA185

UNDO not active - The UNDO command is not active because no IMS log data set was allocated at the start of the Edit session.

Explanation: You issued the UNDO command. This is a request to back out all the database changes you have made since the last checkpoint. However, IMS cannot back out your changes because no IMS log data set was allocated at the start of the Edit session.

User response: If you want to use the UNDO command when editing in DLI mode, you must select Keep, or Delete, for the IMS log option on the Edit Entry panel.

FMNIA186

No updates - You issued the UNDO command but you have not made any database changes since the last checkpoint or rollback, so FM/IMS did not issue a rollback call.

Explanation: You issued the UNDO command. This is a request to back out all the database changes you have made since the last checkpoint, or rollback. To do this, FM/IMS issues a rollback (ROLB) call. However, there have been no database changes since the last checkpoint, or rollback, so FM/IMS did not issue a ROLB call.

User response: No action is required.

FMNIA187

UNDO not active - The UNDO command is not active because your Edit session did not request dynamic backout.

Explanation: You issued the UNDO command. This is a request to back out all the database changes you have made since the last checkpoint. However, IMS cannot back out your changes because your Edit session did not request dynamic backout.

User response: If you want to use the UNDO command when editing in DLI mode, you must select the Dynamic backout option on the DLI Mode Parameters panel. What you are specifying on this panel is the subsystem setting for the Dynamic backout option, so ensure that it is selected for each subsystem that you require it for.

FMNIA188

UNDO not active - The UNDO command is not active because the PSB that your Edit is using has no IO PCB.

Explanation: You issued the UNDO command. This is a request to back out all the database changes you have made since the last checkpoint. However, IMS cannot back out your changes because the PSB that your Edit is using has no IO PCB.

User response: If you want to use the UNDO command when editing in DLI mode, you must use a PSB that has an IO PCB.

FMNIA189

VSAVE not active - The VSAVE command is only active when the Edit or Browse is using a view.

Explanation: You issued the VSAVE command. This is a request to save the view that your Edit or Browse is using. However, your request cannot be honored because the Edit or Browse is not using a view.

User response: If you want the Edit/Browse to use a view, return to the Edit/Browse Entry panel and select New or Existing for the View usage.

FMNIA415

Create/Edit failed - Create/Edit failed because DBDLIB &DSN is not a PDS(E). Use option 4.1 or option 4.4 to update the DBDLIBs specified in the template that the view/criteria set was created from, then update the view/criteria set.

Explanation: The CM command (Create view/criteria set from model) failed because one of the DBDLIB data sets (&DSN) specified in the model view/criteria set is not a PDS(E) or the E command (Edit view/criteria set) failed because one of the DBDLIB data sets (&DSN) specified in the view/criteria set is not a PDS(E).

User response: Use option 4.1 or option 4.4 to correct the DBDLIB data set name specified in the template that the view/criteria set was created from then use option 4.2/4.3 to update the view/criteria set.

FMNIA416

Create/Edit failed - Create/Edit failed because DBDLIB &DSN. is not a loadlib. Use option 4.1 or option 4.4 to update the DBDLIBs specified in the template that the view/criteria set was created from, then update the view/criteria set.

Explanation: The CM command (Create view/criteria set from model) failed because one of the DBDLIB data sets (&DSN) specified in the model view/criteria set is not a loadlib or the E command (Edit view/criteria set) failed because one of the DBDLIB data sets (&DSN) specified in the view/criteria set is not a loadlib.

User response: Use option 4.1 or option 4.4 to correct the DBDLIB data set name specified in the template that the view/criteria set was created from then use option 4.2/4.3 to update the view/criteria set.

FMNIA417

Create/Edit failed - Create/Edit failed because DBDLIB &DSN was not found in the catalog. Use option 4.1 or option 4.4 to update the DBDLIBs specified in the template that the view/criteria set was created from, then update the view/criteria set.

Explanation: The CM command (Create view/criteria set from model) failed because one of the DBDLIB data sets (&DSN) specified in the model view/criteria set was not found in the catalog or the E command (Edit view/criteria set) failed because one of the DBDLIB data sets (&DSN) specified in the view/criteria set was not found in the catalog.

User response: Use option 4.1 or option 4.4 to correct the DBDLIB data set name in the template that the view/criteria set was created from then use option 4.2/4.3 to update the view/criteria set.

FMNIA453

Not partitioned - Member name specified, but the data set is not partitioned.

Explanation: A member name was specified with a data set which is not partitioned.

User response: Remove the member name, or verify that the data set was correctly specified and correctly allocated.

FMNIA454

Member &MBR. specified, but &PARM data set &DSN is not partitioned.

Explanation: The data set specified in the &PARM parameter is not partitioned, but a member name was specified for the data set (either in the &PARM parameter or in the associated member parameter).

User response: Remove the member name from the &PARM parameter, or remove the member parameter specification from the FMNIMSIN input, or verify that the data set was correctly specified and correctly allocated.

FMNIA455

Not partitioned - The data set must be partitioned.

Explanation: Self explanatory.

User response: Specify a PDS(E).

FMNIA458

Member &MBR. was not found in &PARM data set &DSN.

Explanation: The member &MBR was not found in the directory of the data set (&DSN) specified in the &PARM parameter.

User response: Specify a member that is in the directory of the data set.

FMNIA459

&PARM data set &DSN is partitioned. You must specify a member.

Explanation: The data set specified in the &PARM parameter is partitioned, but no member was specified.

User response: Specify the member name either in parenthesis after the data set name or in the associated member parameter, or verify that the data set was correctly specified and correctly allocated.

FMNIA460

Member not found - Member &MBR was not found in data set &DSN.

Explanation: Self explanatory.

User response: Specify a member that is in the data set.

FMNIA999

File Manager problem - message &MSG not found in table

Explanation: File Manager cannot find the message number nnnn in the message table. This is probably a File Manager error.

User response: Contact your system support.

FMNIB283

Segment not found - The segment was not found using the specified key values and occurrence numbers.

Explanation: The key values and occurrence numbers specified on the key specification panel resulted in FM/IMS not finding the segment in the IMS database.

User response: Modify the key values and occurrence numbers to retrieve the require IMS segment.

FMNIB290

PREV limited due to scope - The scope of the PREVIOUS command is limited to the beginning of the current database record

Explanation: The scope of the records has been limited to only show the segments for a single root segment (database record) by setting the 'Set SCOPE REC' field in 'Edit Options' (option 0.5) or issuing the 'SCOPE REC' or 'SCOPE DBREC' command in the browse/edit session. Hence when scrolling up using the PREVIOUS command you will not be able to scroll up past the root segment or the first segment displayed for the database record (if segments excluded).

User response: To position on a previously displayed record use the KEY command to position on the required segment.

FMNIB291

Top of window reached

Explanation: The PREVIOUS command was entered and you are currently positioned at the beginning of the database or if you entered key values on the 'Database Positioning' panel you are back at your starting position in the IMS database. Scrolling backwards is not possible.

User response: If you entered key values on the Database positioning panel and want to specify a new starting position you can either return to the 'Database Positioning' panel or enter the KEY command while in the browse/edit session.

FMNIB292

End of database reached

Explanation: The NEXT command was entered and you are currently positioned at the end of the database, scrolling forwards is not possible.

User response: No action is required.

FMNIB293

Non-replace PCB - The function, which requires Replace permission, cannot be performed with the PCB's PROCOPT.

Explanation: The Static PSB's PCB for the IMS database being accessed has not got replace permission specified in PCB's PROCOPT parameter. The function using this Static PSB will not be able to update IMS segments.

User response: If the IMS segments are required to be updated, you will need to specify a different PCB for the IMS database with the required permissions either in the same static PSB or different static PSB. If available a Dynamic PSB can be used by the function to access the IMS database, FM/IMS will generate a PSB with the required permissions. To use a dynamic PSB specify 'Dynamic' for the PSB type in System settings (option 0.2).

FMNIB294

Load error: The load file includes a record for index database &DBD ; records for indexes should not be included.

Explanation: The load file has records which were extracted from an IMS index database. IMS Index databases are not able to loaded in FM/IMS.

User response: No action is required.

FMNIB295

DELIMS/REPLIMS failed with segment &SEGM because PCB &PCBN of PSB &PSB has PROCOPT &POPT.

Explanation: The DELIMS or REPLIMS function call in the batch IEB job failed as the &PCB PCB of static PSB &PSB did not have delete (for DELIMS) or replace (for REPLIMS) permission for the IMS database specified in the PCB's PROCOPT parameter.

User response: Modify the batch IEB job to specify a PCB (PCBNUM) and static PSB (PSBMEM) with the required permissions for the IMS database. If available a dynamic PSB could be used by the batch IEB job to update the IMS database.

FMNIB296

PSB &PSBMBR. has multiple PCBs for related database &DBD ; specify the PCB you want used in PCBNUM or PCBNAME parameter.

Explanation: The IMS database extract (IXB) uses a static PSB which has multiple PCBs for the logically related database &DBD and you have not specified a PCB for the PCBNUM or PCBNAME parameters in the FMNIMSIN control cards which references the IMS database &DBD.

User response: Update the PCBNUM or PCBNAME parameter on the FMNIMSIN control card to reference the IMS database &DBD. For more information on these parameters, see [Extract \(IXB\) on page 539](#).

FMNIB297

PSB &PSBMBR has multiple PCBs for primary database &DBD ; specify the PCB you want used in PCBNUM or PCBNAME parameter.

Explanation: The IMS database extract (IXB) uses a static PSB which has multiple PCBs for the primary database &DBD and you have not specified a PCB for the PCBNUM or PCBNAME parameters in the FMNIMSIN control cards which references the IMS database &DBD.

User response: Update the PCBNUM or PCBNAME parameter on the FMNIMSIN control card to reference the IMS database &DBD. For more information on these parameters, see [Extract \(IXB\) on page 539](#).

FMNIB298

Load using an alternate processing sequence is not supported.

Explanation: The PCB for the DBD being loaded using the Static PSB specifies a secondary index (PROCSEQ in the PSB). An alternate process sequence (secondary index) is not allowed when loading an IMS database.

User response: Specify a static PSB/PCB that does not specify a secondary index (PROCSEQ in the PSB) for the IMS databases (including logically related databases) being loaded.

FMNIB532

Function terminated because auditing to SMF failed, BPX1SMF call returned RC=&RC Reason Code=&RC(Dec)

Explanation: FM/IMS is set up to write audit records to SMF for the current function. A failure occurred while attempting to write an audit record to SMF. The BPX1SMF call resulted in return code &RC and reason code &RC, both expressed in decimal. The current function may be terminated.

User response:

This error usually indicates a set-up problem. Possible reason for an auditing failure to SMF are:

1. The userid does have READ access to the SAF FACILITY class profile BPX.SMF.
2. The FMN1POPT module does not have a valid number specified for the SMFNO parameter.

Consult the systems programmer for assistance in resolving the cause of the error.

FMNIB835

&CMD not allowed - The &CMD of this segment is not allowed because it may cause a U0828 abend (duplicate segments in a unique secondary index). The &CMD of this segment is allowed when the dynamic backout option on the DLI Mode Settings panel is selected and you use an IMS log.

Explanation: The insert/repeat (&CMD) is not allowed because you are attempting to insert an IMS segment that is the source for a secondary index and it might create a duplicate index entry.

User response: No action is required.

FMNIB836

&CMD not allowed - The &CMD of this segment is not allowed because it is the target of the secondary index that your Edit is using.

Explanation: The delete/insert/repeat (&CMD) is not allowed because you are attempting to insert or delete an IMS root segment that is the target for a secondary index or one of its physical parents and it might create a duplicate index entry.

User response: No action is required.

FMNIB837

&CMD not allowed - The &CMD of this segment is not allowed because it is a physical parent of the target of the secondary index that your Edit is using.

Explanation: The delete/insert/repeat (&CMD) is not allowed because you are attempting to insert or delete an IMS non-root segment that is the target for a secondary index or one of its physical parents and it might create a duplicate index entry.

User response: No action is required.

Appendix B. Support resources

Use these resources to find product details, fixes, and support.

Search knowledge bases

- Download a Program Directory:
 - [Program Directory for Application Delivery Foundation for z/OS Common Components](#)
 - [Program Directory for IBM File Manager for z/OS](#)
 - [Program Directory for IBM Fault Analyzer for z/OS](#)
- Get up-to-date details about installing, customizing, and using these products:
 - [Application Delivery Foundation for z/OS Common Components Customization Guide and User Guide](#)
 - [Fault Analyzer User's Guide and Reference](#)
 - [File Manager Customization Guide](#)
 - [File Manager User's Guide and Reference](#)
 - [File Manager User's Guide and Reference for DB2](#)
 - [File Manager User's Guide and Reference for CICS](#)
 - [File Manager User's Guide and Reference for IMS](#)

Get the latest PTFs

- [ADFz Common Components](#)
- [Fault Analyzer for z/OS](#)
- [File Manager for z/OS](#)
- [z/OS Debugger](#)
- [IBM Developer for z/OS Enterprise Edition](#)
- [Application Performance Analyzer for z/OS](#)

Collect diagnostic data

Before you contact Support, be ready to answer these questions:

- What software versions are you running?
- Do you have logs, traces, and messages related to the problem?
- Can you re-create the problem? If so, how do you re-create the problem?
- Did you make hardware, operating system, or networking software changes?
- Do you have a workaround for the problem?

Contact Support

Open a case, chat with Support, or connect to resources and communities through <https://www.ibm.com/mysupport>.

Notices

IBM File Manager for z/OS License Materials - Property of IBM Corp. and HCL Technologies Ltd. © Copyright IBM Corporation 2000, 2016. © Copyright HCL Technologies Limited 2017, 2024

This information was developed for products and services offered in the U.S.A.

IBM® may not offer the products, services, or features discussed in this document in other countries. Consult your local IBM representative for information on the products and services currently available in your area. Any reference to an IBM product, program, or service is not intended to state or imply that only that IBM product, program, or service may be used. Any functionally equivalent product, program, or service that does not infringe any IBM intellectual property right may be used instead. However, it is the user's responsibility to evaluate and verify the operation of any non-IBM product, program, or service.

IBM may have patents or pending patent applications covering subject matter described in this document. The furnishing of this document does not give you any license to these patents. You can send license inquiries, in writing, to:

*IBM Director of Licensing
IBM Corporation
North Castle Drive, MD-NC119
Armonk, NY 10504-1785
US*

For license inquiries regarding double-byte (DBCS) information, contact the IBM Intellectual Property Department in your country or send inquiries, in writing, to:

*Intellectual Property Licensing
Legal and Intellectual Property Law
IBM Japan Ltd.
19-21, Nihonbashi-Hakozakicho, Chuo-ku
Tokyo 103-8510, Japan*

INTERNATIONAL BUSINESS MACHINES CORPORATION PROVIDES THIS PUBLICATION "AS IS" WITHOUT WARRANTY OF ANY KIND, EITHER EXPRESS OR IMPLIED, INCLUDING, BUT NOT LIMITED TO, THE IMPLIED WARRANTIES OF NON-INFRINGEMENT, MERCHANTABILITY OR FITNESS FOR A PARTICULAR PURPOSE. Some jurisdictions do not allow disclaimer of express or implied warranties in certain transactions, therefore, this statement may not apply to you.

This information could include technical inaccuracies or typographical errors. Changes are periodically made to the information herein; these changes will be incorporated in new editions of the publication. IBM may make improvements and/or changes in the product(s) and/or the program(s) described in this document at any time without notice.

Any references in this information to non-IBM websites are provided for convenience only and do not in any manner serve as an endorsement of those websites. The materials at those websites are not part of the materials for this IBM product and use of those websites is at your own risk.

dcxc

IBM may use or distribute any of the information you provide in any way it believes appropriate without incurring any obligation to you.

Licensees of this program who want to have information about it for the purpose of enabling: (i) the exchange of information between independently created programs and other programs (including this one) and (ii) the mutual use of the information which has been exchanged, should contact:

IBM Director of Licensing
IBM Corporation
North Castle Drive, MD-NC119
Armonk, NY 10504-1785
US

Such information may be available, subject to appropriate terms and conditions, including in some cases, payment of a fee.

The licensed program described in this information and all licensed material available for it are provided by IBM under terms of the IBM Customer Agreement, IBM International Program License Agreement, or any equivalent agreement between us.

The performance data discussed herein is presented as derived under specific operating conditions. Actual results may vary.

Information concerning non-IBM products was obtained from the suppliers of those products, their published announcements or other publicly available sources. IBM has not tested those products and cannot confirm the accuracy of performance, compatibility or any other claims related to non-IBM products. Questions on the capabilities of non-IBM products should be addressed to the suppliers of those products.

Statements regarding future direction or intent of IBM File Manager for z/OS are subject to change or withdrawal without notice, and represent goals and objectives only.

This information contains examples of data and reports used in daily business operations. To illustrate them as completely as possible, the examples include the names of individuals, companies, brands, and products. All of these names are fictitious and any similarity to the names and addresses used by an actual business enterprise is entirely coincidental.

COPYRIGHT LICENSE:

This information contains sample application programs in source language, which illustrates programming techniques on various operating platforms. You may copy, modify, and distribute these sample programs in any form without payment to IBM, for the purposes of developing, using, marketing or distributing application programs conforming to the application programming interface for the operating platform for which the sample programs are written. These examples have not been thoroughly tested under all conditions. IBM, therefore, cannot guarantee or imply reliability, serviceability, or function of these programs. The sample programs are provided "AS IS", without warranty of any kind. IBM shall not be liable for any damages arising out of your use of the sample programs.

Each copy or any portion of these sample programs or any derivative work must include a copyright notice as follows:

© (your company name) (year).

Portions of this code are derived from IBM Corp. and/or

HCL Ltd. sample programs.

© Copyright IBM Corp. 2000, 2016. © Copyright HCL Ltd. 2017, 2024.

Programming interface information

This documentation describes intended Programming Interfaces that allow the customer to write programs to obtain the services of File Manager.

Trademarks

IBM®, the IBM® logo, and ibm.com® are trademarks or registered trademarks of International Business Machines Corp., registered in many jurisdictions worldwide. Other product and service names might be trademarks of IBM® or other companies. A current list of IBM® trademarks is available on the web at "Copyright and trademark information" at www.ibm.com/legal/copytrade.shtml.

Terms and conditions for product documentation

Permissions for the use of these publications are granted subject to the following terms and conditions.

Applicability

These terms and conditions are in addition to any terms of use for the IBM® website.

Personal use

You may reproduce these publications for your personal, noncommercial use provided that all proprietary notices are preserved. You may not distribute, display or make derivative work of these publications, or any portion thereof, without the express consent of IBM®.

Commercial use

You may reproduce, distribute and display these publications solely within your enterprise provided that all proprietary notices are preserved. You may not make derivative works of these publications, or reproduce, distribute or display these publications or any portion thereof outside your enterprise, without the express consent of IBM®.

Rights

Except as expressly granted in this permission, no other permissions, licenses or rights are granted, either express or implied, to the publications or any information, data, software or other intellectual property contained therein.

IBM® reserves the right to withdraw the permissions granted herein whenever, in its discretion, the use of the publications is detrimental to its interest or, as determined by IBM®, the above instructions are not being properly followed.

You may not download, export or re-export this information except in full compliance with all applicable laws and regulations, including all United States export laws and regulations.

IBM® MAKES NO GUARANTEE ABOUT THE CONTENT OF THESE PUBLICATIONS. THE PUBLICATIONS ARE PROVIDED "AS-IS" AND WITHOUT WARRANTY OF ANY KIND, EITHER EXPRESSED OR IMPLIED, INCLUDING BUT NOT LIMITED TO IMPLIED WARRANTIES OF MERCHANTABILITY, NON-INFRINGEMENT, AND FITNESS FOR A PARTICULAR PURPOSE.

IBM Online Privacy Statement

IBM Software products, including software as a service solutions, ("Software Offerings") may use cookies or other technologies to collect product usage information, to help improve the end user experience, to tailor interactions with the end user, or for other purposes. In many cases no personally identifiable information is collected by the Software Offerings. Some of our Software Offerings can help enable you to collect personally identifiable information. If this Software Offering uses cookies to collect personally identifiable information, specific information about this offering's use of cookies is set forth below.

This Software Offering does not use cookies or other technologies to collect personally identifiable information.

If the configurations deployed for this Software Offering provide you as customer the ability to collect personally identifiable information from end users via cookies and other technologies, you should seek your own legal advice about any laws applicable to such data collection, including any requirements for notice and consent.

For more information about the use of various technologies, including cookies, for these purposes, see IBM's Privacy Policy at <http://www.ibm.com/privacy> and IBM's Online Privacy Statement at <http://www.ibm.com/privacy/details> in the section entitled "Cookies, Web Beacons and Other Technologies," and the "IBM Software Products and Software-as-a-Service Privacy Statement" at <http://www.ibm.com/software/info/product-privacy>.

Glossary

This publication includes definitions developed by the American National Standards Institute (ANSI) and the International Organization for Standardization (ISO). This material is reproduced from the *American National Dictionary for Information Processing*, copyright 1977 by the Computer and Business Equipment Manufacturers Association, copies of which can be purchased from the American National Standards Institute, 1430 Broadway, New York, New York 10018.

The following terms are defined as they are used in this manual. If you do not find the term you are looking for, refer to the Index or to the *IBM Dictionary of Computing*.

ANSI definitions are preceded by an asterisk.

A

across format

A FM/IMS dump format that has the same appearance as a system dump. To get this format for your listings, use the SET DUMP=ACROSS processing option.

action bar

The area at the top of a window that contains choices that give you access to choices available in that window.

ASCII

* American National Standard Code for Information Interchange. The standard code, using a coded character set consisting of 7-bit coded characters (8-bits including parity check), that is used for information interchange among data processing systems, data communication systems, and associated equipment. The ASCII set consists of control characters and graphic characters.

B

batch message processing (BMP) program

An IMS batch processing program that has access to on-line databases and message queues.

block

* A collection of contiguous records recorded as a unit. Blocks are separated by interblock gaps and each block may contain one or more logical records.

A block is a *physical record* but it may be composed of several contiguous *logical records* or parts of *logical records*.

blocking

The process of combining two or more *logical records* in one block.

BMP

Batch message processing

bounds

In edit and browse functions, the default *column range* within which commands operate. In edit functions, the bounds can be changed using the BOUNDS command. In browse functions, the bounds is the entire record.

buffer

A portion of storage used to hold input or output data temporarily.

C

cards

Lines in a batch job.

catalog

* A directory of files and libraries, with reference to their locations. A catalog may contain other information such as the types of devices in which the files are stored, passwords, and blocking factors. * To enter information about a file or library into a catalog.

column range

In edit and browse functions, the left and right columns that control which data is processed by edit commands. With some edit and browse commands, you can specify a column range to override the *bounds*.

Common User Access® (CUA®) architecture

Guidelines for the dialog between a person and a workstation or terminal.

console

See *operator console*.

control interval

A fixed-length area of direct access storage in which VSAM stores records and creates distributed free space. Also, in a key-sequenced data set or file, the set of records pointed to by an entry in the sequence-set index record. The control interval is the unit of information that VSAM transmits to or from direct access storage. A control interval always comprises an integral number of *physical records*.

copybook

In general, a copybook is a file containing a sequence of code that is included in a source program at compile time. In FM/IMS, the term "*copybook*" refers specifically to a file containing descriptions of record structures.

cylinder

The tracks of a disk storage device that can be accessed without repositioning the access mechanism.

D

data definition (DD) statement

A job control statement describing a data set associated with a specific job step.

data definition name (ddname)

The name of a data definition (DD) statement that corresponds to a data control block that contains the same name.

data-in-virtual data set

A data set that is considered a continuous stream of uninterrupted data.

DBCS

Double-byte character set.

DBD

Database description.

deblocking

The process of making each *logical record* of a block available for processing. Contrast with *blocking*.

E**EBCDIC**

* Extended Binary-Coded Decimal Interchange Code. A coded character set consisting of 8-bit coded characters.

excluded record

In edit functions, a record that has been excluded from display using the EXCLUDE *primary command* or the X *line command*.

extended help

Help text that applies to an entire function or panel. Contrast with *field help*.

extent

Continuous space on a disk that is occupied by or reserved for a particular data set, data space, or file.

F**field help**

Help text that applies to a specific entry field, parameter, or term. Contrast with *extended help*.

field mapping

The relationship between fields in the *“from”* data set and fields in the *“to”* data set. Field mapping defines which fields in the *“from”* data set are copied to which fields in the *“to”* data set. The field mapping is defined using the Template Workbench.

field range

When data is displayed in TABL or SNGL display format, specifies which fields an edit or browse command is to operate on.

file, tape

See *tape file*.

fill

See *character fill*.

I

IMS

Information Management System

interactive (processing)

Pertaining to an application in which each entry calls for a response from a system or program, as in an inquiry system or an airline reservation system. An interactive system may also be conversational, implying a continuous dialog between the user and the system.

K

KSDS

Key-sequenced data set.

L

label

A record that identifies a volume on tape or disk or that identifies a file on the volume.

line command

In full-screen mode, a command that you can enter on any *list panel* by typing the command over the beginning of a list entry.

linear data set

A named linear string of data, stored in such a way that it can be retrieved or updated in 4096-byte units.

list panel

In full-screen mode, a panel that displays a list of entries such as data sets, members, or objects, and that enables you to perform functions on one or more of the entries.

logical record

A record from the standpoint of its content, function, and use rather than its physical attributes, that is, a record defined in terms of the information it contains. In VSAM, a unit of information normally pertaining to a single subject; a logical record is the user record requested of or given to the data management function.

N

not-selected record

A record that has not been selected for processing by the function because it does not meet the record identification criteria or the record selection criteria.

object

In OAM, data consisting of a contiguous stream of bytes of arbitrary length, up to a maximum of 15 megabytes. The contents and internal structure of an object are defined by the application using it. Objects are increasingly used in image processing and other advanced application areas.

object collection

A collection of user-defined objects.

operator console

A functional unit containing devices that are used for communications between a computer operator and a computer.

O**OAM**

Object Access Method.

P**parameter string**

Two or more parameters separated by commas or blanks.

PDS

Partitioned data set.

physical record

A record whose characteristics depend on the manner or form in which it is stored, retrieved, or moved. A physical record may contain all or part of one or more *logical records*.

line commands

In full-screen mode, commands you enter in the prefix area of the panel. Line commands are used by FM/IMS edit functions.

primary command

In full-screen mode, commands you enter on the command line. FM/IMS provides common primary commands that are available across a range of functions, and function-specific primary commands, such as edit commands and browse commands.

Q**QSAM**

Queued Sequential Access Method, an access method for sequential data sets.

S**SAF**

System Authorization Facility, a system facility for security.

shadow line

In edit and browse functions, a line that indicates the position of records that have been excluded from display.

shift-out/shift-in

Characters that mark the beginning and end of double-byte character set data. The shift-out character is X'0E', and the shift-in character is X'0F'.

SMS

Storage Management Subsystem.

T**template**

A set of information that describes the format of segments in a database, how different segment types are identified, what segments and fields are to be selected for processing, and how fields are to be presented when displayed or printed.

U**updown format**

A FM/IMS dump format with hexadecimal representation of data in 3 lines: character, zone, and number. To get this format for your listings, use the SET DUMP=UPDOWN processing option.

utility program

A computer program in general support of computer processes; for example, a diagnostic program, a trace program, a sort program.

V**view**

A refined template. Several views can be defined using one template. In a view you can change the display width of a field, select fields you want displayed, displaying leading zeros on numeric fields, specify a field heading to use instead of the field name in the copybook and select the segments you want displayed.

volume

Tape volume: A reel of magnetic tape. Disk volume: A disk pack or part of a disk storage module.

volume serial number (volser)

A number in a volume label assigned when a volume is prepared for use in the system.

volume table of contents (VTOC)

A table on a direct access volume that describes each file on the volume.

VSAM

Virtual Storage Access Method.

Index

Special Characters

- ? synonym for FIND command 455
- @
 - SEE national characters
- *
 - showing invalid values 66
- #
 - SEE national characters
- \$
 - SEE national characters

Numerics

- 31 digit decimal processing option 390
- 63 bit binary processing option 389

A

- ABOUT primary command 434
- across display format 62
- Advanced Member Selection panel 192
- AF-authorized 505
- AGN Selection panel 193
- array elements
 - denoting with subscript 66
- asterisks
 - showing invalid values 66
- AUD (Print Audit Report) function 646
- Audit
 - Audit Trail report 188
 - audit trail report 190
 - audit trail report
 - Print Audit Trail panel 349
 - printing 186
 - Audit Trail report
 - Detail Statistics Formatted section 189
 - Detail Statistics Unformatted section 189
 - Summary Statistics section 190
- AUTOSAVE primary command (Edit only) 434

B

- BACKWARD primary command 32, 32
- Batch Browse (IBB) function 631
- Batch Browse Entry panel 195
- Batch Browse Options panel 201
- Batch checkpoint frequency
 - setting 132
- Batch Edit (IEB) function 590
- Batch Edit Entry panel 201
- Batch Edit Options panel 207
- batch job card information 42
- batch job card processing options 381
- Batch Submission Job Statement Information processing option 382
- BMP mode
 - differences from DLI mode 20
- BMP Mode Options panel 209
- BMP Mode Parameters panel 212
- BOTTOM primary command 31, 435
- Browse : IMS Database panel
 - SEE IMS data panel
- Browse Entry panel 214

C

- CA-Panvalet 32
- CANCEL primary command 436
- CAPS primary command 437
- CCSID
 - displayed or hidden 438
- CCSID primary command 438

- CE primary command 438
- Change all checkpoint frequency
 - setting 132
- Change Extended (CX) command 139
- CHANGE primary command (Edit only) 440
- changing
 - long strings 139
 - scramble data set name 112
 - scramble range values 111
 - scramble type 109
 - scramble value columns 111
 - scramble value option 110
- changing display format 62
- Changing field headings 107
- Changing Field Selection Criteria 185
- Changing Relationship
 - Criteria 183
- Changing Relationship Criteria 183
- CHAR display format 62
- character strings 136
- Checkpoint
 - backing out with UNDO 503
 - issuing call with SAVE 189, 491
 - overview 131
- Checkpoint frequency
 - audit trail 189
 - setting 132
- checkpoints
 - turning on or off with AUTOSAVE 434
- CHILD primary command 448
- cleaning up display area 488
- COBOL
 - compiler, displaying details 29
 - copybook 89
- COBOL processing options 382
- COBOL processing options, specifying 42
- COBOL REPLACE 523
- columns
 - limiting searches 140
- command
 - LVL 29
- commands
 - reading syntax diagrams xi
- Compiler Language Selection panel 220
- compiler language specifications 42
- compiler specifications 42
- compiler, COBOL, displaying details 29
- COPY REPLACING 383, 523
- copybook
 - function
 - batch example 525
 - generating multiple record layouts 83
 - replacing strings (COBOL only) 383, 523
 - stored in CA-Panvalet library 17, 32
- Copybook Library List panel 222
- copybooks
 - extracting subset 84
- Create a Criteria Set
 - from model 180
 - using a template 180
- Create a Criteria Set from model (CM) 180
- Create a Criteria Set using a template 180
- Criteria Member Selection panel 224
- criteria set
 - function
 - batch example 538
- Criteria Set Entry panel 179, 226
- Criteria Set Update Utility panel 229

- criteria sets
 - updating 181
 - updating in batch job 181
 - updating in foreground 181
 - updating multiple 533
- CX (Change Extended) command 139

D

- D line command 511
- data
 - canceling without saving 436
 - DPRINT 452
 - loading 172
 - overtyping with CAPS ON 437
 - primary commands
 - DPRINT 452
 - quitting without saving 436
 - statistics, listing 493
- data sets
 - saving 453
- data type 65
- data type and length
 - display 502
- Database Data Set Display panel 234
- Database Data Set Specification panel 236
- Database extract statistics report 563
- database extract summary report 561
- Database Hierarchy panel 239
- Database Load Diagnostic report 578
- Database Load Statistics report 575
- Database Load Summary report 576
- Database Positioning panel 239
- Database Selection panel 242
- databases
 - creating a full copy 157
- Databases and segments
 - access 17
- date fields
 - defining 108
 - specifying scrambling options 113
- Date/Time Attributes panel 244
- DBCS
 - displaying or editing 44
- DBCS processing option 383
- DBD Information panel 248
- DBD Library List panel 250
- DBD primary command 449
- DBDLIST primary command 450
- decimal to hexadecimal converter 36
- DEDB databases
 - extracting and loading sequential dependent (SDEP) segments 168
- DELETE primary command (Edit only) 450
- DELIMS
 - REXX IEB calls, using a view 598
 - REXX IEB calls, without a view 611
- DIB (Initialize) function 639
- display
 - data type and length 502
 - picture clause 483
 - redefines fields and information 485
 - start location 495, 500
 - template structure 500
- display area
 - cleaning up 488
- display format
 - available 62
 - changing 62

- changing case of data 437
 - initial 62
 - when browsing 61
- Displaying a field without truncation 108
- DLI mode
 - differences from BMP mode 20
- DLI Mode Data Sets 1 panel 254
- DLI Mode Data Sets 2 panel 256
- DLI Mode Options panel 259
- DLI Mode Parameters panel 262
- DOWN primary command 31, 450
- DPRINT primary command 452
- DX primary command 36

E

- Edit
 - from Criteria Set 180
- Edit : IMS Database panel
 - SEE IMS data panel
- Edit checkpoint frequency
 - setting 132
- Edit Criteria Set 180
- Edit Entry panel 266
- EDIT primary command, description 453
- editing a view 103, 427
- Editing data
 - inserting segments 142
- editing methods 134
- editor options 43
- Editor Options panel 272
- END primary command 453
- ending session 453
- errors
 - messages 653
- Excluding segment types and layouts 105
- Exit 30
- expanded error messages
 - view 40
- Extract
 - extract reports 172
- Extract : To Data Set Specification panel 285
- Extract (IXB) function 539
- Extract Entry panel 275
- Extract Options panel 282
- Extract Processing 156
 - DEDB databases with sequential dependent segments 168

F

- FC, FH, FL, FS, FT line commands 511
- FE primary command 454
- field
 - scrolling to 71
 - selecting for specifying scrambling options 109
- field attributes
 - setting 107
- field data type 65
- field heading 65
- Field headings
 - changing 107
- Field Information panel 300
- field length 65
- field or column
 - scrolling to 71
- FIELD primary command 455
- field reference 65, 192
- Field Reference column
 - turning display on or off 486
- field selection criteria
 - specifying 115
- Field Selection Criteria

- Changing 185
- field start column 65
- field status 240
- Field status 380
- fields
 - displaying using a different template 463
 - finding next in error 454
 - finding particular numeric value 455
 - holding when scrolling 70
 - in error, changing 438
 - overtyping with CAPS ON 437
 - selecting/sequencing 106
- fields in error
 - defined 454
- filerc 631
- Find Extended (FX) command 138
- FIND primary command 455
- finding
 - long strings 138
- finding a field with a particular numeric value 455
- finding next field in error 454
- first page
 - scrolling to 32
- FM/IMS
 - 28
 - exiting 30
 - launching 28
- FM/IMS
 - Load step description 569
- FMAP primary command 463
- FMN
 - 1JIN
 - Batch Browse (IBB) 632
 - Batch Edit (IEB) 593
 - Extract (IXB) 539
 - Load (ILB) 570
 - Print (IPR) 580
- FMN
- IMSIN
 - Batch Browse (IBB) 632
 - Batch Edit (IEB) 593
 - control statements
 - Batch Browse (IBB) 633
 - Batch Edit (IEB) 593
 - Extract (IXB) 540
 - Load (ILB) 570
 - Print (IPR) 580, 642
 - Extract (IXB) 539
 - initialization (DIB) 642
 - Load (ILB) 570
 - Print (IPR) 580
- format
 - unformatted displays 62
- FORMAT primary command 464
- FORWARD primary command 31, 31
- fragments, syntax diagrams xi
- FREE primary command 465
- function keys
 - scrolling 68
- functions
 - ICU 533
 - ITU 514, 528
- FX (Find Extended) command 138

G

- GE primary command 466
- GETIMS
 - REXX IEB calls, without a view 615

- GETIMS (retrieve an IMS segment) REXX function 599
- GETIMS, REXX IEB calls
 - using a view 599
- glossary dcxciii
- GRAPHIC processing option 389

H

- Help
 - accessing 37
 - fields 37
 - tutorial 38
- HEX display format 62
- HEX primary command 467
- hexadecimal
 - across display format 62
 - updown display format 62
- hexadecimal display format
 - setting 467
- hexadecimal to decimal converter 36
- hexadecimal values
 - showing 63
- hidden segments
 - indicated 70
- HIDE primary command 468
- HIERARCH primary command 469
- highlighting
 - turning off 488
- HLASM
 - copybook 91
- HLASM processing options, specifying 43
- HOLD primary command 469
- holding fields when scrolling 70

I

- I line command 511
- IBB (IMS Batch Browse) function 631
- ICU function 533
- IEB (IMS Batch Edit) function 590
- ILB (IMS Load) function 568
- IMS
 - releases supported by
 - FM/IMS 26
 - system requirements 26
- IMS Catalog Specification panel 306
- IMS data panel 309
 - field order 481
 - field width 506
 - hiding fields 468
 - locking scrolling 469
 - long hexadecimal format 474
 - removing scrolling lock 465
 - show hidden field 494
- IMS display panel
 - hexadecimal format 467
- IMS Library data set
 - specifying a library data set 32
- IMS Subsystem Specification panel 308
- initial display format 62
- Initialize (DIB) function 639
- INSERT primary command 470
- Insert Segment Layout Selection panel 328
- Insert Segment panel 323
- Inserting segments 142
- IPR (IMS Print) function 579
- ISPF Settings panel 330
- ISRTIMS
 - REXX IEB calls, without a view 618
- ISRTIMS (insert an IMS segment) REXX function 618
- ISRTIMS, REXX IEB calls

- using a view 600
- ITU function 514
- IVU function 528
- IXB (IMS Extract) function 539

J

- JCL Submission panel 331
- JUST primary command 471

K

- K line command 511
- Key positioning
 - Relational Operators 61
- KEY primary command 472
- Key Specification panel 332
- KEYLIST
 - specify in JCL 167
- KEYRANGE
 - specify in JCL 167
- keys file
 - creating 73
- keywords, syntax diagrams xi

L

- language specifications 42
- language, compiler specifications 42
- last page
 - scrolling to 31
- Launching 28
- layout
 - generating multiple 83
- layouts
 - matching, defined 116
- left justify numeric fields 471
- LEFT primary command 473
- LHEX display format 63
- LHEX primary command 474
- LIBLIST primary command, description 475
- library data set
 - specifying a library data set 32, 32
- license inquiry dclxxxix
- limiting data
 - to search range 139
 - to specified columns 140
 - to specified fields 141
- limiting searches 139
- line command
 - SHC 380
 - SXE 240
- Line command
 - S* 380
 - Snn 380
 - SS 380
- line commands
 - Browse and Edit 511
 - D 511
 - FC, FH, FL, FS, FT 511
 - I 511
 - K 511
 - R 512
 - RA 512
 - V 512
- lines
 - numbers, using for creating copybook subset 84
- Load
 - JCL submission panel 331
 - load reports 177
 - No replace 173
 - Replace 173
- Load (ILB) function 568
- Load Entry panel 335

- load reports 172, 177
- LOCATE primary command 476
- LOCKMAX 553
- Logical Relationship Information panel 342
- long strings
 - changing 139
 - finding 138
- LZ primary command
 - see LZERO primary command
- LZERO primary command 478

M

- matching layout 116
- MAXROOTS
 - specify in JCL 167
- message
 - more 31
- messages
 - list 653
- moving to next segment 479
- moving to previous segment 483
- multiple templates, updating 514, 528, 533

N

- national characters 45
- NEXT primary command 479
- non-displayable characters
 - representing 66
- not-selected segments
 - hiding 488, 495
 - showing 495
- numbers
 - find and replace 440
- numeric fields
 - left justify 471

O

- OCCURS clause 108
- OFFSET primary command 480
- ORDER primary command 481
- output data set allocation 44
- over-large values
 - editing template to avoid truncation 66
 - showing 66
 - truncating 66
- overriding scrolling amount 70
- overview
 - templates 82
 - views 82

P

- pages
 - scrolling to first 32
 - scrolling to last 31, 435
- panel reference 192
- panels
 - ISPF Settings panel 398
- Panvalet 17
- PARENT primary command 482
- Partial extract using a Keys file 159
- partial extract using extract criteria 162
- PCB Selection panel 343
- PIC primary command 483
- picture clause
 - display 483
- PL/I
 - copybook 90
 - Set PL/I Processing Options panel 389
 - PL/I processing options, specifying 43
 - Preserve copybook library option 221
 - PREVIOUS primary command 483
 - primary commands

- AUTOSAVE 434
- BACKWARD 32, 32
- BOTTOM 31, 435
- CANCEL 436
- CAPS 437
- CCSID 438
- CE 438
- CHANGE 440
- CHILD 448
- DBD 449
- DBDLIST 450
- DELETE 450
- differences between Browse and Edit sessions 511
- DOWN 31, 450
- DPRINT 452
- EDIT 453
- END 453
- FE 454
- FIND 455
- FMAP 463
- FORMAT 464
- FORWARD 31, 31
- FREE 465
- GE 466
- HEX 467
- HIDE 468
- HIERARCH 469
- HOLD 469
- IMS data panel 508, 510
- INSERT 470
- JUST 471
- KEY 472
- LEFT 473
- LHEX 474
- LIBLIST 475
- LOCATE 476
- NEXT 479
- OFFSET 480
- ORDER 481
- PARENT 482
- PIC 483
- PREVIOUS 483
- QUIT 436, 485
- RCHANGE 485
- RDF 485
- REFRESH 486
- REFS 486
- RELATED 486
- REPEAT 487
- RESET 488
- RFIND 489
- RIGHT 490
- ROOT 491
- SAVE 491
- SCOPE 492
- SEGMENT 492
- SEGSTATS 493
- SELECT ALL 493
- SHOW 495
- SHOW (FLD) 494
- SHOWCOB 495
- SLOC 495
- SSID 500
- STR 500
- TOP 32, 501
- TPRINT 501
- TWIN 501
- TYPE 502
- UNDO 503
- UP 32, 503

- UPDATE 504
- VIEW 505
- VSAVE 505
- WIDTH 506
- XKEY 507
- ZOOM 508
- Primary Option menu 346
- Primary Option Menu
 - Set processing options (option 0) 40
 - Settings (option 0) 397
 - Settings (option 1) 390
- PRINT
 - REXX IEB calls, without a view 620
- Print (IPR) function 579
- PRINT (print an IMS segment) REXX function 602, 620
- Print Audit Report (AUD) function 646
- Print Audit Trail panel 349
- Print Entry panel 351
- Print Options panel 358
- print processing options 41
- print reports 77
- PRINT, REXX IEB calls
 - using a view 602
- processing options
 - batch
 - Batch Submission Job Statement Information 382
 - batch job card 381
 - BMP Mode Options panel 209
 - BMP Mode Parameters panel 212
 - COBOL 382
 - DBCS 383
 - Compiler Language Selection 220
 - DLI Mode Data Sets 1 panel 254
 - DLI Mode Data Sets 2 panel 256
 - DLI Mode Options panel 259
 - DLI Mode Parameters panel 262
 - editor options 272
 - global
 - setting for
 - FM/IMS
 - 390, 397
 - IMS
 - LOCKMAX 553
 - PSB type 407
 - ISPF settings 398
 - PL/I 389
 - 31 bit decimal 390
 - 63 bit binary 389
 - GRAPHIC 389
 - UNALIGNED 390
 - system settings 404, 406
- Processing Options 40
- Program Directory 688
- PSB type processing option 407
- PSBs
 - differences between dynamic and static 21
- PTF level, displaying
- File Manager
 - 434, 505

Q

- QUIT primary command 436, 485

R

- R line command 512
- RA line command 512
- range
 - Redefines / Range Specifications panel 363
- RCHANGE primary command 485
- RDF primary command 485

- record
 - generating multiple layouts 83
- redefines
 - display 485
 - displayed 65
 - generating multiple 01-levels 83
- Redefines / Range Specifications panel 363
- REFRESH primary command 486
- REFS primary command 486
- RELATED primary command 486
- Relational Operators 61
- Relationship Criteria panel 365
- release, displaying
- File Manager
 - 434, 505
 - releases supported by
 - FM/IMS
 - 26
- REPEAT primary command (Edit only) 487
- repeatable items, syntax diagrams xi
- repeating search 489
- REPLIMS
 - REXX IEB calls, without a view 622
- REPLIMS (update an IMS segment) REXX function 622
- REPLIMS, REXX IEB calls
 - using a view 603
- REPORT
 - Extract (IXB) 539
 - Load (ILB) 570
- reports
 - database extract statistics 563
 - database extract summary 561
 - database load diagnostic 578
 - database load statistics 575
 - database load summary 576
- RESET primary command 488
- retrieval
 - using a view
 - description 598, 638
 - without a view
 - description 611, 638
- REXX compiler
 - REXX 118
- REXX IBB calls 637
- REXX IEB calls
 - description 598
 - using a view
 - DELIMS 598
 - GETIMS 599
 - ISRTIMS 600
 - PRINT 602
 - REPLIMS 603
 - SETRC 605
 - VIEWIMS 606
 - VIEWPOSN 609
 - without a view
 - DELIMS 611
 - GETIMS 615
 - ISRTIMS 618
 - PRINT 620
 - REPLIMS 622
 - SAVEIMS 624
 - SETRC 625
 - VIEWIMS 625
- RFIND primary command 489
- RIGHT primary command 490
- ROOT primary command 491
- ruler
 - displaying 65

S

- SAVE primary command (Edit only) 491
- SAVEIMS
 - REXX IEB calls, without a view 624
- SAVEIMS (Commit IMS changes) REXX function 624
- SCOPE primary command 492
- scramble
 - options
 - date field 113
 - range values, specifying 111
 - scramble type, specifying 109
 - time field 113
 - value columns, specifying 111
 - value data set name, specifying 112
 - value list 112
 - value option, specifying 110
- scrolling
 - down 450
 - effect in TABL display format 70
 - field or column 71
 - holding fields 70
 - in panels 31, 32
 - left 473
 - primary commands
 - BOTTOM 435
 - DOWN 450
 - LEFT 473
 - RIGHT 490
 - UP 503
 - right 490
 - setting scroll amount 69
 - temporary override 70
 - to field 71
 - to first page 32
 - to first segment 70, 70
 - to last page 31
 - to last segment 70, 70
 - to specified segment 476
 - up 503
 - with function keys 68
 - with primary commands 69
- scrolling lock
 - removing 465
- SDEP segments
 - extracting 169
 - extracting and loading 168
- SDEPTSO
 - IXB function 547
- search
 - limiting to search range 139
 - repeating 489
- Secondary Index Selection panel 367
- segment
 - first, scrolling to 70
 - last, scrolling to 70
 - scrolling to first 70
 - scrolling to last 70
 - showing all by zooming in 67
- Segment Information panel 369
- Segment Layout panel 370
- Segment Layout Selection panel 377
- Segment layouts
 - excluding 105
 - selecting 105
- SEGMENT primary command 492
- Segment Selection panel 379
- Segment types
 - excluding 105, 105
 - selecting 105

- segments
 - currently formatted, defined 113
 - deleting 450, 450
 - hiding in SNGL display format 114
 - making currently formatted 114
 - moving to next 479
 - moving to previous 483
 - non-selected 115
 - not-matched
 - how determined 116
 - scrolling to specified number 476
 - selected 115
 - selecting 115
 - showing in SNGL display format 114
 - suppressed 113
 - zooming 508
- SEGSTATS primary command 493
- Select
 - fields 106
- SELECT ALL primary command 493
- selecting a field for specifying scrambling options 109
- selecting display format 61
- Selecting segment types and layouts 105
- Sequence
 - fields 106
- session
 - ending 453
- Set Batch Job Card Information panel 381
- Set COBOL Processing Options panel 382
- Set PL/I Processing Options panel 389
- set processing options
 - batch job card information 42
 - COBOL processing options 42
 - compiler language 42
 - editor options 43
 - HLASM processing options 43
 - language and compiler 42
 - output data set allocation 44
 - PL/I processing options 43
 - print processing options 41
 - system settings 41
 - temporary data set allocation 44
 - trace options 44
- SETRC
 - REXX IEB calls, without a view 625
- SETRC, REXX IEB calls
 - using a view 605
- Setting field attributes 107
- Settings (option 0)
 - description 397
- Settings (option 1)
 - description 390
- shadow lines
 - defined 113
- SHOW (FLD) primary command 494
- SHOW primary command 495
- SHOWCOB primary command
 - description 495
 - using 29
- sliding window 71
- SLOC primary command 495
- SMF logfile
 - SMF logfile retrieval JCL 188
- SNGL display format 63
 - Browse/Edit 67
 - CHAR or HEX 68
 - hiding segments 114
 - non-ZOOM 68
 - showing segments 114
- specifying field selection criteria 115

- SSID primary command 500
- start location
 - display 495, 500
- statistics
 - listing for a Browse or Edit session 81
 - SEGSTATS primary command 493
- STR primary command 500
- strings
 - changing 138
 - find and replace 440
 - finding 136
 - using for creating copybook subset 84
- subscripting array element 66
- subscripts 108
- subsets
 - extracting from copybook 84
- Subsystem Selection panel 401
- subsystem settings 43
- Subsystem Settings Menu panel 404
- subsystems
 - listed on Subsystem Selection panel 401
 - refreshing statuses 486
- suppressed segments
 - hiding 488, 495
 - showing 495, 505
- syntax diagrams, how to read xi
- SYSPRINT
 - Batch Browse (IBB) 632
 - Batch Edit (IEB) 593
 - Extract (IXB) 540
 - Load (ILB) 570
 - Print (IPR) 580, 642
- system processing options 406
- system settings 41
- System Settings panel 406

T

- TABL display format 65
- table elements 108
- tabular display format 65
- TCREATE
 - IXB function 548
- template
 - not interchangeable between
 - Base
 - ,
 - FM/Db2
 - and
 - FM/IMS
 - 21
- Template Data Sets panel 408
- Template Entry panel 409
- Template Member Selection panel 411
- Template Specification panel 412
- template structure
 - display 500
- Template Update : New Database Segments panel 417
- Template Update Utility panel 418
- Template/View/Criteria Set Menu panel 423
- templates
 - creating 82
 - description 82
 - updating 82, 85
 - updating in batch 86
 - updating in foreground 85
 - updating multiple 514, 528
- templates and views
 - overview 21
- temporary data set allocation 44
- time fields

- defining 108
 - specifying scrambling options 113
- TOP primary command 32, 501
- TPRINT primary command 501
- trace options 44
- turn off highlighting 488
- TWIN primary command 501
- TYPE primary command 502

U

- UNALIGNED 390
- Unavailable HALDB partitions and DEDB areas 24
 - DEDB areas in browse or edit 57
- Unavailable HALDB partitions and DEDB areas 24, 57
- UNDO primary command 503
- unformatted displays 62
- UNLOAD, Extract (IXB) 540
- UP primary command 32, 503
- UPDATE primary command, description 504
- updating
 - multiple templates 514, 528, 533
 - updating a view 427
 - updating criteria sets 181, 181, 181
 - updating templates 85
 - updating views 100, 101
- uppercase
 - changing case of data 437
 - using the REXX compiler 118

V

- V line command 512
- value list, scrambling data 112
- variables, syntax diagrams xi
- VER primary 29
- VER primary command 28, 505
- version checking 28, 28
- View Entry panel 425
- view expanded error messages 40
- View Member Selection panel 428
- VIEW primary command 505
- view update
 - function
 - batch example 532
- View Update Utility panel 429
- VIEWIMS
 - REXX IEB calls, without a view 625
- VIEWIMS (create a new view) 606, 625
- VIEWIMS (load or create a view) REXX function 606, 625
- VIEWIMS, REXX IEB calls
 - using a view 606
- VIEWPOSN, REXX IEB calls
 - using a view 609
- views
 - batch updating 101
 - creating 98
 - creating from a model view 426
 - creating from a template 426
 - creating prior to browse or edit 99
 - creating while browsing or editing 100
 - description 82
 - editing 103, 427
 - updating 100, 427
- VSAVE primary command 505

W

- ways of editing 134
- WIDTH primary command 506
- without truncation
 - Displaying a field 108

X

XD primary command 37
XKEY primary command 507

Z

ZOOM primary command 508
zooming in
to show all one segment 67
zooming on one segment 508