

**IBM File Manager for z/OS®
User's Guide and Reference for Db2 Data
Version 15.1.6**

Note

Before using this information and the product it supports, be sure to read the general information under [Notices on page mcxxviii](#) .

Edition Notice

This edition (published November 2024) applies to Version 15 Release 1 Modification Level 6 of IBM® File Manager for z/OS® (program number 5755-A03) and to all subsequent releases and modifications until otherwise indicated in new editions.

Contents

About this document.....	xiii	FM/Db2 system options (option 0.2).....	63
Who should use this document.....	xiv	Job card specifications (option 0.3).....	63
National characters.....	xiv	Compiler language selection (option 0.4).....	63
Prerequisite and related information.....	xv	COBOL compiler specifications (option 0.5).....	63
How to read syntax diagrams.....	xv	HLASM compiler specifications (option 0.6).....	64
Summary of changes.....	xix	PL/I compiler specifications (option 0.7).....	64
Part I. Working with FM/Db2.....	21	Temporary Data Set Allocations (option 0.8).....	64
Chapter 1. FM/Db2 overview.....	22	Output Data Set Allocations (option 0.9).....	65
What you can do with FM/Db2.....	22	Trace options (option 0.10).....	65
Templates.....	22	ISPF settings (option 0.11).....	65
What is a template?.....	22	View and Edit options (options 1 and 2).....	65
Where you can use templates.....	23	Utilities (option 3).....	66
Chapter 2. System requirements for File Manager for Db2®.....	25	Print utility options (option 3.1).....	66
Chapter 3. Getting started with FM/Db2.....	26	Copy utility options (option 3.3).....	66
Starting and exiting FM/Db2.....	26	Object List Options (option 3.4).....	66
TSO region size.....	26	Export utility options (option 3.7).....	67
Starting FM/Db2.....	26	Db2® LOAD utility options (option 3.L).....	67
Checking your FM/Db2 version.....	28	Db2® Utility LISTDEF options (option 3.UL).....	67
Checking which COBOL compiler you're using.....	29	Db2® Utility OPTIONS options (option 3.UO).....	68
Exiting from FM/Db2.....	29	Db2® Utility TEMPLATE options (option 3.UT).....	68
Selecting the Db2® subsystem when more than one is available.....	30	Db2® Unload utility options (option 3.UU).....	68
Selecting the Db2® subsystem by using the Db2 SSID field.....	30	Displaying or editing DBCS characters.....	68
Selecting the Db2® subsystem by entering the SSID command.....	32	SAF-rule controlled auditing.....	69
Using the Db2® Subsystem Selection menu.....	33	Determining when SAF-rule controlled auditing is in effect.....	69
Using the FM/Db2 interface.....	35	SAF rules for auditing.....	70
Navigating in FM/Db2.....	35	SAF-rule controlled auditing not in effect.....	70
FM/Db2 panel features.....	37	SAF-rule controlled auditing in effect, no auditing.....	70
Screen size.....	39	SAF-rule controlled auditing in effect, auditing possible.....	70
Scrollable input and display fields for long names.....	39	Chapter 4. Working with templates.....	72
Selecting options on FM/Db2 panels.....	44	Associating a template with a Db2® object.....	72
Specifying a Db2® object name.....	45	Information stored in a template.....	73
Specifying the SQLID.....	50	Printing a template.....	75
Specifying a data set and a member name.....	50	Using templates with non-Db2 data.....	75
Canceling long-running Db2® queries.....	54	How FM/Db2 compiles a copybook into a template.....	77
Getting help.....	55	Support for COBOL data description entries.....	78
Accessing Tutorial Help.....	55	Support for HLASM data description entries.....	79
Displaying field-level help information.....	58	Support for PL/I data description entries.....	79
Displaying the expanded form of error messages.....	58	Support for variable-length arrays.....	80
Setting default processing options.....	60	Editing a template.....	81
System Options (option 0).....	62	Adding a description to a template.....	82
Print settings (option 0.1).....	62	Selecting rows.....	83
		Row selection by column.....	83

Row selection criteria in freeform style.....	89	Finding data within a label range.....	146
Scrolling the Row Selection Criteria field.....	91	Searching numeric columns.....	148
Expanding the Row Selection Criteria field.....	92	Changing the view of displayed data.....	149
Using the SQL Edit session.....	92	Handling special data.....	164
Manipulating columns.....	95	DATE and TIME columns.....	165
Selecting columns.....	96	Large numeric fields.....	165
Holding columns on the display when scrolling.....	97	Working with large tables.....	166
Changing the sequence of displayed or printed data.....	98	Null values and VARCHAR processing.....	174
Changing column attributes.....	101	Unicode data.....	175
ROWID columns.....	104	Changing data.....	176
Specifying scrambling options.....	104	Installation settings that affect CAPS.....	176
Selecting a column for specifying scrambling options.....	105	Changing data by overtyping.....	177
Mapping data.....	109	Changing data with the CHANGE command.....	178
Where you can map data.....	109	Changing data using prefix commands.....	182
Letting FM/Db2 do the mapping.....	110	Converting data to uppercase.....	185
Specifying your own mapping.....	110	"Read-only" views, non-updateable columns.....	186
Column mapping rules.....	115	Deleting rows.....	186
Creating a copybook from a File Manager/Db2 Template.....	118	Deleting rows within excluded or non-excluded rows.....	187
Chapter 5. Viewing and changing Db2® data.....	119	Deleting rows within a label range.....	188
FM/Db2 editor sessions.....	120	Editing related tables.....	188
Starting a File Manager/Db2 editor session.....	120	Listing related tables.....	189
Specifying the editor session mode: "normal mode" or "large mode".....	121	Self-referencing constraints.....	190
Specifying the start position for your FM/Db2 editor session.....	123	Referential integrity errors.....	190
Setting options for the current FM/Db2 editor session.....	123	Starting an Edit session of a related table.....	191
Validating and saving changes with a File Manager/Db2 editor session.....	124	Differences when you edit a related table.....	191
Ending a File Manager/Db2 editor session.....	130	Differences when saving or canceling while editing a related table.....	192
Starting another FM/Db2 editor session.....	132	Navigating between Edit sessions.....	192
Specifying the Db2® object you want to view.....	133	Deleting a primary key.....	193
Restricting the data that FM/Db2 loads from Db2®.....	134	Inserting a new foreign key.....	193
Storage considerations.....	135	Updating a primary key.....	194
Viewing large tables or views.....	136	Adding a primary key.....	195
Viewing data in a File Manager/Db2 editor session.....	138	Issuing Db2® commands from within a File Manager/Db2 session.....	196
Count of rows fetched in a File Manager/Db2 editor session.....	138	Issuing Db2® commands from the Enter and Execute Db2® Commands panel.....	196
Locating a row.....	138	Issuing Db2® commands from the command line.....	196
Locating a column.....	139	Handling errors during an Edit session.....	197
Finding a string.....	142	Determining why an error occurred.....	198
Finding data within specific columns.....	144	"Duplicate Row" errors.....	198
Finding a string within specific portions of the data.....	146	"No Primary Key" errors.....	198
Finding data within excluded or non-excluded rows.....	146	"Delete Restrict Rule" errors.....	199
		"Check Constraint" errors.....	200
		"Row Not Found" errors.....	200
		Deadlocks or timeouts.....	200
		Example of correcting an error during an Edit session.....	201

Chapter 6. Creating and dropping Db2® objects.....	203
Working with the Create and Drop panels.....	204
SQL Keywords.....	205
Creating a database.....	218
Creating a table space.....	219
Table Space Type (Create Table Space).....	219
Table Space Allocation (Create Table Space)....	220
Data Storage (Create Table Space).....	220
Locking (Create Table Space).....	220
Data Sharing (Create Table Space).....	220
Partitions (Create Table Space).....	221
Creating a table.....	221
Creating a table using a model.....	222
Creating a table without using a model.....	225
Table Creation options.....	225
1. Columns (Create Table).....	226
2. Nulls and default values (Create Table).....	226
3. Options (Create Table).....	227
4. Unique constraints (Create Table).....	227
5. Referential constraints (Create Table).....	227
6. Check constraints (Create Table).....	229
7. Procedure exits (Create Table).....	230
8. Generate values (Create Table).....	230
Creating a view.....	230
Creating an alias.....	230
Creating an index.....	231
Index type (Create Index).....	232
Index Column Selection (Create Index).....	232
Allocation (Create Index).....	232
Index (Create Index).....	232
Index Partitions (Create Index).....	233
Partition Values Option (Create Index).....	233
Creating a synonym.....	233
Creating a distinct type.....	233
Creating a function.....	234
Parameters (Create Function).....	234
Parameter Types (Create Function).....	234
Returned Data Type (Create Function).....	235
Option List 1/2 (Create Function).....	235
Option List 2/2 (Create Function).....	235
Creating a procedure.....	235
Procedure Parameters (Create Procedure).....	236
Parameter Types (Create Procedure).....	236
Option List 1/2 (Create Procedure).....	236
Option List 2/2 (Create Procedure).....	236
Creating a trigger.....	236
Details (Create Trigger).....	237
Search Conditions (Create Trigger).....	237
SQL Statement (Create Trigger).....	237
Creating an auxiliary table.....	237
Dropping Db2® objects.....	238
Chapter 7. Populating a Db2® table with data.....	239
Editing the template.....	240
Chapter 8. Copying data.....	241
Copying data from one Db2® object to another.....	241
Specifying details for the "From" table.....	242
Specifying details for the "To" table.....	244
Copying data from a VSAM or QSAM file.....	246
When (and when not) to use the Import utility...	247
Specifying details for the "From" data set.....	248
Specifying details for the "To" table.....	250
Using a REXX procedure with the Import utility.....	252
General information about REXX.....	253
Enhancing the Import utility using a REXX procedure.....	263
Copying data to a VSAM or QSAM file.....	274
Specifying details for the "From" table.....	275
Specifying details for the "To" data set.....	279
Copying data from a File Manager/Db2 editor session, or from an SQL statement.....	283
Scrambling data.....	286
When can you scramble data?.....	286
Scrambling rules.....	287
How do I...?.....	287
How do I copy data from one Db2® table to another on the same Db2® system?.....	288
How do I copy data from one Db2® table to another on a different (connectable) Db2® system?.....	288
How do I copy data from one Db2® table to another on a different (non-connectable) Db2® system?.....	288
How do I copy and reorder selected data from a Db2® table to a sequential file?.....	289
How do I define a copybook that describes data exported to a sequential file?.....	290
How do I export data using a copybook that describes a different data format to that used by the FM/Db2 Export Utility?.....	295
Chapter 9. Working with lists of Db2® objects.....	297
Displaying or printing a list of objects.....	298
Working with object list panels.....	301
Limiting the data displayed.....	302
Locating a row or column in a list of Db2® objects.....	307
Finding a string in a list of Db2® objects.....	308
Using the line command area (Cmd).....	308
Sorting the displayed data.....	316

Reverse engineering.....	317	Chapter 13. Working with SQL statements.....	382
Performance tips.....	319	Should you use basic or advanced SQL prototyping?.....	382
Chapter 10. Printing.....	321	Using basic SQL prototyping.....	382
Printing the contents of a Db2® table.....	321	Specifying a predicate.....	386
Formatting the print output.....	322	Example of using basic SELECT prototyping.....	387
Editing the template.....	324	Using advanced SQL prototyping.....	391
Running Print in batch.....	324	Tabbing and color-coding.....	393
Printing rows from a Db2® table.....	324	Using the advanced SELECT prototyping panels to build a SELECT statement.....	394
Looking at the print output from your FM/Db2 session.....	326	Changing the SQL statement.....	399
Printing an audit trail report.....	328	Handling repeatable items in the syntax.....	408
Audit Trail Report.....	329	Executing a SELECT statement after you have built it using prototyping.....	416
Chapter 11. Managing Db2® privileges.....	332	Entering, executing, and explaining SQL statements.....	416
Using the Manage Db2® Privileges panel.....	333	Entering SQL statements.....	417
Displaying privileges.....	334	Executing SQL statements.....	418
Granting privileges.....	335	Explaining SQL.....	419
Revoking privileges.....	337	Editing and executing SQL statements from a data set.....	421
Chapter 12. Generating batch JCL for Db2® utility jobs.....	339	Managing tables used by SQL explain.....	422
Setting options for Db2® utilities.....	341	Exiting SQL prototyping.....	422
Generating a LISTDEF statement in the Db2® utility job.....	342	Chapter 14. Using FM/Db2 functions in batch jobs.....	424
Generating a Db2® utility job.....	343	JCL syntax for File Manager/Db2 batch jobs.....	424
Working with LISTDEF utility panels.....	345	Using File Manager/Db2 edit models.....	425
COPY utility.....	346	Edit model example: JCL that calls the DBP function.....	426
Default values.....	347	Chapter 15. Interfacing with Db2® Interactive.....	430
COPY (table spaces).....	347	Part II. FM/Db2 reference.....	431
COPY (index spaces).....	348	Chapter 16. Db2® data types.....	432
LOAD utility.....	349	Large objects (LOBs).....	434
Input data.....	350	Chapter 17. FM/Db2 panels and fields.....	436
Loading data using LOAD utility control statements.....	351	Scrollable fields on FM/Db2 panels.....	436
Loading data described by a copybook or template.....	353	Action bar pull-down menu.....	436
REBUILD utility.....	357	Additional LISTDEF Statements panel.....	440
REBUILD utility (indexes).....	358	Additional TEMPLATE Statements panel.....	441
REBUILD utility (indexes for table spaces).....	359	Advanced SELECT Prototyping panel.....	442
RECOVER utility.....	360	Alter Database panel.....	444
RECOVER (table spaces).....	360	Alter External Scalar Function panel.....	445
RECOVER (index spaces).....	362	Alter Index panel.....	446
REORG utility.....	363	Alter Stored Procedure panel.....	447
REORG (table spaces).....	364	Alter Table panel.....	448
REORG (indexes).....	366	Alter Table - ADD CHECK Constraint panel.....	449
RUNSTATS utility.....	368	Alter Table - ADD Column panel.....	450
RUNSTATS (table spaces).....	369	Alter Table - ADD FOREIGN KEY Constraint panel.....	451
RUNSTATS (indexes).....	370	Alter Table - ADD PRIMARY KEY panel.....	452
UNLOAD utility.....	372	Alter Table - AUDIT panel.....	453
UNLOAD (tables).....	373	Alter Table - DATA CAPTURE panel.....	454
UNLOAD (table spaces).....	378		

Alter Table - DROP CHECK Constraint panel.....	455	Create Index: Options panel.....	532
Alter Table - DROP FOREIGN KEY Constraint panel.....	456	Create Index: Partitions panel.....	534
Alter Table - DROP PRIMARY KEY panel.....	457	Create Index: Partition Values panel.....	535
Alter Table - RESTRICT ON DROP panel.....	458	Create Index: Type panel.....	537
Alter Table - VALIDPROC panel.....	459	Create Procedure panel.....	538
Alter Table Space panel.....	460	Create Procedure: Option List (1/2) panel.....	539
Application Packages panel.....	460	Create Procedure: Option List (2/2) panel.....	541
Application Plans panel.....	463	Create Procedure: Parameter Types panel.....	542
Basic SELECT Prototyping panel.....	465	Create Procedure: Parameters panel.....	543
Bind Application Plan panel.....	470	Create Synonym panel.....	545
Bind Package panel.....	471	Create Table panel.....	546
Children of Table panel.....	471	Create Table Space panel.....	549
Collections panel.....	471	Create Table Space: Allocation panel.....	551
Column Attributes panel (alphanumeric).....	473	Create Table Space: Data Sharing Options panel.....	552
Column Attributes panel (DATE).....	477	Create Table Space: Data Storage Options panel.....	553
Column Attributes panel (numeric).....	478	Create Table Space: Define Partitions panel.....	555
Column Attributes panel (TIME).....	482	Create Table Space: Locking Options panel.....	557
Column Attributes panel (TIMESTAMP).....	483	Create Table Space: Type panel.....	558
Column Distribution panel.....	485	Create Table: Column Check Constraints panel.....	559
Column Part Statistics panel.....	485	Create Table: Column Referential Constraints panel.....	561
Column Selection/Edit panel.....	485	Create Table: Columns panel.....	562
Columns panel.....	491	Create Table: Generate Values panel.....	565
Columns in Index panel.....	492	Create Table: Model Load panel.....	566
Columns in Table panel.....	493	Create Table: Nulls and Default Values panel.....	568
Comment panels.....	493	Create Table: Options panel.....	571
Compiler Language Selection panel.....	493	Create Table: Procedure Exits panel.....	573
Constraint Columns for panel.....	495	Create Table: Table Check Constraints panel.....	574
Copy Options panel.....	495	Create Table: Table Referential Constraint panel.....	576
Copy Utility ("From") panel.....	498	Create Table: Table Referential Constraints panel.....	577
COPY Utility (Index Spaces) panel.....	502	Create Table: Unique Constraints panel.....	579
COPY Utility (Index Spaces) with LISTDEF panel.....	504	Create Trigger panel.....	580
Copy Utility ("To") panel.....	506	Create Trigger: Details panel.....	582
COPY Utility (Table Spaces) panel.....	509	Create Trigger: Search Condition panel.....	584
COPY Utility (Table Spaces) with LISTDEF panel.....	511	Create Trigger: SQL statement panel.....	584
Create Alias panel.....	512	Create View panel.....	585
Create Auxiliary Table panel.....	513	Create View Source Statements panel.....	587
Create Database panel.....	514	Data Create Utility panel.....	587
Create Distinct Type panel.....	516	Database Request Modules panel.....	591
Create Function: Option List (1/2) panel.....	518	Database Structure panel.....	592
Create Function: Option List (2/2) panel.....	519	Databases panel.....	593
Create Function panel.....	521	Db2® Browse panel.....	595
Create Function: Parameter Types panel.....	522	Db2® Edit panel.....	598
Create Function: Parameters panel.....	524	Db2® Location Selection panel.....	603
Create Function: Returned Data Type panel.....	525	Db2® Object Functions panel.....	604
Create Index panel.....	527	Db2® Save Error Action panel.....	606
Create Index: Allocation panel.....	530	Db2® Subsystem Selection panel.....	607
Create Index: Column Selection panel.....	531	Db2® Template Description panel.....	608

Db2® Utilities panel.....	610	LOAD from panel.....	704
Db2® View panel.....	613	LOAD Utility panel.....	706
Db2I Primary Option Menu panel.....	618	LOAD Utility panel using Db2® templates.....	707
Details panels.....	618	LOAD Utility - Using Templates panel.....	708
Display Row panel.....	619	LOAD Utility Options panel.....	710
Distinct Types panel.....	619	Manage Db2® Privileges panel.....	712
Drop panels.....	621	Object List Line Commands panel.....	714
Drop Confirmation panel.....	622	Object List Options (1 of 2) panel.....	714
Edit/Execute SQL (Data Set) panel.....	623	Object List Options (2 of 2) panel.....	717
Editor Options (1 of 8) panel.....	625	Object List Utility panel.....	719
Editor Options (2 of 8) panel.....	630	OPTIONS Options panel.....	721
Editor Options (3 of 8) panel.....	634	Package Dependencies panel.....	724
Editor Options (4 of 8) panel.....	641	Package List panel.....	724
Editor Options (5 of 8) panel.....	645	Parents of Table panel.....	724
Editor Options (6 of 8) panel.....	649	Partitioned Table Statistics panel.....	724
Editor Options (7 of 8) panel.....	652	Plan Dependencies panel.....	724
Editor Options (8 of 8) panel.....	656	Plan Enabled/Disabled Connections panel.....	725
Enter and Execute Db2® Commands panel.....	659	Plan Table Rows panel.....	725
Enter, Execute and Explain SQL Statements panel....	660	Primary Key for Table panel.....	728
EXPLAIN Interpretation panel.....	662	Primary Option Menu panel.....	728
Explain Utilities panel.....	662	Print Audit Trail panel.....	729
Export Options (1 of 3) panel.....	665	Print Utility Options panel.....	731
Export Options (2 of 3) panel.....	667	Print Utility panel.....	733
Export Options (3 of 3) panel.....	671	Privilege details panels.....	736
Export Utility ("From") panel.....	673	Privileges panels.....	736
Export Utility ("To") panel.....	676	Rebind Application Plan panel.....	738
Field Selection/Edit panel.....	679	Rebind Package panel.....	740
FM/Db2 Release News panel.....	683	REBUILD (Indexes for Table Spaces) panel.....	741
Foreign Keys for Table panel.....	683	REBUILD (Indexes for Table Spaces) with LISTDEF panel.....	743
Free Application Plan panel.....	683	REBUILD Utility (Indexes) panel.....	745
Free Package panel.....	683	REBUILD (Indexes) with LISTDEF panel.....	747
From Column Mapping panel.....	684	Record Type Selection panel.....	748
Functions panel.....	684	RECOVER Utility (Index Spaces) panel.....	748
Generate SQL From Db2® Catalog panel.....	686	RECOVER Utility (Index Spaces) with LISTDEF panel.....	750
Grant privileges panels.....	689	RECOVER Utility (Table Spaces) panel.....	751
Import Options panel.....	690	RECOVER Utility (Table Spaces) with LISTDEF panel.....	753
Import Utility ("From") panel.....	693	Recovery Information panel.....	755
Import Utility ("To") panel.....	694	Related tables panel.....	755
Index Parts panel.....	697	Remote Db2® Location Selection panel.....	759
Indexes panel.....	697	REORG Utility (Indexes) panel.....	760
Indexes and Columns for panel.....	699	REORG Utility (Indexes) with LISTDEF panel.....	761
ISPF Primary Option panel.....	700	REORG Utility (Table Spaces) panel.....	763
ISPF Settings panel.....	700	REORG Utility (Table Spaces) with LISTDEF panel....	765
Label Column panel.....	701	Revoke privileges panels.....	766
Label Table panel.....	701	Routine Parameters panel.....	767
LISTCAT Output Display panel.....	702		
LISTDEF Options panel.....	702		

Row Selection Criteria panel.....	767	TEMPLATE Options (2 of 2) panel.....	848
RUNSTATS Utility (Indexes) panel.....	772	Template Mapping panel.....	850
RUNSTATS Utility (Indexes) with LISTDEF panel.....	774	Template Save panel.....	852
RUNSTATS Utility (Table Spaces) panel.....	775	Triggers panel.....	853
RUNSTATS Utility (Table Spaces) with LISTDEF panel.....	777	UNLOAD Options panel.....	854
Schemas panel.....	779	UNLOAD Utility (Table Spaces) panel.....	857
Scramble Exit Specification panel.....	780	UNLOAD Utility (Table Spaces) with LISTDEF panel.....	858
Select Statement Browse panel.....	782	UNLOAD Utility (Tables) "From" panel.....	860
Select Statement Edit panel.....	782	UNLOAD Utility (Tables) "To" panel.....	861
Sequences panel.....	782	UNLOAD Utility (Tables) with LISTDEF panel.....	863
Set Batch Job Card Information panel.....	784	Utility Functions panel.....	864
Set COBOL Processing Options panel.....	785	Value List Edit panel.....	867
Set HLASM Processing Options panel.....	787	Volumes panel.....	868
Set Optimizer Hint panel.....	788	Chapter 18. FM/Db2 commands.....	870
Set Output Data Set Allocation Options panel.....	789	ABOUT primary command.....	870
Set PL/I Processing Options panel.....	790	ALL primary command.....	870
Set Print Processing Options panel.....	792	BACKWARD primary command.....	871
Set Processing Options panel.....	795	BOTTOM primary command.....	872
Set System Processing Options panel.....	797	BROWSE primary command.....	872
Set Temporary Data Set Allocation Options panel.....	800	CANCEL primary command.....	873
Set Trace options panel.....	801	CAPS primary command.....	874
Set Utility Options panel.....	803	CASE primary command.....	875
Sort Fields panel.....	804	CHANGE primary command.....	875
SQL Prototyping, Execution and Analysis panel.....	806	COL primary command.....	880
Statement Table Rows panel.....	808	CHARPOS primary command.....	881
Storage Group(s) panel.....	810	DELCOL primary command.....	882
Storage Group Usage Privileges panel.....	812	DELETE primary command.....	882
Stored Procedures panel.....	813	DESCRIBE primary command.....	884
Synonym Dependencies panel.....	815	DESELECT primary command.....	884
Synonyms panel.....	815	DOWN primary command.....	885
Systems Options (1 of 4) panel.....	817	EDIT primary command.....	886
Systems Options (2 of 4) panel.....	819	EDITCOL primary command.....	887
Systems Options (3 of 4) panel.....	821	END primary command.....	888
Systems Options (4 of 4) panel.....	823	EXCLUDE primary command.....	888
Table Browse panel.....	824	EXECUTE primary command.....	893
Table Check Constraint Dependencies panel.....	826	EXPAND primary command.....	893
Table Check Constraint Details panel.....	826	EXPLAIN primary command.....	894
Table Check Constraints panel.....	826	EXPORT primary command.....	894
Table Edit panel.....	826	FILE primary command.....	897
Table Edit (related) panel.....	832	FIND primary command.....	897
Table Selection panel.....	833	FMAP primary command.....	903
Table Space Parts panel.....	834	FORMAT primary command.....	904
Table Spaces panel.....	834	FORWARD primary command.....	904
Table View panel.....	837	FREE primary command.....	906
Table/View/Alias Selection panel.....	842	FS primary command.....	907
Tables, Views and Aliases panel.....	843	FT primary command.....	907
TEMPLATE Options (1 of 2) panel.....	846	HEX primary command.....	908

HIDE primary command.....	909	TP primary command.....	944
HINT primary command.....	910	TYPE primary command.....	944
HOLD primary command.....	910	UNDO primary command.....	945
INDEXINF primary command.....	911	UP primary command.....	945
INSRPT primary command.....	912	VER primary command.....	947
LEFT primary command.....	912	VIEW primary command.....	947
LHEX primary command.....	914	WIDTH primary command.....	948
LOBBRWS primary command.....	915	XMLBRWS primary command.....	949
LOBEDIT primary command.....	916	XMLEDIT primary command.....	950
LOBLEN primary command.....	917	XMLLEN primary command.....	951
LOBVIEW primary command.....	918	XMLVIEW primary command.....	952
LOCATE primary command.....	918	ZOOM primary command.....	952
LZERO primary command.....	923	Chapter 19. FM/Db2 functions.....	954
NEW, NEWS primary command.....	923	How to use this reference chapter.....	954
NEXT primary command.....	923	General tips about performance when you use File	
NEXTRPT primary command.....	924	Manager functions.....	954
ORDER primary command.....	924	FM/Db2 batch functions.....	955
PB primary command.....	925	BATSQ (Batch SQL) batch command.....	955
PLAN primary command.....	926	DBC (Copy) batch command.....	963
PREFIX primary command.....	926	DBI (Import) batch command.....	970
PREVIOUS primary command.....	927	DBP (Print) batch command.....	976
PREVRPT primary command.....	928	DBX (Export) batch command.....	979
PRINT primary command.....	928	D2G (Data Generate) batch command.....	994
PROTOCOL primary command.....	929	D2TP (Template create/update) batch	
PURGE primary command.....	929	command.....	996
QUIT primary command.....	930	Specifying a Db2® object name.....	999
RCHANGE primary command.....	930	Specifying the template for a Db2® object.....	1000
RD primary command.....	930	Specifying the template/copybook for a data	
REDIT primary command.....	931	set.....	1000
REFRESH primary command.....	932	Appendix A. Messages.....	1002
REFS primary command.....	932	FM/Db2 messages.....	1002
RESET primary command.....	932	Support resources.....	mcxxvii
RFIND primary command.....	933	Notices.....	mcxxviii
RIGHT primary command.....	934	Programming interface information.....	mcxxxi
RP primary command.....	935	Index.....	1132
RUNTEMP primary command.....	936		
SAVE primary command.....	937		
SAVEAS primary command.....	937		
SHADOW primary command.....	937		
SHOW primary command.....	938		
SHOW primary command.....	939		
SHOWCOB primary command.....	940		
SORT primary command.....	941		
SQL primary command.....	942		
SQLID primary command.....	943		
TEDIT primary command.....	943		
TOP primary command.....	944		

User's Guide and Reference for Db2 Data

This publication provides guidance and reference information for users of File Manager Db2® component (FM/Db2).

About this document

This document provides guidance and reference information for users of File Manager for z/OS® Db2® component (FM/Db2).

This document consists of three parts:

Part 1. Working with FM/Db2

Introduces key concepts and provides step-by-step instructions on how to perform tasks using the FM/Db2 panels under ISPF. The information is presented in a task-based format, with panel and command definitions provided when they are relevant to the current task. For a complete description of a particular panel or command, refer to the appropriate chapter in **Part 2 FM/Db2 reference**.

Part 1 can be used both as a learning tool for new users and as a way to quickly find specific task instructions.

Part 2. FM/Db2 reference

Provides a lookup reference for FM/Db2 panels and commands. The information is presented in two chapters:

- **FM/Db2 panels and fields:** Lists the FM/Db2 panels, alphabetically by panel title. For each listed panel, cross-references are provided to one or more “*parent*” panels (the panels from which you can reach the panel in question) and also, if applicable, cross-references to any “*child*” panels (the panels you can reach from this panel). For several of the panels, there is a definition for each field in the panel including, where applicable, the value ranges that are valid for each field.
- **FM/Db2 commands:** Lists the primary commands you can use with FM/Db2, including a description of their syntax and usage.

Both new and experienced users of FM/Db2 can use Part 2 to quickly look up such things as the exact syntax of a command or the acceptable values for a field in a panel.

Part 3. Appendix

“*FM/Db2 messages*”, provides the full text explanation of all FM/Db2 batch error messages. The support information tells you about IBM Web sites that can help you answer questions and solve problems.

File Manager for z/OS® contains four “*flavors*” of File Manager:

- **FM/Db2 component** for working with Db2® data.
- File Manager Base component for working with data sets and PDS members, Websphere MQ queues, and HFS files.
- **FM/IMS component** for working with IMS™ data.
- **FM/CICS** for working with CICS® resources.

This document describes only the FM/Db2 component. For information about the File Manager Base component, FM/IMS, and FM/CICS components, see these books:

- File Manager User's Guide and Reference
- *File Manager for z/OS User's Guide and Reference for IMS Data*
- File Manager for z/OS User's Guide and Reference for CICS

Who should use this document

This document is for three kinds of Db2® users:

- Application programmers who need to test and debug programs
- Service support personnel who need to analyze and fix problems
- System administrators and system operators who need to do routine tasks such as moving large amounts of data

This document assumes that you are familiar with Db2® and with using ISPF.

To use FM/Db2 functions in batch jobs, you must already be familiar with JCL.

National characters

File Manager uses the national characters shown in [Table 1: National characters on page xiv](#).

Table 1. National characters

Character	Hexadecimal value	Displayed as, in code pages 37 and 500
Dollar sign	X'5B'	\$
Pound sign	X'7B'	#
At sign	X'7C'	@



Note:

1. The dollar sign (\$) and the pound sign (#) have special syntactical meaning in File Manager syntax.
2. The at sign (@) is the default value used for the *"Null column input indicator"*.
3. In countries using code pages other than 37 and 500:

Table 1. National characters

(continued)

Character	Hexadecimal value	Displayed as, in code pages 37 and 500
		<p>a. The dollar sign (\$), pound sign (#), and at sign (@) as represented on terminal keyboards might generate a different hexadecimal representation, and this might cause an error or unwanted results. For example, in some countries the \$ character might generate a X'4A'.</p> <p>b. The hexadecimal values in Table 1: National characters on page xiv might display as different characters to those shown.</p>

When you enter File Manager commands in batch or online, use the keyboard characters that correspond to the hexadecimal values shown in [Table 1: National characters on page xiv](#).

Prerequisite and related information

FM/Db2 documentation supports the following tasks:

Planning for, installing, customizing, and maintaining FM/Db2

Refer first to the *File Manager Customization Guide*, which might then refer you to the File Manager Program Directory (included with the product tape) for some information.

Using FM/Db2

This document, the *File Manager User's Guide and Reference for DB2 Data*, is a guide to using FM/Db2. When using FM/Db2 under ISPF, you can also refer to the online help.

How to read syntax diagrams

The syntactical structure of commands described in this document is shown by means of syntax diagrams.

[Figure 1: Sample syntax diagram on page xvi](#) shows a sample syntax diagram that includes the various notations used to indicate such things as whether:

- An item is a keyword or a variable.
- An item is required or optional.
- A choice is available.
- A default applies if you do not specify a value.
- You can repeat an item.

Figure 1. Sample syntax diagram

Figure 1. Syntax

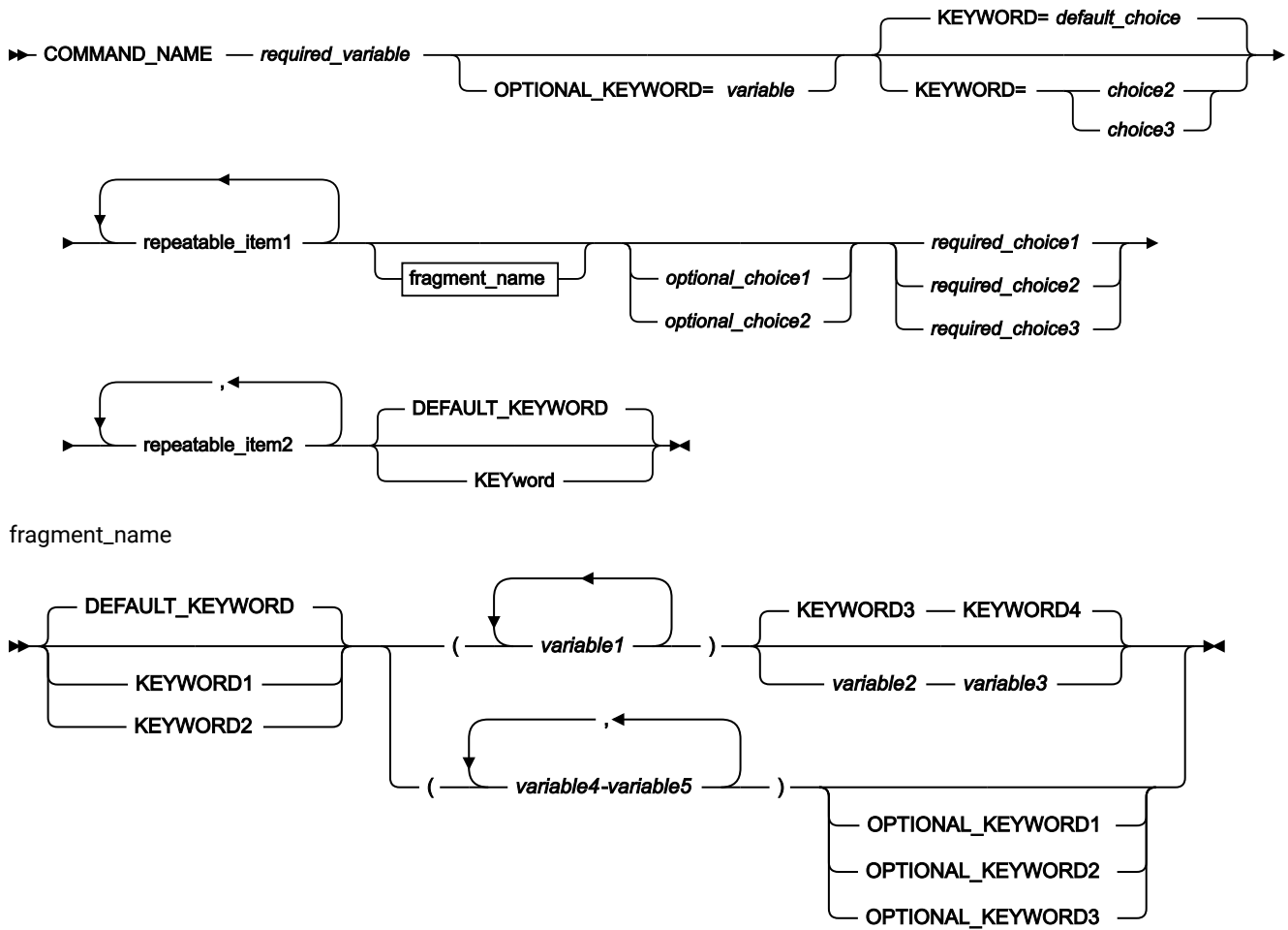

Here are some tips for reading and understanding syntax diagrams:

Order of reading

Read the syntax diagrams from left to right, from top to bottom, following the path of the line.

The **▶**— symbol indicates the beginning of a statement.

The —▶ symbol indicates that a statement is continued on the next line.

The —▶ symbol indicates that a statement is continued from the previous line.

The —▶ symbol indicates the end of a statement.

Keywords

Keywords appear in uppercase letters.

▶ **COMMAND_NAME** ▶

Sometimes you only need to type the first few letters of a keyword, The required part of the keyword appears in uppercase letters.

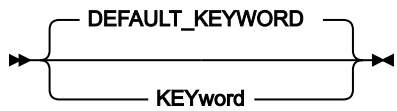

In this example, you could type "KEY", "KEYW", "KEYWO", "KEYWOR" or "KEYWORD".

The abbreviated or whole keyword you enter must be spelled exactly as shown.

Variables

Variables appear in lowercase letters. They represent user-supplied names or values.

▶▶ *required_variable* ◀◀

Required items

Required items appear on the horizontal line (the main path).

▶▶ **COMMAND_NAME** — *required_variable* ◀◀

Optional items

Optional items appear below the main path.



Choice of items

If you can choose from two or more items, they appear vertically, in a stack.

If you *must* choose one of the items, one item of the stack appears on the main path.

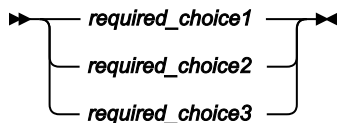

If choosing one of the items is optional, the entire stack appears below the main path.

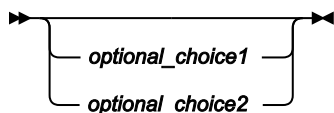

If a default value applies when you do not choose any of the items, the default value appears above the main path.

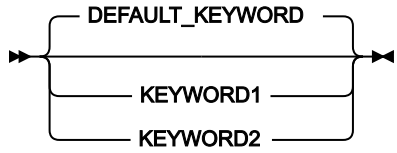

Repeatable items

An arrow returning to the left above the main line indicates an item that can be repeated.

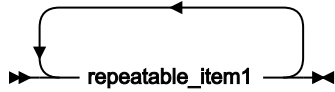

If you need to specify a separator character (such as a comma) between repeatable items, the line with the arrow returning to the left shows the separator character you must specify.

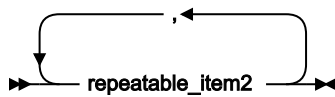

Fragments

Where it makes the syntax diagram easier to read, a section or *fragment* of the syntax is sometimes shown separately.

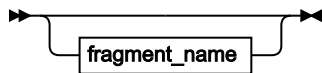

fragment_name

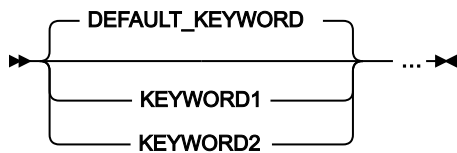

Summary of changes

November 2024, V15R1M6

This edition of the document provides information applicable to File Manager Version 15 Release 1 Modification Level 6. It contains minor changes and clarifications to the information in the previous version. Here are the major changes to this document from the previous release.

- A new option has been added to the Editor Options panel, **Show nullable column indicators**, so that FM/Db2 displays an indicator for columns with nullable status. See [Editor Options \(4 of 8\) panel on page 641](#) for more details. For example output, see [Table Edit panel on page 826](#), [Table Browse panel on page 824](#), and [Table View panel on page 837](#).
- Enhancement of SQL prototyping. See [Basic SELECT Prototyping panel on page 465](#).
- Added support for simple comments in SQL statement execution. See [Enter, Execute and Explain SQL Statements panel on page 660](#).

June 2024, V15R1M5

This edition of the document provides information applicable to File Manager Version 15 Release 1 Modification Level 5. It contains minor changes and clarifications to the information in the previous version.

March 2024, V15R1M4

This edition of the document provides information applicable to File Manager Version 15 Release 1 Modification Level 4. It contains minor changes and clarifications to the information in the previous version.

October 2023, V15R1M3

This edition of the document provides information applicable to File Manager Version 15 Release 1 Modification Level 3. It contains minor changes and clarifications to the information in the previous version.

June 2023, V15R1M2

This edition of the document provides information applicable to File Manager Version 15 Release 1 Modification Level 2. It contains minor changes and clarifications to the information in the previous version. Here are the major changes to this document from the previous release:

- The FM/Db2 Import function and the DBI (Import) batch command now support importing CSV files. See [Import Options panel on page 690](#) and [DBI \(Import\) batch command on page 970](#) for more details.
- Db2 CSV export now supports Quoted values, Single quotes and Leading zeros options similar to the File Manager copy function. The new options have been added to the Db2® CSV Export Options panels and the DBX (Export) batch command: QUOTED=YES/NO, SNGLQUOTE=YES/NO, and LZERO=YES/NO. See [Export Options \(2 of 3\) panel on page 667](#) and [DBX \(Export\) batch command on page 979](#) for more information about these options.

These changes, and smaller corrections and additions, are indicated by a “/” change bar in the left margin of the page.

March 2023, V15R1M1

This edition of the document provides information applicable to File Manager Version 15 Release 1 Modification Level 1. It contains minor changes and clarifications to the information in the previous version.

These changes, and smaller corrections and additions, are indicated by a “/” change bar in the left margin of the page.

October 2022, changes for V15R1 First Edition

This edition of the document provides information applicable to File Manager Version 15 Release 1 Modification Level 0. Here are the major changes to this document from the previous release.

- Two new options added to the Db2® CSV Export Options panels and the DBX (Export) batch command: LEADING=YES/NO and TRAILING= YES/NO. These options specify if leading and trailing blanks within Db2 CHAR and VARCHAR columns are to be included in the CSV exported data set. By default, leading blanks are included and trailing blanks are not included. See [Export Options \(2 of 3\) panel on page 667](#) and [DBX \(Export\) batch command on page 979](#) for more information about these options.
- FM/Db2 supports Db2® version 13.

These changes, and smaller corrections and additions, are indicated by a “/” change bar in the left margin of the page.

Part I. Working with FM/Db2

Chapter 1. FM/Db2 overview

FM/Db2 provides a comprehensive, user-friendly set of tools for working with Db2® data. These tools include the familiar view, edit, copy and print utilities found in ISPF, enhanced to meet the needs of application developers.

This chapter provides an overview of the types of actions you can perform with FM/Db2 and detailed concept information about templates, a means of viewing Db2® data in FM/Db2.

What you can do with FM/Db2

FM/Db2 is a powerful set of utility functions for editing, browsing, printing, copying, and maintaining Db2® data. For a description of the Db2® data types that FM/Db2 supports, see [Db2 data types on page 432](#).

It also provides utilities for listing Db2® objects, managing Db2® privileges, generating JCL to run Db2® standalone utilities, exporting and importing Db2® tables to or from QSAM or VSAM data sets, creating data to populate Db2® tables, and prototyping SQL SELECT statements.

FM/Db2 is an ISPF application program. It uses panels that you can use to select options and to specify parameters, commands and program function (F) keys to simplify requests for common functions, and full-screen format for information display and editing. If data does not fit on the screen, ISPF provides scrolling in all four directions.

Templates

FM/Db2 uses *templates* to provide a formatted view of your data, enabling you to view, edit, and manipulate data according to the columns and data types in the table you are working with.

What is a template?

A File Manager/Db2 template is a collection of information that you can use to select and format tables and columns in a Db2® object. If you use a File Manager/Db2 function that interfaces with non-Db2 data, the corresponding template describes the records and fields in the data set.

When you associate a template with data, you can:

Manipulate columns

You can select which columns you want to work with, adjust the order in which they are shown, and modify the column headings.

You can select to show leading zeros for numeric columns. (By default, leading zeros for numeric columns are suppressed. For example, 00057 is displayed as 57.)

Map data

If you are copying, importing, exporting, or loading data, you can “*map*” how data is transferred from the source to the destination.

Select rows

You can specify *row selection criteria* to restrict the data to the rows you want to work with.

Create data

If you are creating a new table, or adding new columns when moving data, you can specify *create attributes* that FM/Db2 uses to initialize column values.

If you use a File Manager/Db2 function that uses a template for a Db2® object, you can select one of the following options:

- Specify the name of an existing template
- Use FM/Db2 to generate a template (using information from the Db2® catalog for the Db2® object)
- Use the template that was last used with the Db2® object
- Use FM/Db2 to generate a template and immediately save the template using a name you specify

Related tasks

[Working with templates on page 72](#)

Where you can use templates

You can use templates to view, browse, edit, print, copy, import, export, create, or load data. The following table lists the panels where you can use templates:

Task	Panel
Browse data	View (option B)
View data	View (option 1)
Edit data	Edit (option 2)
Print data	Print (option 3.1)
Copy data	Copy (option 3.3)
Import data	Import (option 3.6) ¹
Export data	Export (option 3.7) ¹
Create data	Create (option 3.8)
Load data	Utilities (option 3.9), Db2® LOAD utility ¹
Unload data	Utilities (option 3.9), Db2® UNLOAD utilities ¹

Related tasks

[Viewing and changing Db2 data on page 119](#)

[Printing the contents of a Db2 table on page 321](#)

[Copying data from one Db2 object to another on page 241](#)

1. You can use a template or a copybook with these functions. See [Using templates with non-Db2 data on page 75](#).

[Copying data from a VSAM or QSAM file on page 246](#)

[Copying data to a VSAM or QSAM file on page 274](#)

[Populating a Db2 table with data on page 239](#)

[LOAD utility on page 349](#)

[UNLOAD \(tables\) on page 373](#)

[UNLOAD \(table spaces\) on page 378](#)

Related references

[Db2 Browse panel on page 595](#)

[Db2 View panel on page 613](#)

[Db2 Edit panel on page 598](#)

[Print Utility panel on page 733](#)

[Copy Utility \("From"\) panel on page 498](#)

[Import Utility \("From"\) panel on page 693](#)

[Export Utility \("From"\) panel on page 673](#)

[Data Create Utility panel on page 587](#)

[LOAD Utility panel on page 706](#)

[UNLOAD Utility \(Tables\) "From" panel on page 860](#)

[UNLOAD Utility \(Tables\) with LISTDEF panel on page 863](#)

[UNLOAD Utility \(Table Spaces\) panel on page 857](#)

[UNLOAD Utility \(Table Spaces\) with LISTDEF panel on page 858](#)

Chapter 2. System requirements for File Manager for Db2®

FM/Db2 supports:

- Db2® Version 12 (function level 500 or higher is required)
- Db2® Version 13

For information about "End of support (EOS)" dates for Db2 for z/OS, refer to the [IBM Product lifecycle website](#).

Where variations exist within FM/Db2 depending on the version of Db2® you are using, these variations are highlighted in this document by indicators that identify the start and end of a section of text. For example:



Note: Some examples shown in this document might reference older versions of DB2®. If you are using a later version of Db2® you might find minor variations in the appearance of FM/Db2 panels.

Chapter 3. Getting started with FM/Db2

This chapter provides answers to questions such as: "How do I enter and exit the application?", "How do I move around the application?", "How do I get help?", and "What do I need to do before I start working?" .

Related tasks

[Starting and exiting FM/Db2 on page 26](#)

[Selecting the Db2 subsystem when more than one is available on page 30](#)

[Using the FM/Db2 interface on page 35](#)

[Getting help on page 55](#)

[Setting default processing options on page 60](#)

Starting and exiting FM/Db2

FM/Db2 is an ISPF-developed application and is usually run from within an ISPF session. Exiting from FM/Db2 returns you to your ISPF session.

Related tasks

[Starting FM/Db2 on page 26](#)

[Exiting from FM/Db2 on page 29](#)

TSO region size

The minimum supported TSO region size for FM/Db2 is 16MB. While FM/Db2 can operate with region sizes in the range 4MB - 16MB, these region size specifications restrict the amount of *"below the line"* storage. If you encounter storage-related abends running with TSO region sizes less than 16 MB, attributable to *"below the line"* storage shortages, the remedy is to increase the TSO region size.

When processing large Db2® objects, significant amounts of 31-bit storage may be required.

For most applications a TSO region size of 32MB is a suitable starting point, this should be increased if there is a need to process large Db2® objects.

When using the GEN prefix command, the minimum suggested TSO region size is 32MB. Increase this to 64MB when processing large databases.

Related tasks

[Storage considerations on page 135](#)

[Viewing large tables or views on page 136](#)

Starting FM/Db2

How you start FM/Db2 depends on how it has been installed on your system. Typically, FM/Db2 is installed as an option on your z/OS® Primary Option Menu:

Figure 3. z/OS® Primary Option Menu panel showing FM/Db2 option

```

Menu  Utilities  Compilers  Options  Status  Help
-----
                        z/OS Primary Option Menu

0  Settings      Terminal and user parameters      User ID . . : FMNUSER
1  View          Display source data or listings   Time. . . . : 15:11
2  Edit          Create or change source data      Terminal. . : 3278
3  Utilities     Perform utility functions         Screen. . . : 1
4  Foreground   Interactive language processing   Language. . : ENGLISH
5  Batch         Submit job for language processing Appl ID . . : ISR
6  Command      Enter TSO or Workstation commands TSO logon  : ISPFPROC
7  Dialog Test  Perform dialog testing            TSO prefix : FMNUSER
9  IBM Products IBM program development products  System ID  : FMD2
10 SCLM         SW Configuration Library Manager  MVS acct.  : USER
11 Workplace   ISPF Object/Action Workplace     Release . . : ISPF 5.0
F  File Manager File Manager for z/OS®
FD FM/Db2    FM/Db2                ◀ New

Option ==>>
  F1=Help      F2=Split    F3=Exit     F7=Backward F8=Forward  F9=Swap
 F10=Actions  F12=Cancel

```

To start FM/Db2:

1. Select the FM/Db2 option from the z/OS® Primary Option Menu.



Note: If FM/Db2 is not an option on your menu, ask your systems administrator to explain the startup process used at your site.

When you start FM/Db2, the FM/Db2 Primary Option Menu is shown, with the current version information displayed in a pop-up message box.

Figure 4. FM/Db2 Primary Option Menu panel with version information

```

Process  Options  Help
-----
FM/Db2 (DF72)                Primary Option Menu

0 Settings      Set processing options      User ID . : FMUSER
1 View         View Db2 object            System ID : FMD2
2 Edit         Edit Db2 object            Appl ID . : FMN2
3 Utilities     Perform utility functions   Version . : 15.1.6
4 SQL          Prototype, execute and analyze SQL Terminal : 3278
5 DB2I        Start DB2 Interactive       Screen  . : 1
6 Command      Enter and execute a DB2 Command Date . . : 2024/01/01
7 Template     Template utilities        Time   . . : 10:14
X Exit        Terminate FM/Db2

                                           Db2 SSID . DF72

IBM* File Manager for z/OS Version 15 Release 1 Modification
6
5755-A03 Db2 Component
Licensed Materials - Property of IBM* and HCL**
(C) Copyright IBM Corp. 2001, 2017 - All Rights Reserved.
(C) Copyright HCL Technologies Ltd. 2017, 2024 - All Rights Reserved.
* Trademark of International Business Machines
** Trademark of HCL Technologies Limited

Command ==> ABOUT
F1=Help      F2=Split      F3=Exit      F4=Expand      F7=Backward  F8=Forward
F9=Swap      F10=Left     F11=Right   F12=Cancel
    
```

2. Press Enter to close the version window.

Checking your FM/Db2 version

To display the full version information for FM/Db2, enter VER on the command line of any panel. The current FM/Db2 version number and the PTF number for each FM/Db2 component is displayed in a window. The pop-up also indicates whether or not FM/Db2 is APF-authorized.

Figure 5. FM/Db2 Primary Option Menu panel with PTF information

```

Process  Options  Utilities  Help
-----
FM/Db2 (DF13)                Primary Option Menu
Command ==> VER

0 Settings      Set processing options      User ID . : FMUSER

IBM File Manager for z/OS Version 15 Release 1 Modification
6
Db2 Component
(not APF authorized)

Service Levels of installed components

English      Base      IMS      Db2      CICS
Japanese     xxxxxxxx xxxxxxxx xxxxxxxx xxxxxxxx xxxxxxxx
              xxxxxxxx xxxxxxxx xxxxxxxx xxxxxxxx xxxxxxxx

F1=Help      F2=Split      F3=Exit      F9=Swap      F12=Cancel
:
    
```

An alternative way to display version information is to select **Help > 7. About** from the Action Bar. The current FM/Db2 version number and the PTF number of the Db2® component are displayed. The pop-up panel also shows the copyright information and any notes that are shipped with the product.

```

  Process  Options  Utilities  Help
  -----
FM/Db2 (DF13)                Primary Option Menu
Command ==> ABOUT

0  Settings      Set processing options          User ID . : FMUSER
1
2
3  IBM File Manager for z/OS Version 15 Release 1 Modification
4  Db2 Component
5  PTF level: FM5015
6
7  5755-A03 (C) Copyright IBM Corporation 1986, 2017 - All rights reserved.
X  (C) Copyright HCL Technologies Ltd. 2017, 2024 - All rights reserved.
   Note to US Government Users -- Documentation related to restricted
   rights -- Use, duplication or disclosure is subject to restrictions
   set forth in GSA ADP Schedule Contract with IBM Corp.

   F1=Help      F2=Split      F3=Exit      F9=Swap      F12=Cancel

F1=Help      F2=Split      F3=Exit      F4=Expand      F7=Backward  F8=Forward
F9=Swap      F10=Left     F11=Right   F12=Cancel

```

Related references

[VER primary command on page 947](#)

[Action bar pull-down menu on page 436](#)

Checking which COBOL compiler you're using

FM/Db2 uses the currently loaded COBOL compiler to create a template from a COBOL copybook.

To display details about the current COBOL compiler, enter SHOWCOB on the Command line of any panel. FM/Db2 displays details about the current COBOL compiler in a window.

Related topics

[SHOWCOB primary command on page 940](#)

Exiting from FM/Db2

You can exit from FM/Db2 from the Primary Options Menu panel in any of the following ways:

- Press the Exit function key (F3).
- Enter `x` (or `EXIT` or `END`) on the command line.
- Select **Process > Exit FM/Db2** from the Action Bar.

To exit the application from a panel within FM/Db2:

- Enter `=x` on the command line.

Related references

[END primary command on page 888](#)

[Action bar pull-down menu on page 436](#)

Selecting the Db2® subsystem when more than one is available

On most FM/Db2 panels, the currently connected Db2® subsystem is displayed immediately after the product name.

For instance, in [Figure 6: Primary Option Menu panel on page 31](#), `FM/Db2 (DFG2)` (before the panel title) shows that the current Db2® subsystem is DFG2.

If your system contains more than one active Db2® subsystem, you can select the subsystem to which you want FM/Db2 to connect by entering a value in the **Db2 SSID** field on the Primary Option Menu. You can also use the SSID command in some FM/Db2 panels.

The first time you use FM/Db2, if your system contains multiple active Db2® subsystems, FM/Db2 immediately displays the Db2® Subsystem Selection panel.



Note:

1. FM/Db2 can only run on a system that has at least one active Db2® subsystem that uses a supported version of Db2®.
2. If your system contains only one active Db2® subsystem, FM/Db2 automatically connects to that subsystem.

Related tasks

[Selecting the Db2 subsystem by using the Db2 SSID field on page 30](#)

[Selecting the Db2 subsystem by entering the SSID command on page 32](#)

Related references

[Primary Option Menu panel on page 728](#)

[Db2 Subsystem Selection panel on page 607](#)

Selecting the Db2® subsystem by using the Db2 SSID field

When you start FM/Db2, the Primary Option Menu panel is displayed.

Figure 6. Primary Option Menu panel

```

  Process  Options  Utilities  Help
  -----
FM/Db2 (DFG2)                Primary Option Menu

0 Settings      Set processing options      User ID . . : FMNUSER
1 View          View Db2 object             System ID . : MVS8
2 Edit          Edit Db2 table              Appl ID . . : FMN2
3 Utilities     Perform utility functions   Version . . : 15.1.6
4 SQL           Prototype, execute and analyze SQL Terminal . : 3278
5 Db2I          Start Db2 Interactive        Screen . . : 1
6 Command       Enter and execute a Db2 Command Date . . . : 2019/01/07
7 Template      Template utilities          Time . . . : 08:54
X Exit          Terminate FM/Db2

                                Db2 SSID . DFG2
                                SQL ID . . FMNUSER +

Command ==>>
F1=Help      F2=Split      F3=Exit      F4=Expand      F7=Backward  F8=Forward
F9=Swap      F10=Left     F11=Right   F12=Cancel

```

The **Db2 SSID** field shows the ID of the Db2® subsystem to which FM/Db2 is currently connected. (The Db2® subsystem is also shown before the panel title.) In [Figure 6: Primary Option Menu panel on page 31](#), FM/Db2 is connected to the DFG2 subsystem.

To select a Db2® subsystem using the **Db2 SSID** field, you can use any of the following methods:

- Overtyping the SSID that is currently displayed with the ID of another active Db2® subsystem, and then pressing Enter.

For example, in [Figure 6: Primary Option Menu panel on page 31](#), to connect to the Db2® subsystem DFB2, overtype DFG2 with DFB2, and then press Enter.

- Entering an asterisk (*) or blanks in the **Db2 SSID** field, and then pressing Enter. FM/Db2 displays the Db2 Subsystem Selection panel showing a list of all the Db2® subsystems in your environment from which you can select the Db2® subsystem you want.
- Entering a partial ID, starting or ending with an asterisk (*), or enclosed within two asterisks, in the **Db2 SSID** field, and then pressing Enter. FM/Db2 displays the Db2 Subsystem Selection panel showing a restricted list of Db2® subsystems from which you can select the Db2® subsystem you want.

The following examples demonstrate how you can use the (*) wildcard if specifying a partial Db2® subsystem ID:

DB*

Lists all Db2® subsystems whose ID starts with "DB"

***TST**

Lists all Db2® subsystems whose ID ends with "TST"

2

Lists all Db2® subsystems whose ID contains "2"



Note: To change the Db2® subsystem from a panel other than the Primary Option Menu panel, use the SSID command.

Related tasks

[Using the Db2 Subsystem Selection menu on page 33](#)

[Selecting the Db2 subsystem by entering the SSID command on page 32](#)

Related references

[Primary Option Menu panel on page 728](#)

[Db2 Subsystem Selection panel on page 607](#)

Selecting the Db2® subsystem by entering the SSID command

To connect to a different Db2® subsystem, use the SSID command followed by the name of the Db2® subsystem to which you want to connect.

The SSID command can be used from menu panels, option panels, and most function entry panels. For example, to change to the DB27 subsystem, enter the command:

```
SSID DB27
```

When you use the SSID command, be aware of the following restrictions:

- The name you specify must be an active Db2® subsystem.
- The name you specify must not contain an asterisk (*) or wildcard.
- Once a File Manager/Db2 dialog has started, you cannot use the SSID command to change the currently connected Db2® subsystem.

To display a list of all the Db2® subsystems in your environment, use the **Db2 SSID** field on the Primary Option Menu panel.



Note:

- DB2SYS is a synonym for the SSID command. When FM/Db2 was installed these command names might have been customized to something else. If so, references to the SSID command in this document will apply instead to these customized command names.

To verify the names of the SSID commands at your site, refer to the Db2 Subsystem Selection Tutorial Help panel:



1. From the Primary Option Menu panel, press the Help function key (F1).
2. From the “*FM/Db2 Tutorial - Table of Contents*” panel, select item **D** (Db2 SSID).

The “*FM/Db2 Tutorial - Db2 Subsystem Selection*” panel shows the name of the command and its synonym that were set when FM/Db2 was installed.

- You can abbreviate the command name to as few as 4 characters.

Related tasks

[Using the Db2 Subsystem Selection menu on page 33](#)

[Selecting the Db2 subsystem by using the Db2 SSID field on page 30](#)

[Accessing Tutorial Help on page 55](#)

Related references

[Primary Option Menu panel on page 728](#)

Using the Db2® Subsystem Selection menu

You use the Db2® Subsystem Selection menu to select the Db2® subsystem to which you want FM/Db2 to connect. It shows a list of the Db2® subsystems in your environment and is displayed:

- The first time you use FM/Db2 (providing your system contains multiple active Db2® subsystems),
- If you enter any of the following in the **Db2® SSID** field on the Primary Option Menu:
 - An asterisk (*)
 - Spaces
 - A partial ID, starting or ending with an asterisk (*), or both

If you enter a partial ID in the **Db2® SSID** field on the Primary Option Menu, the list of Db2® subsystems is restricted accordingly.

Related references

[Primary Option Menu panel on page 728](#)

[Db2 Subsystem Selection panel on page 607](#)

Selecting a subsystem

To select a Db2® subsystem from the Db2® Subsystem Selection menu:

1. Enter s (or ?) in the **Sel** column for the Db2® subsystem you want.

The status of the subsystem you select must be "ACTIVE" or "GROUP", and the subsystem must have been defined in the FM/Db2 installation module. For Db2® systems that do not meet these criteria, the selection field is disabled.

2. Press Enter.

FM/Db2 displays the Primary Option Menu. The ID of the subsystem you selected is displayed in the **Db2® SSID** field showing that FM/Db2 is now connected to that Db2® subsystem.

Related references

[Primary Option Menu panel on page 728](#)

[Db2 Subsystem Selection panel on page 607](#)

Refreshing the list of Db2® subsystems

To refresh the list of Db2® subsystems on the Db2® Subsystem Selection menu, use the Refresh (F5) function key or enter the primary command REFRESH.

The refreshed list of Db2® subsystems reflects any changes that have occurred since you last displayed the list (for example, the status of each Db2® subsystem).

Related references

[REFRESH primary command on page 932](#)

[Db2 Subsystem Selection panel on page 607](#)

Restricting the list of Db2® subsystems

You can restrict the list of Db2® subsystems shown on the Db2® Subsystem Selection menu by using the SHOW primary command or the Show function key (F6).

Either of the following commands lists all Db2® subsystems:

```
SHOW *
```

```
SHOW
```

The following examples demonstrate how you can use the SHOW primary command to restrict the list of Db2® subsystems shown on the Db2® Subsystem Selection menu using the asterisk (*) wildcard and a partial Db2® subsystem ID:

SHOW MM*

Restricts the list to Db2® subsystems with an ID starting with "MM"

SHOW *PBJ

Restricts the list to Db2® subsystems with an ID ending with "PBJ"

SHOW *V*

Restricts the list to Db2® subsystems with an ID containing "V"

The Show function key (F6) works in the same way as the SHOW command, except that it uses the contents of the command line as the selection criteria. For example:

- If the command line is blank and you press the Show function key (F6), FM/Db2 lists all Db2® subsystems. (You would get the same result if the command line contained an asterisk (*)).
- If you type `DBT*` on the command line and press the Show function key (F6), FM/Db2 lists all Db2® subsystems whose ID begins with "DBT".
- If you type `*26` on the command line and press the Show function key (F6), FM/Db2 lists all Db2® subsystems whose ID ends with "26".
- If you type `*AB*` on the command line and press the Show function key (F6), FM/Db2 lists all Db2® subsystems whose ID contains "AB".

Related references

[Db2 Subsystem Selection panel on page 607](#)

[SHOW primary command on page 938](#)

Using the FM/Db2 interface

The FM/Db2 interface is based upon the ISPF model. Tasks are performed by processing a function, together with its applicable parameters. Panels provide a user-friendly way of selecting a function and supplying the parameter information. Some functions can be processed in your choice of "foreground" or "batch" mode. In foreground mode, the selected function is processed immediately and any results are returned to you on screen or directed to print outputs, as dictated by your default settings. In batch mode, JCL is generated from the panel information, and then presented to you for editing. You can modify this code and submit it to a processing queue.

This section provides instructions on how to navigate to panels within FM/Db2 and how to specify common panel information.

Navigating in FM/Db2

You navigate around FM/Db2 panels in the same way as any other panels under ISPF. That is, you launch processing panels from menu panels, by entering the appropriate menu option number on the command line. FM/Db2 uses a Primary Options Menu panel to provide access to processing panels that are related to a particular function or group of functions. In some cases, an option on the Primary Options menu leads to another menu panel, from which you can select the required processing panel.

To access a panel, choose one of the following methods:

- Type the menu option number on the Command line and press Enter. Repeat for each nested menu until the required processing panel is displayed.
- From the Primary Option Menu, type the complete menu path to the required panel, separating each menu level with a period, then press Enter. For example, entering `3.4` takes you directly to the Object List Utility panel.
- Use "point-and-shoot" for fields on menu panels. To use this facility, place the cursor on the name of the menu option that is required, and press Enter.



Note: ISPF provides an "=" parameter that you can specify before an option selection. For example, =3.4. When supported, the "=" parameter enables direct navigation to the specified menu option from another unrelated option within an ISPF application.

The "=" parameter is not supported by FM/Db2.

To exit from a panel, choose one of the following methods:

- Press the Exit function key (F3).
- Type `x` on the command line and press Enter.
- Type `END` on the command line and press Enter.

Many FM/Db2 panels have more information than can be seen in a single screen, particularly when you are running in 80x24 display. In this case, a "More" indicator is displayed near the upper right corner of the panel with a plus sign (+), a minus sign (-), or both.

Figure 7. Example panel showing "More" message

```

                                FM/Db2 Tutorial - Ed/Br Options
                                More:  - +
session are only presented to Db2 when an explicit save command is issued,
or at the end of the edit session.

Save data
When this option is selected, all pending changes are submitted to Db2 for
processing whenever the enter key is pressed (and no other operations are

```

A plus sign (+) adjacent to the word "More" indicates more information is available on a following panel. Press the `NxtPage` function key (F11) to display the next information panel.

A minus sign (-) adjacent to the word "More" indicates more information is available on a previous panel. Press the `PrvPage` function key (F10) to display the previous information panel.

To scroll down the panel, choose one of these methods:

- Press the Forward function key (F8). This scrolls down one screenful of lines.
- Enter `FORWARD` or `DOWN` on the command line. These commands scroll down one screenful of lines.
- Enter `BOTTOM` on the command line. This takes you to the bottom of the panel.

To scroll up the panel, choose one of these methods:

- Press the Backward function key (F7). This scrolls up one screenful of lines.
- Enter `BACKWARD` or `UP` on the command line. These commands scroll up one screenful of lines.
- Enter `TOP` on the command line. This takes you to the beginning of the panel.

Related references

Scrolling on page 157

BACKWARD primary command on page 871

BOTTOM primary command on page 872

DOWN primary command on page 885

END primary command on page 888

FORWARD primary command on page 904

TOP primary command on page 944

UP primary command on page 945

Screen size on page 39

FM/Db2 panel features

This section describes the general features of FM/Db2 panels.

Figure 8: Typical FM/Db2 panel on page 37 shows a typical FM/Db2 panel.

Figure 8. Typical FM/Db2 panel

Process	Options	Utilities	Help					①
FM/Db2 (DFG2)			Table Edit				0 of 42	③
TABLE FMUSER.EMP							Format TABL	
EMPNO	FIRSTNME	MIDINIT	LASTNAME	WORKDEPT	PHONENO		HIREDATE	
#1	#2	#3	#4	#5	#6		#7	
CH(6)	VARCHAR(12)	CH(1)	VARCHAR(15)	CH(3)	CH(4)		DATE	
PU-->	<-----1-->	-	<-----1----->	<-NF	<-->		<----->	
000001	000010	CHRISTINE<	I	HAAS<	A00	3978	01.01.1965	
000002	000020	MICHAEL<	L	THOMPSON<	B01	3476	10.10.1973	
000003	000030	SALLY<	A	KWAN<	C01	4738	05.04.1975	
000004	000050	JOHN<	B	GEYER<	E01	6789	17.08.1949	
000005	000060	IRVING<	F	STERN<	D11	6423	14.09.1973	
000006	000070	EVA<	D	PULASKI<	D21	7831	30.09.1980	④
000007	000090	EILEEN<	W	HENDERSON<	E11	5498	15.08.1970	
000008	000100	THEODORE<	Q	SPENSER<	E21	0972	19.06.1980	
000009	000110	VINCENZO<	G	LUCCHESI<	A00	3490	16.05.1958	
000010	000120	SEAN<	H	O'CONNELL<	A00	2167	05.12.1963	
000011	000130	DOLORES<	M	QUINTANA<	C01	4578	28.07.1971	
000012	000140	HEATHER<	A	NICHOLLS<	C01	1793	15.12.1976	
000013	000150	BRUCE<	A	ADAMSON<	D11	4510	12.12.1972	
Command ==>							Scroll PAGE	
F1=Help	F2=Zoom	F3=Exit	F4=CRetriev	F5=RFind	F6=RChange			⑥
F7=Up	F8=Down	F9=Swap	F10=Left	F11=Right	F12=Cancel			

In general, the following lines are displayed on FM/Db2 panels:

① Action bar

Provides access to pull-down menus that give you a fast way to move around the product.



Note: The action bar is not displayed if you select Start Db2® Interactive (option 5).

② Panel title

Identifies the function being carried out.

③ Row count information (editor sessions only)

Shows row number (of top row currently displayed) and total number of rows fetched for the current FM/Db2 editor session.

4 Panel body

Shows information pertaining to the panel.

5 Command line

Use to enter a command or, on a menu, to enter either a command or an option. The command can be any ISPF command or valid FM/Db2 primary command for the FM/Db2 function being carried out.

To change the position of the command line (the bottom or top of the panel, see the *ISPF User's Guide*).

6 Function keys

Displays the settings for the function keys (also known as "Programmable Function" or "PF" keys). For most FM/Db2 panels, these settings are the ISPF function key values. However, for some FM/Db2 panels, these settings are preset to correspond with the needed values for the FM/Db2 function.

For information about default function key values, and how to define your own function key values, see the *ISPF User's Guide*.

Selecting an item from the action bar

To select an item from the action bar:

1. Move the cursor to the item on the action bar; for example, **Options** (see [Figure 9: Action bar menu on page 38](#)).
2. Press Enter. FM/Db2 displays a pull-down menu with choices relating to the action bar item you selected.
3. Select a choice from the pull-down menu. Either:
 - Type the pull-down menu selection number (for example, 6 for **Print settings**), and press Enter, or
 - Move the cursor with the Up or Down arrow keys to the required choice, and press Enter.

An asterisk in front of a choice on a menu indicates that the choice is not available for the current panel.

Figure 9. Action bar menu

Process	Options	Utilities	Help
FM/Db2 (— 1. Print settings		Top of 42
42 rows	2. FM/Db2 system options		Format TABL
E	3. Job card specifications	WORKDEPT	PHONENO
#	4. Compiler language selection	#5	#6
C	5. COBOL compiler specifications	CH(3)	CH(4)
P	6. HLASM compiler specifications	<-NF	<--->
***** *	7. PL/I compiler specifications		<----->
000001 0	8. Temporary Data Set Allocations	A00	3978
000002 0	9. Output Data Set Allocations	B01	3476
000003 0	10. ISPF settings	C01	4738
000004 0	11. Editor options	E01	6789
000005 0	12. Copy utility options	D11	6423
000006 0	13. Object list utility options	D21	7831
000007 0	14. Export utility options	E11	5498
000008 0	15. Db2 LOAD utility options	E21	0972
000009 0	16. Db2 Utility LISTDEF options	A00	3490
000010 0	17. Db2 Utility OPTIONS options	A00	2167
000011 0	18. Db2 Utility TEMPLATE options	C01	4578
000012 0	19. Db2 Unload utility options	C01	1793
Command			Scroll PAGE
F1=Help	F2=Zoom	F3=Exit	F4=CRetriev
F7=Up	F8=Down	F9=Swap	F10=Left
			F5=RFind
			F11=Right
			F6=RChange
			F12=Cancel

Related references

[Action bar pull-down menu on page 436](#)

Screen size

FM/Db2 is designed to handle screen sizes larger than 24 x 80 characters.

For information about ISPF settings affecting terminal characteristics, see the *ISPF User's Guide*.

Scrollable input and display fields for long names

FM/Db2 uses scrollable fields on FM/Db2 panels to allow you to input and view values longer than the field length.

"There are two types of scrollable fields on FM/Db2 panels:

Input fields

The fields on FM/Db2 panels where you can *enter* information, such as the name of an owner (or creator), the name of a Db2® object, or the name of a Db2® column.

Display fields

The fields on FM/Db2 panels that *display* information as a result of some action you have taken.

"The following two sections describe how to work with both types of scrollable fields."

Working with scrollable input fields

On panels where you can enter the name of:

- The owner (or creator),
- A Db2® object, or
- A column

FM/Db2 provides scrollable input fields that allow you to enter values longer than length of the displayed entry field.

You can recognise a scrollable field by the presence of one of the following adjacent to the end of the entry field:

+

Plus sign. Indicates the field is scrollable to the right

-

Minus sign. Indicates the field is scrollable to the left

+-

Plus sign and minus sign. Indicates the field is scrollable to the right or left

If the length of the input field displayed on the panel is insufficient for the value you want to enter, perform one of these actions:

- Progressively scroll to the right as you enter the value with the Right function key (F11) or by entering the RIGHT primary command (with the cursor positioned within the entry field),
- Press the Expand function key (F4), or enter the EXPAND primary command, to display a window that allows you to enter the full length of the value

Figure 10: Db2 View panel: format displayed when connected to a Db2 V8 system on page 40 shows the format of the Db2® View panel. The “+” symbol adjacent to the **Owner** and the **Name** input fields indicates that both are scrollable fields.

Figure 10. Db2® View panel: format displayed when connected to a Db2® V8 system

```

  Process  Options  Utilities  Help
  -----
FM/Db2 (DFG2)                               Db2 View

Specify the Db2 Object:
Location . . . . . _____ Database . . _____ (optional)
Owner . . . . . _____ + Table space _____ (optional)
Name . . . . . _____ +

Row count . . . . . 100 Number of rows to browse

Template:
Data set name . . . 'FMNUSER.TEMPLATE'
Member . . . . . SALARY

Processing Options:
Template usage          Enter "/", "A"lways to select option
3 1. Above             _ Edit options
  2. Previous          _ Edit template
  3. Generate from table _ Re-edit template
  4. Generate/Replace

Command ==> _____
F1=Help    F2=Split  F3=Exit   F4=Expand  F5=Actions  F7=Backward
F8=Forward F9=Swap    F10=Left  F11=Right  F12=Cancel
  
```

The **Owner** input field displayed on the panel allows for up to 16 characters to be entered. To enter the name of an owner that is longer than 16 characters, you must use the scrolling or expand capabilities of the **Owner** input field.

For example, to enter the 21-character name “HANSCHRISTIANANDERSON”, you can perform either of these actions:

- Type the first 16 characters of the name (HANSCHRISTIANAND) in the **Owner** field, use the left arrow key (←) to position the cursor back in the **Owner** input field, press the Right function key (F11) to scroll right, and then type the remainder of the name (ERSON) in the **Owner** field,
- Press the Expand function key (F4), or enter the EXPAND primary command, to display a window that allows you to enter the full name, and then press the Exit function key (F3) to return to the Db2® View panel.

Figure 11: Window when entering a long input name on page 41 shows the window for the Owner field with the full name entered.

Figure 11. Window when entering a long input name

```

FMN2ECRE+0
Line 1 of 2
HANSCHRISTIANANDERSON
Command ==>
F1=Help      F2=Split    F3=Exit     F5=Rfind    F6=Rchange  F7=Up
F8=Down      F9=Swap     F10=Left    F11=Right   F12=Cancel
Scroll ==> PAGE

```

When you press the Exit function key (F3) to return to the Db2® View panel, the **Owner** input field shows the first 16 characters of the name you entered:

```

:
Specify the Db2 Object:
Location . . . . . _____ Database . . _____ (optional)
Owner . . . . . HANSCHRISTIANAND + Table space _____ (optional)
Name . . . . . _____ +
:

```

To see the rest of the name in the **Owner** input field, scroll right by either pressing the Right function key (F11) or entering the RIGHT primary command (ensuring the cursor is positioned within the **Owner** input field):

```

:
Specify the Db2 Object:
Location . . . . . _____ Database . . _____ (optional)
Owner . . . . . ERSON + Table space _____ (optional)
Name . . . . . _____ +
:

```

Deleting data in scrollable input fields

If you want to delete all the data in a field that is displayed as a scrollable input field, take care to ensure that you do, in fact, delete all the data (and not just the displayed data).

If you use the field delete key combination to delete data, FM/Db2 deletes only the data that is currently displayed. If the field contains more data than is displayed, the undisplayed data is left undeleted.

It is recommended that, before deleting data in a field that is displayed as a scrollable field, you first display the entire contents of the field by pressing the Expand function key (F4) or entering the EXPAND primary command. You can then use the field delete key combination to delete all data in the field at once.

Working with scrollable display fields

Many FM/Db2 panels show data displayed in scrollable fields. FM/Db2 uses such fields where the length of the field containing the data to be displayed is longer than the field displayed on the panel.

You can recognise a scrollable field by the presence of one of the following adjacent to the end of the display field:

+

Plus sign. Indicates the field is scrollable to the right

-

Minus sign. Indicates the field is scrollable to the left

+-

Plus sign and minus sign. Indicates the field is scrollable to the right or left

If the data to be displayed is longer than the length of the display field on the panel, you can view the rest of the data by performing either of these actions:

- Progressively scrolling to the right by pressing the Right function key (F11) or by entering the RIGHT primary command (with the cursor positioned within the display field),
- Pressing the Expand function key (F4) or entering the EXPAND primary command to display a window that allows you to view the entire contents of the field.

[Figure 12: Table Details panel: example showing scrollable fields on page 43](#) shows the Table Details panel which includes a number of scrollable display fields (those with a “+” symbol adjacent to the end of the field: **Table owner**, **Table name**, **Created by**, **Created**, and **Altered**). Scrollable display fields indicate that, possibly, not all of the data held in the field is being displayed.



Note: The presence of a “+” symbol indicates that the field is scrollable and *may* contain more data than is currently being displayed. It does not necessarily mean that more data exists than is currently being shown.

Figure 12. Table Details panel: example showing scrollable fields

Process	Options	Utilities	Help
FM/Db2 (DFG2)		Table Details	
		More: +	
Details about table (label) : KPS8610L01234567890123456789012345678901234567			
General Data:			
Table owner	: KPS8610LO	+ Table name	: DUMMY_TABLE_WI +
Created by	: SHRIKES	+ Database name	: DSNDB04
Table space name	: DUMMYRTA	DB ID for database	: 4
Object ID for table	: 3	Primary key OBID	: N/A
Maximum row length	: 69	Primary key columns	: N/A
Number of columns	: 4	Edit procedure name	: N/A
Validation proc.	: N/A	Check pending flag	: No
Parent relations	: 0	Check constraints	: None
Child relations	: 0	Encoding scheme	: E - EBCDIC
Auditing	: AUDIT NONE	Status	: No primary key
Data capture	: No	Created	: 2004-05-10-11. +
Restrict on DROP	: No	Altered	: 2004-05-10-11. +
Release created	: L	Dep. query tables	: 0
Command ==>			
F1=Help	F2=Split	F3=Exit	F4=Expand
F8=Forward	F9=Swap	F10=Left	F11=Right
			F5=Actions
			F7=Backward
			F12=Cancel

For example, to see more of the data in the **Created** display field (in the bottom righthand part of the Table Details panel), you can perform either of these actions:

- Scroll right by either pressing the Right function key (F11) or entering the RIGHT primary command (ensuring the cursor is positioned within the **Created** field).

The **Created** display field now shows more data:

:		
:	Data capture	: No
:	Created	: 1.40.08.268623 -
:		

Note that the scroll symbol has changed from a “+” to a “-”, indicating that, in this case, you have scrolled to end of the field.

- Press the Expand function key (F4) or enter the EXPAND primary command to display a window that shows the entire contents of the **Created** display field:

Figure 13. Window showing entire contents of display field

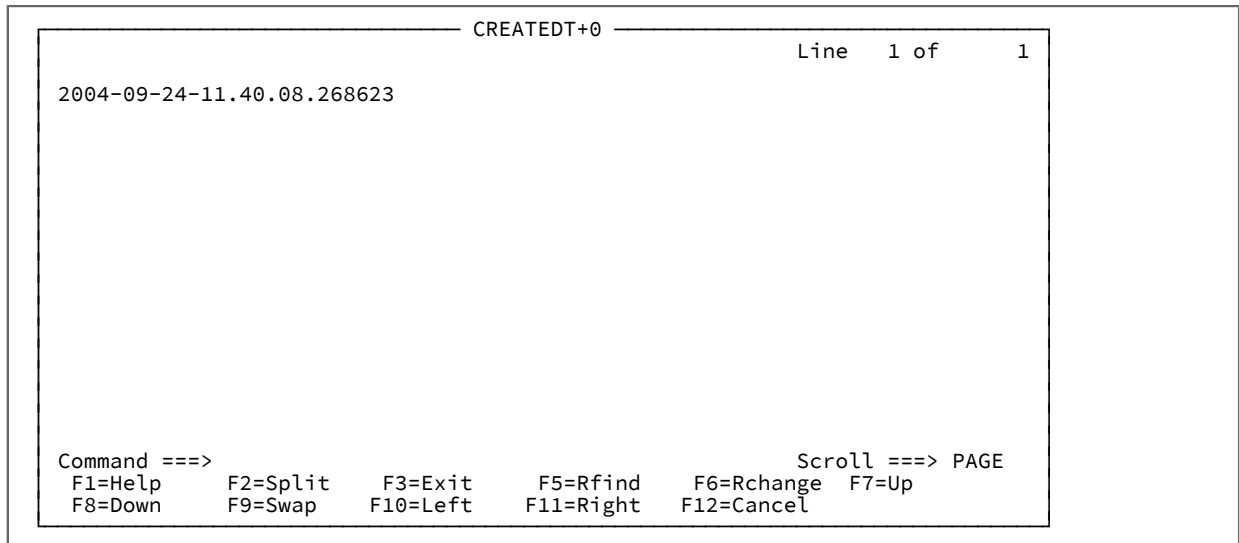

Selecting options on FM/Db2 panels

There are several FM/Db2 panels, such as the Db2® View panel shown in [Figure 14: FM/Db2 panel showing selectable options on page 44](#), where you can select one or more options for the FM/Db2 function you are using.

Figure 14. FM/Db2 panel showing selectable options

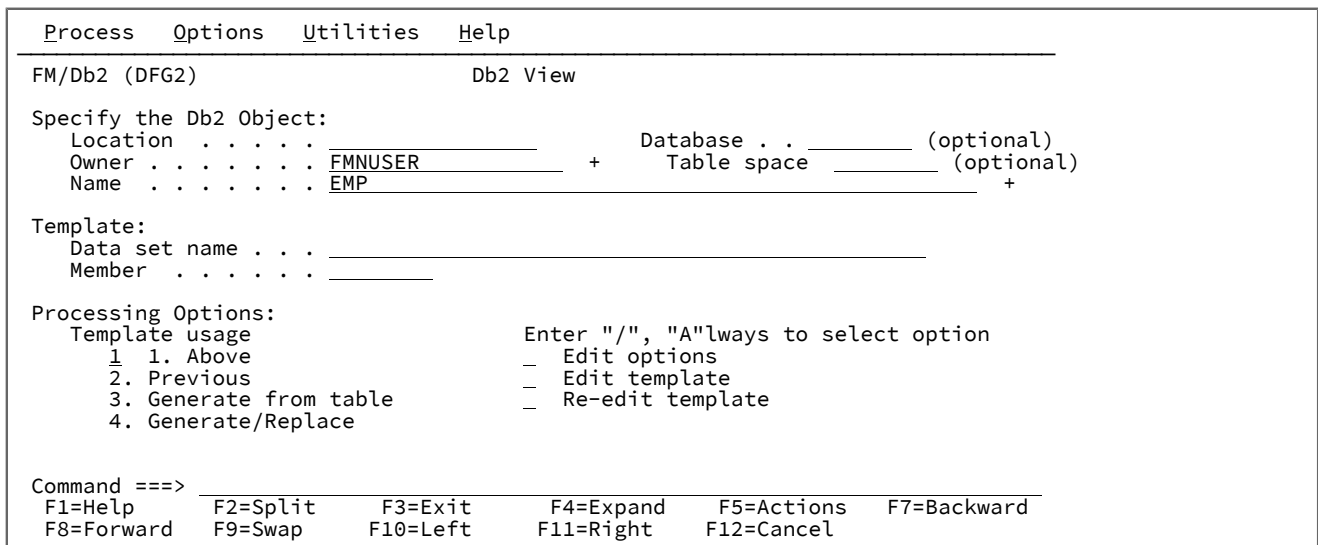

The options on FM/Db2 panels are displayed in two different formats:

- A list of numbered options in the form of a menu.

To select one of these options, type the option number in the entry field provided. For example, in the Db2® View panel shown in [Figure 14: FM/Db2 panel showing selectable options on page 44](#), to select **Previous**, type **2**.

- One or more options that you can select or deselect.

To select one of these options for the current session of the FM/Db2 function only, type a “/” in the entry field provided. To deselect the option, type a space in the entry field.

If the panel shows you can select the option by entering a “/” or an “A” (such as the Db2® View panel):

- To select an option for the current session of the FM/Db2 function only, type a “/”.
- To retain this option as selected from one session of the FM/Db2 function to the next, type an “A”. Use this selection character if you want FM/Db2 to *always* select this option before continuing processing the FM/Db2 function.

For example, if you always want to edit the template before viewing data, select **Edit template** on the Db2® View panel using the selection character “A”.

You must select all the required options before you press Enter.

Related references

[Db2 View panel on page 613](#)

Specifying a Db2® object name

When you use any of the FM/Db2 functions listed below, you specify the name of the Db2® table or view you want to work with in the same way.

- View (option 1)
- Edit (option 2)
- Print (option 3.1)
- Copy (option 3.3)
- Import (option 3.6)
- Export (option 3.7)
- Create (option 3.8)
- Prototyping: Basic (option 4.1)
- Browse (B command on Primary Option Menu panel, or B prefix command against an object in a list of Db2® objects)

[Figure 15: Print utility panel on page 46](#) shows a typical panel containing the entry fields for specifying a Db2® object,

Figure 15. Print utility panel

```

Process  Options  Utilities  Help
-----
FM/Db2 (DFG2)                      Print Utility

Db2 Object:
  1 Location . . . . . _____  4 Database . . _____ (optional)
  2 Owner . . . . . DSN8810      + 5 Table space _____ (optional)
  3 Name . . . . . EMP _____ +

Row count . . . . . ALL _____ Number of rows to print

Db2 Template:
  Data set name . . . _____
  Member . . . . . _____

Processing Options:
  Print Mode      Template usage      Enter "/", "A"lways to select
  1 1. Table      3 1. Above          _ Edit template
  2 2. Single          2. Previous        _ Batch execution
  3. Generate from table _ Use uncommitted read
  4. Generate/Replace _ Print HEX representation

Command ==>
  F1=Help      F2=Split      F3=Exit      F4=Expand      F5=Actions      F7=Backward
  F8=Forward    F9=Swap      F10=Left     F11=Right     F12=Cancel
    
```

The panels for each of the preceding FM/Db2 functions contain the following entry fields, all of which are optional apart from **Name**:

1 Location

The location of the table or view.

If the table or view that you want to work with is at your current location, leave this field blank. Otherwise, type:

- The full name of the remote location
- An asterisk (*) to display all available remote locations, or
- A pattern using wild card characters

If you specify an asterisk on its own or a pattern, FM/Db2 displays a selection list showing the locations that match the input specification. To select the location you want, type **s** against the required entry and press Enter. The location selection list is not available unless access to certain Db2® catalog tables has been granted to FM/Db2 users. When the access is not available, you can still access a remote Db2® system by specifying the exact location name.

When you enter a value in this field, synonym object names are not recognized and are not included in the selection list.

It is also possible to specify the location of a Db2® system using:

- The Db2® subsystem ID
- A location nickname defined for the Db2® system



Note: In what follows, the use of either the Db2® subsystem ID, or a location nickname, is referred to as an *alternative location reference*.

In order to be able to use these alternatives, the systems programmer must have defined the location value and location nickname in the FMN2SSDM macro definition for each Db2® system (FMN2POPT module). You can check whether a location and location nickname have been defined by selecting **About Db2** from the Help pull-down menu.

```

Process  Options  Utilities  Help
-----
FM/Db2 (DFE2)                                Copy Utility

From Db2 Object:
-----
Db2 Connection Information -----
)
+
Db2 Subsystem . . . : DFE2
SQLID . . . . . : PERTHAP
Description . . . . : Db2 Version 12 - Development system
Release . . . . . : 0915
F  FM/Db2 Plan names . : FMN2PLNA
   : FMN2GENA
Attach facility . . : CAF
P  Auditing . . . . . : SAF-RULE CONTROLLED
   Location . . . . . : QXPFMD2DFE2
   Location nickname . : V10DEV
   DECFLOAT Round mode : ROUND Half Even

F1=Help    F2=Split    F3=Exit    F4=Expand    F9=Swap    F12=Cancel

Command ==>
F1=Help    F2=Split    F3=Exit    F4=Expand    F7=Backward  F8=Forward
F9=Swap    F10=Left    F11=Right   F12=CanCommand ==> D2SSCI

```

If a location value has been specified, you can use the Db2® subsystem ID (for example, DFE2) as an alternative to the actual location name. If location and location nickname values have been specified, you can use the location nickname (for example, V9DEV) as an alternative to the actual location name.

You cannot use wildcards when specifying an alternative location reference. When you specify an alternative location reference, the actual location appears in any location reference displayed by FM/Db2; that is, in the Db2® object name shown in a File Manager/Db2 editor session. Similarly, any Db2® object name specified in a Db2® batch job is the actual location name. Specifying an alternative location reference in a File Manager/Db2 batch job is not supported.

You can only access remote locations that have been defined to your local Db2® subsystem.

2 Owner

The authorization ID of the owner of the table, view, or alias.

If you leave this field blank, FM/Db2 uses the current SQL ID. Otherwise, type the full name of the owner, an asterisk (*) to match any owner, or a pattern using wild card characters.

To specify a synonym in the object name field, either leave this field blank, or specify a generic name that includes the current SQLID, or specify the current SQLID. Synonyms are not recognized or included on the table selection list if any of the table space, database, or location fields are non-blank.



Note: Db2® alias names are recognized. Db2® synonyms are not recognized.

3 Name

The name of the Db2® object.

This entry field is mandatory. Type the full name of the Db2® object, an asterisk (*) to display the names of all available objects, or a pattern using wild card characters.

To specify a synonym in this field, type the name of the synonym and ensure that the owner field is either blank, a generic name that includes the current SQLID, or the current SQLID. Synonyms are not recognized or included in the table selection list if any of the table space, database, or location fields are non-blank.

4 Database

The name of the database to which you want to restrict your selection.

Leave this field blank if you do not want to confine the selection to specific databases. Otherwise, type the full name of the database, an asterisk (*) to match any database, or a pattern using wild card characters.

When you enter a value in this field, synonym names are not recognized or included in the selection list.

5 Table space

The name of the table space to which you want to restrict your selection.

Leave this field blank if you do not want to confine the selection to specific table spaces. Otherwise, type the full name of the table space, an asterisk (*) to match any table space, or a pattern using wild card characters.

When you enter a value in this field, synonym names are not recognized or included in the selection list.

If you specify an asterisk (*) or a pattern in one or more of the preceding entry fields (**Owner**, **Name**, **Database**, **Table space**), FM/Db2 displays a selection list showing the Db2® tables and views that match *all* the selection criteria entered in these fields. The selection list may also include synonyms entries under circumstances discussed above.

To select the table, view, or synonym you want, type **s** in the selection column next to the required entry.

For example, say you specified `__DB2` in the **Owner** entry field, `*EMP*` in the **Name** entry field, and `FM*` in the **Database** entry field. FM/Db2 displays a selection list of Db2® tables and views where:

- The name of the owner is five characters long, with "Db2®" as the last three characters,
- The name of the Db2® table or view contains the characters "EMP", and
- The name of the database starts with "FM".

To select, say, the view VEMP, type **s** in the selection column next to that entry.

Related tasks

[Using an asterisk \(*\) or a pattern in entry fields on page 49](#)

Related references

[Table/View/Alias Selection panel on page 842](#)

[Db2 Location Selection panel on page 603](#)

Using an asterisk (*) or a pattern in entry fields

For entry fields on FM/Db2 panels where you can enter an asterisk (*) or wildcards, you can use:

- An asterisk (*) on its own to match all values, or
- A pattern using wildcard characters to select all objects that match the pattern.

In either case, FM/Db2 displays a selection list. To select the listed item you want, type **s** against the required entry and press Enter.

You can specify a pattern using the following characters:

asterisk (*) in combination with one or more other wildcard characters

Represents a string of zero or more characters. Acts the same as a percent sign (%).

percent sign (%)

Represents a string of zero or more characters. Acts the same as an asterisk (*).

underscore (_)

Represents any single character, including a trailing blank.

Other characters

Any other characters that are valid for the entry field.

The following examples show how various patterns work if used to select entries from the following list:

- AGE
- AGREE
- GUM
- IGLOO
- MAN
- MANE
- MANY
- MANAGE
- MANAGES

Pattern

Entries selected

AGE

AGE, MANAGE, and MANAGES

MAN_

MAN, MANE, and MANY

MANAGE%

MANAGE and MANAGES

_G*

AGE, AGREE, and IGLOO

%G__

AGE, MANAGE, and MANAGES

Specifying the SQLID

You can specify the SQLID to be used as part of the connection to Db2® by typing the required value in the **SQL ID** field on the FM/Db2 Primary Option Menu panel. The default is your TSO logonid.

You cannot change the SQLID value until FM/Db2 is successfully connected to a Db2® system.

You require authorization to change the SQLID value to something other than your TSO logonid. See your Db2® systems administrator if you require this capability.

You can also change the SQLID value dynamically by using the SQLID primary command.

You can determine the current value for the SQLID by selecting "About Db2®" from the Help pull-down menu.

Related references

[Primary Option Menu panel on page 728](#)

[SQLID primary command on page 943](#)

Specifying a data set and a member name

Some FM/Db2 panels require you to specify the data set that you wish to use for the current process. If the data set is a PDS, a CA-Panvalet library, or a library accessed using the Library Management System Exit, you also must enter the member name. These panels are collectively referred to as Entry panels.

To specify your data set on any entry panel:

1. In the **Data set name** field, enter a fully-qualified data set name or a name pattern. The name may include a member name or name pattern in parenthesis. If the member is specified here, the associated Member field must be empty.



Note: In the case of a copybook, this can be the name of a CA-Panvalet library or the name of a library accessed using the Library Management System Exit.

If you do not enclose the data set name in quotation marks, then the TSO prefix for your user ID is used as the high-level qualifier.

If you enter a pattern, when the Entry panel is processed FM/Db2 displays a list of the data sets that match the pattern.

Patterns can contain a percent sign (%) to represent a single character, and an asterisk (*) to represent any number of characters within one qualifier. Two asterisks (**) represent any number of characters within any number of qualifiers.

For performance reasons, you should qualify the data set name as much as you can.

2. If you specified the name of a partitioned data set (PDS), the name of a CA-Panvalet library, or the name of a library accessed using the Library Management System Exit, in the **Data set name** field (without including a member name or name pattern in parenthesis), then enter a name or name pattern in the **Member** field.

A member name pattern can consist of any characters that are valid in a member name and the following two special pattern characters:

asterisk (*)

Represents any number of characters. As many asterisks as required can appear anywhere in a member name. For example, if you enter *d*, a list of all members in the data set whose name contains "d" is displayed.

percent sign (%)

A place-holding character representing a single character. As many percent symbols as necessary may appear anywhere in a member name. For example, if you enter %%%%, a list of all members in the data set whose name is four characters in length is displayed.

If you perform either of these actions:

- Do not include a member name or name pattern in parenthesis in the **Data set name field**, and leave the **Member** field blank, or you specify a pattern in the **Member** field,
- Include a member name pattern in parenthesis in the **Data set name field**, and leave the **Member** field blank,

FM/Db2 displays a member name list when the Entry panel is processed and the data set has been specified or selected.

3. For data sets that have not been catalogued, enter the serial number of the volume which contains the data set in the **Volume serial** field.
4. Complete the remaining panel-specific fields, and then press Enter to process the panel function.

If both the data set name and the member name have been fully specified, the panel action will proceed to its next stage.

If you entered a pattern for the data set name or member name, the Data Set Selection panel is displayed, followed by the Member Selection panel, as needed. When you have made your selections from these panels, the Entry panel action will proceed to its next stage.

5. When the Data Set Selection panel is displayed, select your data set by entering an s in the **Sel** field adjacent to the required data set. You can only select one name from this list.

- When the Member Selection panel is displayed, select your members by typing an **s** in the **Sel** field next to each member, and then pressing Enter.

You can select as many names as required from this list. When the panel is processed, the first member on the list is used in the relevant function. When the function is completed, the next member in list is used. For example, if you are selecting several members to be edited, the first member is displayed in the Edit Session panel. When you exit this panel, the next member is displayed, and so on, until all selected members have been processed.

Examples of data set name patterns

The examples below assume that the following data sets exist under the USERID high-level qualifier:

```
USERID.FMN.DATA
USERID.FMN.TEMPLATES
USERID.COBOL.COPY
USERID.COBOL.SOURCE
USERID.PLI.COPY
USERID.PLI.SOURCE
USERID.MISC.DATA.BACKUP
USERID.WORK
```

Example 1

Entering the following pattern (with a single asterisk):

```
'USERID.*'
```

displays the only item with exactly one level of qualifier after USERID:

```
USERID.WORK
```

Example 2

Entering the following pattern (with two asterisks):

```
'USERID.**'
```

displays the complete list of data sets with the USERID high-level qualifier.

Example 3

Entering the following pattern:

```
'USERID.*.%%%'
```

displays the following list (containing those data sets with exactly three qualifiers, whose third-level qualifier contains exactly four characters):

```
USERID.FMN.DATA
USERID.COBOL.COPY
USERID.PLI.COPY
```

Examples of specifying a member name or pattern

The examples below assume that the following members exist within the data set named, FMNUSER.DATA:

```

DATA1
FMNCDATA
FMNCTAM
FMNCTEM
FMNCTMP
NEWDATA
NEWSTUFF
TEMPA
TEMPB

```

Example 1

Entering the following details on an Entry panel:

```

:
: Data set name . . . . . FMUSER.DATA
: Member . . . . . -----
:

```

displays the entire member name list:

```

DATA1
FMNCDATA
FMNCTAM
FMNCTEM
FMNCTMP
NEWDATA
NEWSTUFF
TEMPA
TEMPB

```

Example 2

Entering the following details on an Entry panel:

```

:
: Data set name . . . . . FMUSER.DATA
: Member . . . . . FMNCT*
:

```

displays the member name list:

```

FMNCTAM
FMNCTEM
FMNCTMP

```

Example 3

Entering the following details on an Entry panel:

```

:
: Data set name . . . . . FMUSER.DATA(NEWDATA)
: Member . . . . .
:

```

displays details for the member NEWDATA in data set FMUSER.DATA.

Example 4

Entering the following details on an Entry panel:

```
:  
Data set name . . . . . FMNUSER.DATA(TEM*)  
Member . . . . . _____  
:
```

displays the member name list:

```
TEMPA  
TEMPB
```

Example 5

Entering the following details on an Entry panel:

```
:  
Data set name . . . . . FMNUSER.DATA(*)  
Member . . . . . _____  
:
```

displays the entire member name list:

```
DATA1  
FMNCDATA  
FMNCTAM  
FMNCTEM  
FMNCTMP  
NEWDATA  
NEWSTUFF  
TEMPA  
TEMPB
```

Related references

- [Copy Utility \("From"\) panel on page 498](#)
- [Copy Utility \("To"\) panel on page 506](#)
- [Data Create Utility panel on page 587](#)
- [Db2 View panel on page 613](#)
- [Db2 Browse panel on page 595](#)
- [Db2 Edit panel on page 598](#)
- [Export Utility \("To"\) panel on page 676](#)
- [Export Utility \("From"\) panel on page 673](#)
- [Import Utility \("To"\) panel on page 694](#)
- [Import Utility \("From"\) panel on page 693](#)
- [LOAD from panel on page 704](#)
- [LOAD Utility - Using Templates panel on page 708](#)
- [UNLOAD Utility \(Tables\) "To" panel on page 861](#)
- [Print Utility panel on page 733](#)

Canceling long-running Db2® queries

On occasions, when you are working with very large amounts of Db2® data, you may experience long response times associated with the FM/Db2 query that FM/Db2 is processing.

When you are using one of the following FM/Db2 utilities, you can use the *attention interrupt key* to cancel the query.

- View
- Browse
- Edit
- Print
- Copy
- Import
- Export
- Create
- SQL

Pressing the attention interrupt key when Db2® is processing cancels the current Db2® function. Any uncommitted changes made since the start of the unit of work are lost.

Getting help

FM/Db2 offers two levels of help information: Tutorial Help and, for input fields (and some output fields), field-level help information. Tutorial Help is a context-sensitive help system that provides detailed explanations of the FM/Db2 panels and the processes in which they are used. The field-level help information provides a description of the current field. In addition, all error messages have an associated full text explanation, which can help you to determine the cause of a problem.

This section explains how to find the help information that you need.

Related tasks

[Accessing Tutorial Help on page 55](#)

[Displaying field-level help information on page 58](#)

[Displaying the expanded form of error messages on page 58](#)

Accessing Tutorial Help

The Tutorial Help system is both context-sensitive and structurally organised. You can get directly to the information you need, using the context-sensitive access method or you can enter the Help system at a specific location and navigate to any topic information within the structure.

To access a context-sensitive Tutorial Help page:

1. Place your cursor on the Command Line or anywhere in the panel that is outside of a field entry line.
2. Press the Help function key (F1). The Tutorial Help page associated with the current panel is displayed.

When you access the Tutorial Help in this way, the first page that is displayed may be a main topic page, with a menu listing the associated sub-topics, or it may be a sub-topic page, depending upon the context from which you started.

3. Navigate through the Tutorial Help pages, to find the information you require (see below for a list of navigation commands).
4. When you have finished, press the Exit function key (F3) to return to your starting panel.

The Tutorial Help system is organised with a Table of Contents structure that is based upon the FM/Db2 Primary Options menu. Each entry within the Table of Contents leads to a main topic with a number of associated sub-topics. In addition, there is an index that lists selected topics from the Tutorial Help, alphabetically by subject.

To choose your starting point in Tutorial Help:

1. Select the Help pull-down menu from a panel Action Bar.
2. Enter the option number for the Tutorial Help entry point that you require. These are:

1. Help for help

Displays the Help panel for the Tutorial Help system.

2. Extended help

Displays the Tutorial Help panel associated with the current FM/Db2 panel (equivalent to pressing F1 from the FM/Db2 panel). When on the Primary Options menu, this is the Tutorial Help Table of Contents panel.

3. Keys help

Displays a panel that provides help for the Function Keys that are active on the current FM/Db2 panel.

4. Help index A-M

Displays the Help Index for subjects starting with "A" to "M".

5. Help index N-Z

Displays the Help Index for subjects starting with "N" to "Z".

6. Tutorial

Displays the Tutorial Help Table of Contents panel.

7. About

Displays the FM/Db2 version, PTF level, and copyright information in a window.

8. About Db2®

Displays the Db2® subsystem, Db2® version and release information, FM/Db2 plan names, and audit options in a window.



Note: For more information about audit options, see [SAF-rule controlled auditing on page 69](#).

9. News about FM/Db2

Displays a panels providing general information about the current FM/Db2 version/release.

To navigate Tutorial Help, enter one of the following commands in the Command line on any Tutorial page:

BACK or B

To back up to the previously viewed page.

SKIP or S

To skip the current topic and go on to the next topic.

UP or U

To display a higher level list of topics.

TOC or T

To display the Table of Contents.

INDEX or I

To display the Tutorial Index. Once the Index has been displayed, use the Right function key (F11) and the Left function key (F10) to scroll through the list, then position your cursor on a subject and press Enter to display the topic.

Alternatively, you may use the following keys whenever you are in the tutorial:

Enter (Ctrl)

To display the next sequential page within a topic.

Help (F1)

To display the Help Tutorial page within the Tutorial Help system (that is, the page that describes how to use Tutorial Help).

End (F3)

To terminate the tutorial.

Up (F7)

To display a higher level list of topics (instead of typing UP).

Down (F8)

To skip to the next topic (instead of typing SKIP).

Right (F11)

To display the next sequential page within a topic (instead of pressing Enter).

Left (F10)

To display the previous sequential page within a topic (instead of typing BACK).



Note: The listed keys are the default key mappings. As you can customize key mappings, they may be different on your system.

Related references

[Primary Option Menu panel on page 728](#)

Displaying field-level help information

To display the field-level help information for a field on a File Manager/Db2 panel:

1. Place your cursor on the field entry line.
2. Press the Help function key (F1). The field-level help information is displayed in a pop-up window.

If further information is needed, press the Extended Help function key (F5) to access the Tutorial Help page for the current panel.

Pressing Help while the field information window is displayed takes you to the Help Tutorial page within the Tutorial Help system (that is, the page that describes how to use Tutorial Help).

3. When you have finished reading the message or the relevant Tutorial Help page, press the Exit function key (F3) to return to your starting panel.

For example, [Figure 16: Field-level help information for the PAGESIZE field on page 58](#) shows the message seen when F1 is pressed from the PAGESIZE field in the Set Print Processing Options panel.

Figure 16. Field-level help information for the PAGESIZE field

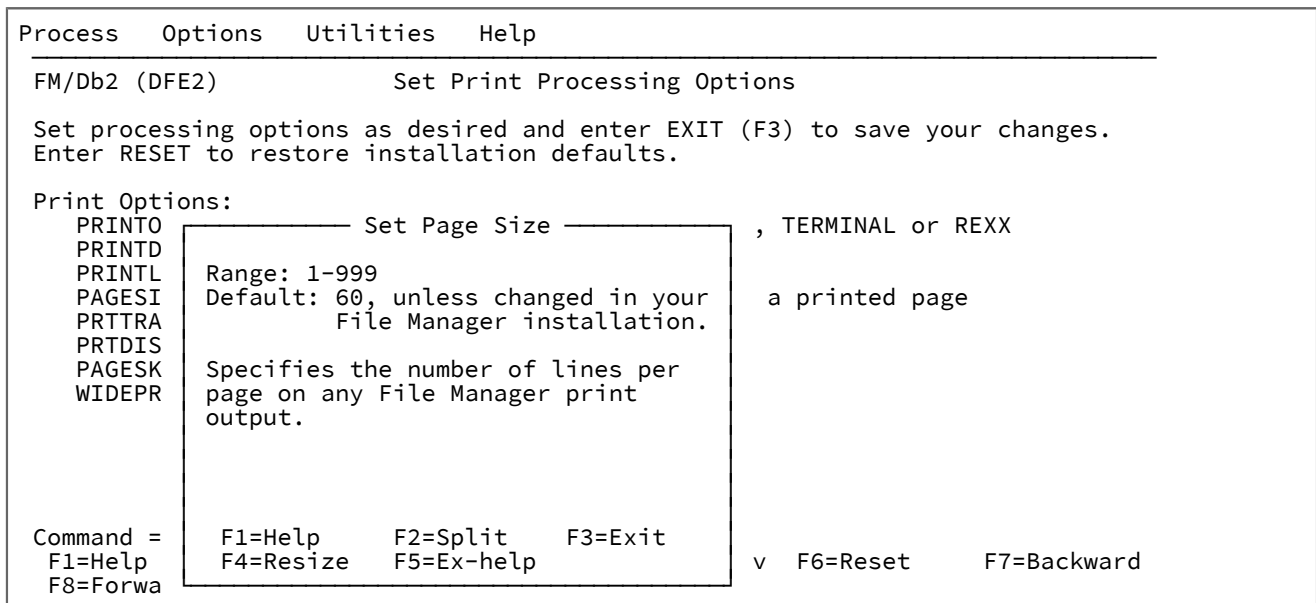

Displaying the expanded form of error messages

If an error occurs when FM/Db2 attempts to process a panel, a short text message displays in the upper right corner of the screen. [Figure 17: Db2 View showing short text message on page 59](#) shows an example where FM/Db2 cannot find the Db2® object specified.

Figure 17. Db2® View showing short text message

Process	Options	Utilities	Help
FM/Db2 (DFE2)		Db2 View	Object not found (DFE2)
Specify the Db2 Object:			
Location	_____	Database . . _____	(optional)
Owner	DSN8910	Table space _____	(optional)
Name	EMPX		+
Row count	ALL		
Template:			
Data set name . . .	'FMNUSER.FMSKELS'		
Member	_____		
Processing Options:			
Template usage		Enter "/", "A"lways to select option	
3 1. Above		- Edit options	
2. Previous		- Edit template	
3. Generate from table		- Re-edit template	
4. Generate/Replace			
Command ==>			
F1=Help	F2=Split	F3=Exit	F4=Expand
F9=Swap	F10=Left	F11=Right	F12=Cancel
		F7=Backward	F8=Forward

While this message is displayed, pressing the Help function key (F1) displays the expanded text of the error message at the bottom of the screen as shown in [Figure 18: Db2 View showing expanded message on page 59](#).

Figure 18. Db2® View showing expanded message

Process	Options	Utilities	Help
FM/Db2 (DFE2)		Db2 View	Object not found (DFE2)
Specify the Db2 Object:			
Location	_____	Database . . _____	(optional)
Owner	DSN8910	Table space _____	(optional)
Name	EMPX		+
Row count	ALL		
Template:			
Data set name . . .	'FMNUSER.FMSKELS'		
Member	_____		
Processing Options:			
Template usage		Enter "/", "A"lways to select option	
No Db2 object matches the combination of object details entered in Db2 system DFE2. Press Help for more information.			
Command ==>			
F1=Help	F2=Split	F3=Exit	F4=Expand
F9=Swap	F10=Left	F11=Right	F12=Cancel
		F7=Backward	F8=Forward

Some messages, like the one shown in [Figure 18: Db2 View showing expanded message on page 59](#) have "Press Help for more information." in the text of the long message. In this case, you can press the Help function key (F1) (again) when the long message is displayed to show a help panel with additional information like that shown in [Figure 19: Help panel displaying additional information relating to a long error message on page 60](#).

Figure 19. Help panel displaying additional information relating to a long error message

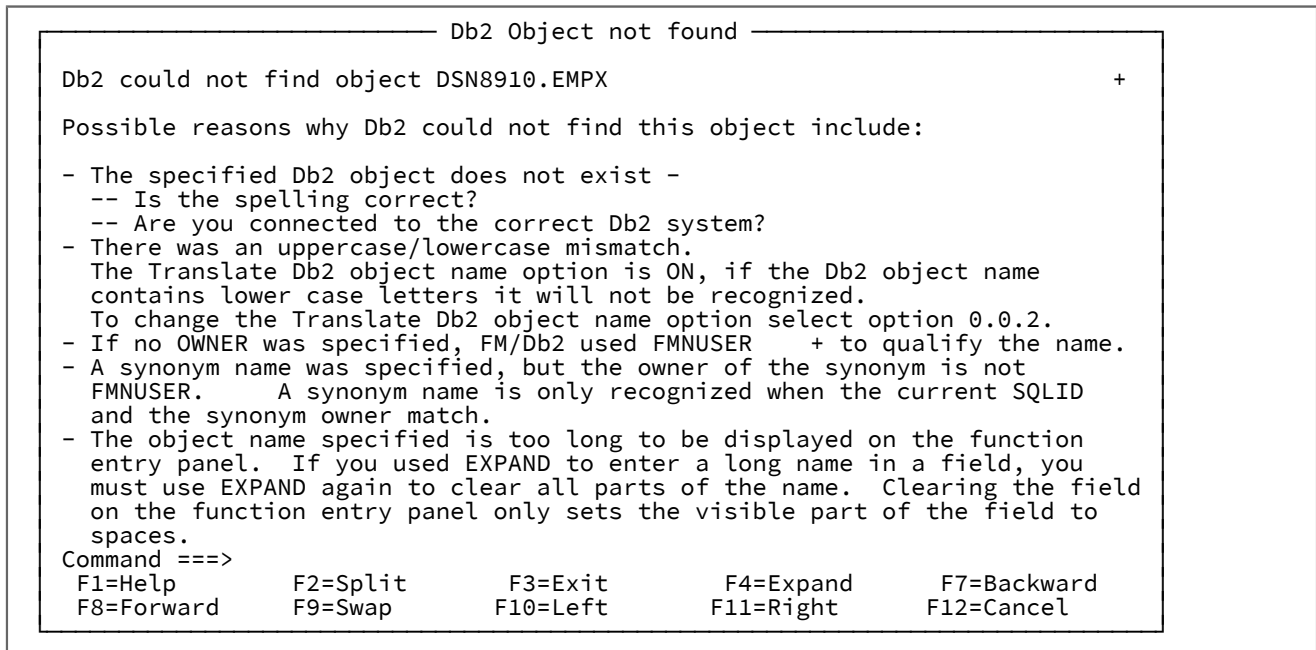

Setting default processing options

Many of the processing operations performed by File Manager use default values that can be set from within the FM/Db2 application. By adjusting these values, you can customize FM/Db2 so that its behavior is best suited to your needs.

When you first use FM/Db2, you will probably find that the default values for processing options (as set at the time of installation) are sufficient. As you become more familiar with working with FM/Db2, you may choose to change some of these options to better suit your needs.

You can update these default values by accessing the relevant processing option panel (for example, the FM/Db2 System Options panel, Editor Options panels, and so on). Changes are saved in your ISPF user profile for future FM/Db2 sessions. They remain in effect until you change the option again.

To access a processing option panel, use either of the following methods:

- From the FM/Db2 Primary Option Menu panel:
 - Select Option 0 (Settings). The Set Processing Options panel is displayed.

Figure 20. Set Processing Options menu

```

Process   Options   Utilities   Help
-----
FM/Db2 (DFG2)           Set Processing Options

0 System           System options
1 View            View options
2 Edit            Edit options
3 Utilities
  3.3 Copy         Copy utility options
  3.4 Object List  Object list utility options
  3.7 Export       Export utility options
  3.L Load        Db2 LOAD utility options
  3.U LISTDEF     Db2 Utility LISTDEF options
  3.UO OPTIONS    Db2 Utility OPTIONS options
  3.UT TEMPLATE   Db2 Utility TEMPLATE options
  3.UU Unload     Db2 Unload utility options

Command ==>
F1=Help    F2=Split    F3=Exit    F7=Backward F8=Forward  F9=Swap
F12=Cancel

```

- Select the required processing options type from the menu.

For example, to display the current FM/Db2 system options, enter `0.2` on the command line and press Enter to display the FM/Db2 System Options (1 of 3) panel.



Note: You can navigate directly to the options panel you want by entering the path as shown on the Set Processing Options panel (such as `0.2`, `3.7`, and so on). Alternatively, for the system and utility options, you can enter `0` or `3` to first display the Set System Processing Options or Set Utility Processing Options panels respectively from which can then select the option you want.

- From any FM/Db2 panel, use the **Options** pull-down menu to select the required processing options type:

Figure 21. Options pull-down menu

```

FM/Db2 (
0 Setti
1 View
2 Edit
3 Utili
4 SQL
5 Db2I
6 Comma
X Exit

  1. Print settings
  2. FM/Db2 system options
  3. Job card specifications
  4. Compiler language selection
  5. COBOL compiler specifications
  6. HLASM compiler specifications
  7. PL/I compiler specifications
  8. Temporary Data Set Allocations
  9. Output Data Set Allocations
 10. ISPF settings
 11. Editor options
 12. Copy utility options
 13. Object list utility options
 14. Export utility options
 15. Db2 LOAD utility options
 16. Db2 Utility LISTDEF options
 17. Db2 Utility OPTIONS options
 18. Db2 Utility TEMPLATE options
 19. Db2 Unload utility options

User ID . : FMUSER
System ID : FMD2
Appl ID . : FMN2
Version . : 15.1.6
Terminal . : 3278
Screen . . : 1
Date . . . : 2018/11/04
Time . . . : 14:54

Db2 SSID . DFE2
SQL ID . . FMUSER +

Command ==>
F1=Help    F2=Split    F3=Exit    F7=Backward F8=Forward  F9=Swap
F12=Cancel

```

When you select an option processing type, File Manager displays a panel listing those options and their current values. The following notes apply to all of these option panels:

- To change the value of an option, overwrite its current value.
- To save the options you have changed and exit the panel, press the Exit function key (F3).
- To exit a panel without saving changes, press the Cancel function key (F12).
- The options on these panels only affect the behavior of FM/Db2 panels.

Related tasks

[Selecting an item from the action bar on page 38](#)

Related references

[Set Processing Options panel on page 795](#)

[Set System Processing Options panel on page 797](#)

[Set Utility Options panel on page 803](#)

System Options (option 0)

System options displays the Set System Processing Options panel from which you can select and display subsequent system options panels.

Related references

[Set System Processing Options panel on page 797](#)

[Set Print Processing Options panel on page 792](#)

[Systems Options \(1 of 4\) panel on page 817](#)

[Set Batch Job Card Information panel on page 784](#)

[Compiler Language Selection panel on page 493](#)

[Set COBOL Processing Options panel on page 785](#)

[Set PL/I Processing Options panel on page 790](#)

[Set Temporary Data Set Allocation Options panel on page 800](#)

[Set Output Data Set Allocation Options panel on page 789](#)

[Set Trace options panel on page 801](#)

[ISPF Settings panel on page 700](#)

Print settings (option 0.1)

The Print settings options control such things as the destination of your print output and the page format to use.

Related tasks

[Printing the contents of a Db2 table on page 321](#)

Related references

[Set Print Processing Options panel on page 792](#)

FM/Db2 system options (option 0.2)

The FM/Db2 system options control such things as the translation of Db2® object names and input SQL statements to uppercase, the use of double quotation marks for SQL identifiers, and the external format for TIME columns.

Related references

[Systems Options \(1 of 4\) panel on page 817](#)

[Systems Options \(2 of 4\) panel on page 819](#)

[Systems Options \(3 of 4\) panel on page 821](#)

Job card specifications (option 0.3)

On the Set Batch Job Card Information panel, you can specify batch job card information to be used for generating batch job submission JCL. The Batch Job Card Information panel provides a number of blank lines (**Batch Submission Job Statement Information**) where you can enter this information.

FM/Db2 assumes any non-blank lines define a JCL job card and copies the information from these lines into generated JCL. If all the lines are blank, the JCL generation process generates a basic job card using information from system variables.

Related references

[Set Batch Job Card Information panel on page 784](#)

Compiler language selection (option 0.4)

The Compiler language selection options allow you to select which compiler is used to generate templates from the COBOL or PL/I copybook for FM/Db2 import and export utilities.

Related tasks

[How FM/Db2 compiles a copybook into a template on page 77](#)

[Copying data from a VSAM or QSAM file on page 246](#)

[Copying data to a VSAM or QSAM file on page 274](#)

Related references

[Compiler Language Selection panel on page 493](#)

COBOL compiler specifications (option 0.5)

The COBOL compiler specifications control various options used by the COBOL compiler to generate templates from COBOL copybooks used by the FM/Db2 import and export utilities.

Related tasks

[How FM/Db2 compiles a copybook into a template on page 77](#)

[Copying data from a VSAM or QSAM file on page 246](#)

[Copying data to a VSAM or QSAM file on page 274](#)

Related references

[Set COBOL Processing Options panel on page 785](#)

HLASM compiler specifications (option 0.6)

The HLASM compiler specifications control various options used by the HLASM compiler to generate templates from HLASM copybooks used by the FM/Db2 import and export utilities.

Related tasks

[How FM/Db2 compiles a copybook into a template on page 77](#)

[Copying data from a VSAM or QSAM file on page 246](#)

[Copying data to a VSAM or QSAM file on page 274](#)

Related references

[Set HLASM Processing Options panel on page 787](#)

PL/I compiler specifications (option 0.7)

The PL/I compiler specifications control various options used by the PL/I compiler to generate templates from PL/I copybooks used by the FM/Db2 import and export utilities.

Related tasks

[How FM/Db2 compiles a copybook into a template on page 77](#)

[Copying data from a VSAM or QSAM file on page 246](#)

[Copying data to a VSAM or QSAM file on page 274](#)

Related references

[Set PL/I Processing Options panel on page 790](#)

Temporary Data Set Allocations (option 0.8)

The temporary data set allocations allow you to specify UNIT, DATA CLASS, STORAGE CLASS, and MANAGEMENT CLASS names for the allocation of a temporary data set.

Related references

[Set Temporary Data Set Allocation Options panel on page 800](#)

Output Data Set Allocations (option 0.9)

The output data set allocations allow you to specify UNIT, DATA CLASS, STORAGE CLASS, and MANAGEMENT CLASS names for the allocation of an output data set.

Related references

[Set Output Data Set Allocation Options panel on page 789](#)

Trace options (option 0.10)

The Trace options displays the Set Trace options panel.

Related references

[Set Trace options panel on page 801](#)

ISPF settings (option 0.11)

The ISPF settings option displays the ISPF Settings panel.

Related references

[ISPF Settings panel on page 700](#)

View and Edit options (options 1 and 2)

The View and Edit options (both these options lead you to the first of the Editor Options panels) control various options used to format the display of data when viewing or editing.



Note: If you are viewing or editing data, and you use the **Options** pull-down menu to change these options, then your changes do not take effect until your next FM/Db2 editor session. To temporarily change the behavior for the current FM/Db2 editor session only, use the **Edit options** option on the Db2® View or Db2® Edit panels.

Related tasks

[Viewing and changing Db2 data on page 119](#)

[Setting options for the current FM/Db2 editor session on page 123](#)

Related references

[Editor Options \(1 of 8\) panel on page 625](#)

Utilities (option 3)

Utilities displays the Set Utility Processing Options panel from which you can select and display subsequent utility options panels.

Related references

- [Set Utility Options panel on page 803](#)
- [Copy Options panel on page 495](#)
- [Export Options \(1 of 3\) panel on page 665](#)
- [LOAD Utility Options panel on page 710](#)
- [LISTDEF Options panel on page 702](#)
- [OPTIONS Options panel on page 721](#)
- [TEMPLATE Options \(1 of 2\) panel on page 846](#)
- [UNLOAD Options panel on page 854](#)

Print utility options (option 3.1)

The Print utility options control such things as print mode (table or single, null column indicator character, batch execution, uncommitted read, and hexadecimal representation).

Related tasks

- [Printing the contents of a Db2 table on page 321](#)

Related references

- [Print Utility Options panel on page 731](#)

Copy utility options (option 3.3)

The Copy utility options control such things as concurrency, table locking, and duplicate key processing when copying data between Db2® tables.

Related tasks

- [Copying data from one Db2 object to another on page 241](#)

Related references

- [Copy Options panel on page 495](#)

Object List Options (option 3.4)

The object list utility options affect the behavior of catalog table displays produced in the following utility functions:

- Object List utility (3.4)
- Manage Db2® Privileges (3.5)
- Explain Utilities (4.5)

Related references

[Object List Options \(1 of 2\) panel on page 714](#)

[Object List Options \(2 of 2\) panel on page 717](#)

Export utility options (option 3.7)

The Export utility options allow you to tailor the way in which the Export utility operates.

Related tasks

[Copying data to a VSAM or QSAM file on page 274](#)

Related references

[Export Options \(1 of 3\) panel on page 665](#)

[Export Options \(2 of 3\) panel on page 667](#)

[Export Options \(3 of 3\) panel on page 671](#)

Db2® LOAD utility options (option 3.L)

The Load utility options control the way in which FM/Db2 generates JCL for the Db2® LOAD utility.

Related tasks

[LOAD utility on page 349](#)

Related references

[LOAD Utility Options panel on page 710](#)

Db2® Utility LISTDEF options (option 3.UL)

The Listdef utility options displays the LISTDEF Options panel.

Related tasks

[Setting options for Db2 utilities on page 341](#)

Related references

[LISTDEF Options panel on page 702](#)

Db2® Utility OPTIONS options (option 3.UO)

The Option utility options displays the OPTIONS Options panel.

Related tasks

[Setting options for Db2 utilities on page 341](#)

Related references

[OPTIONS Options panel on page 721](#)

Db2® Utility TEMPLATE options (option 3.UT)

The Template utility options displays the TEMPLATE Options panel.

Related tasks

[Setting options for Db2 utilities on page 341](#)

Related references

[TEMPLATE Options \(1 of 2\) panel on page 846](#)

[TEMPLATE Options \(2 of 2\) panel on page 848](#)

Db2® Unload utility options (option 3.UU)

The Unload utility options displays the Unload Options panel.

The Unload Utility options apply when you use the LOAD utility in Utilities (3.9) to transfer data.

Related tasks

[Setting options for Db2 utilities on page 341](#)

[UNLOAD utility on page 372](#)

Related references

[UNLOAD Options panel on page 854](#)

Displaying or editing DBCS characters

If you want to display or edit DBCS characters in FM/Db2 and you have a DBCS capable terminal, you must ensure that your ISPF settings specify a terminal type that supports these characters.

To specify the Terminal Type in ISPF:

1. Exit from FM/Db2 and return to the z/OS® Primary Options Menu panel.

Although you can change the ISPF Terminal Type setting while FM/Db2 is running, the change will not be reflected until the next time that FM/Db2 is invoked.

2. Select option 0. `Settings`. The ISPF Settings panel is displayed.

Figure 22. ISPF Settings panel

```

Log/List  Function keys  Colors  Environ  Workstation  Identifier  Help
-----
                                ISPF Settings
                                Command delimiter . ;   More:  -
- Session Manager mode
/ Jump from leader dots
- Edit PRINTDS Command
/ Always show split line
- Enable EURO sign

Terminal Characteristics
Screen format  1  1. Data    2. Std    3. Max    4. Part

Terminal Type  3
               1. 3277      2. 3277A  3. 3278   4. 3278A
               5. 3290A     6. 3278T  7. 3278CF 8. 3277KN
               9. 3278KN   10. 3278AR 11. 3278CY 12. 3278HN
               13. 3278H0   14. 3278IS 15. 3278L2 16. BE163
               17. BE190   18. 3278TH 19. 3278CU 20. DEU78
               21. DEU78A  22. DEU90A 23. SW116  24. SW131
               25. SW500

Command ==>  -----
F1=Help      F2=Split   F3=Exit    F7=Backward F8=Forward  F9=Swap
F10=Actions  F12=Cancel

```

3. Select either 3277KN or 3278KN from the list of Terminal Types. (You may need to scroll down this panel to find the list of Terminal Types.)
4. Press Exit (F3) to save your selection and return to the z/OS® Primary Options Menu panel.
5. Restart FM/Db2.

Related tasks

[Starting FM/Db2 on page 26](#)

[Exiting from FM/Db2 on page 29](#)

SAF-rule controlled auditing

The way in which auditing is performed during a File Manager/Db2 session may be determined by SAF rules, depending on the auditing requirement of your installation.

Determining when SAF-rule controlled auditing is in effect

You can determine if SAF-rule controlled auditing is in effect by selecting "**About Db2®**" on the Help pull-down menu:

- When SAF-rule controlled auditing is effect, the **Auditing** line of the "About Db2®" pop-up panel shows "SAF-RULE CONTROLLED".
- When SAF-rule controlled auditing is active and no auditing is to occur, the message indicates that auditing is prohibited.
- When SAF-rule controlled auditing is active and auditing might occur, the message states only that SAF-rule controlled auditing is active.



Note: The final decision as to whether to audit or not depends on the FM/Db2 function and the appropriate SAF XFACILIT rules defined for the Db2® object names, SQL statements, or Db2® commands that are accessed by the FM/Db2 function.

SAF rules for auditing

When auditing is determined by SAF rules:

- Auditing can be specified independently for each Db2® system accessed by FM/Db2, to either your audit log data set, to SMF, or to both destinations.
- All FM/Db2 functions that allow the execution of SQL statements are subject to audit, with the exception of SQL statements used to access the Db2® catalog tables for the internal processes of FM/Db2.
- SAF rules control if and where the **Create audit trail (*)** option is displayed on FM/Db2 panels. "(*)" is appended to the **Create audit trail** option to show auditing is under SAF control.

For select statements applying to a Db2® object, SAF rules can be specified at a Db2® object name level allowing audit for READ, UPDATE, or both types of operations. An UPDATE operation includes any SQL statement that changes Db2® data such as INSERT, DELETE, and UPDATE.

SAF-rule controlled auditing not in effect

When SAF-rule controlled auditing is *not* in effect (that is, auditing is controlled by the settings in FMN2POPT), the **Create audit trail** option is displayed on the first *global* editor options panel. The value shown reflects the current behaviour. When you display the first *local* editor options panel, the **Create audit trail** option is not displayed since it appears on the editor function entry panel.

SAF-rule controlled auditing in effect, no auditing

When SAF-rule controlled auditing *is* in effect, and *no* auditing is to occur for the Db2® system, the **Create audit trail (*)** option is not displayed on either the editor function entry panel, or on the first editor options panel.

SAF-rule controlled auditing in effect, auditing possible

When SAF-rule controlled auditing *is* in effect, and auditing *is* to occur for the Db2® system, the actual decision on whether or not to create an audit log depends on the Db2® object name being processed.

Therefore, when you press Enter on the editor function entry panel, a check is made to see if auditing should occur for the current editor type (browse or edit) and the Db2® object name.

If the **Create audit trail (*)** option is set appropriately (that is, it matches the auditing requirement as specified in the relevant SAF rule), processing continues, the data is displayed, and audit records are written, or not, depending on the option selection.

If you have not selected the **Create audit trail (*)** option and auditing is required, the function entry panel is re-displayed with a message to indicate that auditing is required. You will not be able to process the object until the audit option is selected.

If you have selected the **Create audit trail (*)** option and auditing is not required, the function entry panel is re-displayed with a message to indicate that auditing is not required. You will not be able to process the object until the audit option is unselected.

Note that both the previous scenarios assume that you do not have audit control access for the Db2® object in question. If you do have control level audit access for the Db2® object, the current value of the **Create audit trail (*)** option determines whether or not audit records are written.

Related references

[Editor Options \(1 of 8\) panel on page 625](#)

[Db2 Edit panel on page 598](#)

[Db2 View panel on page 613](#)

Chapter 4. Working with templates

FM/Db2 uses *templates* to provide a formatted view of your data, enabling you to view, edit, and manipulate data according to the columns and data types in the table you are working with.

Initially, FM/Db2 generates a template from the Db2® catalog table. After you have saved the template, you can then use FM/Db2 to enhance it.

The following sections describe how you use templates with FM/Db2.

Associating a template with a Db2® object

To use an existing template with a File Manager/Db2 panel, you supply the name of the template in the template **Data set name** entry field (and optionally the template **Member** entry field) then, in the **Template usage** entry field, select option 1 (Above).

```
Template:
  Data set name . . . . FMUSER.TEMPLATE
  Member . . . . . SALARIES

Processing Options:
  Template usage          Enter "/", "A"lways to select option
  1. Above                _ Edit options
  2. Previous              _ Edit template
  3. Generate from table  _ Re-edit template
  4. Generate/Replace
```

If you have previously used a template with the input Db2® object, you can select option 2 (Previous) instead. The Previous option instructs FM/Db2 to ignore the contents of the Template fields, and instead use the template most recently associated with the input data set. If you want to edit the template before using it, select the **Edit template** field.

To generate a template for the specified Db2® object, select option 3 (Generate from table). This option instructs FM/Db2 to ignore the contents of the Template fields and use information from the Db2® catalog table to generate a template for the Db2® object. This is the default setting.

To generate a template for the specified Db2® object and immediately save the template, enter the name you want FM/Db2 to use for the template in the template **Data set name** entry field (and optionally the template **Member** entry field) then, in the **Template usage** entry field, select option 4 (Generate/Replace).

Related tasks

[Editing a template on page 81](#)

Related references

[Copy Utility \("From"\) panel on page 498](#)

[Copy Utility \("To"\) panel on page 506](#)

[Data Create Utility panel on page 587](#)

[Db2 Browse panel on page 595](#)

[Db2 Edit panel on page 598](#)

[Db2 View panel on page 613](#)
[Export Utility \("To"\) panel on page 676](#)
[Export Utility \("From"\) panel on page 673](#)
[Import Utility \("To"\) panel on page 694](#)
[Import Utility \("From"\) panel on page 693](#)
[LOAD from panel on page 704](#)
[Print Utility panel on page 733](#)
[UNLOAD Utility \(Tables\) "From" panel on page 860](#)
[UNLOAD Utility \(Tables\) "To" panel on page 861](#)

Information stored in a template

The following section describes the information that a template can contain, and where and how FM/Db2 uses the information.



Note: In this chapter, *"transferring data"* refers to using any of the following FM/Db2 functions:

- Copy (option 3.3)
- Import (option 3.6)
- Export (option 3.7)
- Utilities (option 3.9), Db2® LOAD utility, Db2® UNLOAD utility

Row selection criteria

Determines which rows are to be selected.

Rows that do not match the row selection criteria are excluded when comparing, copying² or printing.

Column selection

Determines which columns are displayed (if you are browsing or editing) or printed.

Except for when you are exporting data, this information is ignored when transferring or creating Db2® objects. (When you are copying, importing, exporting, or loading data, if you want to exclude some data in the input from being transferred to the output, you need to *"map"* the *"To"* template without those fields.)

Column sequence

Overrides the default order in which columns are displayed (if you are browsing or editing) or printed. By default, columns are displayed or printed in the order in which the columns are defined in the object in the Db2® catalog (the COLNO column of SYSIBM.SYSCOLUMNS).

2. When copying, FM/Db2 uses this information in the "From" template. In a "To" template, this information is ignored. However, when comparing, the selection information in both the "Old" and "New" templates is used.

This information is ignored when transferring or creating Db2® objects. (When copying, importing, exporting, or loading data, if you want to exclude some data in the input from being transferred to the output, you need to “map” the “To” template without those fields.)

Column headings

Overrides the default column headings when browsing, editing or printing. (The default column headings are the column names defined in the Db2® catalog.)

Column fixed attributes

The column name and data type as defined in the Db2® catalog on which the template was based.

Column use attributes

Consist of two attributes:

Output width

Defines the number of positions allocated to the column if you are browsing, editing or printing.

The default width depends on the data type and relates to the “external” format for the data. For example, the default width for a SMALLINT column is 6 bytes (the usual external display size).

If a numeric field contains a valid numeric value, but the value is too large to fit in the output width, then, if you are browsing or editing, the value is truncated and highlighted.

Leading zeros (numeric columns only)

Defines whether or not the column value is shown with leading zeros if you are browsing, editing or printing.

Column create attributes

Defines the value to which the column is initialized if you are transferring data, or creating a table.

If you are transferring data, FM/Db2 uses this information in the “To” template. In a “From” template, this information is ignored.

Column mapping

Defines which columns in the “From” template map to columns in the “To” template if you are transferring data.

If you are transferring data, FM/Db2 uses this information in the “To” template. In a “From” template, this information is ignored.

Scrambling options

Determine how the contents of the column are scrambled (if at all) during a copy, import, or export process.

Related tasks

[Copying data from one Db2 object to another on page 241](#)

[Copying data from a VSAM or QSAM file on page 246](#)

[Copying data to a VSAM or QSAM file on page 274](#)

[LOAD utility on page 349](#)

[UNLOAD utility on page 372](#)

[Mapping data on page 109](#)

Related references

[Db2 data types on page 432](#)

[Copy Utility \("From"\) panel on page 498](#)

[Import Utility \("From"\) panel on page 693](#)

[Export Utility \("From"\) panel on page 673](#)

[Data Create Utility panel on page 587](#)

[Db2 Utilities panel on page 610](#)

Printing a template

To print a template, use the TP primary command.

Related tasks

[Looking at the print output from your FM/Db2 session on page 326](#)

Related references

[TP primary command on page 944](#)

[PB primary command on page 925](#)

Using templates with non-Db2 data

Some FM/Db2 functions interface with non-Db2 data:

- You can *retrieve* non-Db2 data with these FM/Db2 functions:
 - Import (option 3.6) – for retrieving non-Db2 data from a VSAM or QSAM data set.
 - The Db2® LOAD utility in Utilities (option 3.9) – for retrieving data from a sequential data set.
- You can *write* data to non-Db2 files with these FM/Db2 functions:
 - Export (option 3.7) – for writing data to a VSAM data set, a sequential data set, or a member of a partitioned data set.
 - The Db2® UNLOAD utility in Utilities (option 3.9) – for unloading data to a sequential data set.

Because this is non-Db2 data, FM/Db2 is not able to create a template from the Db2® catalog table. Instead, you have to provide a source for the template. The source is either a (non-Db2) template or a copybook. This describes the records and fields in the data set or member. If you specify a copybook, FM/Db2 compiles it into a template. You can save it and reuse it with any application data set that has the same record structure.

A copybook is a data set containing COBOL, HLASM, or PL/I source statements that describe the record structure of an application data set:

COBOL data description entries

Each level-01 group item in the copybook describes a record type in the application data set; elementary items in the group describe fields in the record type.

For example, the following entries describe the record structure of an application data set that contains two record types, ORDER and ITEM:

```
01 ORDERS.
  02 ORDER-ID      PIC X(5).
  02 CUSTOMER-ID   PIC X(5).
  02 ORDER-DATE.
    03 ORDER-YEAR  PIC X(4).
    03 ORDER-MONTH PIC X(2).
    03 ORDER-DAY   PIC X(2).
01 ITEM.
  02 PRODUCT-ID    PIC X(9).
  02 QUANTITY      PIC 9(4) BINARY.
  02 UNIT-COST     PIC 9(8) BINARY.
```

ORDER records contain five fields: ORDER-ID, CUSTOMER-ID, ORDER-YEAR, ORDER-MONTH and ORDER-DAY.

ITEM records contain three fields: PRODUCT-ID, QUANTITY and UNIT-COST.

HLASM DSECT definitions

HLASM copybooks are similar to COBOL copybooks, in that the major structures (DSECT names) describe record types and elementary names describe fields:

```
ORDER      DESCT
ORDERID    DS  CL9
CUSTOMERID DS  CL5
ORDERDATE  DS  0CL8
ORDERYEAR  DS  CL4
ORDERMONTH DS  CL2
ORDERDAY   DS  CL2
ITEM       DESCT
PRODUCTID  DS  CL9
QUANTITY   DS  H
UNITCOST   DS  F
```

PL/I DECLARE statements

Similar to COBOL copybooks, major structures (level-1 names) describe record types, and elementary names describe fields:

```
DECLARE 1 ORDER,
  2 ORDER_ID      CHAR(9),
  2 CUSTOMER_ID   CHAR(5),
  2 ORDER_DATE,
  3 ORDER_YEAR    CHAR(4),
  3 ORDER_MONTH   CHAR(2),
  3 ORDER_DAY     CHAR(2);
DECLARE 1 ITEM,
  2 PRODUCT_ID    CHAR(9),
  2 QUANTITY      BIN(15),
  2 UNIT_COST     BIN(31);
```

A copybook can contain the entire source of a COBOL, HLASM, or PL/I program, or only COBOL data description entries, HLASM DSECT definitions, or PL/I DECLARE statements. FM/Db2 ignores everything in the copybook except for COBOL data description entries, HLASM DSECT definitions, or PL/I DECLARE statements.

FM/Db2 supports copybooks stored in any of the following:

- PDS
- PDSE
- CA-Panvalet library
- Library accessed using the Library Management System Exit



Note:

1. Library members may not be packed by ISPF.
2. For details about enabling File Manager to use a CA-Panvalet library, or a library accessed using the Library Management System Exit, see the *File Manager Customization Guide*.

Related tasks

[How FM/Db2 compiles a copybook into a template on page 77](#)

How FM/Db2 compiles a copybook into a template

If you specify a copybook, FM/Db2 performs the following steps:

1. Checks (if the compiler language selected is not HLASM) whether the copybook is a complete source program, or contains only COBOL data declarations or PL/I DECLARE statements. If the copybook is not a complete program, FM/Db2 includes the copybook in a shell program.
2. Calls the selected compiler to check the syntax of the copybook, and to produce an ADATA file.

You can use the Settings: Compiler language selection panel (option 0.0.4) to specify whether FM/Db2 calls the COBOL, HLASM, or PL/I compiler.

For COBOL and PL/I copybooks, you can select the **Auto detect** option on the Compiler Language Selection panel to instruct File Manager to detect the language of the copybook and call the appropriate compiler. In this case, FM/Db2 analyzes the source to determine whether the language of the source is COBOL or PL/I and creates a template based on the result.

To instruct File Manager to process an Assembler copybook, you must set the language option on the Compiler Language Selection panel to HLASM. Once you have set the option to HLASM, every function that supports copybooks can be used with an Assembler copybook. Use the HLASM compiler specifications to provide extra SYSLIB and change ALIGN and DBCS processing options.

You can specify the acceptable return code level for the compilation in the compiler specifications panel for the selected language.

If the compilation produces a return code with a value less than or equal to the specified maximum, FM/Db2 processes the information in the ADATA file to create a template.

If the compilation produces a return code with a value greater than the specified maximum, FM/Db2 displays a pop-up menu. From the pop-up menu, you can:

- View the compilation listing using Print Browse (option 3.11).
- Cancel the template creation process.
- Try the compilation again. Before you select this option, first view the compilation listing and correct any errors in the copybook. While you are viewing the compilation listing, you can use the ISPF split screen facility to swap to another ISPF session and use your editor to correct the errors in the copybook.
- Ignore the errors and proceed with creating the template. This option is only available if FM/Db2 is able to create a template. Some compilation errors, such as warnings, might have no effect on the creation of the template. If you are unsure, view the compilation listing. If the compilation error is too severe, FM/Db2 cannot create a template.
- Try the compiler for the other language. The option is not available if the HLASM compiler language has been selected.

Related tasks

[Compiler language selection \(option 0.4\) on page 63](#)

[Compiler Language Selection panel on page 493](#)

Related references

[Set COBOL Processing Options panel on page 785](#)

[Set PL/I Processing Options panel on page 790](#)

[Set HLASM Processing Options panel on page 787](#)

Support for COBOL data description entries

In the COBOL data description entries specified in a copybook, FM/Db2 supports:

- ASSIGN clause
- OCCURS clause (including OCCURS DEPENDING ON)
- PICTURE clause (except for numeric editing)
- REDEFINES clause
- RENAMES clause
- USAGE clause
- VALUE clause

FM/Db2 ignores:

- BLANK WHEN ZERO clause
- DATE FORMAT clause
- EXTERNAL clause
- GLOBAL clause
- JUSTIFIED clause
- Numeric editing in the PICTURE clause
- SYNCHRONIZED clause

FM/Db2 supports all data item level numbers except 88 (condition-names).

Support for HLASM data description entries

In the HLASM data description entries specified in a copybook, FM/Db2 produces a record, or segment, for each DSECT it finds with corresponding DS/DC fields.

For more information, see the section "Using HLASM copybooks with File Manager" in the Base *File Manager User's Guide and Reference*.

Support for PL/I data description entries

In the PL/I data description entries specified in a copybook, FM/Db2 supports:

- PL/I data attributes VARYING and VARYINGZ for single and double-byte character strings.
- PL/I bit variables including the VARYING attribute.
- Binary, decimal, floating point and numeric picture data (excluding symbols).
- REFER variables for array extents. Both upper and lower bound array elements may be declared for each dimension. The number of extents for each dimension is always:

```
upper bound - lower bound + 1
```



Note: A zero extent is not allowed for a PL/I dimension. If a bound is not specified PL/I assumes a value of 1.

- REFER variable to declare the length of a string variable, character (AN), varying-length character (VC) or zero-terminated character string (ZC) in bytes.
- FM/Db2 also supports PL/I double-byte character variables (DB), varying-length double-byte character (VD) and zero-terminated double-byte characters (Z2) as byte pairs. FM/Db2 also supports bit strings (BT) and varying bit string (VB) variables.
- REFER variables can be declared as integer, fixed binary, packed decimal, floating point, or character string variables.
- UNION declarations at any level which can have varying length (REFER string length or REFER array extents).



Note: UNIONS can contain overlays of different data types, which may require template workbench record selection criteria or SHOW control if data is not displayable.

FM/Db2 ignores:

- INIT data values
- REFER start expression, for example,

```
VAR(, expr Refer abc, ) or
CHAR(expr Refer abc).
```

- EXTERNAL attributes
- DEFINED structure overlays
- LIKE structure attributes



Note: In general, FM/Db2 treats Numeric Edited fields as alphanumeric. A special code, ZA, is used for unsupported zoned decimals.

Support for variable-length arrays

A variable-length array is defined in a COBOL copybook by an OCCURS DEPENDING ON (ODO) clause, and in a PL/I copybook by a dimension attribute where the lower or upper bounds (or both) are defined by REFER options.

The following considerations apply if you are using a template that contains variable-length arrays:

- A record structure can contain multiple variable-length arrays; however, the fields that define the size of the arrays (the ODO or refer “objects”) must all be in the record before the first variable-length array item.
- If any of the following are true:
 - (COBOL copybook only.) The object is out of the range specified by the ODO clause.
 - The record length does not match the calculated length of a record with the number of array items specified by the object.

then, if you are editing the data set, the prefix area contains the description `=LGTH`, indicating that the record was not selected because of incorrect length.

- If you change the value of an object field, then the number of items in the array expands or contracts automatically.

New items are inserted at the end of the current array (and before any fields that follow the array); numeric items are initialized to zero, and alphanumeric items are initialized to blanks.

Similarly, items are deleted from the end of the array, and any fields subsequent to the end of the table are not affected.

For PL/I, the number of items in an array is determined by subtracting the lower bound of the dimension attribute from the upper bound and then adding one. If both the lower and upper bounds are specified using REFER options, changing the value of either of the refer object fields inserts or deletes array items accordingly.

- (COBOL copybook only.) You cannot change the object field to a value outside the range specified by the ODO clause. (FM/Db2 supports an ODO lower value of 0.)
- (COBOL copybook only.) Inserting a new record results in a record with the minimum number of array items specified by the ODO definition. For example:
 - Given the following ODO clause:

```
ODO-ONE OCCURS 0 TO 10 TIMES DEPENDING ON ODO-CNTRL-ONE.
```

if you insert a new record, the ODO-CNTRL-ONE field is initialized to zero, with no ODO-ONE array items in the new record.

- Given the following ODO clause:

```
ODO-ONE OCCURS 5 TO 7 TIMES DEPENDING ON ODO-CNTRL-ONE.
```

ODO-CNTRL-ONE is initialized to 5, with five ODO-ONE array items in the new record.

- (PL/I copybook only.) Inserting a new record results in a record with zero array items. Upper and lower bound refer object fields are initialized to zero.

Related tasks

[Copying data from a VSAM or QSAM file on page 246](#)

[LOAD utility on page 349](#)

[Copying data to a VSAM or QSAM file on page 274](#)

Editing a template

FM/Db2 always uses a template to display Db2® data.

The discussion in this section provides examples based on editing a template while you are browsing the sample data shown in [Figure 142: Sample data on page 825](#).

You can use either of the following methods to edit a template:

- On an entry panel where you can use templates:
 1. Specify the template you want FM/Db2 to use (by selecting the appropriate **Template usage** option and, if required, specifying the name of the template).
 2. Select the **Edit template** field.
 3. Press Enter.

FM/Db2 presents the template for editing, then runs the function after you have finished editing.

If you edit a template in this way, you can change all parts of the template (including row selection criteria).

- If you are using Browse (option B), View (option 1), or Edit (option 2) to browse, view, or edit data, you can use the TEDIT primary command.



Note:

1. You can *only* use the TEDIT primary command from within a File Manager/Db2 editor session (if you have the data displayed). You cannot use TEDIT from either the Db2® View or Db2® Edit function panels.
2. If you use the TEDIT primary command, you cannot change the **Order, A/D, or Row Selection Criteria** input fields.



The reason you cannot alter these parts of the template is that a File Manager/Db2 editor session is in progress and the session can contain uncommitted changes to data. Altering the preceding parts of the template might require data to be retrieved from Db2® using a new (and possibly different) SQL statement.

When you edit a template (using either of the preceding methods), FM/Db2 displays the Column Selection/Edit panel.

When you have finished editing the template using the Column Selection/Edit panel, you can:

- Use the edited template “*on the fly*” without saving it by pressing the RunTemp function key (F6),
- Optionally save the edited template before returning to the FM/Db2 function panel by pressing the Exit function key (F3), or
- Return to the FM/Db2 function panel without saving the template by pressing the Cancel function key (F12).

Related tasks

[Where you can use templates on page 23](#)

[Viewing and changing Db2 data on page 119](#)

Related references

[TEDIT primary command on page 943](#)

[Column Selection/Edit panel on page 485](#)

Adding a description to a template

When you are creating or modifying a template, you can issue the DESCRIBE primary command to add a description to the template.

To add or modify a description for a template:

1. Display the Column Selection/Edit panel for the template concerned by:
 - Selecting the **Edit template** field on an entry panel where you can the template, or
 - Issuing the TEDIT primary command from within a File Manager/Db2 editor session that is using the template to display the data
2. Enter the DESCRIBE primary command.

FM/Db2 displays the Db2® Template Description panel.

3. Enter or modify the description for the template in the **Description** entry field.
4. Press the Exit function key (F3) to return to the Column Selection/Edit panel.

Related references

[DESCRIBE primary command on page 884](#)

[TEDIT primary command on page 943](#)

[Column Selection/Edit panel on page 485](#)

[Db2 Template Description panel on page 608](#)

Selecting rows

Before you view or edit data, you can select the rows you want to view by editing a template and specifying *row selection criteria*.

To specify row selection criteria, you must first display the Column Selection/Edit panel by selecting the **Edit template** field on an entry panel where you can use templates. (If you use the TEDIT primary command to display the Column Selection/Edit panel, you cannot change the row selection criteria.)

You can specify row selection criteria:

- By column, or
- In freeform style

The following sections describe these two methods.

For a full-screen edit, use the SQL primary command or press the SQL function key (F4).

Row selection by column

To enter row selection criteria by column, type **1** on the command line on the Column Selection/Edit panel and press Enter. FM/Db2 displays the Row Selection Criteria panel.

On the line for each column for which you want to specify selection criteria, you specify an operator (like = or >) in the **Op** column and, in most cases, a value in the **Value** column.

For example, to select only employees with a surname of SMITH from a table of employees:

1. On the line for the column LASTNAME, type **=** in the Op column and **SMITH** (optionally enclosed in single quotation marks) in the Value column:

Figure 23. Example 1: Specifying a simple predicate to match a single value

Cmd	Con	(Column name		Data type(length)	Op	Value
<->	-	<-----1-----2----->			<-----1----->	<->	<----->
***	****		Top of data	****			
			EMPNO		CHARACTER(6)		
			AND FIRSTNME		VARCHAR(12)		
			AND MIDINIT		CHARACTER(1)		
			AND LASTNAME		VARCHAR(15)	=	SMITH

This predicate works well in the situation where the data in the table is stored in uppercase. However, if the data in the table is in mixed case (for example, 'Smith') or contains errors (for example, 'SmiTH'), Db2® will not return all the desired rows.

Normally, any operator that is entered in the Op column has no effect on the column name. The following two operators allow a column function to be specified:

LKL

Results in this expression: LOWER(colname) LIKE value.

LKU

Results in this expression: UPPER(colname) LIKE value.

In the following example, any upper case character in the value will result in no matches, so FM/Db2 automatically converts the value entered into lower case. For more information, see [The expression generated from the expression in example 2 on page 85](#).

Figure 24. Example 2: Specifying the LKL operator

Cmd	Con	(Column name	Data type(length)	Op	Value
<->	-	<-----1-----2----->	<-----1----->	<->	<-----1-----2
***	****	Top of data ****			
		EMPNO	CHARACTER(6)		
	AND	FIRSTNME	VARCHAR(12)		
	AND	MIDINIT	CHARACTER(1)		
	AND	LASTNAME	VARCHAR(15)	LKL	'%SMITH%'

In the following example, any lower case character in the value will result in no matches, so FM/Db2 automatically converts the value entered into upper case. For more information, see [The expression generated from the expression in example 3 on page 85](#).

Figure 25. Example 3: Specifying the LKU operator

Cmd	Con	(Column name	Data type(length)	Op	Value
<->	-	<-----1-----2----->	<-----1----->	<->	<-----
***	****	Top of data ****			
		EMPNO	CHARACTER(6)		
	AND	FIRSTNME	VARCHAR(12)		
	AND	MIDINIT	CHARACTER(1)		
	AND	LASTNAME	VARCHAR(15)	LKU	'%smith%'

You can also specify a column expression directly if required. To enter a column expression, you can either issue the EDITCOL editor primary command, or type the EC prefix command against the column name where an expression is required. After issuing these commands, the column name field changes to an input field.

[Figure 26: Example 4: Entering a column expression and a data value with the escape character on page 84](#) shows the use of a column expression and the '\ ' escape character. This example demonstrates how to display the rows where an employee was hired in March. The escape character is used to prevent FM/Db2 from attempting to validate the data in the value field according to the type. The column function MONTH returns an integer representing the month (1 - 12), whereas the data type for the column is DATE.

Figure 26. Example 4: Entering a column expression and a data value with the escape character

Cmd	Con	(Column name	Data type(length)	Op	Value
<->	-	<-----1-----2----->	<-----1----->	<->	<-----
***	****	Top of data ****			
		EMPNO	CHARACTER(6)		
	AND	FIRSTNME	VARCHAR(12)		
	AND	MIDINIT	CHARACTER(1)		
	AND	LASTNAME	VARCHAR(15)		
	AND	WORKDEPT	CHARACTER(3)		
	AND	PHONENO	CHARACTER(4)		
	AND	MONTH(HIREDATE)		=	\3

2. Press the Exit function key (F3).

FM/Db2 displays the Column Selection/Edit panel showing the generated row selection criteria (WHERE clause) in the **Row Selection Criteria** field at the top of the panel:

The results of the expressions entered in example 1 - example 4 are shown below:

Figure 27. The expression generated from the expression in example 1.

```

Process   Options   Utilities   Help
-----
FM/Db2 (DFG2)                               Co
Command ==>
TABLE DSN81010.EMP
----- Row Selection Criteria
1 Sel: WHERE "LASTNAME" = 'SMITH'

```

Figure 28. The expression generated from the expression in example 2

```

Process   Options   Utilities   Help
-----
FM/Db2 (DFG2)                               Co
Command ==>
TABLE DSN81010.EMP
----- Row Selection Criteria
1 Sel: WHERE LOWER("LASTNAME") LIKE '%smith%'

```

Figure 29. The expression generated from the expression in example 3

```

Process   Options   Utilities   Help
-----
FM/Db2 (DFG2)                               Co
Command ==>
TABLE DSN81010.EMP
----- Row Selection Criteria
1 Sel: WHERE UPPER("LASTNAME") LIKE '%SMITH%'

```

Figure 30. The expression generated from the expression in example 4

```

Process   Options   Utilities   Help
-----
FM/Db2 (DFG2)                               Co
Command ==>
TABLE DSN81010.EMP
----- Row Selection Criteria
1 Sel: WHERE MONTH(HIREDATE) = 3

```

3. Press Exit function key (F3)

FM/Db2 displays the selected data:

Figure 31. The data resulting from the expressions in example 1 - example 4

```

FM/Db2 (DFG2)                               Table Edit
Command ==>
2 rows - End of object.
EMPNO  FIRSTNME      MIDINIT  LASTNAME      WORKDEPT  PHONENO  HIREDATE
#1     #2              #3      #4            #5        #6       #7
CH(6)  VARCHAR(12)      CH(1)   VARCHAR(15)   CH(3)     CH(4)    DATE
PUN-> <-N-+-----1-> -         <-N-+-----1-----> <-N      <-->      <----->
*****   **** Top of data   ****
000001 000250 DANIEL<   S          SMITH<      D21        0961     1969-10-30
000002 000300 PHILIP<   X          SMITH<      E11        2095     1972-06-19
    
```

Figure 32. The data resulting from the expression in example 4

```

FM/Db2 (DFG2)                               Table Edit
Command ==>
3 rows - End of object.
EMPNO  FIRSTNME      MIDINIT  LASTNAME      WORKDEPT  PHONENO  HIREDATE
#1     #2              #3      #4            #5        #6       #7
CH(6)  VARCHAR(12)      CH(1)   VARCHAR(15)   CH(3)     CH(4)    DATE
PUN-> <-N-+-----1-> -         <-N-+-----1-----> <-N      <-->      <----->
*****   **** Top of data   ****
000001 000200 DAVID<    S          BROWN<      D11        4501     1966-03-03
000002 000280 ETHEL<    R          SCHNEIDER<  E11        8997     1967-03-24
000003 200280 EILEEN<   R          SCHWARTZ<   E11        8997     1967-03-24
    
```

Continuing with the expression entered in [Figure 23: Example 1: Specifying a simple predicate to match a single value on page 83](#), if you now want to select, for example, employees with a surname of SMITH or JONES, you need to modify the row selection criteria. To do this, you must return to the Row Selection Criteria panel:

1. From the panel of displayed data, press the Exit function key (F3) to return to the Db2® Edit entry panel.
2. Select the **Edit template** field and press the Exit function key (F3) to display the Column Selection/Edit panel.

You will notice on this panel that the **Row Selection Criteria** field (showing your previous WHERE "LASTNAME" = 'SMITH' clause) is protected. This is because row selection criteria entered by column or as a free-form expression are not interchangeable. You can change row selection criteria that has been entered by column, by returning to the Row Selection Criteria panel. You can convert row selection criteria entered by column to a free-form expression by issuing the SQL command on the Column Selection/Edit panel, and saving the data. The conversion removes the specification by column. You cannot convert a free-form expression to a row selection criteria entered by column.

3. Enter 1 on the command line to display the Row Selection Criteria panel.
4. To select more than one value for the same column (as in this case, where you want to select both SMITH and JONES), there are two methods you can use:
 - Use multiple lines for the column:
 - a. Type the R (Repeat) prefix command in the **Cmd** column to repeat the line for the column name concerned
 - b. On the repeated line (or lines) for the column name, change the connector (in the **Con** column) to "OR" by overtyping the AND with O or OR
 - c. Type the value in the **Value** column

For our example, the selection lines now look like this:

```

Cmd  Con  ( Column name                               Op  Value
<-> - <-----1-----2-----3-----> <-> <-----1-----2----->
***   **** Top of data   ****
:
_____ AND  _ LASTNAME                               =   SMITH
_____ OR  _ LASTNAME                               =   JONES
    
```

- Use the IN operator:
 - a. On the line for LASTNAME, change the operator (from =) to IN. The IN operator lets you specify a list of values you want to select.
 - b. In the value column, type the values you want to select. For alphanumeric columns, when you specify a list of values, each value *must* be enclosed in quotation marks and separated by a comma.

For our example, the selection line now look like this:

```

Cmd Con ( Column name                               Op Value
  <-> - <-----1-----2-----3-----> <-> <-----1-----2-----> -
*** **** Top of data ****
:
___ AND _ LASTNAME                                IN 'SMITH','JONES' ___

```

5. Press the Exit function key (F3) twice to display the selected data. Whichever method you used to specify row selection criteria for SMITH or JONES, the same results are achieved:

Process	Options	Utilities	Help
FM/Db2 (DFG2)			Table Edit
TABLE FMUSER.EMP			Template saved Format TABL
EMPNO	FIRSTNME	MIDINIT	LASTNAME
#1	#2	#3	#4
CH(6)	VARCHAR(12)	CH(1)	VARCHAR(15)
PU-->	<-----1->	-	<-----1----->
000000	****	Top of data	****
000001	000210	WILLIAM<	T JONES<
000002	000250	DANIEL<	S SMITH<
000003	000300	PHILIP<	X SMITH<
000004	****	End of data	****
:			

Continuing with this same example, if you now want to select employees with a surname of SMITH or JONES who are in department D21, you again need to modify the row selection criteria.

This time, in order to avoid any ambiguity, you may need to use parentheses to define the sequence of evaluation for the resultant WHERE clause. On the Row Selection Criteria panel, you can use the (and) columns to enclose groups of expressions in parentheses.

For our example, the selection lines may now look like this:

```

Cmd Con ( Column name                               Op Value
  <-> - <-----1-----2-----3-----> <-> <-----1-----2-----> -
*** **** Top of data ****
:
___ AND ( LASTNAME                                = SMITH
___ OR _ LASTNAME                                = JONES
___ AND _ WORKDEPT                              = D21

```

The selected data now appears as:

Process	Options	Utilities	Help
FM/Db2 (DFG2)			Table Edit
TABLE FMUSER.EMP			Template saved Format TABL
EMPNO	FIRSTNME	MIDINIT	LASTNAME
#1	#2	#3	#4
CH(6)	VARCHAR(12)	CH(1)	VARCHAR(15)
PU-->	<-----1->	-	<-----1----->
000000	****	Top of data	****
000002	000250	DANIEL<	S SMITH<
000004	****	End of data	****
:			

Changing the display (80-character screens only)

On wide screens, FM/Db2 displays both the **Column Name** and the **Data type(length)** details for each column on the Row Selection Criteria panel. However, for 80-character screens, by default FM/Db2 displays only the **Column Name** details.

On an 80-character screen, there are five different versions of the Row Selection Criteria panel:

1. The default screen, which includes the column name and no data type field.
2. A screen that includes the data type field, but not the column name field.
3. A screen that includes the column name field and an abbreviated data type field.
4. A screen that includes a truncated column name field and no data type field.
5. A screen that is similar to version 4. However, the column name data is right-aligned, rather than left-aligned.

Use the PF10 and PF11 function keys to cycle between the five screen versions that are described in the preceding list. Pressing PF10 from screen 1 displays screen 5. Pressing PF11 from screen 5 displays screen 1.



Note: The cursor must not be positioned on a **Value** input field.

Verifying the format of DATE, TIME, and TIMESTAMP columns

If the row selection criteria you are specifying includes a DATE, TIME, or TIMESTAMP column, the value you specify (in the **Value** entry field) for that column must be in the correct format.

If you are not sure of the format you should use:

1. Type the required operator (such as "=") in the **Op** entry field
2. Type "=" in the **Value** entry field
3. Press Enter

FM/Db2 displays the field in the format required, showing the current value.

For example, if you enter "=" in the **Value** entry field for a **TIMESTAMP(4)** column, FM/Db2 returns the current date and time in the format required for a **TIMESTAMP(4)** column:

```

Cmd  Con ( Column name                Op  Value
<-> - <-----1-----2-----3-----> <-> <-----1-----2----- -
***  ***  Top of data  ****
:
:
:  AND  -  TSTAMP                      =  2004-09-24-09.19.36.7749
:

```

Note that the last two digits are removed. **TIMESTAMP(4)** means four digits of precision.

Using the same format, you can now overwrite the value that FM/Db2 returns with the value you want to use as part of your row selection criteria.

Related tasks

[Scrolling the Row Selection Criteria field on page 91](#)

[Expanding the Row Selection Criteria field on page 92](#)

Related references

[Column Selection/Edit panel on page 485](#)

[Row Selection Criteria panel on page 767](#)

Row selection criteria in freeform style

To enter freeform row selection criteria, you use the **Row Selection Criteria** entry field at the top of the Column Selection/Edit panel. The entry field is protected and you cannot update it if:

- It already contains a WHERE clause which was generated by column, or
- You have used the TEDIT command to display the Column Selection/Edit panel

In this entry field, enter any valid SQL WHERE clause to specify selection criteria to select the data you want to view or edit.

For example, if you have two columns, WORKDEPT and LASTNAME, and you want to display only details of people in department A00 whose family name starts in the range "A" to "M":

1. Enter the following selection criteria:

```
WORKDEPT = 'A00' AND LASTNAME BETWEEN 'A%' AND 'M%'
```

Alternatively, you can use the FM/Db2 reference numbers as abbreviations for the column names. For example, you can write the preceding expression as:

```
#5 = 'A00' AND #4 BETWEEN 'A%' AND 'M%'
```

If you use abbreviations for column names, FM/Db2 expands them to the full column name when you press Enter. If you omit the keyword WHERE, FM/Db2 inserts it when you press Enter.

The Column Selection/Edit panel now looks like this:

Figure 33. Primary Column Selection/Edit panel showing row selection criteria

```

Process  Options  Utilities  Help
-----
FM/Db2 (DFG2)                Column Selection/Edit                Line 1 of 16
TABLE FMNUSER.EMP
----- Row Selection Criteria ---- (Use SQL/PF4 for full screen edit) -----
1 Sel: WORKDEPT = 'A00' AND LASTNAME BETWEEN 'A%' AND 'M%'                +

Cmd Seq SHEX CL# Column name      Data type(length)  Null Default  Order A/D
-----
      S      1 EMPNO                CHARACTER(6)       None      -----
      S      2 FIRSTNME             VARCHAR(12)        None      -----
      S      3 MIDINIT              CHARACTER(1)       None      -----
      S      4 LASTNAME              VARCHAR(15)        None      -----
      S      5 WORKDEPT              CHARACTER(3)        Y      Null      -----
      S      6 PHONENO              CHARACTER(4)        Y      Null      -----
      S      7 HIREDATE              DATE                Y      Null      -----
      S      8 JOB                CHARACTER(8)        Y      Null      -----
      S      9 EDLEVEL              SMALLINT            Y      Null      -----
      S     10 SEX                CHARACTER(1)        Y      Null      -----
      S     11 BIRTHDATE             DATE                Y      Null      -----
      S     12 SALARY              DECIMAL(9,2)       Y      Null      -----
Command ==>
F1=Help      F2=Split    F3=Exit     F4=SQL      F5=RFind   F6=RunTemp
F7=Up        F8=Down    F9=Swap    F10=Left   F11=Right  F12=Cancel
-----

```

2. Press the Exit function key (F3).

FM/Db2 displays the selected rows:

Figure 34. Example showing selected columns

```

Process  Options  Utilities  Help
-----
FM/Db2 (DFG2)                Table Edit                3 rows fetched
TABLE FMNUSER.EMP
EMPNO  FIRSTNME  MIDINIT  LASTNAME  WORKDEPT  PHONENO  HIREDATE
#1     #2         #3       #4        #5        #6       #7
CH(6)  VARCHAR(12) CH(1)    VARCHAR(15) CH(3)     CH(4)    DATE
PU--> <-----1- > <-----1-----> <-NF <--> <----->
000000 **** Top of data ****
000001 000110 VINCENZO<  G      LUCCHESI<  A00     3490     16.05.1958
000002 200010 DIAN<     J      HEMMINGER< A00     3978     01.01.1965
000003 000010 CHRISTINE< I      HAAS<      A00     3978     01.01.1965
000004 **** End of data ****

Command ==>
F1=Help      F2=Zoom    F3=Exit     F4=CRetrie v F5=RFind   F6=RChange
F7=Up        F8=Down    F9=Swap    F10=Left    F11=Right  F12=Cancel
-----

```

Related tasks

- [Using the SQL Edit session on page 92](#)
- [Scrolling the Row Selection Criteria field on page 91](#)
- [Expanding the Row Selection Criteria field on page 92](#)

Related references

- [Row Selection Criteria panel on page 767](#)

Scrolling the Row Selection Criteria field

To scroll the **Row Selection Criteria** entry field on the Column Selection/Edit panel, you can use the:

- Right function key (F11) and Left function key (F10), or
- RIGHT and LEFT primary commands

In either case, you must position the cursor on the **Row Selection Criteria** entry field before pressing either function key, or pressing Enter to issue either primary command.

The scroll indicator (+ or -) to the right of the expression indicates which directions you can scroll:

+

Entry field scrollable to the right

-

Entry field scrollable to the left

To control how far you scroll, enter a scroll amount in the **Scroll** field:

Scroll amount

Scrolls...

MAX

To the first or last position of the expression

PAGE

One viewable width of data at a time

HALF

Half a viewable width of data at a time

DATA

One character less than a viewable width of data at a time

CSR

When scrolling to the right, FM/Db2 positions the field with the character at the cursor being moved to the leftmost position in the viewable expression.

When scrolling to the left, FM/Db2 positions the field with the character at the cursor being moved to the rightmost position in the viewable expression.

nnnn

nnnn characters at a time

To change the scroll amount, enter a new value into the **Scroll** field. If you enter `MAX`, FM/Db2 restores the scroll amount to its previous value after the operation. If you enter any other scroll amount, it remains in effect until you change it again.

Related tasks

[Row selection by column on page 83](#)

[Row selection criteria in freeform style on page 89](#)

Related references

[RIGHT primary command on page 934](#)

[LEFT primary command on page 912](#)

Expanding the Row Selection Criteria field

You can expand the **Row Selection Criteria** entry field by:

- Entering the command SQL, or pressing the SQL function key (F4), to display an ISPF edit session containing the SQL expression
- Using the EXPAND command:
 1. Type `EXPAND` on the command line
 2. Position the cursor on the **Row Selection Criteria** entry field
 3. Press Enter.

FM/Db2 displays an expanded entry panel that allows you to enter row selection criteria up to 32,767 bytes long.

Related tasks

[Row selection by column on page 83](#)

[Row selection criteria in freeform style on page 89](#)

[Using the SQL Edit session on page 92](#)

Related references

[Column Selection/Edit panel on page 485](#)

[EXPAND primary command on page 893](#)

Using the SQL Edit session

To start an SQL Edit session, use the SQL primary command. The Edit session contains the SQL statement that FM/Db2 is using to retrieve data from Db2®.

You can use the SQL Edit session to change the row selection criteria (WHERE clause), before retrieving data from Db2®.

If you use the SQL primary command from within an editor session, FM/Db2 displays a panel such as that shown in [Figure 35: SQL Edit session: SQL command issued from within an editor session on page 93](#).

Figure 35. SQL Edit session: SQL command issued from within an editor session

```

Process  Options  Utilities  Help
-----
EDIT      SYS02203.T120510.RA000.FMNUSER.R0113662      Columns 00001 00072
*****  ***** Top of Data *****
=NOTE= All changes made during this Edit session will be discarded at the end
=NOTE= of the Edit session.
=NOTE= Use the CREATE or REPLACE commands to take a copy of the SQL.
000001 SELECT "EMPNO", "FIRSTNME", "MIDINIT", "LASTNAME", "WORKDEPT",
000002         "PHONENO", "HIREDATE", "JOB", "EDLEVEL", "SEX", "BIRTHDATE",
000003         "SALARY", "BONUS", "COMM"
000004 FROM   "DSN8810"."EMP"
000005 WHERE  "WORKDEPT" = 'A00' AND "LASTNAME" BETWEEN 'A' AND 'M'
000006 WITH   UR
000007 FOR    FETCH ONLY
*****  ***** Bottom of Data *****

Command ==> ----- Scroll PAGE
F1=Help      F2=Split    F3=Exit     F5=Rfind    F6=Rchange  F7=Up
F8=Down      F9=Swap     F10=Left    F11=Right   F12=Cancel

```

If you are editing a template (before displaying data) and you use the SQL primary command (or press the SQL function key (F4)), FM/Db2 displays a panel such as that shown in [Figure 36: SQL Edit session: SQL command issued when editing a template on page 93](#).

Figure 36. SQL Edit session: SQL command issued when editing a template

```

File  Edit  Edit_Settings  Menu  Utilities  Compilers  Test  Help
-----
EDIT      SYS02248.T145911.RA000.FMNUSER.R0103542      Columns 00001 00072
*****  ***** Top of Data *****
=NOTE= Only changes to the WHERE clause will be recognized at the end of the
=NOTE= Edit session. All other changes will be ignored.
=NOTE= Use the CREATE or REPLACE commands to take a copy of the SQL.
=NOTE=
=NOTE= Columns for "DSN8810"."EMP"
=NOTE=  Cl# Column name           Data type(length)  Null
=NOTE=  1  EMPNO                CHARACTER(6)
=NOTE=  2  FIRSTNME              VARCHAR(12)
=NOTE=  3  MIDINIT                CHARACTER(1)
=NOTE=  4  LASTNAME               VARCHAR(15)
=NOTE=  5  WORKDEPT              CHARACTER(3)       Y
=NOTE=  6  PHONENO                CHARACTER(4)       Y
=NOTE=  7  HIREDATE               DATE               Y
=NOTE=  8  JOB                    CHARACTER(8)       Y
=NOTE=  9  EDLEVEL                SMALLINT           Y
=NOTE= 10  SEX                    CHARACTER(1)       Y
=NOTE= 11  BIRTHDATE             DATE               Y
Command ==> ----- Scroll ==> PAGE
F1=Help      F2=Split    F3=Exit     F5=Rfind    F6=Rchange  F7=Up
F8=Down      F9=Swap     F10=Left    F11=Right   F12=Cancel

```

You can use the ISPF editor commands CREATE and REPLACE to take a copy of the SQL statement into another, permanent, data set.

Column details for the Db2® object might be shown as note lines (=NOTE=) at the top of the ISPF edit session. These are only displayed if the WHERE clause can be changed.

Related references

[SQL primary command on page 942](#)

Making changes

The note lines (**=NOTE=**) at the top of the SQL Edit session indicate whether you can make changes to the SQL statement. When data is displayed in a File Manager/Db2 editor session, you cannot change the SQL statement without first ending the current editor session. To interactively test and change SQL statements, use Prototyping: Enter (option 4.3), or use the **Re-edit template** option on the Db2® View or Db2® Edit panel.

You can use FM/Db2 reference numbers as abbreviations for the column names.

When you exit the SQL Edit session by pressing the Exit function key (F3), FM/Db2 converts FM/Db2 reference numbers to the corresponding Db2® column name, and validates the statement. If the validation fails, FM/Db2 redisplay the SQL statement with an error message.



Note:

1. You cannot change any part of the SQL statement before the WHERE keyword. This includes the list of columns in the SELECT clause (see the following note item).
2. All columns in the table are included in the SELECT clause (following the SELECT keyword) of the SQL statement, even if you have edited the template to deselect some columns. If you deselect a column, it causes FM/Db2 not to display that column; it does not affect the SQL command used by FM/Db2 to retrieve the data from Db2®.
3. The maximum length for the WHERE clause that can be specified in the ISPF editor session displayed by the SQL command is 32767 characters.

Related tasks

- [Ending a File Manager/Db2 editor session on page 130](#)
- [Entering, executing, and explaining SQL statements on page 416](#)
- [Selecting rows on page 83](#)
- [Selecting columns on page 96](#)

Related references

- [Db2 View panel on page 613](#)
- [Db2 Edit panel on page 598](#)
- [SQL primary command on page 942](#)

Saving changes

You can only save any changes you make in the SQL Edit session if the WHERE clause can be changed, and the resultant SQL statement is acceptable to Db2®.

When you have made the required changes, press the Exit function key (F3) to redisplay the Column Selection/Edit panel. The row selection criteria section of the panel shows the changes you made to the WHERE clause in the Edit session.

To return to the Column Selection/Edit panel without saving your changes, press the Cancel function key (F12).

Related references

[Column Selection/Edit panel on page 485](#)

Long WHERE clauses

You can use the FM/Db2 SQL Edit session to enter long WHERE clauses (subject to any limits imposed by your host Db2® system). See the *DB2 for z/OS SQL Reference*.

If the SQL expression is too large to be displayed in the **Row Selection Criteria** section of the Column Selection/Edit panel, FM/Db2 displays as much of the expression as possible. In this situation, if you make any changes to the expression on the Column Selection/Edit panel, FM/Db2 displays an ISPF Edit session containing the complete SQL expression.

The maximum length for the WHERE clause that can be specified in the ISPF editor session displayed by the SQL command is 32767 characters.

Related references

[Column Selection/Edit panel on page 485](#)

Manipulating columns

FM/Db2 offers a number of ways to manipulate columns within rows. Using the Column Selection/Edit panel, you can:

- Select columns
- Change the order in which columns are displayed
- Change column headings
- Access column attributes panels to change individual column attributes

Related tasks

[Selecting columns on page 96](#)

[Changing the sequence of displayed or printed data on page 98](#)

[Changing the column heading on page 102](#)

[Changing column attributes on page 101](#)

Related references

[Column Selection/Edit panel on page 485](#)

Selecting columns

To select which columns are displayed in a File Manager/Db2 editor session, use the Column Selection/Edit panel. Selected columns are displayed with an "S" in the **S** column. To toggle between selecting and deselecting a column, enter **s** in the **Cmd** column of the Column Selection/Edit panel.

By default, FM/Db2 selects all of the columns in the Db2® object for display, in the order that they are defined to Db2®. The initial display shows all columns as selected, with the exception of any ROWID column.



Note: Deselecting a column does not alter the SQL statement that FM/Db2 uses to retrieve data from Db2®. In a File Manager/Db2 editor session, FM/Db2 always generates an SQL statement that specifies every column in the Db2® object.

Toggling the selection status of more than one column at a time

You can toggle between selecting or deselecting more than one column at a time by entering one of the following selection commands:

SS

Selects or deselects a block of columns.

Enter SS twice: first in the **Cmd** column at the start of the block you want to select or deselect, and again at the end of the block. FM/Db2 toggles the selection status of each column in the selected block.

Sn

Selects or deselects *n* columns.

Enter *Sn* in the **Cmd** field of the first column you want to select or deselect. FM/Db2 toggles the selection status of each column, starting from the first column selected for *n* columns.

S*

Selects or deselects a block of columns, starting from the first column selected and then all subsequent columns.

Enter *S** in the **Cmd** field of the first column you want to select or deselect. FM/Db2 toggles the selection status of each column, starting from the first column selected to the last column.



Note: If every column in a template is deselected, FM/Db2 selects every column in the template for processing.

Related tasks

[ROWID columns on page 104](#)

Related references

[Column Selection/Edit panel on page 485](#)

Holding columns on the display when scrolling

You can hold columns so that they are always displayed regardless of how far you scroll.

You can hold columns so that, if you scroll left or right in TABL display format, those columns are always displayed on the left of the panel (regardless of how far you scroll).

To hold a column, enter `H` in the **Cmd** column of the Column Selection/Edit panel. To free the column, enter `H` again in the **Cmd** column.

If you hold a column, “*H*” is displayed in the **H** column on the Column Selection/Edit panel, and “*1*” is displayed in the **Seq** column to show it is the first held column. If you hold a second column, “*2*” is displayed in the **Seq** column to show it is the second held column, and so on.



Note:

1. The sequence numbers shown in the **Seq** column for held columns are independent of any sequence number you might enter to change the sequence of displayed columns. Held columns are always displayed as the leftmost columns on the panel (in the order that you held them when editing the template) and take priority (as far as the left-to-right sequence in which columns are displayed is concerned) over other columns.
2. If you hold a number of columns, there might be little or no room left on the display for non-held columns. This is a particular problem if using an 80-byte display. In this situation you might not be able to scroll right.

Toggling the hold status of multiple columns

You can hold or free more than one column at a time by entering one of the following commands in the **Cmd** column of the Column Selection/Edit panel:

HH

Holds or frees a block of columns.

Enter HH twice: first in the **Cmd** column at the start of the block of columns you want to hold or free, and again at the end of the block. FM/Db2 toggles the hold status of each column in the selected block.

Hn

Holds or frees *n* columns.

Enter *Hn* in the **Cmd** field of the first column you want to hold or free. FM/Db2 toggles the hold status of each column, starting from the first column selected for *n* columns.

Related tasks

[Changing the sequence of displayed or printed data on page 98](#)

Related references

[Column Selection/Edit panel on page 485](#)

Changing the sequence of displayed or printed data

You can edit a template to change:

- the order in which *columns* are displayed or printed
- the sequence in which *rows* are displayed or printed

Related tasks

[Changing the sequence of displayed or printed columns on page 98](#)

[Changing the sequence of displayed or printed rows on page 100](#)

Changing the sequence of displayed or printed columns

By default, FM/Db2 displays or prints columns in the sequence they are defined in the Db2® catalog. This is the same sequence that the column names are displayed in the Column Selection/Edit panel.

To change the order in which columns are displayed or printed, use the **Seq** field on the Column Selection/Edit panel to specify an alternative order.



Note: The **Seq** field on the Column Selection/Edit panel affects only the sequence in which FM/Db2 displays or prints columns. It has no effect on the sequence in which columns are exported when you use the Export utility function (3.7).

For example, on the Column Selection/Edit panel shown in [Figure 37: Primary Column Selection/Edit panel showing column sequence selection on page 99](#), to make the JOB column be shown first, then the HIREDATE column (followed by the remaining columns):

1. In the **Seq** column against the JOB column, type **1**.
2. In the **Seq** column against the HIREDATE column, type **2**.

The Column Selection/Edit panel now looks like this:

Figure 37. Primary Column Selection/Edit panel showing column sequence selection

Process		Options		Utilities		Help			
FM/Db2 (DFG2)				Column Selection/Edit		Line 1 of 16			
TABLE FMNUSER.EMP									
----- Row Selection Criteria ---- (Use SQL/PF4 for full screen edit) -----									
1 Sel: _____ +									
Cmd	Seq	SHEX	CL#	Column name	Data type(length)	Null	Default	Order	A/D
				**** Top of data ****					
---	---	S	1	EMPNO	CHARACTER(6)		None	---	---
---	---	S	2	FIRSTNME	VARCHAR(12)		None	---	---
---	---	S	3	MIDINIT	CHARACTER(1)		None	---	---
---	---	S	4	LASTNAME	VARCHAR(15)		None	---	---
---	---	S	5	WORKDEPT	CHARACTER(3)	Y	Null	---	---
---	---	S	6	PHONENO	CHARACTER(4)		Null	---	---
---	2	S	7	HIREDATE	DATE	Y	Null	---	---
---	1	S	8	JOB	CHARACTER(8)	Y	Null	---	---
---	---	S	9	EDLEVEL	SMALLINT	Y	Null	---	---
---	---	S	10	SEX	CHARACTER(1)	Y	Null	---	---
---	---	S	11	BIRTHDATE	DATE	Y	Null	---	---
---	---	S	12	SALARY	DECIMAL(9,2)	Y	Null	---	---
Command ==>				-----				Scroll PAGE	
F1=Help		F2=Split		F3=Exit		F4=SQL		F5=RFind	
F7=Up		F8=Down		F9=Swap		F10=Left		F11=Right	
								F6=RunTemp	
								F12=Cancel	

3. Press the RunTemp function key (F6).

The data is displayed showing the revised order of the columns:

Process		Options		Utilities		Help			
FM/Db2 (DFG2)				Table Browse		42 rows fetched			
TABLE FMNUSER.EMP									
JOB	HIREDATE	EMPNO	FIRSTNME	MIDDLE INITIAL	LASTNAME	Format TABL			
#8	#7	#1	#2	#3	#4	#5			
CH(8)	DATE	CH(6)	VARCHAR(12)	CHARACTER(1)	VARCHAR(15)	CH(3)			
<----->	<----->	PU-->	<-----1->	-	<-----1----->	<-NF			
**** Top of data ****									
PRES	01/01/1965	000010	CHRISTINE<	I	HAAS<	A00			
MANAGER	10/10/1973	000020	MICHAEL<	L	THOMPSON<	B01			
MANAGER	04/05/1975	000030	SALLY<	A	KWAN<	C01			
MANAGER	08/17/1949	000050	JOHN<	B	GEYER<	E01			
MANAGER	09/14/1973	000060	IRVING<	F	STERN<	D11			
MANAGER	09/30/1980	000070	EVA<	D	PULASKI<	D21			
MANAGER	08/15/1970	000090	EILEEN<	W	HENDERSON<	E11			
MANAGER	06/19/1980	000100	THEODORE<	Q	SPENSER<	E21			
SALESREP	05/16/1958	000110	VINCENZO<	G	LUCCHESI<	A00			
CLERK	12/05/1963	000120	SEAN<		O'CONNELL<	A00			
ANALYST	07/28/1971	000130	DOLORES<	M	QUINTANA<	C01			
ANALYST	12/15/1976	000140	HEATHER<	A	NICHOLLS<	C01			
Command ==>				-----				Scroll PAGE	
F1=Help		F2=Zoom		F3=Exit		F4=CRetriev		F5=RFind	
F7=Up		F8=Down		F9=Swap		F10=Left		F11=Right	
								F6=RChange	
								F12=Cancel	

Related tasks

[Copying data to a VSAM or QSAM file on page 274](#)

Related references

[Column Selection/Edit panel on page 485](#)

Changing the sequence of displayed or printed rows

To change the order in which rows are displayed or printed, use the **Order** field and, optionally, the **A/D** field on the Column Selection/Edit panel. For the most significant column, type "1" in the **Order** field; for the next most significant column, type "2" in the **Order** field, and so on. If you use the **Order** field, rows are displayed in ascending sequence by default. To display the rows in descending sequence, type "D" in the **A/D** field.

If you use either the **Order** or **A/D** fields on the Column Selection/Edit panel, FM/Db2 adds an ORDER BY clause to the SQL SELECT statement used to retrieve the data from Db2®.

For example, on the Column Selection/Edit panel shown in [Figure 38: Primary Column Selection/Edit panel showing row sequence selection on page 100](#), the **Order** and **A/D** fields specify rows to be shown in the sequence LASTNAME (ascending) within WORKDEPT (descending).

Figure 38. Primary Column Selection/Edit panel showing row sequence selection

Process Options Utilities Help									
FM/Db2 (DFG2) Column Selection/Edit Line 1 of 16									
TABLE FMUSER.EMP									
----- Row Selection Criteria ---- (Use SQL/PF4 for full screen edit) -----									
1 Sel: _____ +									
Cmd	Seq	SHEX	CL#	Column name	Data type(length)	Null	Default	Order	A/D
---	---	S	1	EMPNO	CHARACTER(6)		None	---	---
---	---	S	2	FIRSTNME	VARCHAR(12)		None	---	---
---	---	S	3	MIDINIT	CHARACTER(1)		None	---	---
---	---	S	4	LASTNAME	VARCHAR(15)		None	2	A
---	---	S	5	WORKDEPT	CHARACTER(3)	Y	Null	1	D
---	---	S	6	PHONENO	CHARACTER(4)	Y	Null	---	---
---	---	S	7	HIREDATE	DATE	Y	Null	---	---
---	---	S	8	JOB	CHARACTER(8)	Y	Null	---	---
---	---	S	9	EDLEVEL	SMALLINT	Y	Null	---	---
---	---	S	10	SEX	CHARACTER(1)	Y	Null	---	---
---	---	S	11	BIRTHDATE	DATE	Y	Null	---	---
---	---	S	12	SALARY	DECIMAL(9,2)	Y	Null	---	---

Command ==> ----- Scroll PAGE

F1=Help F2=Split F3=Exit F4=SQL F5=RFind F6=RunTemp
 F7=Up F8=Down F9=Swap F10=Left F11=Right F12=Cancel

When the data is displayed, it appears in the revised sequence:

Figure 39. Table Browse panel

Process	Options	Utilities	Help				
FM/Db2 (DFG2)			Table Browse				42 rows fetched
TABLE FMUSER.EMP			Format				TABL
EMPNO	FIRSTNAME	MIDINIT	LASTNAME	WORKDEPT	PHONENO	HIREDATE	JOB
#1	#2	#3	#4	#5	#6	#7	#8 +
CH(6)	VARCHAR(12)	CH(1)	VARCHAR(15)	CH(3)	CH(4)	DATE	CH(8)
PU-->	<---+-----1->	-	<---+-----1----->	<-NF	<->	<---+----->	<---+--
**** Top of data ****							
200340	ROY<	R	ALONZO<	E21	5698	05/05/1947	FIELDR
000340	JASON<	R	GOUNOT<	E21	5698	05/05/1947	FIELDR
000330	WING<		LEE<	E21	2103	02/23/1976	FIELDR
000320	RAMLAL<	V	MEHTA<	E21	9990	07/07/1965	FIELDR
000100	THEODORE<	Q	SPENSER<	E21	0972	06/19/1980	MANAGE
200330	HELENA<		WONG<	E21	2103	02/23/1976	FIELDR
000090	EILEEN<	W	HENDERSON<	E11	5498	08/15/1970	MANAGE
000290	JOHN<	R	PARKER<	E11	4502	05/30/1980	OPERAT
000280	ETHEL<	R	SCHNEIDER<	E11	8997	03/24/1967	OPERAT
200280	EILEEN<	R	SCHWARTZ<	E11	8997	03/24/1967	OPERAT
000310	MAUDE<	F	SETRIGHT<	E11	3332	09/12/1964	OPERAT
000300	PHILIP<	X	SMITH<	E11	2095	06/19/1972	OPERAT
Command ==>						Scroll PAGE	
F1=Help	F2=Zoom	F3=Exit	F4=CRetriev	F5=RFind	F6=RChange		
F7=Up	F8=Down	F9=Swap	F10=Left	F11=Right	F12=Cancel		

Related references

[Column Selection/Edit panel on page 485](#)

Changing column attributes

Attributes are used to determine how to display, print, or create a column.

To change a column attribute, use the Column Selection/Edit panel and enter **E** in the **Cmd** field against one or more columns. For each column you select, FM/Db2 displays a Column Attributes panel.

The attributes you can change are:

- Column heading
- Output width
- Whether to show leading zeros (numeric columns)
- Values to use for creating new columns



Note:

1. For numeric, DATE, TIME, and TIMESTAMP columns, you can change the column heading as for an alphanumeric column.
2. For DATE, TIME, and TIMESTAMP columns, you can change the output width as for an alphanumeric column.
3. For very long columns, change the display width to a smaller value to see more data on the display.

Related tasks

[Changing the attributes for an alphanumeric column on page 102](#)

[Changing the attributes for a numeric column on page 103](#)

Related references

[Column Selection/Edit panel on page 485](#)

[Column Attributes panel \(alphanumeric\) on page 473](#)

[Column Attributes panel \(numeric\) on page 478](#)

[Column Attributes panel \(DATE\) on page 477](#)

[Column Attributes panel \(TIME\) on page 482](#)

[Column Attributes panel \(TIMESTAMP\) on page 483](#)

Changing the attributes for an alphanumeric column

Enter **E** in the **Cmd** field for an alphanumeric column to display the Column Attributes panel. Use this panel to change the heading or width of an alphanumeric column, or to set the pattern if you are creating alphanumeric columns.

Changing the column heading

By default, FM/Db2 uses the column name defined in the Db2® catalog as the column heading. You can change this by editing the template and specifying an alternative column heading in the **Heading** entry field.

The column heading might change the width of the display column. For example, in [Figure 39: Table Browse panel on page 101](#), see how the display changes if you change the heading for the MIDINIT column to the longer heading, "MIDDLE INITIAL":

1. Enter the TEDIT primary command.

FM/Db2 displays the Column Selection Edit panel.

2. On the line for the MIDINIT column, enter **E** in the **Cmd** field.

FM/Db2 displays the Column Attributes panel for the MIDINIT column.

3. Type the new heading, `MIDDLE INITIAL`, in the **Heading** entry field.

4. Press the Exit function key (F3).

FM/Db2 displays the Column Selection/Edit panel.

5. Press the Exit function key (F3) again.

FM/Db2 displays the Template Save panel.

6. Press the RunTemp function key (F6).

FM/Db2 displays the data with the new heading.

Figure 40: Table Browse panel showing width of displayed column changed due to longer heading on page 103 shows how the change of heading has changed the width of the third column from what it was when originally displayed in Figure 39: Table Browse panel on page 101.

Figure 40. Table Browse panel showing width of displayed column changed due to longer heading

Process	Options	Utilities	Help			
FM/Db2 (DFG2)			Table Browse			42 rows fetched
TABLE FMUSER.EMP						Format <u>TABL</u>
EMPNO	FIRSTNAME	MIDDLE INITIAL	LASTNAME	WORKDEPT	PHONENO	HIREDATE
#1	#2	#3	#4	#5	#6	#7
CH(6)	VARCHAR(12)	CHARACTER(1)	VARCHAR(15)	CH(3)	CH(4)	DATE
PU-->	<-----1->	-	<---+---1---	<-NF	<-->	<---+---
**** Top of data ****						
200340	ROY<	R	ALONZO<	E21	5698	05/05/1947
000340	JASON<	R	GOUNOT<	E21	5698	05/05/1947
000330	WING<		LEE<	E21	2103	02/23/1976
000320	RAMLAL<	V	MEHTA<	E21	9990	07/07/1965
000100	THEODORE<	Q	SPENSER<	E21	0972	06/19/1980
200330	HELENA<		WONG<	E21	2103	02/23/1976
000090	EILEEN<	W	HENDERSON<	E11	5498	08/15/1970
:						
Command ==>						Scroll <u>PAGE</u>
F1=Help	F2=Zoom	F3=Exit	F4=CRetriev	F5=RFind	F6=RChange	
F7=Up	F8=Down	F9=Swap	F10=Left	F11=Right	F12=Cancel	

Changing the output width

To change the output width, enter the new width into the **Output width** entry field.

The output width is the number of character positions used by view, edit, browse, and print panels to show the column in TABL display or print format. The default output width is the maximum of the number of characters needed to show the column heading (or column name, if no heading is specified), and the number of characters needed to show the value of the column, as determined from the column definition in the copybook.

The minimum width is six characters. The maximum is 30 or the column width + 10 (whichever is the greater).

Related references

[Column Attributes panel \(alphanumeric\) on page 473](#)

Changing the attributes for a numeric column

Enter **E** in the **Cmd** field for a numeric column to display the numeric Column Attributes panel. Use this panel to change the heading or display attributes of a numeric column, or to set the pattern if you are creating numeric columns.

For numeric columns, you change the column heading as for an alphanumeric column. See [Changing the attributes for an alphanumeric column on page 102](#).

Changing the output width

To change the output width, enter the new width into the **Output width** column. The output width is the number of character positions used by view, edit, browse, and print panels to show the column in TABL display or print format. The default output width is the maximum of the number of characters needed to show the column heading (or column name, if no heading is

specified), and the number of characters needed to show the value of the column, as determined from the column definition in the copybook, including a sign character and decimal point.

The allowable widths are 6 to 32 characters.

Showing leading zeros

To show leading zeros, enter **YES** into the **Leading zeros** column. The default setting is NO (suppress leading zeros). [Figure 41: An example display with leading zeros shown for a column \(SALARY\) on page 104](#) shows the leading zeros shown for SALARY (but not for the other two numeric columns shown).

Figure 41. An example display with leading zeros shown for a column (SALARY)

Process	Options	Utilities	Help			
FM/Db2 (DFG2)				Table Browse	42 rows fetched	
TABLE FMUSER.EMP					Format <u>TABL</u>	
JOB	EDLEVEL	SEX	BIRTHDATE	SALARY	BONUS	COMM
#8	#9	#10	#11	#12	#13	#14
CH(8)	SMINT	CH(1)	DATE	DEC(9,2)	DEC(9,2)	DEC(9,2)
<----->	<---->	-	<----->	<-----1>	<-----1>	<-----1>
**** Top of data ****						
PRES	18	F	08/14/1933	0052750.00	1000.00	4220.00
MANAGER	18	M	02/02/1948	0041250.00	800.00	3300.00
MANAGER	20	F	05/11/1941	0038250.00	800.00	3060.00
MANAGER	16	M	09/15/1925	0040175.00	800.00	3214.00
MANAGER	16	M	07/07/1945	0032250.00	600.00	2580.00
MANAGER	16	F	05/26/1953	0036170.00	700.00	2893.00
MANAGER	16	F	05/15/1941	0029750.00	600.00	2380.00
:						
Command ==>				Scroll <u>PAGE</u>		
F1=Help	F2=Zoom	F3=Exit	F4=CRetriev	F5=RFind	F6=RChange	
F7=Up	F8=Down	F9=Swap	F10=Left	F11=Right	F12=Cancel	

Related references

[Column Attributes panel \(numeric\) on page 478](#)

ROWID columns

You can use ROWID columns to create a unique index for tables that have no obvious unique index column or columns.

After a row has been inserted, you cannot update the data in a ROWID column. You can only specify a ROWID value on insert operations for ROWID columns defined as GENERATED BY DEFAULT. See the *DB2 for z/OS SQL Reference*.

When FM/Db2 generates the template for a table containing a ROWID column, the ROWID column is deselected and is not initially displayed in a File Manager/Db2 editor session.

Specifying scrambling options

Scrambling data allows you to create test data based on production (or "live") data, but with the ability to change the values of certain columns.

When you use the Copy Utility (option 3.3), Import Utility (option 3.6), or Export Utility (option 3.7), you can choose to scramble some or all of the columns being copied. You specify the columns you want scrambled by marking those columns for scrambling in the output template.

You mark a column for scrambling by setting the scrambling options for that column in the template.

You can specify or change scrambling options on the Column Attributes panel. The panel comes in two flavors: one for alphanumeric columns and the other for numeric columns.

[Selecting a column for specifying scrambling options on page 105](#)

[Scrambling data on page 286](#)

[Column Attributes panel \(alphanumeric\) on page 473](#)

[Column Attributes panel \(numeric\) on page 478](#)

[Value List Edit panel on page 867](#)

[Scramble Exit Specification panel on page 780](#)

Selecting a column for specifying scrambling options

You select a column from the Column Selection/Edit panel. To select a column for specifying scrambling options, enter **E** in the **Cmd** field adjacent to the required column. You can enter E against as many columns as you like. For each column you select, File Manager displays a Column Attributes panel.

After you have updated the scrambling options for a column (or any of the other column attributes), when you return to the Column Selection/Edit panel you will see an "E" for that column in the E column (under the "SHEX" heading) indicating that the attributes for that column have changed.

The scrambling options you can specify are:

- Scramble type
- Value option
- Value input column
- Value output column
- Minimum and maximum values for a numeric range
- Value data set name

The scrambling options determine how the input data is scrambled (if at all) when it is copied, imported or exported.

Related topics

[Specifying the scramble type on page 105](#)

[Specifying the value option on page 106](#)

[Specifying value input and out columns on page 107](#)

[Specifying range values on page 108](#)

[Specifying a value data set name on page 108](#)

[Specifying and editing a value list on page 108](#)

Specifying the scramble type

The **Scramble Type** option determines how data is scrambled when it is copied, imported, or exported.

Set the scramble type to one of these values:

Blank

Data is not scrambled.

1 ("Random")

Data scrambled to produce a random output value on each invocation.

2 ("Repeatable")

Data scrambled to produce the same output value on each invocation.

3 ("Translate")

Data scrambled using input and output values held in the value data set (specified in the **Dsn** field).

This option requires you to select the **Value** option with an input and output column (**In** and **Out**) and value data set name (**Dsn**). All records in the translate data set are loaded into memory for the copy operation. The input and output columns provide the location of the input and output field values as stored in the data set. Their lengths are determined by the respective input and output columns that have been mapped for the copy, import, or export operation. If a matching input column value is found, then the corresponding output column value is obtained from the matching record. If no match is found, then the column is initialized to zero, or the value determined by the data create attributes.

4 ("Exit")

Data scrambled using a scrambling exit (as specified on a separate panel). For details about writing a scrambling exit, see the *File Manager Customization Guide*.

Related topics

[Specifying the value option on page 106](#)

[Specifying value input and out columns on page 107](#)

[Specifying range values on page 108](#)

[Specifying a value data set name on page 108](#)

Specifying the value option

The **Value** option and corresponding fields control the output of the scrambling process.

The way in which you select, or specify, this option differs according to whether the associated column is alphanumeric or numeric:

- For alphanumeric column, do one of these:
 - Deselect the **Value** option by entering a blank.
 - Select the **Value** option by entering a "/".
- For numeric columns, do one of these:

- Deselect the **Value** option by entering a blank.
- Select a range by entering "1".
- Select the **Value** option by entering "2".

Value option selected ("/")

Selecting this option allows you to provide:

- **A translate data set.** This applies when you select **Scramble Type** 3 ("Translate") with input and output columns and a value data set.
- **A lookup data set.** This applies when you select a **Scramble Type** of 1 ("Random") or 2 ("Repeatable") along with a value data set name. The data set is loaded into memory and the output value is randomly or repeatably selected from one of the loaded records. The output column determines the location of the value that is selected for this column.
- **A value list.** This applies when you select a **Scramble Type** of 1 ("Random") or 2 ("Repeatable") *without* a value data set name and allows you to enter the selection values for this column on the panel displayed when you press Enter. One of the values you provide is randomly or repeatably selected during a copy, import, or export operation. The values you enter are stored in the template. Value lists are described in more detail later.

Value option deselected (blank)

Deselecting this option scrambles the input column to produce a random or repeatable output value. **Scramble Type** must be set to 1 ("Random") or 2 ("Repeatable").

Specifying value input and out columns

The input column field (**In**) defines the start location of the input field value on the value data set and is used when the translate process is run during a copy, import, or export operation to match the input column with a value on the value data set. The length of the field is set to the length of the input column that is mapped to this column during the copy, import, or export process.



Note: This value is only required when you select **Scramble Type** 3 ("Translate").

The output column field **Out** defines the start location of the output field value on the value data set and is used in these ways during a copy operation:

- **Translate.** If an input column value is matched on the value data set, then the corresponding output value is used.
- **Random** or **Repeatable.** The input value is used to randomly, or repeatably, select an output value from the value data set.



Note: This value is required when you select **Scramble Type** 3 ("Translate").



If you select **Scramble Type 1** ("Random") or 2 ("Repeatable"), and you have also selected the **Value** option, then the output column defaults to 1 if you have specified a value data set name (**Dsn**).

Specifying range values

When you are specifying scramble options for a numeric column, you can specify a range of values from which the resultant scrambled value is to be selected.

You specify the minimum value of the range in the **Min** field and the maximum value of the range in the **Max** field.

You can only select the range option with random and repeatable scrambling. The output value is randomly or repeatably selected from a number within the specified range.

Specifying a value data set name

The output data set name field **Dsn** field defines the value data set. It can be any cataloged sequential, partitioned or VSAM data set containing data that is used to determine the output column value during a copy, import, or export process.

If you select **Scramble Type 3** ("Translate"), then the data set must contain the input and output values in the locations provided in the input and output columns.

If you select **Scramble Type 1** ("Random") or 2 ("Repeatable"), then the data set must contain the output value in the locations provided in the output column.



Notes:

1. This field is required when you select **Scramble Type 3** ("Translate"). If you select **Scramble Type 1** ("Random") or 2 ("Repeatable"), and also select the **Value** option, then you can optionally provide a data set name. If you leave this field blank having selected the **Value** option, you are prompted to enter the value list to be stored in the template.
2. The value data set record length must be greater than or equal to the field length.

Specifying and editing a value list

A value list is a list of values which is used in conjunction with the scrambling options to select a value with which a column is populated during a copy, import, or export operation. When the output column is being populated, one of the values in this list is selected. Scrambling options combine the originating value with the random or repeatable seed to select a value from the list.

For random and repeatable scrambling, you can specify a value list inline by leaving the value data set field (**Dsn**) blank and selecting the **Value** option.

To edit the related value list, select the **Value** option and press Enter. FM/Db2 displays the Value List Edit panel.

The values you provide must be valid for the corresponding data type. Deleting a value list turns off the value list option on the previous panel.

To enter hexadecimal values, use the X'hhhh' format:

```
x'C1C2C3'
```

To provide leading blanks or a blank value, use a quoted string:

```
' SMITH'
```

Blank value lines (no quotation marks) are ignored.

Use the FIND and LOCATE commands to bring a value containing or starting with a given string to the current line.

You can use prefix commands to copy, insert, move, repeat or delete lines.

To save the values, press F3. To ignore changes, press Cancel.

Related topics

[Value List Edit panel on page 867](#)

Mapping data

Mapping tells FM/Db2 how you want columns transferred from an old table to a new table. You can set up mapping so that, in the extreme case, a column is copied to a column of a different name, with a different length, and with a different, but compatible, data type. Most mappings are more straightforward.

Other types of mapping supported by FM/Db2 include:

- Mapping the columns of one table to another.

You can use this type of mapping with the FM/Db2 Copy utility.

- Mapping the columns of a table to the fields in a file.

You can use this type of mapping with the FM/Db2 Export utility and the Db2® UNLOAD utility.

- Mapping the fields in a file to the columns of a Db2® table.

You can use this type of mapping with the FM/Db2 Import utility and the Db2® LOAD utility.

Where you can map data

You can use templates to map data with the following FM/Db2 functions:

- Copy (option 3.3)
- Import (option 3.6)

- [Export \(option 3.7\)](#)
- [Utilities \(option 3.9\)](#)

Related tasks

- [Copying data from one Db2 object to another on page 241](#)
- [Copying data from a VSAM or QSAM file on page 246](#)
- [Copying data to a VSAM or QSAM file on page 274](#)
- [LOAD utility on page 349](#)

Letting FM/Db2 do the mapping

If you want, you can use FM/Db2 to set up the mappings. This happens automatically if you do not select the **Edit template mapping** on the Copy “To” panel. If no mapping exists in the “To” template, FM/Db2 performs a corresponding move by going through the following two steps:

1. Generates mappings based on column names. That is, columns in the “From” template are mapped to like-named columns in the “To” template. FM/Db2 provides mappings for as many columns as it can in this way.
2. For the remaining “unmatched” columns in the “From” template (if any), FM/Db2 generates mapping based on data attributes:
 - FM/Db2 compares the attributes of the first unmatched column in the “From” template with the attributes of the first unmatched column in the “To” template. If the attributes of the two columns are the same, FM/Db2 generates mapping between the two columns.
 - FM/Db2 repeats the preceding step with the next pair of unmatched columns in the two templates until either it has generated mapping for all the columns in the “From” template, or if it finds the attributes of the two columns do not match.

Related references

- [Copy Utility \(“To”\) panel on page 506](#)
- [Import Utility \(“To”\) panel on page 694](#)
- [Export Utility \(“To”\) panel on page 676](#)
- [LOAD from panel on page 704](#)
- [UNLOAD Utility \(Tables\) “To” panel on page 861](#)

Specifying your own mapping

If you want to set up your own mappings, indicate that you want to edit the “To” template by selecting the **Edit template mapping** option on the “To” panel for the relevant FM/Db2 function. If you select this option, FM/Db2 displays the Template Mapping panel (see [Figure 42: Template Mapping panel on page 111](#)).

Figure 42. Template Mapping panel

Process		Options	Utilities	Help				
FM/Db2 (DFG2)		Template Mapping						
To	FMUSER.EEMP							
From	FMUSER.EEMP							
Cmd	CL#	To Column name	Datatype	NI	CL#	From Column name	Datatype	NI
		**** Top of data ****						
---	1	EMPNO	CH(6)	NN	1	EMPNO	CH(6)	NN
---	2	FIRSTNME	VC(12)	NN	2	FIRSTNME	VC(12)	NN
---	3	MIDINIT	CH(1)	NN	3	MIDINIT	CH(1)	NN
---	4	LASTNAME	VC(15)	NN	4	LASTNAME	VC(15)	NN
---	5	WORKDEPT	CH(3)		5	WORKDEPT	CH(3)	
---	6	PHONENO	CH(4)		6	PHONENO	CH(4)	
---	7	HIREDATE	DATE		7	HIREDATE	DATE	
---	8	JOB	CH(8)		8	JOB	CH(8)	
---	9	EDLEVEL	SMINT		9	EDLEVEL	SMINT	
---	10	SEX	CH(1)		10	SEX	CH(1)	
---	11	BIRTHDATE	DATE		11	BIRTHDATE	DATE	
---	12	SALARY	DEC(9,2)		12	SALARY	DEC(9,2)	
---	13	BONUS	DEC(9,2)		13	BONUS	DEC(9,2)	
---	14	COMM	DEC(9,2)		14	COMM	DEC(9,2)	
S	15	RID	CH(4)					
---	16	TSTAMP	TIMESTAMP					
		**** End of data ****						
Command		===>			Scroll PAGE			
F1=Help	F2=Split	F3=Exit	F4=CRetriev	F5=RFind	F6=RunTemp			
F7=Up	F8=Down	F9=Swap	F12=Cancel					

Note that, in [Figure 42: Template Mapping panel on page 111](#), there is no “From” columns against the “To” columns RID and TSTAMP. This shows that, for these two columns in the “To” template, there is no corresponding column in the “From” template. When the table is copied, FM/Db2 creates new values in RID and TSTAMP.

Related references

- [Template Mapping panel on page 850](#)
- [Copy Utility \(“To”\) panel on page 506](#)
- [Import Utility \(“To”\) panel on page 694](#)
- [Export Utility \(“To”\) panel on page 676](#)
- [LOAD from panel on page 704](#)
- [UNLOAD Utility \(Tables\) “To” panel on page 861](#)

Setting up mapping for a column

To set up or change the mapping for a column, enter **s** in the **Cmd** field against the column name. The From Column Mapping panel is displayed.

Figure 43. From Column Mapping panel

```

Process  Options  Utilities  Help
-----
FM/Db2 (DFG2)                From Column Mapping
To Db2 object . . : DSN8810.EEMP
From Db2 object . . : DSN8810.EMP
To column . . . . : #15 RID
From column . . . . :

Sel  Cl#  From Column          Data Type(length)
----  ---  -
      D  Delete "From column"
      1  EMPNO                CHARACTER(6)
      2  FIRSTNME             VARCHAR(12)
      3  MIDINIT           CHARACTER(1)
      4  LASTNAME          VARCHAR(15)
      5  WORKDEPT          CHARACTER(3)
      S_ 6  PHONENO              CHARACTER(4)
      7  HIREDATE          DATE
      8  JOB                CHARACTER(8)
      9  EDLEVEL           SMALLINT
      10 SEX                CHARACTER(1)
Command ===>
F1=Help      F2=Split      F3=Exit      F4=CRetriev  F7=Up        Scroll PAGE
F9=Swap      F12=Cancel

```

In [Figure 43: From Column Mapping panel on page 112](#), the information at the top of the panel shows you the current mapping. In the figure, the **To column** is RID. There is currently no **From column** shown because there is no column in the “From” template with the same name.

To *change* the “From” column, enter **s** against the new “From” column. The information at the top of the panel changes immediately to reflect the new mapping. For example, if you enter **s** against column #6 (PHONENO), the information at the top of the panel changes:

```

;
FM/Db2 (DFG2)                From Column Mapping
To Db2 object . . : DSN8810.EEMP
From Db2 object . . : DSN8810.EMP
To column . . . . : #15 RID
From column . . . . : #6 PHONENO

```

and the Template Mapping panel also changes to show that PHONENO is mapped to RID:

```

;
FM/Db2 (DFG2)                Template Mapping
To          FMNUSER.EEMP
From        FMNUSER.EEMP

Cmd CL#  To Column name  Datatype  NI  CL#  From Column name  Datatype  NI
----  ---  -
      1  EMPNO            CH(6)     NN  |  1  EMPNO            CH(6)     NN
:
      12 SALARY         DEC(9,2)  |  12 SALARY         DEC(9,2)
      13 BONUS          DEC(9,2)  |  13 BONUS          DEC(9,2)
      14 COMM           DEC(9,2)  |  14 COMM           DEC(9,2)
      15 RID            CH(4)     |  6  PHONENO        CH(4)
      16 TSTAMP         TIMESTAMP
      **** End of data ****
Command ===>
F1=Help      F2=Split      F3=Exit      F4=CRetriev  F5=RFind     Scroll PAGE
F7=Up        F8=Down      F9=Swap      F12=Cancel   F6=RunTemp

```

There is now an entry in the “From” column against RID.

To *remove* the current mapping for a “To” column, enter **s** against **Delete “From column”** on the From Column Mapping panel for that column. For example, the Template Mapping panel shown in [Figure 42: Template Mapping panel on](#)

page 111 shows that the “To” column BONUS is mapped to the “From” column BONUS. To remove the mapping for BONUS (so that it is not mapped to any “From” column):

1. On the Template Mapping panel shown in [Figure 42: Template Mapping panel on page 111](#), enter S in the **Cmd** field against column #13 (BONUS).

The From Column Mapping panel is displayed as shown in [Figure 44: From Column Mapping panel showing Delete “From column” selected on page 113](#).

2. Enter S against **Delete “From column”**.

Figure 44. From Column Mapping panel showing **Delete “From column”** selected

```

  Process  Options  Utilities  Help
  -----
  FM/Db2 (DFG2)                From Column Mapping
  To Db2 object . . . : DSN8810.EEMP
  From Db2 object . . . : DSN8810.EMP
  To column . . . . . : #13 BONUS
  From column . . . . . : #13 BONUS

  Sel  Cl#  From Column          Data Type(length)
  ----  ---  -
  S__   D   Delete "From column"
  ----  ---  -
  1     EMPNO             CHARACTER(6)
  ----  ---  -
  2     FIRSTNME          VARCHAR(12)
  ----  ---  -
  3     MIDINIT           CHARACTER(1)
  ----  ---  -
  4     LASTNAME          VARCHAR(15)
  ----  ---  -
  5     WORKDEPT          CHARACTER(3)
  ----  ---  -
  6     PHONENO           CHARACTER(4)
  ----  ---  -
  7     HIREDATE          DATE
  ----  ---  -
  8     JOB               CHARACTER(8)
  ----  ---  -
  9     EDLEVEL           SMALLINT
  ----  ---  -
  10    SEX               CHARACTER(1)
  ----  ---  -
  11    BIRTHDATE         DATE
  ----  ---  -
  12    SALARY            DECIMAL(9,2)
  ----  ---  -
  13    BONUS             DECIMAL(9,2)
  ----  ---  -
  14    COMM              DECIMAL(9,2)
  ----  ---  -
  ***** End of data *****

  Command ==> ----- Scroll PAGE
  F1=Help   F2=Split   F3=Exit    F4=CRetriev F7=Up      F8=Down
  F9=Swap   F12=Cancel

```

3. Press Enter.

The “From column” mapping information (fourth line on the From Column Mapping panel) for BONUS is displayed.

Figure 45. From Column Mapping panel showing **From column** mapping information deleted

Process	Options	Utilities	Help
FM/Db2 (DFG2) From Column Mapping			
To Db2 object . . : DSN8810.EEMP			
From Db2 object . . : DSN8810.EMP			
To column : #13 BONUS			
From column :			
SEL	CL#	From Column	Data Type(length)
**** Top of data ****			
----	D	Delete "From column"	
----	1	EMPNO	CHARACTER(6)
----	2	FIRSTNME	VARCHAR(12)
----	3	MIDINIT	CHARACTER(1)
----	4	LASTNAME	VARCHAR(15)
----	5	WORKDEPT	CHARACTER(3)
----	6	PHONENO	CHARACTER(4)
----	7	HIREDATE	DATE
----	8	JOB	CHARACTER(8)
----	9	EDLEVEL	SMALLINT
----	10	SEX	CHARACTER(1)
----	11	BIRTHDATE	DATE
----	12	SALARY	DECIMAL(9,2)
----	13	BONUS	DECIMAL(9,2)
----	14	COMM	DECIMAL(9,2)
**** End of data ****			
Command ==>			
F1=Help	F2=Split	F3=Exit	F4=CRetriev F7=Up
F9=Swap	F12=Cancel		F8=Down

4. Press the Exit function key (F3).

The Template Mapping panel is displayed showing the "To" column BONUS is now not mapped to any "From" column.

Figure 46. Template Mapping panel showing the "To" column BONUS not mapped to any "From" column

FM/Db2 (DFG2)	Template Mapping							
To	FMUSER.EEMP							
From	FMUSER.EMP							
Cmd	CL#	To Column name	Datatype	NI	CL#	From Column name	Datatype	NI
**** Top of data ****								
----	1	EMPNO	CH(6)	NN	1	EMPNO	CH(6)	NN
:								
----	12	SALARY	DEC(9,2)		12	SALARY	DEC(9,2)	
----	13	BONUS	DEC(9,2)					
----	14	COMM	DEC(9,2)		14	COMM	DEC(9,2)	
----	15	RID	CH(4)		6	PHONENO	CH(4)	
----	16	TSTAMP	TIMESTAMP					
**** End of data ****								
Command ==>								
F1=Help	F2=Split	F3=Exit	F4=CRetriev	F5=RFind	F6=RunTemp			
F7=Up	F8=Down	F9=Swap	F12=Cancel					



Note: Db2® determines the default value for an unmapped column according to the definition of the column in the Db2® catalog.

Changing the attributes for a "To" column

To change the attributes for a "To" column, enter **E** against the column name on the Template Mapping panel (Figure 42: [Template Mapping panel on page 111](#)) to display the Column Attributes panel.

Related tasks

[Changing column attributes on page 101](#)

Creating data for a column

If no mapping exists for a “*To*” column, and FM/Db2 is unable to match it to a “*From*”, FM/Db2 creates data for the column.

Related tasks

[Mapping data on page 109](#)

Mapping using different templates

The mapping relationship is stored in the “*To*” template. The mapping information is the column number and the column name. If you reuse a template to copy, import, export, or load data, the mapping information is checked. FM/Db2 ensures that the column in the specified position has the specified name. If this is not the case, FM/Db2 indicates that the mapping has broken down, and gives you the option of either terminating the FM/Db2 function, or updating the mapping information in the “*To*” template.

This means that you can use a template that is different from the “*From*” template you used to set up the mapping, provided that the structure of the new template does not differ from the structure of the old template. That is, no columns that have been used in the mapping are in a different position or have a different name. The new “*From*” template can, however, have different selection conditions.

You can also use a “*To*” template as a “*From*” template. However, in this case, the mapping information is not relevant.

Mapping contiguous columns

If you need to map contiguous columns, you might find it more convenient to use the SS, *Sn*, or S* commands.

If you select more than one column at a time, FM/Db2 displays the From Column Mapping panel for the next selected column each time you press the Exit function key (F3). If you are viewing the From Column Mapping panel for the last selected field and press the Exit function key (F3), File Manager returns you to the Template Mapping panel.

Related tasks

[Toggling the selection status of more than one column at a time on page 96](#)

Related references

[From Column Mapping panel on page 684](#)

[Template Mapping panel on page 850](#)

Column mapping rules

FM/Db2 uses the rules shown in [Table 2: Column mapping rules on page 116](#) to determine if a given “*From*” column can be mapped to a given “*To*” column. “*Yes*” indicates that the mapping is valid. “*No*” indicates that the mapping is not valid.



Note: If mapping, you cannot select a “From” column with a data type that is incompatible with the data type of the “To” column. For example, [Figure 44: From Column Mapping panel showing Delete “From column” selected on page 113](#) shows the two DATE “From” columns, HIREDATE and BIRTHDATE, as un-selectable for mapping to the numeric “To” column, BONUS.

Table 2. Column mapping rules

“From” column	“To” column				
	DATE	TIME	TIMESTAMP	Character	Numeric
DATE	Yes	No	No	Yes	No
TIME	No	Yes	No	Yes	No
TIMESTAMP	Yes ³	Yes ⁴	Yes ⁵	Yes	No
Character ⁶	Yes ⁷	Yes ⁷	Yes ⁷	Yes	Yes ⁸
Numeric ⁹	No	No	No	No	Yes

These rules describe how a validly mapped “From” column is moved to a “To” column. If the “To” column is:

3. Conversion of TIMESTAMP data type to DATE data type results in truncation of time value. Data type conversion is not supported where the Db2® installation-defined format for dates is LOCAL.
4. Conversion of TIMESTAMP data type to TIME data type results in truncation of date and microsecond values. Data type conversion is not supported where the Db2® installation-defined format for time is LOCAL.
5. Conversion between unlike TIMESTAMP data types may result in loss of precision, or padding with zeroes in the fractional part of the second. Similarly the time zone information may be lost, or the default time zone for the current server may be added. For example:

```

TIMESTAMP(4)          ->    TIMESTAMP(10)
2012-12-02-12.34.56.1234      2012-12-02-12.34.56.1234567890

TIMESTAMP(4) WITH TIME ZONE  ->    TIMESTAMP(0)
2012-12-02-12.34.56.1234-12:00    2012-12-02-12.34.56
    
```

6. The category “character” includes CHAR and VARCHAR data types.
7. Character value must be in a valid format, depending on the Db2® installation-defined formats for date and time, otherwise the “To” column is set to the default value as specified by data create attributes. If the Db2® installation-defined format for dates or time is LOCAL, FM/Db2 is unable to validate the “From” column before inserting it into the “To” column.
8. The “From” column must consist only of numeric characters, and is treated as a numeric column.
9. The category “numeric” includes DECIMAL, NUMERIC, SMALLINT, INTEGER, REAL, DOUBLE, DOUBLE PRECISION, FLOAT, and DECFLOAT data types.

DATE

If the "From" column has a data type of `TIMESTAMP`, only bytes 1–4 of the "From" column are moved to the "To" column; otherwise, the full four bytes of the "From" column are moved to the "To" column.

TIME

If the "From" column has a data type of `TIMESTAMP`, only bytes 5–7 of the "From" column are moved to the "To" column; otherwise, the full three bytes of the "From" column are moved to the "To" column.

TIMESTAMP

When the data types of the "FROM" and "TO" columns are identical all bytes of the "From" column are moved to the "To" column.

When the precision and `TIME ZONE` components of the "FROM" and "TO" columns are different:

- Excess digits are lost in the fraction part of the second when the precision of the "FROM" column is greater than the precision of the "TO" column.
- The fractional part of the second is padded on the right with zeroes when the precision of the "FROM" column is less than the precision of the "TO" column.
- `TIME ZONE` information is lost when the "FROM" column includes a `TIME ZONE` and the "TO" column does not.
- `TIME ZONE` information is added when the "FROM" column does not include a `TIME ZONE` and the "TO" column does.

Character

The data is aligned at the leftmost character position and, if necessary, truncated or padded with spaces at the right.

If the "From" column is a numeric column, the absolute (unsigned) value is used. If the column is defined as signed and the sign occupies a separate character, that character is not moved, and the sending item is considered to be one less character than the actual size.

Integer or packed

The data is aligned on the assumed decimal point and, if necessary, truncated or padded with zeros. If an assumed decimal point is not explicitly specified in the column definition, one is assumed immediately to the right of the column.

If the "From" column is numeric, the data is moved as if both the "From" column and "To" column were described as signed.

If the "From" column is alphanumeric, the data is moved as if the "From" column were described as a signed numeric.

Internal floating-point

A decimal point is assumed immediately to the left of the column. The data is aligned on the leftmost digit position following the decimal point, with the exponent adjusted accordingly.

External floating-point

The data is aligned on the leftmost digit position, and the exponent adjusted accordingly.

Related tasks

[Changing column attributes on page 101](#)

Creating a copybook from a File Manager/Db2 Template

FM/Db2 provides a sample REXX exec (FMN2CPYB) that you can use to create a PL/I or COBOL copybook from a File Manager/Db2 template.

To run the exec:

1. Copy FMN2CPYB from the sample library SFMNSAM1 to a REXX library allocated to your TSO session (for example, SYSPROC or SYSEXEC).
2. Issue the statement:

```
FMN2CPYB input_file output_file copybook_type
```

Where:

input_file

The name of a File Manager/Db2 template. This is typically a member of a partitioned data set.

output_file

The name of an LRECL=80 sequential file, or member of a partitioned data set. The output file contains the copybook derived from the template. Any existing data in the sequential file or member is overwritten.

copybook_type

This parameter is optional. It specifies the type of copybook to be produced. Valid values are:

COBOL

COBOL copybook created.

PLI

PL/I copybook created.

Chapter 5. Viewing and changing Db2® data

To view the contents of a Db2® table or view, use the FM/Db2 View Utility (option 1), the FM/Db2 Edit Utility (option 2), or the FM/Db2 Browse Utility (option B).

The following instructions are given in the context of the FM/Db2 editor. In most cases you can perform these actions in View, Edit, or Browse, in which case the term "editor" is used. Similarly, the term "FM/Db2 editor session" can indicate either a View editor session, an Edit editor session, or a Browse editor session.

FM/Db2 View Utility

The FM/Db2 View Utility (option 1) allows you to view and temporarily change data, but without the ability to save any changes.

When you initiate the FM/Db2 editor with the View Utility, this is referred to as being in a "View editor session" (or just "View").

The FM/Db2 View Utility, similar to ISPF view, provides a File Manager/Db2 editor session that works essentially the same as the Edit Utility. It presents you with an interface that is capable of holding your temporary changes to data. This may be useful, for example, for assessing a change but without any risk of altering live data. The first time you make a change to the data in a View editor session, FM/Db2 displays the following warning:

Save is not possible in a View session. Use Edit if you want to be able to save changes.

When you exit from a View editor session by pressing the Exit function key (F3), if you have made a change to the data in the FM/Db2 editor session, FM/Db2 displays a warning as shown in [Figure 47: Warning displayed when exiting from a View session after data changes on page 119](#).

Figure 47. Warning displayed when exiting from a View session after data changes

```
Process  Options  Utilities  Help
-----  -
F          View Warning
T
          You are currently in Data View mode:
          Press Enter to confirm exit from View.  No changes will be
          saved.
          Enter the END or EXIT command to return to View.
*
0
0
0
0
0
0
0
0
0
0
000007 000090 EILEEN<    W    HENDERSON<    E11    5498
000008 000100 THEODORE<  Q    SPENSER<    E21    0972
000009 000110 VINCENZO< G    LUCCHESI<    A00    3490
Command ===>
          F1=Help      F2=Zoom      F3=Exit      F4=CRetrieve  F5=RFind      F6=RChange
          F7=Up        F8=Down     F9=Swap     F10=Left     F11=Right    F12=Cancel
          Top of 42
          Format TABL
          O HIREDATE
          #7
          DATE
          <----+---->
          01.01.1965
          10.10.1973
          05.04.1975
          17.08.1949
          14.09.1973
          30.09.1980
          15.08.1970
          19.06.1980
          16.05.1958
          Scroll PAGE
```

FM/Db2 Edit Utility

The FM/Db2 Edit Utility (option 2) allows you to view and change your data (by inserting, deleting and otherwise modifying the contents of a Db2® table or view), and save any changes you make.

When you initiate the FM/Db2 editor with the Edit Utility, this is referred to as being in an "Edit editor session" (or just "Edit").

FM/Db2 Browse Utility

The FM/Db2 Browse Utility¹⁰ (option B) allows you to view data, but without the ability to save any changes.

When you start up the FM/Db2 editor in browse mode, this is referred to as being in a "Browse editor session" (or just "Browse").

To start up a Browse editor session, perform one of these actions:

- From the Primary Option Menu panel, enter the **B** command.
- When you are in a File Manager/Db2 editor session, enter the **BROWSE** command.
- From a list of Db2® objects, where it is legitimate to do so, enter the **B** command.

When you start up a Browse editor session, FM/Db2 displays the Db2® Browse entry panel.

Related references

[Working with lists of Db2 objects on page 297](#)

[Table Browse panel on page 824](#)

[Table Edit panel on page 826](#)

[Table View panel on page 837](#)

[Db2 Browse panel on page 595](#)

[BROWSE primary command on page 872](#)

FM/Db2 editor sessions

This topic tells you how to start and end a File Manager/Db2 editor session, and explains some of the possibilities, such as specifying "*normal mode*" or "*large mode*", and validating and saving changes.

Starting a File Manager/Db2 editor session

To start a File Manager/Db2 editor session, select one of these options from the Primary Option Menu panel:

1 View

Displays the Db2® View panel.

2 Edit

Displays the Db2® Edit panel.

B Browse

Displays the Db2® Browse panel.



Note: The View and Browse options do not allow you to save any changes you make to the data.

Related references

10. For consistency with ISPF, the FM/Db2 Browse utility does not appear on the FM/Db2 main menu. You can, however, select the FM/Db2 Browse utility by typing the B command.

[Primary Option Menu panel on page 728](#)

[Db2 View panel on page 613](#)

[Db2 Edit panel on page 598](#)

Specifying the editor session mode: "normal mode" or "large mode"

The FM/Db2 editor can operate in either "normal mode" or "large mode".

Normal mode

To operate the FM/Db2 editor session in "normal mode", enter a value *other than* 0, *, or ALL in the **Row count** field on the editor entry panel.

The FM/Db2 editor retrieves rows from the Db2® object and loads them into the editor until one of these conditions occurs:

- The end of the Db2® object is reached.
- The number of rows loaded into the editor equals the value specified in the **Row count** field.
- Available storage is exhausted.

For information about the amount of storage used by the FM/Db2 editor to store each row, see [Storage considerations on page 135](#).

For information about limiting the number of rows loaded into an editor session, see [Restricting the rows to view by specifying row selection criteria on page 136](#).

Large mode

To operate the FM/Db2 editor session in "large mode", enter 0, *, or ALL in the **Row count** field on the editor entry panel. The FM/Db2 editor retrieves rows from the Db2® object and loads them into the editor until one of these conditions occurs:

- The end of the Db2® object is reached.
- Approximately three screen's worth of rows has been loaded.

The number of rows displayed on the editor data panel (in tabular format) depends on the terminal emulation settings (24x80, 27x132, 40x132, and so on) and also the number of optional columns headers.

In "large mode", the FM/Db2 editor keeps only enough rows in memory to satisfy the current display requirements. You can scroll up or down as required to see all rows of the Db2® object.

In an Edit session in "large mode", the FM/Db2 editor also keeps any rows that have been changed in memory, regardless of the current display position. This can increase the storage requirement for the Edit session substantially if many rows are changed. For more information about limiting the number of rows loaded into an editor session, see [Restricting the rows to view by specifying row selection criteria on page 136](#).

Choosing the appropriate editor mode

The two editor modes, "normal mode" and "large mode", have different characteristics as outlined in [Table 3: Characteristics of editor modes on page 122](#). In most cases, you can use either mode to process a Db2® object.

Table 3. Characteristics of editor modes

	"Normal mode"	"Large mode"
Storage usage	Directly dependent on number of rows loaded, processing objects with large numbers of rows requires very large TSO region size, or not possible.	Independent of number of rows in the Db2® object. Storage use increases as rows in the object are changed.
Db2® requirements	Initial data load occurs quickly for small Db2® objects, more slowly as the size of the object increases. Once loaded scrolling within the Db2® object is very fast.	Initial data load occurs quickly for small Db2® objects, significantly more slowly as the size of the object increases. Once loaded, scrolling to nearby locations is fast, scrolling to distant locations may be slow.
Auto commit feature	Available.	Not available. If selected the auto commit option is disabled. The first attempt to auto commit data changes displays a warning message.
Data visibility	Once loaded, the data in the editor session is static and does not change, even if other processes alter the data.	When an <i>insensitive cursor</i> is used, the data displayed in the editor session is static and does not change, even if other processes alter the data. When a <i>sensitive cursor</i> is used, the data displayed in the editor session might change if other processes delete or update rows. Rows inserted by other processes are not visible.
Moving rows ¹¹	Allowed.	Prohibited.



Note: For a description of *insensitive cursor* and *sensitive cursor*, see [Editor Options \(2 of 8\) panel on page 630](#).

11. "Moving a row" means any operation that changes the *relative* position of a row. These operations are:

- Inserting a new row, or group of rows.
- Repeating a row, or group of rows.
- Moving a row, or group or rows.
- Copying a row, or group of rows to a new position.

All of these operations are prohibited in "large" editor mode.

Deleting a row or group of rows is supported in "large" editor mode, since the deleted rows are marked in the editor session with a special marker, and hence the relative position of the rows does not change.

Table 3. Characteristics of editor modes (continued)

	"Normal mode"	"Large mode"
Sort command	Allowed.	Prohibited.
Row size	No restriction	Row size must not exceed the maximum page size (32704) less 16 bytes. When this limit is exceeded, the editor session reports SQLCODE-670 stating: "The record length of the table exceeds the page size limit". This is because large mode uses a Db2® scrollable cursor, for which each row requires an additional 16 bytes. If you get SQLCODE-670 use "Normal mode" to view and update the Db2® table.

Specifying the start position for your FM/Db2 editor session

You can load rows from the Db2® object being processed starting at the first row, or you can start at some other point.

The **Start position** entry field on the editor entry panel specifies the required start position. The default is 1.

When the FM/Db2 editor is operating in "normal mode", the editor session contains rows starting at the specified start position. The total number of rows loaded is either the value specified in **Row count**, or some lesser number if the end of the Db2® object was encountered before the required number of rows were loaded. You cannot scroll up to see the rows that were skipped.

When the FM/Db2 editor is operating in "large mode", the editor session initially contains rows starting at the specified start position. You can scroll up to see rows prior to the start position, as far as the first row of the Db2® object if required.

Usage Note: You can use the **Start position** value to limit the rows loaded in the editor session, or to start midway through a Db2® object. For example, if you have a large table of, say, a million rows containing people's names ordered by surname and you were only interested in names starting with S, you could enter a start value of, say, 700,000 assuming you knew this is the approximate start position for surnames starting with "S".

Setting options for the current FM/Db2 editor session

To set options for the current FM/Db2 editor session, display the first of the seven Editor Options panels by entering one of the values shown here against **Edit options** on the Db2® View or Db2® Edit panel:

A “,” or an “A”

Displays the first FM/Db2 Editor Options panel, prior to displaying the data for the Db2® object being processed. When the first Editor Options panel is displayed, you can navigate to one or more of the other Editor Options panels.

Usage Note: Entering an "A" in an option field changes the behavior of the dialog so that the Editor Options panel is ALWAYS displayed. Use the "/" character when you only need to refer to the editor options on a single occasion. The "/" is cleared after the option is processed returning the dialog to the default behavior, which is to NOT show the various Editor Options panels.

A number in the range 1–8

Displays the *n*th FM/Db2 Editor Options panel directly where *n* is the value entered.



Note: Any options you set on the Editor Options panels apply for the current FM/Db2 editor session only. When you exit from the FM/Db2 editor session, the editor options revert to the global editor options.

In Edit, an exception to this is the audit option if the installation settings for the currently connected Db2® sub-system specifies AUDIT=OPTIONAL,OFF. In this case there is no difference between the audit option set using the global options, or for an individual Edit session. Further, any value specified is discarded at the end of the FM/Db2 session.

Related references

[Db2 View panel on page 613](#)

[Db2 Edit panel on page 598](#)

[Editor Options \(1 of 8\) panel on page 625](#)

Validating and saving changes with a File Manager/Db2 editor session

In Edit only, you can make changes to the data and save those changes to Db2®.

An Edit session of a Db2® object has important differences when compared to an Edit session of a data set. These differences need to be understood to make the most effective use of a File Manager/Db2 Edit session.

Db2® data is accessed by calls to Db2®. Some important Db2® concepts are discussed here because an understanding of these concepts is central to understanding how the FM/Db2 editor operates:

Db2® unit of work

A Db2® unit of work commences when a process initially connects to, or accesses data from, Db2®. The unit of work continues until the process ends the connection or issues an explicit Db2® COMMIT or ROLLBACK statement. Between the start and end of the unit of work, the process may make many calls to Db2® to read (fetch) change (update), insert, or delete rows.

Db2® COMMIT

This is a Db2® command that is used to signal the end of the current unit of work. A Db2® commit occurs automatically when a process ends; however, a Db2® commit may also be issued to finalize any pending changes to Db2® data. Issuing a Db2® commit is an irrevocable step. After the commit, it is not possible to reverse (back out) any changes made since the start of the unit of work.

Db2® ROLLBACK

This is a Db2® command that is used to signal that all pending changes for the current unit of work are to be reversed (backed out). After the rollback is processed, the Db2® data is in the same state that it was in at the start of the unit of work, or at the last commit point.

For more information about Db2® units of work, commit, and rollback, see "Db2® Concepts (Application Processes, concurrency and recovery)" in the *SQL Reference* manual, for the appropriate version of Db2®.

Ordering of rows within a Db2® object is not guaranteed

The relational model on which Db2® is based does not require data within a Db2® table to be in any specific order. This is not to say that data in a Db2® object is not stored in a particular order as this is certainly the case. In addition, a number of methods can be used (for example, CLUSTERING) to influence the way rows are stored in a Db2® table. In terms of the FM/Db2 editor, these considerations apply:

- Data is read from Db2® in the order Db2® delivers it to FM/Db2. Unless there is an ORDER BY clause for the data entered explicitly (on the Column Selection/Edit panel) or implicitly (for example, when processing a VIEW and the VIEW includes an ORDER BY clause), no assumptions should be made about the relative positions of any two rows.
- Moving rows from one position to another in a File Manager/Db2 Edit session has no effect on the way FM/Db2 stores the data in the table.
- When the editor is operating in "large mode", moving rows from one position to another is disabled.

Viewing and changing LOB data and XML documents

The FM/Db2 editor handles LOB and XML data differently to the data for other columns, primarily because of the potentially very large size for LOB and XML data.

You can use the editor options (see [Editor Options \(8 of 8\) panel on page 656](#)) to control how much (if any) of the data in LOB or XML columns is shown in the FM/Db2 editor. By default the column name for LOB or XML data is shown in the FM/Db2 editor, but no data is shown - this minimizes the use of storage by the FM/Db2 editor.

When the Db2® object being processed contains LOB columns, you can view and change the data in a single LOB column in a separate FM/Db2 editor session, initiated using the LOBBRWS, LOBEDIT or LOBVIEW editor primary commands.

When the Db2® object being processed contains XML columns, you can view and change the data in a single XML column in a separate editor session, initiated using the XMLBRWS, XMLEDIT or XMLVIEW editor primary commands. If the size of the XML document is less than or equal to 10 MB, the ISPF editor is used. Otherwise, the File Manager editor is used.



Note: Do not use the SAVE command in an XMLEDIT or LOBEDIT session because the data will not be updated in the Db2 table.

A File Manager/Db2 editor session of the data in a LOB column has some differences when compared with a File Manager/Db2 editor session of a Db2® object, as described in [Table 4: LOB edit differences on page 126](#). In this table, the term *originating session* refers to the FM/Db2 editor session of the Db2® object that contains a LOB column; *LOB session* refers to the FM/Db2 editor session of a LOB column, this is started from the originating session.

Table 4. LOB edit differences

Action	Object Edit	LOB edit
Initiation	From the function entry panel. EDIT, BROWSE, VIEW editor primary commands	Using the LOBBRWS, LOBEDIT, LOBVIEW editor primary commands from within a File Manager/Db2 editor session of the Db2® object containing the LOB column (Originating session).
Saving	Changes to rows presented to Db2® one at a time. It is possible that Db2® may reject changes to any row for many reasons.	Any changes made in the LOB session are not presented to Db2® as a change to the Db2® object when the LOB session ends. Instead FM/Db2 uses a LOB locator to store any changes. When a SAVE command is issued in the originating session, any rows that have pending changes to LOB columns are presented to Db2®.
Commit	A Db2® commit may be issued when a SAVE is issued from the originating session (this depends on the editor option's settings). A Db2® commit is issued at the end of the originating edit session.	No Db2® commits are issued from within a LOB session.
Data Display	Data is shown initially in either TABL or SNGL format, depending on the settings for the 'Initial display format' editor option. (Displayed on the Editor options (1) panel.)	Data is shown initially in either TABL or SNGL format, depending on the 'LOB display format' editor option. (Displayed on the Editor options (8 of 8) panel.) When data is displayed in SNGL mode, you can use the Previous and Next PFKeys (assigned to PF10 and PF11 by default) to scroll through the LOB data.
VARCHAR	The "varying length column" editor options are shown on Editor options (5 of 8) panel. The settings for these options depend on user settings.	The following "varying length column" editor options are fixed: <div style="background-color: #f0f0f0; padding: 5px; margin-top: 5px;"> <pre>Remove trailing spaces: Off Show end of string: On Convert spaces to Db2 null: Off</pre> </div>
Storage	As described for "normal" or "large" mode, see Table 3.	All of the data for the LOB column is loaded into the FM/Db2 editor. This may not be possible (insufficient storage) with small TSO region sizes and large LOB columns.

The following usage notes may assist in changing data within a LOB column.

- The LOB session is similar to a File Manager/Db2 editor session of a Db2® object containing a single VARCHAR(*nn*) column, where *nn* is in the range 1000 - 4000. The values for *nn* are approximate and depend on the screen size and other factors.
- The data for a single LOB column is split into pieces as it is loaded in the LOB session. This is purely for convenience, since it makes displaying and changing the LOB data easier, given the limitations of a 3270 terminal.
- You can use the FIND editor command to locate specific text within the LOB session. However a string will not be found if it is split across two "rows" in the LOB session.
- The LOB session initially displays the LOB data in either SNGL or TABL mode, this is determined by the current setting of the 'LOB display format' option. The amount of data shown depends on the 'LOB piece size' option, the terminal's characteristics and the number of characters in the LOB column's name.
- For large LOBs where the intent is to scroll through the data, consider setting the LOB display option to 'Single', combined with a LOB piece size option of 'Single display size'. This allows the maximum use of the available screen size to display the LOB data and the absolute character positions of data is also displayed. You can scroll through the data using the NEXT and PREVIOUS commands (PF11 and PF10).
- For edit operations, consider setting the LOB display option to 'Table', combined with a LOB piece size option of 'Table display size'. In TABL display mode, all of the data for each "row" is completely visible without the need to scroll to the right.
- You can also use Single display as the starting point for edit operations. When the insert point for edit operations is found, switch to TABL display mode and issue the SP(lit) prefix command against the row of interest. This converts the row to many smaller rows that are completely visible in TABL display format.
- Trailing spaces at the end of a "row" are significant, and you should exercise caution in removing these using the editor. When FM/Db2 re-assembles the data for the LOB column, it uses the VARCHAR length for each "row" to determine how much data is added to the LOB column. The editor options for varying length columns (see [Editor Options \(5 of 8\) panel on page 645](#)) are set to prevent accidental removal of trailing spaces from a "row", when the data in that "row" is changed.

Note that the end of the row is shown using the display string delimiter for varying length columns (see [Editor Options \(5 of 8\) panel on page 645](#)). You may explicitly set the end for a row using the input string delimiter (see [Editor Options \(5 of 8\) panel on page 645](#)).

XML differences

FM/Db2 uses either the ISPF editor or the File Manager editor to display and process changes to data in an XML column. The ISPF editor is used when the size of the XML document is less than or equal to 10 MB. The File Manager and ISPF editors are designed to handle different types of data:

- The ISPF editor is primarily a text editor, and is well suited to handling XML data.
- The File Manager editor is primarily a data editor, and is well suited to handling data that has a format that can be described using a template.

An XML document cannot be described using a template.

[Table 5: XML edit differences on page 128](#) highlights some important differences between a File Manager/Db2 editor session and an ISPF editor session of an XML document.

Table 5. XML edit differences

Action	Object Edit	XML Edit
Initiation	From the function entry panel. Edit, browse and view editor primary commands.	Using the XMLBRWS, XMLEDIT, XMLVIEW editor primary commands from within a File Manager/Db2 editor session of the Db2® object containing the XML column (Originating session).
Saving	Changes to rows presented to Db2® one at a time. It is possible that Db2® may reject changes to any row for many reasons. When a SAVE command is issued any changes made to XML columns are presented to Db2®.	XML documents are saved when either the XMLEDIT session or the FM/Db2 editor session ends.
Editor used	FM/Db2 editor	If the size of the XML document is less than or equal to 10 MB, the ISPF editor is used. Otherwise, the File Manager editor is used.
Commit	A Db2® commit may be issued at the end of SAVE command, depending on the settings for various editor options.	No Db2® commits are issued from within an edit session of an XML document.
Data Display	Data is shown initially in either TABL or SNGL format, depending on the settings for the 'Initial display format' editor option. (Displayed on the Editor options (1) panel.)	There is only one display format in the ISPF editor. The data is formatted using tag and end-tag pairs prior to display.
Storage	As described for "normal" or "large" mode, see Table 3: Characteristics of editor modes on page 122 .	All of the data for the XML document is written to a temporary data set, and then processed using either the ISPF editor or the File Manager editor. The following constraints might limit the size of the XML document that can be processed: <ul style="list-style-type: none"> • The user's TSO region size. • Allocation restrictions on the size of the temporary data set. • Disk space constraints. • The Db2® LOBVALA parameter (specified in Db2® job DSNTIJUZ). The value of this

Table 5. XML edit differences (continued)

Action	Object Edit	XML Edit
		parameter limits the maximum amount of storage, in KB, that each user is to have for storing LOB values.

Db2-related considerations when changing data in a File Manager/Db2 Edit session

A File Manager/Db2 Edit session is a Db2® unit of work, commencing at the start of the Edit session and continuing until one of these events occurs:

- The Edit session ends when END is pressed.
- The Edit session ends when CANCEL is pressed.
- A Db2® commit point is issued as part of a File Manager/Db2 SAVE primary command.
- A Db2® commit point is issued automatically because the number of successful changes reached the **Auto-commit count** value specified on the Editor Options (6 of 8) panel.

Within a File Manager/Db2 Edit session, multiple changes can be made to the data; you can send these changes to Db2® for validation with the SAVE primary command. At any time, the changes can be backed out (rolled back) to the state the data was in at the start of the Edit session, as long as a Db2® commit point has not been issued. This is unlike an the edit of a data set where typically, once changes have been saved, it is not possible to return to an earlier version of the data.

Changes made during a File Manager/Db2 Edit session are processed one row at a time. This is unlike the edit of a data set where, typically all of the changes made are written all together to the data set when the data is saved and the existing data set is completely replaced by the new one.

Changes made to the data in a Db2® object are validated by Db2® prior to the changes being accepted by Db2®. This is unlike changes that can be made to a data set, where typically there is no validation of the data and issuing a SAVE or END primary command is certain to save any pending changes.

Db2® might reject changes for many reasons. These are some, but not all, of the reasons that a change may be rejected:

- Inappropriate values for the data type of a column. For example, entering non-numeric data in a numeric column, or numeric data that is out of range in a numeric column.
- Violation of any check constraints applying to the Db2® object. For example, a column defined as CHAR(1) used to store the gender of a person, constrained to accept a value of only "M" or "F".
- Violation of any referential integrity rules applying to the Db2® object. For example, attempting to delete a primary key for which there are dependent rows in another table, and the DELETE rule for the constraint is RESTRICT
- Attempts to insert a duplicate with respect to a unique index defined on the Db2® object.

Within a File Manager/Db2 Edit session, you can use these methods to validate, and optionally commit, pending changes to Db2®:

- Issue an explicit SAVE primary command.
- Press the Enter key with no other pending changes (the auto save feature). (See the **Save data** option on [Editor Options \(6 of 8\) panel on page 649](#).)
- Press the END key (normally PF3) to end the Edit session. (See [Ending a File Manager/Db2 editor session on page 130](#).)

When you issue a SAVE primary command, any pending changes made are processed one row at a time. Each change results in a single INSERT, UPDATE, or DELETE SQL statement. If the change is unsuccessful, FM/Db2 marks the row in error in the Edit session. You must then correct the error before you can complete (commit) the data changes to Db2®.

FM/Db2 may issue Db2® commit points automatically during the SAVE process, if a non-zero value has been specified for the **Auto-commit count**, specified on the Editor Options (6 of 8) panel. Such commit points are issued whenever there have been the specified number of successful changes; it is possible for multiple commit points to be issued during the SAVE process. The commit points are issued regardless of whether errors are encountered when processing other rows.

At the end of the SAVE process, FM/Db2 may also issue an explicit Db2® commit, depending on the setting of the **Commit when save issued** and **Commit when no save errors** options. (See [Editor Options \(6 of 8\) panel on page 649](#).)

Usage note: When processing a Db2® object that is subject to constraints, frequent validation of any changes made can avoid frustration at the end of the editor session (when PF3 is pressed). You can issue the SAVE command repeatedly during an Edit session to validate the changes just made, while retaining the ability to cancel the entire Edit session. Remember that, until a Db2® commit point is issued, the entire unit of work can be rolled back. In "normal mode", you also have the option to auto-commit changes when you issue a SAVE primary command. This option is disabled in "large mode".

Related references

[SAVE primary command on page 937](#)

[Editor Options \(6 of 8\) panel on page 649](#)

Ending a File Manager/Db2 editor session

In View or Browse:

To end your FM/Db2 editor session:

Press the Exit function key (F3) or the Cancel function key (F12).

In Edit:

To end your FM/Db2 editor session and save any changes you have made:

Enter `END` on the command line, or press the Exit function key (F3).

To present the changes you have made to the current table to Db2® for validation, without ending the FM/Db2 editor session:

Use the SAVE primary command.

When you use the SAVE command, FM/Db2 processes any changes made one line at a time. Each change results in either an SQL INSERT, UPDATE or DELETE operation, Db2® may reject one or more of your changes. This is unlike an editor session of a normal data set, where generally all changes are made, or no changes are made.

Note the following about the SAVE process:

- FM/Db2 issues Db2® COMMIT points according to these commit options:
 - **Commit when save issued**
 - **Commit when no save errors**
 - **Auto-commit count**

The settings for these options are either the global settings, or as specified for this FM/Db2 editor session only. The first two options influence whether a Db2® COMMIT is issued at the end of the SAVE process. The third option influences whether Db2® COMMIT points are issued during the SAVE process.

- Issuing a Db2® COMMIT finalizes all pending changes to the data, and is an irrevocable process. After the COMMIT is issued, you can cancel the editor session; however, any changes made since the start of the edit session are *not* backed out. Conversely, if no COMMIT has been issued, you can back out *all* changes made during the current editor session, regardless of how many SAVE commands have been issued.
- When the editor is operating in "large mode", any automatic Db2® COMMIT is disabled. Your changes are still presented to Db2® and validated; however, the final COMMIT is deferred until you end the editor session.

To end your FM/Db2 editor session without saving your changes (that is, since the previous successful commit point):

Enter `CANCEL` (or `CAN`) on the command line, or press the Cancel function key (F12). If you have made any changes to the data, FM/Db2 displays a message box asking you to confirm that you want to discard the changes.



Note:

1. If there are dependent related FM/Db2 editor sessions still active:
 - You need to end these sessions before you end the current (parent) FM/Db2 editor session (unless you cancel the session).
 - Canceling the current FM/Db2 editor session also cancels all the dependent related FM/Db2 editor sessions.

Related tasks

[Editing related tables on page 188](#)

[Specifying the editor session mode: "normal mode" or "large mode" on page 121](#)

Related references

[CANCEL primary command on page 873](#)

[SAVE primary command on page 937](#)

[Editor Options \(6 of 8\) panel on page 649](#)

Starting another FM/Db2 editor session

When you are in a File Manager/Db2 editor session, you can start another FM/Db2 editor session by issuing the BROWSE, EDIT, VIEW, or REDIT primary commands.

BROWSE, EDIT, VIEW commands

The BROWSE, EDIT, and VIEW primary commands start another FM/Db2 editor session and display the Browse, Edit, or View entry panel respectively.

The new FM/Db2 editor session is stacked on top of the current FM/Db2 editor session. If you specify a Db2® object owner and Db2® object name, the owner and name fields are pre-filled on the entry panel for the new FM/Db2 editor session.



Note: To start a File Manager/Db2 editor session in Browse mode from the Primary Option Menu panel, enter the abbreviated form of the BROWSE command, `B`, on the command line.

Examples:

`VIEW`

Starts a new FM/Db2 editor session, in View mode.

`BRO DSN8910.EMP`

Starts a new FM/Db2 editor session, in Browse mode. The owner field is set to 'DSN8910' and the name field is set to 'EMP', on the Browse entry panel for the new editor session.

`EDIT EMP`

Starts a new FM/Db2 editor session, in Edit mode. The name field is set to 'EMP', on the Edit entry panel for the new editor session.

To exit the new FM/Db2 editor session and return to the current FM/Db2 editor session, press the End or CANCEL key.

REDIT command

The REDIT primary command displays information about tables related by a Db2® referential integrity (RI) constraint, to the Db2® object currently being edited. The command is context and cursor sensitive.

Related references

[Listing related tables on page 189](#)

[BROWSE primary command on page 872](#)

[EDIT primary command on page 886](#)

[VIEW primary command on page 947](#)

[REDIT primary command on page 931](#)

[Related tables panel on page 755](#)

Specifying the Db2® object you want to view

This section describes how you specify the Db2® object you want to view when you use the FM/Db2 View Utility (option 1), the FM/Db2 Edit Utility (option 2), or the FM/Db2 Browse Utility (option B) to view Db2® data or, in the case of edit, to optionally change Db2® data. The descriptions apply to the Db2® View panel, Db2® Edit panel, and Db2® Browse panel respectively.

To specify the table you want to view, use the **Name** entry field and, optionally, the **Location**, **Owner**, **Database**, and **Table space** entry fields.

To specify the template that you want FM/Db2 to use when viewing the data, use a combination of the **Template** and **Template usage** entry fields. You can:

- Specify a template that describes the format of the Db2® object:
 - Use **Data set name**, and optionally **Member**, to specify the template.
 - Select 1 (Above).
- Use the last (previously used) template:
 - Select 2 (Previous).

Any values in the Data set name and Member fields are ignored.

- Use FM/Db2 to generate a template using the information in the Db2® catalog:
 - Select 3 (Generate from table). This is the default setting.

Any values in the Data set name and Member fields are ignored.

- Use FM/Db2 to generate a template using the information in the Db2® catalog and store the generated template using the name you specify (if the data set already exists, FM/Db2 replaces it):
 - Use **Data set name**, and optionally **Member**, to specify the name that you want FM/Db2 to use if storing the generated template.
 - Select 4 (Generate/Replace).

You can select this option to change the options for the current editor session:

Edit options

Enter one of these:

A “.” or an “A”

Displays the first FM/Db2 editor options panel, prior to displaying the data for the Db2® object being processed.

A number in the range 1–8

Displays the *n*th FM/Db2 editor options panel directly where *n* is the value entered.

Any options that you set last only for the duration of the current Edit session, and override any conflicting global options. To permanently change the Edit options, select option 0.2.

You can select the following options by entering a “/” or an “A”:

Edit template

Select this option to edit the template before editing the data.

Re-edit template

Select this option to control the navigation between panels within the Edit dialog. This option controls the behavior of the F3 and F12 keys when pressed from within an Edit session.

Create audit trail

Select this option to generate an audit trail report of all successful modifications to Db2® data made during the current Edit session.



Note: This option is not displayed if SAF-rule controlled auditing is not in effect. See [SAF-rule controlled auditing on page 69](#).



Note: Entering an “A” in an option field changes the behavior of the dialog so that the appropriate options panel is *always* displayed. If you only need to refer to an options panel on one occasion, use the “/” character. The “/” is cleared after the option is processed, thereby returning the dialog to the default behavior, which is to *not* show the various option panels.

Related tasks

[Selecting options on FM/Db2 panels on page 44](#)

[Setting options for the current FM/Db2 editor session on page 123](#)

[Editing a template on page 81](#)

Related references

[Db2 Browse panel on page 595](#)

[Db2 Edit panel on page 598](#)

Restricting the data that FM/Db2 loads from Db2®

When you view a Db2® table or view in a File Manager/Db2 editor session, FM/Db2 accesses Db2® to obtain a copy of the data in the table or view. This copy of the data is loaded into the FM/Db2 editor. In normal circumstances, the data for every column of the Db2® object is retrieved - with the exception of any LOB or XML columns (see [Viewing and changing LOB data](#)

and XML documents on page 125 for more information). This occurs regardless of whether you have deselected one or more columns using the template editor.

However, you may find that you want to restrict the data that FM/Db2 loads, either because you are only interested in data that satisfies certain selection criteria, or simply to limit the number of rows of data that FM/Db2 retrieves.

The following sections discuss the ways in which you can restrict the data that FM/Db2 loads.

Related tasks

[Storage considerations on page 135](#)

[Viewing large tables or views on page 136](#)

[Restricting the rows to view by specifying row selection criteria on page 136](#)

[Restricting the rows to view with the "Row count" entry field on page 137](#)

[Interactively developing row selection criteria on page 136](#)

[Using Select Statement Edit to limit the data retrieved by FM/Db2 on page 137](#)

[Specifying the editor session mode: "normal mode" or "large mode" on page 121](#)

[Specifying the start position for your FM/Db2 editor session on page 123](#)

Storage considerations

If you are working with large Db2® tables or views, you may need to consider how much space is required in the editor to store the copy of the Db2® object.

The FM/Db2 editor uses storage in the TSO user's address space. The size of the address space is governed by the TSO region size, which may be limited by your systems administrator. As a guide, the amount of space needed by the FM/Db2 editor is the number of rows loaded, multiplied by the number of bytes of data in each row, multiplied by an editor overhead.

For example, to load 100,000 rows of 20 bytes into the FM/Db2 editor, requires at least 2MB of storage. The editor overhead factor is at least 1 and can be as much as 3, so up to 6MB of storage may be needed.

To take another example, if each row occupies 1000 bytes, every 1024 rows loaded requires about 1MB of storage. Therefore to load 100,000 such rows, at least 100MB of storage is required.

When the editor is operating in "normal mode", the number of rows loaded remains fixed and can be used to estimate the total storage requirements.

When the editor is operating in "large mode", the number of rows loaded is approximately three times the number of rows visible in TABL display format. This number remains unchanged regardless of any scrolling operations. When changes are made to rows, those rows remain in the editor. Therefore you may still encounter storage problems if you perform edit operations that change large numbers of rows in the table.

When you need to change large numbers of rows, consider changing the table by direct execution of SQL statements.

Viewing large tables or views

If the Db2® table or view requires more storage than is available in the TSO region, you will *have* to restrict the data that FM/Db2 loads from Db2®. The most convenient way to do this is to select "large mode" by specifying `ALL`, `0` or `*` in the **Row count** field on the entry panel. Large mode may not be available if the product installer has chosen to disable it.

When processing an object containing large object columns, FM/Db2 requires at least as much memory (virtual storage) as that needed to store one row of data from the object, with every large object column at the maximum possible size for that column. This may not be possible with a small TSO region size and large object data in the megabyte (or greater) range. To process an object with large object columns, create a Db2® view of the object without the large object columns present, and then process the view.

The following sections describe other ways in which you can restrict the data that FM/Db2 loads.

Related references

[Specifying the editor session mode: "normal mode" or "large mode" on page 121](#)

Restricting the rows to view by specifying row selection criteria

When you specify row selection criteria, FM/Db2 retrieves only those rows that match your criteria from Db2®. Only these rows are loaded into the Db2® editor. Specifying row selection criteria is usually the most convenient and efficient method for restricting the data that FM/Db2 loads from Db2®.

This method applies to both "normal mode" and "large mode".

Related tasks

[Selecting rows on page 83](#)

[Specifying the editor session mode: "normal mode" or "large mode" on page 121](#)

Interactively developing row selection criteria

Sometimes you may need to view or edit a Db2® table or view with which you are not familiar. You may only need to view (and possibly change) a few rows of the table or view. FM/Db2 View and FM/Db2 Edit provide options to assist in interactively identifying the rows of interest, and then restricting the data loaded by FM/Db2 using row selection criteria.

To use this method, you need to alter the behavior of the editor dialog by setting the **Edit template** and **Re-edit template** options (use "A"). You can then alternate between the data display and the Column Selection/Edit panels, refining the row selection criteria until you have identified exactly the rows you require.

Related tasks

[Selecting options on FM/Db2 panels on page 44](#)

[Selecting rows on page 83](#)

Restricting the rows to view with the "Row count" entry field

If you just want to limit the volume of data that FM/Db2 retrieves from Db2®, use the **Row count** entry field on the Db2® View panel or the Db2® Edit panel to specify the number of rows of Db2® data you want.

You can use this entry field to select "large mode" by typing `ALL`, `0`, or `*` in the field.

If the maximum number of rows was retrieved, the message *"Limit of Rows Retrieved"* appears immediately below the last row (in TABL display format).

You can use this entry field when viewing or editing large tables, in combination with the **Start position** entry field, to show small portions of the table. You can then specify row selection criteria that limit rows retrieved to those of interest.

Related references

[Db2 View panel on page 613](#)

[Db2 Edit panel on page 598](#)

Restricting the rows to view with the "Start position" entry field

In some situations, the rows of interest may be located together in the table, but not necessarily at the beginning. In this case, if you know the approximate starting row number, you can specify a start position value in the **Start position** entry field. FM/Db2 skips rows until the specified start position and then loads rows from that point.

In "normal mode", the **Row count** value applies from the starting row, not the beginning of the table. Once the rows have been loaded you cannot scroll up to see the skipped rows.

In "large mode", FM/Db2 loads rows from the start position until the limits discussed in [Specifying the editor session mode: "normal mode" or "large mode" on page 121](#) are reached. In "large mode", you can scroll up from the start position to the first row of the table if required.

Related references

[Db2 View panel on page 613](#)

[Db2 Edit panel on page 598](#)

Using Select Statement Edit to limit the data retrieved by FM/Db2

You can use the *"Enter, execute and explain SQL statements"* function (option 4.3) to enter a SELECT statement and display the results in a File Manager/Db2 editor session. In general, if you want to view or edit a Db2® table or view, View (option 1) and Edit (option 2) are recommended. However, you can specify the columns to retrieve using option 4.3.

For example, the following statement retrieves all columns from the DSN8810.EMP table:

```
SELECT * FROM DSN8810.EMP
```

However, the following statement retrieves only the listed columns:

```
SELECT EMPNO, FIRSTNME, MIDINIT, LASTNAME, WORKDEPT, PHONENO,  
HIREDATE, JOB, EDLEVEL, SEX, BIRTHDATE FROM DSN8810.EMP
```

You might use this method when editing a table with many columns, most of which are of no interest to you. Alternatively, if the Db2® object has a “*wide*” row, omitting long VARCHAR or VARGRAPHIC columns may dramatically reduce the amount of data retrieved by FM/Db2 and loaded into the editor.



Note: When you omit columns from a Db2® object, you may find that not all edit operations are possible. For example, inserting a new row will fail if any of the omitted columns is defined as NOT NULL.

Related tasks

[View and Edit options \(options 1 and 2\) on page 65](#)

[Storage considerations on page 135](#)

[Entering, executing, and explaining SQL statements on page 416](#)

Related references

[Db2 View panel on page 613](#)

[Db2 Edit panel on page 598](#)

[Editor Options \(1 of 8\) panel on page 625](#)

Viewing data in a File Manager/Db2 editor session

When you view a Db2® table or view in a File Manager/Db2 editor session, you can:

- Locate a specific row or column
- Search the data for a specific string or numeric value
- Select a display format for the data
- Scroll or sort the data

Count of rows fetched in a File Manager/Db2 editor session

When FM/Db2 first displays data in an editor session, it shows the number of rows that were fetched. “*nn rows fetched*” is shown in the upper left, on either the second line (if the command line is at the bottom of the display) or third line (if the command line is at the top of the display), and persists until you press Enter or any function key.

Locating a row

To move to a particular row number, use the LOCATE primary command. In a File Manager/Db2 editor session, rows are numbered from 1 upwards and the row number is shown in the prefix area (TABL display mode) or in the upper right of the panel (SNGL display mode). For example, to move to row 42, enter the following command:

```
LOCATE 42
```

In TABL display format, this command scrolls the display (either forwards or backwards) so that row number 42 is displayed at the top of the screen. In SNGL display format, the display changes so that row number 42 is displayed.

In a File Manager/Db2 editor session, you can also use the LOCATE primary command to move to a row to which a particular label has been assigned. For example, to move to the row labeled “.HERE”, enter the following command:

```
LOCATE .HERE
```

In a File Manager/Db2 editor session, if in TABL display format, this command scrolls the display (either forwards or backwards) so that the row labeled “.HERE” is at the top of the screen. In SNGL display format, the display changes so that the row, previously labeled “.HERE” in TABL display format, is displayed.

Related tasks

[TABL display format on page 150](#)

[SNGL display format on page 152](#)

[Assigning labels to rows on page 147](#)

Related references

[LOCATE primary command on page 918](#)

Locating a column

You can use the LOCATE primary command to move to a particular column. You can specify either a Db2® column number, or part or all of a column name.

You specify a Db2® column *number* by preceding the column number with the “#” symbol (for example, #4). Db2® column numbers are shown on the Column Selection/Edit panel, and optionally in both TABL and SNGL display formats when you view data. (To display column numbers, you must select the **Show column number** option on the third Editor Options panel.) For long character columns only (> 50 bytes) you can optionally locate a character position within a column.

You specify a Db2® column *name* by typing all or part of the column name, with or without quotation marks.

When FM/Db2 finds the specified column, it scrolls the data so that the matching column is displayed on the left of the screen (in TABL display format), or at the top of the screen (in SNGL display format). In addition, after FM/Db2 has found the specified column, in SNGL display format if you press F11 (to display the following record) or F10 (to display the preceding record), the data is scrolled to show the matching column at the top of the screen for each record displayed. If you change to TABL display format, the data is scrolled so that the matching column is displayed on the left of the screen.

Related tasks

[TABL display format on page 150](#)

[SNGL display format on page 152](#)

[View and Edit options \(options 1 and 2\) on page 65](#)

[Setting options for the current FM/Db2 editor session on page 123](#)

Related references

[LOCATE primary command on page 918](#)

[Column Selection/Edit panel on page 485](#)

[Editor Options \(3 of 8\) panel on page 634](#)

Specifying the column number or column name

To locate a column, you must specify one of the following:

- a Db2® column number
- a column name, or
- part of a column name

The following command locates column 4 in the data:

```
LOCATE #4
```

The following command locates column 4 in the data, and scrolls the display so that character position 100 of that column is visible:

```
LOCATE #4 100
```

Either of the following commands locates column EMPNO in the data:

```
L EMPNO
```

```
L 'EMPNO'
```

If you specify part of column name, the LOCATE command matches any column that contains the specified string within the column name. For example,

```
L NO
```

locates both EMPNO and DEPTNO.

Using the FLD parameter

The FLD parameter indicates to FM/Db2 that the string following the FLD keyword is the name or part of the name of the column you want to locate. You use the FLD parameter to resolve any ambiguity that might exist between column names and other command parameters.

You *must* specify the FLD parameter before the string, if the search string is "NEXT", "PREV", "FIRST", "LAST", "FLD", starts with "#", or is a number.

For example, to locate a column name containing the # symbol such as #ITEMS, use the following command:

```
L FLD #ITEMS
```

The command `L #ITEMS` results in an error as FM/Db2 is expecting the # symbol to be followed by a numeric Db2® column number.

Specifying the search direction and starting point

By default, the LOCATE primary command searches for the next occurrence of the specified column name, starting at the column currently displayed on the left of the screen (in TABL display format), or at the top of the screen (in SNGL display format).

You can control the direction and scope of the column name search by entering one of the following optional parameters:

- NEXT
- PREV
- FIRST
- LAST

The following sections describe how you use each of the preceding parameters.

Using the NEXT parameter

NEXT is the default value. Both of the following commands search for the next column name containing the string “NO”:

```
L NEXT 'NO'
L NO NEXT
```

In TABL display format, the preceding commands start at (but exclude) the column currently displayed on the left of the screen and scan right to find the first column name that is either “NO”, or contains the string “NO” (for example, NO, EMPNO, DEPTNO and NOMINAL all contain the string “NO”). The search ends when either a match occurs, or the last column of the Db2® object is encountered. If a matching column name is found, FM/Db2 scrolls the data so that the matching column is displayed on the left of the display.

In SNGL display format, the preceding commands start at (but exclude) the column currently displayed at the top of the screen and scan down to find the first matching column name. The search ends when either a match occurs, or the last column of the Db2® object is encountered. If a matching column name is found, FM/Db2 scrolls the data so that the matching column is displayed at the top of the display.

Using the PREV parameter

Both of the following commands search backwards for the next column name containing the string “NO”:

```
L PREV NO
L NO PREV
```

In TABL display format, the preceding commands start at (but exclude) the column currently displayed on the left of the screen and scan left to find the first column name that is either “NO”, or contains the string “NO”. The search ends when either a match occurs, or the first column of the Db2® object is encountered. If a matching column name is found, FM/Db2 scrolls the data so that the matching column is displayed on the left of the display.

In SNGL display format, the preceding commands start at (but exclude) the column currently displayed at the top of the screen and scan up to find the first matching column name. The search ends when either a match occurs, or the first column

of the Db2® object is encountered. If a matching column name is found, FM/Db2 scrolls the data so that the matching column is displayed at the top of the display.

Using the FIRST parameter

Both of the following commands search for the first column name containing the string "NO":

```
L FIRST NO
L 'NO' FIRST
```

In TABL display format, the preceding commands start at the first column for the Db2® object and scan right to find the first column name that is either "NO", or contains the string "NO". The search ends when either a match occurs, or the last column of the Db2® object is encountered. If a matching column name is found, FM/Db2 scrolls the data so that the matching column is displayed on the left of the display.

In SNGL display format, the preceding commands start at the first column for the Db2® object and scan down to find the first matching column name. The search ends when either a match occurs, or the last column of the Db2® object is encountered. If a matching column name is found, FM/Db2 scrolls the data so that the matching column is displayed at the top of the display.

Using the LAST parameter

Both of the following commands search for the last column name containing the string "NO":

```
L LAST NO
L NO LAST
```

In TABL display format, the preceding commands start at the last column for the Db2® object and scan left to find the last column name that is either "NO", or contains the string "NO". The search ends when either a match occurs, or the first column of the Db2® object is encountered. If a matching column name is found, FM/Db2 scrolls the data so that the matching column is displayed on the left of the display.

In SNGL display format, the preceding commands start at the last column for the Db2® object and scan up to find the first matching column name. The search ends when either a match occurs, or the first column of the Db2® object is encountered. If a matching column name is found, FM/Db2 scrolls the data so that the matching column is displayed at the top of the display.

Finding a string

To search the data for a specific string, use the FIND primary command (which you can abbreviate as F or /).

For example, to search for the next occurrence of the string "Golden" in any mix of uppercase and lowercase, enter the following on the command line:

```
F GOLDEN
```

Repeating the search

To move the cursor to the next occurrence of the search string, issue the RFind primary command or press the RFind function key (F5).



Note: RFind works from the cursor position. When you use the RFind function key (F5), the cursor remains in the body of the data and pressing the key moves to the next occurrence of the string. However, if you type the RFind primary command on the command line, you need to reposition the cursor on the last occurrence of *string* and then press Enter in order to find the next occurrence.

To find the same string as you specified on the previous FIND primary command, specify an asterisk (*) as the search string.

Handling long strings

For character columns (CHAR, VARCHAR), you can specify a search string up to 100 characters long. However, when you are dealing with a long search string, you may find that you cannot fit the whole FIND command (including other parameters) on the command line. To overcome the problem, do one of the following to display an Extended Command Entry pop-up panel:

- Enter `FX` (for Find Extended)
- Enter the FIND command (or one of its abbreviations, such as F or /) *with no parameters*



Note: If you have previously used the FIND or CHANGE commands in the current FM/Db2 editor session, to display the Extended Command Entry pop-up panel in this way, you will need to first use the RESET command before entering the FIND command (or one of its abbreviations) without any parameters. Alternatively, enter `FX`.

The Extended Command Entry pop-up panel contains five lines (each 50 characters long) that you can use to enter all the FIND command parameters (but not the actual keyword FIND or any of its abbreviations). FM/Db2 treats the five lines on the pop-up panel as contiguous, allowing you to specify a long search string, the Db2® column number and optionally any other parameters, using up to 250 characters in total.



Note: You can continue the search string (or any other parameter) from the last position on one line of the pop-up panel to the first position of the next line. However, this does not mean that you need to completely fill a line before using the next line. For example, you can specify the search string on the first of the five lines, and the Db2® column number (specified as #*n*) on the next line. If you do not use all of a line, FM/Db2 treats the unused part of the line as a single space.

Figure 48: Extended Command Entry pop-up panel for the FIND command showing contiguous nature of entry lines on page 144 shows the Extended Command Entry pop-up panel for the FIND command. In this example, FM/Db2 finds any previous occurrences of a long string (78 characters) in Db2® column 3.

Figure 48. Extended Command Entry pop-up panel for the FIND command showing contiguous nature of entry lines

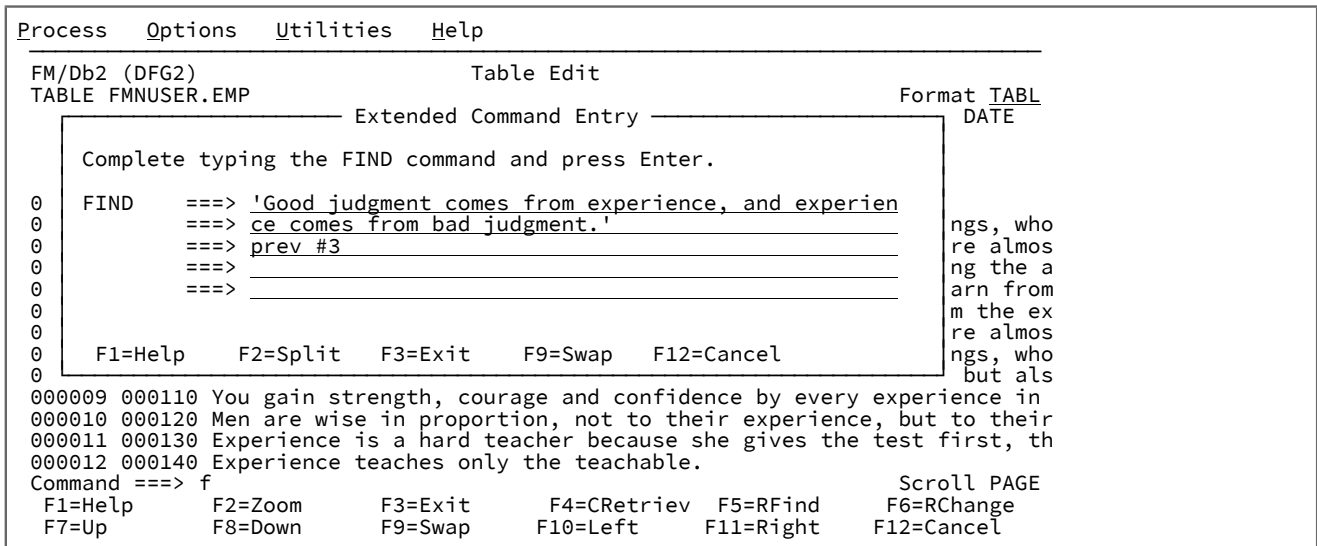

Related references

[FIND primary command on page 897](#)

Finding data within specific columns

You can optionally limit the effects of primary commands to a specified column, a list of columns, or one or more ranges of columns.

You specify the columns to be searched using #n column references. These are displayed above each column in TABL display format, or next to each column in SNGL display format. The search string is found only if it is completely contained within one of the specified columns.

Specifying a list of columns

When you specify a list of columns, you must either:

- Enclose the column references (optionally separated by commas) in parentheses, or
- Separate the column references with commas but without any intervening spaces.

These are valid lists of columns:

```

#17
(#17)
(#17 #22)
(#17, #22)
#17,#22
    
```

These are invalid lists of columns:

```

#17 #22
#17, #22
    
```

The search string is found if it is completely contained within one of the specified columns. For example, the following command excludes all records containing the characters “the” (in any mix of uppercase and lowercase) in column #5:

```
EXCLUDE ALL the #5
```

The following command finds the next record containing an uppercase letter A in column #8 or #9:

```
FIND C'A' #8,#9
```

Specifying ranges of columns

You specify a range of columns by nominating the first and last column reference of the range, separated by a hyphen, with or without intervening spaces. You can optionally enclose the range in parentheses.

These are valid ranges of columns:

```
#17-#19
#17 - #19
(#17-#19)
(#17 - #19)
```

To specify more than one range of columns:

- Enclose each column range in parentheses (optionally separated by commas), or
- Separate each column range with commas, but without any intervening spaces.

These are valid ranges of columns:

```
(#8-#11) (#17-#19) (#24-#25)
(#8-#11), (#17-#19), (#24-#25)
#8-#11, #17-#19, #24-#25
```

These are invalid ranges of columns:

```
#8-#11 #17-#19 #24-#25
#8-#11, #17-#19, #24-#25
```



Note:

1. Column ranges can overlap. For example, #2-#7, #5-#9. In this case, the result is a consolidated single column range equivalent to #2-#9.

[TABL display format on page 150](#)

[SNGL display format on page 152](#)

[Searching numeric columns on page 148](#)

[Excluding rows on page 159](#)

Related references

[CHANGE primary command on page 875](#)

[EXCLUDE primary command on page 888](#)

[FIND primary command on page 897](#)

Finding a string within specific portions of the data

When you use the FIND command to search for a string, you can limit the search to specific portions of the data you are searching:

- To limit the search for a string to only where it appears as a *prefix* in the data, specify the PREFIX parameter.
- To limit the search for a string to only where it appears as a *suffix* in the data, specify the SUFFIX parameter.
- To limit the search for a string to only where it appears as a *word* in the data, specify the WORD parameter.

Related references

[FIND primary command on page 897](#)

Finding data within excluded or non-excluded rows

If your data contains excluded and non-excluded rows, you can limit the search for a string or numeric value to:

- Only non-excluded rows (parameter NX), or
- Only excluded rows (parameter EX or X)

For example, the following command finds the next non-excluded row containing the string "SCARECROW" in column number 1 or column number 7:

```
FIND SCARECROW (#1 #7) NX
```

And the following command finds the next excluded row containing the value 1024 in column number 3:

```
FIND 1024 #3 EX
```

Related references

[FIND primary command on page 897](#)

Finding data within a label range

In a File Manager/Db2 editor session, you can limit the search for a string or numeric value to a range of rows, identified by a pair of labels indicating the first and last rows to be searched.

For example, the following command finds the next row containing the string "TIME" in column number 10 in the range of rows from the label .STRT to the label .FNSH

```
FIND TIME #10 .STRT .FNSH
```

And the following command finds the next row containing the value 2840 in column number 4 or column number 6 in the range of rows from the current cursor position to the label .END

```
FIND 2840 #4,#6 .ZCSR .END
```

Related tasks

[Assigning labels to rows on page 147](#)

Related references

[FIND primary command on page 897](#)

Assigning labels to rows

In a File Manager/Db2 editor session, if you use the CHANGE, DELETE, EXCLUDE, EXPORT, or FIND command in TABL display format, you can limit the rows that are searched by entering a “*range*” parameter. The range parameter consists of a pair of *labels* indicating the first and last rows to be searched. The string is found if it is contained within the specified range.

A label can be one to four alphabetic characters, beginning with a period (.). Labels starting with the letter “Z” are assigned by the editor.

You assign a label by typing the valid character string into the prefix area of the row. In the following example, the label `.HERE` is assigned to row number 16 and the label `.THRE` is assigned to row number 129:

```
:
00015 This is a row.
.HERE This is a row with a label.
00017 This is a row.
:
00128 This is a row.
.THRE This is a row with a label.
00130 This is a row.
:
```

After it is assigned, a label stays with the row, even if the row is moved.

To remove a label from a data row, blank out the label characters (or overwrite them with a new label) then press Enter. You can unassign a label by deleting the row containing that label, or you can remove all row labels by using the RESET LABEL command.

You can overwrite a label with a prefix command without unassigning the label. The label reappears at the completion of the command and remains displayed in the row prefix area.

You can move a label to another row by typing the same label on a new row.

Some labels are automatically assigned and maintained by the editor. These special labels begin with the letter “Z” (Your own labels therefore must not start with a “Z”.) Unlike other labels, these editor-assigned labels do not necessarily stay with the same row, but instead represent logical positions on the display.

Some of these editor-assigned labels are available to you. The editor assigns:

.ZCSR

To the row on which the cursor is currently positioned.

.ZFST

To the first row (relative row number 1). This can be abbreviated to .ZF.

.ZLST

To the last row. This can be abbreviated to .ZL.

The following FIND command finds the next row, excluded or non-excluded, containing the string *xxx*, in the column with column number 5, in the range of rows from the current cursor position to the end of data:

```
FIND xxx #5 .ZCSR .ZLST
```

The following EXCLUDE command excludes all rows, excluded or non-excluded, containing the string "ABC", in either of the columns with column numbers 3 and 7, in the range of rows from the label .HERE to the label .THRE:

```
EXCLUDE ALL ABC (#3 #7) .HERE .THRE
```

If you use the range parameter, the two labels must be separated by a blank or comma. A single label is not allowed. The labels can be any combination of the editor-assigned labels (.ZCSR, .ZFST, .ZLST) or labels you have assigned yourself.

The label representing the smaller relative row number is used as the start of the range and the label representing the larger relative row number is used as the end of the range, regardless of the order in which they are specified.

If the range you specify includes excluded rows that are hidden from display or represented by shadow lines, those rows are not affected by the command.

Related references

[CHANGE primary command on page 875](#)

[DELETE primary command on page 882](#)

[EXCLUDE primary command on page 888](#)

[FIND primary command on page 897](#)

[RESET primary command on page 932](#)

Searching numeric columns

The numeric value of the search string must equal the formatted numeric value of the column. The lengths (number of digits) of the search string and of the numeric column are not significant. Similarly, the data type of the numeric column is not significant. For example, a search string of 123 matches a DECIMAL column containing 00123, or a SMALLINT column containing 123. A search string of 123 does not match a DECIMAL or SMALLINT column containing 12300 (because the numeric values are different). An unsigned value in the string is considered to be positive.

Related references

[Finding data within specific columns on page 144](#)

Related references

[CHANGE primary command on page 875](#)

[EXCLUDE primary command on page 888](#)

[FIND primary command on page 897](#)

Changing the view of displayed data

You can change the view of data displayed in a File Manager/Db2 editor session by editing the template to:

- Show only selected columns
- Change the sequence of displayed columns
- Change column headings
- Change the width of columns
- Show leading zeros (numeric columns)

After you have edited the template, you can either save it for future use, or just use it for the current FM/Db2 editor session only.

To edit the template in the current FM/Db2 editor session, use the TEDIT primary command.

To edit the template from the Table View or Table Edit panel, select the **Edit template** option.

Related tasks

[Working with templates on page 72](#)

Related references

[TEDIT primary command on page 943](#)

Selecting a display format

In a File Manager/Db2 editor session, you can view the data in the following display formats:

- Tabular format (TABL), or
- Single-row format (SNGL)

To select the display format you want, you can:

- Enter one of the following values (or just its first letter) in the **Format** field (in the upper right corner of the Table View or Table Edit panel):
 - TABL
 - SNGL
- Use the FORMAT primary command to toggle between TABL and SNGL display formats.
- In TABL display format, use the FS primary command to change to SNGL display format.

- In SNGL display format, use the FT primary command to change to TABL display format.
- If in TABL display format, use the FS prefix command to change to SNGL display format.

The following pages describe the TABL and SNGL display formats.

Related references

[FORMAT primary command on page 904](#)

[FS primary command on page 907](#)

[FT primary command on page 907](#)

[Table Edit panel on page 826](#)

TABL display format

In TABL display format (the default format), the rows of the table are presented formatted into columns displayed horizontally across the panel.

Figure 49: View panel in TABL display format (with all optional lines displayed) on page 150 shows an example of a view display in TABL display format.

Figure 49. View panel in TABL display format (with all optional lines displayed)

Process	Options	Utilities	Help				
FM/Db2 (DFG2)				Table View			42 rows fetched
TABLE FMUSER.EMP							Format TABL
EMPNO	FIRSTNME	MIDINIT	LASTNAME	WORKDEPT	PHONENO	HIREDATE	JOB
#1	#2	#3	#4	#5	#6	#7	#8 +
CH(6)	VARCHAR(12)	CH(1)	VARCHAR(15)	CH(3)	CH(4)	DATE	CH(8)
PU-->	<-----1->	-	<-----1----->	<-NF	<->	<----->	<-----+
**** Top of data ****							
000010	CHRISTINE<	I	HAAS<	A00	3978	01.01.1965	PRES
000020	MICHAEL<	L	THOMPSON<	B01	3476	10.10.1973	MANAGE
000030	SALLY<	A	KWAN<	C01	4738	05.04.1975	MANAGE
000050	JOHN<	B	GEYER<	E01	6789	17.08.1949	MANAGE
000060	IRVING<	F	STERN<	D11	6423	14.09.1973	MANAGE
000070	EVA<	D	PULASKI<	D21	7831	30.09.1980	MANAGE
000090	EILEEN<	W	HENDERSON<	E11	5498	15.08.1970	MANAGE
000100	THEODORE<	Q	SPENSER<	E21	0972	19.06.1980	MANAGE
000110	VINCENZO<	G	LUCCHESI<	A00	3490	16.05.1958	SALESR
000120	sean<		O'CONNELL<	A00	2167	05.12.1963	CLERK
000130	DOLORES<	M	QUINTANA<	C01	4578	28.07.1971	ANALYS
000140	HEATHER<	A	NICHOLLS<	C01	1793	15.12.1976	ANALYS
Command ==>							Scroll PAGE
F1=Help	F2=Zoom	F3=Exit	F4=CRetrieV	F5=RFind	F6=RChange		
F7=Up	F8=Down	F9=Swap	F10=Left	F11=Right	F12=Cancel		

Figure 50: Edit panel in TABL display format (with all optional lines displayed) on page 151 shows an example of an edit display in TABL display format.

Figure 50. Edit panel in TABL display format (with all optional lines displayed)

Process	Options	Utilities	Help				
FM/Db2 (DFG2)			Table Edit				42 rows fetched
TABLE FMUSER.EMP							Format TABL
EMPNO	FIRSTNME	MIDINIT	LASTNAME	WORKDEPT	PHONENO	HIREDATE	
#1	#2	#3	#4	#5	#6	#7	
CH(6)	VARCHAR(12)	CH(1)	VARCHAR(15)	CH(3)	CH(4)	DATE	
000000	****	Top of data	****				
000000	****	Top of data	****				
000001	000010	CHRISTINE<	I	HAAS<	A00	3978	01.01.1965
000002	000020	MICHAEL<	L	THOMPSON<	B01	3476	10.10.1973
000003	000030	SALLY<	A	KWAN<	C01	4738	05.04.1975
000004	000050	JOHN<	B	GEYER<	E01	6789	17.08.1949
000005	000060	IRVING<	F	STERN<	D11	6423	14.09.1973
000006	000070	EVA<	D	PULASKI<	D21	7831	30.09.1980
000007	000090	EILEEN<	W	HENDERSON<	E11	5498	15.08.1970
000008	000100	THEODORE<	Q	SPENSER<	E21	0972	19.06.1980
000009	000110	VINCENZO<	G	LUCCHESI<	A00	3490	16.05.1958
000010	000120	sean<		O'CONNELL<	A00	2167	05.12.1963
000011	000130	DOLORES<	M	QUINTANA<	C01	4578	28.07.1971
000012	000140	HEATHER<	A	NICHOLLS<	C01	1793	15.12.1976
Command ==>						Scroll PAGE	
F1=Help	F2=Zoom	F3=Exit	F4=CRetrieve	F5=RFind	F6=RChange		
F7=Up	F8=Down	F9=Swap	F10=Left	F11=Right	F12=Cancel		

Multiple rows are displayed on the one panel (limited by the screen size). Each column of the table is formatted according to the data type for that column. For example, numeric data types are displayed as whole or decimal numbers, and date and time fields are displayed as dates or times.

By default, the headings are the names of the columns as defined in the Db2® catalog. You can change them by editing the template.

For SELECT statement View or Edit only, the heading might be displayed as COL nnn where nnn is 001, 002, and so on. This indicates a generated column name. Both of the following examples cause FM/Db2 to generate a column name:

```
SELECT 1, dbname FROM SYSIBM.SYSTABLES
```

```
SELECT CONCAT(dbname, tname) FROM SYSIBM.SYSTABLES
```

One or more columns in the FM/Db2 editor session might be protected. This can occur if:

- The object being edited has a primary key, and the **Allow updates to primary key** option is not selected.
- The object being edited is a read-only view.
- The object being edited is the result table from an arbitrary SELECT statement (that is, select statement edit).
- The object being edited is a table, but contains columns, excluding ROWID columns, marked as not updateable in the Db2® catalog. The Db2® catalog tables fall into this category.

If you display data in TABL display format, you can scroll up, down, left, and right.

To display the data in hexadecimal format, use the HEX primary command:

```
HEX ON
```

In TABL display format, the view or edit display always shows the column names for each displayed column (or the alternative field heading if you have defined one).

Optionally, you can display up to 3 additional information lines between the column heading line and the top of data. These are (in order):

- A line containing the column number (as defined in the Db2® catalog).
- A line containing the data type for the column (and the length for non-numeric fields).
- A line showing a ruler above each column. The ruler can include offset information and, optionally, information about primary and foreign keys, and unique indexes.

You can select which, if any, of these additional information lines are displayed on the editor display either:

- For *all* FM/Db2 editor sessions by setting the appropriate global option using the Editor Options panel, or
- For the *current* FM/Db2 editor session only:
 - For View, you set the appropriate option using the View (option 1) panel.
 - For Edit, you set the appropriate option using the Edit (option 2) panel.

Related tasks

[Working with templates on page 72](#)

[Scrolling on page 157](#)

[View and Edit options \(options 1 and 2\) on page 65](#)

[ROWID columns on page 104](#)

[Setting options for the current FM/Db2 editor session on page 123](#)

[Excluding rows on page 159](#)

Related references

[Db2 View panel on page 613](#)

[Db2 Edit panel on page 598](#)

[Editor Options \(1 of 8\) panel on page 625](#)

[HEX primary command on page 908](#)

SNGL display format

In SNGL display format, only one row of the table is displayed on the panel at the one time.

[Figure 51: Edit panel in SNGL display format \(with all optional columns displayed\) on page 153](#) shows an example of an edit display in SNGL display format.

Figure 51. Edit panel in SNGL display format (with all optional columns displayed)

Process	Options	Utilities	Help
FM/Db2 (DFG2)			Table Edit
TABLE FMUSER.EMP			1 of 42 Format <u>SNGL</u>
Top Column is 1 of 13 in Row 1			
Ref	Rdf	Key	Column Type(len) Data
#1		PU	EMPNO CH(6) 000010
#2			FIRSTNME VC(12) CHRISTINE<
#3			MIDINIT CH(1) I
#4			LASTNAME VC(15) HAAS<
#6			PHONENO CH(4) 3978
#7			HIREDATE DATE 01/01/1965
#8			JOB CH(8) PRES
#9			EDLEVEL SMINT 18
#10			SEX CH(1) F
#11			BIRTHDATE DATE 08/14/1933
#12			SALARY DEC(9,2) 52750.00
#13			BONUS DEC(9,2) 1000.00
#14			COMM DEC(9,2) 4220.00
**** End of record ****			
Command ==>			Scroll PAGE
F1=Help	F2=Zoom	F3=Exit	F4=CRetriev F5=RFind F6=RChange
F7=Up	F8=Down	F9=Swap	F10=Previous F11=Next F12=Cancel

The columns of the table are displayed vertically on the panel, with the column header on the left of the panel, and the data for that column on the right. Each column of the table is formatted according to the data type for that column. For example, numeric data types are displayed as whole or decimal numbers, and date and time fields are displayed as dates or times.

By default, the headings are the names of the columns as defined in the Db2® catalog. You can change them by editing the template.

For SELECT statement in a File Manager/Db2 editor session, the heading might be displayed as COL nnn where nnn is 001, 002, and so on. This indicates a generated column name. Both of the following examples cause FM/Db2 to generate a column name:

```
SELECT 1, dbname FROM SYSIBM.SYSTABLES
```

```
SELECT CONCAT(dbname, tname) FROM SYSIBM.SYSTABLES
```

One or more columns in the FM/Db2 editor session might be protected. This can occur if:

- The object being edited has a primary key, and the “Allow updates to primary key” option is not selected.
- The object being edited is a read-only view.
- The object being edited is the result table from an arbitrary SELECT statement (that is, select statement edit).
- The object being edited is a table, but contains columns, excluding ROWID columns, marked as not updateable in the Db2® catalog. The Db2® catalog tables fall into this category.

If you display data in SNGL display format, you can:

- Scroll within the row (up and down)
- Scroll forward and backward within the table (to show the next and previous non-excluded rows)

To display the data in hexadecimal format, use the HEX primary command `HEX ON`.

In SNGL display format, the view or edit display always shows two columns: the name of the column, and the data for that column.

Optionally, you can display up to three additional information columns. Two of these columns, **Ref** and **Key**, are displayed to the left of the column containing the column name; the third, **Type(Len)** is displayed between the name and data columns. If you choose to show all information columns, the displayed columns are (in order of appearance from left to right):

Ref

An optional column showing the column number (as defined in the Db2® catalog).

You can turn this optional column on and off with the REFS primary command. The value shown can be zero if displaying the result table from an arbitrary select statement (that is, select statement edit). This indicates either that the column is generated, or that the column is not a column of the first table named in the FROM clause of the SELECT statement that produced the result table.

Rdf

Unused.

Key

An optional column showing information about primary keys, foreign keys, unique indexes and check constraints.

You can turn this optional column on and off with the INDEXINF primary command.

Column

A column showing the column name.

This column may also show the start and end position of the character data displayed for a row. For this to occur:

1. The length of the data for the column must be long enough to require two or more rows to display.
2. The *"Show char position range"* editor option needs to be selected, or the CHARPOS command can be issued to turn on the character position range display. For more information, see [Editor Options \(3 of 8\) panel on page 634](#) and CHARPOS command [CHARPOS primary command on page 881](#).

Type(Len)

An optional column showing the data type for the column (and the length for non-numeric fields).

You can turn this optional column on and off with the TYPE primary command

Data

A column showing the (formatted) data for the column.

You can customize the view or edit display either:

- For *all* FM/Db2 editor sessions by setting the appropriate global option using the Editor Options panels, or
- For the *current* FM/Db2 editor session only:
 - For View, you set the appropriate option using the Db2® View panel.
 - For Edit, you set the appropriate option using the Db2® Edit panel.

Related tasks

[Working with templates on page 72](#)

[Scrolling on page 157](#)

Related references

[Db2 View panel on page 613](#)

[Db2 Edit panel on page 598](#)

[Editor Options \(1 of 8\) panel on page 625](#)

[HEX primary command on page 908](#)

[INDEXINF primary command on page 911](#)

[REFS primary command on page 932](#)

[TYPE primary command on page 944](#)

Zooming in to see all of a row

You can “*zoom in*” on a single row by pressing the Zoom function key (F2) or by using the ZOOM primary command.

In TABL display format, to display all data in a particular row without having to scroll left or right, move the cursor to the row, then press the Zoom function key (F2). FM/Db2 limits the display to just that row. In SNGL display format, just press the Zoom function key (F2).

If you zoom in on a row, only that row is displayed in “*zoomed*” SNGL display format. The zoomed display automatically scrolls to the field that was at the left of the panel, or, if applicable, the column where the cursor was positioned before zooming.

In “*zoomed*” SNGL display format, the word **Zoom** is displayed next to **Format** in the upper right corner of the panel as shown in [Figure 52: Zooming in on one row \(“*zoomed*” SNGL display format\) on page 156](#).

Figure 52. Zooming in on one row ("zoomed" SNGL display format)

Process	Options	Help			
FM/Db2 (DFG2)					
TABLE FMUSER.EMP					
Table Edit					
1 of 42					
Zoom Format <u>SNGL</u>					
in Row 1					
Ref	Key	Column Type(len) Data			
#1	PU	EMPNO CH(6)	000050		
#2		FIRSTNME VC(12)	JOHN<		
#3		MIDINIT CH(1)	B		
#4		LASTNAME VC(15)	GEYER<		
#5	NF	WORKDEPT CH(3)	E01		
#6		PHONENO CH(4)	6789		
#7		HIREDATE DATE	08/17/1949		
#8		JOB CH(8)	MANAGER		
#9		EDLEVEL SMINT	16		
#10		SEX CH(1)	M		
#11		BIRTHDATE DATE	09/15/1925		
#12		SALARY DEC(9,2)	40175.00		
#13		BONUS DEC(9,2)	800.00		
#14		COMM DEC(9,2)	3214.00		
**** End of record ****					
Command ==>					
F1=Help	F2=Zoom	F3=Exit	F4=CRetriev	F5=RFind	F6=RChange
F7=Up	F8=Down	F9=Swap	F12=Cancel		

If you view a record in "zoomed" SNGL display format, FM/Db2 displays all columns, regardless of whether they were selected for display in the template. FM/Db2 displays the columns in the order defined in the template. Any template re-sequencing is ignored. In this display format, you cannot navigate between rows or use the TEDIT primary command.

In TABL or normal "un-zoomed" SNGL display format, File Manager only shows the columns selected for display in the template.

For instance, in the example shown in [Figure 52: Zooming in on one row \("zoomed" SNGL display format\) on page 156](#), the columns WORKDEPT and BIRTHDATE are shown in "zoomed" SNGL display format, even though these columns happen to be "deselected" in the template. In "un-zoomed" SNGL display format, the same row is displayed:

Process	Options	Help			
FM/Db2 (DFG2)					
TABLE FMUSER.EMP					
Table Edit					
1 of 42					
Format <u>SNGL</u>					
in Row 1					
Ref	Rdf Key	Column Type(len) Data			
#2		FIRSTNME VC(12)	JOHN<		
#3		MIDINIT CH(1)	B		
#4		LASTNAME VC(15)	GEYER<		
#6		PHONENO CH(4)	6789		
#7		HIREDATE DATE	08/17/1949		
#8		JOB CH(8)	MANAGE		
#9		EDLEVEL SMINT	16		
#10		SEX CH(1)	M		
#12		SALARY DEC(9,2)	40175.00		
#13		BONUS DEC(9,2)	800.00		
#14		COMM DEC(9,2)	3214.00		
**** End of record ****					
Command ==>					
F1=Help	F2=Zoom	F3=Exit	F4=CRetriev	F5=RFind	F6=RChange
F7=Up	F8=Down	F9=Swap	F10=Previous	F11=Next	F12=Cancel

In "un-zoomed" SNGL display format, you can navigate between rows using the PREVIOUS and NEXT primary commands or the Previous function key (F10) and the Next function key (F11).

To return to the display format that was current before zooming in, enter the ZOOM primary command again, or the CANCEL, END, or EXIT command.

Related tasks

[TABL display format on page 150](#)

[SNGL display format on page 152](#)

Related references

[ZOOM primary command on page 952](#)

[TEDIT primary command on page 943](#)

Scrolling

To scroll through your data, press the following function keys:

Press this function key

To...

Up function key (F7)

Scroll backward (up)

Down function key (F8)

Scroll forward (down)

In TABL display format:

Right function key (F11)

Scroll right

Left function key (F10)

Scroll left

In SNGL display format:

Next function key (F11)

Go to the next row

Previous function key (F10)

Go to the previous row

You can also scroll using the primary commands UP, DOWN, LEFT, RIGHT, TOP, BOTTOM, NEXT and PREVIOUS.

Related tasks

[TABL display format on page 150](#)

[SNGL display format on page 152](#)

[Holding columns on the display when scrolling on page 97](#)

Related references

[ZOOM primary command on page 952](#)

[TEDIT primary command on page 943](#)

[UP primary command on page 945](#)

[DOWN primary command on page 885](#)

[LEFT primary command on page 912](#)

[RIGHT primary command on page 934](#)

[TOP primary command on page 944](#)

[BOTTOM primary command on page 872](#)

[NEXT primary command on page 923](#)

[PREVIOUS primary command on page 927](#)

Controlling how far you scroll

To control how far you scroll when you press one of the scrolling function keys, enter a scroll amount in the **Scroll** field:

Scroll amount

Scrolls...

PAGE

One panel at a time

HALF

Half a panel at a time

DATA

One line or panel column less than a screen at a time

CSR

To the cursor position (if the cursor is not positioned on a row when the scroll is performed, the default scroll amount is PAGE)

nnnn

A number of panel columns (if scrolling left or right) or rows (when scrolling up or down) at a time



Note:



1. In TABL display format, you can temporarily override the amount in the **Scroll** field by typing a scroll amount on the command line, then pressing a scroll function key. For example, if you enter `8` on the command line, then press the Right function key (F11), FM/Db2 scrolls right 8 panel columns.
2. In SNGL display format, you can specify the number of rows FM/Db2 scrolls forward or backward by typing a number on the command line, then pressing the Next function key (F11) or the Previous function key (F10). For example, if you enter `5` on the command line, then press the Next function key (F11), FM/Db2 scrolls forward 5 rows.
3. In TABL display format, the position that the cursor occupies after you scroll left or right depends on the data type of the Db2® column that occupies the resultant panel column:
 - If the data type of the Db2® column is non-numeric, scrolling left or right moves to the relative panel column within the Db2® column (for small columns, scrolling moves to the start of the column).
 - If the data type of the Db2® column is numeric, scrolling left or right moves to the start of the Db2® column.

Scrolling to the first or last row or column

To scroll to the first or last row or column in the table, type `MAX` (or `M`) on the command line, then press one of the scroll function keys. For example, typing `M` then pressing the Right function key (F11) scrolls right to the last column.

You can also scroll to the first or last row by entering `TOP` or `BOTTOM` on the command line.

Excluding rows

When you are viewing or editing data, you can “exclude” certain rows in the data you are viewing. These rows are referred to as *excluded rows* and are not displayed on your screen. The remaining rows (those that *are* displayed on your screen) are referred to as *non-excluded rows*.

You may choose to exclude certain rows to restrict the scope of the CHANGE, DELETE, and FIND primary commands. When you use one of these commands with data that contains excluded rows and non-excluded rows, you can specify whether the command is to affect:

- Only non-excluded rows,
- Only excluded rows, or
- All rows

To exclude certain rows in the table you are viewing, you can use:

- The EXCLUDE primary command. For example, the following command excludes all rows with the string “SMITH” in column number 3:

```
EXCLUDE ALL SMITH #3
```

The following command excludes the next row containing the string “XXX” within either column number 20 or column number 30:

```
EXCLUDE XXX #20 #30
```

You can exclude a range of rows identified by a “*from*” label and a “*to*” label. For example, the following command excludes a range of rows, starting with the row labeled “.LABA” and ending with the row labeled “.LABB”:

```
EXCLUDE ALL .LABA .LABB
```

In a File Manager/Db2 editor session, you can specify an asterisk (*) as the search string to find the same string as you specified on the previous EXCLUDE primary command.

In a File Manager/Db2 editor session, you can limit the effect of the EXCLUDE command to specific portions of the data you are searching:

- To limit the search for a string to only where it appears as a *prefix* in the data, specify the PREFIX parameter.
 - To limit the search for a string to only where it appears as a *suffix* in the data, specify the SUFFIX parameter.
 - To limit the search for a string to only where it appears as a *word* in the data, specify the WORD parameter.
- The following prefix commands:

X

Exclude one row.

Xn

Exclude *n* rows.

XX

Exclude a block of rows.

You can use the following line commands to show various rows from a block of excluded rows:

F

Show the first row from a block of excluded rows.

Fn

Show the first *n* rows from a block of excluded rows.

L

Show the last row from a block of excluded rows.

Ln

Show the last *n* rows from a block of excluded rows.

Related tasks

[Showing or hiding excluded rows on page 161](#)

Related references

[EXCLUDE primary command on page 888](#)

[CHANGE primary command on page 875](#)

[DELETE primary command on page 882](#)

[FIND primary command on page 897](#)

Showing or hiding excluded rows

In TABL display format, you can choose to hide excluded rows from display, or represent them by shadow lines:

```
----- n line(s) excluded
```

The SHADOW primary command controls whether shadow lines are shown or hidden. To turn on shadow lines for excluded rows, enter `SHADOW ON`. To turn off shadow lines for excluded rows, enter `SHADOW OFF`.

In SNGL display format, shadow lines are not displayed. If you use the Next function key (F11) or Previous function key (F10) to scroll through rows in SNGL display format, the only indication that an excluded row has been skipped is that the row number (shown in the upper right corner of the panel) skips accordingly.

To redisplay excluded rows, enter the following command:

```
RESET EXCLUDED
```

Related tasks

[TABL display format on page 150](#)

[SNGL display format on page 152](#)

Related references

[SHADOW primary command on page 937](#)

[RESET primary command on page 932](#)

Sorting the data

To sort the data you are viewing or editing in TABL display format, use the SORT primary command.

You can specify up to 5 column numbers (the most significant first) and whether you want the data sorted in ascending (the default sequence) or descending sequence for each column number you specify.

Examples

```
SORT #7 D #6 #3
```

Sorts all rows on the column with column number #7 (primary sort key) in descending order, then on the column with column number #6 (secondary sort key) in ascending order, then on the column with column number #3 (minor sort key) in ascending order,

```
SORT #6 X
```

Sorts all excluded rows on the column with column number #6 in ascending order (as if non-excluded rows did not exist).



Note: The SORT command only changes the order in which you view the data; it has no effect on the order in which the data is stored within Db2®.

Related references

[SORT primary command on page 941](#)

Displaying data in hexadecimal format

To display the data you are browsing or editing in hexadecimal format, use the HEX primary command.

For example, if your display looks something like this:

```

NAME          CREATOR  TYPE  DBNAME  TSNAME  DBID  OBID
#1            #2      #3   #4      #5      #6    #7
VARCHAR(18)   CH(8)   CH(1) CH(8)   CH(8)   SMINT SMINT
<-----1-----> <-----> - <-----> <-----> <-----> <----->
000000 **** Top of data ****
000001 SYSCOPY      SYSIBM  T      DSND06  SYSCOPY  00006 00046
000002 SYSFIELDS   SYSIBM  T      DSND06  SYSDBASE 00006 00021

```

then issuing the command HEX ON causes the hexadecimal representation to be displayed:

```

NAME          CREATOR  TYPE  DBNAME  TSNAME  DBID  OBID
#1            #2      #3   #4      #5      #6    #7
VARCHAR(18)   CH(8)   CH(1) CH(8)   CH(8)   SMINT SMINT
<-----1-----> <-----> - <-----> <-----> <-----> <----->
000000 **** Top of data ****
000001 SYSCOPY      SYSIBM  T      DSND06  SYSCOPY  00006 00046
      EEECDDE0000000000000 EEECD44 E      CEDCCFF4 EEECDDE4      00      02
      28236780000000000000 28292400 3      42542060 28236780      06      0E
000002 SYSFIELDS   SYSIBM  T      DSND06  SYSDBASE 00006 00021
      EEECCDCE000000000000 EEECD44 E      CEDCCFF4 EEECCCEC      00      01
      28269534200000000000 28292400 3      42542060 28242125      06      05

```

Related references

[HEX primary command on page 908](#)

Managing the prefix area

The prefix area displays line numbers that represent the row number in the Db2® table or view being edited.

The prefix area also doubles as the prefix command entry area. You enter prefix commands by overtyping the row number for the appropriate row.

You can use prefix commands to:

- Insert or delete rows
- Repeat (duplicate) rows
- Move rows

- Shift data
- Limit the data being edited

In a File Manager/Db2 editor session, to see which prefix commands are valid for the current environment, enter an "?" in the prefix area (against any listed line). FM/Db2 displays a list of the line commands you can enter, like those shown in [Figure 53: Using the ? prefix command to display a list of valid prefix commands on page 163](#).

Figure 53. Using the ? prefix command to display a list of valid prefix commands

```

Process  Options  Utilities  Help
                FM/Db2 Available Edit Prefix Commands

Prefix commands

You can enter the following commands in the prefix area of the data display:

A      identifies the record after which data is to be moved or copied.
B      identifies the record before which data is to be moved or copied.
C      copy one record.
Cn     copy n records.
CC     copy block of records. Mark start and end of block.

D      delete one record.
Dn     delete n records.
DD     delete block of records. Mark start and end of block.

E      displays information about why Db2 rejected the change to a row

F      display the first record of a block of excluded records.
Command ==>>
F1=Help   F2=Split   F3=Exit   F4=CRetriev  F7=Backward  F8=Forward
F9=Swap   F10=Actions F12=Cancel

```

In a File Manager/Db2 editor session, you can choose whether a prefix area is displayed next to the data or not.

To specify the default position and display state of the prefix area for *all* FM/Db2 editor sessions, set these editor options on the relevant Editor Options panel (0.2):

- **Display prefix area**
- **Display prefix area on the right**
- **Prefix area width (A,6,7,8,9)**

To specify the default position and display state of the prefix area for the *current* FM/Db2 editor session, use the PREFIX primary command. For example:

- To display the prefix area on the right, enter `PREFIX RIGHT`.
- To display the prefix area as an 8-digit field, enter `PREFIX 8`.
- To display the prefix area with a width that automatically adjusts (from 6 to 9 digits wide) in order to display the record number, enter `PREFIX A`.
- To remove the display of the prefix area, enter `PREFIX OFF`.

Related references

[PREFIX primary command on page 926](#)

Displaying the column number

In SNGL display format, use the REFS primary command to show or hide the column number for each displayed column:

- If the column numbers are not currently displayed, FM/Db2 displays an additional column (to the left of the column containing the column name and, if displayed, to the left of the column showing index information) showing the column number for each column.

If you enter the REFS primary command in TABL display format, the display is unaltered. However, if you change to SNGL display format, the display status of the additional column is reversed.

- If the column numbers are already displayed, the REFS primary command removes them from display.



Note: You can also display the column numbers by selecting the **Show column number** option (for TABL, SNGL, or both display formats).

Related references

[REFS primary command on page 932](#)

[Editor Options \(3 of 8\) panel on page 634](#)

Displaying the data type

In SNGL display format, use the TYPE primary command to show or hide the data type (and, for non-numeric columns, the length of the column) for each displayed column:

- If the data type details are not currently displayed, FM/Db2 displays an additional column (between the name and data columns) showing the data type details for each column.

If you enter the TYPE primary command in TABL display format, the display is unaltered. However, if you change to SNGL display format, the display status of the additional column is reversed.

- If the data type details are already displayed, the TYPE primary command removes them from display.



Note: You can also display the data type details by selecting the **Show data type** option (for TABL, SNGL, or both display formats).

Related references

[REFS primary command on page 932](#)

[Editor Options \(3 of 8\) panel on page 634](#)

Handling special data

The following sections describe how to work with special types of data.

DATE and TIME columns

Db2® accepts dates and times in a number of formats.

DATE columns

In a File Manager/Db2 editor session, the display format for DATE columns depends on the setting of the DATE parameter in the Db2® DSNHDECP installation module. For further information, see your Db2® systems administrator, the *Db2 UDB for z/OS SQL Reference*, or other Db2® manuals.

If you edit a DATE column, you can enter a date in any format recognized by Db2®. FM/Db2 converts the date you enter into the appropriate display format. For example, to set the contents of a DATE column to represent September 27, 2004, you can enter `27.09.2004`.

However, you need to be careful when choosing the separator character. If you try to enter `27/09/2004`, FM/Db2 interprets “27” as a month and rejects the date as incorrect. A more subtle example is `08/05/1900` and `08.05.1900`. FM/Db2 interprets the first as 5 August, 1900, but the second as May 8, 1900.

TIME columns

In a File Manager/Db2 editor session, the display format for TIME columns depends on the setting of the **External Format for TIME Data Type Columns** System Option.

If you edit a TIME column, you can enter a time in any format recognized by Db2®. FM/Db2 converts the time you enter into the appropriate display format.

If you enter times in USA format (`hh.mm AM` or `PM`), the absence of *second* information means that the time is stored internally as `hh.mm.00` (that is, the seconds portion is always set to zero). This can cause unexpected results when comparing different TIME columns that have the same display format but different internal representations with respect to seconds.

Related tasks

[FM/Db2 system options \(option 0.2\) on page 63](#)

Related references

[Systems Options \(1 of 4\) panel on page 817](#)

Large numeric fields

If FM/Db2 generates a template, it sets the column width for numeric columns such that any value can be correctly displayed.

However, if as a result of editing the template, a numeric column contains a valid numeric value, but the value is too large to fit in the width allocated to the column (as defined in the template), the value is truncated. The column is highlighted to indicate that truncation has occurred.

To display the entire column without truncation, you need to edit the template, and specify an output width for the column:

1. Enter `TEDIT` on the command line to display the Column Selection/Edit panel.
2. Enter `E` template editor prefix command in the Prefix Command area to display the Column Attributes panel.
3. In the **Output width** field, enter a value that is wide enough to display the entire column.
4. Press the Exit function key (F3) key until you are back at the editor panel.

Related references

[Column Selection/Edit panel on page 485](#)

[EXCLUDE primary command on page 888](#)

[FIND primary command on page 897](#)

[TEDIT primary command on page 943](#)

Working with large tables

When operating in view mode, FM/Db2 allows you to process large Db2® tables without the need to specify a large TSO region size. This feature is not available if the product installer has chosen to disable it.

A number of options and processes associated with working with large tables are available and described in these sections:

- [SQL optimization options on page 166](#)
- [Large table options on page 167](#)
- [Data sampling on page 167](#)

SQL optimization options

You set the **Optimization options** on the on the Editor Options (2 of 8) panel to specify a `OPTIMIZE FOR nnn ROWS` clause in the SQL statement used to retrieve data from Db2®.

[Table 6: Effect of SQL optimization options on page 166](#) describes the behavior for various combinations of options:

Table 6. Effect of SQL optimization options

Use row count value	Row count	Optimize for ... Rows	Behavior
Not selected	0	0	No clause
Not selected	0	<i>nnn</i>	OPTIMIZE FOR <i>nnn</i> ROWS appended
Not selected	<i>nnn</i>	0	No clause
Not selected	<i>nnn</i>	<i>mmm</i>	OPTIMIZE FOR <i>mmm</i> ROWS appended
Selected	0	0	No clause
Selected	0	<i>nnn</i>	OPTIMIZE FOR <i>nnn</i> ROWS appended
Selected	<i>nnn</i>	0	OPTIMIZE FOR <i>nnn</i> ROWS appended

Table 6. Effect of SQL optimization options (continued)

Use row count value	Row count	Optimize for ... Rows	Behavior
Selected	<i>nnn</i>	mmm	OPTIMIZE FOR <i>nnn</i> ROWS appended

Related references

[Editor Options \(2 of 8\) panel on page 630](#)

Large table options

You can set the **Scrollable cursor type** option on the Editor Options (2 of 8) panel to either 1 (Insensitive) or 2 (Sensitive static). When processing a large Db2® object in place holder mode only, FM/Db2 uses the appropriate type of scrollable cursor. There is no simple method for you to determine which type of scrollable cursor is in use. A DBG trace shows the SQL statement used to declare the cursor and fetch the data.

Related references

[Editor Options \(2 of 8\) panel on page 630](#)

Data sampling

Data sampling allows you specify that a subset of the rows in a Db2® object are loaded into the editor. This can be particularly useful when you are working with very large Db2® tables and require a representative sample of the data.

The **Sampling type** option on the Editor Options (2 of 8) panel allows you to specify how you want FM/Db2 to select rows from a Db2® object in order to provide sample data:

Clustered sampling

A specified number of rows are loaded into the editor.

Random sampling

Each row of the object is considered for inclusion in the editor. A random number generator and a frequency are used to determine whether the row is actually loaded.

Each of these two methods of selecting sample data are discussed here in detail.

Clustered data sampling

To specify clustered data sampling, set the **Sampling type** option on the Editor Options (2 of 8) panel to **2. Clustered sampling**.

These points describe the behavior of the FM/Db2 editor when using clustered data sampling:

- Data sampling applies to browse, view, and edit.
- When using data sampling, the editor always loads all sampled rows into memory. Therefore large table support is NOT available when sampling data.

- The options that are pertinent to clustered sampling are:
 - **Row count** on the function entry panel.
 - **Start position** on the function entry panel.
 - **Sampling limit** on the Editor Options (2 of 8) panel.
 - **Initial skip count** on the Editor Options (2 of 8) panel.
 - **Include count** on the Editor Options (2 of 8) panel.
 - **Skip count** (final) on the Editor Options (2 of 8) panel.

Table 7: Behavior of FM/Db2 editor for options related to clustered data sampling on page 168 describes the behavior of the FM/Db2 editor for various options related to clustered data sampling.

Table 7. Behavior of FM/Db2 editor for options related to clustered data sampling

Row count	Start position	Sampling limit	Initial skip count	Include count	Skip count	Behavior
0	1	0	0	<i>nnn</i>	0	All rows sampled
0	1	<i>bbb</i>	0	<i>nnn</i>	0	<i>bbb</i> rows sampled ¹² .
<i>rrr</i>	1	0	0	<i>nnn</i>	0	<i>rrr</i> rows sampled. ¹²
<i>rrr</i>	1	<i>bbb</i>	0	<i>nnn</i>	0	The minimum of (<i>rrr</i> , <i>bbb</i>) rows are sampled. ¹²
0	<i>sss</i>	0	0	<i>nnn</i>	0	Rows sampled from <i>sss</i> until the end of table.
0	<i>sss</i>	<i>bbb</i>	0	<i>nnn</i>	0	<i>bbb</i> rows sampled, commencing <i>sss</i> . ¹²
<i>rrr</i>	<i>sss</i>	0	0	<i>nnn</i>	0	<i>rrr</i> rows sampled, commencing <i>sss</i> . ¹²
<i>rrr</i>	<i>sss</i>	<i>bbb</i>	0	<i>nnn</i>	0	The minimum of (<i>rrr</i> , <i>bbb</i>) rows are sampled, commencing <i>sss</i> . ¹²
0	1	0	<i>xxx</i>	<i>nnn</i>	<i>yyy</i>	Rows are sampled in groups of <i>xxx+nnn+yyy</i> rows. Within each group, <i>xxx</i> rows are skipped; <i>nnn</i> rows are sampled and <i>yyy</i> rows are skipped. The first group starts are row 1, the second group at (<i>xxx+nnn+yyy+1</i>). Groups are sampled until the end of the result table. ¹²
0	1	<i>bbb</i>	<i>xxx</i>	<i>nnn</i>	<i>yyy</i>	Rows are sampled in groups of <i>xxx+nnn+yyy</i> rows. Within each group, <i>xxx</i> rows are skipped; <i>nnn</i> rows are sampled and <i>yyy</i> rows are skipped. The first group starts are row 1, the

12. Sampling continues until one of these conditions is met:

- Any non-zero **Sampling limit** is reached.
- Any non-zero **Row count** limit is reached.
- The end of the result table is reached.

Table 7. Behavior of FM/Db2 editor for options related to clustered data sampling

(continued)

Row count	Start position	Sampling limit	Initial skip count	Include count	Skip count	Behavior
						second group at $(xxx+nnn+yyy+1)$. Groups are sampled until bbb rows are loaded. ¹²
rrr	1	0	xxx	nnn	yyy	Rows are sampled in groups of $xxx+nnn+yyy$ rows. Within each group, xxx rows are skipped; nnn rows are sampled and yyy rows are skipped. The first group starts are row 1, the second group at $(xxx+nnn+yyy+1)$. Groups are sampled until rrr rows are loaded. ¹²
rrr	1	bbb	xxx	nnn	yyy	Rows are sampled in groups of $xxx+nnn+yyy$ rows. Within each group, xxx rows are skipped; nnn rows are sampled and yyy rows are skipped. The first group starts are row 1, the second group at $(xxx+nnn+yyy+1)$. Groups are sampled until the minimum of (bbb,rrr) rows are loaded. ¹²
rrr	sss	bbb	xxx	nnn	yyy	Rows are sampled in groups of $xxx+nnn+yyy$ rows. Within each group, xxx rows are skipped; nnn rows are sampled and yyy rows are skipped. The first group starts are row sss , the second group at $sss+(xxx+nnn+yyy)$. Groups are sampled until the minimum of (bbb,rrr) rows are loaded. ¹²

Random data sampling

To specify random data sampling, set the **Sampling type** option on the Editor Options (2 of 8) panel to **3. Random sampling**.

These points describe the behavior of the FM/Db2 editor when using random data sampling:

- Data sampling applies to browse, view, and edit.
- When using data sampling, the editor always loads all sampled rows into memory. Therefore large table support is NOT available when sampling data.
- The options that are pertinent to random sampling are:
 - **Row count** on the function entry panel.
 - **Start position** on the function entry panel.
 - **Sampling limit** on the Editor Options (2 of 8) panel.
 - **Sampling frequency** on the Editor Options (2 of 8) panel.
 - **Sampling seed** on the Editor Options (2 of 8) panel.

Table 8: Behavior of FM/Db2 editor for options related to random data sampling on page 170 describes the behavior of the FM/Db2 editor for various options related to random data sampling.

Table 8. Behavior of FM/Db2 editor for options related to random data sampling

Row count	Start position	Sampling limit	Sampling frequency	Sample seed	Behavior ¹³
0	1	0	0.fff	0	Rows are fetched, starting at row 1 and continuing until the end of the result table.
0	1	bbb	0.fff	0	Rows are fetched, starting at row 1 and continuing until the end of the result table, or until <i>bbb</i> rows have been added to the editor.
rrr	1	0	0.fff	0	<i>rrr</i> rows are fetched, starting at the first row. Some subset (approximately 0.fff x <i>rrr</i>) of these rows is added to the sample data set.
rrr	1	bbb	0.fff	0	At most <i>rrr</i> rows are fetched, starting at the first row. Some subset (approximately 0.fff x <i>rrr</i>) of these rows, but at most <i>bbb</i> rows, is added to the sample data set.

13. 1. Sampling continues until one of the following conditions is met:

- Any non-zero Sampling limit is reached.
- Any non-zero Row count (fetch) limit is reached.
- The end of the result table is reached.

The Sampling limit sets an upper bound on the number of rows loaded into the editor. This is the number of rows in an editor session. To reach this many rows, approximately $1/(\text{Sampling frequency} \times \text{Sampling limit})$ rows must be fetched. By contrast, the Row count limit sets an upper bound on the number of rows that are fetched from the object. The number of rows that are sampled is approximately Row count x Sampling frequency.

With "small" sampling frequencies, specifying a low Row count limit may result in no rows being sampled. For example, with a Row count limit of 60, a Sampling count of 2000, and a Sampling frequency of 0.01, there is a reasonable chance that no rows are sampled.

2. A Sampling frequency of 0.fff results in, on average and for large numbers of rows sampled, 0.fff x 100% of rows being sampled. Therefore a frequency of 0.1 results in 10% of rows being sampled. For small frequencies, many rows need to be processed to find each matching row. For any particular random sample of data there is no guarantee that the number of rows in the sample will exactly reflect the sampling frequency.

When a Sampling seed value of 0 is specified, FM/Db2 uses the fraction part of the second's value derived from the current system clock value to initiate the random number generator. This value is accurate to the microsecond; therefore each seed has a value in the range 0–999999 inclusive. It is unlikely that two random samples generated with a sampling seed of 0 will be identical.

When the same user-specified Sampling seed is used for the same table and other conditions, the data samples produced will be identical.

Table 8. Behavior of FM/Db2 editor for options related to random data sampling

(continued)

Row count	Start position	Sampling limit	Sampling frequency	Sample seed	Behavior ¹³
0	sss	0	0.fff	0	Rows are sampled, starting at row sss, and continuing until the end of the result table.
0	sss	bbb	0.fff	0	Rows are fetched, starting at row sss, and continuing until the end of the result table or until bbb rows have been added to the editor.
rrr	sss	0	0.fff	0	rrr rows are fetched, starting at row sss. Some subset (approximately 0.fff x rrr) of these rows is added to the sample data set.
rrr	sss	bbb	0.fff	0	At most rrr rows are fetched, starting at row sss. Some subset (approximately 0.fff x rrr) of these rows, but at most bbb rows, is added to the sample data set.
0	1	0	0.fff	0	Rows are fetched, starting at row 1 and continuing until the end of the result table. The random number generator starts with seed yyy.

13. 1. Sampling continues until one of the following conditions is met:
- Any non-zero Sampling limit is reached.
 - Any non-zero Row count (fetch) limit is reached.
 - The end of the result table is reached.

The Sampling limit sets an upper bound on the number of rows loaded into the editor. This is the number of rows in an editor session. To reach this many rows, approximately $1/(\text{Sampling frequency} \times \text{Sampling limit})$ rows must be fetched. By contrast, the Row count limit sets an upper bound on the number of rows that are fetched from the object. The number of rows that are sampled is approximately Row count x Sampling frequency.

With "small" sampling frequencies, specifying a low Row count limit may result in no rows being sampled. For example, with a Row count limit of 60, a Sampling count of 2000, and a Sampling frequency of 0.01, there is a reasonable chance that no rows are sampled.

2. A Sampling frequency of 0.fff results in, on average and for large numbers of rows sampled, 0.fff x 100% of rows being sampled. Therefore a frequency of 0.1 results in 10% of rows being sampled. For small frequencies, many rows need to be processed to find each matching row. For any particular random sample of data there is no guarantee that the number of rows in the sample will exactly reflect the sampling frequency.

When a Sampling seed value of 0 is specified, FM/Db2 uses the fraction part of the second's value derived from the current system clock value to initiate the random number generator. This value is accurate to the microsecond; therefore each seed has a value in the range 0–999999 inclusive. It is unlikely that two random samples generated with a sampling seed of 0 will be identical.

When the same user-specified Sampling seed is used for the same table and other conditions, the data samples produced will be identical.

Table 8. Behavior of FM/Db2 editor for options related to random data sampling

(continued)

Row count	Start position	Sampling limit	Sampling frequency	Sample seed	Behavior ¹³
0	1	<i>bbb</i>	<i>0.fff</i>	0	Rows are fetched, starting at row 1 and continuing until the end of the result table, or until <i>bbb</i> rows have been added to the editor. The random number generator starts with seed <i>yyy</i> .
<i>rrr</i>	1	0	<i>0.fff</i>	0	<i>rrr</i> rows are fetched, starting at the first row. Some subset (approximately $0.fff \times rrr$) of these rows is added to the sample data set. The random number generator starts with seed <i>yyy</i> .
<i>rrr</i>	1	<i>bbb</i>	<i>0.fff</i>	0	At most <i>rrr</i> rows are fetched, starting at the first row. Some subset (approximately $0.fff \times rrr$) of these rows, but at most <i>bbb</i> rows, is added to the sample data set. The random number generator starts with seed <i>yyy</i> .
0	<i>sss</i>	0	<i>0.fff</i>	0	Rows are sampled, starting at row <i>sss</i> and continuing until the end of the result table. The random number generator starts with seed <i>yyy</i> .

Sampling continues until one of the following conditions is met:

13. 1.
 - Any non-zero Sampling limit is reached.
 - Any non-zero Row count (fetch) limit is reached.
 - The end of the result table is reached.

The Sampling limit sets an upper bound on the number of rows loaded into the editor. This is the number of rows in an editor session. To reach this many rows, approximately $1/(\text{Sampling frequency} \times \text{Sampling limit})$ rows must be fetched. By contrast, the Row count limit sets an upper bound on the number of rows that are fetched from the object. The number of rows that are sampled is approximately Row count x Sampling frequency.

With "small" sampling frequencies, specifying a low Row count limit may result in no rows being sampled. For example, with a Row count limit of 60, a Sampling count of 2000, and a Sampling frequency of 0.01, there is a reasonable chance that no rows are sampled.

2. A Sampling frequency of *0.fff* results in, on average and for large numbers of rows sampled, $0.fff \times 100\%$ of rows being sampled. Therefore a frequency of 0.1 results in 10% of rows being sampled. For small frequencies, many rows need to be processed to find each matching row. For any particular random sample of data there is no guarantee that the number of rows in the sample will exactly reflect the sampling frequency.

When a Sampling seed value of 0 is specified, FM/Db2 uses the fraction part of the second's value derived from the current system clock value to initiate the random number generator. This value is accurate to the microsecond; therefore each seed has a value in the range 0–999999 inclusive. It is unlikely that two random samples generated with a sampling seed of 0 will be identical.

When the same user-specified Sampling seed is used for the same table and other conditions, the data samples produced will be identical.

Table 8. Behavior of FM/Db2 editor for options related to random data sampling

(continued)

Row count	Start position	Sampling limit	Sampling frequency	Sample seed	Behavior ¹³
0	sss	bbb	0.fff	0	Rows are fetched, starting at row sss and continuing until the end of the result table, or until bbb rows have been added to the editor. The random number generator starts with seed yyy.
rrr	sss	0	0.fff	0	rrr rows are fetched, starting at row sss. Some subset (approximately 0.fff x rrr) of these rows is added to the sample data set. The random number generator starts with seed yyy.
rrr	sss	bbb	0.fff	0	At most rrr rows are fetched, starting at row sss. Some subset (approximately 0.fff x rrr) of these rows, but at most bbb rows, is added to the sample data set. The random number generator starts with seed yyy.

Related references

13. 1. Sampling continues until one of the following conditions is met:
- Any non-zero Sampling limit is reached.
 - Any non-zero Row count (fetch) limit is reached.
 - The end of the result table is reached.

The Sampling limit sets an upper bound on the number of rows loaded into the editor. This is the number of rows in an editor session. To reach this many rows, approximately $1/(\text{Sampling frequency} \times \text{Sampling limit})$ rows must be fetched. By contrast, the Row count limit sets an upper bound on the number of rows that are fetched from the object. The number of rows that are sampled is approximately Row count x Sampling frequency.

With "small" sampling frequencies, specifying a low Row count limit may result in no rows being sampled. For example, with a Row count limit of 60, a Sampling count of 2000, and a Sampling frequency of 0.01, there is a reasonable chance that no rows are sampled.

2. A Sampling frequency of 0.fff results in, on average and for large numbers of rows sampled, 0.fff x 100% of rows being sampled. Therefore a frequency of 0.1 results in 10% of rows being sampled. For small frequencies, many rows need to be processed to find each matching row. For any particular random sample of data there is no guarantee that the number of rows in the sample will exactly reflect the sampling frequency.

When a Sampling seed value of 0 is specified, FM/Db2 uses the fraction part of the second's value derived from the current system clock value to initiate the random number generator. This value is accurate to the microsecond; therefore each seed has a value in the range 0–999999 inclusive. It is unlikely that two random samples generated with a sampling seed of 0 will be identical.

When the same user-specified Sampling seed is used for the same table and other conditions, the data samples produced will be identical.

[Db2 Browse panel on page 595](#)

[Db2 Edit panel on page 598](#)

[Db2 View panel on page 613](#)

[Editor Options \(2 of 8\) panel on page 630](#)

Null values and VARCHAR processing

FM/Db2 provides different options for processing null values, and varying-length columns.

Null column indicator character

FM/Db2 provides options that you can use to specify two null column characters:

Null column indicators: Input

For use when editing a null column

Null column indicators: Display

Indicates a null column when it is displayed

In a File Manager/Db2 editor session, entering the null column input indicator character in the first (leftmost) column of a column that permits null values indicates that the column is to have a null value. For FM/Db2 to recognize the null column input indicator character, you must type the selected character in the first position of the input field, and remove all the remaining characters.

FM/Db2 also provides an option whereby it interprets a column containing spaces as containing a null value.

Related references

[Editor Options \(4 of 8\) panel on page 641](#)

Varying-length columns

You can use FM/Db2 options to specify two string delimiter characters:

String delimiters: Input

For use when editing a varying-length column

String delimiters: Display

Indicates the end of a varying-length column when it is displayed

You can also select an option (**Remove trailing spaces**) to control how FM/Db2 interprets trailing spaces in a varying-length column.

The following examples show the effect of the **Remove trailing spaces** option, and the use of the string delimiter character (“#” in this case), if you specify a string (for a varying-length column) in a File Manager/Db2 editor session. In the examples, “>” and “<” indicate the start and end of the data you type.

- If the **Remove trailing spaces** option is selected, trailing spaces are removed:

```
Example string #<
```

Stored as "Example string".

- If the **Remove trailing spaces** option is not selected, trailing spaces are not removed:

```
Example string #<
```

Stored as "Example string ".

Related tasks

[View and Edit options \(options 1 and 2\) on page 65](#)

[Setting options for the current FM/Db2 editor session on page 123](#)

Related references

[Editor Options \(5 of 8\) panel on page 645](#)

Unicode data

The FM/Db2 editor handles character data stored in Unicode differently to data stored in EBCDIC or ASCII. The differences are summarized here.

FM/Db2 normally retrieves character data from Db2® with automatic conversion to the CCSID of the FM/Db2 plan, normally CCSID 37. This is US EBCDIC; other EBCDIC CCSIDs may also be used.

When FM/Db2 retrieves character data stored in Unicode (within Db2®), this automatic data conversion does not occur. The FM/Db2 editor processes the character data internally in native Unicode format. This means that, prior to display on the terminal, the data is converted from Unicode to the CCSID of the terminal. This may result in conversion errors when a Unicode character has no corresponding code point in the CCSID of the terminal. Any characters that cannot be converted are shown on the display as periods, indicating an unconverted character. When data displayed (and possibly changed) on the terminal is processed, it is converted from the CCSID of the terminal into Unicode, prior to submission to Db2®. This conversion will always be successful, since Unicode includes code points for all characters in commonly used CCSIDs.

Data corruption is possible when the displayed data includes a period indicating an unconverted Unicode character, and the data for the column is changed by overtyping. Any periods in the modified data are converted to the Unicode equivalent. Therefore, if the period represents an unconverted Unicode character, that character will be corrupted by the change. When character data is displayed in hexadecimal mode, the hexadecimal characters normally represent the encoding for the displayed character in the CCSID of the terminal. For example, 'A' is represented by 'C1'x in EBCDIC. When the character data is for a Unicode-encoded column, the hexadecimal characters represent the native Unicode data, not the encoding of the displayed character in the CCSID of the terminal. For example, 'A' is represented by '41'x when Unicode data is being displayed.

You can also make changes to the data in a column stored in Unicode by turning hexadecimal display on (HEX ON command) and overtyping the hexadecimal characters directly. When you do this, you should use the Unicode representation of any character, not the terminal's CCSID representation.

Assuming the target column is character data stored within Db2® in Unicode, the FIND, CHANGE, and EXCLUDE commands operate like this:

- Strings such as 'ABC' are converted to Unicode prior to any search or change occurring.
- Hexadecimal strings such as '414243'x are *not* converted to Unicode prior to any search or change occurring. Therefore `F 'ABC'` and `F '414243'x` are equivalent commands when the target column contains Unicode data, but not when the target column contains EBCDIC data.

Changing data

In a File Manager/Db2 editor session, you can change data by:

- Overtyping
- Using the CHANGE primary command
- Entering prefix commands in the prefix area next to each row

Related tasks

[Installation settings that affect CAPS on page 176](#)

[Changing data by overtyping on page 177](#)

[Changing data with the CHANGE command on page 178](#)

[Changing data using prefix commands on page 182](#)

Installation settings that affect CAPS

The setting of CAPS determines whether or not the characters you enter in a File Manager/Db2 editor session are converted to uppercase. If CAPS is set to ON, FM/Db2 translates all data in rows that are changed by overtyping from lowercase to uppercase, and translates replacement data specified in the CHANGE command from lowercase to uppercase. If CAPS is OFF, the new data you type is not converted to uppercase.

When FM/Db2 is installed, a number of customization settings affect CAPS. These settings determine:

- The initial setting for CAPS (ON or OFF)
- Whether you can change this setting by means of the edit options; that is, whether the setting is *"updateable"* (meaning you can change it) or *"fixed"* (meaning you cannot change it)
- Whether you are permitted to issue the FM/Db2 CAPS primary command

For more information about these customization settings, see the *Customization Guide*.

For the first and second of the above settings, you can verify their value by looking at the third Editor Options panel.

For the third of the above settings, if you try to issue the CAPS command but FM/Db2 has been customized so that the CAPS command is unavailable, FM/Db2 displays the message *"The CAPS command has been disabled at installation time."*

If the installation option for CAPS is *"fixed"*, each FM/Db2 editor session starts with the installation setting for CAPS (either ON or OFF) and you cannot change the setting using the edit options.

If the installation option for CAPS is *"updateable"*, you can change the setting (to either ON or OFF) using the edit options and each FM/Db2 editor session starts with the current CAPS setting.

If the CAPS command is disabled, and the installation option for CAPS is *"fixed"*:

- If the installation option for CAPS is ON, to enter lowercase data you must first issue the CASE MIXED command
- If the installation option for CAPS is OFF, to enter uppercase data you must use the Shift or Caps Lock keys

Related tasks

[Changing data by overtyping on page 177](#)

[Changing data with the CHANGE command on page 178](#)

[Converting data to uppercase on page 185](#)

Related references

[Editor Options \(1 of 8\) panel on page 625](#)

[CAPS primary command on page 874](#)

[CASE primary command on page 875](#)

Changing data by overtyping

You can change the data displayed in a File Manager/Db2 editor session by overtyping it with the new data.

To successfully change data by overtyping:

- The new data you enter must be compatible with the data type of the column being changed. For example, you can only enter numeric values in a column that has a numeric data type.
- The column must be updateable (as defined in the Db2® catalog).
- If the table is subject to referential integrity, the new data must not cause a referential integrity violation.

Related tasks

["Read-only" views, non-updateable columns on page 186](#)

[Editing related tables on page 188](#)

[Converting data to uppercase on page 185](#)

Related references

[Db2 data types on page 432](#)

Changing data with the CHANGE command

When you use the CHANGE command to change data, you must specify one or more column numbers to be included in the search (in the same way as you use the FIND command to find data).

For example, the following command changes all occurrences of the string "CHAIR" in all rows to the string "TABLE" in either of the columns with column numbers #5 and #6.

```
CHANGE ALL CHAIR TABLE #5,#6
```

And the following command changes the next occurrence of the value 400 in column number 3 to 500:

```
CHANGE 400 500 #3
```

To change the next occurrence of the string, press the RChange function key (F6). To find the next occurrence of the string and optionally change it, use a combination of the RFind function key (F5) and the RChange function key (F6).

To find the same string as you specified on the previous CHANGE primary command, specify an asterisk (*) as the search string.

To use the same replacement string as you specified on the previous CHANGE primary command, specify an asterisk (*) as the replacement string.

Further examples

```
CHANGE BLACK WHITE #4 #7
```

In TABL display format, changes the next occurrence of "BLACK" to "WHITE", where "BLACK" is completely contained within either of the columns represented by column numbers 4 and 7.

In SNGL display format, changes the next occurrence of "BLACK" to "WHITE", where "BLACK" is completely contained within either of the columns represented by column numbers 4 and 7, in the current row only.

```
CHANGE BLACK WHITE ALL #2 #8
```

In TABL display format, changes all occurrences of "BLACK" to "WHITE", where "BLACK" is completely contained within either of the columns represented by column numbers 2 and 8, in all rows.

In SNGL display format, changes all occurrences of "BLACK" to "WHITE", where "BLACK" is completely contained within either of the columns represented by column numbers 2 and 8, in the current row only.

Related concepts

[Installation settings that affect CAPS on page 176](#)

Related tasks

[Changing data within excluded or non-excluded rows on page 181](#)

[Changing data within a label range on page 182](#)

[Finding data within specific columns on page 144](#)

Related references

[CHANGE primary command on page 875](#)

[Table Edit panel on page 826](#)

"From" and "To" strings of different lengths

For character columns (CHAR, VARCHAR), you can specify *“from”* and *“to”* strings (*from_string* and *to_string*) of different lengths, subject to the following conditions:

- For fixed-length character columns, when the *“to”* string (*to_string*) is shorter than the *“from”* string (*from_string*), FM/Db2 performs the change and pads the column with spaces. When the *“to”* string (*to_string*) is longer than the *“from”* string (*from_string*), FM/Db2 performs the change only if there are enough unused characters in the column to accommodate the change.

For example, for a given row, if column #2 is a fixed-length, character column of length 8 containing *“GEORGE ”* (with two trailing spaces):

```
CHANGE GEORGE FRED #2
```

Changes *“GEORGE ”* (with two trailing spaces) to *“FRED ”* (with four trailing spaces) in that row.

```
CHANGE GEORGE WILLIAM #2
```

Changes *“GEORGE ”* (with two trailing spaces) to *“WILLIAM ”* (with one trailing space) in that row.

```
CHANGE GEORGE ALEXANDER #2
```

FM/Db2 does not perform the change to that row as there are not enough unused characters in the column to accommodate the change.

- For varying-length character columns, when the *“to”* string (*to_string*) is shorter than the *“from”* string (*from_string*), FM/Db2 performs the change and adjusts the length of the column downwards by the difference between the lengths of *to_string* and *from_string*. When the *“to”* string (*to_string*) is longer than the *“from”* string (*from_string*), FM/Db2 performs the change only if there are enough unused characters in the column to accommodate the change. In this case, FM/Db2 adjusts the length of the column upwards by the difference between the lengths of *from_string* and *to_string*.

Handling long strings

For character columns (CHAR, VARCHAR), you can specify *“from”* and *“to”* strings (*from_string* and *to_string*) up to 100 characters long. However, when you are dealing with long strings, you may find that you cannot fit the whole CHANGE command (including other parameters) on the command line. To overcome the problem, do one of the following to display an Extended Command Entry pop-up panel (see [Figure 54: Extended Command Entry pop-up panel for the CHANGE command on page 180](#)):

- Enter `cx` (for Change Extended)
- Enter the CHANGE primary command (or one of its abbreviations, such as C) *with no parameters*

 **Note:** If you have previously used the CHANGE or FIND commands in the current FM/Db2 editor session, to display the Extended Command Entry pop-up panel in this way, you will need to first use the RESET command before entering the CHANGE command (or one of its abbreviations) without any parameters. Alternatively, enter `cx`.

The Extended Command Entry pop-up panel contains five lines (each 50 characters long) that you use to enter all the CHANGE command parameters (but not the actual keyword CHANGE or any of its abbreviations). FM/Db2 treats the five lines on the pop-up panel as contiguous, allowing you to specify long “from” and “to” strings, the Db2® column number and optionally any other parameters, using up to 250 characters in total.

 **Note:** You can continue a string (or any other parameter) from the last position on one line of the pop-up panel to the first position of the next line. However, this does not mean that you need to completely fill a line before using the next line. For example, you can specify the “from” string on the first of the five lines, the “to” string on the next line, and the Db2® column number (specified as #n) on the next line. If you do not use all of a line, FM/Db2 treats the unused part of the line as a single space.

Figure 54: Extended Command Entry pop-up panel for the CHANGE command on page 180 shows the Extended Command Entry pop-up panel for the CHANGE command. In this example, any previous occurrences of the string “dichlorodiphenyltrichloroethane” in Db2® columns 4 or 7, between the labels .abc and .def, are to be changed to the string “trinitrophenylmethylnitramine” for non-excluded rows only.

Figure 54. Extended Command Entry pop-up panel for the CHANGE command

```

Process  Options  Utilities  Help
-----
FM/Db2 (DFG2)          Table Edit          1 of 42
TABLE FMUSER.EMP          Format TABL
                          Extended Command Entry          DATE
                          Complete typing the CHANGE command and press Enter.
0  CHANGE  ==>  dichlorodiphenyltrichloroethane
0          ==>  trinitrophenylmethylnitramine
0          ==>  prev (#4 #7)
0          ==>  .abc .def
0          ==>  nx
0
0          F1=Help   F2=Split  F3=Exit   F9=Swap   F12=Cancel
0
000009 000110 magnesium silicate
000010 000120 sodium bicarbonate
000011 000130 aqueous solution of ammonium hydroxide
000012 000140 ammonium hydroxide solution
Command ==> c
          F1=Help   F2=Zoom    F3=Exit    F4=CRetriev  F5=RFind    F6=RChange
          F7=Up     F8=Down    F9=Swap    F10=Left    F11=Right   F12=Cancel
          Scroll PAGE
          9/1980
    
```

Figure 55: Extended Command Entry pop-up panel for the CHANGE command showing contiguous nature of entry lines on page 181 shows the pop-up panel for the CHANGE command where the next occurrence of a long string (84 characters) in Db2® column 5 is to be changed to another long string (70 characters).

Figure 55. Extended Command Entry pop-up panel for the CHANGE command showing contiguous nature of entry lines

```

Process  Options  Utilities  Help
-----
FM/Db2 (DFG2)                Table Edit                1 of 42
TABLE FMUSER.EMP                Format TABL                DATE
                                Extended Command Entry
                                Complete typing the CHANGE command and press Enter.
0  CHANGE  ==> 'It is wise to apply the oil of refined politeness
0  ==>      to the mechanisms of friendship.'
0  ==>      'In prosperity our friends know us; in adversity w
0  ==>      e know our friends.' #5
0  ==>
0
0
0  F1=Help   F2=Split  F3=Exit   F9=Swap   F12=Cancel
0
000009 000110 You can make more friends in two months by becoming interested in
000010 000120 Never explain--your friends do not need it and your enemies will
000011 000130 Do not protect yourself by a fence, but rather by your friends.
000012 000140 Nothing changes your opinion of a friend so surely as success - y
Command ==> c
F1=Help   F2=Zoom   F3=Exit   F4=CRetrie  F5=RFind   F6=RChange
F7=Up     F8=Down   F9=Swap   F10=Left   F11=Right  F12=Cancel

```

Changing numeric columns

If you use the CHANGE command to change a numeric column, then the lengths of *from_string* and *to_string* are not significant. For example, if column #2 is a numeric column, then the following CHANGE command is permitted, because *from_string* and *to_string* are interpreted as numeric values:

```
CHANGE 3.1415 3.2 #2
```

Changing data within excluded or non-excluded rows

If your data contains excluded and non-excluded rows, you can limit the effect of the CHANGE command to:

- Only non-excluded rows (parameter NX), or
- Only excluded rows (parameter EX or X)

For example, the following command changes all occurrences of the string "GREEN", in column number 2 or column number 5 in non-excluded rows only, to the string "BLACK":

```
CHANGE ALL GREEN BLACK (#2 #5) NX
```

And the following command changes the next occurrence of the value 250, in column number 2 in an excluded row, to 520:

```
CHANGE 250 520 #2 EX
```

Related tasks

[Excluding rows on page 159](#)

Related references

[CHANGE primary command on page 875](#)

Changing data within a label range

You can limit the effect of the CHANGE command to a range of rows, identified by a pair of labels indicating the first and last rows to be searched for the data you want to change.

For example, in the range of rows from the label .LABA to the end of the data, the following command changes the next occurrence of the string "EVIL" in column number 4 to the string "GOOD":

```
CHANGE EVIL GOOD #4 .LABA .ZLST
```

And, in the range of rows from the current cursor position to the label .LABB, the following command changes all occurrences of the value 48 in column number 3 or column number 11 to the value 148:

```
CHANGE ALL 48 148 #3,#11 .ZCSR .LABB
```

Related tasks

[Assigning labels to rows on page 147](#)

Related references

[CHANGE primary command on page 875](#)

Limiting the change to specific portions of the data

You can limit the effect of the CHANGE command to specific portions of the data you are searching:

- To limit the search for a string to only where it appears as a *prefix* in the data, specify the PREFIX parameter.
- To limit the search for a string to only where it appears as a *suffix* in the data, specify the SUFFIX parameter.
- To limit the search for a string to only where it appears as a *word* in the data, specify the WORD parameter.

Related references

[CHANGE primary command on page 875](#)

Changing data using prefix commands

In a File Manager/Db2 View or Edit editor session, you can enter prefix commands in the prefix area of one or more rows on the display. The prefix area is typically represented by a column of 6-digit numbers on the far left or far right of your display.

You can use prefix commands to:

- Insert or delete rows
- Repeat (duplicate) rows
- Move rows
- Overlay data in one or more rows with data from one or more other rows
- Shift data

- Copy or move rows to and from a clipboard
- Limit the data being edited

To set the position of the prefix area (left or right), or turn the prefix area on or off, use the PREFIX primary command.

You can use most of the prefix area commands on either a single row or a block of consecutive rows:

- To perform an operation on a single row, you enter the appropriate command code.
- To perform an operation on a block of consecutive rows, either enter the command code preceded or followed by the number of lines, or enter the appropriate block command code at the start and end lines of the block.

Generally, you need to type over only the first 1 or 2 characters of the line number to enter a prefix command. Sometimes, however, typing a single character can be ambiguous. In the following example, it is unclear whether the intended prefix command is R to repeat line 31700, or R3 to repeat the line three times:

```
031600
R31700
031800
```

In such cases, the editor assumes that you have not typed a number following the prefix command (it cannot detect if you overwrite a character with the same character). If you want to repeat the line three times, you can use any of the following procedures:

- Type one or more blanks following the R3:

```
R3 700
```

- Type `R3` and press the Erase EOF key to clear the rest of the Line Command field, or press the Erase EOF key and then type `R3`.
- Type one or more blanks after the R but before the number such that the number when entered is different than the characters being overtyped.:

```
R 3700
```

- Type the number before the R, ensuring that the number when entered is different than the characters being overtyped:

```
3R1700
```

To clear any outstanding commands in the prefix area, use the RESET primary command.



Note: Moving rows in a File Manager/Db2 editor session does not affect the order in which the rows are stored in the underlying Db2® table.

Overlaying data in existing rows

You can overlay data in a row with data from another row by specifying the O or OO prefix commands.

When data is to be copied or moved by the C (copy) or M (move) prefix commands and overlaid on one or more existing rows, the O or OO (overlay) prefix commands specify the destination for the data. You can only overlay data onto character columns (CHAR and VARCHAR).

The data that is copied or moved overlays blanks in the destination rows.

If the destination column is VARCHAR:

- It must have a non-zero length.
- If the length of the data being moved or copied is longer than the destination column, only the data that can fit into the destination column is moved or copied.

When data is to be moved or copied and then overlaid on a destination:

- Where the destination is a *single row*.
 - The O (overlay) prefix command specifies the destination for the data.

You can type a number after the O prefix command to specify the number of times that the M or C prefix command is to be performed. For example, typing the command `O3` against a row causes the data to be moved or copied and then overlaid on that row and also the next two rows.
- Where the destination is a *block of rows*.
 - The OO (overlay, multiple-line target) prefix command specifies the first and last row of the destination for the data.

To overlay one or more *single rows*:

1. Type either `M` or `C` in the prefix area of the row that is to be moved or copied.
2. Type `O` in the prefix area of the row that the moved or copied record is to overlay.
3. Press Enter. The data being moved or copied overlays the specified row or rows.

To overlay one or more *blocks of rows*:

1. Type either `MM` or `CC` in the prefix area of the first and last rows of a block of rows that is to be moved or copied. You can scroll (or use FIND or LOCATE) between typing the first command and the second command, if necessary.
2. Type `OO` in the prefix area of the first and last rows that the block of rows being moved or copied is to overlay. Again, you can scroll (or use FIND or LOCATE) between typing the first `OO` and the second `OO`, if necessary.
3. Press Enter. The rows that contain the two CC or MM commands and all of the rows between them overlay the rows that contain the two OO commands and all of the rows between them.

The number of source and receiving rows need not be the same. If there are more receiving rows, the source rows are repeated until the receiving rows are gone. If there are more source rows than receiving rows, the extra source rows are ignored.

Related topics

[Table Edit panel on page 826](#)

Related references

[Table Edit panel on page 826](#)

[PREFIX primary command on page 926](#)

[RESET primary command on page 932](#)

Converting data to uppercase

In a File Manager/Db2 editor session, the CAPS and CASE primary commands control whether data in the data area is converted to uppercase on input (CAPS, CAPS ON or CASE UPPER), or left alone (CASE, CASE MIXED or CAPS OFF; this is the default action).

You can abbreviate the CAPS command to CAP and the CASE command to CAS.

The CAPS ON and CASE UPPER commands have slightly different effects.

CAPS or CAPS ON is similar to the ISPF editor CAPS command:

- If you overwrite any data in a row, only the current column is converted to uppercase.
- The CHANGE command treats the new (replacement) string as if it were specified in all uppercase unless:
 - The new string is enclosed in single quotation marks, prefixed by the letter C (for example, C'New String'), or
 - The new string is specified as a hexadecimal string (for example, x'C1C2C3')

If either of the previous conditions apply, the new string is not converted to uppercase.

CAPS or CAPS ON affects only rows changed after the CAPS or CAPS ON command is entered.

CASE UPPER converts all data in any new or changed rows to uppercase, regardless of how the rows are changed. CASE UPPER affects all rows inserted or changed in the current FM/Db2 editor session, including rows inserted or changed before the CASE UPPER command is entered.

The CAPS OFF, CASE, and CASE MIXED commands have the same effect: they turn off conversion to uppercase.

Any CAPS command overrides any previously entered CASE command, and any CASE command overrides any previously entered CAPS command.



Note:



1. In the ISPF editor with CAPS ON, a line is considered changed if you type *anything* on the line (if you overwrite a space with a space, it is considered to be a change). However, in the FM/Db2 editor, overtyping a character with the same character is not considered a change.
2. The values for CASE and CAPS are not maintained between FM/Db2 editor sessions. Each new FM/Db2 editor session begins with CAPS OFF; that is, data entered in lowercase is not converted to uppercase.

Related concepts

[Installation settings that affect CAPS on page 176](#)

Related tasks

[Changing data by overtyping on page 177](#)

Related references

[CAPS primary command on page 874](#)

[CASE primary command on page 875](#)

[Table Edit panel on page 826](#)

[Editor Options \(1 of 8\) panel on page 625](#)

"Read-only" views, non-updateable columns

If the object you are editing is a view, it is possible that one or more columns within the view are marked as non-updateable in the Db2® catalog. In Db2® parlance, such a view is referred to as a *read-only* view.

If you attempt to edit a read-only view that contains *only* non-updateable columns, FM/Db2 displays a Browse session (instead of an Edit session) and issues an advisory message at the start of the session. Otherwise (that is, if the read-only view contains at least one updateable column), FM/Db2 displays a File Manager/Db2 editor session showing the non-updateable columns as protected and issues an advisory message at the start of the FM/Db2 editor session. If you edit a view containing one or more non-updateable columns, not all edit operations are possible.

If you edit a table that contains one or more columns, excluding ROWID columns, that are marked as non-updateable in the Db2® catalog (such as a Db2® catalog table), FM/Db2 displays a File Manager/Db2 editor session showing the non-updateable columns as protected and issues an advisory message at the start of the FM/Db2 editor session. If you edit a table containing one or more non-updateable columns, excluding ROWID columns, not all edit operations are possible.

Related tasks

[ROWID columns on page 104](#)

Deleting rows

In a File Manager/Db2 editor session, you can delete rows by using:

- The DELETE primary command
- The D, Dn, or DD prefix commands in the prefix area next to each row (TABL display only)

In TABL display format, you can restrict the rows you delete by:

- Limiting the rows that are deleted to only excluded or only non-excluded rows
- Limiting the rows that are deleted to those within a range of rows identified by a pair of labels
- Using the D, Dn, or DD prefix commands

In SNGL display format, DELETE deletes the currently displayed row only. To delete the currently displayed row, enter:

```
DELETE
```



Note:

1. In TABL display format, care should be taken when using the DELETE primary command to ensure that you only delete the rows you intend to. The command `DELETE ALL` (with no other parameters) deletes all rows in the table or view being edited.
2. If the table target has referential constraints, you might not be able to delete rows. For further information, see [Handling errors during an Edit session on page 197](#).

Related tasks

[Deleting rows within excluded or non-excluded rows on page 187](#)

[Deleting rows within a label range on page 188](#)

Related references

[DELETE primary command on page 882](#)

[Table Edit panel on page 826](#)

Deleting rows within excluded or non-excluded rows

If your data contains excluded and non-excluded rows, you can limit the effect of the DELETE command to:

- Only non-excluded rows (parameter NX), or
- Only excluded rows (parameter EX or X)

For example, the following command deletes all excluded rows:

```
DELETE ALL EX
```

And the following command deletes the first non-excluded row:

```
DELETE NX
```

Related tasks

[Excluding rows on page 159](#)

Related references

[DELETE primary command on page 882](#)

Deleting rows within a label range

You can limit the effect of the DELETE command to a range of rows, identified by a pair of labels indicating the first and last rows to be deleted.

For example, the following command deletes all rows from the label .LABA to the label .LABB.

```
DELETE ALL .LABA .LABB
```

Related tasks

[Assigning labels to rows on page 147](#)

Related references

[DELETE primary command on page 882](#)

Editing related tables

FM/Db2 provides support for editing tables that are subject to referential integrity (RI) constraints. If you are not familiar with the terms *parent table*, *dependent table*, *primary key*, *foreign key* and *referential integrity*, see the relevant Db2® manuals.



Note: The support provided by FM/Db2 for editing related tables applies only to Db2® tables, not to any Db2® view created on a table that is subject to RI constraints.

This section describes the behavior of the REDIT command when a Db2® error has been encountered, and the Db2® error is an RI violation. For a description of issuing the REDIT command when no RI error has occurred, see [Listing related tables on page 189](#).

If FM/Db2 encounters an error when attempting to save the data changed in an Edit session and the error is due to a RI violation, it automatically determines the name of the other table (the related table) in the RI relationship. You can then start another FM/Db2 Edit session for the related table. The new Edit session (dependent session) is displayed as a new ISPF logical session, as if you had typed `START` on the command line and then selected FM/Db2 Edit. You can use the ISPF commands SWAP and SWAP LIST to move between different logical sessions.

FM/Db2 customizes the template for the new Edit session to make the identification of the key columns easier. If the related table is a dependent table, FM/Db2 displays only the rows with values that match the primary key in the parent table. If the

related table is a parent table, you can use the IP (Insert primary key) prefix command to insert a row with a primary key matching the foreign key that caused the error.

If an Edit session has active dependent Edit sessions, you cannot save changes made in the session until you end all dependent Edit sessions. If you cancel an edit session that has active dependent Edit sessions, all dependent Edit sessions are also canceled. Any uncommitted changes in any of the dependent Edit sessions are lost.

Listing related tables

When you are in a File Manager/Db2 View or Edit editor session, you can issue the REDIT primary command to display a list of tables related by a Db2® referential integrity (RI) constraint to the Db2® object currently being edited.

When you enter the REDIT primary command, you can optionally supply a field number that identifies the column in the table of the Db2® object currently being edited.

The way in which FM/Db2 responds after you enter the REDIT primary command depends on the object you are editing, the position of the cursor, and whether you specify a column number:

- When the object being edited does *not* have RI constraints, a new FM/Db2 Edit session is stacked on top of the existing Edit session. You are presented with the Db2® Edit entry panel.
- When the object being edited *does* have RI constraints:
 - When the cursor is not located in the data portion of the screen, or is not located on the data for a column of the table, FM/Db2 displays a selection list showing all the Db2® objects that are directly related to the object being edited by an RI constraint. This includes tables that are parent tables in a relationship with the table being edited, and tables that are dependent tables in a relationship with the table being edited.
 - When the cursor is located on the data for a column of the table, and that column is not part of a primary, parent or foreign key, FM/Db2 displays a selection list showing all the Db2® objects that are directly related to the object being edited by an RI constraint. This includes tables that are parent tables in a relationship with the table being edited, and tables that are dependent tables in a relationship with the table being edited.
 - When the cursor is located on the data for a column of the table, and that column is part of a primary, parent, or foreign key, FM/Db2 displays a selection list showing only those Db2® objects that are directly related to the object being edited, limited to those tables where the primary, parent, or foreign key of the table being edited contains the column where the cursor is located.
 - When you have specified a field number with the REDIT primary command and the column identified by the field number is part of a primary, parent, or foreign key, FM/Db2 displays a selection list showing only those Db2® objects that are directly related to the object being edited, limited to those tables where the primary, parent, or foreign key of the table being edited contains the column identified by the field number.
 - When a field number is provided with the REDIT command and the column identified by the field number is not part of a primary, parent, or foreign key, FM/Db2 displays a selection list showing all the Db2® objects that are directly related to the object being edited by an RI constraint. This includes tables that are parent tables in a relationship with the table being edited, and tables that are dependent tables in a relationship with the table being edited.

The list of related tables for an object is displayed by the FM/Db2 Object List utility on the Related tables panel. You can issue a number of prefix commands against any of the objects shown on the list. For example:

Prefix command

FM/Db2 displays...

EE or VE

A new FM/Db2 editor session for the selected object. The new FM/Db2 editor session appears in a new ISPF logical screen (as though you had split the screen and started a new FM/Db2 session).

The first panel displayed, and the rows displayed in the Edit (or View) session, depend on where you position the cursor at the time of entering the REDIT command:

- When the cursor is located on the data for a column that is part of a parent, primary, or foreign key, the new FM/Db2 editor session starts with the display of data, and contains only those rows related to the row where the cursor was located.
- When the cursor is not located on the data for a column that is part of a parent, primary, or foreign key, the new FM/Db2 editor session starts with the display of the Db2® Edit (or Db2® View) entry panel (where you can alter the object name if required), and contains all rows of the object.

E or V

A new FM/Db2 Edit session stacked on top of the existing Edit session.

To see all the available commands, type "?" in the selection field (**SEL**) to the left of any entry and press Enter.

You can only issue the REDIT command when editing a table. The REDIT command is inoperative when editing a view.

Related references

[Working with lists of Db2 objects on page 297](#)

[Related tables panel on page 755](#)

[REDIT primary command on page 931](#)

Self-referencing constraints

A self-referencing constraint exists if a Db2® object is subject to a primary or foreign key relationship in which the parent table and the dependent table are the same table. If the DELETE rule for the relationship is CASCADE, the deletion or change of one row can cause a recursive deletion of other rows in the table. If FM/Db2 detects a self-referencing constraint defined on a table, it does not attempt to determine which rows are affected by a deletion or change of a primary key value. This also applies to any other tables affected by other relationships defined on the table.

Referential integrity errors

There are two types of referential integrity errors:

- The first type of referential integrity error occurs if you are editing a parent table and you either delete or update a primary key value. If the restrict rule applies to foreign key values in the dependent table, Db2® rejects the update or delete operation. To make the change to the primary key value in the parent table, you must edit the dependent table and either delete or change all rows with a matching foreign key.
- The second type of referential integrity error occurs if you are editing a dependent table and you create a foreign key value for which there is no corresponding entry in the parent table. Db2® rejects the insert or update operation (because a foreign key value cannot exist without a corresponding primary key value). To change the value of the foreign key in the dependent table, you must edit the parent table and create a row with a primary key value that matches the value of the new foreign key value in the dependent table.

Related tasks

[Handling errors during an Edit session on page 197](#)

Starting an Edit session of a related table

To start a File Manager/Db2 Edit session of a related table, perform one of these actions:

- In the information panel for an RI error (accessed by typing **E** in the prefix area for an RI error), type **REDIT** on the command line.
- Use the RE prefix command against a row marked in error if the error is an RI error.



Note: When the object being edited is a Db2® view, both the REDIT line command and the RE prefix command are disabled.

Related references

[REDIT primary command on page 931](#)

[Table Edit panel on page 826](#)

Differences when you edit a related table

A File Manager/Db2 Edit session for a related table is similar to a typical Edit session, with the following exceptions:

- The new session starts with the display of data for the related table.
- You cannot change the edit options. The current global edit options apply.
- There is no opportunity to edit the template before displaying the data.
- The panel title shows *“Table Edit (related)”* (instead of *“Table Edit”*).
- The location information is replaced with either *“PARNT”* or *“DPDNT”* and the name of the other object in the relationship. *“PARNT”* indicates that the other table is the parent table in the relationship. *“DPDNT”* indicates the other table is the dependent table in the relationship.
- For a dependent table, the template includes a WHERE clause that limits the data displayed to only those rows that match the primary key value in the parent table. If the parent table is subject to a self-referencing constraint, all rows might be displayed.

- The template includes information about the order in which columns are displayed. Columns that comprise the primary or foreign key are displayed (in order) at the left (TABL display format), or top (SNGL display format), of the other object in the relationship.
- In TABL display format, columns that form part of the relationship's key are identified with a "K" in the sixth character of the scale header line.
- If an Edit session has active dependent Edit sessions (that is, you have used either the REDIT primary command or the RE prefix command to start another FM/Db2 edit session of a related table, *and* that Edit session is still active), you cannot save any changes you have made to data until you end all dependent Edit sessions.
- If you cancel an Edit session that has active dependent Edit sessions, FM/Db2 also cancels all dependent Edit sessions. Any uncommitted changes in the canceled dependent Edit sessions are lost.

Related tasks

[Self-referencing constraints on page 190](#)

Related references

[REDIT primary command on page 931](#)

[Table Edit panel on page 826](#)

Differences when saving or canceling while editing a related table

If you have initiated one or more Edit sessions for related tables, the following restrictions apply:

- If there are active dependent Edit sessions (that is, you have used either the REDIT primary command or the RE prefix command to start another FM/Db2 Edit session for a related table, *and* any of those edit sessions are still active), you cannot save any changes to data until you have ended all dependent Edit sessions.
- If you cancel an Edit session that has active dependent Edit sessions, any dependent Edit sessions are also canceled. Any uncommitted changes in the canceled dependent Edit sessions are lost.

Related references

[REDIT primary command on page 931](#)

[Table Edit panel on page 826](#)

Navigating between Edit sessions

To switch between two or more FM/Db2 Edit sessions, use the ISPF commands SWAP and SWAP LIST. For more information, see the *z/OS ISPF User's Guide Vol 1*.

If the table you are editing is part of a larger RI structure, you might need to start several Edit sessions of related tables to make the required changes to the original table.

Deleting a primary key

If you delete a row in a parent table, it might generate an error if there are rows in the dependent table and the delete restrict rule is specified for the relationship. The delete restrict rule prevents the deletion of the primary key value unless you first delete (or change) all the rows in the dependent table with foreign key values matching the primary key value.

In this situation:

1. Start a File Manager/Db2 Edit session for the dependent table by either using the RE prefix command, or REDIT primary command from the error information panel. Usually, only those rows that would be affected by the deletion of the primary key in the parent table are displayed (see following note).
2. Either delete the displayed rows (see following note), or change the values of the foreign keys to another valid value.
3. Press the Exit function key (F3) to validate and commit your changes.
4. Return to the Edit session for the primary table and proceed with deletion of the primary key value.



Note:

1. In most cases, FM/Db2 shows only those rows that would be affected by the deletion of the primary key in the parent table. The exception is the situation where the parent table has a self-referencing constraint that might cause the deletion of other rows in the parent table if a primary or parent key value is deleted or changed. In this situation, FM/Db2 shows all rows and you must select the dependent rows.
2. If the parent or dependent tables are also parent or dependent tables in other relationships, changes to the primary or foreign key values can result in other errors.

Related references

[REDIT primary command on page 931](#)

[Table Edit panel on page 826](#)

Inserting a new foreign key

If you insert a row in a dependent table, it might generate an error if there is no row in the parent table with a corresponding primary key value. Db2® prevents the insertion of the foreign key value until a primary key is created in the parent table.

The parent table can be the same as the table currently being edited (a self-referencing constraint. This is indicated by the absence of an “R” in the rightmost position of the prefix area for the row in error. You can use the E prefix command to display an information panel with details of the relationship name, the parent and dependent table names, and the names of the columns in the key in both the parent and dependent tables.

In the situation where the parent and dependent tables are different:

1. Start a File Manager/Db2 Edit session for the parent table by either using the RE prefix command, or REDIT primary command from the error information panel.
2. Use the IP prefix command to insert a new row in the table, with a primary key that matches the foreign key value entered in the Edit session for the dependent table. You can also change an existing row so that its primary key matches the foreign key entered in the Edit session of the dependent table.
3. Press the Exit function key (F3) to validate and commit your changes.
4. Return to the original Edit session and save the new foreign key value.



Note: If the parent or dependent tables are also parent or dependent tables in other relationships, changes to the primary or foreign key values can result in other errors.

Related tasks

[Self-referencing constraints on page 190](#)

Related references

[REDIT primary command on page 931](#)

[Table Edit panel on page 826](#)

Updating a primary key

Db2® interprets updating a primary key as a deletion, followed by an insertion of a new row the same as the deleted row but with the new primary key value.

If you update a row in a parent table, it can generate an error if there are rows in the dependent table with matching foreign key values and the delete restrict rule is specified for the relationship. The delete restrict rule prevents the deletion of the primary key value unless you first delete (or change) all the rows in the dependent table with foreign key values matching the primary key value.

In this situation:

1. Repeat the row containing the original primary key value you want to change.



Note: After the repeat operation, the new row is displayed immediately below the repeated row and is intensified.

2. Change the primary key in the *new* row to the required value.
3. Use the SAVE primary command to verify that there are no other Db2® errors.
4. Delete the original row.
5. Start a File Manager/Db2 Edit session for the dependent table by either using the RE prefix command, or REDIT primary command from the error information panel. Usually, only those rows that would be affected by the deletion of the primary key in the parent table are displayed (see following note).
6. Either delete the displayed rows (see following note), or change the values of the foreign keys to another valid value.

7. Press the Exit function key (F3) to validate and commit your changes.
8. Return to the Edit session for the primary table and proceed with deletion of the primary key value.

**Note:**

1. In most cases, FM/Db2 shows only those rows that would be affected by the deletion of the primary key in the parent table. The exception is the situation where the parent table has a self-referencing constraint that might cause the deletion of other rows in the parent table if a primary or parent key value is deleted or changed. In this situation, FM/Db2 shows all rows and you must select the dependent rows.
2. If the parent or dependent tables are also parent or dependent tables in other relationships, changes to the primary or foreign key values can result in other errors.

Related references

[REDIT primary command on page 931](#)

[SAVE primary command on page 937](#)

[Table Edit panel on page 826](#)

Adding a primary key

You can add a row with a new primary key value to a table using one of these methods:

- You can insert a new row in the table (I prefix command) and then change the values in the new row to create the required primary key value.
- You can repeat an existing row and then change the values in the new row to create the required primary key value.



Note: If you use this method, you *must* change the new row (added immediately below the original row, and intensified), rather than the original row. The reason for this is that changing the original row instead of the new row results in FM/Db2 attempting to update the original row with the new primary key value. This change fails if the original row has dependent rows, and SQLCODE -531 results. FM/Db2 also reports a duplicate row error (SQLCODE -803) against the new row as it attempts to insert a new row, identical to the original row.

Related tasks

[Updating a primary key on page 194](#)

[Handling errors during an Edit session on page 197](#)

Related references

[Table Edit panel on page 826](#)

Issuing Db2® commands from within a File Manager/Db2 session

When you are working in a File Manager/Db2 session, you can issue a Db2® command and view the output returned by Db2®.

There are two ways in which you can enter a Db2® command from within a File Manager/Db2 session:

- By displaying the Enter and Execute Db2® Commands panel and entering the required Db2® command (prefixed by "Db2® ") on the panel.
- From some FM/Db2 panels, entering the required Db2® command on the command line.

Issuing Db2® commands from the Enter and Execute Db2® Commands panel

To issuing Db2® commands from the Enter and Execute Db2® Commands panel:

1. Display the Enter and Execute Db2® Commands panel by performing one of these actions:
 - Select option **6** (Command) from the Primary Option Menu panel and press Enter.
 - From the Process pull-down menu on the Action bar, select option **1** (Db2® Command) and press Enter.
2. On the Enter and Execute Db2® Commands panel, under **Db2® Command:**, type a hyphen (-) followed immediately by the Db2® command you want to issue.

For example:

```
-DISPLAY ARCHIVE
```



Note: If you do not prefix the command with a hyphen, one is added by FM/Db2.

3. When you issue either the DISPLAY THREAD or DISPLAY DATABASE command, you can optionally specify the maximum number of lines to be returned in the **Line count** field.
4. Press Enter.

FM/Db2 displays the output from the Db2® command in an ISPF View session as shown in [Figure 56: Example of output displayed by Db2 after Db2 command issued on page 197](#).

Issuing Db2® commands from the command line

You can issuing a Db2® command from the command line on these FM/Db2 panels:

- Table Browse panel
- Table Edit panel
- Table View panel
- Object list panels displayed with the Object List utility
- Privilege details panels
- Enter, Execute and Explain SQL Statements panel

To issue a Db2® command from the command line of a File Manager/Db2 panel:

1. Type `DB2`, followed a space, and then the Db2® command you want to issue.

For example, to issue the Db2® command `DISPLAY ARCHIVE`, type:

```
DB2 DISPLAY ARCHIVE
```

2. Press Enter.

FM/Db2 displays the output from the Db2® command in an ISPF View session as shown in [Figure 56: Example of output displayed by Db2 after Db2 command issued on page 197](#).

Figure 56. Example of output displayed by Db2® after Db2® command issued

```

File Edit Edit_Settings Menu Utilities Compilers Test Help
VIEW      SYS07228.T121015.RA000.FMUSER.R0227849      Columns 00001 00072
***** ***** Top of Data *****
==MSG> -Warning- The UNDO command is not available until you change
==MSG> your edit profile using the command RECOVERY ON.
000001 DSNV401I -DFE2 DISPLAY THREAD REPORT FOLLOWS -
000002 DSNV402I -DFE2 ACTIVE THREADS -
000003 NAME      ST A   REQ ID          AUTHID   PLAN     ASID  TOKEN
000004 DB2CALL  T     144 FMUSER      FMUSER   FMN2PLN1 00C0  302
000005 DB2CALL  T     *    2 FMUSER      FMUSER   00C0  303
000006 DISPLAY ACTIVE REPORT COMPLETE
000007 DSN9022I -DFE2 DSNVDT '-DISPLAY THREAD' NORMAL COMPLETION
***** ***** Bottom of Data *****

Command ==>>
F1=Help      F2=Split    F3=Exit     F5=Rfind    F6=Rchange  F7=Up
F8=Down     F9=Swap    F10=Left   F11=Right   F12=Cancel

```

Related references

[Enter and Execute Db2 Commands panel on page 659](#)

Handling errors during an Edit session

FM/Db2 might report errors if it attempts to implement the changes to data that you have made in an Edit session. These errors are detected by Db2® when FM/Db2 issues `INSERT`, `UPDATE`, or `DELETE` SQL statements. SQL errors can arise for many reasons, including violation of uniqueness, referential integrity and check data constraints defined on the Db2® object being edited. If you are unfamiliar with these concepts, see the *Db2 UDB for z/OS Administration Guide*.

If FM/Db2 detects an error, it marks the row that caused the error with either “=ERR”, “=ERR R”, or the `SQLCODE` in the prefix area. The choice of error indicator is determined by the **Show SQLCODE** editor option. Rows that were deleted are reinserted at the top of the current display (in `TABL` display format). Save operations cannot proceed until all pending errors have been corrected. If the Db2® object you are editing is subject to many constraints, or if many changes have been made to the data without verification, it might be impossible to resolve all errors. In this situation, cancel the Edit session.

Related tasks

[View and Edit options \(options 1 and 2\) on page 65](#)

[Setting options for the current FM/Db2 editor session on page 123](#)

[Ending a File Manager/Db2 editor session on page 130](#)

[Example of correcting an error during an Edit session on page 201](#)

Related references

[Editor Options \(3 of 8\) panel on page 634](#)

Determining why an error occurred

You can find more information about the error detected against a row by typing **E** in the prefix field for that row. An error information panel is displayed with an explanation of why Db2® rejected the change operation.

If the SQLCODE is displayed in the prefix area, see the *Db2 UDB for z/OS Messages and Codes* for a detailed explanation of the error.

Some errors are the result of referential integrity (RI) constraint violations. If the RI relationship applies to two tables, these errors are indicated by the presence of an "R" in the rightmost position of the prefix area.

You can use the RE prefix command against rows with RI errors that apply to two tables to start another FM/Db2 Edit session. The new session is an Edit session for the other table affected by the RI error.

Related tasks

[Editing related tables on page 188](#)

[Example of correcting an error during an Edit session on page 201](#)

Related references

[Table Edit panel on page 826](#)

"Duplicate Row" errors

FM/Db2 reports a "Duplicate Row Error" if the insert or update operation would have resulted in two rows with the same value with respect to a unique index defined on the table. You can use the Primary Key and Unique Index indicators to identify columns of the table that are part of unique indexes. Note that if you used row selection criteria to limit the amount of data in your Edit session, the duplicate row might not be displayed in your Edit session.

Related tasks

[Selecting rows on page 83](#)

"No Primary Key" errors

FM/Db2 reports a "No Primary Key" error if your change would have created a foreign key value for which there is no corresponding primary key in the parent table of the relationship. This is a *referential integrity* (RI) constraint error. The prefix

area error indicator only shows an “R” in the rightmost position if the parent table is different to the table currently being edited.

You can use the foreign key indicators to identify columns of the table that are defined as foreign keys.



Note: The foreign key information is only available if the “Retrieve foreign key information when building templates” option was selected when the template for the object was built.

The error information panel for this error shows the names of the parent and dependent tables in the relationship that caused the error, and the name of the relationship. At the bottom of the panel are the names of the columns that comprise the key in both the parent and dependent tables, along with the value that caused the error.

If the parent table is different to the dependent table, you can enter the RE prefix command against the row, or enter the REDIT primary command from the error information panel, to edit the parent table of the relationship and correct the error.

Related tasks

[Editing related tables on page 188](#)

Related references

[Systems Options \(1 of 4\) panel on page 817](#)

[REDIT primary command on page 931](#)

"Delete Restrict Rule" errors

FM/Db2 reports a “Delete Restrict Rule” error if your deletion or change would have deleted one or more rows in dependent tables, but the delete rule is RESTRICT. These are referential integrity (RI) constraint errors.

The error information panel for this error shows the names of the parent and dependent tables in the relationship that caused the error, and the name of the relationship. At the bottom of the panel are the names of the columns that comprise the key in both the parent and dependent tables, along with the value that caused the error.

You can enter the RE prefix command against the row, or enter the REDIT command from the error information panel, to edit the dependent table of the relationship and correct the error.

Related tasks

[Editing related tables on page 188](#)

Related references

[REDIT primary command on page 931](#)

"Check Constraint" errors

FM/Db2 reports a *"Check Constraint Error"* if a change violates a check constraint defined on either a column or the table. The panel shows the name of the constraint that caused the change to fail. You can press the ShowCon function key (F5), or issue the SHOWCON command, to display an ISPF Edit session showing the SQL text of the constraint.

"Row Not Found" errors

FM/Db2 reports a *"Row Not Found Error"* if the original row was not found when either a DELETE or UPDATE operation was attempted. This can occur because another user has changed the row since the data was originally retrieved from Db2®. The recommended action in this situation is to restart the Edit session with a current copy of the data. This can also occur if the Db2® object being edited has a TIME data type column and the system options are set to display the data for this column in USA format.

Related tasks

[FM/Db2 system options \(option 0.2\) on page 63](#)
[DATE and TIME columns on page 165](#)

Related references

[Systems Options \(1 of 4\) panel on page 817](#)

Deadlocks or timeouts

Db2® might encounter a deadlock or timeout condition (SQLCODE -911) if it attempts to implement changes made in a File Manager/Db2 Edit session. If this occurs there is a delay, followed by the display of the SQL error pop-up panel with the explanation for the -911 SQLCODE.

If you encounter this error, be aware that:

- Changes made to any row marked with -911 have **not** been completed.
- Db2® has rolled back the current unit of work. This means that all uncommitted changes made in the current Edit session have been lost.
- After the rollback of the current unit of work, the data shown in the FM/Db2 Edit session might not reflect the current state of the data in the Db2® table.

The recommended course of action is to cancel the current Edit session and restart with a new copy of the data. If the problem persists contact your Db2® systems administrator for assistance in determining which other Db2® task is preventing access to the Db2® object.

Related tasks

[Ending a File Manager/Db2 editor session on page 130](#)

Example of correcting an error during an Edit session

If an error occurs during an Edit session, FM/Db2 displays “=ERR”, “=ERR R”, or the SQLCODE in the prefix area of the row (or rows) in error. [Figure 57: Example: error indicated during Edit session on page 201](#) shows an error has occurred for one row.

Figure 57. Example: error indicated during Edit session

Process	Options	Utilities	Help
FM/Db2 (DFG2)			Table Edit
TABLE FMUSER.EMP			1 of 42
EMPNO	FIRSTNME	MIDINIT	LASTNAME
#1	#2	#3	#4
CH(6)	VARCHAR(12)	CH(1)	VARCHAR(15)
PU-->	<----+-----1->	-	<----+-----1----->
000000	****	Top of data	****
000001	000010	CHRISTINE<	I HAAS<
000002	000020	MICHAEL<	L THOMPSON<
000003	000030	SALLY<	A KWAN<
000004	000050	JAN<	B GEYER<
-803	000050	IRVING<	F STERN<
000006	000070	EVA<	D PULASKI<
000007	000090	EILEEN<	W HENDERSON<
000008	000100	THEODORE<	Q SPENCER<
000009	000110	VINCENZO<	G LUCCHESI<
000010	000120	SEAN<	O'CONNELL<
000011	000130	DOLORES<	M QUINTANA<
000012	000140	HEATHER<	A NICHOLLS<
Command ==>			Scroll PAGE
F1=Help	F2=Zoom	F3=Exit	F4=CRetrie v
F7=Up	F8=Down	F9=Swap	F10=Left
			F11=Right
			F6=RChange
			F12=Cancel

To determine the type of error, type **E** in the prefix area for the row in error and press Enter. FM/Db2 displays an error information panel that describes the error and instructions about what you can do to correct the error.

Figure 58. Example: error information describing the type of error that occurred during an Edit session

Db2 Save Error Action	
S	Db2 reported an error while attempting to save this row.
F	Duplicate Row Error
L	The insert or update operation on this line would have resulted in two rows with the same index key, and the index is defined as unique.
0	Instructions:
0	Press ENTER or enter EXIT to return to the edit session and correct the error in this line.
E	Enter CANCEL to terminate the Edit session.
0	Any changes made since the last commit point will be lost.
0	Command ==>
0	F1=Help
0	F2=Split
0	F3=Exit
0	F7=Backward
C	F8=Forward
	F9=Swap
	F12=Cancel
	1 of 42
	Format TABL
	ENO HIREDATE
	#7
) DATE
	<----+----->
	01/01/1965
	10/10/1973
	04/05/1975
	08/17/1949
	09/14/1973
	09/30/1980
	08/15/1970
	06/19/1980
	05/16/1958
	12/05/1963
	07/28/1971
	12/15/1976
	Scroll PAGE
	F6=RChange
	F12=Cancel

You can then take one of the following actions:

- Cancel the Edit session by pressing the Cancel function key (F12). Any uncommitted changes are lost.
- Press Enter or the Exit function key (F3) to return to the Edit session.

- Use the REDIT primary command (if the error information panel offers it as an option) to edit the related table to correct the error.



Note: If the error information panel does *not* offer the REDIT primary command as an option, REDIT displays an Edit session.

In the example shown in [Figure 57: Example: error indicated during Edit session on page 201](#), the error has been caused by two rows having the same index key (rows 4 and 5 both have an EMPNO of 000050). To correct the error:

1. Press Enter to return to the Edit session.
2. Change the offending index key for row 5 to a unique value such as 000060.
3. Press the Exit function key (F3) to return to the Edit session.

Related references

[Table Edit panel on page 826](#)

[REDIT primary command on page 931](#)

Chapter 6. Creating and dropping Db2® objects

You can use the Objects utility to create and drop Db2® objects without needing to know the SQL commands for these operations.

The Db2® Object Functions panel is option 3.2 from the Primary Option Menu panel. From the Db2® Object Functions panel you can select the Db2® object type you want to create or drop:

1. Specify the relevant number in the **Object Type** entry field. When you first display the Db2® Object Functions panel, this field is initialized to 3 (Table).
2. If you intend to drop an object but would like FM/Db2 to display a Drop Confirmation panel before it actually drops the object you have specified, ensure the **Confirm object drop** option is checked.
3. To *create* the specified object type, type **C** on the command line.

To *drop* the specified object type, type **D** on the command line.

4. Press Enter.

[Table 9: Supported actions for each Db2 object on page 203](#) shows the Db2® object types you can create or drop.

Table 9. Supported actions for each Db2® object

Object Type	Create	Drop
Database	Yes	Yes
Table space	Yes	Yes
Table	Yes	Yes
View	Yes	Yes
Alias	Yes	Yes
Index	Yes	Yes
Synonym	Yes	Yes
Distinct Type	Yes	Yes
Function	Yes	Yes
Stored Procedure	Yes	Yes
Trigger	Yes	Yes
Auxiliary Table	Yes	No ¹⁴

14.  **Notes:**

Related references

[Primary Option Menu panel on page 728](#)

[Utility Functions panel on page 864](#)

[Db2 Object Functions panel on page 604](#)

[Drop Confirmation panel on page 622](#)

Working with the Create and Drop panels

Here are a few general points relating to the usage of the Create and Drop panels:

You cannot use wildcard characters when using the Create or Drop panels.

You can type **SQL** on the command line of the main Create and Drop panels and the Drop Confirmation panel to examine the SQL that would be constructed given the current panel inputs.

If you receive a validation error when inputting data on the panels, a brief error message is displayed on the upper right of the panel. To obtain a more detailed explanation of the error message, press the Help function key (F1). Also, if you receive an SQL error during the Create or Drop operation, you can press the Help function key (F1) to receive a more detailed explanation. Press the Help function key (F1) again to examine the SQL statement and the cause of the error.

Some of the Create panels such as the Create Table Space panel and the Create Function panel incorporate a number of subsidiary panels to collect the Create statement inputs. Generally, only a few of these panels are required, therefore you do not need to visit all of the lower-level panels before executing the Create statement. The inputs and the panels that are required are indicated on the main panel. Generally, you can visit and revisit the subsidiary panels in any order but exceptions are indicated on the main panel. If you receive an SQL error during the create operation, you need only return to the panels that are in error to correct the errors and then try the Create operation again. When inputting your data on the subsidiary panel, you can press Enter to validate your changes, the Exit function key (F3) to save your changes and return to the main panel, or the Cancel function key (F12) to return to the main panel without saving your changes.

Many of the subsidiary panels use ISPF tables to manage object information that can have more than one occurrence, such as the columns of a table or the parameters of a function. Each line in the table contains a set of values for an occurrence of the piece of information.

When editing the ISPF tables, you can repeat, delete, and insert lines when the CMD field is displayed using the following commands:



1. Use table drop. Populated auxiliary tables can only be dropped by dropping their associated base table. To drop an unpopulated auxiliary table without dropping its base table:
 - Use the drop table function (by selecting Object Type 3 and entering D on the command line on the Db2® Object Functions panel.
 - Specify the auxiliary table as the table to drop.

I

Inserts a new (blank) line at the current position.

I(*n*)

Inserts *n* new (blank) lines at the current position.

D

Deletes the line.

D(*n*)

Deletes *n* lines, starting at the current position.

R

Repeats the line.

R(*n*)

Repeats the line *n* times.

If the **Cmd** field is not displayed, you can only edit some fields in the existing lines.

SQL Keywords

[Table 10: Create Database on page 206](#) through to [Table 21: Create Auxiliary Table on page 218](#) show, for each of the Create panels (and, where applicable, for each subsidiary panel), the SQL keyword (or variable) that relates to each entry field on that panel.

For example, [Table 10: Create Database on page 206](#) shows that, on the main Create Database panel, the optional entry field **Storage group name** relates to the SQL keyword STOGROUP. When FM/Db2 builds the CREATE DATABASE statement, if you have entered a name (*stogroup-name*) in the **Storage group name** entry field, FM/Db2 generates the storage group part of the CREATE DATABASE statement syntax as:

```
STOGROUP stogroup-name
```

**Note:**

1. In some cases, a keyword that is valid for the connected Db2® version is not displayed on any panel because, although the keyword is supported, it is not required to build the SQL statement. The create index **TYPE** parameter is an example of this.
2. Some keyword values are managed entirely by FM/Db2 and are displayed only as output fields on the panels, and are included here for reference. For example, for the **PART** keyword, FM/Db2 generates the value set for



NUMPARTS. Fields that are displayed elsewhere as input fields are not redocumented if they reappear as output fields.

- Where possible, fields are associated with SQL keywords (rather than the values associated with those keywords). Otherwise, they are associated with the value-names shown in the relevant SQL syntax diagram. Occasionally more detailed context is given to avoid ambiguity.

Table 10. Create Database

Main/subsidiary panel	Field	SQL Keyword(s)
Main	(See Create Database panel on page 514.)	
	(Database) Name	<i>database-name</i>
	Storage group name	STOGROUP
	Buffer pool for table spaces	BUFFERPOOL
	Buffer pool for indexes	INDEXBP
	Database usage	AS WORKFILE
	Database usage	AS TEMP
	Data encoding	CCSID
	Member name	FOR MEMBER

Table 11. Create Table Space

Main/subsidiary panel	Field	SQL Keyword(s)
Main	(See Create Table Space panel on page 549.)	
	(Table space) Name	<i>table-space-name</i>
	Database	IN
	Buffer pool	BUFFERPOOL
1. Type	(See Create Table Space: Type panel on page 558.)	
	Table Space Type	LARGE
	Table Space Type	LOB
	Segment size	SEGSIZE

Table 11. Create Table Space

(continued)

Main/subsidiary panel	Field	SQL Keyword(s)
	No. of partitions	NUMPARTS
	Max. partition size	DSSIZE
2. Allocation	(See Create Table Space: Allocation panel on page 551.)	
	VCAT name	VCAT
	Storage group name	STOGROUP
	Primary space	PRIQTY
	Secondary space	SECQTY
	Free pages	FREEPAGE
	Free space	PCTFREE
	Maximum rows per page	MAXROWS
3. Data Storage Options	(See Create Table Space: Data Storage Options panel on page 553.)	
	Use data compression	COMPRESS
	Close if not in use	CLOSE
	Erase data on delete	ERASE
	Define data set now	DEFINE
	INSERT uses clustering index	MEMBER CLUSTER
	Track modified changes	TRACKMOD
	Log changes to LOB columns	LOG
	Data encoding	CCSID
4. Locking Options	(See Create Table Space: Locking Options panel on page 557.)	
	Locksize parameter	LOCKSIZE
	Application Locking	LOCKMAX
5. Data Sharing Options	(See Create Table Space: Data Sharing Options panel on page 552.)	
	Selective Partition Locking	LOCKPART
	Group Buffer Pool Usage	GBPCACHE
6. Define Partitions	(See Create Table Space: Define Partitions panel on page 555.)	

Table 11. Create Table Space

(continued)

Main/subsidiary panel	Field	SQL Keyword(s)
	Pt. No.	PART
	VCAT name	VCAT
	Storage group name	STOGROUP
	Primary space	PRIQTY
	Secndry space	SECQTY
	Erase Data	ERASE
	Free pages	FREEPAGE
	Free space	PCTFREE
	Use Data Cmpr	COMPRESS
	Group BP Caching	GBPCACHE

Table 12. Create Table

Main/subsidiary panel	Field	SQL Keyword(s)
Main	(See Create Table panel on page 546.)	
	(New Table) Owner	<i>table-name</i>
	(New Table) Name	<i>table-name</i>
	(New Table) Database	IN
	(New Table) Table Space	IN
	(Model Table) Owner	LIKE
	(Model Table) Name	LIKE
1. Columns	(See Create Table: Columns panel on page 562.)	
	Column Name	<i>column-name</i>
	Data Type	<i>built-in-data-type</i>
	Len	<i>built-in-data-type</i>
	Pr	<i>built-in-data-type</i> (numeric only)

Table 12. Create Table

(continued)

Main/subsidiary panel	Field	SQL Keyword(s)
	Sc	<i>built-in-data-type</i> (decimal only)
	For Data	FOR ... DATA
	User Defined Data Type	<i>distinct-type-name</i>
2. Default Values	(See Create Table: Nulls and Default Values panel on page 568.)	
	Not Null	NOT NULL
	Default Value	WITH DEFAULT
3. Options	(See Create Table: Options panel on page 571.)	
	Editproc	EDITPROC
	Validproc	VALIDPROC
	OBID value	OBID
	Audit Options	AUDIT
	Data Storage Options	CCSID
	Log data capture changes	DATA CAPTURE
	Restrict drop of table	WITH RESTRICT ON DROP
4. Primary Key	(See Create Table: Unique Constraints panel on page 579.)	
	Constraint Name	CONSTRAINT <i>constraint-name</i> PRIMARY KEY
	Order	PRIMARY KEY (<i>column-name ...</i>)
5. Foreign Key	(See Create Table: Column Referential Constraints panel on page 561.)	
	Constrnt Name	FOREIGN KEY
	Owner	REFERENCES
	Table Name	REFERENCES
	Column Name	REFERENCES
	ON DLT	ON DELETE
6. Check Constraints	(See Create Table: Column Check Constraints panel on page 559.)	
	Table Constraint	CONSTRAINT <i>constraint-name</i> CHECK
	Check Condition	CHECK (<i>check-condition ...</i>)

Table 12. Create Table

(continued)

Main/subsidiary panel	Field	SQL Keyword(s)
	(Constraint) Name	CONSTRAINT <i>constraint-name</i> CHECK
	(Constraint) Condition	CHECK (<i>check-condition ...</i>)
7. Procedure Exits	(See Create Table: Procedure Exits panel on page 573.)	
	Name	FIELDPROC
	Parameters	FIELDPROC
8. Generate Values	(See Create Table: Generate Values panel on page 565.)	
	Gen (A/D)	GENERATE
	As Idty (Y/N)	AS IDENTITY
	Start value	START WITH
	Incr value	INCREMENT BY
	Caching Option	(NO) CACHE

Table 13. Create View

Main/subsidiary panel	Field	SQL Keyword(s)
Main	(See Create View panel on page 585.)	
	Owner	<i>view-name</i>
	Name	<i>view-name</i>
	Select statement	AS
	Column names	<i>column-name ...</i>
	With Check Option	WITH ... CHECK OPTION

Table 14. Create Alias

Main/subsidiary panel	Field	SQL Keyword(s)
Main	(See Create Alias panel on page 512.)	

Table 14. Create Alias

(continued)

Main/subsidiary panel	Field	SQL Keyword(s)
	(Alias) Owner	<i>alias-name</i>
	(Alias) Name	<i>alias-name</i>
	(Table or View) Location	FOR
	(Table or View) Owner	FOR
	(Table or View) Name	FOR

Table 15. Create Index

Main/subsidiary panel	Field	SQL Keyword(s)
Main	(See Create Index panel on page 527.)	
	Owner	<i>index-name</i>
	Name	<i>index-name</i>
	Table Owner	ON
	Table Name	ON
	Buffer Pool	BUFFERPOOL
1. Index Type	(See Create Index: Type panel on page 537.)	
	Uniqueness	UNIQUE WHERE NOT NULL
	Internal format	TYPE
	Clustering Index Option	CLUSTER
	Piecesize	PIECESIZE
	Multiplier	PIECESIZE
2. Column Selection	(See Create Index: Column Selection panel on page 531.)	
	Order	<i>column-name</i>
	(A/D)	<i>column-name</i>
3. Allocation	(See Create Index: Allocation panel on page 530.)	
	VCAT name	VCAT

Table 15. Create Index

(continued)

Main/subsidiary panel	Field	SQL Keyword(s)
	Storage group name	STOGROUP
	Primary space	PRIQTY
	Secondary space	SECQTY
	Free pages	FREEPAGE
	Free space	PCTFREE
4. Options	(See Create Index: Options panel on page 532.)	
	Close if not in use	CLOSE
	Erase data on delete	ERASE
	Defer building index	DEFER
	Define data set now	DEFINE
	Allow COPY of index	COPY
	Group Buffer Pool Usage	GBPCACHE
5. Partitions	(See Create Index: Partitions panel on page 534.)	
	Parttn. Number	PART
	VCAT name	VCAT
	Storage group name	STOGROUP
	Primary space	PRIQTY
	Secndry space	SECQTY
	Erase Data	ERASE
	Free pages	FREEPAGE
	Free space	PCTFREE
	Group BP Caching	GBPCACHE
6. Partition Values	(See Create Index: Partition Values panel on page 535.)	
	Value	VALUES

Table 16. Create Synonym

Main/subsidiary panel	Field	SQL Keyword(s)
Main	(See Create Synonym panel on page 545.)	
	(Synonym) Name	<i>synonym</i>
	(Table) Owner	FOR
	(Table) Name	FOR

Table 17. Create Distinct Type

Main/subsidiary panel	Field	SQL Keyword(s)
Main	(See Create Distinct Type panel on page 516.)	
	Schema	<i>distinct-type-name</i>
	Name	<i>distinct-type-name</i>
	Source Type	AS
	Length	AS
	Scale	AS
	For Data	FOR ... DATA
	Encoding Method	CCSID

Table 18. Create Function

Main/subsidiary panel	Field	SQL Keyword(s)
Main	(See Create Function panel on page 521.)	
	Schema	<i>function-name</i>
	Name	<i>function-name</i>
	Unique Name	SPECIFIC
1. Parameters	(See Create Function: Parameters panel on page 524.)	
	Parameter Name	<i>parameter-name</i>

Table 18. Create Function

(continued)

Main/subsidiary panel	Field	SQL Keyword(s)
	Data Type	<i>built-in-data-type</i>
	Len	<i>built-in-data-type</i>
	Pr	<i>built-in-data-type</i>
	Sc	<i>built-in-data-type</i>
	For Data	FOR ... DATA
	User Defined Data Type	<i>distinct-type-name</i>
2. Parameter Types	(See Create Function: Parameter Types panel on page 522.)	
	As LOC	AS LOCATOR
	Owner	TABLE LIKE
	Name	TABLE LIKE
3. Returned Data Type	(See Create Function: Returned Data Type panel on page 525.)	
	(Returns) Data Type	RETURNS
	(Returns) Schema	RETURNS
	(Returns) Length	RETURNS
	(Returns) Scale	RETURNS
	(Returns) For Data	RETURNS ... FOR ... DATA
	(Returns) Encoding Method	RETURNS ... CCSID
	(Cast From) Data Type	CAST FROM
	(Cast From) Length	CAST FROM
	(Cast From) Scale	CAST FROM
	(Cast From) For Data	CAST FROM ... FOR ... DATA
	(Cast From) Encoding Method	CAST FROM ... CCSID
	As Locator	RETURNS ... AS LOCATOR
4. Option List (1/2)	(See Create Function: Option List (1/2) panel on page 518.)	
	External Name	EXTERNAL NAME
	Scratchpad	(NO) SCRATCHPAD

Table 18. Create Function

(continued)

Main/subsidiary panel	Field	SQL Keyword(s)
	Package Collection	(NO) COLLID
	Workload Manager Environment	WLM ENVIRONMENT
	Time Limit	ASUTIME (NO) LIMIT
	Language	LANGUAGE
	SQL	(READS)(NO)(MODIFIES) (CONTAINS) SQL (DATA)
	Security	SECURITY
	Parallel	(DIS)ALLOW PARALLEL
	Run-time Options	RUN OPTIONS
5. Option List (2/2)	(See Create Function: Option List (2/2) panel on page 519.)	
	Main Program	PROGRAM TYPE
	Stay Resident	STAY RESIDENT
	Deterministic	(NOT) DETERMINISTIC
	Called on null input	(RETURNS NULL)(CALLED) ON NULL INPUT
	No external action	(NO) EXTERNAL ACTION
	Final Call	(NO) FINAL CALL
	DBINFO argument passed	(NO) DBINFO

Table 19. Create Procedure

Main/subsidiary panel	Field	SQL Keyword(s)
Main	(See Create Procedure panel on page 538.)	
	Schema	<i>procedure-name</i>
	Name	<i>procedure-name</i>
	Result Sets	DYNAMIC RESULT SET(S)
1. Parameters	(See Create Procedure: Parameters panel on page 543.)	
	Parameter Name	<i>parameter-name</i>

Table 19. Create Procedure**(continued)**

Main/subsidiary panel	Field	SQL Keyword(s)
	Data Type	<i>built-in-data-type</i>
	Len	<i>built-in-data-type</i>
	Pr	<i>built-in-data-type</i>
	Sc	<i>built-in-data-type</i>
	For Data	FOR ... DATA
	User Defined Data Type	<i>distinct-type-name</i>
2. Parameter Types	(See Create Procedure: Parameter Types panel on page 542.)	
	As LOC	AS LOCATOR
	Owner	TABLE LIKE
	Name	TABLE LIKE
	IN OUT INOUT	(IN)(OUT)(INOUT)
4. Option List (1/2)	(See Create Procedure: Option List (1/2) panel on page 539.)	
	External Name	EXTERNAL NAME
	Package Collection	(NO) COLLID
	Workload Manager Environment	(NO) WLM ENVIRONMENT
	Time Limit	ASUTIME (NO) LIMIT
	Language	LANGUAGE
	SQL	(READS)(NO)(MODIFIES) (CONTAINS) SQL (DATA)
	Security	SECURITY
	Parameter Style	PARAMETER STYLE
	Run-time Options	RUN OPTIONS
5. Option List (2/2)	(See Create Procedure: Option List (2/2) panel on page 541.)	
	Main Program	PROGRAM TYPE
	Stay Resident	STAY RESIDENT
	Deterministic	(NOT) DETERMINISTIC
	DBINFO argument passed	(NO) DBINFO

Table 19. Create Procedure

(continued)

Main/subsidiary panel	Field	SQL Keyword(s)
	Commit on return	COMMIT ON RETURN

Table 20. Create Trigger

Main/subsidiary panel	Field	SQL Keyword(s)
Main	(See Create Trigger panel on page 580.)	
	Schema	<i>trigger-name</i>
	Name	<i>trigger-name</i>
1. Type	(See Create Trigger: Details panel on page 582.)	
	(Order) No cascade before	NO CASCADE BEFORE
	(Order) After	AFTER
	(Type) Insert	INSERT
	(Type) Delete	DELETE
	(Type) Update	UPDATE
	Columns	UPDATE OF
	(Trigger Table) Name	ON
	(Trigger Table) Owner	ON
	Old correlation name	OLD
	New correlation name	NEW
	Old table identifier	OLD TABLE
	New table identifier	NEW TABLE
	(Executed) For each modified row	FOR EACH ROW
	(Executed) Once	FOR EACH STATEMENT
2. Search Condition	(See Create Trigger: Search Condition panel on page 584.)	
	Search Condition	WHEN
3. SQL Statement	(See Create Trigger: SQL statement panel on page 584.)	

Table 20. Create Trigger

(continued)

Main/subsidiary panel	Field	SQL Keyword(s)
	Triggered SQL Statement(s)	BEGIN ATOMIC

Table 21. Create Auxiliary Table

Main/subsidiary panel	Field	SQL Keyword(s)
Main	(See Create Auxiliary Table panel on page 513.)	
	(Auxiliary Table) Owner	<i>aux-table-name</i>
	(Auxiliary Table) Name	<i>aux-table-name</i>
	(Table Space) Name	IN
	Database	IN
	(Base Table) Owner	STORES
	(Base Table) Name	STORES
	(Base Table Column) Name	COLUMN
	Partition	PART

Creating a database

To create a new database, perform the following on the Db2® Object Functions panel:

1. Type **1** in the **Object Type** entry field.
2. Type **0** on the command line.
3. Press Enter. FM/Db2 displays the Create Database panel.

The Create Database panel defines a Db2® database at the current server.

The only required field on the panel is the first, where you enter the name for the new database. All of the other fields on the panel are optional, although values are often specified for the second group of input fields.

The database options and member selection sections of the panel contain input fields that you can use to define a work file or temporary database.

The default data encoding scheme for z/OS® systems is EBCDIC. You can specify ASCII encoding if required.

For workfile databases, you can also specify a member name (for use in a data sharing environment only).

Related references

[Db2 Object Functions panel on page 604](#)

[Create Database panel on page 514](#)

Creating a table space

To create a new table space, perform the following on the Db2® Object Functions panel:

1. Type `T` in the **Object Type** entry field.
2. Type `C` on the command line.
3. Press Enter. FM/Db2 displays the Create Table Space panel.

Use the Create Table Space panel to define a simple, segmented or partitioned table space at the current server.

Related tasks

[Table Space Type \(Create Table Space\) on page 219](#)

[Table Space Allocation \(Create Table Space\) on page 220](#)

[Data Storage \(Create Table Space\) on page 220](#)

[Locking \(Create Table Space\) on page 220](#)

[Data Sharing \(Create Table Space\) on page 220](#)

[Partitions \(Create Table Space\) on page 221](#)

Related references

[Db2 Object Functions panel on page 604](#)

[Create Table Space panel on page 549](#)

[Create Table Space: Type panel on page 558](#)

[Create Table Space: Allocation panel on page 551](#)

[Create Table Space: Data Storage Options panel on page 553](#)

[Create Table Space: Locking Options panel on page 557](#)

[Create Table Space: Data Sharing Options panel on page 552](#)

[Create Table Space: Define Partitions panel on page 555](#)

Table Space Type (Create Table Space)

In Db2®, table space is either non-partitioned, or partitioned. A non-partitioned table space can be segmented (a partitioned table space cannot). Non-partitioned means that there is a 1:1 relationship between the table space and the data set defined to store the data. Partition means that many data sets are used to store the data.

To make more effective use of non-partitioned table spaces, by improving the support for multiple table definitions within the one table space, use segmented table spaces.

The maximum partition size for a partitioned table space determines the amount of data that can be stored within the table space. Large values imply the creation of multi-volume table spaces capable of storing GB of data.

Related references

[Create Table Space: Type panel on page 558](#)

Table Space Allocation (Create Table Space)

The Create Table Space: Allocation panel is optional, although most users need to specify a Db2® storage group and the size of the table space.

You have the option of defining Db2® data sets externally, or Db2® can create the data sets on behalf of you. The former option is selected by specifying a VCAT name in the data set parameters section of the panel. The most common option is to specify a (Db2®) storage group name. These parameters are mutually exclusive.

Related references

[Create Table Space: Allocation panel on page 551](#)

Data Storage (Create Table Space)

Use the Create Table Space: Data Sharing Options panel to specify options that control various aspects of data management for the function.

Related references

[Create Table Space: Data Sharing Options panel on page 552](#)

Locking (Create Table Space)

The locksize parameter specifies the size of locks within the table space.

You can select from six different locking parameters. Page and Row cannot be specified for LOB table spaces. Table can only be specified for a segmented table space.

You can also specify a maximum value for the number of locks that application programs can hold on a table space before lock escalation occurs.

Related references

[Create Table Space: Locking Options panel on page 557](#)

Data Sharing (Create Table Space)

The Create Table Space: Data Sharing Options panel is optional and contains options that control how the table space behaves in a data sharing environment. In most cases, the default values are appropriate.

Related references

[Create Table Space: Data Sharing Options panel on page 552](#)

Partitions (Create Table Space)

The Create Table Space: Define Partitions panel is optional, even for the definition of a partitioned table space. However, you might want to specify parameters for each partition of a partitioned table space, rather than relying on the values set at the table space level.

For a partitioned table space, there is an optional 'USING CLAUSE' for every partition of the table space. You can define the number of partitions on the Table Space Type panel before selecting this panel. The table at the bottom of the panel is pre-formatted with the required number of rows (one for each partition).

Alternatively, you can select the Define Partitions panels directly. The number of pre-formatted rows reflect the value specified for a number of partitions (the default value is 1). You can then adjust the values for this single partition to what is required. After this is done, you can use the R prefix command (optionally followed by an integer) to expand the number of partitions to the required number. The value specified for number of partitions on the Table space Type panel is updated accordingly.



Note: The individual partitions of a partitioned table space are typically defined with similar parameters. It is easier for you to define the values once, then repeat them, rather than type the same information in for each row repeatedly.

The Db2® default values for Free Pages, Percent Free, Data Compression and GBPCACHE are used.

Related references

[Create Table Space: Define Partitions panel on page 555](#)

[Create Table Space: Type panel on page 558](#)

Creating a table

To create a new table, perform the following on the Db2® Object Functions panel:

1. Type **3** in the **Object Type** entry field.
2. Type **4** on the command line.
3. Press Enter. FM/Db2 displays the Create Table panel.

Use the Create Table utility to create a new Db2® table. If a table already exists that is similar to the one you want to create, you can use that table as a model for the new table.

Related tasks

[1. Columns \(Create Table\) on page 226](#)

[2. Nulls and default values \(Create Table\) on page 226](#)

3. [Options \(Create Table\) on page 227](#)
4. [Unique constraints \(Create Table\) on page 227](#)
5. [Referential constraints \(Create Table\) on page 227](#)
6. [Check constraints \(Create Table\) on page 229](#)
7. [Procedure exits \(Create Table\) on page 230](#)
8. [Generate values \(Create Table\) on page 230](#)

Related references

- [Db2 Object Functions panel on page 604](#)
- [Create Table panel on page 546](#)
- [Create Table: Columns panel on page 562](#)
- [Create Table: Nulls and Default Values panel on page 568](#)
- [Create Table: Options panel on page 571](#)
- [Create Table: Unique Constraints panel on page 579](#)
- [Create Table: Column Referential Constraints panel on page 561](#)
- [Create Table: Column Check Constraints panel on page 559](#)
- [Create Table: Procedure Exits panel on page 573](#)
- [Create Table: Generate Values panel on page 565](#)

Creating a table using a model

The Create Table utility lets you use an existing table or view as a model for the new table you want to create. You can use this modeling facility to create a table in either of these ways:

- With columns that have exactly the same name and description as the model table or view: Usage option 1.



Note: If you use Usage option 1, none of the Table Creation options related to columns are available (Db2® copies the column information about the model table or view when it issues the CREATE TABLE statement). However, you can still specify non-column details on the main panel and by selecting Table Creation option 3 (**Table options**).

- Based on the model table or view but where you want to change some of the column details : Usage option 2, Table Creation options 1–8.

To create a table with columns that have exactly the same name and description as the model table or view:

1. Specify the name of the table you want to create in **New Table**.
2. Specify the name of the model table or view in **Model Table/View**. You can optionally qualify the name of the model table or view by specifying an owner. If you do not specify a model table (or view) owner, FM/Db2 uses your current SQL ID.
3. Select Usage option 1 (**Generate LIKE clause**).
4. Select the Table Creation option **Create the table**.

5. Press Enter.

FM/Db2 generates the following SQL statement:

```
CREATE TABLE new_table_name LIKE model_table_name
```

before sending it to Db2® for execution. FM/Db2 issues a message to confirm that the generated SQL statement has been run. For further details about the LIKE clause in the CREATE TABLE statement, see the *Db2 UDB for z/OS SQL Reference*.



Note: To view the generated SQL statement, either before or after it is issued, enter `SQL` on the command line.

To create a table based on the model table or view, but where you want to change some of the column details:

1. Specify the name of the Db2® table you want to create in **New Table**.
2. Specify the name of the model Db2® table or view in **Model Table/View**. You can optionally qualify the name of the model table or view by specifying an owner. If you do not specify a model table (or view) owner, FM/Db2 uses your current SQL ID.
3. Select Usage option 2 (**Load table information**).
4. Press Enter.

FM/Db2 displays the Create Table Model Load panel.



Note: The Create Table Model Load panel is displayed if you:

- Initially specify, or subsequently change, the **Model Table/View** details,
- Select Usage option 2 (**Load table information**), and
- Press Enter.

Use the Create Table Model Load panel to selectively load information describing the model table or view from the Db2® catalog into the ISPF variables and tables used to generate the CREATE TABLE statement. You can also use this panel to specify whether you want this information to replace the current information, or to be added to it.

5. Select the **Model Load Options** you want by typing a slash (/) next to the required option. (FM/Db2 selects the first three options for you.) To deselect a model load option, type a blank in place of the slash.



Note: If no data exists in the model table or view for any of the model load options you select, FM/Db2 issues the message “*Some data not loaded*” when it redisplay the main panel.

When you return to the main Create Table panel, you can change or add to this information by selecting the appropriate table creation option 1–8. For details, see [Table Creation options on page 225](#).



Note: If you use a view as the model, FM/Db2 loads only the database name, table space name, encoding scheme, and column information.

6. To specify whether you want FM/Db2 to use the information about the model table or view as a refresh, or if you want FM/Db2 to add it to the current information for the table you are creating, select the appropriate **Refresh/Add** option.
7. If the model table has referential constraints, specify whether you want single-column referential constraints loaded as *column* referential constraints or *table* referential constraints by selecting one of the following options:
 - 1. Column referential constraints
 - 2. Table referential constraints



Note:

- a. FM/Db2 does not check for duplicate column names if multiple model tables (or views) are loaded or model table (or view) columns are added to manually-defined columns.
- b. If you select any of the key or constraint options (**Primary key information**, **Unique key information**, **Referential constraints** or **Check constraints**), the **Column information** option is selected automatically.
- c. FM/Db2 loads all check constraint information in the form of *table* check constraints.

8. Press Enter.

FM/Db2 loads information into the ISPF variables and tables used to generate the CREATE TABLE statement according to the **Model Load Options** and **Refresh/Add** options you have selected and returns you to the main Create Table panel.



Note: To view the generated SQL statement, type `SQL` on the command line of the main Create Table panel.

9. To specify further information for the table you want to create, select any of the table creation options 1–8 and press Enter.

FM/Db2 validates your input and displays a panel that you use to enter information for the table creation option you have selected. For details about each table creation option, see [Table Creation options on page 225](#).

10. Select the Table Creation option **Create the table** on the main panel.

11. Press Enter.

FM/Db2 generates the following SQL statement:

```
CREATE TABLE new_table_name other_details
```

where *other_details* represents SQL clauses based on the details you have selected using the model table or view and Table Creation options. FM/Db2 sends the generated SQL statement to Db2® and issues a message to confirm that it has been successfully run.



Note: To view the generated SQL statement, either before or after it is issued, enter `SQL` on the command line.

Related references

[Create Table: Model Load panel on page 566](#)

[Create Table panel on page 546](#)

Creating a table without using a model

To create a new table without using a model (for instance, if no table already exists that is similar to the one you want to create):

1. Specify the name of the Db2® table you want to create in **New Table**.
2. Leave the owner and name of the model Db2® table in **Model Table** blank.
3. Select any of the Table Creation options 1–8 and press Enter. The default setting is Option 1 (**Columns**).



Note: Before you can specify any of the table creation options 2, 4, 5, 6, 7, or 8, you must create at least some of the columns for the new table (using option 1).

FM/Db2 validates your input and displays a panel that you use to enter information for the table creation option you have selected.

For information about each table creation option, see [Table Creation options on page 225](#).

4. Select the Table Creation option **Create the table**
5. Press Enter.

FM/Db2 generates the following SQL statement:

```
CREATE TABLE new_table_name other_details
```

where *other_details* represents SQL clauses based on the details you have selected using the Table Creation options. FM/Db2 sends the generated SQL statement to Db2® and issues a message to confirm that it has been successfully run.



Note: To view the generated SQL statement, either before or after it is issued, enter `SQL` on the command line.

Table Creation options

Use the table creation options on the main Create Table panel to provide additional information to define the table you are creating.

If you are using a model table with Usage option 2, you can select any of the options 1–8 before using the Table Creation option **Create the table** to create the table. If you have already used the Model Load panel to provide information for the table you want to create, use the table creation options to supplement or change details you have already selected.

If you are *not* using a model table, you must select option 1 (**Columns**) and then optionally options 2–8, before using the Table Creation option **Create the table** to create the table.

You can revisit each of the table creation options as many times as you want to add or modify the data.

If you select one of the table creation options 1 to 8, FM/Db2 displays a panel that you use to enter information for the creation option you have selected. If you select the Table Creation option **Create the table**, FM/Db2 generates and issues a CREATE TABLE SQL statement.

The following pages describe the panels for each creation option.

Related references

[Create Table panel on page 546](#)

[Create Table: Model Load panel on page 566](#)

1. Columns (Create Table)

The Create Table Columns panel is displayed if you select Table Creation option 1 (**Columns**) on the main Create Table panel. You use this panel to define columns for the table you are creating, or to change information for columns you have already defined.

The lower section of the panel shows the columns defined for the table. (If you have not yet defined any columns, this part of the panel shows a single line of empty entry fields.) If you have used the modeling facility, the panel shows the column details for each column in the model table.

Related references

[Create Table: Columns panel on page 562](#)

[Create Table panel on page 546](#)

2. Nulls and default values (Create Table)

The Nulls and Default Values panel is displayed if you select Table Creation option 2 (**Nulls/default values**) on the main Create Table panel.

The Nulls and Default Values panel shows the columns defined for the table. If you have used the modeling facility, the panel shows the column details for each column in the model table. You use this panel to specify information to define the null attributes and default values for the columns of the table you are creating.

Related references

[Create Table: Nulls and Default Values panel on page 568](#)

[Create Table panel on page 546](#)

3. Options (Create Table)

The Options panel is displayed if you select Table Creation option 3 (**Table options**) on the main Create Table panel.

You use the Options panel to specify information to define options for the table you are creating.

Related references

[Create Table: Options panel on page 571](#)

[Create Table panel on page 546](#)

4. Unique constraints (Create Table)

The Unique Constraints panel is displayed if you select Table Creation option 4 (**Unique Constraints**) on the main Create Table panel.

You use the Unique Constraints panel to specify information to define a primary key and up to three additional unique keys for the table you are creating. The panel shows only those columns that are defined as NOT NULL (and therefore eligible to be selected as part of either the primary key or a unique key).

To define the primary key or any of the three unique keys, enter **S** or a number in one of the **Column Order in Key** fields to add a column to the key. If you enter **S**, FM/Db2 generates the next highest number for that key. To deselect a column that is already selected, clear the displayed number by overtyping it with spaces.



Note: The actual numbers are not important; FM/Db2 uses their relative order to define the column order for the key.

You can optionally specify constraint names for the primary key and the three unique keys.

Related references

[Create Table: Unique Constraints panel on page 579](#)

[Create Table panel on page 546](#)

5. Referential constraints (Create Table)

If you select Table Creation option 5 (**Referential Constraints**) on the main Create Table panel, FM/Db2 displays either the Column Referential Constraints panel or the Table Referential Constraints panel. To change from one panel to the other, press the F11 function key.



Note: The first time you select the **Referential Constraints** creation option, FM/Db2 displays the Column Referential Constraints panel. Thereafter, within the same invocation of the Create Table utility, each time you select the **Referential Constraints** creation option, FM/Db2 displays whichever panel (column or table) it last displayed.

Column referential constraints and table referential constraints

You can specify referential constraints associated with individual columns (column referential constraints), or with the entire table (table referential constraints).

- A *column referential constraint* relates a column (the foreign key) in the table being created (the dependent table) to an equivalent column (the parent key) in another table (the parent table), and restricts non-null values of the foreign key column to the values of the parent key column.
- A *table referential constraint* relates a set of columns (the foreign key) in the table being created (the dependent table) to an equivalent set of columns (the parent key) in another table (the parent table), and restricts non-null values of the foreign key to the values of the parent key.



Note:

1. The parent key must be a primary or unique key on the parent table.
2. If you do not specify the parent key column name (or names), the foreign key is related to the primary key of the parent table.

To specify column referential constraints, use the Column Referential Constraints panel.

The Column Referential Constraints panel shows the columns defined for the table you are creating. If you have used the modeling facility, the panel shows the column details for each column in the model table. You use this panel to specify information to define column referential constraints for the table you are creating. To define a referential constraint, you must at least specify the parent table name. To indicate a column does not have a referential constraint, leave all the fields for that column blank.

To specify table referential constraints, use the Table Referential Constraints panel. Each row of the panel defines a single table referential constraint.

You use the Table Referential Constraints panel to specify information to define table referential constraints for the table you are creating. To define a referential constraint, you must at least specify the parent table name.

The Create Table Referential Constraint panel is displayed if you enter S in the **Cmd** entry field.

The Create Table Referential Constraint panel shows the columns defined for the table you are creating (the dependent table). If you have used the modeling facility, the panel shows the column details for each column in the model table. You use this panel to select the dependent table columns (the foreign key) and specify the parent table columns (the parent key) to which they relate.

Related references

[Create Table panel on page 546](#)

[Create Table: Column Referential Constraints panel on page 561](#)

[Create Table: Table Referential Constraint panel on page 576](#)

6. Check constraints (Create Table)

If you select Table Creation option 6 (**Check Constraints**) on the main Create Table panel, FM/Db2 displays either the Column Check Constraints panel or the Table Check Constraints panel. To change from one panel to the other, press the F11 function key. You use these panels to specify information to define check constraints for the table you are creating.



Note: The first time you select the **Check Constraints** creation option, FM/Db2 displays the Column Check Constraints panel. Thereafter, within the same invocation of the Create Table utility, each time you select the **Check Constraints** creation option, FM/Db2 displays whichever panel (column or table) it last displayed.

Column check constraints and table check constraints

You can specify check constraints associated with individual columns (column check constraints), or with the entire table (table check constraints). Both types of check constraint produce the same result when the statement is issued, and you can specify any valid check condition as either type. However, you might prefer to use table check constraints for check conditions that would violate the SQL standard (not enforced by Db2®) that a column check constraint only refers to the column on which it is defined.



Note:

1. If model table information is loaded into the Create Table utility, all check constraints defined on the table are loaded as table check constraints.

To specify column check constraints, use the Column Check Constraints panel.

The Column Check Constraints panel shows the columns defined for the table you are creating. If you have used the modeling facility, the panel shows the column details for each column in the model table.

To specify table check constraints, use the Table Check Constraints panel. Each row of the panel defines a single table check constraint.

You use the Table Check Constraints panel to specify an SQL check condition for each check constraint you want to define for the table you are creating.

Related references

[Create Table panel on page 546](#)

[Create Table: Column Check Constraints panel on page 559](#)

[Create Table: Table Check Constraints panel on page 574](#)

7. Procedure exits (Create Table)

The Procedure Exits panel is displayed if you select Table Creation option 7 (**Procedure exits**) on the main Create Table panel.

You use the Procedure Exits panel to specify information to define procedure exits for the table you are creating.

Related references

[Create Table: Procedure Exits panel on page 573](#)

[Create Table panel on page 546](#)

8. Generate values (Create Table)

The Generate Values panel is displayed if you select Table Creation option 8 (**Generate value**) on the main Create Table panel.

You use the Generate Values panel to specify information to define generated values for identity or ROWID columns in the table you are creating.

Related references

[Create Table: Generate Values panel on page 565](#)

[Create Table panel on page 546](#)

Creating a view

To create a new view, perform the following on the Db2® Object Functions panel:

1. Type **v** in the **Object Type** entry field.
2. Type **c** on the command line.
3. Press Enter. FM/Db2 displays the Create View panel.

Use the Create View panel to create a new view at the current location.

Related references

[Db2 Object Functions panel on page 604](#)

[Create View panel on page 585](#)

Creating an alias

To create a new alias, perform the following on the Db2® Object Functions panel:

1. Type **5** in the **Object Type** entry field.
2. Type **c** on the command line.
3. Press Enter. FM/Db2 displays the Create Alias panel.

Use the Create Alias panel to create an alias for a table or a view at the correct location.

An alias is an alternative name for a table or view. The table or view need not exist when the alias is created. The table or view can exist at a different location to the local Db2® system.

Related references

[Db2 Object Functions panel on page 604](#)

[Create Alias panel on page 512](#)

Creating an index

To create a new index, perform the following on the Db2® Object Functions panel:

1. Type **6** in the **Object Type** entry field.
2. Type **c** on the command line.
3. Press Enter. FM/Db2 displays the Create Index panel.

Use the Create Index panel to create an index for a pre-existing base table.

The top section of the panel contains five input fields that define the index to be created. If you entered object name information on the Db2® object functions panel, these values are carried forward and the appropriate name fields are pre-filled.

The bottom part of the panel contains a list of options that need to be completed to define the index. There is a single selection field, in which you can type the number of the required option.

The first option is required (define the columns in the index). Typically, the third option is needed (define the space requirements for the index).

When the index has been completely specified, you select option 7 to create the index.

Related tasks

[Index type \(Create Index\) on page 232](#)

[Index Column Selection \(Create Index\) on page 232](#)

[Allocation \(Create Index\) on page 232](#)

[Index \(Create Index\) on page 232](#)

[Index Partitions \(Create Index\) on page 233](#)

[Partition Values Option \(Create Index\) on page 233](#)

Related references

[Db2 Object Functions panel on page 604](#)

[Create Index panel on page 527](#)

[Create Index: Type panel on page 537](#)

[Create Index: Column Selection panel on page 531](#)

[Create Index: Allocation panel on page 530](#)

[Create Index: Options panel on page 532](#)

[Create Index: Partitions panel on page 534](#)

[Create Index: Partition Values panel on page 535](#)

Index type (Create Index)

You can use the first group of input fields to enter uniqueness information, and the type of index.

Related references

[Create Index: Type panel on page 537](#)

Index Column Selection (Create Index)

Use this panel to select the columns that comprise the index.



Note:

Each time a column is selected using S, it is assigned an order one greater than the maximum order used so far.

If the column currently containing the highest order number is deselected, the maximum order is decremented (otherwise unchanged).

Because of the previous point and the ability of the user to enter an arbitrary number, gaps can occur in the order. However, any such gaps are ignored when the SQL is built.

Related references

[Create Index: Column Selection panel on page 531](#)

Allocation (Create Index)

Use this panel to specify the space requirements for the index being created.

Related references

[Create Index: Allocation panel on page 530](#)

Index (Create Index)

Use this panel to specify various YES/NO and data sharing options. In most cases, the default values are appropriate.

Related references

[Create Index: Options panel on page 532](#)

Index Partitions (Create Index)

Use this panel to specify space information for index partitions.

Related references

[Create Index: Partitions panel on page 534](#)

Partition Values Option (Create Index)

Use this panel to specify limit values for index entries in each partition.

Related references

[Create Index: Partition Values panel on page 535](#)

Creating a synonym

To create a new synonym, perform the following on the Db2® Object Functions panel:

1. Type **7** in the **Object Type** entry field.
2. Type **C** on the command line.
3. Press Enter. FM/Db2 displays the Create Synonym panel.

A synonym is an alternative name for a table or view. It is used as an unqualified identifier and is specific to the SQLID that owns the synonym.

For more details, see the *Db2 UDB for z/OS SQL Reference*.

Related references

[Db2 Object Functions panel on page 604](#)

[Create Synonym panel on page 545](#)

Creating a distinct type

To create a new distinct type, perform the following on the Db2® Object Functions panel:

1. Type **8** in the **Object Type** entry field.
2. Type **C** on the command line.
3. Press Enter. FM/Db2 displays the Create Distinct Type panel.

Related references

[Db2 Object Functions panel on page 604](#)

[Create Distinct Type panel on page 516](#)

Creating a function

To create a new function, perform the following on the Db2® Object Functions panel:

1. Type **g** in the **Object Type** entry field.
2. Type **c** on the command line.
3. Press Enter. FM/Db2 displays the Create Function panel.

Use this panel to create an external scalar function.

Related tasks

[Parameters \(Create Function\) on page 234](#)

[Parameter Types \(Create Function\) on page 234](#)

[Returned Data Type \(Create Function\) on page 235](#)

[Option List 1/2 \(Create Function\) on page 235](#)

[Option List 2/2 \(Create Function\) on page 235](#)

Related references

[Db2 Object Functions panel on page 604](#)

[Create Function panel on page 521](#)

[Create Function: Parameters panel on page 524](#)

[Create Function: Parameter Types panel on page 522](#)

[Create Function: Returned Data Type panel on page 525](#)

[Create Function: Option List \(1/2\) panel on page 518](#)

[Create Function: Option List \(2/2\) panel on page 519](#)

Parameters (Create Function)

Use this panel to define and optionally name the parameters for the function.

Related references

[Create Function: Parameters panel on page 524](#)

Parameter Types (Create Function)

Use this panel to specify additional type information for function parameters.

Related references

[Create Function: Parameter Types panel on page 522](#)

Returned Data Type (Create Function)

Use this panel to specify the data type returned by the function.

Related references

[Create Function: Returned Data Type panel on page 525](#)

Option List 1/2 (Create Function)

Use this panel to specify various options to further define the function.

Related references

[Create Function: Option List \(1/2\) panel on page 518](#)

Option List 2/2 (Create Function)

This panel lets you specify additional options.

Related references

[Create Function: Option List \(2/2\) panel on page 519](#)

Creating a procedure

To create a new procedure, perform the following on the Db2® Object Functions panel:

1. Type `10` in the **Object Type** entry field.
2. Type `c` on the command line.
3. Press Enter. FM/Db2 displays the Create Procedure panel.

Related tasks

[Procedure Parameters \(Create Procedure\) on page 236](#)

[Parameter Types \(Create Procedure\) on page 236](#)

[Option List 1/2 \(Create Procedure\) on page 236](#)

[Option List 2/2 \(Create Procedure\) on page 236](#)

Related references

[Db2 Object Functions panel on page 604](#)

[Create Procedure panel on page 538](#)

[Create Procedure: Parameters panel on page 543](#)

[Create Procedure: Parameter Types panel on page 542](#)

[Create Procedure: Option List \(1/2\) panel on page 539](#)

[Create Procedure: Option List \(2/2\) panel on page 541](#)

Procedure Parameters (Create Procedure)

This panel is equivalent to the Create Function: Parameters panel.

Related references

[Create Procedure: Parameters panel on page 543](#)

[Create Function: Parameters panel on page 524](#)

Parameter Types (Create Procedure)

This panel is equivalent to the Create Function: Parameter Types panel.

Related references

[Create Procedure: Parameter Types panel on page 542](#)

[Create Function: Parameter Types panel on page 522](#)

Option List 1/2 (Create Procedure)

This panel lets you specify various options to further define the procedure.

Related references

[Create Procedure: Option List \(1/2\) panel on page 539](#)

Option List 2/2 (Create Procedure)

This panel lets you specify additional options.

Related references

[Create Procedure: Option List \(2/2\) panel on page 541](#)

Creating a trigger

To create a new trigger, perform the following on the Db2® Object Functions panel:

1. Type **11** in the **Object Type** entry field.
2. Type **c** on the command line.
3. Press Enter. FM/Db2 displays the Create Trigger panel.

Related tasks

[Details \(Create Trigger\) on page 237](#)

[Search Conditions \(Create Trigger\) on page 237](#)

[SQL Statement \(Create Trigger\) on page 237](#)

Related references

- [Db2 Object Functions panel on page 604](#)
- [Create Trigger panel on page 580](#)
- [Create Trigger: Details panel on page 582](#)
- [Create Trigger: Search Condition panel on page 584](#)
- [Create Trigger: SQL statement panel on page 584](#)

Details (Create Trigger)

This panel lets you specify additional details required for the definition of a trigger.

Related references

- [Create Trigger: Details panel on page 582](#)

Search Conditions (Create Trigger)

Use this panel to specify a search condition. The triggered SQL statements are run only if the search condition evaluates to true or is omitted.

Related references

- [Create Trigger: Search Condition panel on page 584](#)

SQL Statement (Create Trigger)

Use this panel to specify the SQL to be run if the trigger is activated.

Related references

- [Create Trigger: SQL statement panel on page 584](#)

Creating an auxiliary table

To create a new auxiliary table, perform the following on the Db2® Object Functions panel:

1. Type `12` in the **Object Type** entry field.
2. Type `c` on the command line.
3. Press Enter. FM/Db2 displays the Create Auxiliary Table panel.

Auxiliary tables are required for LOB support. An auxiliary table is needed if a table contains a LOB column. If such a column is defined, an auxiliary table needs to be defined to store the data for that column. If the table is also partitioned, there needs to be an auxiliary table for each partition.

Related references

[Db2 Object Functions panel on page 604](#)

[Create Auxiliary Table panel on page 513](#)

Dropping Db2® objects

The available drop functions are shown in [Table 9: Supported actions for each Db2 object on page 203](#).

To drop a Db2® object, perform the following using the Db2® Object Functions panel:

1. Specify the relevant number (1–11) for the Db2® object type you want to drop in the **Object Type** entry field.
2. If you want FM/Db2 to display a Drop Confirmation panel before it actually drops the object you have specified, check the **Confirm object drop** option.
3. Type **D** on the command line.
4. Press Enter. FM/Db2 displays the relevant Drop panel.
5. Specify the name of the Db2® object you want to drop and press Enter.

If you have selected the **Confirm object drop** option, FM/Db2 displays a Drop Confirmation panel. To proceed with the drop, press Enter. To cancel the drop, press the Cancel function key (F12) or the Exit function key (F3).

If you have not selected the **Confirm object drop** option, FM/Db2 drops the specified object.

If the drop operation fails, FM/Db2 displays an error message; press the Help function key (F1) for further information.

Related references

[Db2 Object Functions panel on page 604](#)

[Drop panels on page 621](#)

[Drop Confirmation panel on page 622](#)

Chapter 7. Populating a Db2® table with data

You can populate a table with data by using the FM/Db2 Create utility (3.8). You can specify the number of rows that are to be created and how each row is to be initialized. By editing a template, you can use fill characters and patterns to initialize the data and change the data create attributes for individual columns.

When fill characters and/or patterns are used to initialize a column, the resultant data must conform to any data type restrictions imposed by Db2® for that column.

During the data creation process, FM/Db2 attempts to insert each row formatted by the data create utility into the target Db2® object. The insert operation may be rejected by Db2® if uniqueness, referential integrity, or other constraints would be violated.

The data create operation can be performed in background (batch execution) or in the foreground.

The main panel for the FM/Db2 Create utility is the Data Create Utility panel.

To display the Data Create Utility panel,

1. From the Primary Option Menu panel, enter **3** (Utilities) to display the Utility Functions panel.
2. From the Utility Functions panel, enter **8** (Create)

Now that you have the Data Create Utility panel displayed, you can specify the name of the table you want to populate with data, the number of rows that are to be created, and how each row is to be initialized:

1. Identify the Db2® table you want to populate with data using the **Specify the Db2® Object** entry fields.
2. Use the **Create Count** entry field to specify the number of rows you want to create.
3. If you are using a specific template to specify the data initialization details, (see option 1 in **Template usage**), specify the name of the template data set.
4. Use the **Processing Options** to specify which template you want to use for the create process, and whether you want to edit the template before the create process.
5. Press Enter. If you selected **Edit template**, the Column Selection/Edit panel is displayed. Otherwise, FM/Db2 creates the data in the specified Db2® table.

Related tasks

[Specifying a Db2 object name on page 45](#)

[Specifying a data set and a member name on page 50](#)

[Editing the template on page 240](#)

Related references

[Primary Option Menu panel on page 728](#)

[Utility Functions panel on page 864](#)

[Data Create Utility panel on page 587](#)

Editing the template

If you selected the **Edit template** option on the Create panel, FM/Db2 displays the Column Selection/Edit panel when you press Enter.

To populate the columns for the Db2® table you have specified by editing the template:

1. Enter **E** against the first column in the Column Selection/Edit panel. FM/Db2 displays one of five Column Attributes panels depending on the data type of the column:
 - Alphanumeric (for CHAR, VARCHAR, GRAPHIC, and VARGRAPHIC data types)
 - Numeric (for DECIMAL or NUMERIC, SMALLINT, INTEGER, REAL, and DOUBLE data types)
 - DATE
 - TIME
 - TIMESTAMP
2. Use the Column Attributes panel to specify the *create attributes* for the column. The create attributes determine the value that FM/Db2 puts in the column when it creates data.

For details about how to enter the create attributes, refer to the description for the relevant Column Attributes panel.

3. Press the Exit function key (F3) to return to the Column Selection/Edit panel.
4. Repeat from Step 1 for each of the remaining columns you want to populate.

Related references

[Db2 data types on page 432](#)

[Column Selection/Edit panel on page 485](#)

[Column Attributes panel \(alphanumeric\) on page 473](#)

[Column Attributes panel \(numeric\) on page 478](#)

[Column Attributes panel \(DATE\) on page 477](#)

[Column Attributes panel \(TIME\) on page 482](#)

[Column Attributes panel \(TIMESTAMP\) on page 483](#)

Chapter 8. Copying data

FM/Db2 provides the following utilities that allow you to copy data from one place to another:

Copy Utility (3.3)

Copies data from one Db2® object to another Db2® object (that is accessible from within the same Db2® subsystem).

Import Utility (3.6)

Copies data from a VSAM or QSAM file into a Db2® table or view.

Export Utility (3.7)

Copies data from a Db2® table or view to a VSAM or QSAM file.

Related tasks

[Copying data from one Db2 object to another on page 241](#)

[Copying data from a VSAM or QSAM file on page 246](#)

[Copying data to a VSAM or QSAM file on page 274](#)

[How do I...? on page 287](#)

Copying data from one Db2® object to another

To copy data between Db2® tables, use the Copy utility function (3.3).



Note:

1. To copy data *to* a Db2® table or view from a QSAM or VSAM data set, use the Import utility function (3.6).
2. To copy data *from* a Db2® table or view to a QSAM or VSAM data set, use the Export utility function (3.7).

When you copy data from one Db2® object to another, you can:

- Select which rows to copy
- Reformat data during the copy by mapping columns in the input table to different columns in the output table
- Initialize new columns using user-specified values or patterns
- Limit the number of rows copied

The main panel for the Copy utility is the Copy Utility ("From") panel.

To display the Copy Utility ("From") panel,

1. From the Primary Option Menu panel, enter **3** (Utilities) to display the Utility Functions panel.
2. From the Utility Functions panel, enter **3** (Copy)

You can now specify details about:

- The source table (where the data is that you want to copy). During this step, you can also edit the source template to restrict the data that is copied (if applicable).
- The target table (where you want the data copied). During this step, you can also change the copy options, edit the template mapping for the target table, and specify if you want the copy performed in a batch job.

Related tasks

[Copying data from a VSAM or QSAM file on page 246](#)

[Copying data to a VSAM or QSAM file on page 274](#)

[Specifying details for the "From" table on page 242](#)

[Specifying details for the "To" table on page 244](#)

Related references

[Primary Option Menu panel on page 728](#)

[Utility Functions panel on page 864](#)

[Copy Utility \("From"\) panel on page 498](#)

Specifying details for the "From" table

Specify the name of the source ("*From*") table on the Copy Utility "*From*" panel. If the table you specify does not exist, FM/Db2 issues an error message and stops the utility.

If you do not want to copy all of the rows in the "*From*" table, specify the number of rows you want to copy (1–99999999) in **Copy Count**.

If you are using a specific template for the "*From*" table (see options 1 and 4 in **Template usage**), specify the name of the template data set and, optionally, the member name, in the **From Template** entry fields.

The **Processing Options** specify which template you want to use for the "*From*" table, and whether you want to edit the template before the copy process.

Template usage

The Copy Utility panel provides four options for template usage:

1. Above

Requires that you enter the name of a template data set (and optionally a member name) in the **From Template** section of the panel. If you do not specify a member name, or if you specify a pattern, FM/Db2 displays a member selection list. After you have specified the member containing a template, processing continues using this template in place of the automatically-generated template for the table. (For a detailed explanation, see Template Usage option 3).

2. Previous

Uses the last (previously used) template for this table.

3. Generate from table

Generates a template based on the information in the Db2® catalog for the specified table. This is the default setting. If you have specified a member name in the **Template From** section of the panel, it is ignored. FM/Db2 generates the required template in memory.

4. Generate/Replace

Generates a template based on the information in the Db2® catalog for the specified table, and saves this information in the member specified in the **From Template** section of the panel. If the member already exists, it is replaced. Any prior customization is lost.

You can select the following options by entering a “/” or an “A”:

Edit template

Use to edit the template for the “From” table before proceeding to the Copy Utility “To” panel.

Copy “From” values to “To” panel

Use to copy the values (Db2® object **Location, Owner, Name**, and template **Data set name, Member**) entered on the “From” panel to the corresponding fields on the “To” panel.

To proceed, press Enter.

If you selected **Edit template** (either by using a “/”, or by having previously used the “A” selection character for this option), the Column Selection/Edit panel is displayed. Otherwise, the Copy Utility “To” panel is displayed.

Related tasks

[Specifying a Db2 object name on page 45](#)

[Selecting options on FM/Db2 panels on page 44](#)

[Working with templates on page 72](#)

[Editing the template for the "From" table on page 243](#)

[Specifying details for the "To" table on page 244](#)

Related references

[Copy Utility \("From"\) panel on page 498](#)

[Column Selection/Edit panel on page 485](#)

[Copy Utility \("To"\) panel on page 506](#)

Editing the template for the "From" table

If you select the **Edit template** option on the Copy Utility “From” panel, FM/Db2 displays the Column Selection/Edit panel ([Figure 59: Primary Column Selection/Edit panel on page 244](#)). You can use this panel to restrict the data in the “From” table that you want copied by:

- Selecting (or deselecting) specific columns for copying.
- Specifying *row selection criteria*. Only rows whose contents satisfy the criteria are selected for copying.

For example, the template shown in [Figure 59: Primary Column Selection/Edit panel on page 244](#) has been edited to select certain columns and only rows whose contents meet certain criteria. If you use this template as the "From" template for your Copy, the data copied is restricted to columns where WORKDEPT contains "MNT" and JOB contains "PAINTER".

Figure 59. Primary Column Selection/Edit panel

Process		Options		Utilities		Help			
FM/Db2 (DFG2)				Column Selection/Edit		Line 1 of 16			
TABLE FMNUSER.EMP									
----- Row Selection Criteria ----- (Use SQL/PF4 for full screen edit) -----									
1 Sel: WHERE WORKDEPT = 'MNT' AND JOB = 'PAINTER' +									
Cmd	Seq	SHEX	CL#	Column name	Data type(length)	Null	Default	Order	A/D
				**** Top of data ****					
---	---	S	1	EMPNO	CHARACTER(6)		None	---	---
---	---	S	2	FIRSTNME	VARCHAR(12)		None	---	---
---	---	S	3	MIDINIT	CHARACTER(1)		None	---	---
---	---	S	4	LASTNAME	VARCHAR(15)		None	---	---
---	---	S	5	WORKDEPT	CHARACTER(3)	Y	Null	---	---
---	---	S	6	PHONENO	CHARACTER(4)	Y	Null	---	---
---	---	S	7	HIREDATE	DATE	Y	Null	---	---
---	---	S	8	JOB	CHARACTER(8)	Y	Null	---	---
---	---	S	9	EDLEVEL	SMALLINT	Y	Null	---	---
---	---	S	10	SEX	CHARACTER(1)	Y	Null	---	---
---	---	S	11	BIRTHDATE	DATE	Y	Null	---	---
---	---	S	12	SALARY	DECIMAL(9,2)	Y	Null	---	---
Command ==>				-----				Scroll PAGE	
F1=Help		F2=Split		F3=Exit		F4=SQL		F5=RFind	
F7=Up		F8=Down		F9=Swap		F10=Left		F11=Right	
								F6=RunTemp	
								F12=Cancel	

Related tasks

[Working with templates on page 72](#)

Related references

- [Copy Utility \("From"\) panel on page 498](#)
- [Column Selection/Edit panel on page 485](#)
- [Copy Utility \("To"\) panel on page 506](#)

Specifying details for the "To" table

Specify the name of the target ("To") table on the Copy Utility "To" panel.

If you are using a specific template for the "To" table, specify the name of the template data set and, optionally, the member name, in the **To Template** entry fields.

The **Processing Options** specify which template you want to use for the "To" table, and whether you want to edit the template before the copy process.

Template usage

The Copy Utility panel provides four options for template usage:

1. Above

Requires that you enter the name of a template data set (and optionally a member name) in the **To Template** section of the panel. If you do not specify a member name, or if you

specify a pattern, FM/Db2 displays a member selection list. After you have specified the member containing a template, processing continues using this template in place of the automatically-generated template for the table. (For a detailed explanation, see Template Usage option 3).

2. Previous

Uses the last (previously used) template for this table.

3. Generate from table

Generates a template based on the information in the Db2® catalog for the specified table. This is the default setting. If you have specified a member name in the **To Template** section of the panel, it is ignored. FM/Db2 generates the required template in memory.

4. Generate/Replace

Generates a template based on the information in the Db2® catalog for the specified table, and saves this information in the member specified in the **To Template** section of the panel. If the member already exists, it is replaced. Any prior customization is lost.

You can select the following options by entering a “/” or an “A”:

Edit copy options

Use to edit the Copy options before copying the data.

Edit template mapping

Use to edit the template mapping for the “To” table before copying the data.

Batch execution

Builds the necessary JCL to perform the Copy utility in a batch job.

To proceed, press Enter.

If you selected **Edit Copy options** (either by using a “/”, or by having previously used the “A” selection character for this option), the Copy Options panel is displayed for editing.

If you selected **Edit template mapping** (either by using a “/”, or by having previously used the “A” selection character for this option), the Template Mapping panel is displayed for editing.

If you selected **Batch execution** (either by using a “/”, or by having previously used the “A” selection character for this option), the generated JCL is displayed using the ISPF editor, where you can review the JCL and submit the job for batch processing.

Otherwise (if you selected none of the preceding options), FM/Db2 copies the data from the “From” table to the “To” table.

Setting options for the current Copy session

If you select **Edit copy options** on the Copy “To” panel FM/Db2 displays the Copy Options panel.

You can use this panel to change the options for the current Copy session.



Note: Any options you set on this panel apply for the current Copy session only. When you exit from the Copy session, the copy options revert to the global copy options.

Related references

[Copy Options panel on page 495](#)

Running Copy in batch

If you want to copy large Db2® tables, you can perform the copy in a batch job.

If you select the **Batch execution** option on the Copy Utility "From" panel, the Copy utility builds the necessary JCL to perform the copy function in a batch job. The generated JCL is displayed using the ISPF editor, where you can review the JCL and submit the job for batch processing.

Related tasks

[Specifying a Db2 object name on page 45](#)

[Selecting options on FM/Db2 panels on page 44](#)

[Setting options for the current Copy session on page 245](#)

[Mapping data on page 109](#)

[Running Copy in batch on page 246](#)

Related references

[Copy Utility \("To"\) panel on page 506](#)

[Copy Utility \("From"\) panel on page 498](#)

[Copy Options panel on page 495](#)

[Copy utility options \(option 3.3\) on page 66](#)

Copying data from a VSAM or QSAM file

To copy data to a Db2® table or view from a QSAM or VSAM data set, use the Import utility function (3.6).



Note:

1. To copy data between Db2® tables, use the Copy utility function (3.3).
2. To copy data *from* a Db2® table or view to a QSAM or VSAM data set, use the Export utility function (3.7).

The input to the Import utility function can be a QSAM or VSAM data set produced by:

- The FM/Db2 Export utility
- Any external source

You must specify a copybook or template that describes the record format of the data in the input QSAM or VSAM data set. If you specify a copybook, FM/Db2 compiles it to produce a template.

When you copy data to a Db2® table or view from a QSAM or VSAM data set, you can:

- Reformat data during import by mapping Db2® table columns to fields in the input QSAM or VSAM data set (as defined by a copybook or template).
- Use a REXX procedure to enhance the way in which data is selected and imported.
- Specify the number of rows to be imported, and the starting record in the import file.
- Specify whether you want to run the import in foreground or batch.
- Specify that any duplicate rows are to be updated with the values in the imported row.
- Specify how often FM/Db2 should commit changes to Db2® during the import process.

The main panel for the Import utility is the Import Utility ("From") panel.

To display the Copy Utility ("From") panel,

1. From the Primary Option Menu panel, enter 3 (Utilities) to display the Utility Functions panel.
2. From the Utility Functions panel, enter 6 (Import)

You can now specify details about:

- The source QSAM or VSAM data set (where the data is that you want to copy). During this step, you can also edit the source template to restrict the data that is copied (if applicable).
- The target table (where you want the data copied). During this step, you can also:
 - Edit the template mapping for the target table
 - Specify if you want the copy performed in a batch job
 - Optionally specify the name of a REXX procedure to further enhance the way data is selected

When (and when not) to use the Import utility

The Import utility provides one method for moving Db2® data between different Db2® subsystems (that is, export on one subsystem followed by import on another). If you want to move data between tables in the same Db2® sub-system, either the Copy utility or direct execution of SQL statements is typically more convenient.

In general terms, the Import utility is suitable for inserting small to medium volumes of data into Db2® tables. Import operations are achieved by inserting each selected record in the import data set into the target table, and any update operations are achieved by generating an update statement.

All insert and update operations are logged by Db2®, which can have operational and performance implications. The Import utility is not intended as a substitute for the Db2® utilities if unloading or migrating large volumes of data, and the Db2® utilities offer superior performance in these situations. Whenever possible, run import operations in batch.

The import utility provides for automatic mapping of the Db2® null indicator, and, optionally, one of the following formats can be specified corresponding to the template used:

FM/Db2 (SQLDA) format
Db2@ unload format
DSNTIAUL format
User defined format (excluding Placement, User defined)

However, the template editor does not show the null indicator as a separate item in the "From" template on the Field Mapping panel. It is therefore not possible to re-map the null indicator associated with nullable columns to a column in the target table.

Related tasks

[Compiler language selection \(option 0.4\) on page 63](#)
[Specifying details for the "From" data set on page 248](#)
[Specifying details for the "To" table on page 250](#)
[Using a REXX procedure with the Import utility on page 252](#)

Related references

[Primary Option Menu panel on page 728](#)
[Utility Functions panel on page 864](#)
[Import Utility \("From"\) panel on page 693](#)
[Import Utility \("To"\) panel on page 694](#)

Specifying details for the "From" data set

Specify the name of the source (*"From"*) data set on the Import Utility *"From"* panel. Use a combination of the **Data set name**, **Member**, and **Volume** entry fields to specify the sequential data set, VSAM data set, or PDS member from which you want to import the data.

If you do not want to import all of the records from the input data set, specify the number of records you want to import (1–99999999) in **Import Count**.

If you are using a specific template for the *"From"* data set (see option 1 in **Template usage**), specify the name of the template data set and, optionally, the member name, in the **From Copybook or Template** entry fields.

The **Processing Options** on the Import Utility *"From"* panel specify template usage, and whether you want to edit the template before the import process.

Template usage

The Import Utility *"From"* panel provides two options for template processing:

1. Above

Requires that you enter the name of a copybook or template in the **From Copybook or Template** section of the panel. After you have specified a name of a copybook or template, processing

continues using this template in place of the previously used template (see Template usage option 2).

2. Previous

Uses the last (previously used) template for this data set.

You can select the following option by entering a “/” or an “A”:

Edit template

Use to edit the template for the “From” data set before proceeding to the Import Utility “To” panel.

To proceed, press Enter.

If you selected **Edit template** (either by using a “/”, or by having previously used the “A” selection character for this option), the Field Selection/Edit panel is displayed.

Otherwise, the Import Utility “To” panel is displayed.

Related tasks

- [Specifying a data set and a member name on page 50](#)
- [Selecting options on FM/Db2 panels on page 44](#)
- [Working with templates on page 72](#)
- [Editing the template for the "From" data set on page 249](#)
- [Specifying details for the "To" table on page 250](#)

Related references

- [Import Utility \("From"\) panel on page 693](#)
- [Import Utility \("To"\) panel on page 694](#)

Editing the template for the "From" data set

If you select the **Edit template** option on the Import Utility “From” panel, FM/Db2 displays the Field Selection/Edit panel (see [Figure 60: Import Utility: Field Selection/Edit panel for the “From” data set on page 250](#)).

You can narrow down which records you want to process by specifying *record selection criteria*. Only records whose contents satisfy the criteria are selected. You specify record selection criteria using REXX comparison expressions.



Note: Record selection criteria is applied on the input data *before* any field mapping or data conversion is performed, whereas the REXX import procedure applies *after* any field mapping or data conversion is performed.

For example, the template shown in [Figure 60: Import Utility: Field Selection/Edit panel for the “From” data set on page 250](#) has been edited to select only records that meet certain criteria. If you use this template as the “From” template for your Import utility, the data imported is restricted to records where SALARY contains a value greater than 50 000.

Figure 60. Import Utility: Field Selection/Edit panel for the "From" data set

```

Process  Options  Help
-----
File Manager          Field Selection/Edit          Line 1 of 10
-----
----- Criteria - Enter 1 or 2 to specify expression by field -----
1 Id : _____ +
2 Sel: #6 > 50000 _____ +
Offset _____ 5
Cmd Seq SHE Ref Field Name          Picture  Type Start Length
-----
      S   1 1 REC-TYPE01          ***** Top of data *****
      S   2 2 REC-TYPE          XX          AN      6      2
      S   3 2 NAME          X(20)       AN      8     20
      S   4 2 EMPLOYEE-NO      9(4)       BI     28      2
      S   5 2 AGE          9(4)       BI     30      2
      S   6 2 SALARY          9(7)       PD     32      4
      S   7 2 MONTH OCCURS 12 TIMES 9(8)       BI     36      4
      S   8 2 FILLER          XX          AN     84      2
      ***** End of data *****

Command ==> _____ Scroll HALF
F1=Help      F2=Split    F3=Exit     F4=Expand   F5=RFind    F6=RunTemp
F7=Up        F8=Down    F9=Swap     F10=Left   F11=Right   F12=Cancel
    
```

If you press Enter, FM/Db2 saves the updated template and returns you to the Import Utility "From" panel.



Note: For more information about specifying record selection criteria, see the File Manager User's Guide and Reference.

Related tasks

[General information about REXX on page 253](#)

Related references

[Import Utility \("From"\) panel on page 693](#)

[Field Selection/Edit panel on page 679](#)

Specifying details for the "To" table

Specify the name of the table to which the input data is to be imported on the Import Utility "To" panel. If the table you specify does not exist, FM/Db2 issues an error message.

If you are using a specific template for the "To" table (see options 1 and 4 in **Template usage**), specify the name of the template in the **To Template** entry fields.

To delete all the rows in the target table before importing the data from the QSAM or VSAM data set, select the **Delete existing rows** option.

Set the **Duplicate row options** according to how you want FM/Db2 to handle any instances where the data to be imported is a "duplicate" of an existing row. That is, where the only changes to the data are in columns that are not part of any unique index key:

- To ignore duplicate rows, select **1. Ignore**.

Any duplicates that FM/Db2 detects are not updated and FM/Db2 ignores the value (if any) in the **For ... duplicates** field.

- To update duplicate rows, select **2. Update**.

FM/Db2 updates any duplicate rows. If the number of duplicates exceeds the value specified in the **For ... duplicates** field, FM/Db2 terminates the import operation and all changes are rolled back.

To proceed, press Enter.

If you selected **Edit template mapping** (either by using a “/”, or by having previously used the “A” selection character for this option), then, before FM/Db2 imports the data, the Template Mapping panel is displayed for editing.

If you selected **Batch execution** (either by using a “/”, or by having previously used the “A” selection character for this option), the generated JCL is displayed using the ISPF editor, where you can review the JCL and submit the job for batch processing.

Otherwise, FM/Db2 imports the data from the “From” data set to the “To” Db2® table.

Related tasks

[Specifying a Db2 object name on page 45](#)

[Specifying a data set and a member name on page 50](#)

[Mapping data on page 109](#)

[Running Import in batch on page 251](#)

Related references

[Import Utility \(“To”\) panel on page 694](#)

[Template Mapping panel on page 850](#)

Running Import in batch

If you want to import large Db2® tables, you can perform the import in a batch job.

If you select the **Batch execution** option on the Import Utility “To” panel, the Import utility builds the necessary JCL to perform the import function in a batch job. The generated JCL is displayed using the ISPF editor, where you can review the JCL and submit the job for batch processing.

If you have one or more data sets that contain the template that describes the record structure of your input data, you can specify the data set details (or TSO ALLOC statement) in the generated JCL with the keywords TINPUT or TCIN.

Similarly, if you have one or more data sets that contain the template that describes the record structure of your output data, you can specify the data set details (or TSO ALLOC statement) in the generated JCL with the keywords TOUTPUT or TCOUT.

Related references

[DBI \(Import\) batch command on page 970](#)

[Import Utility \("To"\) panel on page 694](#)

Using a REXX procedure with the Import utility

You can specify an existing REXX procedure, or create a new one, to further enhance the way in which data is selected and imported.

You can code any number of REXX statements and functions to manipulate the output record, select specific records, print reports and tally numeric values. If you are coding a REXX procedure, be aware that:

- The import procedure is run after input template record selection is performed. The import procedure can cause a record (which would have been selected by the template selection process, if there was one) to be deselected for copying using RETURN DROP.
- The import procedure is run after any field mapping or conversion supplied by a template has been performed.
- If the record has been reformatted as a result of the template processing, the variable INREC contains the input record value and the variable OUTREC contains the reformatted output record.
- Changes made by the import procedure to INREC are ignored. Changes made to OUTREC are used in the import process to load the Db2® table.
- If using the PRINT() function, the template is determined as follows:
 - If an input template without an output template has been specified, the input template is used.
 - If an output template is specified, and the record value specified to print is the input record, the input template is used. Otherwise the output template is used.
 - If a record cannot be matched against the selected printing template, it is not printed.

Example 1

Import records, inserting a new field after column 40 for a length of 4.

```
outrec = fld(1,40)||'    '||fld(41)
```

Example 2

Import records with type A and print the first 10. The type value is in column 6.

```
if fld(6,1) = 'A' then do                /* Type A? */
  If prtcount() <= 10 then print(inrec,'CHAR') /* Print 10 */
  RETURN                                  /* Copy    */
end
return 'DROP'                            /* Drop the rest */
```

Example 3

Change the output records to uppercase while importing.

```
upper outrec
```

Related tasks

[Specifying details for the "To" table on page 250](#)

[Enhancing the Import utility using a REXX procedure on page 263](#)

General information about REXX

REXX stands for the REstructured eXtended eXecutor language. REXX is a general purpose programming language, similar to PL/I. It includes extensive parsing capabilities for character manipulation, extensive mathematical capabilities, and numerous built-in functions that perform various processing, searching, and comparison functions.

REXX programs are typically run by a language processor (interpreter). That is, the program is run statement-by-statement, without first being converted to another form (compiled). Because of the interpretive nature of REXX, FM/Db2 is able to exploit the power of REXX when processing record selection criteria.

Although REXX is a powerful and versatile language, coding selection criteria using REXX is straightforward. You do not need to know how to write REXX programs. All you need to know is how to write REXX comparison expressions. FM/Db2 takes care of turning your selection criteria into a REXX program.

Much of the information in this section has been extracted from the *OS/390® TSO/E REXX Reference* and *OS/390® TSO/E REXX User's Guide*. For more detailed information about REXX, see those manuals.

Overview of REXX expressions

REXX expressions consist of one or more *terms* interspersed with zero or more *operators* that denote operations to be carried out on terms. Expressions are evaluated left to right, modified by parentheses and by operator precedence in the typical algebraic manner. If parentheses are encountered (other than those that identify function calls) the entire subexpression between the parentheses is evaluated immediately when the term is required. Expressions are wholly evaluated, unless an error occurs during evaluation. The REXX language uses a free format. This means you can insert extra spaces between words without causing an error.

The following list shows the terms you can use in a selection criteria expression. The operators you can use are described on the pages that follow.

Literal strings

A literal string is a sequence including any characters and delimited by the single quotation mark (') or the double quotation mark ("). Use two consecutive double quotation marks (") to represent a " character within a string delimited by double quotation marks. Use two consecutive single quotation marks (') to represent a ' character within a string delimited by single quotation marks. A literal string is a constant and its contents are never modified when it is processed.

These are valid strings:

```
'Fred'
"Don't Panic!"
'You shouldn't'      /* Same as "You shouldn't" */
```

Note that a string followed immediately by a `()` is considered to be the name of a function. If followed immediately by the symbol `x` or `X` it is considered to be a hexadecimal string. If followed immediately by the symbol `B` or `b` it is considered to be a binary string.

A hexadecimal string is a literal string, expressed using a hexadecimal notation of its encoding. It is any sequence of zero or more hexadecimal digits (0-9, a-f, A-F), grouped in pairs. A single leading 0 is assumed, if necessary, at the front of the string to make an even number of hexadecimal digits. The groups of digits are optionally separated by one or more blanks, and the whole sequence is delimited by single or double quotation marks, and immediately followed by the symbol `X` or `x`. (Neither `x` nor `X` can be part of a longer symbol.) A hexadecimal string is a literal string formed by packing the hexadecimal digits given. Packing the hexadecimal digits removes blanks and converts each pair of hexadecimal digits into its equivalent character, for example:

```
'C1'X A.
```

You can use hexadecimal strings to include characters in a program even if you cannot directly enter the characters themselves. These are valid hexadecimal strings:

```
'ABCD'x
"1d ec f8"X
"1 d8"x
```

A binary string is a literal string, expressed using a binary representation of its encoding. It is any sequence of zero or more binary digits (0 or 1) in groups of 8 (bytes) or 4 (nibbles). The first group can have fewer than four digits; in this case, up to three 0 digits are assumed to the left of the first digit, making a total of four digits. The groups of digits are optionally separated by one or more blanks, and the whole sequence is delimited by matching single or double quotation marks and immediately followed by the symbol `b` or `B`.

A binary string is a literal string formed by packing the binary digits given. If the number of binary digits is not a multiple of eight, leading zeros are added on the left to make a multiple of eight before packing. You can use binary strings to specify characters explicitly, bit by bit.

These are valid binary strings:

```
'11110000'b      /* == 'f0'x          */
"101 1101"b     /* == '5d'x          */
'1'b            /* == '00000001'b and '01'x */
'10000 10101010'b /* == '0001 0000 1010 1010'b */
'b             /* == ''            */
```

Symbols

Character strings, without quotation marks, which are converted to uppercase. Any symbol that begins with a `#` is treated as a reference to a field in the record being processed, and the value of the field is used. All other symbols are treated as constants.

FM/Db2 assigns to each field defined in a template a unique field reference number. If you want to refer to a field in a selection criteria expression, you specify the field's field reference number prefixed by `#`. Note that you can only refer to fields defined in the record you are currently working with.

REXX expression evaluation only processes data in the form of “*typeless*” character strings (typeless because they are not, as in the case of COBOL, of a particular data type such as binary, packed-decimal, and so forth). Therefore, if you refer to a numeric field, FM/Db2 converts the value of the field to a numeric character string that can be processed by REXX when evaluating the selection criteria expression. The number of integer and decimal digits in the character string is determined by the field definition in your template. For example, if you refer to a packed-decimal field with a COBOL PICTURE clause of 999V99, FM/Db2 converts the value of the field to a character string consisting of numeric digits, a period for the virtual decimal place, and, if the value of the field is negative, a leading sign character (such as -123.45). Note that all numeric fields are treated as signed, regardless of whether the COBOL PICTURE clause contains a sign symbol.

Occasionally, you might want to evaluate the value of a numeric field without converting it to a numeric character string. To do this, prefix the field reference number by #u instead of #. This tells FM/Db2 not to convert the number to a numeric character string. For example, if to test a 2-byte binary numeric field (with a field reference number of 45) for a special value of X'FFFF', code:

```
#u45 = 'FFFF'x
```

If you refer to a field in an array, you must qualify the field reference with the required number of subscripts enclosed in parentheses and separated by commas. The number of subscripts you specify must equal the number of dimensions in the array that contains the field you are referencing. In COBOL terms, there must be a subscript for each OCCURS clause in the hierarchy containing the field, including any OCCURS clause for the field itself. Each subscript you specify must be a positive integer in the range 1 to the maximum number of occurrences of the field as specified in the OCCURS clauses. If the field you refer to is in a variable-length array (specified using the OCCURS DEPENDING ON clause), ensure that you do not refer to an occurrence of the field that, for any given record, might not exist. If you do refer to a non-existent field, the selection criteria is not satisfied, and the record is not selected.



Note: The object of an OCCURS DEPENDING ON clause must be defined as a field in the static portion of the same record as the array (that is, the portion of the record that precedes any variable-length array defined with the OCCURS DEPENDING ON clause). If the object of the OCCURS DEPENDING ON clause is not defined in this way, you cannot refer to any fields in the array or any fields in the record that follow the array.

Function call

A call to REXX built-in function.

Subexpressions

Terms in an expression bracketed within left and right parentheses.

Comparison operators

REXX comparison operators compare two terms and return the value 1 if the result of the comparison is true, or 0 otherwise. Comparison operators can compare numbers or character strings. The most commonly used comparison operators are:

Operator

Meaning

=

Equal

≠, \=

Not equal

<

Less than

≧, \<

Not less than

>

Greater than

≧, \>

Not greater than

≤

Less than or equal to

≥

Greater than or equal to

≠

Greater than or less than (same as not equal)

≠

Less than or greater than (same as not equal)

Note that the `not` character (`≠`), is synonymous with the backslash (`\`). You can use the two characters interchangeably.

When comparing terms using these comparison operators, if both terms in the expression are numeric, REXX performs a numeric comparison. Otherwise, both terms are treated as character strings and REXX performs character comparison. (A number in REXX is a string that contains one or more decimal digits, an optional decimal point, and an optional leading sign character. The string can contain one or more leading or trailing blanks, and the sign character can be separated from the digits by one or more blanks.)

In a character comparison, leading and trailing blanks are ignored, and the shorter string is padded with blanks on the right. Character comparisons are case-sensitive. To prevent lowercase characters being converted to uppercase, delimit character strings with quotation marks. For example, if the field `#4` contains the value `MixedCase` both the following comparison operations would be true:

```
#4 = 'MixedCase'
#4 = '   MixedCase   '
```

but the following comparison operation would not be true:

```
#4 = MixedCase
```

In numeric comparisons, the comparison is effected by subtracting the two numbers (calculating the difference) and then comparing the result with 0. For example, the comparison operation:

```
#6 = 10
```

is identical to the operation:

```
(#6 - 10) = 0
```

In addition to these comparison operators, REXX provides a number of “*strict*” comparison operators that are mainly intended for use if comparing character strings. The strict comparison operators all have one of the characters defining the operator doubled, such as `==` (strictly equal).

The strict comparison operators are:

Operator

Meaning

`==`

Strictly equal

`-==, \==`

Strictly not equal

`<<`

Strictly less than

`-<<, \<<`

Strictly not less than

`>>`

Strictly greater than

`->>, \>>`

Strictly not greater than

`<<=`

Strictly less than or equal to

`>>=`

Strictly greater than or equal to

If you use the `==` comparison operator (strictly equal), the two character strings being compared must be identical (character by character) and of the same length to be considered strictly equal. Leading and trailing blanks are significant. For example, continuing the example using field #4 that contains the value `MixedCase` only the first of the following comparison operations would be true:

```
#4 == 'MixedCase'
#4 == '    MixedCase    '
```

Similarly, the strict comparison operators such as `>>` or `<<` carry out a simple character-by-character comparison, with no padding of either of the strings being compared. The comparison of the two strings is from left to right. If one string is shorter than and is a leading substring of another, then it is smaller than (less than) the other. The strict comparison operators do not attempt to perform a numeric comparison on the two terms. Do not use them to compare numeric fields.

Arithmetic operators

You can process numeric terms in comparison expressions using the arithmetic operators:

Operator

Meaning

+

Add

-

Minus

Multiply

/

Divide

%

Integer divide (divide and return the integer part of the result)

//

Remainder (divide and return the remainder—not modulo, because the result might be negative)

Power[®] (raise a number to a whole-number power)

Prefix -

Same as the subtraction: `0 - number`

Prefix +

Same as the addition: `0 + number`

You can use these operators to produce an intermediate result that you can compare with another term. For example, given these fields:

#6

Contains a numeric value representing an employee's annual salary.

#15

Contains a numeric value representing his annual travel allowance.

#23

Contains a numeric value representing his annual bonus.

you can use this comparison to select records for employees with a combined annual payment of greater than \$100,000:

```
(#6 + #15 + #23) > 100000
```

For another example, with these fields:

#45

Contains the number of sick days an employee is entitled to annually.

#46

Contains the number of sick days an employee has used in the current year.

you can use this comparison to select records for employees who have used 50% or more of their sick days entitlement:

```
(#46 / #45) >= .5
```

Note that in each of these examples, the arithmetic subexpression is contained in parentheses. This ensures that the entire subexpression is evaluated before the comparison operation.

The order of precedence of arithmetic operators is as follows (highest is at the top):

Operator**Meaning**

+ - * \

Prefix operators

**

Power[®]

* /

Multiply and divide

+ -

Add and subtract

For example, * (multiply) has a higher priority than + (add), therefore `3+2*5` evaluates as `13` (rather than the `25` that would result if strict left to right evaluation occurred). To force the addition to occur before the multiplication, rewrite the expression as `(3+2)*5`. Adding the parentheses makes the first three tokens a subexpression.

Logical (boolean) operators

REXX comparison expressions return a true (1) or false (0) value when processed. Logical operators combine two comparisons and return the true (1) or false (0) value depending on the results of the comparisons.

The logical operators are:

Operator

Meaning

&

AND

Returns 1 if both comparisons are true. For example:

```
(4 > 2) & (a = a)      /* true, therefore result is 1 */
(2 > 4) & (a = a)      /* false, therefore result is 0 */
```

|

Inclusive OR

Returns 1 if at least one comparison is true. For example:

```
(4 > 2) | (5 = 3) /* at least one is true, therefore result is 1 */
(2 > 4) | (5 = 3) /* neither one is true, therefore result is 0 */
```

&&

Exclusive OR

Returns 1 if only one comparison (but not both) is true. For example:

```
(4 > 2) && (5 = 3) /* only one is true, therefore result is 1 */
(4 > 2) && (5 = 5) /* both are true, therefore result is 0 */
(2 > 4) && (5 = 3) /* neither one is true, therefore result is 0 */
```

Prefix ~ \

Logical NOT

Returns the opposite response. For example:

```
\ 0          /* opposite of 0, therefore result is 1 */
\ (4 > 2)     /* opposite of true, therefore result is 0 */
```

Logical expressions are used in complex comparisons and can act as checkpoints to stop unwanted conditions (such as testing a field for a value of zero before using it as a divisor). If you have a series of logical expressions, for clarification, use one or more sets of parentheses to enclose each expression. For example:

```
(#46 = 999) | ((#45 > 0) & (#46 / #45) >= .5)
```

Useful functions

REXX provides a rich set of built-in functions, including character manipulation and conversion functions. Some of these functions might be of use when you are writing your comparison expressions. To call a function, type the function name directly followed by one or more arguments within parentheses. There can be no space between the function name and the left parenthesis. For example:

```
function(arguments)
```

A function call can contain up to 20 arguments separated by commas. Each argument can be:

Argument

Example

Blank

function()

Constant

function(55)

Symbol

function(#5)

Literal string

function('With a literal string')

Option recognized by function

function(option)

Another function

function(function(arguments))

Combination of argument types

function('Literal string', #5, option)

Some of the built-in functions provided by REXX that you might find useful are:

ABS()

Figure 61.

►► **ABS** — (*number*) —◄◄

Returns the absolute value of a *number*. For example, to select records in which field #12 contains a value in the range -10 to +10, specify:

```
ABS(#12) <= 10
```

MAX()

Figure 62.

►► **MAX** — (— *number* —) —◄◄

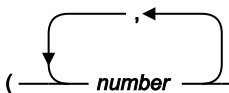

Returns the largest number from the list specified. For example, to select records in which any of fields #10, #11, or #12 contains a value greater than 55, specify:

```
MAX(#10, #11, #12) > 55
```

MIN()

Figure 63.

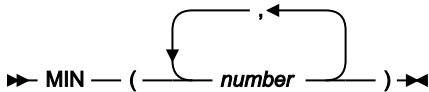

Returns the smallest number from the list specified. For example, to select records in which any of fields #10, #11, or #12 contains a value less than 0, specify:

```
MIN(#10, #11, #12) < 0
```

POS()

Figure 64.

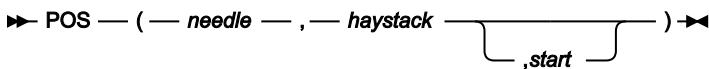

Returns the position of one string, *needle*, in another, *haystack*. Returns 0 if *needle* is a null string, or is not found in *haystack*, or if *start* is greater than the length of *haystack*. By default, the search starts at the first byte of *haystack* (that is, the value of *start* is 1). You can override this by specifying *start* (which must be a positive whole number), the point at which the search starts. For example, to select records in which any character in field #22 is a blank, specify: `POS(' ', #22) > 0`

SUBSTR()

Figure 65.

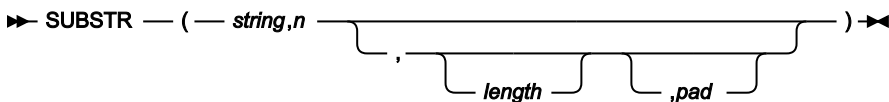

Returns the substring of *string* that begins at the *n*th byte and is of length *length* bytes, padded with *pad* if necessary. *n* is a positive whole number. If *n* is greater than the length of *string* (in bytes), only pad characters are returned.

If you omit *length*, the rest of the string is returned. The default *pad* character is a blank.

For example, to select records in which bytes 4-6 of field #22 are the string 'NOT', specify:

```
SUBSTR(#22, 4, 3) = 'NOT'
```

Performance tips

Do not use EXITs in REXX

Use RETURN to terminate all your REXX processing. Do not use EXIT statements. EXIT statements in REXX used with FM/Db2 cause excessive CPU usage.

Examples

The following are examples of REXX comparison expressions:

Example 1

Select records in which the transaction date (field #14) is any date in July 2000, or the transaction value (field #27) is greater than \$100,000.00

```
(#14 >= 20000701 & #14 < 20000801) | #27 > 100000.00
```

Example 2

Select records in which the count of credit notes (field #62) is greater than 10% of the count of invoices (field #61)

```
#62 > #61/10
```

Example 3

Select records in which either the transaction value (field #27) is greater than \$50,000.00 and the purchase order number (field #25) starts with characters other than 'TX', or the transaction value is greater than \$70,000 and the supplier number (field #23) is 984545, but not if both sets of conditions are true

```
(#27 > 50000.00 & SUBSTR(#25,1,2) ~= 'TX') &&  
(#27 > 70000.00 & #23 = 984545)
```

Enhancing the Import utility using a REXX procedure

When you use the Import utility, you can supply a REXX procedure to enhance typical import FM/Db2 processing according to your own custom requirements.

Supplying a REXX procedure when using the Import utility

You use the **Use REXX proc** field on the Import "From" panel to supply the REXX procedure:

```
/ Use REXX proc member
```

If you enter an * (asterisk) as the *member* name, FM/Db2 displays an edit panel where you can enter a temporary procedure for one time use. Use this method only for short, ad hoc procedures that you do not want to keep for future use.

Alternatively, you can allocate an FMNEXEC DD that identifies a PDS where your saved REXX procedures reside. If you specify a member name, File Manager either edits a new member or runs with an existing member. Specifying blank or a pattern other than * displays a member selection list of the PDS allocated to FMNEXEC. Concatenated FMNEXEC data sets are not supported under ISPF.

For example, if you store your REXX procedures in a PDS called 'USERID.FMNEXEC' then, before using the **Use REXX proc** field, you must issue a TSO ALLOC command similar to this:

```
TSO ALLOC DD(FMNEXEC) DSN('USERID.FMNEXEC') SHR
```

In each case, FM/Db2 validates the REXX procedure that you supply. If errors are detected, FM/Db2 shows all detected errors in a message box and opens the procedure in an edit panel which you can use to correct it. Canceling the Edit session clears the **Use REXX proc** field and redisplay the entry panel.

How enhanced processing works

The REXX procedure that you supply is run against each input record in sequence, either until the end of the input data set is reached, or until the REXX procedure issues a RETURN STOP (or RETURN STOP IMMEDIATE) command.

FM/Db2 defines two special REXX variables, INREC and OUTREC, that you can use in the REXX procedure that you supply to perform enhanced processing. When the FM/Db2 function or panel calls the REXX procedure, the contents of each input record selected for processing are passed to the procedure in both INREC and OUTREC. When the procedure is called, the contents of INREC and OUTREC are identical.

The variable INREC is intended to be used as a reference variable (FM/Db2 ignores any changes to INREC). The variable OUTREC can be updated by the procedure, and (unless you “drop” the record from further processing, as described later in this section) when the REXX procedure has completed, is passed back for processing by the Import utility. For example, the following code changes a two-digit year in the output record to a four-digit year:

```
/* Changes a date of format MMDDYY (starting at column 1) to MMDDYYYY */
If fld(5,2,z) > 50
  outrec = fld(1,4) || '19' || fld(5)
else
  outrec = fld(1,4) || '20' || fld(5)
```

Using templates with enhanced processing

Only those records that the template selects are passed to the REXX procedure for further processing.

Regardless of whether or not the template you are using selects only certain fields, the INREC and OUTREC variables contain complete records with all fields.

Related tasks

[Working with templates on page 72](#)

Dropping a record from further processing

If the REXX procedure exits normally after processing a record, that record is considered to be “selected”, and the contents of OUTREC are used as the output record for importing. However, if the REXX procedure ends with a RETURN DROP (or RETURN STOP IMMEDIATE) instruction, the current record is “dropped” from further processing by FM/Db2, and is not imported.

External REXX functions

FM/Db2 provides the following external REXX functions that you can use in addition to the built-in REXX functions described in the *OS/390® TSO/E REXX Reference*.

CHANGE

Change a character string

CONTAINS

Check for character values

FLD

Refer to a field from the current input record

NCONTAIN

Check for numeric values

PRINT

Print a record

PRTCOUNT

Count of records printed

RECSIN

Count of records read

RECSOUT

Count of records written to a given data set

TALLY

Total a field value and report the total

TM

Test a string for a bit value

WRITE

Write a record



Note: You can only use these FM/Db2-specific REXX external functions, and the INREC and OUTREC variables, in a REXX procedure specified by the **Use REXX proc** field). You cannot use these functions and variables in REXX procedures outside of this FM/Db2 environment.

CHANGE

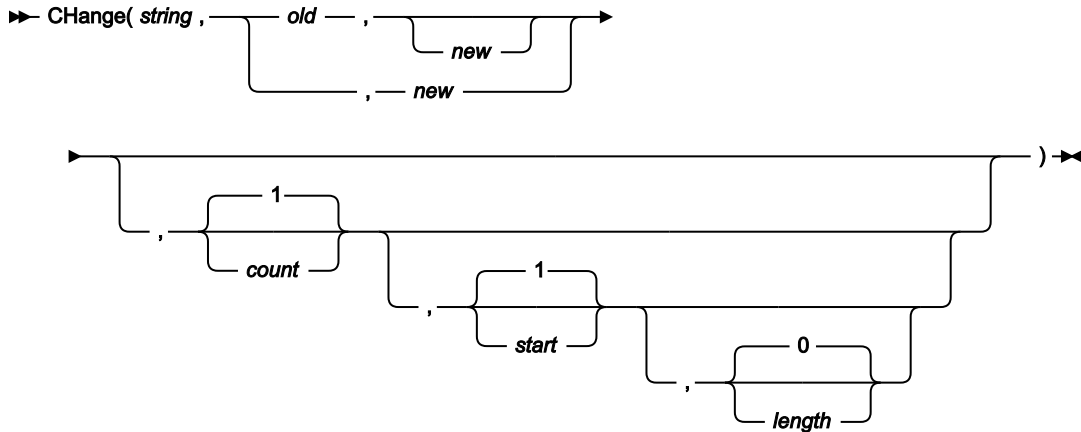

Returns *string*, with up to *count* occurrences of the substring *old* changed to the substring *new*. The default value for *count* is 1. If you specify *count*, it must be zero or a positive whole number. If you specify zero, all occurrences of *old* in *string* are changed to *new*.

You can restrict the byte positions within *string* that are examined for substring *old* by specifying a starting byte position (*start*) and a length in bytes (*length*). The default value for *start* is 1. If you specify *start*, it must be a positive whole number. If *start* is greater than `LENGTH(string)`, the CHANGE function has no effect. If you specify *length*, it must be zero or a positive whole number. If you omit *length*, or specify zero, the remainder of *string* from byte position *start* is examined. If *length* is less than `LENGTH(old)`, the CHANGE function has no effect.

The lengths of substrings *old* and *new* can be different. If you omit *old*, the substring *new* is inserted in *string* at the byte position indicated by *start*. If you omit *new*, the substring *old* is deleted from *string*.

Here are some examples:

Example 1

```
CHANGE('abcabcabc','abc','DeF')    →  'DeFabcabc'
/* 1 (default) occurrence of old changed */
```

Example 2

```
CH('abcabcabc','abc','DeF',2)     →  'DeFDeFabc'
/* 2 occurrences of old changed */
```

Example 3

```
CHANGE('abcabcabc','abc','DeF',0)  →  'DeFDeFDeF'
/* count = 0, all occurrences of old changed */
```

Example 4

```
CH('abcabcabc','abc','DeF',,4)    →  'abcDeFabc'
/* 1 (default) occurrences of old changed,      */
/* starting at position 4                       */
```

Example 5

```
CHANGE('aaaaaaaa','a',A',0,3,2)    →  'aaAAaaaa'
/* all occurrences of old changed, starting at   */
/* position 3 for a length of 2                 */
```

Example 6

```
CH('abcabcabc','a',,0)             →  'bcabc'
/* new omitted, count = 0,                   */
/* all occurrences of old deleted             */
```

Example 7

```
CHANGE('abc',,'def',,2)             →  'aefbc'
/* old omitted, new inserted, starting at       */
/* position 2                                   */
```

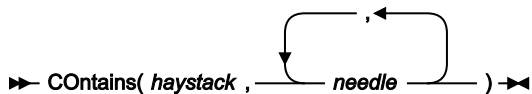
CONTAINS

If the *haystack* string contains one or more of the *needle* strings, CONTAINS returns 1. Otherwise, CONTAINS returns 0.

CONTAINS is case-sensitive: it only returns 1 if the *haystack* contains a string with the same mix of uppercase and lowercase as a *needle*.

Example 1

If the current input record contains “Michael”, “Mick” or “Mike” in the first ten columns, print the record.

```
If co(fld(1,10),'Michael','Mick','Mike') Then print(inrec, 'CHAR')
```

Example 2

If the current input record contains “USA”, “Australia” or “England”, drop the record from processing.

```
If contains(inrec,'USA','Australia','England') Then exit 'DROP'
```

Related tasks

[NCONTAIN on page 269](#)

FLD

► FLD(*start_column* _____) ◄

└───┬───┘ └───┬───┘

,length *,type*

Returns the value of a field from the current input record (INREC), starting at *start_column* (in bytes), of *length* number of bytes, interpreted according to the specified *type*:

B

if the field is binary. If you specify B for *type*, *length* must be 2, 4, or 8.

C

if the field contains characters.

P

if the field is packed decimal. If you specify P for *type*, *length* must be between 1 and 16.

Z

if the field is zoned decimal. If you specify Z for *type*, *length* must be between 1 and 32 or, if the field contains a separate sign character, between 1 and 33.

The default value for *type* is C.

If you omit *length* and specify *type* P (packed decimal), FLD attempts to determine the packed field length from the record data, and returns only that field. If you omit *length* for other field types, FLD returns the remainder of the record.

The FLD function is similar to the built-in REXX SUBSTR function, except that FLD interprets the “*substring*” according to the specified data type, and returns the value formatted appropriately. (For a numeric field, FLD returns the value with a sign, and without leading zeros.)

Example 1

If the value of the packed-decimal field that starts at byte 8 is greater than 100, do not process the current record.

```
if fld(8,P) > 100 then exit 'DROP'
```

Example 2

If the value of the 2-digit year field starting at byte 42 is greater than 60, insert the literal “19” before the year field. Otherwise, insert “20”.

```
if fld(42,2,Z) > 60 then
  outrec = fld(1,41)||'19'||fld(42)
else
  outrec = fld(1,41)||'20'||fld(42)
```

NCONTAIN

►► NContain(*number* , *match*) ►►

If the numeric value of any of the *match* arguments is equal to the numeric value of *number*, NCONTAIN returns 1. Otherwise, NCONTAIN returns 0.

Example 1

If the current record contains a packed decimal value of value of 10, 20, or 30 starting at byte 8, print the record.

```
if nco(fld(8,P),10,20,30) then print(inrec,'CHAR')
```

Example 2

If the current record contains a zoned decimal value of 11, 12, or 13 starting at byte 10, drop the record from processing.

```
if nco(fld(10,5,Z),11,12,13) then exit 'DROP'
```

Related tasks

[CONTAINS on page 267](#)

PRINT

►► PRINT(*record* , *format*) ►►

Prints the *record* string in the specified *format*: SNGL or TABL.



Note:

1. Only those fields that have been selected in the template are printed.
2. If the record has been reformatted by template processing, the variable INREC contains the input record value and OUTREC will contain the reformatted output record.

Example 1

Print the first hundred records.

```
if PRTCOUNT() < 100 then PRINT(inrec,'CHAR')
```

Example 2

Print the current input record in TABL format.

```
rc = PRINT(inrec,'TABL')
```

Related tasks

[Working with templates on page 72](#)

[Selecting a display format on page 149](#)

PRTCOUNT

►► PRTCOUNT() ◄◄

Returns the current count of records printed.

Example

Print the first 10 input records.

```
if prtcount() < 10 then print(inrec,'CHAR')
```

RECSIN

►► RECSIN() ◄◄

Returns the count of records read so far from the input data set, and passed to the REXX procedure. Only the input records that are selected by the template are passed to the REXX procedure and included in the count returned by RECSIN.

Example

Print every hundredth record.

```
if RECSIN()//100 = 0 then PRINT(inrec,'CHAR')
```

RECSOUT

►► RECSOUT(*ddname*) ◄◄

Returns the count of records so far written to the specified output data set.

The argument you can specify is:

ddname

Specifies that the count of records so far written to the data set identified by the specified *ddname* be returned.

The count of records written to an output data set is incremented each time a WRITE function is issued against the specified data set. In the case of the primary output data set, the count is also incremented each time a record is written to the data set by the FM/Db2 function. Unless a record is discarded using the RETURN DROP (or STOP IMMEDIATE) instruction, each record selected for processing is written to the primary output data set.

Example 1

If more than one hundred records have been written to the EXT100 file, stop FM/Db2 processing.

```
rc = WRITE(EXT100)
if RECSOUT(EXT100) > 100 then exit "STOP"
```

Related tasks

[RETURN values on page 273](#)

TALLY

► TALLY(*start* , *length* ,  , *string*) ◄

Accumulates the value of the specified input record field in a TALLY register and, at the end of the Import utility, prints on SYSPRINT the TALLY register prefixed by the character string *string*. If the TALLY function is successful, it returns a value of 0. If it is unsuccessful, it raises the REXX syntax error condition.

The field whose value is to be accumulated starts at position *start* (in bytes) in the input record, and is *length* bytes long. If the sum of *start* and *length* is greater than LENGTH(INREC), the TALLY function returns a value of 0 without changing the TALLY register.

The data type of the field to be accumulated is specified by *type*. The values that can be specified for *type* are:

B

if the field is binary. If you specify B for *type*, *length* must be 2, 4, or 8. The field is assumed to be signed.

P

if the field is packed decimal. If you specify P for *type*, *length* must be between 1 and 16 bytes.

Z

if the field is zoned decimal. If you specify Z for *type*, *length* must be between 1 and 32 bytes or, if the field contains a separate sign character, between 1 and 33 bytes.

The default value for *type* is Z.

You can code more than one TALLY function in your procedure. FM/Db2 creates a separate TALLY register for each TALLY function with a unique combination of arguments. This means that you can accumulate a given field in more than one TALLY register by specifying a different value for *string* in each TALLY function.

Example

Accumulate hours recorded in personnel records depending on record type.

```
select;
  when(fld(1,1) = 'E') then
    rc = TALLY(15,4,B,'Sum of employee hours')
  when(fld(1,1) = 'S') then
    rc = TALLY(15,4,B,'Sum of supervisor hours')
  otherwise
```

```
rc = TALLY(28,4,B,'Sum of manager hours')
end
```

TM

►► **TM(*string* ,*mask*)** ◄◄

Tests selected bits of a string and sets the condition code accordingly.

The length of the test is based on the length of the shorter of the two arguments, *string* and *mask*. A *mask* bit of one indicates that the equivalent bit in *string* is to be tested. If a *mask* bit is zero, the equivalent *string* bit is ignored. If the tested bits are all ones, TM returns 1. Otherwise, TM returns 0.

Example 1

Test the third byte of the input record and if the low order bit is set, overlay a hex FF into the second byte of that record.

```
if TM(fld(3,1),'01'x) then do
  outrec = OVERLAY('FF'x,outrec,2)
  exit
end
exit drop
```

Example 2

Test the third byte of the input record and if the high order bit is set, logically OR a hex 04 over the contents of the second byte of that record.

```
if TM(fld(3,1),'10000000'b) then do
  outrec = OVERLAY(BITOR(fld(2,1),'04'x),outrec,2)
  exit
end
exit drop
```

WRITE

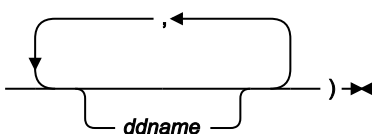
►► **WRITE(**  **)** ◄◄

Writes a record to the specified data sets. If the WRITE function is successful, it returns a value of 0. If the WRITE function is unsuccessful, it raises the REXX syntax error condition.

The argument you can specify is:

ddname

Specifies a record is to be written to the data set identified by the specified *ddname*.

The record is written from the contents of one of the following REXX variables:

- If it has been assigned a value by the procedure, the variable `OUTREC.ddname`, where *ddname* is the ddname specified in the `WRITE` function
- If the variable `OUTREC.ddname` has not been assigned a value, or has been unassigned using the `DROP` instruction, the FM/Db2-defined variable, `OUTREC`

The length of the record written depends upon the data set attributes of the output data set. If the output data set contains variable-length records, the length of the record is determined from the length of the data in the REXX variable. If the length of the data is greater than the maximum record length specified in the data set attributes, the record is truncated. If the output data set contains fixed-length records, the length of the record written is the length specified in the data set attributes, truncated or padded as necessary.

If the record format of the output data set specifies that the records contain a carriage control character, depending on the output device, the first character of the record data in the REXX variable is interpreted as a carriage control character. For more information about records containing carriage control characters, see *OS/390 DFSMS: Using Data Sets*.

Example 1

If the current record is type 01, write it to the DD01 file.

```
if fld(1,2) = 01 then WRITE('DD01')
```

Example 2

If the current record is type 02, write it to the DD02 and DD02COPY files.

```
if fld(1,2) = 02 then WRITE('DD02','DD02COPY')
```

RETURN values

In REXX, you can use the `RETURN` instruction to leave a procedure. You can optionally specify a character string as a parameter on the `RETURN` instruction. This character string is returned to the caller of the procedure. File Manager recognizes and processes the following character strings if specified on the `RETURN` instruction. The character strings can be specified in uppercase, lowercase, or a mixture of both.

DROP

The character string `DROP` tells FM/Db2 to not write the current record to the primary output data set. Specifying `DROP` on the `RETURN` instruction results in the current record not being imported to the target table.

Here are some examples:

```
RETURN 'DROP'
Return 'Drop'
Return drop /* assumes no variable named 'drop' has been assigned */
```

STOP

The character string STOP tells FM/Db2 to stop the current FM/Db2 function after the current record has been written to the primary output data set. Specifying STOP on the RETURN instruction results in the current record being imported to the target table and the Import utility being stopped.

Here are some examples:

```
RETURN 'STOP'
Return 'Stop'
Return stop /* assumes no variable named 'stop' has been assigned */
```

STOP IMMEDIATE

The character string STOP IMMEDIATE tells FM/Db2 to stop the current FM/Db2 function without writing the current record to the primary output data set. Specifying STOP IMMEDIATE on the RETURN instruction results in the current record not being imported to the target table and the Import utility being stopped.

Here are some examples:

```
RETURN 'STOP IMMEDIATE'
Return 'Stop Immediate'
Return stop immediate /* assumes variables 'stop' and 'immediate' not assigned */
```

Copying data to a VSAM or QSAM file

To copy data from a Db2® table or view to a partitioned, sequential, or VSAM data set, use the Export utility function (3.7).



Note:

1. To copy data between Db2® tables, use the Copy utility function (3.3).
2. To copy data to a Db2® table or view from a QSAM or VSAM data set, use the Import utility function (3.6).
3. To copy data to a sequential file using the Db2® UNLOAD utility, use the Db2® Utilities option (3.9). When copying large tables, the use of the Db2® UNLOAD utility is preferable (for reasons of performance and efficiency).

The Export utility generates the export data using Db2® SQL. The data can be exported in any of these formats:

- Db2® (File Manager internal) format. This format is *not* the same as the data formats used by the DSNTIAUL sample job and the Db2® utilities. This is the recommended option if the exported data is imported into another Db2® table using the FM/Db2 Import utility.
- Db2® external (or unload) format. This is the same format used by the Db2® UNLOAD utility.
- Db2® DSNTIAUL unload format. This is the format used by the Db2® DSNTIAUL sample program.
- A user defined format. Note that the user defined Placement: **3. User defined** is not supported by the Import utility.

- Delimited (CSV) format. The exported data format is not supported by the Import utility.
- Copybook layout format.

You can use the output data set generated by the Export Utility for input to:

1. The FM/Db2 Import utility. This utility supports data in Db2® format and copybook formats.
2. A PC-based spreadsheet application program in the form of a comma-delimited (CSV) file.
3. Other user application programs.

If you export data, you can:

- Select the format in which the data is exported.
- Select the columns to be exported by selecting the required columns in the "from" template.
- Reformat data during export by mapping table columns to fields in the output partitioned, sequential, or VSAM data set (as defined by a template).
- Create and save a template that describes the exported data.
- Select which rows to export.
- Specify the number of rows that are exported.
- Specify whether you want to run the export in foreground or batch.

To display the Export Utility panel,

1. From the Primary Option Menu panel, enter **3** (Utilities) to display the Utility Functions panel.
2. From the Utility Functions panel, enter **7** (Export)

Related tasks

[Copying data from a VSAM or QSAM file on page 246](#)

[Notes on using Export on page 282](#)

[Specifying details for the "From" table on page 275](#)

[Specifying details for the "To" data set on page 279](#)

Related references

[Primary Option Menu panel on page 728](#)

[Utility Functions panel on page 864](#)

[Export Utility \("From"\) panel on page 673](#)

Specifying details for the "From" table

Specify the name of the source (*"From"*) table on the Export Utility panel. If the table you specify does not exist, FM/Db2 issues an error message and stops the utility.

If you do not want to export all of the rows in the *"From"* table, specify the number of rows you want to export (1–99999999) in **Export Count**.

If you are using a specific template for the *"From"* table (see option 1 in **Template usage**), specify the name of the template in the **From Template** entry fields.

The **Processing Options** on the Export Utility panel specify which template you want to use for the *"From"* table, and whether you want to edit the template before the export process.

Template usage

The Export Utility panel provides four options for template processing:

1. Above

Requires that you enter the name of a template data set (and optionally a member name) in the **From Template** section of the panel. If you do not specify a member name, or if you specify a pattern, FM/Db2 displays a member selection list. After you have specified the member containing a template, processing continues using this template in place of the automatically-generated template for the table (see Template usage option 3).

2. Previous

Uses the last (previously used) template for this table.

3. Generate from table

Generates a template based on the information in the Db2® catalog for the specified table. This is the default setting. If you have specified a member name in the **From Template** section of the panel, it is ignored. FM/Db2 generates the required template in memory.

4. Generate/Replace

Generates a template based on the information in the Db2® catalog for the specified table, and saves this information in the member specified in the **From Template** section of the panel. If the member already exists, it is replaced. Any prior customization is lost.

You can select the following options by entering a *"^"* or an *"A"*:

Edit options

Use to display the first of the Export Options panels.

Edit template

Use to edit the template for the *"From"* table before proceeding to the Export Utility *"To"* panel.

To proceed, press Enter.

If you selected **Edit options** (either by using a *"^"*, or by having previously used the *"A"* selection character for this option), the first of the Export Options panels is displayed.

If you selected **Edit template** (either by using a *"^"*, or by having previously used the *"A"* selection character for this option), the Column Selection/Edit panel is displayed.

Otherwise, the Export Utility *"To"* panel is displayed.

Related tasks

[Specifying a Db2 object name on page 45](#)

[Specifying a data set and a member name on page 50](#)

[Selecting options on FM/Db2 panels on page 44](#)

[Working with templates on page 72](#)

[Editing the template for the "From" table on page 277](#)

[Specifying details for the "To" data set on page 279](#)

Related references

[Export Utility \("From"\) panel on page 673](#)

Setting options for the current Export session

If you select **Edit options** on the Export Utility panel (or the Export Utility "To" panel), FM/Db2 displays the first of up to three Export Options panels. The remaining panels are displayed by pressing the `NxtPage` function key (F11).



Note:

1. To navigate to the Export Options (2 of 3) panel, you must select one of the data format options **4. User defined** or **5. Delimited variables (CSV), and Null indicators / CSV options** on the Export Options (1 of 3) panel.
2. To navigate to the Export Options (3 of 3) panel, you must select the data format option **4. User defined and Data type format** on the Export Options (1 of 3) panel.

Use the Export Options panels to change the options for the current Export session.



Note: Options apply for the current session of FM/Db2 and only revert to global settings when the session is terminated or global settings are invoked (from the pull down or from the menu).

Related references

[Export Utility \("From"\) panel on page 673](#)

[Export Options \(1 of 3\) panel on page 665](#)

Editing the template for the "From" table

If you select the **Edit template** option on the Export Utility panel, FM/Db2 displays the Column Selection/Edit panel. You can use this panel to restrict the data in the "From" table that you want exported by:

- Selecting (or deselecting) specific columns for exporting.
- Specifying *row selection criteria*. Only rows whose contents satisfy the criteria are selected for exporting.



Note: When you export data in FM/Db2 internal (SQLDA) format, you cannot alter the order in which the columns are exported. Data is always exported in the order that the columns are defined in the Db2® catalog (the same order in which the columns are displayed in the Column/Selection Edit panel).

The Export Utility ignores any information specified in the **Seq** field of the template (this information is used to change the order in which FM/Db2 *displays* or *prints* columns).

For example, the template shown in [Figure 66: Column Selection/Edit panel for the “From” table on page 278](#) has been edited to select certain columns and only rows whose contents meet certain criteria. If you use this template as the “From” template for your Export, the data exported is restricted to:

- The columns FIRSTNME, LASTNAME, WORKDEPT, and JOB, but only where WORKDEPT equals “MNT” and JOB equals “PAINTER”.

Figure 66. Column Selection/Edit panel for the “From” table

```

Process  Options  Utilities  Help
-----
FM/Db2 (DFG2)                Column Selection/Edit                Line 1 of 16
TABLE FMUSER.EMP
----- Row Selection Criteria ---- (Use SQL/PF4 for full screen edit) -----
1 Sel: WHERE "WORKDEPT" = 'MNT' AND "JOB" = 'PAINTER'
-----+

```

Cmd	Seq	SHEX	CL#	Column name	Data type(length)	Null	Default	Order	A/D
---	---		1	EMPNO	CHARACTER(6)		None	---	---
---	---	S	2	FIRSTNME	VARCHAR(12)		None	---	---
---	---		3	MIDINIT	CHARACTER(1)		None	---	---
---	---	S	4	LASTNAME	VARCHAR(15)		None	---	---
---	---	S	5	WORKDEPT	CHARACTER(3)	Y	Null	---	---
---	---		6	PHONENO	CHARACTER(4)	Y	Null	---	---
---	---		7	HIREDATE	DATE	Y	Null	---	---
---	---	S	8	JOB	CHARACTER(8)	Y	Null	---	---
---	---		9	EDLEVEL	SMALLINT	Y	Null	---	---
---	---		10	SEX	CHARACTER(1)	Y	Null	---	---
---	---		11	BIRTHDATE	DATE	Y	Null	---	---
---	---		12	SALARY	DECIMAL(9,2)	Y	Null	---	---

```

Command ==>
F1=Help      F2=Split    F3=Exit     F4=SQL      F5=RFind   F6=RunTemp
F7=Up        F8=Down    F9=Swap    F10=Left   F11=Right  F12=Cancel

```

Related tasks

- [Working with templates on page 72](#)
- [Changing the sequence of displayed or printed data on page 98](#)

Related references

- [Export Utility \(“From”\) panel on page 673](#)
- [Column Selection/Edit panel on page 485](#)

Specifying details for the "To" data set

Type the "To" data set details. Use a combination of the **Data set name**, **Member**, and **Volume** entry fields to specify the partitioned, sequential, or VSAM data set to which you want to export the data. You can specify the name of an existing data set, or the name of a data set that you want the Export utility function to create.

If you are using a specific template or copybook for the "To" data set, specify the name of the template or copybook data set and, optionally, the member name, in the **To Copybook or Template** entry fields.

Use the **Processing Options** to select a number of options for the export process.

To proceed, press Enter.

If you selected **Edit options** (either by using a "/", or by having previously used the "A" selection character for this option), the second of the Export Options panels is displayed.

If you selected **Edit template mapping** (either by using a "/", or by having previously used the "A" selection character for this option), the Template Mapping panel is displayed for editing.

If you selected **Batch execution** (either by using a "/", or by having previously used the "A" selection character for this option), the generated JCL is displayed using the ISPF editor, where you can review the JCL and submit the job for batch processing.

If you selected options **3. Batch, using Db2® utility** and **Edit UNLOAD options** on the Export Options - (1 of 3) panel, before the generated JCL is displayed using the ISPF editor, the UNLOAD Options panel is displayed.

Otherwise, FM/Db2 exports the data from the "From" table to the "To" partitioned, sequential, or VSAM data set.

Related tasks

[Specifying a data set and a member name on page 50](#)

[Mapping data on page 109](#)

[Exported data formats on page 279](#)

[Running Export in batch on page 281](#)

[Notes on using Export on page 282](#)

Related references

[Export Utility \("To"\) panel on page 676](#)

[Template Mapping panel on page 850](#)

Exported data formats

You can export data in four pre-defined formats:

- Db2® (File Manager internal) format
- Db2® external (or unload) format

- Db2® DSNTIAUL unload format
- Comma-delimited format (CSV output)

and two formats that require user definition:

- A user-defined format
- Copybook layout format

The output format depends on which **Data format** option you selected on the Export Options - (2 of 3) panel:

To export data in Db2® (File Manager internal) format, specify option 1 (**FM/Db2 (SQLDA) format**).

To export data in Db2® external (or unload) format, specify option 2 (**Db2® unload format**).

To export data in Db2® DSNTIAUL unload format, specify option 3 (**DSNTIAUL format**).

To export data in user-defined format, specify option 4 (**User defined**).

To export data in comma-delimited format (CSV output), specify option 5 (**Delimited Variables (CSV)**).

The output format depends on which **Template usage** processing option you select.

To export data in Db2® (File Manager internal) format, specify **Template usage** option 3 (**Generate from input**) or option 4 (**Generate and save**) and export option 1 **FM/Db2 (SQLDA) format**. When you specify these options, FM/Db2 copies the output template from the input template, and exports the data in the format returned by Db2® if an SQLDA is used to access the result table. In this format, any nullable column is preceded by a 2-byte binary field containing the null indicator. If the "From" column has a null value, the null indicator field for the corresponding "To" field contains -1, otherwise it contains 0. Each decimal field in the output data set occupies 16 bytes, with the data left-aligned followed by trailing binary zeros. Any graphic or vargraphic field is followed by two bytes containing binary zeros. Use this option if you plan to import the exported data into another Db2® table using Import (option 3.6).

To export data in Db2® unload format, specify Template usage option 3 (**Generate from input**) or option 4 (**Generate and save**) and select export option 2 **Db2® unload format**. The exported data is in the same format as that returned by the Db2® UNLOAD utility, with the NOPAD option not specified. In this format, any nullable column is preceded by a 1-byte binary field containing the null indicator. If the "From" column has a null value, the null indicator field for the corresponding "To" field contains X'FF', otherwise it contains 0. Any decimal field occupies the minimum number of bytes needed to represent the data as a packed decimal field. Variable length columns in the unloaded records are padded to their maximum length and the padded data fields are preceded by length fields that indicate the size of the actual data without the padding. CCSID conversion is not supported. The exported data will be in the CCSID used to bind the FM/Db2 plan.

To export data in DSNTIAUL format, specify Template usage option 3 (**Generate from input**) or option 4 (**Generate and save**), and select export option 3. **DSNTIAUL format**. In this format, any nullable column is followed by a 1-byte binary field containing the null indicator. If the "From" column has a null value, the null indicator field for the corresponding "To" field contains "?", otherwise it contains 0. Any decimal field occupies the minimum number of bytes needed to represent the data as a packed decimal field.

To export data in comma-delimited format (CSV output), specify **Template usage** option 5 (**None. CSV output**). If you specify this option, FM/Db2 does not generate an output template but writes the exported data as varying-length records, separated by a delimiter. For delimited format, FM/Db2 uses the **Null column display indicator** to indicate that data for a nullable column is the null value.

To export data in user-defined format, specify **Template usage** option 3 (**Generate from input**) or option 4 (**Generate and save**), and select export option **4. User defined format**. For a user-defined format, FM/Db2 provides the following options for nullable columns:

- To use or not use nulls. In the latter case, there would be no fields in the exported data corresponding to the null indicator. Set Null Indicators Usage to **2. None** on Export Options screen.
- To place the null indicator either before or after the data for the column to which it applies. Set Null Indicators Placement to **1. Before** or **2. After** on the Export Options screen.
- To use either a 1-byte (character format) or 2-byte (signed integer format) for the null indicator, set Null Indicators Type to **1. One byte** or **2. Two byte** on the Export Options screen. Set the value to be used in Indicator **Char** or **Integer**.

To export data in user-defined format, and to place either a 1-byte (character format) or a 2-byte (signed integer format) null indicator somewhere in the output record, but not before or after the data for the column to which it applies, select Null Indicators Placement to **3. User defined** on the Export Options - (2 of 3) panel. You must provide a copybook and specify Template usage option **1 (Above)** or **2 (Previous)**, and select **Edit template mapping** and map the null indicators. If the field names in the copybook are not the same as the Db2® column names, you will also need to map each Db2® column to the appropriate field in the copybook.

To export data in any other format, you must use a user-defined template. Specify **Template usage** option 1 (**Above**) to use the template you have specified in the **To Copybook or Template** section of the panel, or **Template usage** option 2 (**Previous**) to use the template last used for the table from which you are exporting data. If exporting columns that permit null values, FM/Db2 processes them as follows: if the field that corresponds to a nullable column is followed by an unmapped 2-byte binary field, FM/Db2 maps the null indicator for the column to this 2-byte binary field. In all other situations, FM/Db2 does not map the null indicator to any field in the output template.

Related references

[Editor Options \(4 of 8\) panel on page 641](#)

Running Export in batch

If you want to export large Db2® tables, you can perform the export in a batch job.

If you select the **Batch execution** option on the Export Options (1 of 3) panel, the Export utility builds the necessary JCL to perform the export function in a batch job. The generated JCL is displayed using the ISPF editor, where you can review the JCL and submit the job for batch processing. If you select the **Batch, using Db2® utility** option, the JCL is set up for the Db2® UNLOAD utility, and displayed for review before submission.

If you have one or more data sets that contain the template that describes the record structure of your input data, you can specify the data set details (or TSO ALLOC statement) in the generated JCL with the keywords TINPUT or TCIN.

Similarly, if you have one or more data sets that contain the template that describes the record structure of your output data, you can specify the data set details (or TSO ALLOC statement) in the generated JCL with the keywords TOUTPUT or TCOU.

If the export data set does not already exist, you are prompted to create it. However, you can defer the creation of the export data set until batch job execution time by selecting the **Batch data set creation** option. If you select this option, FM/Db2 creates a new sequential export data set in the JCL for the batch job.

Related references

[DBX \(Export\) batch command on page 979](#)

Notes on using Export

The Export utility function provides one method for moving Db2® data between different Db2® sub-systems (that is, to export data from one Db2® sub-system and import it to another Db2® sub-system). If you want to move data between tables in the same Db2® sub-system, you might find it more convenient to use Copy (3.3), or move the data by direct execution of SQL statements.

In general terms, the Export utility function is suitable for extracting small to medium volumes of data from Db2® tables. It is not intended to serve as a substitute for the Db2® utilities if unloading or migrating large volumes of data. The Db2® utilities offer superior performance in these situations.

It is recommended that you run the Export utility in batch whenever possible.

The Export utility provides for automatic mapping of the Db2® null indicator. However, if Export Option Data format 4. User defined Null Indicators Placement 3. User defined is selected the template editor shows the null indicator as a separate item in the "From" template on the Field Mapping panel. It is therefore possible to re-map the null indicator associated with nullable columns to a field in the export data set. If you want to rearrange the data fields in the export data set, it is recommended that you first export the data using the default mapping and then use the File Manager Base component to map the data to the required format.

A sample REXX exec is provided in SFMNSAM1 that converts a FM/Db2 template generated by FM/Db2 into a COBOL or PL/I copybook.

To convert a FM/Db2 template generated by FM/Db2 into a COBOL or PL/I copybook, you specify a TSO command like the following:

```
FMN2CPYB input output language
```

where:

input

The name of a sequential file or partitioned data set and member that contains a File Manager Db2® template.

output

The name of a sequential file or partitioned data set and member that will contain the copybook.

language

Optional keyword that determines the type of copybook generated. Valid values are:

COBOL
PL/I

If not specified, a COBOL copybook is generated.

The sample REXX must be copied to a library in your SYSPROC or SYSEXEC concatenation. Alternatively, you can specify the library name containing the sample exec in the command.

Related tasks

[Copying data from one Db2 object to another on page 241](#)

[Generating batch JCL for Db2 utility jobs on page 339](#)

[Working with templates on page 72](#)

Copying data from a File Manager/Db2 editor session, or from an SQL statement

Use the EXPORT primary command to write data from the current FM/Db2 editor session to an external file. Alternatively, you can re-execute the SQL statement that generated the data for the current FM/Db2 editor session and write rows for this select statement to an external file. For the second option, you can generate a JCL deck to perform the export operation using batch processing.

Data can be exported in the same data formats as for the Export utility (3.7).

During the export process, the Export Utility panel is optionally displayed. You enter the data format for the exported data on this panel.

The Export "To" panel is also optionally displayed. The Export "To" panel enables you to:

- Specify the name of the data set that will contain the exported data.
- Specify the name of a data set that contains a template or copybook, that describes the exported data.
- Specify a processing option for the template data set.
- Specify a disposition option for the export data set.
- View and possibly change the export options.
- Use the template editor to display and possibly change the mapping between the source and data to be exported.

Related references

[Export Utility \("From"\) panel on page 673](#)

[Export Utility \("To"\) panel on page 676](#)

[Specifying details for the "From" data set on page 248](#)

[Specifying details for the "To" table on page 244](#)

[EXPORT primary command on page 894](#)

Specifying the source for the exported data

You can specify the source for the exported data with the ALL, NX, X, or EX parameter to the EXPORT primary command.

When you specify this parameter, FM/Db2 copies all, or selected, rows in the current FM/Db2 editor session to the target data set.

If you omit this parameter, FM/Db2 re-executes the SQL statement that produced the data for the current FM/Db2 editor session. FM/Db2 exports the rows fetched by the SQL statement to the target data set, up to any row limit specified on the export options panel.

You can use the **Export Count** field on the Export Utility panel to limit the data loaded into the FM/Db2 editor, for large Db2® objects, or arbitrary select statements that generate large result tables. Issuing the EXPORT primary command without the ALL parameter enables all rows for the Db2® object, or result table from the arbitrary select statement, to be written to the export data set.

Related references

[EXPORT primary command on page 894](#)

[Export Utility \("From"\) panel on page 673](#)

Specifying the format of the exported data

You can export data in a number of data formats (see [Exported data formats on page 279](#)).

You can specify the data format for the exported data as an optional parameter to the EXPORT primary command. When specified, the parameter overrides the current data format, as displayed on the Export Options (1 of 3) panel.

The possible parameter values are SQLDA, Db2®, DSNTIAUL, USER, and CSV.

Related references

[EXPORT primary command on page 894](#)

[Export Options \(1 of 3\) panel on page 665](#)

Limiting the rows exported with a label range

You can limit the rows processed to only those rows within a specified label range, rather than all rows in the FM/Db2 editor session.



Note: You can only specify a label range if you have also specified the source parameter (ALL, NX, X, or EX).

You must specify a "from" label and a "to" label.

Related references

[Assigning labels to rows on page 147](#)

[EXPORT primary command on page 894](#)

Differences compared with the export utility

The process for exporting data with the EXPORT primary command is similar to that for the Export utility function (3.7) with the following exceptions:

- The **Batch, using Db2® UNLOAD** execution option is not available when exporting data using the EXPORT primary command.
- The dialog commences with the optional display of the Export Options (1 of 3) panel. The Export Utility panel is not displayed.
- The data to be exported can be the result table for the SQL statement that generated the current FM/Db2 editor session, *or* rows from the current FM/Db2 editor session. In the former case, the SQL statement can refer to a Db2® object (for example, when entered using the Edit function), or an arbitrary SQL statement (for example, when entered using one of the SQL options 4.1, 4.2, 4.3 or 4.4). The arbitrary SQL statement can be any valid select statement, including joins of multiple tables, sub-selects, and so on. By contrast, the Export utility only allows export of data from a Db2® object (for example, table, view, alias).
- When using the EXPORT primary command to export data from an arbitrary SELECT statement (for example, entered using one of the FM/Db2 functions 4.1, 4.2, 4.3 or 4.4) in batch, there are some restrictions on the template mapping operations that are supported.

It is not possible to use the template used to describe the SELECT statement in the editor session in the generated JCL deck.

For export in CSV format, which cannot be described using a template, this means any changes made to the template for the editor session are discarded when exporting the data - the output will include data for every column.

For export in other supported formats:

- Use the TE command in the editor session to select or de-select the columns as required.
 - Issue the EXPORT BAT command to generate a JCL deck.
 - You are required to save the output template that describes the data to be exported. This is included as a parameter in the JCL deck.
 - When the JCL deck is submitted for processing, FM/Db2 re-creates a temporary template for the arbitrary SQL statement specified in the JCL deck, and then uses template mapping to identify which columns should be exported - these are the columns defined in the output template.
- The export options panel includes an input field where the number of rows to be exported can be entered. This operates independently of any input field that limits the number of rows loaded into the FM/Db2 editor session. It is therefore possible to edit a few rows of a result table using FM/Db2 edit, and then export *all* the rows for that result table to a data set.

Related references

[Export Options \(1 of 3\) panel on page 665](#)

[Export Utility \("From"\) panel on page 673](#)

[EXPORT primary command on page 894](#)

Ways that you can use the EXPORT primary command

Here are two ways you can use the EXPORT primary command:

- To export data from an arbitrary SQL statement to an external file:
 1. Develop the SQL SELECT statement using options 4.1, 4.2, 4.3, or 4.4. The SQL statement can be any valid SQL statement, including joins of multiple tables, sub-selects, and so on.
 2. Use the row count field to limit the rows loaded into the FM/Db2 editor, if the result table is large.
 3. Confirm that the result table is correct by examining the data in the Edit session.
 4. Optionally edit the template and de-select any columns of the result table that are not required.
 5. Issue the EXPORT command without the ALL parameter, to export all rows from the result table of the arbitrary SQL statement to an external file. You can also issue EXPORT BAT to generate a JCL deck to export the rows from the arbitrary SQL statement to an external file. If required you can take a copy of the generated JCL for later re-use.
- To export selected editor session rows to an external file:
 1. Ensure that the **Use edit (instead of browse) to display results** option is selected. This option is set using the FM/Db2 System Options (2 of 3) panel.
 2. Develop the SQL SELECT statement using options 4.1, 4.2, 4.3 or 4.4, or edit the required Db2® object using the FM/Db2 Edit utility.
 3. Use editor commands to isolate the required data in either excluded, not excluded rows, label ranges, or some combination of these methods.
 4. Issue the EXPORT primary command with the OPT parameter and one of ALL, X, or NX. Ensure that the required data format is selected. On the Export "To" panel, enter the required export data set name and set the disposition option to MOD.
 5. After the initial export of rows to the export data set, isolate additional rows to be exported, then issue EXPORT QUIET plus a combination of ALL, X, or NX and optionally a label range, to export the additional rows. The MOD setting for the export file ensures that each additional EXPORT primary command adds the newly-exported rows to the end of the export data set.

Scrambling data

Scrambling data allows you to create test data based on production (or "live") data, but with the ability to change the values of certain columns. In this way, you can avoid sensitive or confidential information appearing in test data.

When can you scramble data?

When you copy data from one place to another with either the Copy Utility (option 3.3), Import Utility (option 3.6), or Export Utility (option 3.7), you can choose to scramble some or all of the columns being copied.

For scrambling to occur during the copy, import, or export process, you must supply an *output template* which has mapped fields *marked for scrambling*.

Scrambling rules

FM/Db2 scrambles data according to these rules:

- If you do not specify any value or range options:
 - Uppercase alphabetic characters are scrambled to other uppercase alphabetic characters.
 - Lowercase alphabetic characters are scrambled to other lowercase alphabetic characters.
 - DBCS characters are scrambled to other DBCS characters.
 - Numerics are scrambled to other numerics.
 - Any other characters remain unchanged.
 - Repeatable scrambling produces unique results for numeric fields defined with **Leading zeros** set to YES, and all non-numeric fields.
- If you provide a value list, then the column is populated with a value from the list.
- If you provide a range, then the resultant number is in the range provided.
- If you specify a scramble type of random or repeatable and also the value option and a value data set, then the column is populated with a value from the data set.
- If you specify a scramble type of translate, then the input column value is matched and the corresponding output value is used from the value data set.

Related topics

[Specifying scrambling options on page 104](#)

[Column Attributes panel \(alphanumeric\) on page 473](#)

[Column Attributes panel \(numeric\) on page 478](#)

[Value List Edit panel on page 867](#)

[Scramble Exit Specification panel on page 780](#)

How do I...?

If you want to copy data from one place to another, but are not sure of the best way of going about it, you may find the following sections helpful.

The sections below describe typical situations that you may encounter when planning to copy data. For each scenario, step-by-step instructions are included describing how to achieve the required result.



Note: In the following examples, “*source table*” refers to the table from which the data is exported, and “*target table*” refers to the table to which the data is imported.

How do I copy data from one Db2® table to another on the same Db2® system?

Scenario: I have data in a Db2® table and want to copy it to another Db2® table. The source and target Db2® tables are on the same Db2® system.

Consider using the FM/Db2 Copy Utility (3.3), instead of the FM/Db2 Export Utility and Import Utility. If the source and target table have different column names, different numbers of columns, or if data type conversions are needed, you can use template re-mapping to map columns in the source table to columns in the target table. In most cases, FM/Db2 performs any data type conversions automatically.

Related tasks

[Copying data from one Db2 object to another on page 241](#)

[Column mapping rules on page 115](#)

How do I copy data from one Db2® table to another on a different (connectable) Db2® system?

Scenario: I have data in a Db2® table and want to copy it to another Db2® table. The source and target Db2® tables are on different Db2® systems. It is possible to connect to the target Db2® system from the source Db2® system by specifying a location value.

Consider using the FM/Db2 Copy Utility (3.3), instead of the FM/Db2 Export Utility and the FM/Db2 Import Utility. See [How do I copy data from one Db2 table to another on the same Db2 system? on page 288](#). If a large number of rows are to be transferred, some caution needs to be exercised due to network considerations.

Related tasks

[Copying data from one Db2 object to another on page 241](#)

[Column mapping rules on page 115](#)

How do I copy data from one Db2® table to another on a different (non-connectable) Db2® system?

Scenario: I have data in a Db2® table and want to copy it to another Db2® table. The source and target Db2® tables are on different Db2® systems. It is not possible to connect to the target Db2® system from the source Db2® system by specifying a location value, or I want to transfer the data out of Db2® as part of the copy process.

To copy the data, you need to perform two steps:

1. Use the FM/Db2 Export Utility (3.7) to export the data to a sequential file (preferably) or a VSAM file. In general, the default mapping is sufficient. To use the default mapping, specify a template data set and member name on the Export “To” panel and select **Template usage** option 4 (Generate and save). If the amount of data to be transferred is large (more than 10,000 rows), run the export in batch by selecting **Batch execution**. If the amount of data to be transferred is very large (more than 100,000–1,000,000 rows), consider using the Db2® UNLOAD utility (accessed from Utilities, 3.9) instead.
2. Use the FM/Db2 Import Utility (3.6) to load the exported data into the target Db2® table. If the target table has different column names to the source table, or if data type conversions are required, use template re-mapping to map columns in the source table to columns in the target table. In most cases, FM/Db2 performs any data type conversions automatically.

Related tasks

[Copying data to a VSAM or QSAM file on page 274](#)
[Running Export in batch on page 281](#)
[Copying data from a VSAM or QSAM file on page 246](#)
[UNLOAD utility on page 372](#)
[Column mapping rules on page 115](#)

Related references

[Export Utility \(“To”\) panel on page 676](#)

How do I copy and reorder selected data from a Db2® table to a sequential file?

Scenario: I have data in a Db2® table and I want to copy it to a sequential file. I only want the data for some of the columns in the Db2® table, and I want the data for those columns reordered in the sequential data set.

The FM/Db2 Export Utility (3.7) supports the export of selected columns from a Db2® object. To export selected columns only, edit the template on the Export Utility panel and deselect the columns that are not required.

The FM/Db2 Export Utility does *not* support the reordering of columns in the export data set. The selected columns are always exported in the order in which they are defined in the Db2® catalog. There is a simple workaround for this. Create a view for the Db2® object to be exported, specifying the columns in the desired order. Then export data from the view, to achieve the desired result.

Related tasks

[Copying data to a VSAM or QSAM file on page 274](#)
[Mapping data on page 109](#)

Related references

[Export Utility \(“From”\) panel on page 673](#)

How do I define a copybook that describes data exported to a sequential file?

Scenario: I have data in a Db2® table and I've used the FM/Db2 Export Utility to copy the data to a sequential file. I need to define a copybook that describes the exported data.

You need to code the copybook in either COBOL, HLASM, or PL/I. The amount of space required in the export data set for each of the Db2® data types is summarized in the following example:

- Suppose you want to export data from the table created using the following definition:

```
CREATE TABLE SAMPLE.EXPORT_EX
(COL1  INTEGER          NOT NULL
 ,COL2  SMALLINT        NOT NULL
 ,COL3  FLOAT(21)       NOT NULL
 ,COL4  FLOAT(53)       NOT NULL
 ,COL5  DECIMAL(1,0)    NOT NULL
 ,COL6  DECIMAL(15,7)   NOT NULL
 ,COL7  CHAR(10)        NOT NULL
 ,COL8  VARCHAR(10)     NOT NULL
 ,COL9  DATE            NOT NULL
 ,COL10 TIME           NOT NULL
 ,COL11 TIMESTAMP      NOT NULL
 ,COL12 ROWID  GENERATED ALWAYS NOT NULL
 )
```

A COBOL copybook that describes the exported data is as follows:

```
01 EXPORT-EXAMPLE.
* INTEGER DATA TYPE
  10 COL1                PIC S9(6) USAGE COMP.
* SMALLINT DATA TYPE
  10 COL2                PIC S9(4) USAGE COMP.
* FLOATING POINT (4 BYTES) DATA TYPE
  10 COL3                USAGE COMP-1.
* FLOATING POINT (8 BYTES) DATA TYPE
  10 COL4                USAGE COMP-2.
* PACKED DECIMAL DATA TYPE
  10 COL5                PIC S9(1)V USAGE COMP-3.
  10 FILLER              PIC X(15).
* PACKED DECIMAL DATA TYPE
  10 COL6                PIC S9(8)V9(7) USAGE COMP-3.
  10 FILLER              PIC X(8).
* CHARACTER DATA TYPE
  10 COL7                PIC X(10).
* VARCHAR DATA TYPE
  10 COL8.
     49 COL8-LEN        PIC S9(4) USAGE COMP.
     49 COL8-TEXT      PIC X(10).
* DATE DATA TYPE
  10 COL9                PIC X(10).
* TIME DATA TYPE
  10 COL10              PIC X(8).
* TIMESTAMP DATA TYPE
  10 COL11              PIC X(26).
* ROWID DATA TYPE
  10 COL12.
```

```

49 COL12-LEN      PIC S9(4) USAGE COMP.
49 COL12-TEXT     PIC X(40).

```

In HLASM, the copybook looks like this:

```

EXAMPLE DSECT
* Integer data type
COL1    DS    F
* Smallint data type
COL2    DS    H
* Floating point (4 bytes) data type
COL3    DS    E
* Floating point (8 bytes) data type
COL4    DS    D
* Packed decimal data type (1 byte)
COL5    DS    PL1
* Packed decimal data type (8 bytes)
COL6    DS    PL8
* Character data type
COL7    DS    CL10
* VARCHAR data type
COL8_LEN DS    H
COL8_TXT DS    CL10
* DATE data type
COL9    DS    CL10
* TIME data type
COL10   DS    CL8
* TIMESTAMP data type
COL11   DS    CL26
* ROWID data type
COL12_LEN DS    H
COL12_TXT DS    CL40
      END

```

In PL/I, the copybook looks like this:

```

DCL 1 EXPORT_EXAMPLE UNALIGNED,
/* INTEGER DATA TYPE */
  2 COL1          BIN(31,0),
/* SMALLINT DATA TYPE */
  2 COL2          BIN(15,0),
/* FLOATING POINT (4 BYTES) DATA TYPE */
  2 COL3          FLOAT,
/* FLOATING POINT (8 BYTES) DATA TYPE */
  2 COL4          FLOAT(8),
/* PACKED DECIMAL DATA TYPE */
  2 COL5          FIXED DEC(1,0),
  2 COL5_PAD      CHAR(15),
/* PACKED DECIMAL DATA TYPE */
  2 COL6          FIXED DEC(15,7),
  2 COL6_PAD      CHAR(8),
/* CHARACTER DATA TYPE */
  2 COL7          CHAR(10),
/* VARCHAR DATA TYPE */
  2 COL8,
    3 COL8_LEN    BIN(15,0),
    3 COL8_TEXT   CHAR(10),
/* DATE DATA TYPE */
  2 COL9          CHAR(10),

```

```

/* TIME DATA TYPE                                */
  2 COL10          CHAR(8),
/* TIMESTAMP DATA TYPE                            */
  2 COL11          CHAR(26),
/* ROWID DATA TYPE                                */
  2 COL12,
  3 COL12_LEN      BIN(15,0),
  3 COL12_TEXT     CHAR(40);

```

Note the following:

Db2® data type

Space in exported data set.

INTEGER

4 bytes.

SMALLINT

2 bytes.

REAL (4 bytes)

4 bytes.

FLOAT (8 bytes)

8 bytes.

PACKED DECIMAL

16 bytes in total. The data is left-aligned. The unused bytes contain binary zeros. A DECIMAL(*n,m*) field occupies TRUNC(*n/2*) + 1 bytes within the 16-byte field.

CHAR(*n*)

n bytes.

VARCHAR(*n*)

n+2 bytes. The data is preceded by a 2-byte binary field, containing the number of characters in the VARCHAR field.

DATE

10 bytes. See note 1.

TIME

8 bytes. See note 1.

TIMESTAMP

26 bytes.

ROWID

42 bytes. Define a ROWID column as for a VARCHAR(40) column.

**Note:**

1. The length required for DATE and TIME fields may vary if a date or time exit is in use.

- If the Db2® table has columns that allow nulls and was created using the following definition:

```
CREATE TABLE SAMPLE.EXPORT_EX_NULL
(COL1  INTEGER
, COL2  SMALLINT
, COL3  FLOAT(21)
, COL4  FLOAT(53)
, COL5  DECIMAL(1,0)
, COL6  DECIMAL(15,7)
, COL7  CHAR(10)
, COL8  VARCHAR(10)
, COL9  DATE
, COL10 TIME
, COL11 TIMESTAMP
, COL12 ROWID  GENERATED ALWAYS NOT NULL
)
```

- A COBOL copybook that describes the exported data is as follows:

```
01 EXPORT-EXAMPL2.
* INTEGER DATA TYPE WITH NULL INDICATOR
  10 COL1-NULL          PIC S9(4) USAGE COMP.
  10 COL1                PIC S9(6) USAGE COMP.
* SMALLINT DATA TYPE WITH NULL INDICATOR
  10 COL2-NULL          PIC S9(4) USAGE COMP.
  10 COL2                PIC S9(4) USAGE COMP.
* FLOATING POINT (4 BYTES) DATA TYPE WITH NULL INDICATOR
  10 COL3-NULL          PIC S9(4) USAGE COMP.
  10 COL3                USAGE COMP-1.
* FLOATING POINT (8 BYTES) DATA TYPE WITH NULL INDICATOR
  10 COL4-NULL          PIC S9(4) USAGE COMP.
  10 COL4                USAGE COMP-2.
* PACKED DECIMAL DATA TYPE WITH NULL INDICATOR
  10 COL5-NULL          PIC S9(4) USAGE COMP.
  10 COL5                PIC S9(1)V USAGE COMP-3.
  10 FILLER              PIC X(15).
* PACKED DECIMAL DATA TYPE WITH NULL INDICATOR
  10 COL6-NULL          PIC S9(4) USAGE COMP.
  10 COL6                PIC S9(8)V9(7) USAGE COMP-3.
  10 FILLER              PIC X(8).
* CHARACTER DATA TYPE WITH NULL INDICATOR
  10 COL7-NULL          PIC S9(4) USAGE COMP.
  10 COL7                PIC X(10).
* VARCHAR DATA TYPE WITH NULL INDICATOR
  10 COL8-NULL          PIC S9(4) USAGE COMP.
  10 COL8.
    49 COL8-LEN          PIC S9(4) USAGE COMP.
    49 COL8-TEXT         PIC X(10).
* DATE DATA TYPE WITH NULL INDICATOR
  10 COL9-NULL          PIC S9(4) USAGE COMP.
  10 COL9                PIC X(10).
* TIME DATA TYPE WITH NULL INDICATOR
  10 COL10-NULL         PIC S9(4) USAGE COMP.
```

```

10 COL10          PIC X(8).
* TIMESTAMP DATA TYPE WITH NULL INDICATOR
10 COL11=NULL    PIC S9(4) USAGE COMP.
10 COL11          PIC X(26).
* ROWID DATA TYPE
10 COL12.
49 COL12-LEN     PIC S9(4) USAGE COMP.
49 COL12-TEXT    PIC X(40).

```

In HLASM, the copybook looks like this:

```

EXAMPLE2 DSECT
* Integer data type with null indicator
COL1_NI DS H
COL1 DS F
* Smallint data type with null indicator
COL2_NI DS H
COL2 DS H
* Floating point (4 bytes) data type with null indicator
COL3_NI DS H
COL3 DS E
* Floating point (8 bytes) data type with null indicator
COL4_NI DS H
COL4 DS D
* Packed decimal data type (1 byte) with null indicator
COL5_NI DS H
COL5 DS PL1
* Packed decimal data type (8 bytes) with null indicator
COL6_NI DS H
COL6 DS PL8
* Character data type with null indicator
COL7_NI DS H
COL7 DS CL10
* VARCHAR data type with null indicator
COL8_NI DS H
COL8_LEN DS H
COL8_TXT DS CL10
* DATE data type with null indicator
COL9_NI DS H
COL9 DS CL10
* TIME data type with null indicator
COL10_NI DS H
COL10 DS CL8
* TIMESTAMP data type with null indicator
COL11_NI DS H
COL11 DS CL26
* ROWID data type
COL12_LEN DS H
COL12_TXT DS CL40
END

```

In PL/I, the copybook looks like this:

```

DCL 1 EXPORT_EXAMPLE UNALIGNED,
/* INTEGER DATA TYPE WITH NULL INDICATOR */
2 COL1_NULL          BIN(15,0),
2 COL1              BIN(31,0),
/* SMALLINT DATA TYPE WITH NULL INDICATOR */
2 COL2_NULL          BIN(15,0),

```

```

2 COL2                BIN(15,0),
/* FLOATING POINT (4 BYTES) DATA TYPE WITH NULL INDICATOR */
2 COL3_NULL           BIN(15,0),
2 COL3                FLOAT,
/* FLOATING POINT (8 BYTES) DATA TYPE WITH NULL INDICATOR */
2 COL4_NULL           BIN(15,0),
2 COL4                FLOAT(8),
/* PACKED DECIMAL DATA TYPE WITH NULL INDICATOR */
2 COL5_NULL           BIN(15,0),
2 COL5                FIXED DEC(1,0),
2 COL5_PAD            CHAR(15),
/* PACKED DECIMAL DATA TYPE WITH NULL INDICATOR */
2 COL6_NULL           BIN(15,0),
2 COL6                FIXED DEC(15,7),
2 COL6_PAD            CHAR(8),
/* CHARACTER DATA TYPE WITH NULL INDICATOR */
2 COL7_NULL           BIN(15,0),
2 COL7                CHAR(10),
/* VARCHAR DATA TYPE WITH NULL INDICATOR */
2 COL8_NULL           BIN(15,0),
2 COL8,
    3 COL8_LEN         BIN(15,0),
    3 COL8_TEXT        CHAR(10),
/* DATE DATA TYPE WITH NULL INDICATOR */
2 COL9_NULL           BIN(15,0),
2 COL9                CHAR(10),
/* TIME DATA TYPE WITH NULL INDICATOR */
2 COL10_NULL          BIN(15,0),
2 COL10               CHAR(8),
/* TIMESTAMP DATA TYPE WITH NULL INDICATOR */
2 COL11_NULL          BIN(15,0),
2 COL11               CHAR(26),
/* ROWID DATA TYPE */
2 COL12,
    3 COL12_LEN        BIN(15,0),
    3 COL12_TEXT       CHAR(40);

```

The only difference between the first and second set of definitions is the addition of a 2-byte binary field immediately prior to the column definition for those columns that allow Db2® null values.

Related tasks

[Copying data to a VSAM or QSAM file on page 274](#)

[Using templates with non-Db2 data on page 75](#)

Related references

[Export Utility \("From"\) panel on page 673](#)

How do I export data using a copybook that describes a different data format to that used by the FM/Db2 Export Utility?

Scenario: I have data in a Db2® table. I want to export data using a copybook that I have defined, but the copybook describes a different data format to that used by the FM/Db2 Export Utility.

You need to code the copybook in either COBOL, HLASM, or PL/I. When you perform the export with the FM/Db2 Export Utility (3.7), enter the name of the data set that contains the copybook in the **To Copybook or Template** section on the Export "To" panel. Set the **Template usage** processing option to 1 (Above). If you specify 4 (Generate and save), your copybook will be overwritten. If you have renamed the fields in the copybook, or if data type conversions are required, use template re-mapping to map columns in the source table to fields in the target data set.

If the Db2® data contains one or more nullable columns, you are restricted in the processing for the Db2® null indicator. If you need the Db2® null indicator in the exported data, you *must* include a 2-byte binary field immediately after the definition for the field in the template that corresponds to the column.

For example, for a CHAR(10) field that allows for the Db2® null value, you would code:

```
* CHARACTER DATA TYPE
  10 COL7                PIC X(10).
  10 COL7-NULL          PIC S9(4) USAGE COMP.
```

In addition, the 2-byte field must be un-mapped when the export begins. In other words, you must not map a column of the table to this field using template re-mapping; if you do, the FM/Db2 Export Utility does not include the null indicator for the column in the exported data set.

If you want the Db2® null indicator mapped to a different position in the export data set, or you want the Db2® null indicator converted into a different data type, you can:

1. Export the data using either the default mapping, or using a user-defined copybook that includes fields defined for the Db2® null indicators as described above.
2. Create a template that describes the final data format.
3. Use the File Manager Base component to copy the data from the export data set into the final format. You may need to use REXX to convert the Db2® null indicators (and possibly other data values) as part of the copy process.

Related tasks

[Copying data to a VSAM or QSAM file on page 274](#)
[Using templates with non-Db2 data on page 75](#)

Related references

[Export Utility \("To"\) panel on page 676](#)

Chapter 9. Working with lists of Db2® objects

If you want to look at a group of Db2® objects, you can use the Object List utility (3.4) to list or print the objects in which you're interested.

You can use the Object List utility to specify:

- Whether you want the list of objects displayed or printed.
- The type of object you want listed or printed.
- Criteria to restrict the objects listed or printed.
- Options to apply when processing the listed objects.

To display the Object List Utility panel,

1. From the Primary Option Menu panel, enter **3** (Utilities) to display the Utility Functions panel.
2. From the Utility Functions panel, enter **4** (Object List)

Now that you have the Object List Utility panel displayed, you can start specifying the sorts of Db2® objects you want to display or print.



Note:

1. One of the options available at the time of installing FM/Db2 allows for views on Db2® catalog tables to be created for those tables accessed by FM/Db2. The set of views includes only those columns within the tables that are needed by FM/Db2.

If this option has been used at installation, it may affect the results obtained when you use the Object List utility. When FM/Db2 accesses a view, it shows only the columns of the view, rather than the columns of the table. If there are fewer columns in the view than the underlying table, the information displayed is incomplete.

2. The system option, **Show all catalog table columns**, affects which columns FM/Db2 displays when you use the Object List utility.

When you select this option, any display of catalog table information includes every available column, including any columns marked as "unused" or "internal use only" in the *DB2 for z/OS SQL Reference*.

The default for this option is not selected. Selecting this option overrides any settings for the **Show "unused" catalog table columns** and **Show "internal use only" catalog table columns** options.

Related tasks

[Working with object list panels on page 301](#)

[Displaying or printing a list of objects on page 298](#)

Related references

[Primary Option Menu panel on page 728](#)

[Object List Utility panel on page 719](#)

[Utility Functions panel on page 864](#)

[Editor Options \(3 of 8\) panel on page 634](#)

Displaying or printing a list of objects

To display or print a list of objects:

1. Specify object identification criteria to identify the objects you want listed:

Location

The location of the objects you want listed.

Leave this field blank if the objects you want listed are at your current location. Otherwise, type the full name of the remote location, an asterisk (*) to display all available remote locations, or a pattern using wildcard characters. If you specify an asterisk on its own or a pattern, FM/Db2 displays a selection list showing the locations that match the input specification.

To select the location you want, type against the required entry and press Enter.

Owner

The name of the person who created the Db2® object.

To select objects regardless of their owner, leave this field blank. Otherwise, to restrict the list of objects by owner, type either the full name of the owner or a pattern using wildcard characters. If this entry field is not blank, FM/Db2 limits the objects listed to those matching the owner selection criteria you specify.

Name

The name of the Db2® object.

To select objects regardless of their name, leave this field blank. Otherwise, to restrict the list of objects by name, type either the full name of the object or a pattern using wildcard characters. If this entry field is not blank, FM/Db2 limits the objects listed to those matching the name selection criteria you specify.

Database/collect/schema

The name of a database, a collection, or a schema. The name can be a full name or a pattern. This name is used to restrict the list of objects to only those objects that are in the specified database, collection, or schema. If you specify a pattern, the list of objects includes any objects that are included in a database or collection or schema whose name matches the pattern specification.

How FM/Db2 uses this field depends upon the type of object being listed as specified using the **Object Type** (see [step 3 on page 300](#)):

Object type

Field use

Database

Not allowed

Table space

Used as database name

Table, view, or alias

Used as database name

Index

Used as database name

Column

Used as database name

Synonym

Used as database name

Plan

Not allowed

Package

Used as collection name

Collection

Not allowed

DBRM

Not allowed

Schema

Used as schema name

Distinct type

Used as schema name

Function

Used as schema name

Stored procedure

Used as schema name

Trigger

Used as schema name

- Specify any additional selection criteria to further restrict the objects to be listed by coding a simple SQL SELECT "where clause" that specifies a column in the appropriate Db2® system catalog table.

Column

Name of column in the relevant Db2® system catalog table. To list the columns in the appropriate Db2® system catalog table, enter an asterisk (*).

Operator

A valid SQL operator.

Value

The value to be compared with the contents of the column.

For more information about SQL statements, see the *DB2 for z/OS SQL Reference*.

For example, to restrict a list of columns to only those columns with a data type of DATE, specify the following values:

Additional Selection Criteria:	
Column	COLTYPE_____ Enter * to list catalog columns
Operator	=_____
Value	'DATE'_____

- Nominate the type of object you want listed, and other options to apply to processing of the listed objects.

Object Type

Specify the type of Db2® object that you want listed. The numeric indicator for each object type is shown on the Object List Utility panel. This input field is mandatory, but defaults to "3" (Table/view/alias).

Confirm Db2® Object Drop

Indicates if you want FM/Db2 to display a confirmation panel each time you enter a DR(op) command against an object.

/

Display a confirmation panel if a DROP command is entered against an object. This is the default setting.

(blank)

If a DROP command is entered against an object, issue the command without displaying a confirmation panel.

- Specify if you want to display or print the list of objects:
 - To display a list of objects, leave the command line blank.
 - To print a list of objects, enter P on the command line.
- Press Enter.

FM/Db2 displays or prints the object list panel for the type of object you have specified.

Related tasks

Using an asterisk (*) or a pattern in entry fields on page 49

Related references

Remote Db2 Location Selection panel on page 759

Working with object list panels

After you have completed the necessary steps to display a list of objects, FM/Db2 displays the object list panel for the corresponding object type.

The following pages describe the features that are common to all object list panels.

Figure 67: Layout of a typical object list panel on page 301 shows the areas of a typical object list panel.

Figure 67. Layout of a typical object list panel

Process Options Utilities Help ①									
FM/Db2 (DFG2) Databases									
Location: Format TABL									
SEL	DATABASE NAME	DATABASE CREATOR	STORAGE GROUP NAME	BUFFER POOL NAME	INTERNAL DATABASE IDENTIFIER	AUTHID THAT CREATED	TYPE OF DATABASE		
*	*	*	*	*	*	*	*	*	*
----	#1-----	#2-----	#3-----	1- #4-----	-----	#5 #7-----	#20-----	②	
**** Top of data ****									
⑤	ABC	SHRIKE2	DDDDDDDDDD	BP0		270 SHRIKE2			
	DSN8D81A	CJUNELL	DSN8G810	BP0		259 CJUNELL			
	DSN8D81P	CJUNELL	DSN8G810	BP0		260 CJUNELL			
	DSNATPDB	CJUNELL	SYSDEFLT	BP0		257 CJUNELL			
	DSNDB04	SYSIBM	SYSDEFLT	BP0		4 SYSIBM			
	DSNDB06	SYSIBM				6 SYSIBM			
	DSNDB07	CJUNELL	SYSDEFLT	BP0		7 CJUNELL		WORKFILE	
	DSNRGFDB	CJUNELL	SYSDEFLT	BP0		258 CJUNELL			
	DSNRLST	CJUNELL	SYSDEFLT	BP0		256 CJUNELL			
	JLV3D81A	SHRIKES	JLV3G810	BP0		266 SHRIKES			
	JLV3D81P	SHRIKES	JLV3G810	BP0		267 SHRIKES			
	JOHND81P	SHRIKES	JOHNG810	BP0		265 SHRIKES			
	KPS8D81A	SHRIKES	KPS8G810	BP0		268 SHRIKES			
	KPS8D81P	SHRIKES	KPS8G810	BP0		269 SHRIKES			
	KPSAD81A	SHRIKES	KPSAG810	BP0		262 SHRIKES			
	KPSAD81P	SHRIKES	KPSAG810	BP0		263 SHRIKES			
	RFM0133	SHRIKES	SYSDEFLT	BP0		261 SHRIKES			
**** End of data **** ⑥									
Command ==> ⑦									
F1=Help		F2=Zoom		F3=Exit		F4=CRetriev		F5=RFind	
F7=Up		F8=Down		F9=Swap		F10=Left		F11=Right	
								Scroll PAGE	
								F6=RChange	
								F12=Cancel	

①

Action bar. The action bar choices for the object list panels function.

②

Column heading lines. Shows the name of the column of data shown below. A plus sign (“+”), minus sign (“-”), or both (“+”) indicates that the column is scrollable and may contain more data than is currently displayed.

③

Filter line. This is where you can specify a filter string for one or more columns to limit the information FM/Db2 displays.

4

Operator line. This is where you can specify an operator for one or more columns to work in conjunction with the corresponding filter pattern.

5

Line command area.

6

End of data marker. This marker line indicates the end of the data returned from FM/Db2.

7

Command line. On this line you can specify any Db2® command, ISPF command, or FM/Db2 primary command.

Related tasks

[Displaying or printing a list of objects on page 298](#)

[Working with scrollable display fields on page 42](#)

[Limiting the data displayed on page 302](#)

[Using the line command area \(Cmd\) on page 308](#)

[Sorting the displayed data on page 316](#)

Related references

[Collections panel on page 471](#)

[Columns panel on page 491](#)

[Databases panel on page 593](#)

[Database Request Modules panel on page 591](#)

[Distinct Types panel on page 619](#)

[Functions panel on page 684](#)

[Indexes panel on page 697](#)

[Application Packages panel on page 460](#)

[Application Plans panel on page 463](#)

[Schemas panel on page 779](#)

[Stored Procedures panel on page 813](#)

[Synonyms panel on page 815](#)

[Tables, Views and Aliases panel on page 843](#)

[Table Spaces panel on page 834](#)

[Triggers panel on page 853](#)

Limiting the data displayed

You can limit the data that FM/Db2 displays by “*filtering out*” the data you do not want displayed.

To filter the data, use:

- The *filter line* to specify a filter pattern for one or more columns
- And, optionally, the *operator line* to specify an operator to work in conjunction with the corresponding filter pattern.

Using the filter line

On the filter line, the asterisk (*) under a column heading marks an area where you can enter a filter pattern to limit the data displayed. You can specify filter patterns for more than one column if necessary.

For alphanumeric columns, the asterisk is displayed in the leftmost position. For numeric columns, the asterisk is displayed in the rightmost position.

In the filter pattern area, use:

- An asterisk (*) on its own to match all values, or
- A filter pattern using wildcard characters to select only those objects that match the pattern.

You can specify a filter pattern using any of the following special characters:

asterisk (*)

Represents a string of zero or more characters. Acts the same as a percent sign (%).

percent sign (%)

Represents a string of zero or more characters. Acts the same as an asterisk (*).

underscore (_)

Represents any single character, excluding a trailing blank.

When you specify a filter pattern for a column, FM/Db2 only selects objects where the contents of that column match the specified filter pattern.



Note: If you have also specified an operator (on the operator line) for the column, FM/Db2 uses the operator in conjunction with the filter pattern to match objects (see following section).

For alphanumeric columns, FM/Db2 matches the filter pattern you enter with the *leading* characters of the contents of the column for each row. That is, the filter pattern DEF matches 'DEF' and 'DEFG', but not 'CDEF'.

For numeric columns, FM/Db2 matches the filter pattern you enter with the *value* of the contents of the column for each row. That is, the search argument 7 matches columns containing 7 but not, for example, 70 or 17.

The following examples show how you can use filter patterns to limit the data FM/Db2 displays. (In the examples shown, it is assumed no operator has been specified in the corresponding area on the operator line.)

Pattern filter

Selects objects where column contains...

*

Any alphanumeric string

ABC*

Any alphanumeric string starting with "ABC"

ABC

Any alphanumeric string containing the string "ABC"

A_C

Any four-character alphanumeric string where the first character is "A" and the last character is "C"

%BC_

Any alphanumeric string containing the string "BC" followed by one more character

123

For numeric columns: the value 123

23

For numeric columns: the value 23

Using the operator line

You use the operator line to specify an operator that FM/Db2 uses in conjunction with the filter pattern specified in the corresponding area on the filter line. You can specify operators for more than one column if necessary. Normally, you only specify an operator for a column where you have also specified a filter pattern.

To enter an operator in the operator line, type the required operator anywhere within the operator area for the required column. Processing occurs left to right. FM/Db2 only recognizes the first operator encountered and any other characters entered in the operator field are ignored. For example, if you type "=>" in the operator field, FM/Db2 treats it as "=", and ignores the ">".

To remove an operator, overwrite the operator with a space.

You can use any of the following operators:

Blank

Means "like". Any *, %, or _ characters in the corresponding filter pattern are treated as special characters. A match occurs if the filter pattern matches the data after considering any special characters.

! (or) -

Means "not like". Any *, %, or _ characters in the corresponding filter pattern are treated as special characters. A match occurs if the filter pattern does not match the data after considering any special characters.

=

Means "equals". For numeric data types, special characters in the corresponding filter pattern are not allowed. For non-numeric data types, *, %, and _ characters are allowed but are not treated as special characters. *, %, and _ characters match themselves only.

!=, -=, (or) <>

Means “*not equals*”. For numeric data types, special characters in the corresponding filter pattern are not allowed. For non-numeric data types, *, %, and _ characters are allowed but are not treated as special characters. *, %, and _ characters match themselves only.

<

Means “*less than*”. For numeric data types, special characters in the corresponding filter pattern are not allowed. For non-numeric data types, *, %, and _ characters are allowed but are not treated as special characters. *, %, and _ characters match themselves only.

<=, !>, (or) ->

Means “*less than or equal to*”. For numeric data types, special characters in the corresponding filter pattern are not allowed. For non-numeric data types, *, %, and _ characters are allowed but are not treated as special characters. *, %, and _ characters match themselves only.

>=, !<, (or) -<

Means “*greater than or equal to*”. For numeric data types, special characters in the corresponding filter pattern are not allowed. For non-numeric data types, *, %, and _ characters are allowed but are not treated as special characters. *, %, and _ characters match themselves only.

>

Means “*greater than*”. For numeric data types, special characters in the corresponding filter pattern are not allowed. For non-numeric data types, *, %, and _ characters are allowed but are not treated as special characters. *, %, and _ characters match themselves only.

You can also enter the following commands in the operator field for a column:

X

Excludes the column from the data display. The effect is the same as editing the template and de-selecting the column, followed by a re-display of the data.

W*

Resets the display width for the column to the maximum value for the column. The command is only effective when entered against a column that has a non-numeric data type.

Wnnn

Sets the display width for the column to *nnn* (*nnn* must be an integer between 6 and the maximum possible display width for the column). The command is only effective when entered against a column that has a non-numeric data type.

When you specify an operator for a column, FM/Db2 first applies the operator to the corresponding filter pattern and then only selects objects where the contents of that column match the resultant filter pattern.

The following examples show how you can use operators, in conjunction with filter patterns, to limit the data FM/Db2 displays.

Pattern filter (operator)

Selects objects where column...

ABC* (blank)

Contains any alphanumeric string starting with "ABC"

ABC* (=)

Contains the string "ABC*"

ABC* (-)

Does not contain the string "ABC*"

A (>)

Contains an alphanumeric string whose first character is greater than "A"

A_C (->)

Contains an alphanumeric string whose first three characters are less than or equal to the string "A_C"

123 (=)

For numeric columns: contains the value 123

23 (<)

For numeric columns: contains a value less than 23

Let's take an example. [Figure 67: Layout of a typical object list panel on page 301](#) shows a list of database object types. To limit the columns displayed to those where:

- The database creator is SHRIKES
- The storage group name starts with the letter K
- The internal database identifier is greater than 264

Enter the following filter patterns and operators:

1. Under the column heading DATABASE CREATOR, type `SHRIKES` on the filter line.
2. Under the column heading STORAGE GROUP NAME, type `K*` on the filter line.
3. Under the column heading INTERNAL DATABASE IDENTIFIER, type `264` on the filter line and type `>` on the operator line.

Figure 68. Object list: databases

Process Options Utilities Help							
FM/Db2 (DFG2) Databases							
Location:							
SEL	DATABASE NAME	DATABASE CREATOR	STORAGE GROUP NAME	BUFFER POOL NAME	INTERNAL DATABASE IDENTIFIER	AUTHID THAT CREATED	Format TYPE OF DATABASE
	*	SHRIKES	K*	*	264	*	*
----	#1-----	#2-----	#3-----1-	#4-----	>---	#7-----	#20-+---
****	Top of data ****						
----	ABC	SHRIKE2	DDDDDDDDDD	BP0		270 SHRIKE2	
----	DSN8D81A	CJUNELL	DSN8G810	BP0		259 CJUNELL	
----	DSN8D81P	CJUNELL	DSN8G810	BP0		260 CJUNELL	
----	DSNATPDB	CJUNELL	SYSDEFLT	BP0		257 CJUNELL	
----	DSNDB04	SYSIBM	SYSDEFLT	BP0		4 SYSIBM	
----	DSNDB06	SYSIBM				6 SYSIBM	
----	DSNDB07	CJUNELL	SYSDEFLT	BP0		7 CJUNELL	WORKFILE
----	DSNRGFDB	CJUNELL	SYSDEFLT	BP0		258 CJUNELL	
----	DSNRLST	CJUNELL	SYSDEFLT	BP0		256 CJUNELL	
----	JLV3D81A	SHRIKES	JLV3G810	BP0		266 SHRIKES	
----	JLV3D81P	SHRIKES	JLV3G810	BP0		267 SHRIKES	
----	JOHND81P	SHRIKES	JOHNG810	BP0		265 SHRIKES	
----	KPS8D81A	SHRIKES	KPS8G810	BP0		268 SHRIKES	
----	KPS8D81P	SHRIKES	KPS8G810	BP0		269 SHRIKES	
----	KPSAD81A	SHRIKES	KPSAG810	BP0		262 SHRIKES	
----	KPSAD81P	SHRIKES	KPSAG810	BP0		263 SHRIKES	
----	RFM0133	SHRIKES	SYSDEFLT	BP0		261 SHRIKES	
****	End of data ****						
Command ==>							
F1=Help	F2=Zoom	F3=Exit	F4=CRetriev	F5=RFind	Scroll PAGE		
F7=Up	F8=Down	F9=Swap	F10=Left	F11=Right	F6=RChange F12=Cancel		

4. Press Enter. A list of database object types is displayed, restricted to the search criteria you specified:

Figure 69. Object List: databases (list restricted using filter patterns and operators)

Process Options Utilities Help							
FM/Db2 (DFG2) Databases							
Location:							
SEL	DATABASE NAME	DATABASE CREATOR	STORAGE GROUP NAME	BUFFER POOL NAME	INTERNAL DATABASE IDENTIFIER	AUTHID THAT CREATED	Format TYPE OF DATABASE
	*	SHRIKES	K*	*	264	*	*
----	#1-----	#2-----	#3-----1-	#4-----	>---	#5	#7----- #20-+---
****	Top of data ****						
----	KPS8D81A	SHRIKES	KPS8G810	BP0		268 SHRIKES	
----	KPS8D81P	SHRIKES	KPS8G810	BP0		269 SHRIKES	
****	End of data ****						
Command ==>							
F1=Help	F2=Zoom	F3=Exit	F4=CRetriev	F5=RFind	Scroll PAGE		
F7=Up	F8=Down	F9=Swap	F10=Left	F11=Right	F6=RChange F12=Cancel		

Locating a row or column in a list of Db2® objects

When you display data with the Object List utility, you can use the LOCATE primary command to locate either a row or a column in a similar way to when you are viewing data with FM/Db2 View or Edit.

Related references

[Locating a row on page 138](#)

[Locating a column on page 139](#)

[LOCATE primary command on page 918](#)

Finding a string in a list of Db2® objects

When you display data with the Object List utility, you can use the FIND primary command to find a specific string in a similar way to when you are viewing data with FM/Db2 View or Edit.

Related references

[Finding a string on page 142](#)

[FIND primary command on page 897](#)

Using the line command area (Cmd)

In the line command area (under the heading **Cmd**) for a listed object, you can enter a line command or one of the general line commands (?, =, or ROW).

Line command

[Table 22: Object list line commands on page 308](#) shows the line commands you can use with each type of object.

Table 22. Object list line commands

Command	Description	Database	Table space	Table/View	Index	Column	Synonym	Plan	Package	Collection	DBRM	Schema	Distinct Type	Function	Procedure	Trigger	Storage Group	Sequence
A	Alter an object.	Y	Y	Y	Y									Y	Y			
ADD	Add table check constraint.			Y ¹⁵														
ALS	Show aliases of an object.			Y														
AT	Show auxiliary tables for LOB columns.			Y		Y												
B	Browse the object.			Y			Y ¹⁶				Y							
BI	Bind the object.							Y	Y									
BT	Show base table for auxiliary table.			Y														
C	Copy table.			Y			Y ¹⁶											

15. Only available from a list of table constraints.

16. The synonym name is copied to the function panel if the location is unspecified and the owner is the SQLID; otherwise, the synonym name is resolved and the resolved name is copied.

Table 22. Object list line commands

(continued)

Command	Description	Database	Table space	Table/View	Index	Column	Synonym	Plan	Package	Collection	DBRM	Schema	Distinct Type	Function	Procedure	Trigger	Storage Group	Sequence
CBI	Copy and bind the object.								Y									
CDI	Show column distribution statistics (as generated by RUNSTATS).			Y														
CH	Show child (dependent) tables.			Y														
CHR	Show child relationships (referential constraints).			Y														
CK	Show information about table check constraints.			Y														
COL	Show the columns for the object.			Y	Y	Y ¹⁷												
COM	Comment on an object.			Y		Y							Y	Y	Y	Y		
CR	Create an object like this object.	Y	Y	Y	Y		Y						Y	Y	Y	Y	Y	Y
CRA	Create an alias for an object.			Y			Y											
CRS	Create a table space in the database.	Y																
CRT	Create a table in the table space.		Y															
CRX	Create an index.			Y														
CS	Describe the columns for an object (abbreviation of information provided by COL command).			Y														
D	Show the database for an object.	Y ¹⁷	Y	Y	Y												Y	

17. Only available from a list of object privileges.

Table 22. Object list line commands

(continued)

Command	Description	Database	Table space	Table/View	Index	Column	Synonym	Plan	Package	Collection	DBRM	Schema	Distinct Type	Function	Procedure	Trigger	Storage Group	Sequence
DEP	Show the dependencies on an object.			Y ¹⁵				Y	Y									Y
DI	Display distribution statistics of a column.					Y												
DR	Drop the object/constraint.	Y	Y	Y	Y		Y						Y	Y	Y	Y	Y	Y
DS	Display the database structure.	Y	Y															
DT	Show the source data type (columns) or distinct types (schemas).					Y						Y						
E	Edit the object.			Y			Y ¹⁶											
EDC	Show enabled/disabled connections.							Y	Y									
F	Show functions.											Y						
FC	Show the foreign key From Column.			Y ¹⁸														
FK	Show information about the referential integrity defined for foreign keys.			Y														
FRE	Free the object.							Y	Y									
G	Grant privileges for the object.	Y	Y	Y		Y		Y	Y	Y			Y	Y	Y		Y	Y
GEN	Generate SQL for object from Db2® catalog.	Y	Y	Y	Y							Y	Y	Y	Y			
H	Show the homonyms (like-named objects) for the object.					Y												
I	Show detailed information about the object.	Y	Y	Y	Y	Y	Y	Y	Y		Y		Y	Y	Y	Y		

18. Only available from a list of foreign keys.

Table 22. Object list line commands

(continued)

Command	Description	Database	Table space	Table/View	Index	Column	Synonym	Plan	Package	Collection	DBRM	Schema	Distinct Type	Function	Procedure	Trigger	Storage Group	Sequence
ICS	Show the status of image copies for the object.	Y	Y		Y													
L	Show the collection for the object or, for tables, show the rows of this table.									Y ¹⁷								
LAB	Label the object.			Y		Y												
LC	Show LISTCAT information for the data set.	Y ¹⁹	Y ¹⁹															
LPT	List the PLAN_TABLE table for the object.							Y	Y									
M	Show the DBRMs for the object.							Y										
O	Show related stored procedures.											Y						
P	Display information about the privileges for this object.	Y	Y	Y		Y		Y	Y	Y		Y	Y	Y	Y		Y	
PA	Show parent tables.			Y														
PAR	Show parent relations (referential constraints).			Y														
PARM	Show the routine parameters.													Y	Y			
PC	Show the column privileges for this object.			Y ¹⁷														
PK	Show the primary key for this table.			Y														
PKG	Show the packages for the object.			Y	Y			Y	Y ¹⁷	Y				Y	Y	Y		

19. Only available from a list of image copies.

Table 22. Object list line commands

(continued)

Command	Description	Database	Table space	Table/View	Index	Column	Synonym	Plan	Package	Collection	DBRM	Schema	Distinct Type	Function	Procedure	Trigger	Storage Group	Sequence
PKL	Show the package lists for the object.							Y	Y	Y								
PL	Show the plans for the object.			Y	Y			Y ¹⁷	Y	Y	Y							
PR	Print table.			Y			Y ¹⁶											
PS	Display information about the privileges for the schema for this object.												Y	Y	Y	Y		
PST	Show partition statistics.			Y		Y												
PT	Show the parts of the object.		Y		Y												Y	
R	Revoke the privilege for this object. ¹⁷	Y	Y	Y				Y	Y	Y		Y	Y	Y	Y			
RBI	Rebind the object.							Y	Y									
RDT	Return data type.													Y				
ROW	Show all the columns in (or /) this row of the result table.	Y	Y	Y	Y	Y	Y	Y	Y	Y	Y	Y	Y	Y	Y	Y	Y	Y
RT	Recover TOCOPY.	Y ¹⁹	Y ¹⁹															
S	Show the table spaces for the object.	Y	Y ¹⁷	Y				Y	Y								Y	
SCH	Show the schema the object.											Y ¹⁷	Y	Y	Y ¹⁷	Y		
SEL	Build SQL SELECT statement for this object.			Y			Y ¹⁶											
SEQ	Show identity column information.					Y												
SQL	Show the SQL statements in the object.							Y	Y	Y	Y					Y		
SYN	Show the synonyms for the object.			Y				Y	Y									

Table 22. Object list line commands

(continued)

Command	Description	Database	Table space	Table/View	Index	Column	Synonym	Plan	Package	Collection	DBRM	Schema	Distinct Type	Function	Procedure	Trigger	Storage Group	Sequence
T	Show the tables for the object.	Y	Y	Y ²⁰	Y	Y	Y	Y	Y				Y			Y		
TC	Show the foreign key To Column.			Y ¹⁸														
TR	Show triggers.			Y								Y						
UTL	Run a Db2® utility job against the object.		Y	Y	Y		Y ¹⁶											
V	View the object.			Y			Y ¹⁶											
VER	Show the versions of the object.								Y									
VOL	Show volumes.															Y	Y	
VS	Show how the view was created.			Y ²¹														
VW	Show views.			Y			Y											
X	Show the indexes for the object.	Y		Y		Y		Y	Y								Y	
XC	Show the indexes and index columns for the object.			Y														
XPT	Show index parts.															Y	Y	

Related tasks

[Line command query \(?\) on page 314](#)

[Equal \(=\) on page 314](#)

[ROW on page 315](#)

20. Only available when the object is a view or an alias, or from a list of object privileges.

21. Only available when the object is a view.

Line command query (?)

If you enter ? in the line command area, FM/Db2 displays a list of the line commands you can enter for this object type.

Figure 70: Using the ? line command to display a list of valid line commands on page 314 shows an example of a list of valid line commands (in this case, for a synonym object type).

Figure 70. Using the ? line command to display a list of valid line commands

```

  Process  Options  Utilities  Help
  FM/Db2 (DFG2) ----- Object List Line Commands ----- Row 1 to 6 of 6
  Type S against the required line command and press Enter.
  Sel Command  Description
  -   B         Browse table
  -   C         Copy table
  -   CR        Create a synonym
  -   CRA       Create an alias
  -   DR        Drop synonym
  -   E         Edit table
  -   I         Details about synonym
  -   PR        Print table
  -   ROW       Show all columns for this row
  -   SEL       Build a SELECT statement
  -   T         Show tables
  -   UTL       Utility functions
  Command ==>  ----- Scroll PAGE
  F1=Help      F2=Split    F3=Exit     F4=CRetriev F7=Backward F8=Forward
  F9=Swap      F10=Actions F12=Cancel
  
```

To select a command from the list of valid commands, enter **s** in the **Sel** column.

Related references

[Object List Line Commands panel on page 714](#)

[Table 22: Object list line commands on page 308](#)

Equal (=)

If you enter = in the line command area, FM/Db2 runs the previous line command.

Figure 71: Using the equal (=) line command on page 315 shows the use of the = line command. The previous line command that FM/Db2 ran was DS (to display the structure of the data base DSNRLST). The asterisk is displayed in the first position of the line command area after FM/Db2 has run the command and you have returned to the original panel. If you enter = in the line command area for another listed object (in this case, the data base FMN2), FM/Db2 runs the DS command for that object.

Figure 71. Using the equal (=) line command

```

Process  Options  Utilities  Help
-----
FM/Db2 (DFG2)                Databases                Row 1 to 10 of 63

Location:

Cmd      Name      Owner  +  Storage  Buffer  Created  Index
*  ----- *  ----- *  ----- *  ----- *  -----
----- DSNDB04  SYSIBM  SYSDEFLT  BP0      4  SYSIBM      BP0
----- DSNDB06  SYSIBM  SYSDEFLT  BP0      6  SYSIBM      E  BP0
----- DSNDB07  FMNUSER  SYSDEFLT  BP0      7  FMNUSER  W  BP0
*S  ----- DSNRLST  FMNUSER  SYSDEFLT  BP0     256  FMNUSER      E  BP0
----- DSNRGFDB  FMNUSER  SYSDEFLT  BP0     257  FMNUSER      E  BP0
=  ----- FMN2     FMNUSER  SG01      BP0     258  FMNUSER      E  BP0
----- FMDB2     FMNUSER  SYSDEFLT  BP0     259  FMNUSER      E  BP0
----- DSN8D61P  BRADB   DSN8G610  BP0     261  BRADB       E  BP0
----- DSN8D61A  BRADB   DSN8G610  BP0     260  BRADB       E  BP0
----- DSN8D61L  BRADB   DSN8G610  BP0     262  BRADB       E  BP0

Command ==>> ----- Scroll PAGE
F1=Help      F2=Split    F3=Exit    F4=Expand  F7=Backward  F8=Forward
F9=Swap      F10=Left   F11=Right  F12=Cancel

```

If you enter the “=” line command multiple times, as shown in [Figure 72: Using the equal \(=\) line command multiple times on page 315](#), FM/Db2 runs the line command (in this case, DS) consecutively for each of the nominated objects in the list without returning to the original panel between each execution.

Figure 72. Using the equal (=) line command multiple times

```

Process  Options  Utilities  Help
-----
FM/Db2 (DFG2)                Databases                Row 1 to 10 of 63

Location:

Cmd      Name      Owner  +  Storage  Buffer  Created  Index
*  ----- *  ----- *  ----- *  ----- *  -----
----- DSNDB04  SYSIBM  SYSDEFLT  BP0      4  SYSIBM      BP0
----- DSNDB06  SYSIBM  SYSDEFLT  BP0      6  SYSIBM      E  BP0
----- DSNDB07  FMNUSER  SYSDEFLT  BP0      7  FMNUSER  W  BP0
*S  ----- DSNRLST  FMNUSER  SYSDEFLT  BP0     256  FMNUSER      E  BP0
----- DSNRGFDB  FMNUSER  SYSDEFLT  BP0     257  FMNUSER      E  BP0
=  ----- FMN2     FMNUSER  SG01      BP0     258  FMNUSER      E  BP0
----- FMDB2     FMNUSER  SYSDEFLT  BP0     259  FMNUSER      E  BP0
=  ----- DSN8D61P  BRADB   DSN8G610  BP0     261  BRADB       E  BP0
=  ----- DSN8D61A  BRADB   DSN8G610  BP0     260  BRADB       E  BP0
----- DSN8D61L  BRADB   DSN8G610  BP0     262  BRADB       E  BP0

Command ==>> ----- Scroll PAGE
F1=Help      F2=Split    F3=Exit    F4=Expand  F7=Backward  F8=Forward
F9=Swap      F10=Left   F11=Right  F12=Cancel

```

ROW

If you enter `ROW` in the line command area, FM/Db2 displays the column name (and its value) as held in the Db2® catalog table for each column of the specified object,

You can enter more than one ROW line command at a time.

[Figure 73: Using the ROW line command on page 316](#) shows the use of the ROW line command, placed in the line command area for the synonym object TCONA.

Figure 73. Using the ROW line command

```

Process  Options  Utilities  Help
-----
FM/Db2 (DFG2)                               Synonyms                               Row 1 to 11 of 36

Location:

Cmd  Synonym      + Owner  + Table/View Name  + Owner  +      Created
*-----*-----*-----*-----*-----*-----*-----
----- DEPT      HARFOUJ  DEPT              DSN8810  HARFOUJ
----- DEPT      KIEFERA  DEPT              DSN8810  KIEFERA
----- SDEPT     KIEFERA  DEPT              DSN8810  KIEFERA
----- VPSTRDE1   BRADB    VPSTRDE1         FMDB2    BRADB
----- VPSTRDE2   BRADB    VPSTRDE2         FMDB2    BRADB
----- VASTRDE1   BRADB    VASTRDE1         FMDB2    BRADB
----- EMP      BRADB    EMP              FMDB2    BRADB
----- VPHONE   BRADB    VPHONE          FMDB2    BRADB
ROW__ TCONA      BRADB    TCONA            FMDB2    BRADB
----- DEPT      BRADB    DEPT             FMDB2    BRADB
----- VDEPT     BRADB    VDEPT           FMDB2    BRADB

Command ==>> ----- Scroll PAGE
F1=Help      F2=Split    F3=Exit      F4=Expand   F7=Backward F8=Forward
F9=Swap      F10=Left   F11=Right   F12=Cancel
    
```

Figure 74: Result of using the ROW line command on page 316 shows the result. In this case, the column names are from the Db2® catalog table, SYSSYNONYMS.

Figure 74. Result of using the ROW line command

```

Process  Options  Utilities  Help
-----
FM/Db2 (DFG2)                               Display Row                               Row 1 to 7 of 7

Column Name      Column Value
*-----*-----*
NAME             TCONA
CREATOR          BRADB
TBNAME          TCONA
TBCREATOR       FMDB2
IBMREQD         N
CREATEDBY       BRADB
CREATEDTS       2001-05-02-10.01.58.268038
***** END OF Db2 DATA *****

Command ==>> ----- Scroll PAGE
F1=Help      F2=Split    F3=Exit      F4=Expand   F7=Backward F8=Forward
F9=Swap      F10=Left   F11=Right   F12=Cancel
    
```

You can limit the number of entries shown on the panel by entering search criteria in the areas marked by an asterisk (*) immediately below the headings.

Related tasks

[Limiting the data displayed on page 302](#)

Sorting the displayed data

Use the SORT primary command to sort a column in the current object list.

To sort one column (in ascending sequence):

1. Type `sort` on the command line.
2. Place the cursor within the column you want to sort.
3. Press Enter.

FM/Db2 sorts the column in ascending sequence.

To sort multiple columns, in ascending or descending sequence:

1. Type `sort` on the command line.
2. Ensure the cursor is not positioned within any column.
3. Press Enter:

FM/Db2 displays the Sort Fields panel.

You can limit the number of entries shown on the panel by entering search criteria in the areas marked by an asterisk (*) immediately below the headings.

Related tasks

[Limiting the data displayed on page 302](#)

Related references

[Sort Fields panel on page 804](#)

[SORT primary command on page 941](#)

Reverse engineering

Reverse engineering lets you reverse engineer the Db2® objects in your database catalog.

Reverse engineering generates the SQL statements necessary to re-create a Db2® object.

Use the GEN line command on the corresponding object list panel to reverse engineer any of the following objects:

- Database
- Table space
- Table or view
- Index
- Schema
- Distinct type
- Function
- Stored procedure



Note: The GEN line command applies to objects at the current server only. If you enter the GEN line command against an object at a remote location, the location information is discarded when the Generate SQL From Db2® Catalog panel is displayed.

To generate DDL for objects at a remote location, first connect to that location, then use the GEN line command.

Figure 75: GEN line command entered on Databases object list panel on page 318 shows the GEN line command entered on a database object list panel:

Figure 75. GEN line command entered on Databases object list panel

```

Process  Options  Utilities  Help
-----
FM/Db2 (DFG2)          Databases          Row 51 to 54 of 54
Location:

Cmd  Name      Owner      Storage  Buffer   Created      Index
     *      *          Group    Pool    DBID By      + T E Pool
-----*-----*-----*-----*-----*-----*-----*-----*
CONVDB4 OSPEED  SYSDEFLT  BP0      302 OSPEED  E BP0
GEN__ JOHNLEDP SIROED   JOHNLEG0 BP0      304 SIROED  E BP0
----- GPCOPYL  GRAHAMP  GRAHAMP0 BP0      276 GRAHAMP  E BP0
----- UTILBIG1 OSPEED  DB2BIG   BP0      306 OSPEED  E BP0
***** END OF Db2 DATA *****

Command ==>
F1=Help      F2=Split    F3=Exit     F4=Expand   F7=Backward F8=Forward
F9=Swap      F10=Left   F11=Right   F12=Cancel
    
```

Typical uses for reverse engineering include:

- Extracting the DDL for an object before changes are made, so that the changes are applied to the current definition and are available for fallback purposes.
- Move Db2® objects to another Db2® subsystem. By using reverse engineering (together with the Db2® table unload and load facilities), objects can be moved after a few manual modifications to the generated SQL and batch jobs.

When extracting database, table space, and table objects, all dependent objects can also be generated; this includes table spaces, tables, indexes, views, synonyms, aliases, referential constraints, table checks, and table triggers. When extracting objects in schemas, reverse engineering can extract the dependent distinct types, functions, and stored procedures. All authorizations to these objects can also be generated.

You can generate the SQL statements using a batch or online job. If you are using FM/Db2 to extract several objects from a large catalog, batch jobs are recommended.

If you use the GEN line command, FM/Db2 displays the Generate SQL From Db2® Catalog panel.

On the Generate SQL From Db2® Catalog panel, you can:

- As an option, specify new values for the :
 - Storage group (possibly using a different storage group for table spaces and index spaces).
 - Database.
 - Specify a new object owner. If specified, the new owner is used whenever an object is created.
 - Specify a new schema name (where applicable). If specified, the new schema is used whenever an object is created.
 - Specify the data set in which FM/Db2 places the generated SQL.
 - Specify whether the SQL generation runs as a batch or online job.
 - Specify how often reverse engineering adds an SQL COMMIT statement to the generated SQL.
 - Specify whether Db2® default parameters are removed or kept in the generated SQL.

If you specify an execution mode of BATCH, FM/Db2 generates a batch job and displays the job in an ISPF Edit session, ready for any modifications you need to make before submitting the job for execution. If you specify TSO, FM/Db2 generates the SQL statements online and displays the results.

Related tasks

[Performance tips on page 319](#)

Related references

[Generate SQL From Db2 Catalog panel on page 686](#)

Performance tips

To improve performance of the extract program, consider adding the following indexes to the Db2® catalog:

On SYSDBAUTH

(database,(grantor,grantee))

On SYSCHECKS

(towner,tbname)

On SYSRELS

(creator,tbname,relname)

On SYSRESAUTH

(qualifier,name,(grantor,grantee,obtype))

On SYSTABAUTH

(tcreator,tname,(grantor,grantee,granteetype))

On SYSCOLAUTH

(creator,tname,(dategranted,timegranted))

The recommended mode of operation is batch, even if only a few objects are requested. This is because the design process is based on the standard Db2® catalog indexes, which means that some parts of the process scan the catalog tables instead of doing a direct reference.

Considerations

The following considerations apply to reverse engineering:

- FM/Db2 does not extract IDCAMS DEFINE CLUSTER statements for VCAT-defined table spaces and indexes.
- The generated SQL for table spaces and indexes defined with a DSETPASS (password) contains a SPUFI comment line such as:

```
-- DSETPASS XXXXXXXX
```

FM/Db2 does not reveal the data set password in the catalog; FM/Db2 generates the comment line and issues a warning.

- The ability to generate actually allocated or actually used space allocations depends on information in the Db2® catalog. The actual data set sizes for table spaces or index spaces are not retrieved. Only use these options if you have recently run STOSPACE and RUNSTATS for the selected objects.

Chapter 10. Printing

FM/Db2 provides various utilities that allow you to print or view printed output:

- To print the contents of a Db2® table or view, use the Print utility function (3.1).
- To browse, and optionally purge, the print output from your current FM/Db2 editor session held in the print data set, use the Print Browse utility function (3.11).
- To print an audit trail report using the contents of the audit trail data set, use the Audit trail utility function (3.10).

Each of these utilities is described in the remainder of this chapter.

Related tasks

[Printing the contents of a Db2 table on page 321](#)

[Looking at the print output from your FM/Db2 session on page 326](#)

[Printing an audit trail report on page 328](#)

Printing the contents of a Db2® table

To print the contents of a Db2® table or view, use the Print utility function (3.1).

When you print data, you can:

- Select which rows to print.
- Select which columns to print and the order in which they are arranged on the listing.
- Print Db2® tables or views with columns formatted according to column data type.
- Provide customized column headings.
- Limit the number of rows printed:

Limit the print

You can limit the number of rows that are printed by specifying the number of rows to print.

To print all the rows of the Db2® object, specify 0 (zero) or ALL.

Select rows

You can select the rows you want to print by specifying *row selection criteria*.

To display the Print Utility panel,

1. From the Primary Option Menu panel, enter 3 (Utilities) to display the Utility Functions panel.
2. From the Utility Functions panel, enter 1 (Print)

Now that you have the Print Utility panel displayed, you can specify the name of the Db2® table or view you want to print, how many rows you want to print, and other options to control how the data is printed.

When you have finished specifying these details, press Enter.

If you selected **Edit options** (either by using a "/", or by having previously used the "A" selection character for this option), before printing the data, the Print Utility Options panel is displayed.

If you selected **Edit template** (either by using a "/", or by having previously used the "A" selection character for this option), before printing the data, the Column Selection/Edit panel is displayed.

If you selected **Batch execution** (either by using a "/", or by having previously used the "A" selection character for this option), the generated JCL is displayed using the ISPF editor, where you can review the JCL and submit the job for batch processing.

Otherwise (if you selected none of the preceding options), FM/Db2 prints the data.

Formatting the print output

Formatting of the print output is controlled by the following:

Settings: Print settings (option 0.0.1)

Several processing options, that you can specify using the Set Print Processing Options panel, affect the printed output:

Output destination

Where you want the printed output sent:

SYSPRINT

Send print output to the current SYSPRINT allocation.

Typically, SYSPRINT is allocated to the terminal, making this option synonymous with TERMINAL. However, you can allocate SYSPRINT in other ways.

Terminal

Send print output to the terminal.

Data set

Output is accumulated in the print data set specified in the **Data set name** field. This data set can be browsed using the PB command or sent to the JES spool queue for printing by issuing the PRINT command while browsing the data set. (The output is sent to the JES spool queue class specified in the Output class field.)

REXX

Send print output to the REXX stem variable FILEM.

Choose this option when you want to control your printing from within a REXX program.

Record length

How many columns wide the output is

Page skip

Whether output from each function starts on a new page

Wide print

Whether the maximum print line length for print output is used

Translate non-printable chars

Whether non-printable characters are translated to blanks

Uppercase message text

Whether all message text is translated to uppercase.

Data set DISP

Whether the print output is appended to the existing data set (MOD) or replaces it (OLD).



Note: This option only affects output sent to the print data set specified in the PRINTDSN option.

Dump format

Which format (updown or across) is used for hexadecimal print output

Data set name

The print data set where print output is directed when the PRINTOUT print option is set to SYSOUT=c

Output class

The class of the JES spool queue to be used when the PRINT command is issued while browsing the temporary print data set.

Lines per page

How many lines per page the output has

Record limits

Which part of each record to print

You can view the print data set using Print Browse (option 3.11). While you are using the Print Browse, you can use the PURGE primary command to clear the print data set. To transfer the contents of the print data set to a SYSOUT class, press the Print function key (F4).

Print Mode

This entry field on the Print Utility panel determines the format of the printed output.

Related references

[Set Print Processing Options panel on page 792](#)

[PURGE primary command on page 929](#)

Editing the template

Before you print the data, you can edit the template to specify what data is printed and how it is displayed. For example, you might only want to print certain columns, specify different headings for them, and change the sequence in which the columns are printed.

To edit the template, select the **Edit template** option on the Print Utility panel. The Column Selection/Edit panel is displayed.

Running Print in batch

If you want to print large Db2® tables, you can perform the print in a batch job.

If you select the **Batch execution** option on the Print Utility panel, the Print utility builds the necessary JCL to perform the print function in a batch job. The generated JCL is displayed using the ISPF editor, where you can review the JCL and submit the job for batch processing.

Related tasks

- [Editing the template for the "From" table on page 243](#)
- [Specifying a Db2 object name on page 45](#)
- [Specifying a data set and a member name on page 50](#)
- [Print settings \(option 0.1\) on page 62](#)
- [Working with templates on page 72](#)
- [Looking at the print output from your FM/Db2 session on page 326](#)

Related references

- [Primary Option Menu panel on page 728](#)
- [Utility Functions panel on page 864](#)
- [Print Utility panel on page 733](#)
- [Column Selection/Edit panel on page 485](#)

Printing rows from a Db2® table

To print rows from a Db2® table, use:

- The RD (*Record Dump*) primary command to print the data in dump format
- The RP (*Record Print*) primary command to print the data in character format

Examples

Here is an example of RD output when the display format is SNGL:

Figure 76. Sample printed output from RD primary command (SNGL display format)

```

Process  Options  Utilities  Help
-----
Print Browse          SHRIKE2.FMN.LIST          Top of 64
Command ==>          Record AT TOP      Col 2          Scroll CSR
                                         Format CHAR          8
-----
*** Top of data ***
IBM® File Manager for z/OS® Db2 Component
Key      Column      Data
-----
Printed record number - 1

PUN      EMPNO          000010
                          FFFFFFFF
                          000010

N        FIRSTNME     CHRISTINE<
                          CCDCEECD
                          389923955

MIDINIT  I
F1=Help  F2=Split  F3=Exit  F4=Print  F5=RFind  F6=Purge  F7=Up
F8=Down  F9=Swap   F10=Left F11=Right F12=Cancel

```

Here is an example of RD output when the display format is TABL:

Figure 77. Sample printed output from RD primary command (TABL display format)

```

Process  Options  Utilities  Help
-----
Print Browse          SHRIKE2.FMN.LIST          Top of 8
Command ==>          Record AT TOP      Col 2          Scroll CSR
                                         Format CHAR          8
-----
*** Top of data ***
IBM® File Manager for z/OS® Db2 Component
EMPNO  FIRSTNME  MIDINIT  LASTNAME  WORKDEPT  PHONENO  HIREDATE  JOB
CH(6)  VARCHAR(12) CH(1)    VARCHAR(15) CH(3)     CH(4)    DATE      CH(8)
PUN->  <-N+-----1-> -          <-N+-----1-----> <-N      <-->      <-----> <----->
000010 CHRISTINE<  I          HAAS<      A00        3978      1965-01-01 PRES
FFFFFF CCDCEECD  C          CCCE       CFF        FFFF      FFFF6FF6FF DDCE4444
000010 389923955  9          8112      100       3978      1965001001 79520000

*** End of data ***

F1=Help  F2=Split  F3=Exit  F4=Print  F5=RFind  F6=Purge  F7=Up
F8=Down  F9=Swap   F10=Left F11=Right F12=Cancel

```

Here is an example of RP output when the display format is SNGL:

Figure 78. Sample printed output from RP primary command (SNGL display format)

```

Process  Options  Utilities  Help
-----
Print Browse          SHRIKE2.FMN.LIST          Top of 24
Command ==>          Record AT TOP      Col 2          Scroll SCR
Format CHAR          -----8
---+---10---+---2---+---3---+---4---+---5---+---6---+---7---+---8
**** Top of data ****
IBM® File Manager for z/OS® Db2 Component
Key      Column      Data
-----
Printed record number - 1

PUN      EMPNO      000010
N        FIRSTNME  CHRISTINE<
          MIDINIT   I
N        LASTNAME  HAAS<
N        WORKDEPT  A00
          PHONENO   3978
          HIREDATE  1965-01-01
          JOB       PRES
          EDLEVEL   18
F1=Help  F2=Split  F3=Exit  F4=Print  F5=RFind  F6=Purge  F7=Up
F8=Down  F9=Swap   F10=Left F11=Right F12=Cancel
    
```

Here is an example of RP output when the display format is TABL:

Figure 79. Sample printed output from RP primary command (TABL display format)

```

Process  Options  Utilities  Help
-----
Print Browse          SHRIKE2.FMN.LIST          Top of 5
Command ==>          Record AT TOP      Col 2          Scroll CSR
Format CHAR          -----8
**** Top of data ****
IBM® File Manager for z/OS® Db2 Component
EMPNO  FIRSTNME  MIDINIT  LASTNAME  WORKDEPT  PHONENO  HIREDATE  JOB
CH(6)  VARCHAR(12) CH(1)    VARCHAR(15) CH(3)    CH(4)    DATE      CH(8)
PUN-+> <-N-+-----1-> - <-N-+-----1-----> <-N <--> <-----> <----->
000010 CHRISTINE< I HAAS< A00 3978 1965-01-01 PRES
**** End of data ****

F1=Help  F2=Split  F3=Exit  F4=Print  F5=RFind  F6=Purge  F7=Up
F8=Down  F9=Swap   F10=Left F11=Right F12=Cancel
    
```

Related references

[RD primary command on page 930](#)

[RP primary command on page 935](#)

Looking at the print output from your FM/Db2 session

To browse, and optionally purge, the print output from your current FM/Db2 editor session held in the print data set:

- Issue the PB primary command, or
- Use the Print Browse utility function (3.11)

You specify the print data set using the **PRINTDSN** entry field on the Set Print Processing Options panel.

If you use the PB primary command or the Print Browse utility when you have not created any print output, FM/Db2 displays the message `Empty print data set.`

The following primary commands are available with Print Browse:

- FIND
- LOCATE
- PRINT
- PURGE

To select the Print Browse utility:

1. From the Primary Option Menu panel, enter `3` (Utilities) to display the Utility Functions panel.
2. From the Utility Functions panel, enter `11` (Print browse)

Figure 80: Print Browse: sample output on page 327 shows an example of some printed output displayed by Print Browse.

Figure 80. Print Browse: sample output

```

Process  Options  Utilities  Help
-----
Print Browse          SHRIKE2.FMN.LIST                      Top of 48
Command ==> ----- Record AT TOP      Col 2      Scroll CSR
-----+-----10-----+-----2-----+-----3-----+-----4-----+-----5-----+-----6-----+-----7-----+-----8
**** Top of data ****
IBM® File Manager for z/OS® Db2 Component
Db2 SSID: DFG2      SQL ID: SHRIKE2      Location:      Table/View: "DSN81010"."
EMPNO  FIRSTNME  MIDINIT  LASTNAME  WORKDEPT  PHONENO  HIREDATE  JOB
CH(6)  VARCHAR(12) CH(1)    VARCHAR(15) CH(3)     CH(4)    DATE      CH(8)
PUN->  <-N-+-----1-> -      <-N-+-----1-----> <-N-      <-->      <----+----> <----+---->
000010 CHRISTINE  I        HAAS      A00      3978     1965-01-01 PRES
000020 Michael  L        THOMPSON  B01      3476     1973-10-10 MANAGER
000030 SALLY    A        KWAN      C01      4738     1975-04-05 MANAGER
000050 JOHN    B        GEYER     E01      6789     1949-08-17 MANAGER
000060 IRVING   F        STERN     D11      6423     1973-09-14 MANAGER
000070 EVA     D        PULASKI  D21      7831     1980-09-30 MANAGER
000090 NEIL    W        HENDERSON E11      5F98     1970-08-15 MANAGER
000100 THEODORE Q        SPENSER  E21      0972     1980-06-19 MANAGER
000110 VINCENZO G        LUCCHESI A00      3490     1958-05-16 SALESREP
F1=Help  F2=Split  F3=Exit  F4=Print  F5=RFind  F6=Purge  F7=Up
F8=Down  F9=Swap   F10=Left F11=Right F12=Cancel

```

Related tasks

[Printing the contents of a Db2 table on page 321](#)

[Printing an audit trail report on page 328](#)

Related references

[Primary Option Menu panel on page 728](#)

[Utility Functions panel on page 864](#)

[Set Print Processing Options panel on page 792](#)

[FIND primary command on page 897](#)

[LOCATE primary command on page 918](#)

[PRINT primary command on page 928](#)

[PURGE primary command on page 929](#)

Printing an audit trail report

To print an audit trail report using the contents of the audit trail data set, use the Audit trail utility function (3.10).

An audit trail data set is created if the **Create an audit trail** option is selected when you use:

- View (option 1)
- Edit (option 2)
- Copy (option 3.3)



Note: You can create an audit trail data set yourself using the batch job FMNSMFX (supplied with FM/Db2). This job creates an audit trail data set using data from the SMF log file. For details, see the *File Manager Customization Guide*.

To display the Print Audit Trail panel,

1. From the Primary Option Menu panel, enter **3** (Utilities) to display the Utility Functions panel.
2. From the Utility Functions panel, enter **10** (Audit trail)

To print an audit trail report:

1. Specify the name of the audit trail data set that contains the audit trail data you want to print (**Data set name**).

If FM/Db2 created the audit trail data set (as a result of FM/Db2 view, edit, or copy activity), the name is in the format

```
prefix.FMN2AUD.ssid.Dyymmdd.Thhmmss
```

or

```
userid.FMN2AUD.ssid.Dyymmdd.Thhmmss
```

where:

prefix

is the TSO prefix of the user, if it exists.

userid

is the ISPF shared pool variable ZUSER. This is typically the same as the user's TSO logonid.

FMN2AUD

is a constant that identifies the data set as an audit trail

ssid

is the Db2® subsystem ID

Dyymmdd

is the date FM/Db2 created the audit trail data set

Tthmmss

is the time FM/Db2 created the audit trail data set



Note: If the AUDITHLQ option is set in FMNOPOPT (see *File Manager Customization Guide*), audit trail data sets have the name *audithlq.FMNLOG.Dyymmdd.Tthmmss*.

If you created the audit trail data set yourself, use the data set name you specified in the supplied batch job FMNSMFX. For details, see the *File Manager Customization Guide*.

2. To help identify your audit trail report, use the **Description** entry field. If the description contains embedded spaces, you must enclose it in quotation marks. The description you enter is displayed on the Formatted Audit Event Records section of the report.
3. Select the processing options you want:

Print only changed columns

Limits the amount of printed lines.

Keep data set after printing

Whether to keep or delete the data set after it is printed.

Browse report

The audit trail report is displayed using Print Browse (option 3.11).



Note: The contents of the audit trail report are transferred to a SYSOUT class as specified by the **PRINTOUT** print option on the Set Print Processing Options panel. To browse the audit trail report, set the **PRINTOUT** print option to SYSOUT=c.

Batch execution

Generates JCL for printing the audit trail report using a batch job. For command syntax, see “*AUD (Print Audit Trail Report)*” in the File Manager User’s Guide and Reference.

4. Press Enter.

Audit Trail Report

The audit trail report is divided into two sections: Formatted Audit Events Records ([Figure 81: Audit trail report: Formatted Audit Event Records section on page 330](#)) and Summary Statistics ([Figure 82: Audit trail report: Summary Statistics section on page 331](#)).

Figure 81. Audit trail report: Formatted Audit Event Records section

```

-----
IBM® File Manager for z/OS Db2 Component  Audit Trail Report                               Page 1
                                           Formatted Audit Event Records                 Date: 2004-09-2
                                                                                               Time: 11.14.39

Audit trail for EDIT function.
  Data set name: FMNUSER.FMN2AUD.DB26.D020918.T155156
  Audit description:
  System Information:
    MVS System Id: FMD2
    Db2 Subsystem: DB26
    Current SQLID: FMNUSER
  Db2 Object Information:
    Location:
    Owner: FMNUSER
    Name: EMP
  Template Information:
    Data set name:
  Audit event number: 1                               Data fetched on 02/09/18 at 15.52.00
  SQL statement:  SELECT "EMPNO", "FIRSTNME", "MIDINIT", "LASTNAME", "WORKDEPT", "PHONENO", "HIREDATE",
                  "JOB", "EDLEVEL", "SEX", "BIRTHDATE", "SALARY", "BONUS", "COMM" FROM "FMNUSER"."EMP"
-----

```

The first part of the Formatted Event Records section shows:

- The FM/Db2 function being audited (View, Edit, or Copy).
- The name of the data set holding the audit log records.
- The report description (if specified).
- Location information for the Db2® object being manipulated.

The second part of the Formatted Event Records section shows information for each audit event (each SQL call is defined as a separate audit event):

- The audit event number.
- A date and timestamp.
- The SQL statement.
- The Db2® column name.
- The type of key (if applicable).
- The original value of the column (if the column has been changed or deleted).
- The new value of the column (if the column has been changed or inserted).

If **Print only changed fields** was selected on the Print Audit Trail panel, only columns where the data has changed are shown.

Every FM/Db2 view, edit, or copy of a Db2® object is recorded as a separate session. If SMF recording is used, many sessions can be logged. Summary statistics are provided for each session, not the entire period being audited.

Figure 82. Audit trail report: Summary Statistics section

```

Summary Statistics
-----
IBM® File Manager for z/OS Db2 Component  Audit Trail Report                               Page 2
                                           Summary Statistics                               Date: 2004-09-2
                                                                                               Time: 11.14.39

                Data base opened on 2004-09-18 at 15.52.00 by userid: FMNUSER
                Data base closed on 2004-09-18 at 15.55.47
Total SQL statements: 1
    Rows inserted: 0
    Rows deleted: 0
    Rows replaced: 0
TOTAL Data base changes: 0
    Records bypassed: 0
Audit Trail Report Options
    Maximum Print Lines per Page: 60
    Print Only Changed Fields on an Update: NO
-----

```

The Summary Statistics section shows:

- The times the database was opened and closed.
- The user ID.
- Counts of the number of SQL calls, inserts, deletes, and row replacements for the FM/Db2 session.
- The total number of update events.

Related tasks

- [View and Edit options \(options 1 and 2\) on page 65](#)
- [Setting options for the current FM/Db2 editor session on page 123](#)
- [Copy utility options \(option 3.3\) on page 66](#)
- [Viewing and changing Db2 data on page 119](#)
- [Copying data from one Db2 object to another on page 241](#)
- [Looking at the print output from your FM/Db2 session on page 326](#)
- [Print settings \(option 0.1\) on page 62](#)

Related references

- [Editor Options \(1 of 8\) panel on page 625](#)
- [Print Audit Trail panel on page 729](#)

Chapter 11. Managing Db2® privileges

Use the Privileges utility function to display, grant, and revoke Db2® privileges.

To perform these functions, you use the Manage Db2® Privileges panel.

The available functions for managing Db2® privileges are shown in [Table 23: Privilege functions on page 332](#).

Table 23. Privilege functions

Privilege Type	Grant	Revoke
Database	Yes	Yes
Table space	Yes	Yes
Table/View	Yes	Yes
Column	Yes	No ²²
Plan	Yes	Yes
Package	Yes	Yes
Collection	Yes	Yes
Schema	Yes	Yes
Distinct type	Yes	Yes
Function	Yes	Yes
Stored procedure	Yes	Yes

To display the Manage Db2® Privileges panel,

1. From the Primary Option Menu panel, enter **3** (Utilities) to display the Utility Functions panel.
2. From the Utility Functions panel, enter **5** (Privileges)

Related tasks

[Displaying privileges on page 334](#)

[Granting privileges on page 335](#)

[Revoking privileges on page 337](#)

Related references

22. You cannot revoke privileges on specific columns. You must revoke the appropriate table privileges.

[Manage Db2 Privileges panel on page 712](#)

[Primary Option Menu panel on page 728](#)

[Utility Functions panel on page 864](#)

Using the Manage Db2® Privileges panel

The Manage Db2® Privileges panel consists of two sections:

Object Identification Criteria

Use this section of the panel to specify object identification criteria to identify the objects you want listed. FM/Db2 lists all objects, restricted by any such criteria, for which privileges exist. Input in this section depends on the **Object Type** you specify.

Location

Leave this field blank if the objects you want listed are at your current location. Otherwise, type the full name of the remote location, an asterisk (*) to display all available remote locations, or a pattern using wildcard characters. If you specify an asterisk on its own or a pattern, FM/Db2 displays a selection list showing the locations that match the input specification.

To select the location you want, type **s** against the required entry and press Enter.



Note: You can only specify a location if displaying privileges (command line blank).

Owner

To select objects regardless of their owner, leave this field blank. Otherwise, to restrict the list of objects by owner, type either the full name of the owner or a pattern using wildcard characters. If this entry field is not blank, FM/Db2 limits the objects listed to those matching the owner selection criteria you specify.



Note: You can only specify an owner for table or column object types.

Name

To select objects regardless of their name, leave this field blank. Otherwise, to restrict the list of objects by name, type either the full name of the object or a pattern using wildcard characters. If this entry field is not blank, FM/Db2 limits the objects listed to those matching the name selection criteria you specify.

In

This is an optional field you can use to qualify the following object types:

Object type	Qualify by specifying the...
Table space	Name of the database

Object type	Qualify by specifying the...
Column	Name of the table
Package	Name of the collection
Distinct type	Name of the schema
Function	Name of the schema
Stored procedure	Name of the schema

Object Type

Use this section to identify the type of Db2® object against which privilege operations are performed. The available functions for managing Db2® privileges are shown in [Table 23: Privilege functions on page 332](#).

To select the object type you want, type the appropriate number in the **Object Type** selection field. The default value is 3 (table).

You select whether to display, grant, or revoke privileges by what, if anything, you type on the command line:

Display privileges

To select this processing option, leave the command line blank.

Grant privileges

To select this processing option, type **G** on the command line.

Revoke privileges

To select this processing option, type **R** on the command line.



Note: To change an *existing* privilege, you must:

1. Revoke the existing privilege.
2. Grant the new privilege.

Related tasks

[Using an asterisk \(*\) or a pattern in entry fields on page 49](#)

Related references

[Manage Db2 Privileges panel on page 712](#)

[Remote Db2 Location Selection panel on page 759](#)

Displaying privileges

You can display privilege details for any of the object types listed on the Manage Db2® Privileges panel.

To display privilege details:

1. Type the required details (if any) in the **Object Identification Criteria** section.
2. Type the appropriate number in the **Object Type** selection field to select the object type you want, or use the default value, 3 (table).
3. Leave the command line blank.
4. Press Enter. The privilege display panel for the specified privilege types is displayed.

Related tasks

[Granting privileges on page 335](#)

[Revoking privileges on page 337](#)

Related references

[Manage Db2 Privileges panel on page 712](#)

[Primary Option Menu panel on page 728](#)

[Utility Functions panel on page 864](#)

[Privileges panels on page 736](#)

Granting privileges

You can grant (create new) privileges for any of the object types listed on the Manage Db2® Privileges panel.

To grant one or more privileges for an object, you can use any of the following methods:

- Method 1 (specifying the object using the grant privileges panel):
 1. On the Manage Db2® Privileges panel:
 - a. Type the required details (if any) in the **Object Identification Criteria** section.
 - b. Type the appropriate number in the **Object Type** selection field to select the object type you want, or use the default value, 3 (table).
 2. Type `G` on the command line.
 3. Press Enter.

The grant privileges panel for the specified object type is displayed. The panel lists each privilege type, with a corresponding selection entry field, that can apply to the object type.

On the grant privileges panel:

- a. Select the privileges you want to grant by entering “Y” or “G” in the corresponding selection fields.
 - b. In the entry field (or fields) provided, specify the name of the object.
 - c. In the **To** entry field, specify the SQLID of the user to whom the privileges are to be granted (the grantee).
 - d. Press Enter.
- Method 2 (specifying the object from a privilege display panel):



Note: This method only works if there are already privileges for the Db2® object. If not, FM/Db2 issues the message “No rows selected”.

1. On the Manage Db2® Privileges panel,
 - a. Type the required details (if any) in the **Object Identification Criteria** section.
 - b. Type the appropriate number in the **Object Type** selection field to select the object type you want, or use the default value, 3 (table).
2. Leave the command line blank.
3. Press Enter. The privilege display panel for the specified object type is displayed listing the selected objects.
4. On the privilege display panel, type **G** in the **Cmd** field against the object for which you want to grant privileges.
5. Press Enter. The grant privileges panel for the specified object is displayed.



Note: If you use this method to navigate to the grant privileges panel for the specified object type, the following details are pre-entered:

- The existing setting for each privilege type (Y, G, or blank)
- The name details for the object
- The SQLID of the user to whom the existing privileges are granted (the grantee)

On the grant privileges panel:

- a. Select the privileges you want to grant by entering “Y” or “G” in the corresponding selection fields.
 - b. Press Enter.
- Method 3 (using the Object List utility):
 1. Use the utility function, Object List (option 3.4), to display a list of the type of objects you want.
 2. On the object list panel for the selected object type, type **G** in the **Cmd** field against the object for which you want to grant privileges.
 3. Press Enter.

The grant privileges panel for the specified object type is displayed (as for Method 1). The panel lists each privilege type, with a corresponding selection entry field, that can apply to the object type.

4. Follow the remaining steps as for Method 1 ([3.a on page 335](#) to [3.d on page 335](#))

If the grant privilege processing is successful, FM/Db2 displays a message indicating that the grant ran successfully. Otherwise, a panel is displayed showing the formatted SQL return code.

Related tasks

[Displaying privileges on page 334](#)

[Revoking privileges on page 337](#)

[Displaying or printing a list of objects on page 298](#)

Related references

[Manage Db2 Privileges panel on page 712](#)

[Primary Option Menu panel on page 728](#)

[Utility Functions panel on page 864](#)

[Grant privileges panels on page 689](#)

Revoking privileges

You can revoke (remove existing) privileges for any of the object types listed on the Manage Db2® Privileges panel apart from column. (You cannot revoke privileges on specific columns. You must revoke the appropriate table privileges.)

To revoke one or more privileges for an object, you can use either of the following methods:

- Method 1 (specifying the object using the revoke privileges panel):
 1. On the Manage Db2® Privileges panel,
 - a. Type the required details (if any) in the **Object Identification Criteria** section.
 - b. Type the appropriate number in the **Object Type** selection field to select the object type you want, or use the default value, 3 (table).
 2. Type `R` on the command line.
 3. Press Enter.

The revoke privileges panel for the specified object type is displayed. If there is more than one type of privilege that can apply to the object type, the panel lists each privilege type with a corresponding entry field.

On the revoke privileges panel:

- a. Select the privileges you want to revoke by entering *any character* in the corresponding selection fields.



Note: For object types where there is only one type of privilege, this step does not apply.

- b. In the entry field provided (for some types of privilege there are two entry fields), specify the name of the object.
 - c. In the **From** entry field, specify the SQLID of the user for whom the privileges are to be revoked (the revokee).
 - d. In the **By** entry field, specify the SQLID of the user who granted the privileges (the grantor), or *“ALL”* for all grantors.
 - e. Press Enter.
- Method 2 (specifying the object from a privilege display panel):
 1. On the Manage Db2® Privileges panel,
 - a. Type the required details (if any) in the **Object Identification Criteria** section.
 - b. Type the appropriate number in the **Object Type** selection field to select the object type you want, or use the default value, 3 (table).
 2. Leave the command line blank.
 3. Press Enter. The privilege display panel for the specified object type is displayed listing the selected objects.

4. On the privilege display panel, type **R** in the **Cmd** field against the object for which you want to revoke the privileges.
5. Press Enter. The revoke privileges panel for the specified object is displayed.



Note: If you use this method to navigate to the revoke privileges panel (for the specified object type), the following details are pre-entered:

- The existing setting for each privilege type (Y, G, or blank)
- The name details for the object
- The SQLID of the user for whom the privileges are to be revoked (the revokee) in the **From** entry field.

On the revoke privileges panel:

- a. Select the privileges you want to revoke by entering *any character* in the corresponding selection fields.



Note: For object types where there is only one type of privilege, this step does not apply.

- b. In the **By** entry field, specify the SQLID of the user who granted the privileges (the grantor), or *“ALL”* for all grantors.
- c. Press Enter.

If the revoke privilege processing is successful, FM/Db2 displays a message indicating that the revoke ran successfully. Otherwise, a panel is displayed showing the formatted SQL return code.

Related tasks

[Displaying privileges on page 334](#)

[Granting privileges on page 335](#)

Related references

[Manage Db2 Privileges panel on page 712](#)

[Primary Option Menu panel on page 728](#)

[Utility Functions panel on page 864](#)

[Revoke privileges panels on page 766](#)

Chapter 12. Generating batch JCL for Db2® utility jobs

To generate batch JCL to execute the Db2® utility jobs listed below, use the Utilities utility function (3.9). You do not need to know the utility control statements for these operations.

- COPY
- LOAD
- REBUILD
- RECOVER
- REORG
- RUNSTATS
- UNLOAD

For an explanation of the uses of these Db2® utility jobs, refer to the *Db2® Utility Guide and Reference*.



Note: To successfully execute the generated utility job, you must have the appropriate Db2® privileges on any Db2® objects that are referenced.

The main panel for the Utilities utility is the Db2® Utilities panel.

To display the Db2® Utilities panel,

1. From the Primary Option Menu panel, enter **3** (Utilities) to display the Utility Functions panel.
2. From the Utility Functions panel, enter **9** (Utilities)

Use the fields on the Db2® Utilities panel to select:

- The type of Db2® utility you want to run
- The type of Db2® object that the utility processes
- Details of the particular Db2® objects you want to run a utility on

When you press Enter, all objects at the local Db2® server are displayed, unless you entered information in the “*Db2® Object Details*” fields on the Db2® Utilities panel in which case the displayed rows are limited to the objects that match the information you have specified.

The JCL for the Db2® utility job is generated and presented in an ISPF edit session. You can make any required changes prior to submitting the job, or use the ISPF editor commands to save a copy of the JCL for later use.

[Table 24: Db2 utilities you can use with Db2 objects on page 340](#) show which Db2® utilities you can use with which Db2® objects.

Table 24. Db2® utilities you can use with Db2® objects

Db2® utility	Use with these Db2® objects				
	1. Tables	2. Table spaces	3. Index spaces	4. Indexes	5. Indexes for table space
1. COPY		Yes (see COPY (table spaces) on page 347)	Yes (see COPY (index spaces) on page 348)		
2. LOAD	Yes (see LOAD utility on page 349)				
3. REBUILD				Yes (see REBUILD utility (indexes) on page 358)	Yes (see REBUILD utility (indexes for table spaces) on page 359)
4. RECOVER		Yes (see RECOVER (table spaces) on page 360)	Yes (see RECOVER (index spaces) on page 362)		
5. REORG		Yes (see REORG (table spaces) on page 364)		Yes (see REORG (indexes) on page 366)	
6. RUNSTATS		Yes (see RUNSTATS (table spaces) on page 369)		Yes (see RUNSTATS (indexes) on page 370)	
7. UNLOAD	Yes (see UNLOAD (tables) on page 373)	Yes (see UNLOAD (table spaces) on page 378)			

Related tasks[COPY utility](#) on page 346[LOAD utility](#) on page 349[REBUILD utility](#) on page 357[RECOVER utility](#) on page 360[REORG utility](#) on page 363[RUNSTATS utility](#) on page 368

[UNLOAD utility on page 372](#)

[Generating a Db2 utility job on page 343](#)

Related references

[Db2 Utilities panel on page 610](#)

[Primary Option Menu panel on page 728](#)

[Utility Functions panel on page 864](#)

Setting options for Db2® utilities

You can set Db2® utility options to:

- Insert JCL DD statements for specified LISTDEF or TEMPLATE libraries
- Modify the Db2® utility functions to include DD name clauses with specified template names
- Insert LISTDEF, TEMPLATE, and OPTIONS Db2® utility statements

To change the option settings for Db2® utilities, first select **0 (Settings)** from the Primary Option menu to display the Set Processing Options panel. The new settings apply for the current subsystem only. When you reconnect to the same subsystem, your option settings are retrieved.

To reset the option settings back to the installation defaults (for the current Db2® subsystem), use the RESET primary command or the Reset function key (F6).

The Set Processing Options panel shows menu items for:

Unload utility options

The FM/Db2 Unload Utility options apply when the UNLOAD utility is used to transfer data.

Options utility options

The FM/Db2 Options utility options assist in generating Db2® OPTIONS utility control statements.

Listdef utility options

The FM/Db2 Listdef utility options assist in generating Db2® LISTDEF utility control statements and in generating JCL for utility batch jobs to access a LISTDEF library.

Template utility options

The FM/Db2 Template utility options assist in generating Db2® TEMPLATE utility control statements and in generating JCL for utility batch jobs to access a template library. Also, options are provided that allow you to specify template names for DD names clauses of various Db2® utility control statements.

For a full description of Db2® utilities, see the *Db2® Utility Guide and Reference*.

Before you generate batch JCL to execute a Db2® Utility, check that these options are set to the values you want.

FM/Db2 uses the above options to generate JCL that refers to the appropriate LISTDEF and TEMPLATE libraries and also, where applicable, to generate an OPTIONS, LISTDEF, or TEMPLATE utility statement in the utility batch job. If specified,

FM/Db2 places the **OPTIONS**, **LISTDEF**, and **TEMPLATE** statements in the **SYSIN** deck before the utility statement that corresponds to the utility selected from the Db2® Utilities panel.

To change the option settings for a Db2® utility:

1. From either the Set Processing Options panel or the **Options** pull-down menu, select the menu item for the options you want to change:

11

Unload

12

Options

13

Listdef

14

Template

FM/Db2 displays the selected options panel.

2. Change the option settings as necessary

Related tasks

[Setting default processing options on page 60](#)

Related references

[Set Processing Options panel on page 795](#)

[Db2 Utilities panel on page 610](#)

[UNLOAD Options panel on page 854](#)

[OPTIONS Options panel on page 721](#)

[LISTDEF Options panel on page 702](#)

[Additional LISTDEF Statements panel on page 440](#)

[TEMPLATE Options \(1 of 2\) panel on page 846](#)

[TEMPLATE Options \(2 of 2\) panel on page 848](#)

[Additional TEMPLATE Statements panel on page 441](#)

[RESET primary command on page 932](#)

Generating a LISTDEF statement in the Db2® utility job

The Db2® Utilities panel shows a **Specification** section and a **LISTDEF name** entry field. You can use these entry fields to specify the name of a LISTDEF.

If you select LISTDEF in the **Specification** section, you must also specify a LISTDEF name as the object of the utility.

To use a LISTDEF name as the object of the utility:

1. In the **Specification** section, select **2. LISTDEF**
2. Enter the name of the LISTDEF in **LISTDEF name**



Note: The LOAD syntax does not have a LISTDEF clause. If you select LOAD in the **Db2® Utility** section and LISTDEF in the **Specification** section, FM/Db2 issues an error message.

Related references

[Db2 Utilities panel on page 610](#)

Generating a Db2® utility job

To generate a Db2® utility job:

1. Specify the Db2® utility you want to generate:

1

COPY

2

LOAD

3

REBUILD

4

RECOVER

5

REORG

6

RUNSTATS

7

UNLOAD

2. Specify the object type:

1

Tables

2

Table spaces

3

Index spaces

4

Indexes

5

Indexes for table spaces

3. For COPY, REBUILD, RECOVER, REORG, RUNSTATS, and UNLOAD (that is, all the FM/Db2 Db2® utilities except LOAD), you can specify that a LIST clause is to be included in the JCL generated by FM/Db2 for the nominated Db2® utility.

To generate a LIST clause in the JCL for the Db2® utility, select **2. LISTDEF**; otherwise, select **1. Object name**.

4. You now need to supply details about either the object or the LISTDEF for the Db2® utility job:
 - If you specified **1. Object name** in the Specification section (Step 3), optionally, specify details about the object by using one or more of the four filter fields:
 - **Database**
 - **Table/Index space**
 - **Owner** (Table or Index)
 - **Name** (Table or Index)

FM/Db2 validates any details you enter and carries them forward to the next panel.

For each of the preceding filter fields, you can enter:

- The full name of the item.
- An asterisk (*) to display a list of items from which you can select the one you want.

If you enter an asterisk (*) in any of the four filter fields, FM/Db2 displays the respective selection list panel from which you can select a value to put into the filter field. The records displayed in these panels are restricted by any other related filter you have previously entered. Each combination of utility and Db2® object results in certain valid filter combinations. Incorrect filter combinations are rejected.

- A pattern to display a list of all items whose name matches the pattern specification.
 - Blanks. No filtering effect occurs.
- If you specified **2. LISTDEF** in the Specification section (Step 3), enter the name to be used in the LIST clause in **LISTDEF name**.

5. Press Enter.

FM/Db2 displays the panel for the specified Db2® utility and object type.

If you specified **1. Object name** in the Specification section (Step 3), the panel shows the qualifying list of rows, with various input and output fields. Select the rows you want and change the values in any of the editable fields as required.

If you specified **2. LISTDEF** in the Specification section (Step 3), FM/Db2 displays an alternative panel for the Db2® utility. See [Working with LISTDEF utility panels on page 345](#).

6. Press Enter.

FM/Db2 displays the generated JCL which you can edit if you need to before you submit it as a job. (The LOAD and UNLOAD utilities are exceptions to this rule, as both utilities show another series of panels, before displaying the generated JCL.) [Figure 83: Sample JCL generated for COPY Utility \(table spaces\) on page 345](#) shows an example of generated JCL.

Figure 83. Sample JCL generated for COPY Utility (table spaces)

```

File Edit Edit_Settings Menu Utilities Compilers Test Help
-----
EDIT          FMNUSER.SPFTEMP1.CNTL                      Columns 00001 00072
***** ***** Top of Data *****
000001 //FMNUSERB JOB (IBMGSA),
000002 //          FMNUSER,MSGCLASS=A,
000003 //          NOTIFY=FMNUSER,CLASS=A,
000004 //          MSGLEVEL=(1,1)
000005 //*
000006 //          JCLLIB ORDER=(DB2V810.DFA2.PROCLIB)
000007 //*
000008 //*****
000009 //* STEP COPY1: COPY TABLESPACE DSN8D81A.DSN8S81D
000010 //*****
000011 //COPY1 EXEC DSNUPROC,SYSTEM=DFA2,UID='FMNUSER'
000012 //DSNUPROC.STEPLIB DD DSN=DB2V810.DFA2.SDSNEXIT,DISP=SHR
000013 //          DD DSN=DB2.V810.SDSNLOAD,DISP=SHR
000014 //DSNUPROC.SYSCOPY DD DISP=(NEW,CATLG,DELETE),
000015 //          DSN=FMNUSER.DSN8D81A.DSN8S81D.F00000.D2601115,
000016 //          UNIT=SYSALLDA,SPACE=(TRK,(1,1),RLSE)
000017 //DSNUPROC.SYSIN DD *
000018 COPY TABLESPACE DSN8D81A.DSN8S81D
000019 COPYDDN(SYSCOPY)
000020 /*
***** ***** Bottom of Data *****

Command ==> _____ Scroll ==> PAGE
F1=Help      F2=Split    F3=Exit     F5=Rfind    F6=Rchange  F7=Up
F8=Down     F9=Swap    F10=Left   F11=Right   F12=Cancel

```

7. To submit the JCL as a job stream for batch processing, use the SUBMIT command.

The following sections describe each of the Db2® utilities that FM/Db2 supports.

Related tasks

[Using an asterisk \(*\) or a pattern in entry fields on page 49](#)

[COPY utility on page 346](#)

[LOAD utility on page 349](#)

[REBUILD utility on page 357](#)

[RECOVER utility on page 360](#)

[REORG utility on page 363](#)

[RUNSTATS utility on page 368](#)

[UNLOAD utility on page 372](#)

Working with LISTDEF utility panels

When you specify **2. LISTDEF** in the Specification section and the name of the LISTDEF in **LISTDEF name** of one of the Db2® utility panels (excluding LOAD), FM/Db2 displays an alternative panel showing the name of the LISTDEF. You use the LISTDEF form of the utility panel to specify one or more names to be used in the LIST clause in the JCL generated for the Db2® utility.

Initially the panel shows a single line containing the name you specified in the **LISTDEF name** field on the Db2® utility panel.

You can manipulate the panel rows as necessary by entering line commands in the **CMD** field to insert, repeat, delete, or select rows.

An asterisk (*) in the **PRC** column indicates the LISTDEF in the row is selected. Use the S command to toggle unselected rows to selected and selected rows to unselected.

You cannot select a row where the **LISTDEF Name** field is blank.

To display the LISTDEF Selection pop-up panel, type an asterisk (*) in the **LISTDEF Name** field.

```

LISTDEF Selection
Row 1 to 4 of 4
Select one from the list of the last twelve entries.
Sel LISTDEF
  - NORMAL
  - EXAMPLE1
  - JOHNS
  - MYLIST
***** Bottom of data *****

Command ==>
F1=Help      F2=Split    F3=Exit
F9=Swap      F12=Cancel
    
```

Select a LISTDEF name from the displayed list by entering an **s** in the **Sel** field.

To create a utility batch job with the selected LISTDEFs, press Enter.

For more information about the LISTDEF name, see the LIST keyword in the *Db2 Utility Guide and Reference*.

COPY utility

To select the COPY utility, enter **1** in the **Db2® utility** input field on the Db2® Utilities panel.

If you selected *Table spaces* in the **Object Type** section of the Db2® Utilities panel, the COPY Utility (Table spaces) panel is displayed.

If you selected *Index spaces* in the **Object Type** section of the Db2® Utilities panel (and did not specify name of a LISTDEF), one of two forms of the COPY Utility (Index spaces) panel is displayed. The format of the panel depends on which, if any, of the filter fields you specified on the Db2® Utilities panel.



Note: If you specified the name of a LISTDEF on the Db2® Utilities panel, FM/Db2 displays an alternative form of the COPY Utility (Table spaces) panel or COPY Utility (Index spaces) panel.

Related tasks

[Default values on page 347](#)

[COPY \(table spaces\) on page 347](#)

[COPY \(index spaces\) on page 348](#)

Related references

[Db2 Utilities panel on page 610](#)

[COPY Utility \(Table Spaces\) panel on page 509](#)

[COPY Utility \(Table Spaces\) with LISTDEF panel on page 511](#)

[COPY Utility \(Index Spaces\) panel on page 502](#)

[COPY Utility \(Index Spaces\) with LISTDEF panel on page 504](#)

[TEMPLATE Options \(2 of 2\) panel on page 848](#)

Default values

The default naming conventions used for image copy data sets in the generated JCL are:

- &ZUSER..&DBNAME..&OBJNAME..&PRE&PARTNO..D&FMN2DTIM.
- &ZUSER, &DBNAME, and &PARTNO are self-explanatory.
- &OBJNAME is either the table space name or the index space name.
- &PRE can be:

F

Full

I

Incremental

C

Change Limit. This can result in Db2® performing a full or incremental imagecopy.

- &FMN2DTIM contains *jjjhhmm*, where with *jjj* is the Julian day, and *hhmm* is the time.

For example, OSPEED.UTILDB1.T1RIX1.F00000.D1011044

COPY (table spaces)

This option corresponds to the COPY TABLE SPACE form of the COPY utility control statement.

- If you did *not* specify the name of a LISTDEF on the Db2® Utilities panel:
 - If you entered information in the **Database name** or **Table/index space name** filter fields on the Db2® Utilities panel, the displayed rows are limited to the Db2® objects that match the information you specified.
 - To select a table space from those displayed, type **S** in the **Sel** column. An asterisk (*) in the **PRC** column indicates selected table spaces.
 - You can modify the COPY utility statement by changing the values in the following input fields:

- FCP
- Change Limits
- RPO
- [Figure 83: Sample JCL generated for COPY Utility \(table spaces\) on page 345](#) shows an example of generated JCL for copying a table space.
- If you *did* specify the name of a LISTDEF on the Db2® Utilities panel:
 - FM/Db2 displays an alternative form of the COPY Utility (Table Spaces) panel showing the specified LISTDEF and a number of editable fields that correspond to keywords in the COPY statement.
 - [Figure 84: Sample JCL generated for COPY Utility \(table spaces\) with LISTDEF specified on page 348](#) shows an example of generated JCL for copying a table space where a LISTDEF has been specified.

Figure 84. Sample JCL generated for COPY Utility (table spaces) with LISTDEF specified

```

File Edit Edit_Settings Menu Utilities Compilers Test Help
EDIT          FMNUSER.SPFTEMP1.CNTL                      Columns 00001 00072
***** ***** Top of Data *****
000001 //FMNUSERB JOB (IBMGSA),
000002 //          FMNUSER,MSGCLASS=A,
000003 //          NOTIFY=FMNUSER,CLASS=A,
000004 //          MSGLEVEL=(1,1)
000005 // *
000006 //          JCLLIB ORDER=(DB2V810.DFA2.PROCLIB)
000007 // *
000008 //*****
000009 // * STEP COPY1: COPY TABLESPACE LIST LDEFNAME
000010 //*****
000011 //COPY1 EXEC DSNUPROC,SYSTEM=DFA2,UID='FMNUSER'
000012 //DSNUPROC.STEPLIB DD DSN=DB2V810.DFA2.SDSNEXIT,DISP=SHR
000013 //          DD DSN=DB2.V810.SDSNLOAD,DISP=SHR
000014 //DSNUPROC.SYSCOPY DD DISP=(NEW,CATLG,DELETE),
000015 //          DSN=FMNUSER.LDEFNAME.F.D2601124,
000016 //          UNIT=SYSALLDA,SPACE=(TRK,(1,1),RLSE)
000017 //DSNUPROC.SYSIN DD *
000018 COPY LIST LDEFNAME
000019 COPYDDN(SYSCOPY)
000020 /*
***** ***** Bottom of Data *****

Command ==> _____ Scroll ==> PAGE
F1=Help      F2=Split    F3=Exit     F5=Rfind    F6=Rchange  F7=Up
F8=Down      F9=Swap     F10=Left    F11=Right   F12=Cancel
    
```

Related references

- [COPY Utility \(Table Spaces\) panel on page 509](#)
- [COPY Utility \(Table Spaces\) with LISTDEF panel on page 511](#)
- [Db2 Utilities panel on page 610](#)

COPY (index spaces)

This option corresponds to the COPY INDEXSPACE form of the COPY utility control statement.

- If you did *not* specify the name of a LISTDEF on the Db2® Utilities panel:
 - When you use COPY (index spaces), you can use the following combinations of filter fields on the Db2® Utilities panel:
 - **Database name, or Table/index space name.**
 - **Database name, Table/index owner, or Table/index name.**

- If you entered information in any of the preceding filter fields on the Db2® Utilities panel, the displayed rows are limited to the Db2® objects that match the information you specified.
 - To select an index space from those displayed, type **s** in the **Sel** column. An asterisk (*) in the **PRC** column indicates selected table spaces.
 - The COPY INDEXSPACE statements generated by FM/Db2 specify the database and index space name (rather than the index owner and index name), regardless of the way you specified the index to be copied.
- [Figure 85: Sample JCL generated for COPY Utility \(index spaces\) on page 349](#) shows an example of generated JCL for copying an index space.

Figure 85. Sample JCL generated for COPY Utility (index spaces)

```

File Edit Edit_Settings Menu Utilities Compilers Test Help
-----
EDIT          FMNUSER.SPFTEMP1.CNTL                      Columns 00001 00072
***** ***** Top of Data *****
000001 //FMNUSERB JOB (IBMGSA),
000002 //          FMNUSER,MSGCLASS=A,
000003 //          NOTIFY=FMNUSER,CLASS=A,
000004 //          MSGLEVEL=(1,1)
000005 //*
000006 //          JCLLIB ORDER=(DB2V810.DFA2.PROCLIB)
000007 //*
000008 //*****
000009 //* STEP COPY1: COPY INDEXSPACE JLV3D81A.XEMP2
000010 //*****
000011 //COPY1 EXEC DSNUPROC,SYSTEM=DFA2,UID='FMNUSER'
000012 //DSNUPROC.STEPLIB DD DSN=DB2V810.DFA2.SDSNEXIT,DISP=SHR
000013 //          DD DSN=DB2.V810.SDSNLOAD,DISP=SHR
000014 //DSNUPROC.SYSCOPY DD DISP=(NEW,CATLG,DELETE),
000015 //          DSN=FMNUSER.JLV3D81A.XEMP2.F00000.D2601130,
000016 //          UNIT=SYSALLDA,SPACE=(TRK,(1,1),RLSE)
000017 //DSNUPROC.SYSIN DD *
000018 COPY INDEXSPACE JLV3D81A.XEMP2
000019 COPYDDN(SYSCOPY)
000020 /*
***** ***** Bottom of Data *****

Command ==> _____ Scroll ==> PAGE
F1=Help      F2=Split      F3=Exit      F5=Rfind     F6=Rchange   F7=Up
F8=Down      F9=Swap       F10=Left    F11=Right    F12=Cancel

```

- If you *did* specify the name of a LISTDEF on the Db2® Utilities panel:
 - FM/Db2 displays an alternative form of the COPY Utility (Index Spaces) panel showing the specified LISTDEF and a number of editable fields that correspond to keywords in the COPY statement.

Related references

- [COPY Utility \(Index Spaces\) panel on page 502](#)
- [COPY Utility \(Index Spaces\) with LISTDEF panel on page 504](#)
- [Db2 Utilities panel on page 610](#)

LOAD utility

This option corresponds to the Db2® LOAD utility control statement.

To select the LOAD utility, on the Db2® Utilities panel:

1. Enter 2 (LOAD) in the **Db2® Utility** entry field.
2. Enter 1 (Tables) in the **Object Type** entry field.

The LOAD Utility panel is displayed.



Note: You can also use the Import (option 3.6) utility to load data from a QSAM or VSAM data set into a Db2® table, either in foreground or in batch.

Related tasks

- [Copying data from a VSAM or QSAM file on page 246](#)
- [Input data on page 350](#)
- [Loading data using LOAD utility control statements on page 351](#)
- [Loading data described by a copybook or template on page 353](#)

Related references

- [Db2 Utilities panel on page 610](#)
- [LOAD Utility panel on page 706](#)
- [TEMPLATE Options \(2 of 2\) panel on page 848](#)

Input data

The FM/Db2 process that builds the LOAD utility JCL requires the input data to be in a fixed-length format, as it builds fixed-position field specification statements.

You can use the LOAD utility where the data to be loaded is:

- Described by existing LOAD utility control statements.

For example, the REORG utility can be used to unload Db2® data into Db2® *“unload”* format by specifying the UNLOAD EXTERNAL option. The REORG utility also produces a file containing Db2® LOAD utility control statements to (re)load the data into the original tables.

- Described by a copybook or template.

You must specify the name of a copybook or FM/Db2 template that describes the input data. The format of the data needs to be consistent with the requirements of the LOAD utility.

Related tasks

- [REORG utility on page 363](#)
- [Setting options for Db2 utilities on page 341](#)
- [Loading data using LOAD utility control statements on page 351](#)
- [Loading data described by a copybook or template on page 353](#)

Loading data using LOAD utility control statements



Note: To load data in this way, the default INDDN name (in the **INDDN template name** field on the second TEMPLATE Options panel) must be blank.

To load data from a previous Db2® “unload” operation:

1. In the entry fields for input data, specify the name of the data set (**Data set name**), and optionally the name of the member (**Member**), containing the data to be loaded.
2. In the entry fields for utility control statements, specify the name of the data set (**Data set name**), and optionally the name of the member (**Member**), containing the utility control statements.
3. Select option 1 (“*The data is described by utility control statements*”)
4. Press Enter.

FM/Db2 constructs a batch job to run the Db2® LOAD utility job using the input details you have specified. [Figure 86: Sample JCL generated for LOAD Utility using LOAD utility control statements on page 352](#) shows an example of generated JCL for loading a table using data in Db2® “unload” format.

Figure 86. Sample JCL generated for LOAD Utility using LOAD utility control statements

```

File Edit Edit_Settings Menu Utilities Compilers Test Help
EDIT          FMNUSER.SPFTEMP1.CNTL                      Columns 00001 00072
***** ***** Top of Data *****
000001 //FMNUSERB JOB (IBMGSA),
000002 //          FMNUSER,MSGCLASS=A,
000003 //          NOTIFY=FMNUSER,CLASS=A,
000004 //          MSGLEVEL=(1,1)
000005 //*
000006 //          JCLLIB ORDER=(DB2V810.DFA2.PROCLIB)
000007 //*
000008 //*****
000009 //*
000010 //* FM/Db2 GENERATED JOB TO LOAD A TABLE
000011 //*
000012 //*****
000013 //*
000014 //*****
000015 //* STEP SETPARM: OVERRIDE ANY GLOBAL DATASET SIZING VALUES HERE
000016 //*****
000017 //SETPARM SET ALLOC='TRK',PRI='1',SEC='1'
000018 //*
000019 //*****
000020 //* STEP LOAD: LOAD THE TABLE
000021 //*****
000022 //LOAD EXEC DSNUPROC,SYSTEM=DFA2,UID='FMNUSER'
000023 //DSNUPROC.STEPLIB DD DSN=DB2V810.DFA2.SDSNEXIT,DISP=SHR
000024 //          DD DSN=DB2.V810.SDSNLOAD,DISP=SHR
000025 //DSNUPROC.SYSREC00 DD DISP=SHR,          INPUT DATA
000026 //          DSN=FMNUSER.DATA(FMNCDATA)
000027 //DSNUPROC.SYSDISC DD SYSOUT=*          DISCARDED RECORDS
000028 //DSNUPROC.SYSERR DD UNIT=SYSALLDA,
000029 //          SPACE=(TRK,(1,1))          ERROR INFORMATION
000030 //DSNUPROC.SYSMAP DD UNIT=SYSALLDA,
000031 //          SPACE=(TRK,(1,1))          INTERNAL MAPPING DATA SET
000032 //DSNUPROC.SYSUT1 DD UNIT=SYSALLDA,
000033 //          SPACE=(&ALLOC,(&PRI,&SEC),RLSE)
000034 //DSNUPROC.SORTOUT DD UNIT=SYSALLDA,
000035 //          SPACE=(&ALLOC,(&PRI,&SEC),RLSE)
000036 //DSNUPROC.SYSIN DD *
000037 LOAD DATA
000038 PREFORMAT
000039 LOG YES
000040 INDDN SYSREC00
000041 RESUME YES
000042 FLOAT(IEEE)
000043 ASCII
000044 SORTKEYS 100
000045 SORTDEVT SYSDA
000046 INTO TABLE
000047 "FMNUSER"."EMP"
000048 (
000049 "EMPNO          " POSITION(1      :2      ) CHAR(6)
000050 ,"SALARY        " POSITION(27     :30     ) DECIMAL
000051 )
***** ***** Bottom of Data *****

Command ===> _____ Scroll ===> PAGE
F1=Help      F2=Split    F3=Exit     F5=Rfind    F6=Rchange  F7=Up
F8=Down      F9=Swap     F10=Left   F11=Right   F12=Cancel

```

Related tasks

[Loading data described by a copybook or template on page 353](#)

Related references

[LOAD Utility panel on page 706](#)

Loading data described by a copybook or template

You can use the LOAD utility to load data in a sequential data set, providing a copybook or template exists that describes the format of the input data.

In this case, you use a series of panels:

- On the LOAD Utility panel, you specify the name of the data set containing the input data, and the name of the target table.
- On the second panel, you specify the “*From*” copybook or template that describes the input data.
- On the third panel, you can specify the “*To*” template that describes the target table. Alternatively, you can use FM/Db2 to generate a template for the target table using the information in the Db2® catalog.

At this stage, you can define the mapping between fields in the input template and fields in the output template.

To load data described by a copybook or template:

1. In the entry fields for input data, specify the name of the data set (**Data set name**), and optionally the name of the member (**Member**), containing the data to be loaded.
2. In the entry fields for the target Db2® table (**Table owner**, **Table name**, and optionally **Database** and **Table space**), specify the name of the table into which the data is to be loaded. In any of these fields, you can enter either an asterisk (*) to display a selection list, or wildcards.
3. Select option 2 (“*The data is described by a template or copybook*”)
4. Press Enter.

If you have specified a default name for an INDDN clause (in the **INDDN template name** field on the second TEMPLATE Options panel), FM/Db2 displays an interim panel showing the default name (for example, LODINDDN) in the **Template name** field for the input data:

```

  Process  Options  Utilities  Help
  -----
FM/Db2 (DFG2)                                LOAD Utility
Input Data:
  Template name . . . LODINDDN
Target Db2 Table:
  Owner . . . . . FMNUSER      + Database . . . . . (optional)
  Name . . . . . EMP          + Table space . . . . . (optional)
                                     +
Command ==>
F1=Help      F2=Split    F3=Exit     F4=Expand    F7=Backward  F8=Forward
F9=Swap      F10=Left    F11=Right   F12=Cancel

```

FM/Db2 displays a panel where you can specify the input template or copybook.

5. Specify the “From” template details. Perform one of these actions:
 - Specify a copybook or template:
 - In the entry fields for the input template or copybook, specify the name of the data set (**Data set name**), and optionally the name of the member (**Member**), for the template or copybook that describes the format of the input data.
 - Select 1 (Above) for the **Template usage** option.
 - Use the last (previously used) template:
 - Select 2 (Previous) for the **Template usage** option.
6. To edit the template for the input data before proceeding to the LOAD utility “To” template panel, select the **View template** option. You can select this option by entering either a / or an “A”.



Note: The template edit operations have no effect when the template is used to generate Db2® LOAD utility control statements. If you select this option, you cannot update and save changes to the template.

7. Press Enter.

FM/Db2 displays a panel where you can specify the template for the target Db2® table.

8. Specify the “To” template details using a combination of the **To Template** and **Template usage** entry fields. You can:
 - Specify a template that describes the format of the input data:
 - Use **Data set name**, and optionally **Member**, to specify the template.
 - Select 1 (Above).
 - Use the last (previously used) template:
 - Select 2 (Previous).
 - Use FM/Db2 to generate a template using the information in the Db2® catalog:
 - Select 3 (Generate from table).

- Use FM/Db2 to generate a template using the information in the Db2® catalog and store the generated template using the name you specify (if the member already exists, FM/Db2 replaces it):
 - Use **Data set name**, and optionally **Member**, to specify the name that you want FM/Db2 to use when storing the generated template.
 - Select 4 (Generate/Replace).
9. To change the options for the current LOAD session, select **Edit load utility options** by entering either a / or an "A".

FM/Db2 displays the Load Utility Options panel for editing.



Note: Any options you set on this panel apply for the current LOAD session only. When you exit from the LOAD session, the load options revert to the global LOAD options.

10. To map the columns (or fields) in the "From" template to the columns in the "To" template, select **Edit load utility options** by entering either a / or an "A". FM/Db2 displays the Template Mapping panel.
11. Press Enter.

FM/Db2 constructs a batch job to run the Db2® LOAD utility job using the input details you have specified. [Figure 87: Sample JCL generated for LOAD Utility using data described by a copybook or template \(continued in next figure\) on page 356](#) shows an example of generated JCL for loading a table using data described by a copybook or template. [Figure 87. Sample JCL generated for LOAD Utility using data described by a copybook or template \(continued in next figure\)](#)

```

File Edit Edit_Settings Menu Utilities Compilers Test Help
EDIT          FMNUSER.SPFTEMP1.CNTL                      Columns 00001 00072
***** ***** Top of Data *****
000001 //FMNUSERB JOB (IBMGSA),
000002 //          FMNUSER,MSGCLASS=A,
000003 //          NOTIFY=FMNUSER,CLASS=A,
000004 //          MSGLEVEL=(1,1)
000005 //*
000006 //          JCLLIB ORDER=(DB2V810.DFA2.PROCLIB)
000007 //*
000008 //*****
000009 //*
000010 //* FM/Db2 GENERATED JOB TO LOAD A TABLE
000011 //*
000012 //*****
000013 //*
000014 //*****
000015 //* STEP SETPARM: OVERRIDE ANY GLOBAL DATASET SIZING VALUES HERE
000016 //*****
000017 //SETPARM SET ALLOC='TRK',PRI='1',SEC='1'
000018 //*
000019 //*****
000020 //* STEP LOAD: LOAD THE TABLE
000021 //*****
000022 //LOAD      EXEC DSNUPROC,SYSTEM=DFA2,UID='FMNUSER'
000023 //DSNUPROC.STEPLIB DD DSN=DB2V810.DFA2.SDSNEXIT,DISP=SHR
000024 //          DD DSN=DB2.V810.SDSNLOAD,DISP=SHR
000025 //DSNUPROC.SYSREC00 DD DISP=SHR,          INPUT DATA
000026 //          DSN=FMNUSER.DATA(FMNCDATA)
000027 //DSNUPROC.SYSDISC DD SYSOUT=*          DISCARDED RECORDS
000028 //DSNUPROC.SYSERR  DD UNIT=SYSALLDA,
000029 //          SPACE=(TRK,(1,1))          ERROR INFORMATION
000030 //DSNUPROC.SYSMAP  DD UNIT=SYSALLDA,
000031 //          SPACE=(TRK,(1,1))          INTERNAL MAPPING DATA SET
000032 //DSNUPROC.SYSUT1  DD UNIT=SYSALLDA,
000033 //          SPACE=(&ALLOC,(&PRI,&SEC),RLSE)
000034 //DSNUPROC.SORTOUT DD UNIT=SYSALLDA,
000035 //          SPACE=(&ALLOC,(&PRI,&SEC),RLSE)
000036 //DSNUPROC.SYSIN   DD *
000037 LOAD DATA
000038 PREFORMAT
000039 LOG YES
000040 INDDN SYSREC00
000041 RESUME YES
000042 FLOAT(IEEE)
000043 ASCII
000044 SORTKEYS 100
000045 SORTDEVT SYSDA
000046 INTO TABLE
000047 "FMNUSER"."EMP"
000048 (
000049 "EMPNO           " POSITION(1      :2      ) CHAR(6)
000050 ,"SALARY         " POSITION(27     :30     ) DECIMAL
000051 )
***** ***** Bottom of Data *****

Command ==> _____ Scroll ==> PAGE
F1=Help      F2=Split    F3=Exit     F5=Rfind    F6=Rchange  F7=Up
F8=Down      F9=Swap     F10=Left    F11=Right   F12=Cancel

```

Related tasks

[Loading data using LOAD utility control statements on page 351](#)

[Mapping data on page 109](#)

[Selecting options on FM/Db2 panels on page 44](#)

[Editing a template on page 81](#)

[Db2 LOAD utility options \(option 3.L\) on page 67](#)

[Using an asterisk \(*\) or a pattern in entry fields on page 49](#)

Related references

[LOAD Utility panel on page 706](#)

[LOAD Utility - Using Templates panel on page 708](#)

[LOAD from panel on page 704](#)

[LOAD Utility Options panel on page 710](#)

[Template Mapping panel on page 850](#)

[TEMPLATE Options \(2 of 2\) panel on page 848](#)

REBUILD utility

This option corresponds to the Db2® REBUILD INDEX utility control statement.

To select the REBUILD utility, enter **3** in the **Db2® Utility** input field on the Db2® Utilities panel.

If you selected Table spaces in the **Object Type** section of the panel, the REBUILD Utility (Indexes) panel is displayed.

If you selected Indexes or Index spaces in the **Object Type** section of the panel, the REBUILD Utility (Indexes for Table Spaces) panel is displayed.



Note: If you specified the name of a LISTDEF on the Db2® Utilities panel, FM/Db2 displays an alternative form of the REBUILD Utility (Indexes) panel or REBUILD Utility (Indexes for Table Spaces) panel.

Related tasks

[REBUILD utility \(indexes\) on page 358](#)

[REBUILD utility \(indexes for table spaces\) on page 359](#)

Related references

[Db2 Utilities panel on page 610](#)

[REBUILD Utility \(Indexes\) panel on page 745](#)

[REBUILD \(Indexes\) with LISTDEF panel on page 747](#)

[REBUILD \(Indexes for Table Spaces\) panel on page 741](#)

[REBUILD \(Indexes for Table Spaces\) with LISTDEF panel on page 743](#)

REBUILD utility (indexes)

To include a WORKDDN clause in the generated REBUILD statement, specify the required template name in **WORKDDN template name** on the second TEMPLATE Options panel.

- If you did *not* specify the name of a LISTDEF on the Db2® Utilities panel:
 - If you entered information in the **Database name**, **Table/index owner**, or **Table/index name** filter fields on the Db2® Utilities panel, the displayed rows are limited to the Db2® objects that match the information you specified.
 - To select an index from those displayed, type **s** in the **Sel** column. An asterisk (*) in the **PRC** column indicates selected indexes.
 - [Figure 88: Sample JCL generated for REBUILD Utility \(indexes\) on page 358](#) shows an example of generated JCL for rebuilding indexes.

In this example, FM/Db2 has generated two JCL steps, one for each index selected from the displayed rows on the previous panel.

Figure 88. Sample JCL generated for REBUILD Utility (indexes)

```

File Edit Edit_Settings Menu Utilities Compilers Test Help
-----
EDIT          FMNUSER.SPFTEMP1.CNTL          Columns 00001 00072
***** ***** Top of Data *****
000001 //FMNUSERB JOB (IBMGSA),
000002 //          FMNUSER,MSGCLASS=A,
000003 //          NOTIFY=FMNUSER,CLASS=A,
000004 //          MSGLEVEL=(1,1)
000005 //*
000006 //          JCLLIB ORDER=(DB2V810.DFA2.PROCLIB)
000007 //*
000008 //*****
000009 //* STEP SETPARM: OVERRIDE ANY GLOBAL DATASET SIZING VALUES HERE
000010 //*****
000011 //SETPARM SET ALLOC='TRK',PRI='1',SEC='1'
000012 //*
000013 //*****
000014 //* STEP RBIX1: REBUILD INDEX
000015 //* "FMNUSER"."XACT2"
000016 //*****
000017 //RBIX1 EXEC DSNUPROC,SYSTEM=DFA2,UID='FMNUSER'
000018 //DSNUPROC.STEPLIB DD DSN=DB2V810.DFA2.SDSNEXIT,DISP=SHR
000019 //          DD DSN=DB2.V810.SDSNLOAD,DISP=SHR
000020 //DSNUPROC.SYSUT1 DD UNIT=SYSALLDA,
000021 //          SPACE=(&ALLOC,&PRI,&SEC),RLSE)
000022 //DSNUPROC.SYSIN DD *
000023 REBUILD INDEX (
000024 "FMNUSER"."XACT2"
000025 )
000026 WORKDDN(SYSUT1) SORTDEVT SYSALLDA SORTNUM 4 SORTKEYS
000027 /*
***** ***** Bottom of Data *****

Command ==> _____ Scroll ==> PAGE
F1=Help      F2=Split    F3=Exit     F5=Rfind    F6=Rchange  F7=Up
F8=Down      F9=Swap     F10=Left   F11=Right   F12=Cancel
    
```

- If you *did* specify the name of a LISTDEF on the Db2® Utilities panel:
 - FM/Db2 displays an alternative form of the REBUILD Utility (Indexes) panel showing the specified LISTDEF and a number of editable fields that correspond to keywords in the REBUILD statement.

Related tasks

[REBUILD utility \(indexes for table spaces\) on page 359](#)

Related references

[Db2 Utilities panel on page 610](#)

[REBUILD Utility \(Indexes\) panel on page 745](#)

[REBUILD \(Indexes\) with LISTDEF panel on page 747](#)

[TEMPLATE Options \(2 of 2\) panel on page 848](#)

REBUILD utility (indexes for table spaces)

- If you did *not* specify the name of a LISTDEF on the Db2® Utilities panel:
 - If you entered information in the **Database name** or **Table/index space name** filter fields on the Db2® Utilities panel, the displayed rows are limited to the Db2® objects that match the information you specified.
 - To select a table space from those displayed, type **s** in the **Sel** column. An asterisk (*) in the **PRC** column indicates selected table spaces.
 - [Figure 89: Sample JCL generated for REBUILD Utility \(indexes for table spaces\) on page 359](#) shows an example of generated JCL for rebuilding indexes for table spaces.

Figure 89. Sample JCL generated for REBUILD Utility (indexes for table spaces)

```

File Edit Edit_Settings Menu Utilities Compilers Test Help
EDIT          FMNUSER.SPFTEMP1.CNTL                      Columns 00001 00072
***** ***** Top of Data *****
000001 //FMNUSERB JOB (IBMGSA),
000002 //          FMNUSER,MSGCLASS=A,
000003 //          NOTIFY=FMNUSER,CLASS=A,
000004 //          MSGLEVEL=(1,1)
000005 //*
000006 //          JCLLIB ORDER=(DB2V810.DFA2.PROCLIB)
000007 //*
000008 //*****
000009 //* STEP SETPARM: OVERRIDE ANY GLOBAL DATASET SIZING VALUES HERE
000010 //*****
000011 //SETPARM SET ALLOC='TRK',PRI='1',SEC='1'
000012 //*
000013 //*****
000014 //* STEP RBIX1: REBUILD INDEX ALL FOR DSN8D81A.DSN8S81D
000015 //*****
000016 //RBIX1 EXEC DSNUPROC,SYSTEM=DFA2,UID='FMNUSER'
000017 //DSNUPROC.STEPLIB DD DSN=DB2V810.DFA2.SDSNEXIT,DISP=SHR
000018 //          DD DSN=DB2.V810.SDSNLOAD,DISP=SHR
000019 //DSNUPROC.SYSUT1 DD UNIT=SYSALLDA,
000020 //          SPACE=(&ALLOC,(&PRI,&SEC),RLSE)
000021 //DSNUPROC.SYSIN DD *
000022 REBUILD INDEX (ALL) TABLESPACE DSN8D81A.DSN8S81D
000023 WORKDDN(SYSUT1) SORTDEVT SYSALLDA SORTNUM 4 SORTKEYS
000024 /*
***** ***** Bottom of Data *****

Command ==> _____ Scroll ==> PAGE
F1=Help      F2=Split    F3=Exit     F5=Rfind    F6=Rchange  F7=Up
F8=Down      F9=Swap     F10=Left    F11=Right   F12=Cancel

```

- If you *did* specify the name of a LISTDEF on the Db2® Utilities panel:
 - FM/Db2 displays an alternative form of the REBUILD (Indexes for Table Spaces) panel showing the specified LISTDEF and a number of editable fields that correspond to keywords in the REBUILD statement.

Related tasks

[REBUILD utility \(indexes\) on page 358](#)

Related references

[Db2 Utilities panel on page 610](#)

[REBUILD \(Indexes for Table Spaces\) panel on page 741](#)

[REBUILD \(Indexes for Table Spaces\) with LISTDEF panel on page 743](#)

RECOVER utility

The RECOVER utility option generates JCL to run the Db2® RECOVER utility job.

To select the RECOVER utility, enter **4** in the **Db2® Utility** input field on the Db2® Utilities panel.

If you selected Table spaces in the **Object Type** section of the panel, the RECOVER Utility (Table spaces) panel is displayed.

If you selected Index spaces in the **Object Type** section of the panel, the RECOVER Utility (Index spaces) panel is displayed.



Note: If you specified the name of a LISTDEF on the Db2® Utilities panel, FM/Db2 displays an alternative form of the RECOVER Utility (Table Spaces) panel or RECOVER Utility (Index Spaces) panel.

Related tasks

[RECOVER \(table spaces\) on page 360](#)

[RECOVER \(index spaces\) on page 362](#)

Related references

[Db2 Utilities panel on page 610](#)

[RECOVER Utility \(Table Spaces\) panel on page 751](#)

[RECOVER Utility \(Table Spaces\) with LISTDEF panel on page 753](#)

[RECOVER Utility \(Index Spaces\) panel on page 748](#)

[RECOVER Utility \(Index Spaces\) with LISTDEF panel on page 750](#)

FM/Db2 only supports the following form of the RECOVER utility statement:

```
RECOVER object TOCOPY datasetname TOVOLUME CATALOG
```

RECOVER (table spaces)

This option corresponds to the RECOVER TABLE SPACE form of the RECOVER utility control statement.

- If you did *not* specify the name of a LISTDEF on the Db2® Utilities panel:
 - The information displayed in the RECOVER Utility (Table Spaces) panel includes one row for every matching entry found in the SYSCOPY catalog table. The match is performed on database name and table space name, and the type (**Typ**) of the entry must be either *"F"* (Full image copy) or *"I"* (Partial image copy). Only cataloged

image copy data sets are supported. This means that there can be 0, 1, or many entries for any table space name.

- If you entered information in the **Database name** or **Table/index space name** filter fields on the Db2® Utilities panel, the displayed rows are limited to the Db2® objects that match the information you specified.
- To select a table space from those displayed, type **s** in the **Sel** column. An asterisk (*) in the **PRC** column indicates selected table spaces.
- [Figure 90: Sample JCL generated for RECOVER Utility \(table spaces\) on page 361](#) shows an example of generated JCL for recovering table spaces.

Figure 90. Sample JCL generated for RECOVER Utility (table spaces)

```

File Edit Edit_Settings Menu Utilities Compilers Test Help
-----
EDIT          FMNUSER.SPFTEMP1.CNTL                      Columns 00001 00072
***** ***** Top of Data *****
000001 //FMNUSERB JOB (IBMGSA),
000002 //          FMNUSER,MSGCLASS=A,
000003 //          NOTIFY=FMNUSER,CLASS=A,
000004 //          MSGLEVEL=(1,1)
000005 //*
000006 //          JCLLIB ORDER=(DB2V810.DFA2.PROCLIB)
000007 //*
000008 //*****
000009 //* STEP RECV1: RECOVER TABLESPACE DSNDB01.SCT02
000010 //*****
000011 //RECV1 EXEC DSNUPROC,SYSTEM=DFA2,UID='FMNUSER'
000012 //DSNUPROC.STEPLIB DD DSN=DB2V810.DFA2.SDSNEXIT,DISP=SHR
000013 //          DD DSN=DB2.V810.SDSNLOAD,DISP=SHR
000014 //DSNUPROC.SYSIN DD *
000015 RECOVER TABLESPACE DSNDB01.SCT02 TOCOPY
000016 DFA2.IMAGCOPY.SCT02 TOVOLUME CATALOG
000017 REBUILD INDEX (ALL) TABLESPACE DSNDB01.SCT02
000018 SORTNUM 4 SORTDEVT SYSALLDA
000019 /*
***** ***** Bottom of Data *****

Command ==> _____ Scroll ==> PAGE
F1=Help      F2=Split    F3=Exit     F5=Rfind    F6=Rchange  F7=Up
F8=Down      F9=Swap     F10=Left   F11=Right   F12=Cancel

```

- If you *did* specify the name of a LISTDEF on the Db2® Utilities panel:

- FM/Db2 displays an alternative form of the REBUILD Utility (Indexes) panel showing the specified LISTDEF and a number of editable fields that correspond to keywords in the RECOVER statement.
- [Figure 91: Sample JCL generated for RECOVER Utility \(table spaces\) with LISTDEF specified on page 362](#) shows an example of generated JCL for recovering table spaces where a LISTDEF has been specified.

Figure 91. Sample JCL generated for RECOVER Utility (table spaces) with LISTDEF specified

```

File Edit Edit_Settings Menu Utilities Compilers Test Help
-----
EDIT          FMNUSER.SPFTEMP1.CNTL                      Columns 00001 00072
***** ***** Top of Data *****
000001 //FMNUSERB JOB (IBMGSA),
000002 //          FMNUSER,MSGCLASS=A,
000003 //          NOTIFY=FMNUSER,CLASS=A,
000004 //          MSGLEVEL=(1,1)
000005 //*
000006 //          JCLLIB ORDER=(DB2V810.DFA2.PROCLIB)
000007 //*
000008 //*****
000009 //* STEP RECV1: RECOVER TABLESPACE LIST LDEFNAME1
000010 //*****
000011 //RECV1 EXEC DSNUPROC,SYSTEM=DFA2,UID='FMNUSER'
000012 //DSNUPROC.STEPLIB DD DSN=DB2V810.DFA2.SDSNEXIT,DISP=SHR
000013 //          DD DSN=DB2.V810.SDSNLOAD,DISP=SHR
000014 //DSNUPROC.SYSIN DD *
000015 RECOVER LIST LDEFNAME1
000016 /*
***** ***** Bottom of Data *****

Command ==> _____ Scroll ==> PAGE
F1=Help      F2=Split      F3=Exit      F5=Rfind     F6=Rchange   F7=Up
F8=Down     F9=Swap       F10=Left     F11=Right    F12=Cancel

```

Related tasks

[RECOVER \(index spaces\) on page 362](#)

Related references

- [Db2 Utilities panel on page 610](#)
- [RECOVER Utility \(Table Spaces\) panel on page 751](#)
- [RECOVER Utility \(Table Spaces\) with LISTDEF panel on page 753](#)

RECOVER (index spaces)

This option corresponds to the RECOVER INDEXSPACE form of the RECOVER utility control statement.

- If you did *not* specify the name of a LISTDEF on the Db2® Utilities panel:
 - If you entered information in the **Database name** or **Table/index space name** filter fields on the Db2® Utilities panel, the displayed rows are limited to the Db2® objects that match the information you specified.
 - To select an index space from those displayed, type **s** in the **Sel** column. An asterisk (*) in the **PRC** column indicates selected index spaces.

- [Figure 92: Sample JCL generated for RECOVER Utility \(index spaces\) on page 363](#) shows an example of generated JCL for recovering index spaces.

Figure 92. Sample JCL generated for RECOVER Utility (index spaces)

```

File Edit Edit_Settings Menu Utilities Compilers Test Help
EDIT          FMNUSER.SPFTEMP1.CNTL                      Columns 00001 00072
*****
***** Top of Data *****
000001 //FMNUSERB JOB (IBMGSA),
000002 //          FMNUSER,MSGCLASS=A,
000003 //          NOTIFY=FMNUSER,CLASS=A,
000004 //          MSGLEVEL=(1,1)
000005 //*
000006 //          JCLLIB ORDER=(DB2V810.DFA2.PROCLIB)
000007 //*
000008 //*****
000009 //* STEP RECV1: RECOVER INDEXSPACE JLV3D81A.XDEPT2
000010 //*****
000011 //RECV1 EXEC DSNUPROC,SYSTEM=DFA2,UID='FMNUSER'
000012 //DSNUPROC.STEPLIB DD DSN=DB2V810.DFA2.SDSNEXIT,DISP=SHR
000013 //          DD DSN=DB2.V810.SDSNLOAD,DISP=SHR
000014 //DSNUPROC.SYSIN DD *
000015 RECOVER INDEXSPACE JLV3D81A.XDEPT2 TOCOPY
000016 SHRIKES.JLV3D81A.XDEPT2.F00000.D2541023 TOVOLUME CATALOG
000017 /*
*****
***** Bottom of Data *****

Command ==>
F1=Help      F2=Split    F3=Exit     F5=Rfind    F6=Rchange  F7=Up
F8=Down     F9=Swap     F10=Left   F11=Right   F12=Cancel

```

- If you *did* specify the name of a LISTDEF on the Db2® Utilities panel:
 - FM/Db2 displays an alternative form of the RECOVER Utility (Index Spaces) panel showing the specified LISTDEF and a number of editable fields that correspond to keywords in the RECOVER statement.

Related tasks

[RECOVER \(table spaces\) on page 360](#)

Related references

[Db2 Utilities panel on page 610](#)

[RECOVER Utility \(Index Spaces\) panel on page 748](#)

[RECOVER Utility \(Index Spaces\) with LISTDEF panel on page 750](#)

REORG utility

To select the REORG utility, enter **5** in the **Db2® Utility** input field on the Db2® Utilities panel.

If you selected Table spaces in the **Object Type** section of the panel, the REORG Utility (Table spaces) panel is displayed.

If you selected Indexes in the **Object Type** section of the panel, the REORG Utility (Indexes) panel is displayed.



Note: If you specified the name of a LISTDEF on the Db2® Utilities panel, FM/Db2 displays an alternative form of the REORG Utility (Table spaces) panel or REORG Utility (Indexes) panel.

Related tasks

[REORG \(table spaces\) on page 364](#)

[REORG \(indexes\) on page 366](#)

Related references

[Db2 Utilities panel on page 610](#)

[REORG Utility \(Table Spaces\) panel on page 763](#)

[REORG Utility \(Table Spaces\) with LISTDEF panel on page 765](#)

[REORG Utility \(Indexes\) panel on page 760](#)

[REORG Utility \(Indexes\) with LISTDEF panel on page 761](#)

REORG (table spaces)

To include a UNLDDN clause in the generated REORG statement, specify the required template name in **UNLDDN template name** for the REORG TABLESPACE statement on the second TEMPLATE Options panel.



Note: The **Unload External** option on the REORG Utility (Table Spaces) panel for the selected table space must be set to "Y".

This option corresponds to the REORG TABLE SPACE utility control statement.

- If you did *not* specify the name of a LISTDEF on the Db2® Utilities panel:
 - If you entered information in the **Database name** or **Table/index space name** filter fields on the Db2® Utilities panel, the displayed rows are limited to the Db2® objects that match the information you specified.
 - To select a table space from those displayed, type **s** in the **Sel** column. An asterisk (*) in the **PRC** column indicates selected table spaces.

- Figure 93: Sample JCL generated for REORG Utility (table spaces) on page 365 shows an example of generated JCL for reorganizing table spaces.

Figure 93. Sample JCL generated for REORG Utility (table spaces)

```

File Edit Edit_Settings Menu Utilities Compilers Test Help
EDIT          FMNUSER.SPFTEMP1.CNTL                      Columns 00001 00072
*****
***** Top of Data *****
000001 //FMNUSERB JOB (IBMGSA),
000002 //          FMNUSER,MSGCLASS=A,
000003 //          NOTIFY=FMNUSER,CLASS=A,
000004 //          MSGLEVEL=(1,1)
000005 //*
000006 //          JCLLIB ORDER=(DB2V810.DFA2.PROCLIB)
000007 //*
000008 //*****
000009 //* STEP SETPARM: OVERRIDE ANY GLOBAL DATASET SIZING VALUES HERE
000010 //*****
000011 //SETPARM SET ALLOC='TRK',PRI='1',SEC='1'
000012 //*
000013 //*****
000014 //* STEP RORG1: REORG TABLESPACE DSN8D81A.DSN8S81D
000015 //*****
000016 //RORG1 EXEC DSNUPROC,SYSTEM=DFA2,UID='FMNUSER'
000017 //DSNUPROC.STEPLIB DD DSN=DB2V810.DFA2.SDSNEXIT,DISP=SHR
000018 //          DD DSN=DB2.V810.SDSNLOAD,DISP=SHR
000019 //DSNUPROC.SYSREC DD UNIT=SYSALLDA,
000020 //          SPACE=(&ALLOC,&PRI,&SEC),RLSE)
000021 //DSNUPROC.SYSUT1 DD UNIT=SYSALLDA,
000022 //          SPACE=(&ALLOC,&PRI,&SEC),RLSE)
000023 //DSNUPROC.SORTOUT DD UNIT=SYSALLDA,
000024 //          SPACE=(&ALLOC,&PRI,&SEC),RLSE)
000025 //DSNUPROC.SYSIN DD *
000026 REORG TABLESPACE DSN8D81A.DSN8S81D LOG NO
000027 SORTDATA
000028 /*
*****
***** Bottom of Data *****

Command ==>
F1=Help      F2=Split    F3=Exit     F5=Rfind    F6=Rchange  F7=Up
F8=Down      F9=Swap     F10=Left   F11=Right   F12=Cancel
Scroll ==> PAGE

```

- If you *did* specify the name of a LISTDEF on the Db2® Utilities panel:

- FM/Db2 displays an alternative form of the REORG (Table Spaces) panel showing the specified LISTDEF and a number of editable fields that correspond to keywords in the REORG statement.
- [Figure 94: Sample JCL generated for REORG Utility \(table spaces\) with LISTDEF specified on page 366](#) shows an example of generated JCL for recovering table spaces where a LISTDEF has been specified.

Figure 94. Sample JCL generated for REORG Utility (table spaces) with LISTDEF specified

```

File Edit Edit_Settings Menu Utilities Compilers Test Help
-----
EDIT          FMNUSER.SPFTEMP1.CNTL                      Columns 00001 00072
***** ***** Top of Data *****
000001 //FMNUSERB JOB (IBMGSA),
000002 //          FMNUSER,MSGCLASS=A,
000003 //          NOTIFY=FMNUSER,CLASS=A,
000004 //          MSGLEVEL=(1,1)
000005 //*
000006 //          JCLLIB ORDER=(DB2V810.DFA2.PROCLIB)
000007 //*
000008 //*****
000009 //* STEP SETPARM: OVERRIDE ANY GLOBAL DATASET SIZING VALUES HERE
000010 //*****
000011 //SETPARM SET ALLOC='TRK',PRI='1',SEC='1'
000012 //*
000013 //*****
000014 //* STEP RORG1: REORG TABLESPACE LIST LDEFNAME1
000015 //*****
000016 //RORG1 EXEC DSNUPROC,SYSTEM=DFA2,UID='FMNUSER'
000017 //DSNUPROC.STEPLIB DD DSN=DB2V810.DFA2.SDSNEXIT,DISP=SHR
000018 //          DD DSN=DB2.V810.SDSNLOAD,DISP=SHR
000019 //DSNUPROC.SYSREC DD UNIT=SYSALLDA,
000020 //          SPACE=(&ALLOC,(&PRI,&SEC),RLSE)
000021 //DSNUPROC.SYSUT1 DD UNIT=SYSALLDA,
000022 //          SPACE=(&ALLOC,(&PRI,&SEC),RLSE)
000023 //DSNUPROC.SORTOUT DD UNIT=SYSALLDA,
000024 //          SPACE=(&ALLOC,(&PRI,&SEC),RLSE)
000025 //DSNUPROC.SYSIN DD *
000026 REORG TABLESPACE LIST LDEFNAME1 LOG NO
000027 SORTDATA
000028 /*
***** ***** Bottom of Data *****

Command ==> _____ Scroll ==> PAGE
F1=Help      F2=Split    F3=Exit     F5=Rfind    F6=Rchange  F7=Up
F8=Down     F9=Swap     F10=Left    F11=Right   F12=Cancel

```

Related tasks

- [REORG \(indexes\) on page 366](#)
- [Setting options for Db2 utilities on page 341](#)

Related references

- [Db2 Utilities panel on page 610](#)
- [TEMPLATE Options \(2 of 2\) panel on page 848](#)
- [REORG Utility \(Table Spaces\) panel on page 763](#)
- [REORG Utility \(Table Spaces\) with LISTDEF panel on page 765](#)

REORG (indexes)

This option corresponds to the REORG INDEX utility control statement.

- If you did *not* specify the name of a LISTDEF on the Db2® Utilities panel:
 - If you entered information in the **Database name**, **Table/index owner**, or **Table/index name** filter fields on the Db2® Utilities panel, the displayed rows are limited to the Db2® objects that match the information you specified.
 - To select an index from those displayed, type **s** in the **Sel** column. An asterisk (*) in the **PRC** column indicates selected indexes.
 - [Figure 95: Sample JCL generated for REORG Utility \(indexes\) on page 367](#) shows an example of generated JCL for reorganizing indexes.

Figure 95. Sample JCL generated for REORG Utility (indexes)

```

File Edit Edit_Settings Menu Utilities Compilers Test Help
-----
EDIT          FMNUSER.SPFTEMP1.CNTL                      Columns 00001 00072
***** ***** Top of Data *****
000001 //FMNUSERB JOB (IBMGSA),
000002 //          FMNUSER,MSGCLASS=A,
000003 //          NOTIFY=FMNUSER,CLASS=A,
000004 //          MSGLEVEL=(1,1)
000005 //*
000006 //          JCLLIB ORDER=(DB2V810.DFA2.PROCLIB)
000007 //*
000008 //*****
000009 //* STEP SETPARM: OVERRIDE ANY GLOBAL DATASET SIZING VALUES HERE
000010 //*****
000011 //SETPARM SET ALLOC='TRK',PRI='1',SEC='1'
000012 //*
000013 //*****
000014 //* STEP RORG1: REORG INDEX
000015 //* "BUDGER2"."PLAN_TABLE_HINT_IX"
000016 //*****
000017 //RORG1 EXEC DSNUPROC,SYSTEM=DFA2,UID='FMNUSER'
000018 //DSNUPROC.STEPLIB DD DSN=DB2V810.DFA2.SDSNEXIT,DISP=SHR
000019 //          DD DSN=DB2.V810.SDSNLOAD,DISP=SHR
000020 //DSNUPROC.SYSREC DD UNIT=SYSALLDA,
000021 //          SPACE=(&ALLOC,(&PRI,&SEC),RLSE)
000022 //DSNUPROC.SYSUT1 DD UNIT=SYSALLDA,
000023 //          SPACE=(&ALLOC,(&PRI,&SEC),RLSE)
000024 //DSNUPROC.SORTOUT DD UNIT=SYSALLDA,
000025 //          SPACE=(&ALLOC,(&PRI,&SEC),RLSE)
000026 //DSNUPROC.SYSIN DD *
000027 REORG INDEX
000028 "BUDGER2"."PLAN_TABLE_HINT_IX"
000029 /*
***** ***** Bottom of Data *****

Command ==> _____ Scroll ==> PAGE
F1=Help      F2=Split    F3=Exit     F5=Rfind    F6=Rchange  F7=Up
F8=Down      F9=Swap     F10=Left    F11=Right   F12=Cancel

```

- If you *did* specify the name of a LISTDEF on the Db2® Utilities panel:

- FM/Db2 displays an alternative form of the REORG (indexes) panel showing the specified LISTDEF and a number of editable fields that correspond to keywords in the REORG statement.
- [Figure 96: Sample JCL generated for REORG Utility \(indexes\) with LISTDEF specified on page 368](#) shows an example of generated JCL for recovering table spaces where a LISTDEF has been specified.

Figure 96. Sample JCL generated for REORG Utility (indexes) with LISTDEF specified

```

File Edit Edit_Settings Menu Utilities Compilers Test Help
EDIT          FMNUSER.SPFTEMP1.CNTL                      Columns 00001 00072
***** ***** Top of Data *****
000001 //FMNUSERB JOB (IBMGSA),
000002 //          FMNUSER,MSGCLASS=A,
000003 //          NOTIFY=FMNUSER,CLASS=A,
000004 //          MSGLEVEL=(1,1)
000005 //*
000006 //          JCLLIB ORDER=(DB2V810.DFA2.PROCLIB)
000007 //*
000008 //*****
000009 //* STEP SETPARM: OVERRIDE ANY GLOBAL DATASET SIZING VALUES HERE
000010 //*****
000011 //SETPARM SET ALLOC='TRK',PRI='1',SEC='1'
000012 //*
000013 //*****
000014 //* STEP RORG1: REORG INDEX LIST LDEF1
000015 //*****
000016 //RORG1      EXEC DSNUPROC,SYSTEM=DFA2,UID='FMNUSER'
000017 //DSNUPROC.STEPLIB DD DSN=DB2V810.DFA2.SDSNEXIT,DISP=SHR
000018 //          DD DSN=DB2.V810.SDSNLOAD,DISP=SHR
000019 //DSNUPROC.SYSREC  DD UNIT=SYSALLDA,
000020 //          SPACE=(&ALLOC,(&PRI,&SEC),RLSE)
000021 //DSNUPROC.SYSUT1  DD UNIT=SYSALLDA,
000022 //          SPACE=(&ALLOC,(&PRI,&SEC),RLSE)
000023 //DSNUPROC.SORTOUT DD UNIT=SYSALLDA,
000024 //          SPACE=(&ALLOC,(&PRI,&SEC),RLSE)
000025 //DSNUPROC.SYSIN   DD *
000026 REORG INDEX LIST LDEF1
000027 /*
***** ***** Bottom of Data *****

Command ==> _____ Scroll ==> PAGE
F1=Help      F2=Split    F3=Exit      F5=Rfind     F6=Rchange   F7=Up
F8=Down     F9=Swap     F10=Left    F11=Right   F12=Cancel

```

Related tasks

[REORG \(table spaces\) on page 364](#)

Related references

- [Db2 Utilities panel on page 610](#)
- [REORG Utility \(Indexes\) panel on page 760](#)
- [REORG Utility \(Indexes\) with LISTDEF panel on page 761](#)

RUNSTATS utility

To select the RUNSTATS utility, enter **6** in the **Db2® Utility** input field on the Db2® Utilities panel.

If you selected Table spaces in the **Object Type** section of the panel, the Runstats Utility (Table spaces) panel is displayed.

If you selected Indexes in the **Object Type** section of the panel, the Runstats Utility (Indexes) panel is displayed.



Note: If you specified the name of a LISTDEF on the Db2® Utilities panel, FM/Db2 displays an alternative form of the Runstats Utility (Table spaces) panel or Runstats Utility (Indexes) panel.

Related tasks

[RUNSTATS \(table spaces\) on page 369](#)

[RUNSTATS \(indexes\) on page 370](#)

Related references

[Db2 Utilities panel on page 610](#)

[RUNSTATS Utility \(Table Spaces\) panel on page 775](#)

[RUNSTATS Utility \(Table Spaces\) with LISTDEF panel on page 777](#)

[RUNSTATS Utility \(Indexes\) panel on page 772](#)

[RUNSTATS Utility \(Indexes\) with LISTDEF panel on page 774](#)

RUNSTATS (table spaces)

This option corresponds to the RUNSTATS TABLE SPACE form of the RUNSTATS utility control statement.

- If you did *not* specify the name of a LISTDEF on the Db2® Utilities panel:
 - If you entered information in the **Database name** or **Table/index space name** filter fields on the Db2® Utilities panel, the displayed rows are limited to the Db2® objects that match the information you specified.
 - To select a table space from those displayed, type **s** in the **Sel** column. An asterisk (*) in the **PRC** column indicates selected table spaces.
 - [Figure 97: Sample JCL generated for RUNSTATS Utility \(table spaces\) on page 369](#) shows an example of generated JCL for gathering statistics on a table space.

Figure 97. Sample JCL generated for RUNSTATS Utility (table spaces)

```

File Edit Edit_Settings Menu Utilities Compilers Test Help
-----
EDIT          FMNUSER,SPFTEMP1.CNTL                      Columns 00001 00072
***** ***** Top of Data *****
000001 //FMNUSERB JOB (IBMGSA),
000002 //          FMNUSER,MSGCLASS=A,
000003 //          NOTIFY=FMNUSER,CLASS=A,
000004 //          MSGLEVEL=(1,1)
000005 //*
000006 //          JCLLIB ORDER=(DB2V810.DFA2.PROCLIB)
000007 //*
000008 //*****
000009 //* STEP STAT1: RUNSTAT TABLESPACE DSN8D81A.DSN8S81D
000010 //*****
000011 //STAT1 EXEC DSNUPROC,SYSTEM=DFA2,UID='FMNUSER'
000012 //DSNUPROC.STEPLIB DD DSN=DB2V810.DFA2.SDSNEXIT,DISP=SHR
000013 //          DD DSN=DB2.V810.SDSNLOAD,DISP=SHR
000014 //DSNUPROC.SYSIN DD *
000015 RUNSTATS TABLESPACE DSN8D81A.DSN8S81D
000016 UPDATE ALL
000017 /*
***** ***** Bottom of Data *****

Command ==> _____ Scroll ==> PAGE
F1=Help      F2=Split      F3=Exit      F5=Rfind     F6=Rchange   F7=Up
F8=Down      F9=Swap       F10=Left     F11=Right    F12=Cancel

```

- If you *did* specify the name of a LISTDEF on the Db2® Utilities panel:
 - FM/Db2 displays an alternative form of the RUNSTATS Utility (Table Spaces) panel showing the specified LISTDEF and a number of editable fields that correspond to keywords in the RUNSTATS statement.
 - [Figure 98: Sample JCL generated for RUNSTATS \(table spaces\) with LISTDEF specified on page 370](#) shows an example of generated JCL for recovering table spaces where a LISTDEF has been specified.

Figure 98. Sample JCL generated for RUNSTATS (table spaces) with LISTDEF specified

```

File Edit Edit_Settings Menu Utilities Compilers Test Help
-----
EDIT          FMNUSER.SPFTEMP1.CNTL                      Columns 00001 00072
***** ***** Top of Data *****
000001 //FMNUSERB JOB (IBMGSA),
000002 //          FMNUSER,MSGCLASS=A,
000003 //          NOTIFY=FMNUSER,CLASS=A,
000004 //          MSGLEVEL=(1,1)
000005 //*
000006 //          JCLLIB ORDER=(DB2V810.DFA2.PROCLIB)
000007 //*
000008 //*****
000009 //* STEP STAT1: RUNSTAT TABLESPACE LIST LDEFNAME1
000010 //*****
000011 //STAT1 EXEC DSNUPROC,SYSTEM=DFA2,UID='FMNUSER'
000012 //DSNUPROC.STEPLIB DD DSN=DB2V810.DFA2.SDSNEXIT,DISP=SHR
000013 //          DD DSN=DB2.V810.SDSNLOAD,DISP=SHR
000014 //DSNUPROC.SYSIN DD *
000015 RUNSTATS TABLESPACE LIST LDEFNAME1
000016 UPDATE ALL
000017 /*
***** ***** Bottom of Data *****

Command ==>
F1=Help      F2=Split    F3=Exit     F5=Rfind    F6=Rchange  F7=Up
F8=Down      F9=Swap     F10=Left   F11=Right   F12=Cancel
    
```

Related tasks

[RUNSTATS \(indexes\) on page 370](#)

Related references

- [Db2 Utilities panel on page 610](#)
- [RUNSTATS Utility \(Table Spaces\) panel on page 775](#)
- [RUNSTATS Utility \(Table Spaces\) with LISTDEF panel on page 777](#)

RUNSTATS (indexes)

This option corresponds to the RUNSTATS INDEX form of the RUNSTATS utility control statement.

- If you did *not* specify the name of a LISTDEF on the Db2® Utilities panel:
 - If you entered information in the **Database name**, **Table/index owner**, or **Table/index space name** filter fields on the Db2® Utilities panel, the displayed rows are limited to the Db2® objects that match the information you specified.
 - To select an index from those displayed, type **s** in the **Sel** column. An asterisk (*) in the **PRC** column indicates selected indexes.

- [Figure 99: Sample JCL generated for RUNSTATS Utility \(indexes\) on page 371](#) shows an example of generated JCL for gathering statistics on indexes.

Figure 99. Sample JCL generated for RUNSTATS Utility (indexes)

```

File Edit Edit_Settings Menu Utilities Compilers Test Help
EDIT          FMNUSER.SPFTEMP1.CNTL                      Columns 00001 00072
***** ***** Top of Data *****
000001 //FMNUSERB JOB (IBMGSA),
000002 //          FMNUSER,MSGCLASS=A,
000003 //          NOTIFY=FMNUSER,CLASS=A,
000004 //          MSGLEVEL=(1,1)
000005 //*
000006 //          JCLLIB ORDER=(DB2V810.DFA2.PROCLIB)
000007 //*
000008 //*****
000009 //* STEP STAT1: RUNSTAT INDEX
000010 //* "BUDGER2"."PLAN_TABLE_HINT_IX"
000011 //*****
000012 //STAT1 EXEC DSNUPROC,SYSTEM=DFA2,UID='FMNUSER'
000013 //DSNUPROC.STEPLIB DD DSN=DB2V810.DFA2.SDSNEXIT,DISP=SHR
000014 //          DD DSN=DB2.V810.SDSNLOAD,DISP=SHR
000015 //DSNUPROC.SYSIN DD *
000016 RUNSTATS INDEX (
000017 "BUDGER2"."PLAN_TABLE_HINT_IX"
000018 )
000019 UPDATE ALL
000020 /*
***** ***** Bottom of Data *****

Command ==> _____ Scroll ==> PAGE
F1=Help      F2=Split    F3=Exit     F5=Rfind    F6=Rchange  F7=Up
F8=Down      F9=Swap     F10=Left   F11=Right   F12=Cancel

```

- If you *did* specify the name of a LISTDEF on the Db2® Utilities panel:
 - FM/Db2 displays an alternative form of the RUNSTATS Utility (Indexes) panel showing the specified LISTDEF and a number of editable fields that correspond to keywords in the RUNSTATS statement.
 - [Figure 100: Sample JCL generated for RUNSTATS \(indexes\) with LISTDEF specified on page 371](#) shows an example of generated JCL for recovering table spaces where a LISTDEF has been specified.

Figure 100. Sample JCL generated for RUNSTATS (indexes) with LISTDEF specified

```

File Edit Edit_Settings Menu Utilities Compilers Test Help
EDIT          FMNUSER.SPFTEMP1.CNTL                      Columns 00001 00072
***** ***** Top of Data *****
000001 //FMNUSERB JOB (IBMGSA),
000002 //          FMNUSER,MSGCLASS=A,
000003 //          NOTIFY=FMNUSER,CLASS=A,
000004 //          MSGLEVEL=(1,1)
000005 //*
000006 //          JCLLIB ORDER=(DB2V810.DFA2.PROCLIB)
000007 //*
000008 //*****
000009 //* STEP STAT1: RUNSTAT INDEX LIST LDEFNAME1
000010 //*****
000011 //STAT1 EXEC DSNUPROC,SYSTEM=DFA2,UID='FMNUSER'
000012 //DSNUPROC.STEPLIB DD DSN=DB2V810.DFA2.SDSNEXIT,DISP=SHR
000013 //          DD DSN=DB2.V810.SDSNLOAD,DISP=SHR
000014 //DSNUPROC.SYSIN DD *
000015 RUNSTATS INDEX LIST LDEFNAME1
000016 UPDATE ALL
000017 /*
***** ***** Bottom of Data *****

Command ==> _____ Scroll ==> PAGE
F1=Help      F2=Split    F3=Exit     F5=Rfind    F6=Rchange  F7=Up
F8=Down      F9=Swap     F10=Left   F11=Right   F12=Cancel

```

Related tasks

[RUNSTATS \(table spaces\) on page 369](#)

Related references

[Db2 Utilities panel on page 610](#)

[RUNSTATS Utility \(Indexes\) panel on page 772](#)

[RUNSTATS Utility \(Indexes\) with LISTDEF panel on page 774](#)

UNLOAD utility

The UNLOAD utility unloads data from one or more source objects to one or more sequential data sets in external format. It is the preferred method for unloading or transferring large amounts of data.

You can specify the Db2® templates that identify the data set to receive the LOAD utility control statements (PUNCHDDN clause) and the data sets into which the data is unloaded (UNLDDN clause).

To select the UNLOAD utility, enter **7** in the **Db2® utility** input field on the Db2® Utilities panel.

If you selected *"Tables"* in the **Object Type** section of the Db2® Utilities panel, the UNLOAD Utility (Tables) panel is displayed.

If you selected *"Table spaces"* in the **Object Type** section of the Db2® Utilities panel, the UNLOAD Utility (Table Spaces) panel is displayed.



Note: If you specified the name of a LISTDEF on the Db2® Utilities panel, FM/Db2 displays an alternative form of the UNLOAD Utility (Tables) panel or UNLOAD Utility (Table Spaces) panel.

Related tasks

[UNLOAD \(tables\) on page 373](#)

[UNLOAD \(table spaces\) on page 378](#)

[Setting options for Db2 utilities on page 341](#)

Related references

[Db2 Utilities panel on page 610](#)

[TEMPLATE Options \(2 of 2\) panel on page 848](#)

[UNLOAD Utility \(Tables\) "From" panel on page 860](#)

[UNLOAD Utility \(Tables\) "To" panel on page 861](#)

[UNLOAD Utility \(Tables\) with LISTDEF panel on page 863](#)

[UNLOAD Utility \(Table Spaces\) panel on page 857](#)

[UNLOAD Utility \(Table Spaces\) with LISTDEF panel on page 858](#)

UNLOAD (tables)

Use the UNLOAD (tables) utility to unload data into a sequential data set. You can choose to replace any existing data with the new data, or to add the new data to the data already in the data set. The UNLOAD (tables) utility provides the most efficient means of adding large amounts of data to a data set.

When you use the UNLOAD utility, you can:

- Select the columns to be unloaded by specifying the required columns in the “*From*” template
- Reformat data during the unload by mapping table columns to fields in the output data set (as defined by a template)
- Create and save a File Manager Base component template that describes the unloaded data
- Select which rows to unload
- Specify the number of rows to be unloaded

To include a PUNCHDDN clause in the generated UNLOAD statement, specify the required template name in **PUNCHDDN template name** on the second TEMPLATE Options panel.

To include a UNLDDN clause in the generated UNLOAD statement, specify the required template name in **UNLDDN template name** for the UNLOAD statement on the second TEMPLATE Options panel.

The following description applies if you did *not* specify the name of a LISTDEF on the Db2® Utilities panel. If you *did* specify the name of a LISTDEF on the Db2® Utilities panel, see [UNLOAD \(tables\) with LISTDEF specified on page 378](#).

On the UNLOAD Utility (Tables) panel:

1. The table name details you entered on the Db2® Utilities panel are copied to the UNLOAD Utility (Tables) panel. If you do not want to unload all of the rows in the source table, specify the number of rows you want to unload in the **Unload Count** field.
2. If you are using a specific template for the source table, specify the name of the template in the **From Template** entry fields.
3. In the **Processing Options**, specify the template you want FM/Db2 to use for the source table, and whether you want to edit the template before FM/Db2 builds the utility batch job.
4. To proceed, press Enter.

If you selected the **Edit template** option, FM/Db2 displays the Column Selection/Edit panel. Use this panel to restrict the data in the source table by:

- Selecting or deselecting specific columns for unloading
- Specifying row selection criteria. FM/Db2 selects only the rows whose contents satisfy the criteria for unloading

For example, the template shown in [Figure 101: Column Selection/Edit panel showing row selection criteria and selected columns on page 374](#) has been edited to select certain columns and only rows whose contents meet certain criteria. If you use this template as the “*From*” template for an unload, the data unloaded is restricted to:

- The columns FIRSTNAME, LASTNAME, WORKDEPT, and JOB, but only where WORKDEPT equals “MNT” and JOB equals “PAINTER”.

Figure 101. Column Selection/Edit panel showing row selection criteria and selected columns

Process	Options	Utilities	Help						
FM/Db2 (DFG2)	Column Selection/Edit		Line 1 of 16						
TABLE FMUSER.EMP									
----- Row Selection Criteria ---- (Use SQL/PF4 for full screen edit) -----									
1 Sel: WHERE WORKDEPT = 'MNT' AND JOB = 'PAINTER' +									
Cmd	Seq	SHEX	CL#	Column name	Data type(length)	Null	Default	Order	A/D
**** Top of data ****									
---	---		1	EMPNO	CHARACTER(6)		None	---	--
---	---	S	2	FIRSTNME	VARCHAR(12)		None	---	--
---	---		3	MIDINIT	CHARACTER(1)		None	---	--
---	---	S	4	LASTNAME	VARCHAR(15)		None	---	--
---	---	S	5	WORKDEPT	CHARACTER(3)	Y	Null	---	--
---	---		6	PHONENO	CHARACTER(4)	Y	Null	---	--
---	---		7	HIREDATE	DATE	Y	Null	---	--
---	---	S	8	JOB	CHARACTER(8)	Y	Null	---	--
---	---		9	EDLEVEL	SMALLINT	Y	Null	---	--
---	---		10	SEX	CHARACTER(1)	Y	Null	---	--
---	---		11	BIRTHDATE	DATE	Y	Null	---	--
---	---		12	SALARY	DECIMAL(9,2)	Y	Null	---	--
Command ==>				-----				Scroll PAGE	
F1=Help		F2=Split		F3=Exit		F4=SQL		F5=RFind	
F7=Up		F8=Down		F9=Swap		F10=Left		F11=Right	
								F6=RunTemp	
								F12=Cancel	

If you did not select the **Edit template** option (or have completed the edit of the template option), and the value of the **UNLDDN template name** field on the TEMPLATE Options (2 of 2) panel is blank, FM/Db2 displays the UNLOAD Utility “To” panel.



Note: If the **UNLDDN template name** field is not blank, FM/Db2 does not display the UNLOAD Utility “To” panel as the output is already defined.

- To temporarily change the settings for the UNLOAD options that FM/Db2 uses in building the current batch job, select **Edit UNLOAD utility options** to display the UNLOAD Options panel.

If you change any of the original settings, they remain in effect only for as long as you use the Db2® Utilities UNLOAD feature in which the settings were changed. If you exit from the UNLOAD Utility (Tables) panel and return to this panel later, the settings changed in the previous UNLOAD session are unavailable.

- On the UNLOAD Utility “To” panel, specify the sequential data set that is the target of the unload by entering the “To” data set details using the **Data set name** and, optionally, **Volume**, entry fields.
- If you are using a specific template or copybook for the “To” data set, you can specify the name of the template or copybook data set and, optionally, the member name, in the **To Data Template or Copybook** entry fields.

The data format used by the Db2® UNLOAD utility is fixed. Therefore, if you specify a copybook or template data set, the copybook or template should reflect the Db2® UNLOAD data format to avoid data mismatch problems.

When a template is specified for the Db2® unload data set, it must be a File Manager Base component template; a FM/Db2 template cannot be used.

When the **Allow padding** option on the Db2® UNLOAD utility options panel is not selected, FM/Db2 cannot generate a template that describes the unloaded data. In this situation, all fields related to template processing are protected when the UNLOAD utility “To” panel is displayed and the template usage option is set to 5 (NONE).

- Select the **Template usage** and **Disposition** options you want.

9. You can review the Db2® UNLOAD options by selecting the **View UNLOAD options** field. No changes can be made when the Db2® UNLOAD utility options panel is displayed. To make changes return to the Db2® UNLOAD utility *“From”* panel and select **Edit UNLOAD options**.
10. To edit the template mapping for the source table, select **Edit template mapping** to display the Template Mapping panel.
11. To proceed, press Enter.

FM/Db2 builds a batch job to execute the Db2® UNLOAD utility job using the specified input details.

Figure 102: Sample JCL generated for UNLOAD (Tables) on page 376 shows an example of the generated JCL for unloading a table object.

Figure 102. Sample JCL generated for UNLOAD (Tables)

```

File Edit Edit_Settings Menu Utilities Compilers Test Help
EDIT FMUSER.SPFTEMP1.CNTL Columns 00001 00072
***** ***** Top of Data *****
000001 //FMUSERB JOB (IBMGSA),
000002 // FMUSER,MSGCLASS=A,
000003 // NOTIFY=FMUSER,CLASS=A,
000004 // MSGLEVEL=(1,1)
000005 //*
000006 // JCLLIB ORDER=(DB2V810.DFA2.PROCLIB)
000007 //*
000008 //*****
000009 //*
000010 //* FM/Db2 GENERATED JOB TO UNLOAD A TABLE
000011 //*
000012 //*****
000013 //*
000014 //*****
000015 //* STEP UNLOAD: UNLOAD FROM TABLE
000016 //* "FMUSER"."EMP"
000017 //*****
000018 //UNLOAD1 EXEC DSNUPROC,SYSTEM=DFA2,UID='FMUSER'
000019 //DSNUPROC.STEPLIB DD DSN=DB2V810.DFA2.SDSNEXIT,DISP=SHR
000020 // DD DSN=DB2.V810.SDSNLOAD,DISP=SHR
000021 //DSNUPROC.SYSREC00 DD DISP=(MOD,CATLG,DELETE),UNIT=SYSALLDA,
000022 // BLKSIZE=0,
000023 // AVGREC=U,
000024 // LRECL=82,RECFM=FB,DSORG=PS,
000025 // SPACE=(82,(42,4),RLSE),
000026 // DSN=FMUSER.FRED
000027 //DSNUPROC.SYSPUNCH DD DISP=(NEW,CATLG,DELETE),UTIL CONTRL DATA
000028 // UNIT=SYSALLDA,SPACE=(TRK,(1,1),RLSE),
000029 // DSN=FMUSER.FMUSER.EMP.D2581536.SYSPUNCH
000030 //DSNUPROC.SYSIN DD *
000031 UNLOAD DATA FROM TABLE
000032 "FMUSER"."EMP"
000033 HEADER NONE
000034 LIMIT ALL
000035 (
000036 "FIRSTNME " POSITION(1 ) VARCHAR
000037 ,"LASTNAME " POSITION(15 ) VARCHAR
000038 ,"WORKDEPT " POSITION(33 ) CHAR(3)
000039 ,"JOB " POSITION(38 ) CHAR(8)
000040 ,"BONUS " POSITION(48 ) DECIMAL
000041 ,"COMM " POSITION(66 ) DECIMAL
000042 )
000043 WHEN
000044 (
000045 "WORKDEPT" = 'MAINT' AND "JOB" = 'PAINTER'
000046 )
000047 UNLDDN(SYSREC00)
000048 NOSUBS
000049 /*
***** ***** Bottom of Data *****

Command ==> Scroll ==> PAGE
F1=Help F2=Split F3=Exit F5=Rfind F6=Rchange F7=Up
F8=Down F9=Swap F10=Left F11=Right F12=Cancel

```

Related tasks

- [Working with templates on page 72](#)
- [Editing a template on page 81](#)
- [Letting FM/Db2 do the mapping on page 110](#)
- [Setting options for Db2 utilities on page 341](#)

Related references

- [Column Selection/Edit panel on page 485](#)
- [UNLOAD Utility \(Tables\) "From" panel on page 860](#)
- [UNLOAD Utility \(Tables\) "To" panel on page 861](#)
- [TEMPLATE Options \(2 of 2\) panel on page 848](#)
- [UNLOAD Options panel on page 854](#)
- [Template Mapping panel on page 850](#)
- [TEMPLATE Options \(2 of 2\) panel on page 848](#)

Null indicator byte processing

The Db2® UNLOAD utility data format uses a single byte for the Db2® null value, located immediately before the data for each nullable column, in the output data set. The value in this byte is set to X'00' if the column contains a value and X'FF' when the column contains the Db2® null value. The Db2® UNLOAD utility automatically places the appropriate value in the null indicator byte in the output data set.

FM/Db2 automatically generates a File Manager Base component template when the template processing option is set to 3 or 4 on the "To" panel. This template includes fields for the null indicator bytes as appropriate.

When a copybook is used to describe the output data, FM/Db2 attempts to generate a reasonable mapping between the template for the Db2® object and the template for the output data set. The data format used by the Db2® UNLOAD utility is fixed, therefore the data format described by the copybook should reflect this format, to avoid data mismatch problems.

The Db2® null indicator byte in a user-specified copybook is successfully mapped when:

- It immediately precedes a nonvarying target field, or precedes the length field of a varying target field.
- The null indicator byte does not overlap any field that has already been mapped.
- The field name for the null indicator byte contains "NULL". In this case, FM/Db2 documents the mapping as comments in the generated JCL for the Db2® UNLOAD utility.

Other types of mapping, or null indicator byte usage are not supported, including:

- A copybook that would map a nullable Db2® column to a data field without a null indicator byte.
- A copybook that would map a not-nullable Db2® column to a data field with a null indicator byte.
- A copybook that uses null indicator fields that are not one byte in length, or are not located immediately before the data for the column to which they pertain.

Related references

- [UNLOAD Options panel on page 854](#)

UNLOAD (tables) with LISTDEF specified

If you specified the name of a LISTDEF on the Db2® Utilities panel, FM/Db2 displays an alternative form of the UNLOAD Utility (Tables) panel showing the specified LISTDEF and a number of editable fields that correspond to keywords in the UNLOAD statement.

Figure 103: Sample JCL generated for UNLOAD (Tables) with LISTDEF specified on page 378 shows an example of generated JCL for unloading a table object where a LISTDEF has been specified.

Figure 103. Sample JCL generated for UNLOAD (Tables) with LISTDEF specified

```

File Edit Edit_Settings Menu Utilities Compilers Test Help
EDIT          FMNUSER.SPFTEMP1.CNTL                      Columns 00001 00072
***** ***** Top of Data *****
000001 //FMNUSERB JOB (IBMGSA),
000002 //          FMNUSER,MSGCLASS=A,
000003 //          NOTIFY=FMNUSER,CLASS=A,
000004 //          MSGLEVEL=(1,1)
000005 //*
000006 //          JCLLIB ORDER=(DB2V810.DFA2.PROCLIB)
000007 //*
000008 //*****
000009 //*
000010 //* FM/Db2 GENERATED JOB TO UNLOAD TABLE LIST
000011 //*
000012 //*****
000013 //*
000014 //*****
000015 //* STEP SETPARAM: OVERRIDE ANY GLOBAL DATASET SIZING VALUES HERE
000016 //*****
000017 //SETPARAM SET ALLOC='TRK',PRI='1',SEC='1'
000018 //*
000019 //*****
000020 //* STEP UNLOAD1: UNLOAD TABLE LIST LDEFNAME1
000021 //*****
000022 //UNLOAD1 EXEC DSNUPROC,SYSTEM=DFA2,UID='FMNUSER'
000023 //DSNUPROC.STEPLIB DD DSN=DB2V810.DFA2.SDSNEXIT,DISP=SHR
000024 //          DD DSN=DB2.V810.SDSNLOAD,DISP=SHR
000025 //DSNUPROC.SYSREC00 DD DISP=(NEW,CATLG,DELETE),
000026 //          UNIT=,SPACE=(&ALLOC,&PRI,&SEC),RLSE),
000027 //          DSN=FMNUSER.LDEFNAME.D2601243.SYSREC
000028 //DSNUPROC.SYSPUNCH DD DISP=(NEW,CATLG,DELETE), UTIL CONTRL DATA
000029 //          UNIT=,SPACE=(TRK,(1,1),RLSE),
000030 //          DSN=FMNUSER.LDEFNAME.D2601243.SYSPUNCH
000031 //DSNUPROC.SYSIN DD *
000032 UNLOAD LIST LDEFNAME1
000033 UNLDDN(SYSREC00)
000034 NOSUBS
000035 /*
***** ***** Bottom of Data *****

Command ==> _____ Scroll ==> PAGE
F1=Help      F2=Split    F3=Exit     F5=Rfind    F6=Rchange  F7=Up
F8=Down      F9=Swap     F10=Left    F11=Right   F12=Cancel

```

Related references

[UNLOAD Utility \(Tables\) with LISTDEF panel on page 863](#)

UNLOAD (table spaces)

This option corresponds to the UNLOAD TABLESPACE form of the UNLOAD utility control statement.

When you use UNLOAD (table spaces), you can use the following combinations of filter fields on the Db2® Utilities panel:

- **Database name, or Table/index space name.**

If you entered information in any of the preceding filter fields on the Db2® Utilities panel, the displayed rows are limited to the Db2® objects that match the information you specified.

Figure 104: UNLOAD Utility (Table Spaces) panel showing list of table spaces. on page 379 shows an example of the UNLOAD Utility (Table Spaces) panel with a list of table spaces.

To select an index space from those displayed, type **s** in the **SEL** column. An asterisk (*) in the **PRC** column indicates selected table spaces.

Figure 104. UNLOAD Utility (Table Spaces) panel showing list of table spaces.

Process		Options		Utilities		Help	
FM/Db2 (DFG2)		UNLOAD Utility (Table Spaces)				Row 1 to 4 of 4	
S	P	Table	Part'n	Number	Number	Allocation	
e	R	Database	Range	Part'n	Tables	Primary	Secdry
l	C	Name	One Two	Part'n	Tables	Space	Space
S		BILLDB1	ACT	<u>2</u>	<u>3</u>	1	1
		BILLDB1	ACT	---	---	2	1
		BILLDB1	ACT	---	---	3	1
		BILLDB1	ACT	---	---	4	1
						3	3
						5	5
						3	3
						5	5
***** Bottom of data *****							
Command ==> _____ Scroll PAGE							
F1=Help F2=Split F3=Exit F7=Backward F8=Forward F9=Swap							
F12=Cancel							

If only a single row results from the filter values you entered, the row is marked as selected, and is shown with an asterisk (*) in the **PRC** field.

If you entered a table space name containing wildcards, the ISPF part of the UNLOAD Utility panel is initialized with one row for each of the table space names that match the input specification. Note that if you did not specify a database name on the Db2® utilities panel, or specified a generic name, the list may contain table spaces from more than one database.

To select a table spaces to copy, type an "S" in the **SEL** field. Selected table spaces have an asterisk (*) in the **PRC** field.

You can modify the UNLOAD utility statement by changing the value in the **Part'n Range** input field.

In Figure 104: UNLOAD Utility (Table Spaces) panel showing list of table spaces. on page 379, the input shows that a range of partitions (from 2 to 3) is to be unloaded.

Figure 105: Sample JCL generated for UNLOAD Utility (Table Spaces) on page 380 shows an example of generated JCL for unloading a table object where a LISTDEF has been specified.

Figure 105. Sample JCL generated for UNLOAD Utility (Table Spaces)

```

File Edit Edit_Settings Menu Utilities Compilers Test Help
EDIT          FMNUSER.SPFTEMP1.CNTL                      Columns 00001 00072
***** ***** Top of Data *****
000001 //FMNUSERB JOB (IBMGSA),
000002 //          FMNUSER,MSGCLASS=A,
000003 //          NOTIFY=FMNUSER,CLASS=A,
000004 //          MSGLEVEL=(1,1)
000005 //*
000006 //          JCLLIB ORDER=(DB2V810.DFA2.PROCLIB)
000007 //*
000008 //*****
000009 //*
000010 //* FM/Db2 GENERATED JOB TO UNLOAD TABLESPACE
000011 //*
000012 //*****
000013 //*
000014 //*****
000015 //* STEP SETPARAM: OVERRIDE ANY GLOBAL DATASET SIZING VALUES HERE
000016 //*****
000017 //SETPARM SET ALLOC='TRK',PRI='1',SEC='1'
000018 //*
000019 //*****
000020 //* STEP UNLOAD1: UNLOAD TABLESPACE DSN8D81A.DSN8S81D
000021 //*****
000022 //UNLOAD1 EXEC DSNUPROC,SYSTEM=DFA2,UID='FMNUSER'
000023 //DSNUPROC.STEPLIB DD DSN=DB2V810.DFA2.SDSNEXIT,DISP=SHR
000024 //          DD DSN=DB2.V810.SDSNLOAD,DISP=SHR
000025 //DSNUPROC.SYSREC00 DD DISP=(NEW,CATLG,DELETE),
000026 //          UNIT=SYSALLDA,SPACE=(&ALLOC,&PRI,&SEC),RLSE),
000027 //          DSN=FMNUSER.DSN8D81A.DSN8S81D.D2581554.SYSREC
000028 //DSNUPROC.SYSPUNCH DD DISP=(NEW,CATLG,DELETE), UTIL CONTRL DATA
000029 //          UNIT=SYSALLDA,SPACE=(TRK,(1,1),RLSE),
000030 //          DSN=FMNUSER.DSN8D81A.DSN8S81D.D2581554.SYSPUNCH
000031 //DSNUPROC.SYSIN DD *
000032 UNLOAD TABLESPACE DSN8D81A.DSN8S81D
000033 UNLDDN(SYSREC00)
000034 NOSUBS
000035 /*
***** ***** Bottom of Data *****

Command ==> _____ Scroll ==> PAGE
F1=Help      F2=Split      F3=Exit      F5=Rfind     F6=Rchange   F7=Up
F8=Down      F9=Swap       F10=Left     F11=Right    F12=Cancel

```

Related references

- [Column Selection/Edit panel on page 485](#)
- [UNLOAD Utility \(Table Spaces\) panel on page 857](#)
- [TEMPLATE Options \(2 of 2\) panel on page 848](#)
- [UNLOAD Options panel on page 854](#)
- [Template Mapping panel on page 850](#)

UNLOAD (table spaces) with LISTDEF specified

If you specified the name of a LISTDEF on the Db2® Utilities panel, FM/Db2 displays an alternative form of the UNLOAD Utility (Table Spaces) panel showing the specified LISTDEF and a number of editable fields that correspond to keywords in the UNLOAD statement.

Figure 106: [Sample JCL generated for UNLOAD \(Table Space\) with LISTDEF specified on page 381](#) shows an example of generated JCL for unloading a table space object where a LISTDEF has been specified.

Figure 106. Sample JCL generated for UNLOAD (Table Space) with LISTDEF specified

```

File Edit Edit_Settings Menu Utilities Compilers Test Help
-----
EDIT          FMNUSER.SPFTEMP1.CNTL          Columns 00001 00072
***** ***** Top of Data *****
000001 //FMNUSERB JOB (IBMGSA),
000002 //          FMNUSER,MSGCLASS=A,
000003 //          NOTIFY=FMNUSER,CLASS=A,
000004 //          MSGLEVEL=(1,1)
000005 //*
000006 //          JCLLIB ORDER=(DB2V810.DFA2.PROCLIB)
000007 //*
000008 //*****
000009 //*
000010 //* FM/Db2 GENERATED JOB TO UNLOAD TABLESPACE LIST
000011 //*
000012 //*****
000013 //*
000014 //*****
000015 //* STEP SETPARAM: OVERRIDE ANY GLOBAL DATASET SIZING VALUES HERE
000016 //*****
000017 //SETPARM SET ALLOC='TRK',PRI='1',SEC='1'
000018 //*
000019 //*****
000020 //* STEP UNLOAD1: UNLOAD TABLESPACE LIST LDEF1
000021 //*****
000022 //UNLOAD1 EXEC DSNUPROC,SYSTEM=DFA2,UID='FMNUSER'
000023 //DSNUPROC.STEPLIB DD DSN=DB2V810.DFA2.SDSNEXIT,DISP=SHR
000024 //          DD DSN=DB2.V810.SDSNLOAD,DISP=SHR
000025 //DSNUPROC.SYSREC00 DD DISP=(NEW,CATLG,DELETE),
000026 //          UNIT=SYSALLDA,SPACE=(&ALLOC,&PRI,&SEC),RLSE),
000027 //          DSN=FMNUSER.LDEF1.D2581557.SYSREC
000028 //DSNUPROC.SYSPUNCH DD DISP=(NEW,CATLG,DELETE), UTIL CONTRL DATA
000029 //          UNIT=SYSALLDA,SPACE=(TRK,(1,1),RLSE),
000030 //          DSN=FMNUSER.LDEF1.D2581557.SYSPUNCH
000031 //DSNUPROC.SYSIN DD *
000032 UNLOAD TABLESPACE LIST LDEF1
000033 UNLDDN(SYSREC00)
000034 NOSUBS
000035 /*
***** ***** Bottom of Data *****

Command ==> _____ Scroll ==> PAGE
F1=Help      F2=Split      F3=Exit      F5=Rfind     F6=Rchange   F7=Up
F8=Down      F9=Swap       F10=Left     F11=Right    F12=Cancel

```

Related references

[UNLOAD Utility \(Table Spaces\) with LISTDEF panel on page 858](#)

Chapter 13. Working with SQL statements

When you want to:

- Issue any dynamic SQL statement from your panel or from a data set, or
- Build and run an SQL SELECT statement interactively

you can use the SQL prototyping, execution and analysis option (4).



Note:

1. This chapter does not attempt to describe the syntax of SQL statements. For full details, see the *DB2 for z/OS SQL Reference*.

To display the SQL Prototyping, Execution and Analysis panel, from the Primary Option Menu panel select option 4 (SQL).

Related tasks

[Should you use basic or advanced SQL prototyping? on page 382](#)

[Using basic SQL prototyping on page 382](#)

[Using advanced SQL prototyping on page 391](#)

Related references

[Primary Option Menu panel on page 728](#)

[SQL Prototyping, Execution and Analysis panel on page 806](#)

Should you use basic or advanced SQL prototyping?

If you only need to build a simple SQL SELECT statement, basic SELECT prototyping 4.1) is probably sufficient for your needs. If you need to build a more complex statement, use advanced SELECT prototyping (4.2).

Related references

[Using basic SQL prototyping on page 382](#)

[Using advanced SQL prototyping on page 391](#)

Using basic SQL prototyping

Basic SELECT prototyping uses two panels: you use the primary panel to specify the table (or tables) that contain the data you want to retrieve (FROM clause), and the secondary panel to specify the columns you want to show, any qualifying information (WHERE clause), and the sequence in which you want the data to be shown (ORDER BY clause).

To display the primary Basic SELECT Prototyping panel, select option 1 (Basic) on the SQL Prototyping, Execution and Analysis panel.

Figure 107. Primary Basic SELECT Prototyping panel

Process	Options	Utilities	Help
FM/Db2 (DFG2)		Basic SELECT Prototyping	
Enter the name(s) of the table(s) from which to retrieve data:			
	Owner	Name	
1	DSN81010	+ EMP	+ Location _____
2	DSN81010	+ DEPT	+ Database _____
3	_____	+ _____	+ Tbl spc. _____
4	_____	+ _____	+ _____
5	_____	+ _____	+ _____
6	_____	+ _____	+ _____
7	_____	+ _____	+ _____
8	_____	+ _____	+ _____
9	_____	+ _____	+ _____
10	_____	+ _____	+ _____
11	_____	+ _____	+ _____
12	_____	+ _____	+ _____
13	_____	+ _____	+ _____
14	_____	+ _____	+ _____
15	_____	+ _____	+ _____
Command ==>			
F1=Help		F2=Split	F3=Exit
		F9=Swap	F12=Cancel

On this panel you can specify up to 15 tables, views, synonyms, or aliases that can be part of the SELECT statement being prototyped. If you specify more than one object, the columns for all objects specified are shown on the secondary Basic SELECT Prototyping panel when you press Enter; see [Figure 108: Secondary Basic SELECT Prototyping panel on page 384](#).

You cannot modify the entry-line numbers at the left of the panel (1, 2, and so on). The purpose of the entry-line number is to provide a suffix for the correlation name used to identify the Db2® object. Db2® correlation names are discussed in detail in the *SQL Reference*. The complete Db2® correlation name is shown in the "Tab" column on the secondary Basic SELECT Prototyping panel when you press Enter. The complete correlation name will be a capital letter, followed by the entry-line number. The capital letter will usually be 'T', but may be another letter if any of the Db2® object names start with 'T'. The Basic Prototyper ensures that the letter selected for the correlation name reference is not the same as the first letter of any Db2® object name included on the primary Basic SELECT Prototyping panel.

The columns and rows included in the result table are determined by the SELECT and WHERE clauses specified on the secondary Basic SELECT Prototyping panel, which is displayed when you specify the objects and press Enter. The examples in this section use the tables DSN81010.EMP and DSN81010.DEPT.

Tables and views are specified by optionally entering values in the **Location**, **Database**, **Tbl spc.** (table space), and **Owner** fields, and entering values in the **Name fields**. Synonyms are specified by entering values in the **Name fields**. If a value is entered in the **Owner** field for a synonym, it must be the current SQLID. All of the fields support catalog searches by specifying a pattern in the field. After you have specified the table names on the primary Basic SELECT Prototyping panel, press Enter to display the secondary Basic SELECT Prototyping panel.

Figure 108. Secondary Basic SELECT Prototyping panel

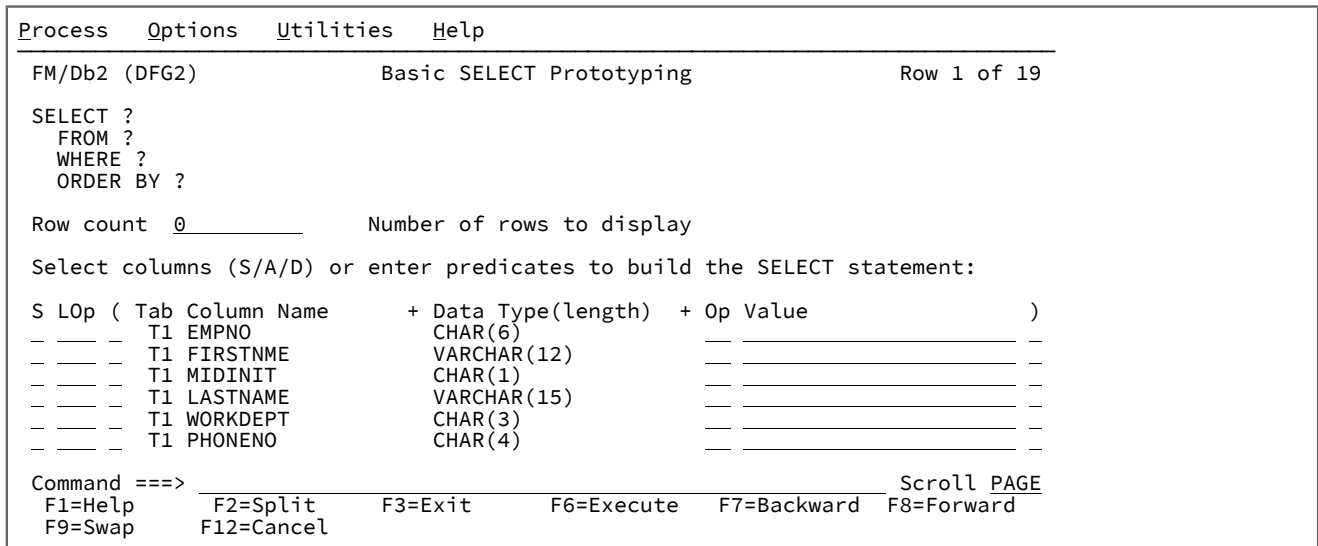

When initially displayed, the secondary Basic SELECT Prototyping panel shows all of the columns for the Db2® objects entered on the primary panel. You can scroll up or down if there are more columns than will fit on the display. The SQL statement being prototyped is shown at the top of the panel as 4 clauses (SELECT, FROM, WHERE and ORDER BY). An empty clause is indicated by a “?”.

FM/Db2 automatically updates one or more of these clauses as you enter either primary or line commands. Each of the clause fields is an ISPF expandable field. If the field is too short to display all of the clause then a “+” will be shown at the end of the field. You can position the cursor anywhere in the field and press the ISPF EXPAND key to show the complete clause in a pop-up window.

To limit the number of rows returned in the result set when the SQL statement is executed, specify the maximum number of rows in the **Row count** field.

The following primary commands are available when you use basic SELECT prototyping:

ALL

Use this command to select all columns for a Db2® object. You can specify an optional parameter #n to include only the columns of the nth Db2® object displayed.

CANCEL

Use this command to return to the primary Basic SELECT Prototyping panel

EXECUTE

Use this command to run the SQL statement being prototyped

RESET

Use this command to abandon all changes to the SQL statement. All clauses are returned to empty status.

SQL

Use this command to show the complete SQL statement in an ISPF editor session

UNDO

Use this command to back-out the last change made.

The following line commands can be entered against any column:

- S or /

You type either S or / against the entry for a column to add that column to the list of columns for the SQL statement. Data from the column will be included in the result table when the statement is executed.

You can select multiple columns at once, however your entries are processed from top to bottom, so you might need to select columns individually if the order of columns in the result table is important.

- A and D

You type either A or D against the entry for a column to add an ORDER BY clause for that column. If the specified column does not exist in the column list, the column is also added to the column list. Data from the column will be included in the result table when the statement is executed, and rows will be sorted in ascending or descending order on that data.

Entering a A results in the ORDER BY clause including the column name without modification, this defaults to ascending (ASC keyword).

Entering a D results in the ORDER BY clause including the column name followed by the DESC keyword, this indicates the result table should be sorted in descending order based on the data for the column.

- U

You type U against the entry for a column to remove the last column reference from the list of columns in the result table. When the column is removed and the column is no longer specified in the list of columns:

- All ORDER BY clause references to the column are also removed.
- All predicate references to the column are also removed.

If the column has been added to the column list multiple times, use the U command repeatedly to remove all references.

- UO

You type UO against the entry for a column to remove the last ORDER BY reference.

Removing an ORDER BY reference for the column does not remove the column from the column list, nor does it remove any predicates referencing the column from the WHERE clause.

If the column has been added to the ORDER BY clause multiple times, use the UO command repeatedly to remove all references.

- UW

You type UW against the entry for a column to remove the last predicate that references the column.

Removing a WHERE clause reference for the column does not remove the column from the column list, nor does it remove any references for the column from the ORDER BY clause.

If there are multiple predicates containing the column, use the UW command repeatedly to remove all references.

Specifying a predicate

You specify a predicate (for example EMPNO = '000010') by typing the comparison operator ("=") in the Op field, and the comparison value ("000010") in the Value field. To specify a join predicate, include the correlation reference for the table containing the join column in the value field.

For example, to specify a join between DSN81010.EMP.WORKDEPT and DSN81010.DEPT.DEPTNO:

- Type "=" in the **Op** field for column WORKDEPT.
- Type "T2.DEPTNO" in the **Value** column for WORKDEPT.

Figure 109: Specifying a join predicate on page 386 shows an example of specifying the join, and Figure 110: The result of the join predicate shown in the previous figure on page 387 shows the result of the join predicate.

Figure 109. Specifying a join predicate

```

Process  Options  Utilities  Help
-----  -
FM/Db2 (DFG2)          Basic SELECT Prototyping          Row 1 of 19

SELECT T1.*
  FROM "DSN81010"."EMP" T1
  WHERE ?
  ORDER BY ?

Row count  100          Number of rows to display

Select columns (S/A/D) or enter predicates to build the SELECT statement:

S LOp ( Tab Column Name      + Data Type(length)  + Op Value          )
- - - - T1 EMPNO              CHAR(6)             = 
- - - - T1 FIRSTNME           VARCHAR(12)         = 
- - - - T1 MIDINIT            CHAR(1)             = 
- - - - T1 LASTNAME           VARCHAR(15)         = 
- - - - T1 WORKDEPT           CHAR(3)             = T2.DEPTNO
- - - - T1 PHONENO            CHAR(4)             = 

Command ==>>>          Scroll PAGE
F1=Help      F2=Split  F3=Exit    F6=Execute  F7=Backward  F8=Forward
F9=Swap      F12=Cancel
    
```

Figure 110. The result of the join predicate shown in the previous figure

```

Process  Options  Utilities  Help
-----  -
FM/Db2 (DFG2)          Basic SELECT Prototyping          Row 1 of 19

SELECT T1.*
  FROM "DSN81010"."EMP" T1 "DSN81010"."DEPT" T2
  WHERE "WORKEDPT" = T2.DEPTNO
  ORDER BY ?

Row count  100          Number of rows to display

Select columns (S/A/D) or enter predicates to build the SELECT statement:

S LOp ( Tab Column Name      + Data Type(length)  + Op Value          )
- - - - -
- - - - - T1 EMPNO              CHAR(6)
- - - - - T1 FIRSTNME           VARCHAR(12)
- - - - - T1 MIDINIT           CHAR(1)
- - - - - T1 LASTNAME          VARCHAR(15)
- - - - - T1 WORKDEPT          CHAR(3)
- - - - - T1 PHONENO           CHAR(4)
- - - - -

Command ==>>          Scroll PAGE
F1=Help      F2=Split    F3=Exit     F6=Execute  F7=Backward F8=Forward
F9=Swap      F12=Cancel

```

Example of using basic SELECT prototyping

We'll use an example to show how to use basic SELECT prototyping to build a SELECT statement and then run it to see the results.

Suppose you want to list details of all employees in the table DSN8810.EMP whose:

- Department is not "E01", and
- JOB is "Manager" or SALARY is at least \$40,000

For each employee, you want to show the following columns from the table DSN8810.EMP (correlation name #1):

```

LASTNAME
FIRSTNME
WORKDEPT
JOB
SALARY (in ascending sequence)

```

and the following column from the table DSN8810.EEMP (correlation name #2):

```

BONUS

```

You can specify details on the secondary Basic SELECT Prototyping panel for more than one column at a time. However, for the purpose of clarity, the following steps show the details being entered one at a time for each column, and the resultant SELECT statement that FM/Db2 progressively builds (and displays at the top of the panel) after you press Enter.

Step 1

Select the column, LASTNAME, by typing **s** in the **S** entry field:

S	L	Op	(Tab Column Name	Data Type(length)	Op Value)
:	:	:	:	:	:	:
s	---		#1 LASTNAME	VARCHAR(15)	-----	-
:	:	:	:	:	:	:

FM/Db2 updates the generated SELECT statement by:

- Adding the name of the selected column (LASTNAME) to the SELECT clause.

```
SELECT #1.LASTNAME
FROM DSN8810.EMP #1, DSN8810.EEMP #2
WHERE ?
ORDER BY ?
```

Step 2

Select the column, FIRSTNME, by typing **s** in the **S** entry field:

S	L	Op	(Tab Column Name	Data Type(length)	Op Value)
:	:	:	:	:	:	:
s	---		#1 FIRSTNME	VARCHAR(12)	-----	-
:	:	:	:	:	:	:

FM/Db2 updates the generated SELECT statement by:

- Adding the name of the selected column (FIRSTNME) to the SELECT clause.

```
SELECT #1.LASTNAME, #1.FIRSTNME
FROM DSN8810.EMP #1, DSN8810.EEMP #2
WHERE ? STNAME <> 'SMITH'
ORDER BY ?
```

Step 3

To exclude employees in WORKDEPT "E01":

- Select the column, WORKDEPT, by typing **s** in the **S** entry field,
- Type the expression operator **<>** in the **Op** entry field, and
- Type **E01** in the **Value** entry field:

S	L	Op	(Tab Column Name	Data Type(length)	Op Value)
:	:	:	:	:	:	:
s	---		#1 WORKDEPT	CHAR(3)	<> e01-----	-
:	:	:	:	:	:	:

FM/Db2 updates the generated SELECT statement by:

- Adding the name of the selected column (WORKDEPT) to the SELECT clause.
- Adding a predicate, **#1.WORKDEPT <> 'E01'**, to the WHERE clause.

```
SELECT #1.LASTNAME, #1.FIRSTNME, #1.WORKDEPT
FROM DSN8810.EMP #1, DSN8810.EEMP #2
WHERE #1.WORKDEPT <> 'E01'
ORDER BY ?
```

Step 4

To select employees with a JOB of "Manager":

- Select the column, JOB, by typing **s** in the **S** entry field,
- Type an opening parenthesis, **(**, in the **(** entry field, and
- Type **MANAGER** in the **Value** entry field:

S	Lop	(Tab Column Name	Data Type(length)	Op	Value)
⋮						
s		(#1 JOB	CHAR(8)		manager	_____)
⋮						

FM/Db2 updates the generated SELECT statement by:

- Adding the name of the selected column (JOB) to the SELECT clause.
- Inserting the default logical operator **AND** before adding a predicate, **(#1.JOB = 'MANAGER'**, to the WHERE clause.

```
SELECT #1.LASTNAME, #1.FIRSTNME, #1.WORKDEPT, #1.JOB
FROM DSN8810.EMP #1, DSN8810.EEMP #2
WHERE #1.WORKDEPT <> 'E01' AND (#1.JOB = 'MANAGER'
ORDER BY ?
```

Step 5

To also select employees with a SALARY of at least \$40,000 (regardless of their JOB), and to specify that the results are to be shown in ascending sequence of SALARY:

- Select the column, SALARY, for ascending sequence by typing **a** in the **S** entry field,
- Type the logical operator, **OR**, in the **Lop** entry field,
- Type the expression operator **>=** in the **Op** entry field, and
- Type **40000** in the **Value** entry field.
- Type a closing parenthesis in the **)** entry field:

S	Lop	(Tab Column Name	Data Type(length)	Op	Value)
⋮						
a	or	_ #1 SALARY	DECIMAL(9,2)	>=	40000	_____)
⋮						

FM/Db2 updates the generated SELECT statement by:

- Adding the name of the selected column (SALARY) to the SELECT clause.
- Adding a predicate, **OR #1.SALARY >= 40000**), to the WHERE clause.
- Adding the name of the selected column (SALARY), and the keyword **ASC**, to the ORDER BY clause.

```
SELECT #1.LASTNAME, #1.FIRSTNME, #1.WORKDEPT, #1.JOB, #1.SALARY
FROM DSN8810.EMP #1, DSN8810.EEMP #2
WHERE #1.WORKDEPT <> 'E01' AND (#1.JOB = 'MANAGER' OR #1.SALARY >= 40000)
ORDER BY #1.SALARY ASC
```

Step 6

Select the column, BONUS (from the table DSN8810.EEMP), by typing **s** in the **S** entry field:

S	LOp (Tab Column Name	Data Type(length)	Op Value)
:				
s	___ _ #2 BONUS	DECIMAL(9,2)		-----
:				

FM/Db2 updates the generated SELECT statement by:

- Adding the name of the selected column (BONUS) to the SELECT clause.

```
SELECT #1.LASTNAME, #1.FIRSTNME, #1.WORKDEPT, #1.JOB, #1.SALARY, #2.BONUS
FROM DSN8810.EMP #1, DSN8810.EEMP #2
WHERE #1.WORKDEPT <> 'E01' AND (#1.JOB = 'MANAGER' OR #1.SALARY >= 40000)
ORDER BY #1.SALARY ASC
```

Figure 111: Details entered together on the secondary Basic SELECT Prototyping panel on page 390 shows how the Basic SELECT Prototyping panel is displayed if you had entered the details for all of the columns at the same time.



Note: The effect of entering details for one column at a time (as in the previous steps) can be different to when you enter details for more than one column at a time.

For example, if you enter the details as shown in [Figure 111: Details entered together on the secondary Basic SELECT Prototyping panel on page 390](#), FIRSTNME is shown before LASTNAME in the generated SELECT statement.

Figure 111. Details entered together on the secondary Basic SELECT Prototyping panel

Process	Options	Utilities	Help
FM/Db2 (DFG2)		Basic SELECT Prototyping	Row 1 to 8 of 14
SELECT ?			
FROM DSN8810.EMP #1, DSN8810.EEMP #2			
WHERE ?			
ORDER BY ?			
Row count	ALL	Number of rows to display	
Select columns (S/A/D) or enter predicates to build the SELECT statement:			
S	LOp (Tab Column Name	+ Data Type(length)	+ Op Value)
:			
s	___ _ #1 FIRSTNME	VARCHAR(12)	-----
:			
s	(#1 JOB	CHAR(8)	manager-----
s	___ _ #1 LASTNAME	VARCHAR(15)	-----
:			
a	or_ _ #1 SALARY	DECIMAL(9,2)	>= 40000-----)
:			
s	___ _ #1 WORKDEPT	CHAR(3)	<> e01-----
:			
s	___ _ #2 BONUS	DECIMAL(9,2)	-----
:			
Command ==> _____ Scroll PAGE			
F1=Help	F2=Split	F3=Exit	F4=Expand F6=Execute F7=Backward
F8=Forward	F9=Swap	F10=Left	F11=Right F12=Cancel

Related tasks

[Executing a SELECT statement after you have built it using prototyping on page 416](#)

Related references

[Basic SELECT Prototyping panel on page 465](#)

[SQL primary command on page 942](#)

Using advanced SQL prototyping

In this section, the following terms are used:

clause

A distinct part of the SELECT statement, such as a WHERE clause.

element

A single item within the syntax (such as a keyword, variable, reference to a fragment, or special character).

fragment

A portion of the SELECT statement syntax. Fragments can contain references to other fragments.

instance

A repeatable item that has been assigned a value. For example, the following GROUP BY clause contains three instances:

```
GROUP BY COL1 , COL2 , COL3
```

keyword

An item that must be spelled exactly as shown. Keywords (for example, `FROM`) are shown in uppercase in the syntax diagram displayed on the Advanced SELECT Prototyping panel.

repeatable item

An item that can be repeated within the syntax. Repeatable items are indicated by a repeat arrow that can contain a repeat separator. For example:

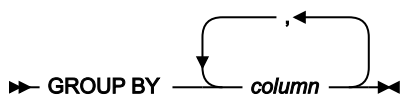

variable

An element that requires you to enter a value.

Advanced SELECT prototyping lets you develop a complex SELECT statement using a recursive set of specification panels.

Each panel displays a fragment of the SELECT statement syntax, presented in the form of a syntax diagram (in a similar way to a reference manual). You build the SELECT statement by selecting the optional fragments of the syntax you want to use, discarding those that you do not need, and entering items where required. The panels guide you through the syntax and ensure that you include all the required fragments of the syntax. Each panel shows the partly-formed SELECT statement as you progressively build it.

As you build the SELECT statement, you can return to any part of the statement to:

- Change values.
- Add a fragment of syntax.
- Remove a fragment of syntax.



Note:

1. If you have a 24-line screen, to see the SQL statement as it is being built you must remove the function key lines from your display by entering `PFSHOW OFF`.
2. If the generated SQL statement extends over several lines, you can scroll forward or backward with the Forward function key (F8) and Backward function key (F7) respectively.

To display the Advanced SELECT Prototyping panel, select option 2 (Advanced) on the SQL Prototyping, Execution and Analysis panel.

The following primary commands are available when you use advanced SELECT prototyping:

- CANCEL
- DESELECT
- EXECUTE
- INSRPT
- NEXTRPT
- PREVRPT
- SQL

Related tasks

- [Example 2 \(Changing the SQL statement\) on page 399](#)
- [Example 3 \(Adding to the SQL statement\) on page 400](#)
- [Example 4 \(Removing part of the SQL statement\) on page 406](#)
- [Executing a SELECT statement after you have built it using prototyping on page 416](#)

Related references

- [SQL Prototyping, Execution and Analysis panel on page 806](#)
- [Advanced SELECT Prototyping panel on page 442](#)
- [CANCEL primary command on page 873](#)
- [DESELECT primary command on page 884](#)
- [EXECUTE primary command on page 893](#)
- [INSRPT primary command on page 912](#)
- [NEXTRPT primary command on page 924](#)
- [PREVRPT primary command on page 928](#)
- [SQL primary command on page 942](#)

Tabbing and color-coding

Advanced SELECT prototyping uses colors to help you:

- Navigate the SELECT statement syntax.
- Identify current and non-current parts of the generated SELECT statement, particularly for fragments that contain repeatable items.

Syntax diagram color-coding

To help you navigate the syntax, advanced SELECT prototyping uses a tabbing and color-coding scheme.

You can tab to those parts of the syntax where you are able to either make a choice or enter a variable. You cannot tab to a required keyword.

Advanced SELECT prototyping uses the following system of colors for the syntax diagram:

RED

References to required fragments that have not been completed, or references to optional fragments that have been selected but not completed.

WHITE

Required keywords. You cannot select these, or tab to them.

GREEN

In general terms, indicates a reference to a completed fragment of the syntax:

- Selected optional keywords (otherwise yellow)
- Required fragments whose subselections have been made to enable them to be resolved (otherwise red)
- Optional fragments whose subselections have been made to enable them to be resolved (otherwise yellow)

YELLOW

Optional keywords and fragments that are not currently selected (green when selected and complete; red when selected and incomplete).

Generated SELECT statement color-coding

To help you recognize which part of the generated SELECT statement is current (the part that is accessible to you) and, in the case of repeatable items, which is the current repeatable item, advanced SELECT prototyping uses the following system of colors for the generated SELECT statement:

GREEN

The current part of the SELECT statement and which, therefore, is accessible to you. This includes any data that is part of a current repetition.

YELLOW

Part of a repetition that is not current. To make a non-current (YELLOW) current (GREEN), use the PrvRpt function key (F10) or NxtRpt function key (F11) function keys.

WHITE

Parts of the SELECT statement that are above the level of the current fragment.

Related references

[Advanced SELECT Prototyping panel on page 442](#)

Using the advanced SELECT prototyping panels to build a SELECT statement

If you use advanced SELECT prototyping, you place the cursor on the part of the syntax you want and press Enter. To specify a value for a variable, you type the name in a panel. As you proceed to build the SELECT statement, FM/Db2 shows the partly-built statement within the panel you are viewing. You repeat this process until you have built the complete SELECT statement.

Example 1 (Building a simple SQL statement)

The following series of panels show each stage of using advanced SELECT prototyping to build an SQL statement to show all rows of the table PARTS.

1. Select option 2 (Advanced) from the SQL Prototyping and Execution panel to display the initial Advanced SELECT Prototyping panel.
2. Move the cursor to the **fullselect** fragment.
3. Press Enter. The syntax for the full SELECT clause is displayed.

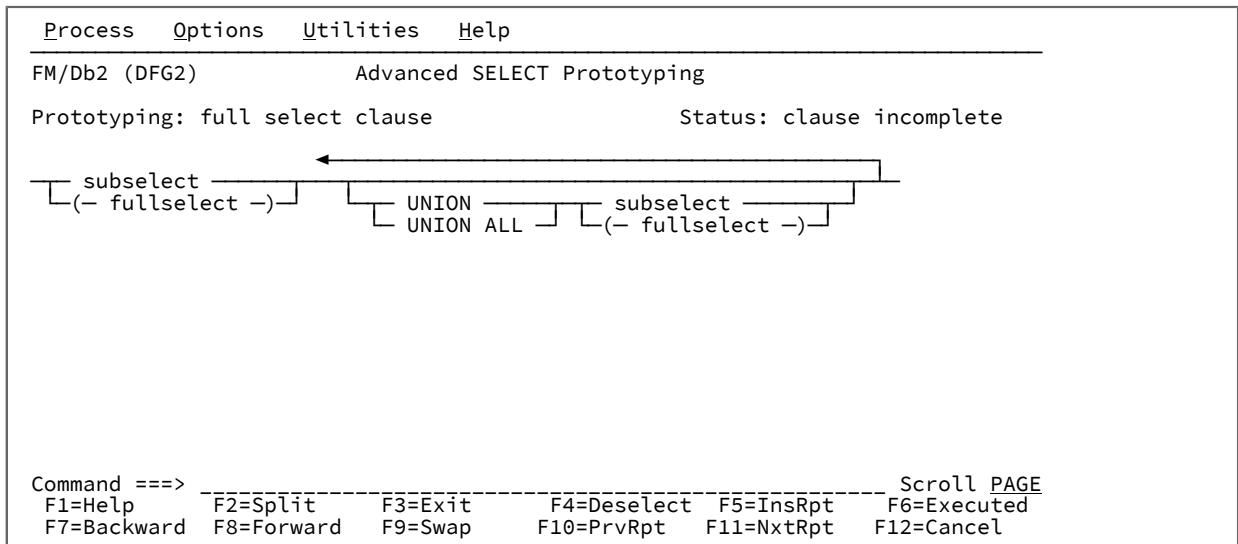

4. Move the cursor to the **subselect** fragment.
5. Press Enter. The syntax for the subselect clause is displayed.

```

  Process  Options  Utilities  Help
  -----
FM/Db2 (DFG2)          Advanced SELECT Prototyping
Prototyping: subselect clause          Status: clause incomplete
- select - from  ┌───┴───┐ ┌───┴───┐ ┌───┴───┐
                  where  groupby  having

Command ===> ----- Scroll PAGE
F1=Help      F2=Split    F3=Exit     F4=Deselect  F5=InsRpt   F6=Executed
F7=Backward  F8=Forward   F9=Swap     F10=PrvRpt  F11=NxtRpt  F12=Cancel

```

Notice that the **select** and **from** fragments are displayed on your screen in *red* indicating that the subsections relating to these fragments must be completed before these fragments can be resolved.

6. Move the cursor to the **select** fragment.
7. Press Enter. The syntax for the SELECT clause is displayed.

```

  Process  Options  Utilities  Help
  -----
FM/Db2 (DFG2)          Advanced SELECT Prototyping
Prototyping: select clause          Status: clause incomplete
- SELECT ┌───┴───┐ ┌───┴───┐ ┌───┴───┐
          ALL  DISTINCT  *
          └───┬───┘ └───┬───┘ └───┬───┘
                , expression  AS  column
                ┌───┴───┐ ┌───┴───┐
                table  view  correlation  .*

SELECT ALL

Command ===> ----- Scroll PAGE
F1=Help      F2=Split    F3=Exit     F4=Deselect  F5=InsRpt   F6=Executed
F7=Backward  F8=Forward   F9=Swap     F10=PrvRpt  F11=NxtRpt  F12=Cancel

```

The panel now shows the partly-built SELECT statement:

```
SELECT ALL
```

This is because:

- The keyword **SELECT** is a required keyword for this fragment. As you have selected this fragment, FM/Db2 has entered it into the SELECT statement.
- **ALL** is a default keyword (and, in this case, what you want).

8. Move the cursor to the asterisk (*).
9. Press Enter.

```

Process  Options  Utilities  Help
-----
FM/Db2 (DFG2)          Advanced SELECT Prototyping
Prototyping: select clause          Status: clause complete

- SELECT [ ALL ] [ DISTINCT ] *
      |
      |----- expression -----
      |
      |----- table -----
      |
      |----- view -----
      |
      |----- correlation -----
      |
      |----- AS -----
      |
      |----- column -----
      |
      |----- .* -----

SELECT ALL *

Command ==> ----- Scroll PAGE
F1=Help      F2=Split    F3=Exit      F4=Deselect  F5=InsRpt   F6=Executed
F7=Backward  F8=Forward   F9=Swap     F10=PrvRpt  F11=NxtRpt  F12=Cancel
    
```

The panel now shows the partly-built SELECT statement:

```
SELECT ALL *
```

10. Press the Exit function key (F3). The syntax for the subselect clause is displayed.

```

Process  Options  Utilities  Help
-----
FM/Db2 (DFG2)          Advanced SELECT Prototyping
Prototyping: subselect clause          Status: clause incomplete

- select - from [ where ] [ groupby ] [ having ]

SELECT ALL *

Command ==> ----- Scroll PAGE
F1=Help      F2=Split    F3=Exit      F4=Deselect  F5=InsRpt   F6=Executed
F7=Backward  F8=Forward   F9=Swap     F10=PrvRpt  F11=NxtRpt  F12=Cancel
    
```

Notice that the **select** fragment has now changed on your screen from red to *green* indicating that the subsection relating to this fragment has been completed and this fragment can be resolved.

You now need to complete the subsection relating to the **from** fragment.

11. Move the cursor to the **from** fragment.
12. Press Enter. The syntax for the FROM clause is displayed.

```

Process  Options  Utilities  Help
-----
FM/Db2 (DFG2)          Advanced SELECT Prototyping
Prototyping: from clause          Status: clause incomplete

- FROM ← 'tabref'

SELECT ALL * FROM

Command ==> ----- Scroll PAGE
F1=Help      F2=Split    F3=Exit     F4=Deselect  F5=InsRpt   F6=Executed
F7=Backward  F8=Forward  F9=Swap     F10=PrvRpt  F11=NxtRpt  F12=Cancel

```

The panel now shows the partly-built SELECT statement:

```
SELECT ALL * FROM
```

This is because the keyword FROM is a required keyword.

Again, notice that the **tabref** fragment is displayed on your screen in *red*, indicating that the subsection relating to this fragment is yet to be completed before this fragment can be resolved

13. Move the cursor to the **tabref** fragment.
14. Press Enter. The syntax for the table specification clause is displayed.

```

Process  Options  Utilities  Help
-----
FM/Db2 (DFG2)          Advanced SELECT Prototyping
Prototyping: table reference clause          Status: clause incomplete

┌─── table ───┐
├─── view ───┐ ┌─── correl ───┐
├─── tablocref ───┐
├─── TABLE ───┐ (- fullselect -) ─── correl ───┐
├─── tabfunref ───┐
├─── itableref ───┐
├─── joinedtable ───┐
└────────────────┘

SELECT ALL * FROM

Command ==> ----- Scroll PAGE
F1=Help      F2=Split    F3=Exit     F4=Deselect  F5=InsRpt   F6=Execute
F7=Backward  F8=Forward  F9=Swap     F10=PrvRpt  F11=NxtRpt  F12=Cancel

```

15. Move the cursor to the **table** fragment.
16. Press Enter. A panel is displayed in which you can enter a table name.
17. Type `PARTS` in the panel.

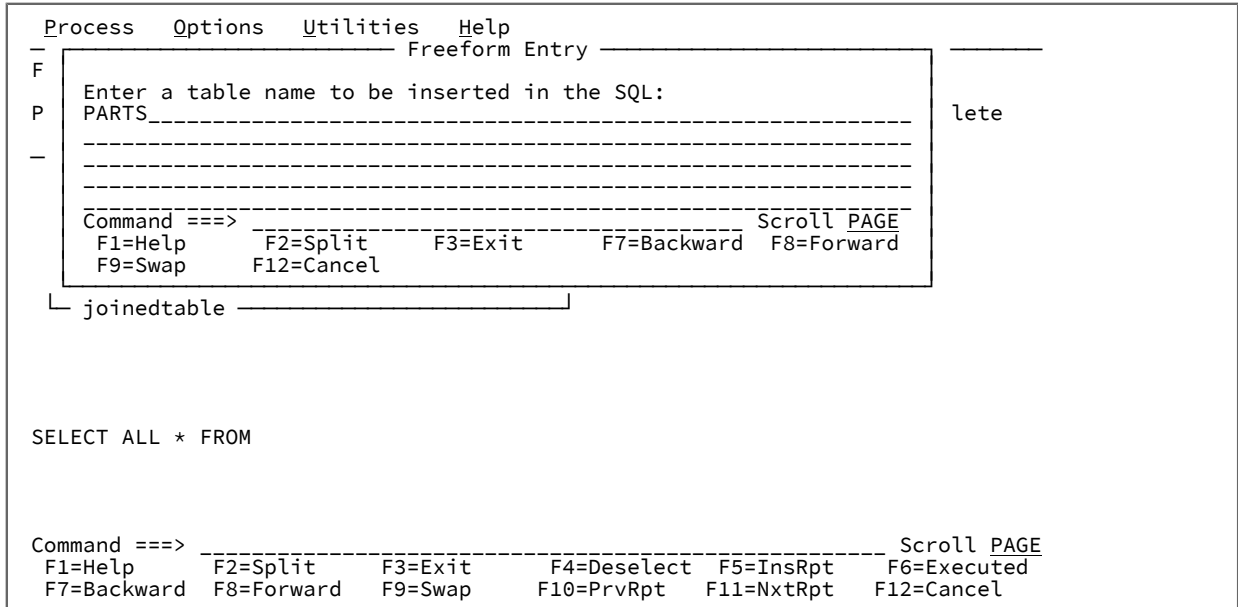

18. Press the Exit function key (F3). The syntax for the table specification clause is displayed.

Figure 112. Advanced SELECT prototyping: the completed statement (example 1)

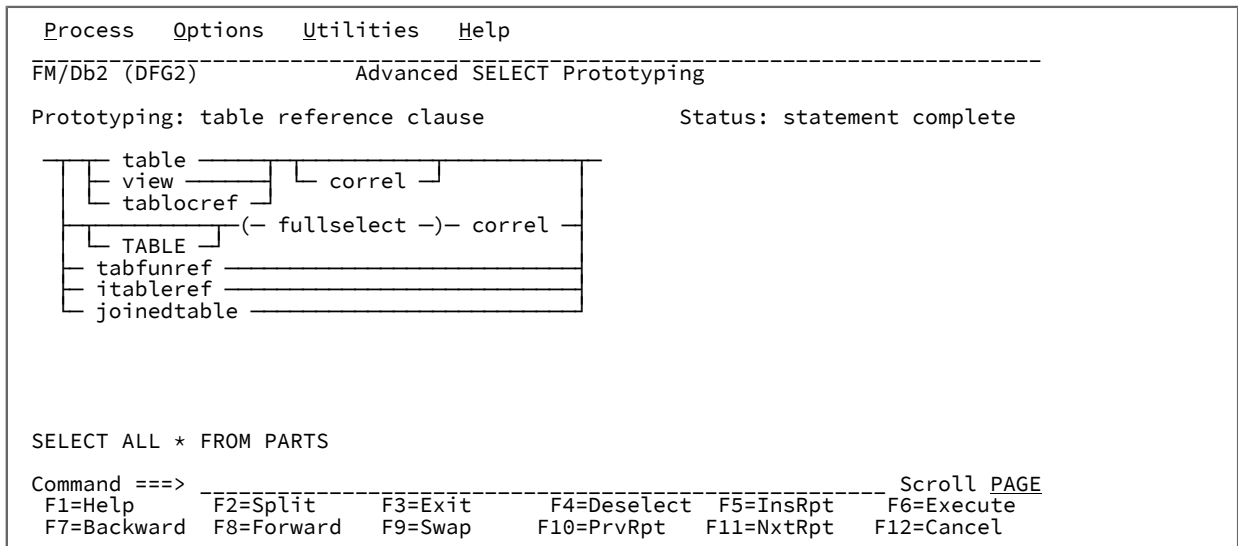

The panel shows the completed SELECT statement:

```
SELECT ALL * FROM PARTS
```

Notice that the **table** fragment has now changed on your screen from red to *green*, indicating that the subsection relating to this fragment has been completed and the fragment can be resolved. Also notice that the status indicator (**Status:**) shows "statement complete".

Related tasks

[Executing a SELECT statement after you have built it using prototyping on page 416](#)

Related references

[SQL Prototyping, Execution and Analysis panel on page 806](#)

[Advanced SELECT Prototyping panel on page 442](#)

Changing the SQL statement

At any stage of building an SQL statement, you can:

- Change part of the statement by positioning the cursor on the relevant part of the SELECT statement and pressing Enter. FM/Db2 returns you to that part of the syntax. You can then make the required change.
- Add an extra fragment to the statement by positioning the cursor on the relevant part of the SELECT statement and pressing Enter. FM/Db2 returns you to that part of the syntax. You can then add the required fragment.
- Remove a part of the statement by pressing the Deselect function key (F4).

Example 2 (Changing the SQL statement)

Having built the SQL statement in the previous exercise to show *all* rows of the table PARTS (see [Figure 112: Advanced SELECT prototyping: the completed statement \(example 1\) on page 398](#)), suppose you want to change this to eliminate all but one of each set of duplicate rows:

1. Move the cursor under the word ALL in the generated statement.
2. Press Enter. The syntax for the SELECT clause is displayed.

```

Process  Options  Utilities  Help
-----
FM/Db2 (DFG2)  Advanced SELECT Prototyping
Prototyping: select clause  Status: statement complete

- SELECT - [ ALL ] *
           [ DISTINCT ] ← , expression [ AS ] column
                             [ table ]
                             [ view ]
                             [ correlation ]
                             [ .* ]

SELECT ALL * FROM PARTS

Command ==> ----- Scroll PAGE
F1=Help      F2=Split    F3=Exit     F4=Deselect F5=InsRpt  F6=Executed
F7=Backward F8=Forward  F9=Swap     F10=PrvRpt F11=NxtRpt F12=Cancel

```

3. Move the cursor to the keyword **DISTINCT**.

4. Press Enter. DISTINCT replaces ALL in the built SELECT statement.

Figure 113. Advanced: the completed statement (example 2)

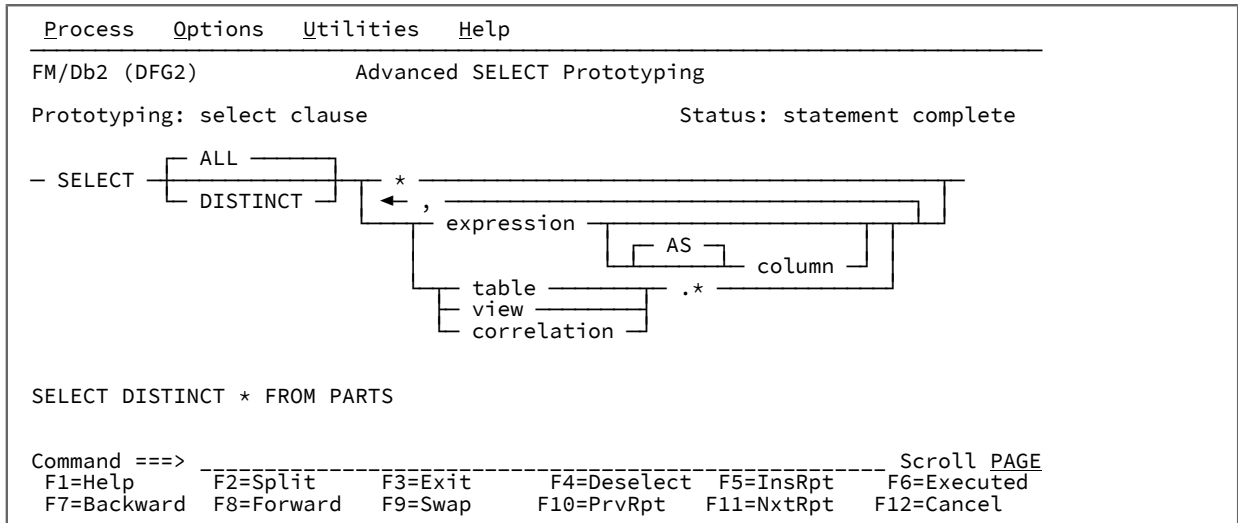

The panel shows the completed SELECT statement:

```
SELECT DISTINCT * FROM PARTS
```

Related tasks

[Example 1 \(Building a simple SQL statement\) on page 394](#)

[Executing a SELECT statement after you have built it using prototyping on page 416](#)

Example 3 (Adding to the SQL statement)

Suppose now that you want to add a condition to the SQL statement in the previous exercise (see [Figure 113: Advanced: the completed statement \(example 2\) on page 400](#)) to show only rows of the table PARTS with a part number greater than 12456:

1. Press the Exit function key (F3) to return to the syntax for the subselect clause.

```

  Process  Options  Utilities  Help
  -----
FM/Db2 (DFG2)          Advanced SELECT Prototyping
Prototyping: subselect clause          Status: statement complete
- select - from  [ where ] [ groupby ] [ having ]

SELECT DISTINCT * FROM PARTS

Command ==> ----- Scroll PAGE
F1=Help      F2=Split    F3=Exit     F4=Deselect F5=InsRpt   F6=Executed
F7=Backward  F8=Forward  F9=Swap     F10=PrvRpt F11=NxtRpt  F12=Cancel

```

2. Move the cursor to the **where** fragment.
3. Press Enter. The syntax for the WHERE clause is displayed.

```

  Process  Options  Utilities  Help
  -----
FM/Db2 (DFG2)          Advanced SELECT Prototyping
Prototyping: where clause          Status: clause incomplete
- WHERE - srchcon -

SELECT DISTINCT * FROM PARTS WHERE

Command ==> ----- Scroll PAGE
F1=Help      F2=Split    F3=Exit     F4=Deselect F5=InsRpt   F6=Executed
F7=Backward  F8=Forward  F9=Swap     F10=PrvRpt F11=NxtRpt  F12=Cancel

```

Notice that FM/Db2 has added the required keyword WHERE to the SQL statement.

4. Move the cursor to the **srchcon** fragment.
5. Press Enter. The syntax for the search condition clause is displayed.

```

Process  Options  Utilities  Help
-----
FM/Db2 (DFG2)              Advanced SELECT Prototyping
Prototyping: search condition clause           Status: clause incomplete

┌── NOT ─┘ ┌── predicate ─┘
┌──────────┘ ┌── (- srchcon -) ─┘
┌──────────┘ ┌── AND ─┘ ┌── NOT ─┘ ┌── predicate ─┘
┌──────────┘ ┌── OR ─┘ ┌── (- srchcon -) ─┘

SELECT DISTINCT * FROM PARTS WHERE

Command ==> ----- Scroll PAGE
F1=Help      F2=Split     F3=Exit      F4=Deselect  F5=InsRpt    F6=Executed
F7=Backward  F8=Forward    F9=Swap      F10=PrvRpt  F11=NxtRpt   F12=Cancel
  
```

6. Move the cursor to the first **predicate** fragment.
7. Press Enter. The syntax for the predicate clause is displayed.

```

Process  Options  Utilities  Help
-----
FM/Db2 (DFG2)              Advanced SELECT Prototyping
Prototyping: predicate clause           Status: clause incomplete

┌── basicpred ─┘
┌── quantifiedpred ─┘
┌── betweenpred ─┘
┌── distinctpred ─┘
┌── existspred ─┘
┌── inpred ─┘
┌── likepred ─┘
┌── nullpred ─┘

SELECT DISTINCT * FROM PARTS WHERE

Command ==> ----- Scroll PAGE
F1=Help      F2=Split     F3=Exit      F4=Deselect  F5=InsRpt    F6=Executed
F7=Backward  F8=Forward    F9=Swap      F10=PrvRpt  F11=NxtRpt   F12=Cancel
  
```

8. Move the cursor to the **basicpred** fragment.
9. Press Enter. The syntax for the basic predicate clause is displayed.

```

Process  Options  Utilities  Help
-----
FM/Db2 (DFG2)          Advanced SELECT Prototyping
Prototyping: basic predicate clause          Status: clause incomplete

expression = expression
           <> (- fullselect -)
           <
           >
           <=
           >=

(← , expression) = (← , expression)
<>

SELECT DISTINCT * FROM PARTS WHERE

Command ==> ----- Scroll PAGE
F1=Help      F2=Split    F3=Exit      F4=Deselect  F5=InsRpt    F6=Executed
F7=Backward  F8=Forward   F9=Swap      F10=PrvRpt  F11=NxtRpt   F12=Cancel

```

10. Move the cursor to the **expression** fragment (to the left of the list of operators).
11. Press Enter. The syntax for the expression clause is displayed.

```

Process  Options  Utilities  Help
-----
FM/Db2 (DFG2)          Advanced SELECT Prototyping
Prototyping: expression clause          Status: clause incomplete

← oper -----
+ -----
- -----
function -----
(- expression) -----
constant -----
column -----
hostvar -----
register -----
(- scalarfullsel -) -----
duration -----
caseexpr -----
castspec -----
sequenceref -----

SELECT DISTINCT * FROM PARTS WHERE

Command ==> ----- Scroll PAGE
F1=Help      F2=Split    F3=Exit      F4=Deselect  F5=InsRpt    F6=Executed
F7=Backward  F8=Forward   F9=Swap      F10=PrvRpt  F11=NxtRpt   F12=Cancel

```

12. Move the cursor to the **column** fragment.
13. Press Enter. A pop-up panel is displayed in which you can enter a column name.
14. Type `PARTNO` in the pop-up panel.

```

Process  Options  Utilities  Help
-----  -
Freeform Entry
F
P
Enter a column name to be inserted in the SQL:
PARTNO-----
-----
-----
-----
-----
-----
-----
Command ==> ----- Scroll PAGE
F1=Help      F2=Split    F3=Exit     F7=Backward F8=Forward
F9=Swap      F12=Cancel

(- scalarfullsel -)
duration -----
caseexpr -----
castspec -----
sequenceref -----

SELECT DISTINCT * FROM PARTS WHERE PARTNO

Command ==> ----- Scroll PAGE
F1=Help      F2=Split    F3=Exit     F4=Deselect F5=InsRpt  F6=Executed
F7=Backward F8=Forward  F9=Swap     F10=PrvRpt F11=NxtRpt F12=Cancel
    
```

15. Press the Exit function key (F3). The column name PARTNO is added to the SELECT statement.
16. Press the Exit function key (F3). The syntax for the basic predicate clause is displayed.

```

Process  Options  Utilities  Help
-----  -
FM/Db2 (DFG2)      Advanced SELECT Prototyping
Prototyping: basic predicate clause      Status: clause incomplete

expression = expression
          <> (- fullselect -)
          <
          >
          <=
          >=

(- , expression ) = (- , expression )
          <>

SELECT DISTINCT * FROM PARTS WHERE PARTNO

Command ==> ----- Scroll PAGE
F1=Help      F2=Split    F3=Exit     F4=Deselect F5=InsRpt  F6=Executed
F7=Backward F8=Forward  F9=Swap     F10=PrvRpt F11=NxtRpt F12=Cancel
    
```

17. Move the cursor to the "greater than" (>) symbol.
18. Press Enter. A "greater than" (>) symbol is displayed in the partly-built SELECT statement.
19. Move the cursor to the **expression** fragment (to the right of the list of operators).
20. Press Enter. The syntax for the expression clause is displayed.

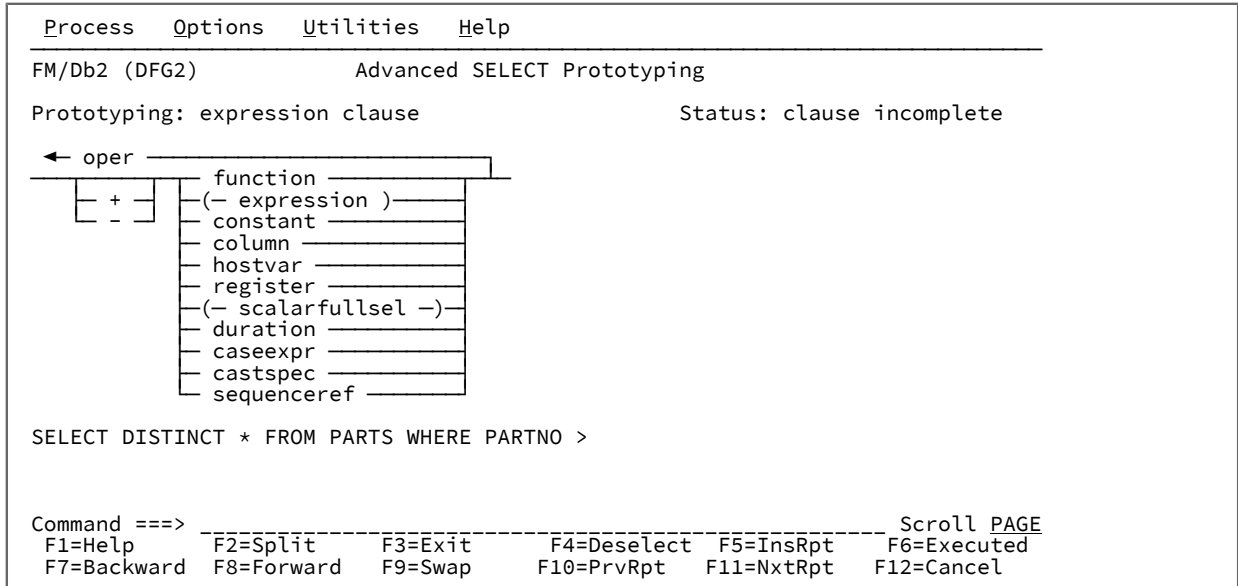

21. Move the cursor to the **constant** fragment.
22. Press Enter. A pop-up panel is displayed in which you can enter a constant.
23. Type 12456 in the pop-up panel.

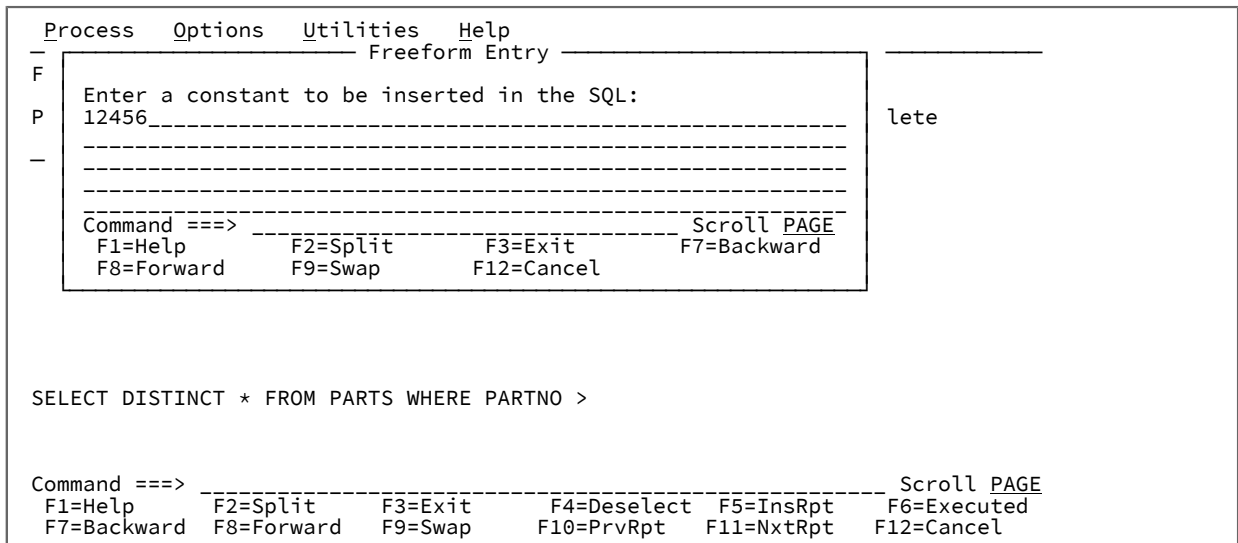

24. Press the Exit function key (F3).

Figure 114. Advanced: the completed statement (example 3)

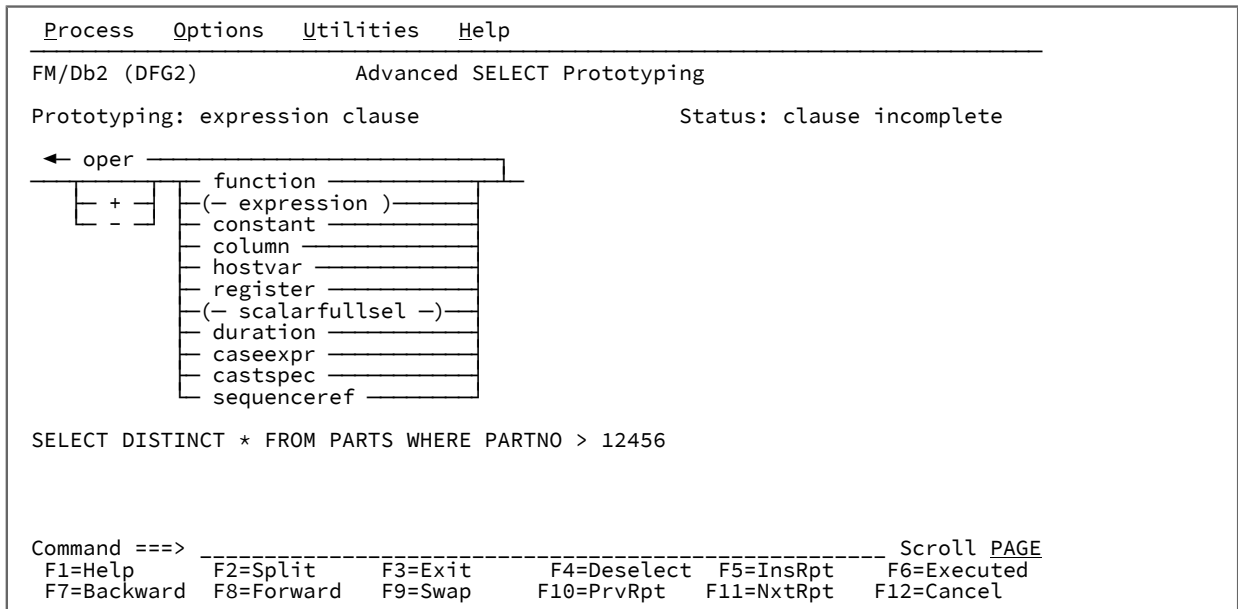

The panel shows the completed SELECT statement:

```
SELECT DISTINCT * FROM PARTS WHERE PARTNO > 12456
```

Related tasks

- [Example 2 \(Changing the SQL statement\) on page 399](#)
- [Executing a SELECT statement after you have built it using prototyping on page 416](#)

Example 4 (Removing part of the SQL statement)

To remove part of a SELECT statement you have built using advanced SELECT prototyping, use the Deselect function key (F4). The effect of the Deselect function key depends on which fragment of the syntax is currently active. For more information, see the description of the DESELECT command.

Suppose that you want to remove the condition you added to the SQL statement in the previous exercise (see [Figure 114: Advanced: the completed statement \(example 3\) on page 406](#)) that restricted the rows shown to those with a part number greater than 12456. This means that you need to remove the WHERE clause from the SELECT statement.

You can remove the WHERE clause by either of these methods:

- Using the Deselect function key (F4):
 1. Place the cursor on the WHERE clause in the generated SELECT statement.
 2. Press Enter to select the WHERE clause. It changes to green, and the syntax for the WHERE clause is redisplayed.
 3. Place the cursor on the command line.
 4. Press the Deselect function key (F4).
- Returning to the prototyping panel that contains the **where** fragment and “deselecting” it:



Note: The following steps assume the current panel on your screen is the last panel in Example 3 as shown in Figure 114: Advanced: the completed statement (example 3) on page 406.

1. Press the Exit function key (F3). FM/Db2 returns you to the syntax for the basic predicate clause.
2. Press the Exit function key (F3). FM/Db2 returns you to the syntax for the predicate clause.
3. Press the Exit function key (F3). FM/Db2 returns you to the syntax for the search condition clause.
4. Press the Exit function key (F3). FM/Db2 returns you to the syntax for the WHERE clause.
5. Press the Exit function key (F3). FM/Db2 returns you to the syntax for the subselect clause. This panel contains the **where** fragment.

```

Process  Options  Utilities  Help
-----
FM/Db2 (DFG2)          Advanced SELECT Prototyping
Prototyping: subselect clause          Status: statement complete
- select - from  [ where ]  [ groupby ]  [ having ]

SELECT DISTINCT * FROM PARTS WHERE PARTNO > 23456

Command ==> ----- Scroll PAGE
F1=Help      F2=Split    F3=Exit     F4=Deselect F5=InsRpt  F6=Executed
F7=Backward  F8=Forward  F9=Swap     F10=PrvRpt F11=NxtRpt F12=Cancel

```

6. Move the cursor to the **where** fragment.
7. Press the Deselect function key (F4).

Figure 115. Advanced: the statement with WHERE clause removed (example 4)

```

Process  Options  Utilities  Help
-----
FM/Db2 (DFG2)          Advanced SELECT Prototyping
Prototyping: subselect clause          Status: statement complete
- select - from  [ where ]  [ groupby ]  [ having ]

SELECT DISTINCT * FROM PARTS

Command ==> ----- Scroll PAGE
F1=Help      F2=Split    F3=Exit     F4=Deselect F5=InsRpt  F6=Executed
F7=Backward  F8=Forward  F9=Swap     F10=PrvRpt F11=NxtRpt F12=Cancel

```

The panel shows the SELECT statement without the WHERE clause:

```
SELECT DISTINCT * FROM PARTS
```

Related tasks

- [Example 3 \(Adding to the SQL statement\) on page 400](#)
- [Executing a SELECT statement after you have built it using prototyping on page 416](#)

Handling repeatable items in the syntax

Some parts of the SELECT statement syntax contain repeatable items where one or more repeatable items are delimited by a repeat separator. The repeat separator for some repeat fragments is a comma (,), for some others it is a constant or an operand, and for others it is a space. If you specify more than one repeatable item, and the separator is constant, Advanced SELECT prototyping inserts the correct separator for you; otherwise, you must select the separator like any other element.

Let's take a simple example to show how you can build a fragment of the SELECT clause with repeatable items. Say you want to show certain information (specified in the rest of the SELECT statement) about a company's employees, grouped by their skill type, grade, and the year they started.

1. Repeat steps 1 to 5 of the first example (see [Example 1 \(Building a simple SQL statement\) on page 394](#)) so that the syntax for the subselect clause is displayed.

```

  Process  Options  Utilities  Help
  -----
  FM/Db2 (DFG2)          Advanced SELECT Prototyping
  Prototyping: subselect clause          Status: clause incomplete
  - select - from  ┌ where ─┐ ┌ groupby ─┐ ┌ having ─┐
  Command ==> ----- Scroll PAGE
  F1=Help      F2=Split    F3=Exit      F4=Deselect  F5=InsRpt    F6=Executed
  F7=Backward  F8=Forward  F9=Swap      F10=PrvRpt  F11=NxtRpt   F12=Cancel
  
```

2. Move the cursor to the **groupby** fragment.
3. Press Enter. The syntax for the GROUP BY clause is displayed.

```

Process  Options  Utilities  Help
-----
FM/Db2 (DFG2)          Advanced SELECT Prototyping
Prototyping: group by clause          Status: clause incomplete

- GROUP BY ← , groupingexpr ─┘

GROUP BY

Command ==> ----- Scroll PAGE
F1=Help      F2=Split    F3=Exit     F4=Deselect F5=InsRpt   F6=Executed
F7=Backward  F8=Forward  F9=Swap     F10=PrvRpt F11=NxtRpt  F12=Cancel

```

Notice that FM/Db2 shows the required keywords GROUP BY in the partly-built SQL clause on the panel.

You can see that the syntax for the GROUP BY clause consists of:

- The required key words GROUP BY (shown on your screen in white),
- The repeatable item **groupingexpr** (shown on your screen in red), and
- A comma (,) as the repeat separator.

4. Move the cursor to the **groupingexpr** fragment.
5. Press the InsRpt function key (F5). A pop-up panel is displayed in which you can enter a column name.
6. Type `SKILLTYPE` in the pop-up panel.

```

Process  Options  Utilities  Help
-----
Freeform Entry -----
F
P  Enter a grouping expression to be inserted in the SQL:
   SKILLTYPE-----
   -----
   -----
   -----
Command ==> ----- Scroll PAGE
F1=Help      F2=Split    F3=Exit     F7=Backward F8=Forward
F9=Swap      F12=Cancel

```

lete

```

GROUP BY

Command ==> ----- Scroll PAGE
F1=Help      F2=Split    F3=Exit     F4=Deselect F5=InsRpt   F6=Executed
F7=Backward  F8=Forward  F9=Swap     F10=PrvRpt F11=NxtRpt  F12=Cancel

```

7. Press the Exit function key (F3). The column name SKILLTYPE is added to the GROUP BY clause.

```

Process  Options  Utilities  Help
-----
FM/Db2 (DFG2)          Advanced SELECT Prototyping
Prototyping: group by clause          Status: clause complete

- GROUP BY ← , groupingexpr ┘

GROUP BY SKILLTYPE

Command ==> ----- Scroll PAGE
F1=Help      F2=Split    F3=Exit     F4=Deselect F5=InsRpt   F6=Executed
F7=Backward  F8=Forward  F9=Swap     F10=PrvRpt F11=NxtRpt  F12=Cancel
    
```

Notice that, at this stage, FM/Db2 has not added a repeat separator to the statement. If you are only specifying one repeatable item, this is the correct syntax. However, if FM/Db2 detects that you are specifying more than one repeatable item (as in the following steps), it inserts the repeat separator.

8. Again, move the cursor to the **groupingexpr** fragment.
9. Press the InsRpt function key (F5) to display the pop-up panel.
10. Type `EMPGRADE` in the pop-up panel.
11. Press the Exit function key (F3). The repeat separator and column name `EMPGRADE` are added to the GROUP BY clause.

```

Process  Options  Utilities  Help
-----
FM/Db2 (DFG2)          Advanced SELECT Prototyping
Prototyping: group by clause          Status: clause complete

- GROUP BY ← , groupingexpr ┘

GROUP BY SKILLTYPE , EMPGRADE

Command ==> ----- Scroll PAGE
F1=Help      F2=Split    F3=Exit     F4=Deselect F5=InsRpt   F6=Executed
F7=Backward  F8=Forward  F9=Swap     F10=PrvRpt F11=NxtRpt  F12=Cancel
    
```

12. Repeat steps 8 on page 410 through 11 on page 410 for `STARTYEAR`.

```

  Process  Options  Utilities  Help
  -----
  FM/Db2 (DFG2)          Advanced SELECT Prototyping
  Prototyping: group by clause          Status: clause complete

  - GROUP BY ← , groupingexpr ─┘

  GROUP BY SKILLTYPE, EMPGRADE, STARTYEAR

  Command ==> ----- Scroll PAGE
  F1=Help      F2=Split      F3=Exit      F4=Deselect  F5=InsRpt    F6=Executed
  F7=Backward  F8=Forward    F9=Swap      F10=PrvRpt  F11=NxtRpt   F12=Cancel

```

The panel shows the completed GROUP BY clause:

```
GROUP BY SKILLTYPE , EMPGRADE , STARTYEAR
```



Note: If you only require one repeatable item in the fragment, after you move the cursor to the **groupingexpr** fragment (step 4 on page 409), you can press the InsRpt function key (F5) or Enter.

Related tasks

- [Example 1 \(Building a simple SQL statement\) on page 394](#)
- [Navigating through the repeatable items on page 411](#)
- [Inserting an extra repeatable item on page 412](#)
- [Changing a repeatable item on page 412](#)
- [Deleting a repeatable item on page 413](#)
- [Handling selectable repeat separators on page 414](#)
- [Points to consider when working with repeatable items on page 415](#)

Navigating through the repeatable items

After you have added a number of repeatable items to a clause, you might need to modify part of the clause by inserting an extra repeatable item, or changing or deleting an existing repeatable item. In any of these cases, you need to navigate your way through the repeatable items so that the appropriate repeatable item is current.

To make a repeatable item current (and therefore change its color from yellow to green), either:

- Move the cursor to one of the elements within the repeat group in the syntax, and use PrvRpt (F10) to scroll backwards or NxtRpt (F11) to scroll forwards through the repeatable items in the generated statement, or
- Move the cursor to the repeatable item in the generated statement, and press Enter.

Inserting an extra repeatable item

Suppose you need to insert an extra repeatable item (department) in the previous GROUP BY clause so that the information is grouped by their skill type, *department*, level, and the year they started:

1. Move the cursor to the **SKILLTYPE** repeatable item (that is to precede the new repeatable item) in the GROUP BY clause.
2. Press Enter to make **SKILLTYPE** the current repeatable item. Its color changes from yellow to green.
3. Move the cursor to the **groupingexpr** fragment.
4. Press the InsRpt function key (F5). A pop-up panel is displayed in which you can enter a column name.
5. Type **DEPT** in the pop-up panel.
6. Press the Exit function key (F3). The repeat separator and the new repeatable item, DEPT, are added to the GROUP BY statement after the SKILLTYPE repeatable item.

```

  Process  Options  Utilities  Help
  -----
  FM/Db2 (DFG2)          Advanced SELECT Prototyping
  Prototyping: group by clause          Status: clause complete
  - GROUP BY  ← , groupingexpr  |
  -----
  GROUP BY SKILLTYPE , DEPT , EMPGRADE , STARTYEAR

  Command ==> ----- Scroll PAGE
  F1=Help      F2=Split      F3=Exit      F4=Deselect  F5=InsRpt   F6=Executed
  F7=Backward  F8=Forward     F9=Swap      F10=PrvRpt  F11=NxtRpt  F12=Cancel
  
```

Changing a repeatable item

Suppose you want to change the name of the repeatable item, EMPGRADE, in the previous GROUP BY clause to EMPLEVEL:

1. Move the cursor to the **groupingexpr** fragment.
2. Press the NxtRpt function key (F11) to make EMPGRADE the current repeatable item. Its color changes from yellow to green.
3. Press Enter. A pop-up panel is displayed showing the repeatable item EMPGRADE already entered.

```

Process  Options  Utilities  Help
-----  -
Freeform Entry
F
P
Enter a column name to be inserted in the SQL:
EMPGRADE_-----
-----
-----
-----
-----
-----
-----
-----
Command ==>----- Scroll PAGE
F1=Help      F2=Split    F3=Exit     F7=Backward
F8=Forward   F9=Swap     F12=Cancel

```

GROUP BY SKILLTYPE , DEPT , EMPGRADE , STARTYEAR

```

Command ==>----- Scroll PAGE
F1=Help      F2=Split    F3=Exit     F4=Deselect F5=InsRpt   F6=Executed
F7=Backward  F8=Forward  F9=Swap     F10=PrvRpt F11=NxtRpt  F12=Cancel

```

- You can now edit the name of the column in the pop-up panel. Change it to `EMPLEVEL`.
- Press the Exit function key (F3). `EMPGRADE` is replaced by `EMPLEVEL` in the `GROUP BY` statement.

```

Process  Options  Utilities  Help
-----  -
FM/Db2 (DFG2)          Advanced SELECT Prototyping
Prototyping: group by clause          Status: clause complete
- GROUP BY ← , groupingexpr

```

GROUP BY SKILLTYPE , DEPT , EMPLEVEL , STARTYEAR

```

Command ==>----- Scroll PAGE
F1=Help      F2=Split    F3=Exit     F4=Deselect F5=InsRpt   F6=Executed
F7=Backward  F8=Forward  F9=Swap     F10=PrvRpt F11=NxtRpt  F12=Cancel

```

Deleting a repeatable item

Suppose you want to remove the repeatable item, `STARTYEAR`, from the previous `GROUP BY` clause:

- Move the cursor to the repeatable item, `STARTYEAR`
- Press Enter to make `STARTYEAR` the current repeatable item. Its color changes from yellow to green.
- Move the cursor to the **groupingexpr** fragment.

4. Press the Deselect function key (F4). The repeatable item, STARTYEAR (and its preceding repeat separator), is deleted from the GROUP BY clause.

```

Process  Options  Utilities  Help
-----
FM/Db2 (DFG2)          Advanced SELECT Prototyping
Prototyping: group by clause          Status: clause complete

- GROUP BY ← , groupingexpr

GROUP BY SKILLTYPE , DEPT , EMPLEVEL

Command ==> ----- Scroll PAGE
F1=Help      F2=Split    F3=Exit     F4=Deselect  F5=InsRpt   F6=Executed
F7=Backward  F8=Forward  F9=Swap     F10=PrvRpt  F11=NxtRpt  F12=Cancel
    
```

Handling selectable repeat separators

Some repeatable items in the SELECT statement syntax have a repeat separator that you can select (rather than a constant such as a comma). For example, the expression clause as shown in [Figure 116: Example of a selectable repeat separator on page 414](#) uses an operator (**oper**) as a repeat separator.

Figure 116. Example of a selectable repeat separator

```

Process  Options  Utilities  Help
-----
FM/Db2 (DFG2)          Advanced SELECT Prototyping
Prototyping: expression clause          Status: clause incomplete

← oper
┌───┴───┐
├── + ──┤ function
├── - ──┤ (- expression -)
├──   ──┤ constant
├──   ──┤ column
├──   ──┤ hostvar
├──   ──┤ register
├──   ──┤ (- scalarfullsel -)
├──   ──┤ duration
├──   ──┤ caseexpr
├──   ──┤ castspec
├──   ──┤ sequenceref
└──   ──┘

SELECT ALL

Command ==> ----- Scroll PAGE
F1=Help      F2=Split    F3=Exit     F4=Deselect  F5=InsRpt   F6=Executed
F7=Backward  F8=Forward  F9=Swap     F10=PrvRpt  F11=NxtRpt  F12=Cancel
    
```

To show how to handle selectable repeat separators, we'll use an example. To generate the following expression clause:

```
AMT1 + AMT2 - AMT3
```

where the columns `AMT1`, `AMT2`, and `AMT3` are three repeat items, and `+` and `-` are the two repeat separators, perform the following steps:

1. Move the cursor to the **column** element and press Enter. A pop-up panel is displayed.
2. Type `AMT1` and press the InsRpt function key (F5). AMT1 is added to the clause:

```
AMT1
```

3. Move the cursor to the **oper** repeat separator and press the InsRpt function key (F5). A list of valid repeat separators is displayed.
4. Move the cursor to the “+” repeat separator and press Enter. “+” is added to the clause:

```
AMT1 +
```

5. Press the Exit function key (F3). The syntax for the expression clause is redisplayed.
6. Move the cursor to the **column** element and press Enter. A pop-up panel is displayed.
7. Type `AMT2` and press the InsRpt function key (F5). AMT2 is added to the clause:

```
AMT1 + AMT2
```

8. Move the cursor to the **oper** repeat separator and press the InsRpt function key (F5). A list of valid repeat separators is displayed.
9. Move the cursor to the “-” repeat separator and press Enter. “-” is added to the clause:

```
AMT1 + AMT2 -
```

10. Press the Exit function key (F3). The syntax for the expression clause is redisplayed.
11. Move the cursor to the **column** element and press Enter. A pop-up panel is displayed.
12. Type `AMT3` and press the InsRpt function key (F5). AMT3 is added to the clause:

```
AMT1 + AMT2 - AMT3
```



Note: The repeat separator is associated with the repeat item it follows. When the last repeat item is current, you cannot edit the repeat separator.

Points to consider when working with repeatable items

If you are working with repeatable items, keep in mind the following:

- Repeatable item commands are only effective if you move the cursor to one of the elements of the repeatable item.
- For each repeatable item in a fragment (generally none or one), only one instance of the item is current at a given time. Generated data for the current instance is displayed in green; generated data for any other instances is displayed in yellow.
- Press the PrvRpt (F10) and NxtRpt (F11) function keys to navigate between the instances.
- The InsRpt function key (F5) inserts a repeat instance after the active repeat instance and makes the new repeat instance active.
- If there are no instances for a repeatable item, you can create the initial instance and make it active by either:
 - Using the InsRpt function key (F5), or
 - Moving the cursor to an element of the repeatable item and pressing Enter
- If there is already an instance of a repeatable item, pressing Enter with the cursor on an element of the repeatable item causes that element to be “edited”.

Executing a SELECT statement after you have built it using prototyping

When you have completed building an SQL SELECT statement, using either basic SELECT prototyping or advanced SELECT prototyping, you can run it by:

- Entering the EXECUTE primary command, or
- Pressing the Execute function key (F6)

FM/Db2 displays the results according to the **Use edit (instead of browse) to display results** option. If this option is selected, FM/Db2 displays the results using FM/Db2 Edit; otherwise, FM/Db2 displays the results using FM/Db2 Browse.

Figure 117: Sample results table displayed using Browse on page 416 shows a results table using FM/Db2 Browse.

Figure 117. Sample results table displayed using Browse

```

Process  Options  Utilities  Help
-----
FM/Db2 (DFG2)          Select Statement Browse
RESULTS FOR SELECT #1.FIRSTNME, #1.LASTNAME, #1.JOB FROM D...   Format TABL
FIRSTNME  LASTNAME  JOB
#2        #4        #8
VARCHAR(12) VARCHAR(15) CH(8)
<-----1-> <-----1-----> <----->
*** Top of data ***
MICHAEL<  THOMPSON<  MANAGER
IRVING<   STERN<    MANAGER
EVA<     PULASKI<  MANAGER
THEODORE< SPENSER<  MANAGER
VINCENZO< LUCCHESI< SALESREP
SEAN<    O'CONNELL< CLERK
DOLORES< QUINTANA< ANALYST
HEATHER<  NICHOLLS< ANALYST
ELIZABETH< PIANKA<   DESIGNER
MASATOSHI< YOSHIMURA< DESIGNER
MARILYN<  SCOUTTEN< DESIGNER
JAMES<    WALKER<   DESIGNER
Command ==>----- Scroll PAGE
F1=Help    F2=Zoom   F3=Exit   F4=CRetriev F5=RFind   F6=RChange
F7=Up      F8=Down   F9=Swap   F10=Left   F11=Right  F12=Cancel
    
```

If there is insufficient space on the panel to show all of the columns, use the LEFT primary command to scroll left, or the RIGHT primary commands to scroll right, to view the additional columns.

Related tasks

[FM/Db2 system options \(option 0.2\) on page 63](#)

Related references

[EXECUTE primary command on page 893](#)

Entering, executing, and explaining SQL statements

If you want to:

- Enter freeform SQL statements,
- Run freeform SQL statements, or
- Obtain information about an SQL statement

select option 3 (Enter) on the SQL Prototyping, Execution and Analysis panel.

When you select this option, FM/Db2 displays the Enter, Execute and Explain SQL Statements panel.

Related tasks

[Entering SQL statements on page 417](#)

[Executing SQL statements on page 418](#)

[Explaining SQL on page 419](#)

Related references

[SQL Prototyping, Execution and Analysis panel on page 806](#)

[Enter, Execute and Explain SQL Statements panel on page 660](#)

Entering SQL statements

You can enter SQL statements freeform in the SQL statement entry area. If you want to enter more than one SQL statement, you must separate the statements with a semicolon (;). When the SQL statements are processed, the last column of each line is joined directly to the first column of the next line. If a token ends in the last column of a line, ensure that the first column of the next line contains a blank or a delimiter token.

For detailed information about constructing SQL statements, see the *DB2 for z/OS SQL Reference*.

Editing SQL

You can edit the SQL you have entered by entering the SQL primary command. The SQL you have entered is copied to a temporary data set and an ISPF edit session is started. When you complete the Edit session, the temporary data set is copied back to the entry area on the Enter, Execute and Explain SQL Statements panel.

When you edit the SQL, you can:

- Save it to a data set for later use (using the ISPF edit CREATE command).
- Retrieve SQL you have saved previously (using the ISPF edit COPY command).
- Exploit the power of the ISPF editor to construct your SQL.

Related references

[Enter, Execute and Explain SQL Statements panel on page 660](#)

[SQL primary command on page 942](#)

Limiting the rows loaded into the FM/Db2 editor

To limit the rows loaded into the FM/Db2 editor when the SQL statement being processed is a SELECT statement, specify the maximum number of rows in the **Row count** field on the Enter, Execute and Explain SQL Statements panel.

To load all rows for the SELECT statement, specify * or ALL in this field.

Scrolling the entry area

If the statement you are entering extends beyond the visible display area, you can scroll through your data, using the following function keys:

Up function key (F7)

Scroll backward (up)

Down function key (F8)

Scroll forward (down)

You can also scroll using the primary commands UP and DOWN.

To control how far you scroll when you press one of the scrolling function keys, enter a scroll amount in the **Scroll** field:

Scroll amount

Scrolls...

PAGE

One page of data at a time

HALF

Half a page of data at a time

MAX

To the top or bottom

DATA

One line less than a page of data at a time

CSR

To the cursor position (if the cursor is within the data, otherwise the default scroll amount, PAGE, applies)

nnnn

nnnn lines at a time.

Related references

[Enter, Execute and Explain SQL Statements panel on page 660](#)

Executing SQL statements

To run the SQL you have entered in the statement entry area, press Enter.

If the SQL statement returns a result table, FM/Db2 displays it in an edit or browse panel, depending on the setting of the **Use edit (instead of browse) to display results** option.

If you have entered more than one SQL statement, the statements are run in sequence, interrupted by the display of any result tables. Execution continues until:

- An error occurs,
- The CANCEL command is entered on a result table display, or
- All the statements have been run

You can use the Enter, Execute and Explain SQL Statements panel to specify one or more of the following SQL SELECT statements (without using prototyping) and then run them in sequence:

ALTER	COMMENT ON	COMMIT
CREATE	DELETE	DROP
EXPLAIN	GRANT	INSERT
LABEL ON	LOCK TABLE	RENAME
REVOKE	ROLLBACK	SELECT
SET CURRENT DEGREE	SET CURRENT SQLID	UPDATE

Related tasks

[Entering SQL statements on page 417](#)

[FM/Db2 system options \(option 0.2\) on page 63](#)

Related references

[Enter, Execute and Explain SQL Statements panel on page 660](#)

SQL cost

If any SELECT statements are run, and no errors occur, FM/Db2 displays a message after each execution showing the total SQL “cost” of all the SELECT statements.

SQL errors

If an SQL error occurs while a statement is being run or explained, a panel is displayed containing the SQL error information.

To display the full text of the SQL statement that caused the error, press the SQL function key (F5) or enter `SQL` on the command line.

When you return from the error panel, FM/Db2 places the cursor on the failing statement or, if a syntax error occurred, places the cursor on the token in the failing statement that Db2® identified as in error. Statements that ran successfully before the failing statement are not rolled back, and no further statements are run or explained.

Explaining SQL

To explain the SQL you have entered in the statement entry area, enter the EXPLAIN primary command. FM/Db2 creates an EXPLAIN statement for the entered SQL, and optionally displays the Plan Table Rows panel showing the rows added by Db2® as a result of the explain.



Note: For detailed information about explaining an SQL statement, see the *DB2 for z/OS SQL Reference*.

To help identify the results of this explanation, you can enter a number in the **Query number** entry field. If you leave **Query number** blank, FM/Db2 generates a query number for you in the format YYYYMMDDss, where ss is a sequence number.

If you have selected the **Show results** option, FM/Db2 attempts to display the relevant rows that Db2® has inserted in the plan table as a result of explaining the statement. If you have entered more than one SQL statement, the statements are explained in sequence, interrupted by the display of the plan table rows. Execution continues until an error occurs, the CANCEL command is entered on a plan table display, or all the statements have been explained.

You can use the Enter, Execute and Explain SQL Statements panel to explain the following SQL statements:

SELECT
INSERT
UPDATE (searched form only)
DELETE (searched form only)

The following primary commands are available with the Enter, Execute and Explain SQL Statements panel:

- DOWN
- EXECUTE
- EXPLAIN
- SQL
- UP

Related tasks

[Entering SQL statements on page 417](#)
[Executing SQL statements on page 418](#)
[Additional considerations for EXPLAIN on page 421](#)

Related references

[Enter, Execute and Explain SQL Statements panel on page 660](#)
[Plan Table Rows panel on page 725](#)
[DOWN primary command on page 885](#)
[EXECUTE primary command on page 893](#)
[EXPLAIN primary command on page 894](#)
[SQL primary command on page 942](#)
[UP primary command on page 945](#)

Additional considerations for EXPLAIN

The EXPLAIN primary command constructs and runs an SQL EXPLAIN statement. For the explain statement to run successfully, a *plan table* (called PLAN_TABLE) must exist with an owner name matching your current SQL authorization ID. Db2® places the results of the EXPLAIN statement in the plan table.

FM/Db2 also places relevant data in a *statement table* (called DSN_STATEMNT_TABLE) and a *function table* (called DSN_FUNCTION_TABLE) if they exist.

You can access the statement and function table rows related to a plan table row by using line commands.

Related tasks

[Explaining SQL on page 419](#)

[Managing tables used by SQL explain on page 422](#)

Related references

[COL primary command on page 880](#)

[PLAN primary command on page 926](#)

[HINT primary command on page 910](#)

Editing and executing SQL statements from a data set

If you want to:

- Optionally initiate an ISPF Edit session on a data set or PDS member containing SQL statements
- Run the SQL statements in a data set or PDS member

select option 4 (Edit) on the SQL Prototyping, Execution and Analysis panel.



Note: You cannot use this option to create a new member.

When you select this option, FM/Db2 displays the Edit and Execute SQL Statements from a Data Set panel.

To use this panel:

1. Specify the name of the data set or PDS member containing the SQL statements you want to edit. Use a combination of the **Data set name**, **Member**, and **Volume serial** entry fields.
2. To limit the rows loaded into the FM/Db2 editor when the SQL statement being processed is a SELECT statement, specify the maximum number of rows in the **Row count** field on the Edit and Execute SQL Statements from a Data Set panel.

To load all rows for the SELECT statement, specify * or ALL in this field.

3. Set the processing options.
4. Press Enter.

If you selected the **Edit data set** processing option, the contents of the specified data set or PDS member are displayed in an ISPF Edit session. When you have completed editing the SQL statements, press the Exit function key (F3) to run the commands (the **Execute SQL from data set** processing option must be selected).

If you selected the **Execute SQL from data set** processing option, but not the **Edit data set** processing option, FM/Db2 immediately runs the SQL commands in the specified data set or PDS member



Note: If an SQL error occurs, to prevent FM/Db2 executing further SQL statements, use the Cancel function key (F12) to return you to the Edit and Execute SQL Statements from a Data Set panel.

Related tasks

[Specifying a data set and a member name on page 50](#)

Related references

[SQL Prototyping, Execution and Analysis panel on page 806](#)

[Edit/Execute SQL \(Data Set\) panel on page 623](#)

Managing tables used by SQL explain

If you want to select functions to support the use of the SQL EXPLAIN statement, select option 5 (Utility) on the SQL Prototyping, Execution and Analysis panel.

When you select this option, FM/Db2 displays the Explain Utilities panel. This panel lets you create and delete the tables used by the SQL EXPLAIN statement. For additional information about the tables used by the SQL EXPLAIN statement, see the *DB2 for z/OS SQL Reference*.

Use the Explain Utilities panel to specify the type of function you want to perform. For more details about using this panel, refer to the reference sections.

Related tasks

[Entering, executing, and explaining SQL statements on page 416](#)

Related references

[SQL Prototyping, Execution and Analysis panel on page 806](#)

[Explain Utilities panel on page 662](#)

Exiting SQL prototyping

To exit SQL prototyping, issue the CANCEL primary command or press the Cancel function key (F12).

Related references

[CANCEL primary command on page 873](#)

Chapter 14. Using FM/Db2 functions in batch jobs

You can perform FM/Db2 functions that can be executed in batch jobs.

FM/Db2 functions that can be executed in batch jobs.

Edit models are provided that insert predefined statements and instructions for a selected File Manager/Db2 function or REXX external function.

JCL syntax for File Manager/Db2 batch jobs

To use a File Manager/Db2 function in a batch job, include the following statement: `//stepname EXEC`

```
PGM=FMNDB2,PARM=('SSID=sysid,SQLID=sqlid')
```

where,

sysid

Refers to the Db2 subsystem where the FM/Db2 functions run.

sqlid

Refers to the Db2 SQLID under which the FM/Db2 functions run.

By default, report output is written to SYSPRINT. Sections of the output can be directed instead to the following ddnames:

FMNRPRM

\$\$FILEM command parameters and return codes

FMNREPT

Command reports and return codes

If FMNPRINT is present in the JCL, it is used instead of SYSPRINT. If FMNIN is present in the JCL, it is used instead of SYSIN.

You might also need a STEPLIB statement or other DD statements, depending on which File Manager functions the batch job contains.

When you code File Manager control statements, you must:

- Begin each control statement with `$$FILEM` in columns 1 to 7, followed by a blank in column 8, followed by the command name, followed by the first parameter (if any).
- Specify parameters and their values separated by an equal sign, as follows:

```
PARAMETER=value
```

- Follow each parameter (except the last one) immediately with a comma.

Comment statements, which begin with an asterisk (*), are also allowed.

To continue a control statement onto the next line, end the first line with a comma and begin the next line with `$$FILEM` and a blank.

To continue a parameter that does not fit onto one line, do not use a continuation character. Instead, split the parameter into more than one line, enclosing each part in apostrophes. For example:

```
$$$FILEM OBJIOWNR=' LONGOWNER1234567890123456789012345678901',
$$$FILEM '2345678901234567890123456789012345678901NAME',
```



Notes:

1. If the control statement contains only the function name, there must be a space between the function name and the comma.
2. To change processing options in batch or to reset options to the installation default, use the SET function.

Example

Example

The following example shows a batch job that uses the FM/Db2 DSP function to print the Db2 table:

```
//jobcard
$$$FILEM DBP FORMAT=TABLE,
$$$FILEM OBJIOWNR=' LONGOWNER1234567890123456789012345678901',
$$$FILEM '2345678901234567890123456789012345678901NAME',
$$$FILEM OBJIOWNR=' DUMMY_TABLE_WITH_A_LO23456789012345678901',
$$$FILEM '12345678901234567890123456789012345678901LONG_NAME',
$$$FILEM UCREAD=YES,
$$$FILEM NULLIND=_,
$$$FILEM ROWS=ALL
```

Using File Manager/Db2 edit models

This topic explains how to use edit models to create batch JCL to access File Manager/Db2 functions.

The ISPF environment of your site must be configured to enable access to the File Manager edit models. See *“Implementing File Manager edit models in ISPF Edit”* in the *File Manager for z/OS Customization Guide*.

Edit models

An ISPF edit model is a predefined set of statements. You can include these statements in a member that you are editing and then modify them to suit your needs. Along with the edit models that are shipped with ISPF, File Manager includes edit models for the File Manager Base component, FM/Db2, and FM/IMS functions and REXX external functions.

An edit model has two parts:

Data lines

These are the actual lines that are placed in the data you are editing. In the File Manager ISPF models the data lines describe the format of function parameters.

Notes

Notes provide tutorial information about the function parameters. These describe how to update the data lines to your requirements.

When you enter the MODEL command, you can select the File Manager function for the data type (JCL or EXEC) of the member that is being edited.

Using edit models

If you edit a member of a data set of type JCL or EXEC and then issue the MODEL command, a list of applicable File Manager functions or REXX external functions is displayed.

JCL

The **File Manager Models** panel lists the available edit models, grouped by category.

You can enter RF to display another panel which lists the available edit models for REXX external functions.

EXEC

The **REXX Models** panel is displayed.

Enter FF to display the **File Manager REXX Function Models** panel, which lists the available edit models for REXX external functions.

Enter the function name to insert the statements from that edit model in the edit session. For example, enter DSEB to insert the Batch Edit model. Use the A (after) or B (before) line command to insert the statements at a specific location.

Issue the RESET command to permanently remove the note lines, leaving only the data lines.

Edit model example: JCL that calls the DBP function

This example shows how to use edit models to generate a batch job to print a Db2 table using the DBP function.

1. Select option 2 from the ISPF Primary Option Menu.
2. In the **Edit Entry Panel**, enter the name of a new member in a data set of type "JCL". Example:

```
Data Set Name . . . 'EXAMPLE.JCL(newdbpx)'
```

3. In the edit session, enter the MODEL primary command.

```

File Edit Edit_Settings Menu Utilities Compilers Test Help
-----
EDIT          EXAMPLE.JCL(NEWDBPX) - 01.00          Columns 00001 00072
Command ==> model                               Scroll ==> CSR
***** ***** Top of Data *****
!!!!!!
!!!!!!
```

The **File Manager Models** panel lists the available edit models in the JCL class.

```

File Manager Models
Option ==> jd
-----
Enter number or service name (RF for External Rexx Functions)
Enter END command to cancel MODEL command.

FM/BASE
AUD Audit Base/Db2/IMS
CLM Load Module compare
DSB Resource Browse
DSC Resource Copy
DSE Resource Edit
DSEB Batch Edit
DSM Compare
DSG Generate
DSP Print
DSU Resource Update
DSV Resource view
FCH Find/Change
NSRT NOSORT (no DFSORT)
PBK Print Copybooks
SET Set options
SETRC Set Return code
VER Version information
VLM View load Module

Base Templates
BTB Batch Template Build
BTU Batch Template Update
TPIM Template Import
TPXP Template Export

Db2 Templates
D2TP DB2 Template Crt/Upd

IMS Templates
ICU IMS Criteria Update
ITU IMS Template Update
IVU IMS View Update

Data set functions
DSFA Data Set Alter
DSFC Data Set Allocate
DSFD Data Set Delete
DSFR Data Set Rename

Db2 functions
BSQL Batch SQL
DBC Batch Db2 Copy
DBI Batch Db2 Import
DBP Batch Db2 Print
DBX Batch Db2 Export
D2G Db2 Data Generation

IMS functions
DBI IMS Initialization
IBB IMS Batch Browse
IEB IMS Batch Edit
ILB IMS Load
IPR IMS Print
IXB IMS Extract

File Manager JCL
JB FM/Base JCL
JD FM/Db2 JCL
JI FM/IMS JCL

F1=Help F3=Exit F12=Cancel

```

4. Enter JD.

The edit model for the FM/Db2 JCL is copied into the edit session.

```

File Edit Edit_Settings Menu Utilities Compilers Test Help
EDIT EXAMPLE.JCL(NEWDBPX) - 01.00 Columns 00001 00072
Command ==> Scroll ==> CSR
***** Top of Data *****
=NOTE= -----
=NOTE= -- --
=NOTE= -- DB2 JCL --
=NOTE= -----
000001 //FMNDB2 EXEC PGM=FMNDB2,PARM=('SSID=sysid,SQID=sqld')
000002 //SYSPRINT DD SYSOUT=*
000003 //FMNTSPRT DD SYSOUT=*
000004 //SYSOUT DD SYSOUT=*
000005 //SYSTEM DD SYSOUT=*
000006 //SYSTSPRT DD SYSOUT=*
=NOTE=
000007 //FMNODPP DD DISP=SHR,DSN=OPTIM.ODPP.SAMPLIB(ENVVARS)
=NOTE=
=NOTE= FMNODPP DD
=NOTE= To enable File Manager to specify and run ODPP commands,
=NOTE= you must first allocate or define a DD name FMNODPP.
=NOTE=
=NOTE= This name points to a data set that contains the
=NOTE= environment variables that are required by the ODPP
=NOTE= to run as a TSO or batch application.
=NOTE=
=NOTE=
=NOTE= Where the data set member ENVVARS contains the following lines:
=NOTE=
=NOTE= LIBPATH=/usr/local/odpp/odppbin
=NOTE= ODPPPL=/usr/local/odpp/licensefiles
=NOTE= ODPPERL=/usr/local/odpp/odppbin
=NOTE= ODPPTRCL=/usr/local/odpp/tracefiles
=NOTE= ODPPTRC=N
=NOTE=
000008 //SYSIN DD *
=NOTE=
=NOTE= DBP (Db2 Print)
=NOTE=
=NOTE= Purpose
=NOTE= To print the contents of a Db2. object in a variety of formats.
=NOTE=
=NOTE= Usage
=NOTE= The Print utility function can:
=NOTE= - Print data in table or single formats, in either character or
=NOTE= HEX.
=NOTE= - Select the rows and columns to be printed.
=NOTE= - Limit the number of rows to be printed.
=NOTE=
:

```

Notes are identified by the characters `=NOTE=` in the line command field. The notes contain information to help in modifying the JCL statements and parameters.

5. Issue the RESET command to permanently remove the note lines, leaving only the data lines.
6. Overtyping line 000008 with the A line command and then enter the MODEL primary command.

```

File Edit Edit_Settings Menu Utilities Compilers Test Help
EDIT          EXAMPLE.JCL(NEWDBPX) - 01.00          Columns 00001 00072
Command ==> model          Scroll ==> CSR
***** ***** Top of Data *****
000001 //FMNDB2 EXEC PGM=FMNDB2,PARM=('SSID=sysid,SQID=sqid')
000002 //SYSPRINT DD SYSOUT=*
000003 //FMNTSPRT DD SYSOUT=*
000004 //SYSOUT DD SYSOUT=*
000005 //SYSTEM DD SYSOUT=*
000006 //SYSTSPRT DD SYSOUT=*
000007 //FMNODPP DD DISP=SHR,DSN=OPTIM.ODPP.SAMPLIB(ENVVARS)
A
000009 /*
***** ***** Bottom of Data *****

```

7. Enter DBP.

The edit model for the FM/Db2 Print function is copied into the edit session.

```

File Edit Edit_Settings Menu Utilities Compilers Test Help
EDIT          EXAMPLE.JCL(NEWDBPX) - 01.00          Columns 00001 00072
Command ==>          Scroll ==> CSR
***** ***** Top of Data *****
000001 //FMNDB2 EXEC PGM=FMNDB2,PARM=('SSID=sysid,SQID=sqid')
000002 //SYSPRINT DD SYSOUT=*
000003 //FMNTSPRT DD SYSOUT=*
000004 //SYSOUT DD SYSOUT=*
000005 //SYSTEM DD SYSOUT=*
000006 //SYSTSPRT DD SYSOUT=*
000007 //FMNODPP DD DISP=SHR,DSN=OPTIM.ODPP.SAMPLIB(ENVVARS)
000008 //SYSIN DD *
=NOTE=
=NOTE= DBP (Db2 Print)
=NOTE=
=NOTE= Purpose
=NOTE= To print the contents of a Db2. object in a variety of formats.
=NOTE=
=NOTE= Usage
=NOTE= The Print utility function can:
=NOTE= - Print data in table or single formats, in either character or
:

```

8. Once again, issue the RESET command to remove the note lines.

```

File Edit Edit_Settings Menu Utilities Compilers Test Help
EDIT          EXAMPLE.JCL(NEWDBPX) - 01.00          Columns 00001 00072
Command ==>          Scroll ==> CSR
***** ***** Top of Data *****
000001 //FMNDB2 EXEC PGM=FMNDB2,PARM=('SSID=sysid,SQID=sqid')
000002 //SYSPRINT DD SYSOUT=*
000003 //FMNTSPRT DD SYSOUT=*
000004 //SYSOUT DD SYSOUT=*
000005 //SYSTEM DD SYSOUT=*
000006 //SYSTSPRT DD SYSOUT=*
000007 //FMNODPP DD DISP=SHR,DSN=OPTIM.ODPP.SAMPLIB(ENVVARS)
000008 //SYSIN DD *
000009 $$FILEM DBP,
000010 $$FILEM FORMAT=TABLE|SINGLE,
000011 $$FILEM OBJIN=location.owner.name,
000012 $$FILEM OBJILOCN=location,
000013 $$FILEM OBJIOWNR=owner,
000014 $$FILEM OBJIOWNR=name,
000015 $$FILEM TINPUT=ddname,
000016 $$FILEM TINMEM=member,
000017 $$FILEM TMIN=template_data_set_name(member),
000018 $$FILEM UCREAD=YES|NO,
:

```

You now have a JCL member that can be used to print a Db2 table using the FM/Db2 DBP function.

Chapter 15. Interfacing with Db2® Interactive

To interface to Db2® Interactive (Db2I), use the Db2I utility function (option 5).

To display the Db2I Primary Option Menu panel, from the Primary Option Menu panel select option 5 (Db2I).

For further information about Db2I, see the *Db2® Application Programming and SQL Guide*.

Related references

[Primary Option Menu panel on page 728](#)

[Db2I Primary Option Menu panel on page 618](#)

Part II. FM/Db2 reference

Chapter 16. Db2® data types

FM/Db2 supports the following IBM-supplied data types:

Character strings (alphanumeric)

A sequence of bytes where the length of the string is the number of bytes in the sequence.

CHAR

Fixed-length character string.

VARCHAR

Varying-length character string.

GRAPHIC

Fixed-length graphic string.

VARGRAPHIC

Varying-length graphic string.

BINARY

Fixed-length binary string.

VARBINARY

Varying-length binary string.

Numeric

Decimal, binary integer, and floating point data types containing a sign and a precision.

DECIMAL or NUMERIC

A packed decimal number with an implied decimal point.

DECFLOAT

A decimal floating-point number.

SMALLINT

A binary integer with a precision of 15 bits.

INTEGER

A binary integer with a precision of 31 bits.

BIGINT

A binary integer with a precision of 63 bits.

REAL

A single precision floating-point number (32 bits).

DOUBLE, DOUBLE PRECISION, or FLOAT

A double precision floating-point number (64 bits).

Row identifier

Supports queries that navigate directly to a row in the table.

ROWID

A unique value maintained permanently by Db2®.

Datetime

These data types represent a point in time.

DATE

Internally to Db2®, the date is represented as a 4 byte field, with each byte containing 2 packed decimal digits stored in the format *yyyymmdd*.

Externally, as returned by an SQL SELECT statement, the date is represented by a character field. The format of the string is dependant on the DATE parameter in the Db2® DSNHDECP installation module (the Db2® installation option specified on the installation panel DSNTIP4). [Table 25: Date and Time field formats on page 434](#) shows valid Db2® date formats. The length of the date field is 10 bytes, except where the Db2® Installation Date format is LOCAL, in which case the length is installation-dependent and in the range 10 to 254 bytes. The date value must be in the range 0001-01-01 to 9999-12-31 (ISO format).

TIME

Internally to Db2® the timestamp is represented as a 7-15 byte field. with each byte containing 2 packed decimal digits. The first 4 bytes represent the date, the next 3 bytes the time, the next 0-6 bytes the microseconds, and when a TIME ZONE is present, 2 bytes containing the time zone.

Externally, as returned by an SQL select statement, the timestamp is represented by a 19-38 byte character field. The timestamp is always returned in the format *yyyy-mm-dd.hh.mm.ss(.nnnnnnnnnnn)(sHH:MM)* where:

yyyy

An integer in the range 1 to 9999 representing the years.

mm

An integer in the range 1 to 12 representing the months.

dd

An integer in the range 1 to 31 representing the days. The value must be appropriate for the month, including leap years.

hh

An integer in the range 0 to 24 representing the hours.

mm

An integer in the range 0 to 59 representing the minutes.

ss

An integer in the range 0 to 59 representing the seconds.

The remaining parts of the **TIMESTAMP** (fractional part of the seconds value and **TIME ZONE**) are optional:

nnnnnnnnnnnnnn

An integer in the range 0 to 99999999999 representing the fractional part of the seconds. The number of digits can vary from 0-12 inclusive, depending on the precision of the **TIMESTAMP**.

sHH

A signed integer in the range -12 to +14 inclusive. -12 represents 12 hours behind Greenwich mean time, +14 represents 14 hours ahead.

MM

An integer in the range 00-59, representing the minutes component of the time zone. Internally to Db2®, the time is represented as a 3 byte field with each byte containing 2 packed decimal digits stored in the format *hhmmss*.

Table 25. Date and Time field formats

Format Name	Abbreviation	Date format	Time format
International Standard Organization	ISO	yyyy-mm-dd	hh.mm.ss
IBM® USA standard	USA	mm/dd/yyyy	hh.mm AM or PM
IBM® European standard	EUR	dd.mm.yyyy	hh.mm.ss
Japanese industrial standard	JIS	yyyy-mm-dd	hh:mm:ss
Installation defined	LOCAL	Installation-defined format	Installation-defined format

For a full description of Db2® data types, see the *Db2 UDB for z/OS SQL Reference*.

Large objects (LOBs)

The term *large object (LOB)* refers to any of the following data types:

CLOB

Character large object

DBCLOB

Double-byte character large object

BLOB

Binary large object

FM/Db2 recognizes columns with a LOB data type but these columns do not participate in FM/Db2 functions. If displayed, the name of the LOB column is shown but the column is displayed as empty.

Chapter 17. FM/Db2 panels and fields

This section of the manual lists most of the FM/Db2 panels. For several of the panels, there is a definition for each field in the panel and, where applicable, the value ranges that are valid for each entry field.

Scrollable fields on FM/Db2 panels

Some fields on FM/Db2 panels are scrollable to allow you to input or view longer values.

The panels shown in this section were produced using Db2® Version 8. In these panels, some fields have adjacent “+” and “-” signs. These signs show that the fields are scrollable.

For further information, see [Scrollable input and display fields for long names on page 39](#).

Action bar pull-down menu

The Action bar pull-down menus give you a fast way to move around the product. The panel shown here shows an example of a pull-down menu for the action bar item, **Options**.

Panel and field definitions

Process	Options	Utilities	Help
FM/Db2 (Command	1. Print settings		
0 Setti	2. FM/Db2 system options		
1 View	3. Job card specifications		
2 Edit	4. Compiler language selection		: JHELVON
3 Utili	5. COBOL compiler specifications		: FMD2
4 SQL	6. HLASM compiler specifications		: FMN2
5 Db2I	7. PL/I compiler specifications		: 15.1.6
6 Comma	8. Temporary Data Set Allocations		: 3278
7 Templ	9. Output Data Set Allocations		: 1
X Exit	10. Trace options		: 2018/11/04
	11. ISPF settings		: 14:27
	12. Editor options		
	13. Print utility options		. DFE2
	14. Copy utility options		. JHELVON +
	15. Object list utility options		
	16. Import utility options		
	17. Export utility options		
	18. Db2 LOAD utility options		
	19. Db2 Utility LISTDEF options		
	20. Db2 Utility OPTIONS options		
	21. Db2 Utility TEMPLATE options		
	22. Db2 Unload utility options		
Command F1=Help F9=Swap	F10=Left	F11=Right	F12=Cancel
			F8=Forward

Process

The Process menu offers the following choice:

1

Exit

Options



Note: The Options menu is not available for the Set Processing Options panel ([Set Processing Options panel on page 795](#)).

The Options menu offers the following choice:

- 1
Print settings
- 2
FM/Db2 system options
- 3
Job card specifications
- 4
Compiler language selection
- 5
COBOL compiler specifications
- 6
HLASM compiler specifications
- 7
PL/I compiler specifications
- 8
Temporary Data Set Allocations
- 9
Output Data Set Allocations
- 10
Trace options
- 11
ISPF settings
- 12
Editor options
- 13
Print utility options
- 14
Copy utility options

15

Object list utility options

16

Import utility options

17

Export utility options

18

Db2® LOAD utility options

19

Db2® Utility LISTDEF options

20

Db2® Utility OPTIONS options

21

Db2® Utility TEMPLATE options

22

Db2® Unload utility options

Utilities



Note: The Utilities menu is not available for the Set Processing Options panel ([Set Processing Options panel on page 795](#)).

The Utilities menu offers the following choice:

1

Print

2

Objects

3

Copy

4

Object List

5

Db2® Privileges

6

Import

7

Export

8

Create

9

Db2® Utilities

10

Audit Trail

11

Print Browse

Help

The Help menu offers the following choice:

1

Help for help...

2

Extended help...

3

Keys help...

4

Help index A-M

5

Help index N-Z

6

Tutorial...

7

About...

8

About Db2®...

9

News about FM/Db2...

Parent panels

Pull-down menus are available from all FM/Db2 panels.

Child panels

None.

Related tasks

- [Checking your FM/Db2 version on page 28](#)
- [Exiting from FM/Db2 on page 29](#)
- [Selecting an item from the action bar on page 38](#)

Additional LISTDEF Statements panel

You use the Additional LISTDEF Statements panel to provide additional LISTDEF statements, which are used to supplement the LISTDEF statement provided in the LISTDEF Options panel.

Panel and field definitions

<u>P</u> rocess	<u>O</u> ptions	<u>U</u> tilities	<u>H</u> elp
FM/Db2 (DFG2)	Additional LISTDEF Statements		Global Settings
No corresponding statement is generated if its field is blank.			
LISTDEF	_____		

LISTDEF	_____		

LISTDEF	_____		

Command ==>			
F1=Help	F2=Split	F3=Exit	F4=CRetriev
F8=Forward	F9=Swap	F10=Actions	F12=Cancel
			F6=Reset
			F7=Backward

LISTDEF

The text that you enter here is included in a LISTDEF statement, if the Use additional statements option on the LISTDEF Options panel ([LISTDEF Options panel on page 702](#)) is selected.

Parent panels

- [LISTDEF Options panel on page 702](#)

Child panels

None.

Related tasks

- [RESET primary command on page 932](#)
- [Setting options for Db2 utilities on page 341](#)

Additional TEMPLATE Statements panel

You use the Additional TEMPLATE Statements panel to provide additional TEMPLATE statements, which are used to supplement the TEMPLATE statement provided in the TEMPLATE Options (1 of 2) panel.

Panel and field definitions

<u>P</u> rocess	<u>O</u> ptions	<u>U</u> tilities	<u>H</u> elp
FM/Db2 (DFG2)	Additional TEMPLATE Statements		Global Settings
No corresponding statement is generated if its field is blank.			
TEMPLATE	_____		

TEMPLATE	_____		

TEMPLATE	_____		

Command ==>> _____			
F1=Help	F2=Split	F3=Exit	F4=CRetriev
F8=Forward	F9=Swap	F10=Actions	F12=Cancel
			F6=Reset
			F7=Backward

TEMPLATE

The text that you enter here is included in a TEMPLATE statement, if the Use additional statements option on the TEMPLATE Options (1 of 2) panel ([TEMPLATE Options \(1 of 2\) panel on page 846](#)) is selected.

Parent panels

- [TEMPLATE Options \(1 of 2\) panel on page 846](#)

Child panels

None.

Related tasks

- [RESET primary command on page 932](#)
- [Setting options for Db2 utilities on page 341](#)

Advanced SELECT Prototyping panel

The advanced select prototyping function is an aid to learning the syntax of the SQL SELECT statement, and a tool for prototyping complex SQL statements. Fragments of the statement syntax are displayed on the screen in a form based on the "railroad tracks" used to describe the syntax in the Db2® manuals. By positioning the cursor on the parts of the syntax you wish to explore or use, you can build up a statement that conforms to the syntax requirements. The statement you create is displayed at the bottom of the screen, and can be executed when you have completed it.

Panel and field definitions

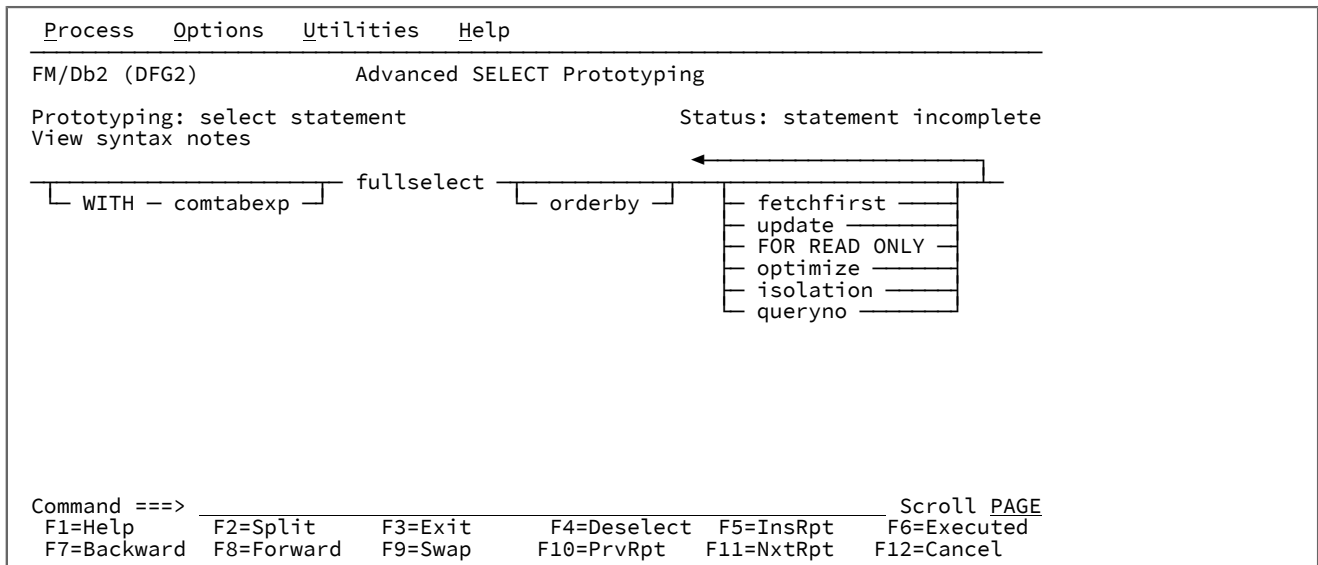

Prototyping

Shows the name of the syntax fragment currently displayed.

Status

The current status of the SQL statement you are building. The status indicator, in the form of a text string, applies either to the whole SQL statement (in which case, it uses the word "statement"), or to the clause within the SQL statement that you are currently prototyping (in which case, it uses the word "clause"):

statement incomplete

Only is displayed on the first Advanced SELECT Prototyping panel, and indicates that the statement generated so far is not ready for execution.

clause incomplete

Can be displayed on any panel except the first, and indicates that the clause currently being prototyped is not ready for execution (and by implication, the statement as a whole is not yet ready for execution).

clause complete

Can be displayed on any panel except the first, and indicates that the clause currently being prototyped is now complete. This indirectly implies (because otherwise the status would appear as *“statement complete”*) that the statement as a whole is not yet ready for execution.

statement complete

Can be displayed on any panel, and indicates that the statement as a whole is now complete and ready for execution (and implies that the current clause is also complete).



Note: Advanced SELECT prototyping is designed to help you build a SELECT statement until it is displayed to be complete. However, the *“completed”* status of a SELECT clause or statement does not necessarily mean that it is syntactically correct or references valid Db2® data. Only the successful execution of the SELECT statement confirms that its syntax is correct.

View syntax notes

Explanatory notes relating to the current syntax fragment, available on some of the advanced SELECT prototyping panels. Such panels show the text *“View syntax notes”* immediately below the *“Prototyping:”* field heading.

To view the notes, move the cursor to the *“View syntax notes”* text and press Enter. FM/Db2 displays a panel containing notes relevant to the current syntax fragment.

Parent panels

- [SQL Prototyping, Execution and Analysis panel on page 806](#)

Child panels

To display this panel...	Use/do this
Select Statement Browse panel on page 782	Press Enter

Related tasks

- [Using advanced SQL prototyping on page 391](#)
- [Generated SELECT statement color-coding on page 393](#)

Related references

- [CANCEL primary command on page 873](#)
- [DESELECT primary command on page 884](#)
- [EXECUTE primary command on page 893](#)
- [INSRPT primary command on page 912](#)
- [NEXTRPT primary command on page 924](#)
- [PREVRPT primary command on page 928](#)
- [SQL primary command on page 942](#)

Alter Database panel

Panel and field definitions

Process	Options	Utilities	Help
FM/Db2 (DFG2)			Alter Database
Database name . . .	<u>FMN2</u>		
Buffer pool	<u> </u>		(Optional: BPn, BP8Kn, BP16Kn, BP32Kn)
Index buffer pool .	<u>BP0</u>		(Optional: BPn)
Storage group . . .	<u>SG01</u>		+ (Optional, storage group name)
Command ==>			
F1=Help	F2=Split	F3=Exit	F4=Expand
F9=Swap	F10=Left	F11=Right	F12=Cancel
			F7=Backward F8=Forward

Parent panels

- [Databases panel on page 593](#)

Child panels

None.

Related tasks

Alter External Scalar Function panel

Panel and field definitions

Process	Options	Utilities	Help
FM/Db2 (DFG2)	Alter External Scalar Function		
ALTER SPECIFIC FUNCTION "SYATES"."FUNCTIO1"			
All parameters are optional			
External name . . .	<u>F</u> UNCTIO1	+	(default is the function name)
Language	<u>C</u> OBOL		Deterministic . <u>N</u> (Y/N)
NOT NULL Call . . .		(Y/N)	External action <u>Y</u> (Y/N)
Final call	<u>N</u>	(Y/N)	DBINFO <u>N</u> (Y/N)
SQL	<u>R</u>	(C - Contain	R - Read M - Mod N - No)
Scratch pad	<u>0</u>	(scratch pad	length or 0)
ALLOW PARALLEL	<u>D</u>		(Y/N)
Collid		+	(collection or '-' for none)
WLM Environment . . .	<u>WLM_FOR_DFA2</u>	+	(WLM env. name or '-' for none)
ASUTIME limit	<u>0</u>		(CPU service units or 0 for no limit)
Stay resident	<u>N</u>	(Y/N)	
Program type	<u>S</u>	(M - Main S - Subroutine)	
External security . .	<u>D</u>	(D - Db2 AS U - User C - Definer)	
Run time options . .			+
Command ==>			
F1=Help	F2=Split	F3=Exit	F4=Expand
F9=Swap	F10=Left	F11=Right	F12=Cancel
			F7=Backward F8=Forward

Parent panels

- [Functions panel on page 684](#)

Child panels

None.

Related tasks

Alter Index panel

Panel and field definitions

<u>P</u> rocess	<u>O</u> ptions	<u>U</u> tilities	<u>H</u> elp
FM/Db2 (DFG2)			Alter Index
Index owner	FMUSER		+
Index name	XDEPT1		+
Partition	_____		
Primary quantity .	_____	Buffer pool	BP0
Secondary quantity	_____	Erase rule	NO
Free page	_____	Close rule	NO
Percent free	_____		
Storage group . . .	_____		+
VSAM catalog . . .	_____	Piece size(KB) . . .	2097152
GB pool cache . . .	_____	Copy allowed	NO
Limit value	_____		+
Use the SHOW primary command to display index partition values, and the SAVE line command to copy the values to this panel.			
Command ==> _____			
F1=Help	F2=Split	F3=Exit	F4=Expand
F9=Swap	F10=Left	F11=Right	F12=Cancel
			F7=Backward F8=Forward

Parent panels

- [Indexes panel on page 697](#)

Child panels

None.

Related tasks

Alter Stored Procedure panel

Panel and field definitions

<u>P</u> rocess	<u>O</u> ptions	<u>U</u> tilities	<u>H</u> elp
FM/Db2 (DFG2)		Alter Stored Procedure	
ALTER SPECIFIC FUNCTION "SYATES"."FUNCTIO1"			
All parameters are optional			
RESULT SETS	@_____	(maximum number of result sets)	
EXTERNAL NAME	<u>DSNX9DUJ</u> +	(default is the function name)	
LANGUAGE	<u>C</u> _____ +	DETERMINISTIC . <u>N</u> (Y/N)	
PARM STYLE	<u>D</u> _____	(D - DB2SQL G - General N - w. NULLS)	
SQL	<u>M</u> _____	(C - Contain R - Read M - Mod N - No)	
DBINFO	<u>N</u> _____	(Y/N)	
COLLID	<u>DSNJAR</u> _____	+ (collection or '-' for none)	
WLM ENV	<u>WLM_FOR_DFA2</u> _____	+ (WLM env. name or '-' for none)	
ASUTIME LIMIT	<u>0</u> _____	(CPU service units or 0 for no limit)	
STAY RESIDENT	<u>Y</u> _____	(Y/N)	
PROGRAM TYPE	<u>S</u> _____	(M - Main S - Subroutine)	
EXT SECURITY	<u>U</u> _____	(D - Db2 AS U - User C - Definer)	
COMMIT RETURN	<u>N</u> _____	(Y/N)	
RUN TIME OPTS	<u>POSIX(ON)</u> _____	+	
Command ==>> _____			
F1=Help	F2=Split	F3=Exit	F4=Expand
F9=Swap	F10=Left	F11=Right	F12=Cancel
			F7=Backward F8=Forward

Parent panels

- [Stored Procedures panel on page 813](#)

Child panels

None.

Related tasks

Alter Table panel

Panel and field definitions

<u>P</u> rocess	<u>O</u> ptions	<u>U</u> tilities	<u>H</u> elp
FM/Db2 (DFG2)		Alter Table	
Table Identification:			
Table owner	KPS8810_LONG		+
Table name	VACT		+
Processing Options:			
Select type of ALTER			
— 1. AUDIT		7. DROP FOREIGN KEY constraint	
2. ADD column		8. DATA CAPTURE	
3. VALIDPROC		9. ADD CHECK constraint	
4. ADD PRIMARY KEY		10. DROP CHECK constraint	
5. ADD FOREIGN KEY constraint		11. ADD RESTRICT ON DROP	
6. DROP PRIMARY KEY		12. DROP RESTRICT ON DROP	
Command ==>			
F1=Help	F2=Split	F3=Exit	F4=Expand
F9=Swap	F10=Left	F11=Right	F12=Cancel
			F7=Backward F8=Forward

Parent panels

- [Tables, Views and Aliases panel on page 843](#)
- [Table Check Constraints panel on page 826](#)

Child panels

To display this panel...	Use/do this
Alter Table - AUDIT panel on page 453	Processing option 1
Alter Table - ADD Column panel on page 450	Processing option 2
Alter Table - VALIDPROC panel on page 459	Processing option 3
Alter Table - ADD PRIMARY KEY panel on page 452	Processing option 4
Alter Table - ADD FOREIGN KEY Constraint panel on page 451	Processing option 5
Alter Table - DROP PRIMARY KEY panel on page 457	Processing option 6
Alter Table - DROP FOREIGN KEY Constraint panel on page 456	Processing option 7
Alter Table - DATA CAPTURE panel on page 454	Processing option 8
Alter Table - ADD CHECK Constraint panel on page 449	Processing option 9
Alter Table - DROP CHECK Constraint panel on page 455	Processing option 10
Alter Table - RESTRICT ON DROP panel on page 458	Processing option 11 or 12

Related tasks**Alter Table - ADD CHECK Constraint panel****Panel and field definitions**

<u>P</u> rocess	<u>O</u> ptions	<u>U</u> tilities	<u>H</u> elp
FM/Db2 (DFG2) Alter Table - ADD CHECK Constraint			
Table Identification:			
Owner	KPS8810_LONG		+
Name	VACT		+
Constraint:			
Name	_____		+
Check condition	_____		+
Command ==>			
F1=Help	F2=Split	F3=Exit	F4=Expand
F9=Swap	F10=Left	F11=Right	F12=Cancel
			F7=Backward F8=Forward

Parent panels

- [Alter Table panel on page 448](#)

Child panels

None.

Related tasks

Alter Table - ADD Column panel

Panel and field definitions

<u>P</u> rocess	<u>O</u> ptions	<u>U</u> tilities	<u>H</u> elp
FM/Db2 (DFG2)	Alter Table - ADD Column		
Table Identification:			
Owner	KPS8810_LONG	+	
Name	VACT	+	
Column Details:			
Name	_____ + (for example CHAR, DECIMAL, INTEGER)		
Type	_____ + (for example CHAR, DECIMAL, INTEGER)		
Length	_____ (optional, valid for FLOAT and DECIMAL only)		
Precision	_____ (optional, valid for DECIMAL only)		
Scale	_____ (optional, valid for DECIMAL only)		
NOT NULL	_ (Yes or No)		
FOR ? DATA	_ (type: B - BIT, S - SBCS, D - DBCS, blank - none)		
WITH DEFAULT	_ (Yes, No or enter value below)		
Default value	_____ +		
FIELDPROC Details:			
Name	_____ (optional)		
Parm	_____ +		
Command ==>			
F1=Help	F2=Split	F3=Exit	F4=Expand
F9=Swap	F10=Left	F11=Right	F12=Cancel

Parent panels

- [Alter Table panel on page 448](#)

Child panels

None.

Related tasks

Alter Table - ADD FOREIGN KEY Constraint panel

Panel and field definitions

<u>P</u> rocess	<u>O</u> ptions	<u>U</u> tilities	<u>H</u> elp		
FM/Db2 (DFG2)	Alter Table - ADD FOREIGN KEY Constraint				
Table Identification:					
Owner	KPS8810_LONG		+		
Name	VACT		+		
Constraint:					
Name	VACT		+		
Foreign Key:					
Column name 1	_____				
2	_____				
3	_____				
4	_____				
5	_____				
6	_____				
7	_____				
8	_____				
REFERENCES Table Identification:					
Owner	SYSTEM				
Name	_____				
ON DELETE:					
Select type of delete rule					
_ 1. RESTRICT					
2. CASCADE					
3. SET NULL					
4. NO ACTION					
Command ==>					
F1=Help	F2=Split	F3=Exit	F4=Expand	F7=Backward	F8=Forward
F9=Swap	F10=Left	F11=Right	F12=Cancel		

Parent panels

- [Alter Table panel on page 448](#)

Child panels

None.

Related tasks

Alter Table - ADD PRIMARY KEY panel

Panel and field definitions

<u>P</u> rocess	<u>O</u> ptions	<u>U</u> tilities	<u>H</u> elp		
FM/Db2 (DFG2)	Alter Table - ADD PRIMARY KEY				
Table Identification:					
Owner	KPS8810_LONG		+		
Name	VACT		+		
Primary Key:					
Column name 1	_____				
2	_____				
3	_____				
4	_____				
5	_____				
6	_____				
7	_____				
8	_____				
Command ==>					
F1=Help	F2=Split	F3=Exit	F4=Expand	F7=Backward	F8=Forward
F9=Swap	F10=Left	F11=Right	F12=Cancel		

Parent panels

- [Alter Table panel on page 448](#)

Child panels

None.

Related tasks

Alter Table - AUDIT panel

Panel and field definitions

```

  Process  Options  Utilities  Help
  -----
FM/Db2 (DFG2)                Alter Table - AUDIT

Table Identification:
  Owner . . . . . KPS8810_LONG  +
  Name . . . . . VACT           +

Auditing Attribute:
  Select type of AUDIT
  - 1. NONE
    2. CHANGES
    3. ALL

Command ==>
  F1=Help   F2=Split   F3=Exit   F4=Expand   F7=Backward  F8=Forward
  F9=Swap   F10=Left   F11=Right  F12=Cancel

```

Parent panels

- [Alter Table panel on page 448](#)

Child panels

None.

Related tasks

Alter Table - DATA CAPTURE panel

Panel and field definitions

<u>P</u> rocess	<u>O</u> ptions	<u>U</u> tilities	<u>H</u> elp		
FM/Db2 (DFG2)		Alter Table - DATA CAPTURE			
Table Identification:					
Owner	KPS8810 LONG	+		
Name	VACT	+		
Additional Logging Attribute:					
Select type of DATA CAPTURE					
-	1.	NONE			
-	2.	CHANGES			
Command ==>					
F1=Help	F2=Split	F3=Exit	F4=Expand	F7=Backward	F8=Forward
F9=Swap	F10=Left	F11=Right	F12=Cancel		

Parent panels

- [Alter Table panel on page 448](#)

Child panels

None.

Related tasks

Alter Table - DROP CHECK Constraint panel

Panel and field definitions

<u>P</u> rocess	<u>O</u> ptions	<u>U</u> tilities	<u>H</u> elp
FM/Db2 (DFG2)		Alter Table - DROP CHECK Constraint	
Table Identification:			
Owner	KPS8810_LONG		+
Name	VACT		+
CHECK Constraint:			
Name			+
Command ==>			
F1=Help	F2=Split	F3=Exit	F4=Expand
F9=Swap	F10=Left	F11=Right	F12=Cancel
		F7=Backward	F8=Forward

Parent panels

- [Alter Table panel on page 448](#)
- [Table Check Constraints panel on page 826](#)

Child panels

None.

Related tasks

Alter Table - DROP FOREIGN KEY Constraint panel

Panel and field definitions

<u>P</u> rocess	<u>O</u> ptions	<u>U</u> tilities	<u>H</u> elp		
FM/Db2 (DFG2)	Alter Table - DROP FOREIGN KEY Constraint				
Table Identification:					
Owner	KPS8810_LONG		+		
Name	VACT		+		
FOREIGN KEY Constraint:					
Name			+		
Command ==>					
F1=Help	F2=Split	F3=Exit	F4=Expand	F7=Backward	F8=Forward
F9=Swap	F10=Left	F11=Right	F12=Cancel		

Parent panels

- [Alter Table panel on page 448](#)

Child panels

None.

Related tasks**Alter Table - DROP PRIMARY KEY panel****Panel and field definitions**

<u>P</u> rocess	<u>O</u> ptions	<u>U</u> tilities	<u>H</u> elp		
FM/Db2 (DFG2)	Alter Table - DROP PRIMARY KEY				
Table Identification:					
Owner	KPS8810_LONG		+		
Name	VACT		+		
DROP PRIMARY KEY					
Press ENTER to confirm.					
Command ==>					
F1=Help	F2=Split	F3=Exit	F4=Expand	F7=Backward	F8=Forward
F9=Swap	F10=Left	F11=Right	F12=Cancel		

Parent panels

- [Alter Table panel on page 448](#)

Child panels

None.

Related tasks

Alter Table - RESTRICT ON DROP panel

Panel and field definitions

```
Process  Options  Utilities  Help
-----
FM/Db2 (DFG2)          Alter Table - RESTRICT ON DROP

Table Identification:
  Owner . . . . . KPS8810_LONG  +
  Name  . . . . . VACT          +

ADD RESTRICT ON DROP

Press ENTER to confirm.

Command ==>
F1=Help      F2=Split    F3=Exit     F4=Expand   F7=Backward F8=Forward
F9=Swap      F10=Left   F11=Right   F12=Cancel
```

Parent panels

- [Alter Table panel on page 448](#)

Child panels

None.

Related tasks**Alter Table - VALIDPROC panel****Panel and field definitions**

<u>P</u> rocess	<u>O</u> ptions	<u>U</u> tilities	<u>H</u> elp
FM/Db2 (DFG2)	Alter Table - VALIDPROC		
Table Identification:			
Owner	KPS8810_LONG		+
Name	VACT		+
Validation Procedure:			
Select type of VALIDPROC			
- 1. NULL			
- 2. Program name . . . _____			
Command ==>			
F1=Help	F2=Split	F3=Exit	F4=Expand
F9=Swap	F10=Left	F11=Right	F12=Cancel
			F7=Backward F8=Forward

Parent panels

- [Alter Table panel on page 448](#)

Child panels

None.

Related tasks

Alter Table Space panel

Panel and field definitions

<u>P</u> rocess	<u>O</u> ptions	<u>U</u> tilities	<u>H</u> elp
FM/Db2 (DFG2)		Alter Table Space	
Database name . . .	<u>FMN2</u>		
Table space name . .	<u>SYSCOPY</u>		
Partition	_____		
Primary quantity . .	_____	Buffer pool	<u>BP0</u>
Secondary quantity .	_____	Close rule	<u>NO</u>
Free page	_____	Erase rule	<u>NO</u>
Percent free	_____	Lock size	<u>ANY</u>
Storage group	_____ +	Lock max	_____
VSAM catalog	_____	Lock part	_____
Compress	_____	Max rows	<u>255</u>
GBP Cache	_____	Log	_____
Track mods	_____		
Use the SHOW primary command to display table space partition values, and the SAVE line command to copy the values to this panel.			
Command ==>			
F1=Help	F2=Split	F3=Exit	F4=Expand
F9=Swap	F10=Left	F11=Right	F12=Cancel
		F7=Backward	F8=Forward

Parent panels

- [Table Spaces panel on page 834](#)

Child panels

None.

Related tasks

Application Packages panel

You use the Application Packages panel to list packages in the Db2® catalog.

Panel and field definitions

The columns that are displayed include the SEL field and columns of SYSIBM.SYSPACKAGE.

Process		Options		Utilities		Help	
FM/Db2 (DFG2)				Application Packages			
Location:				Format <u>TABL</u>			
SEL	COLLID	NAME	CONTOKEX	OWNER			
----	*-----1-----2-----	*-----1--	*-----1-----+	*-----			
****	Top of data	****					
----	DSNACCOR	DSNACCOR	177E87BE0FB21F55	CJUNELL			
----	DSNAOCLI	DSNCLIC1	177B36231891080D	CJUNELL			
----	DSNAOCLI	DSNCLIC2	177310CF0292F222	CJUNELL			
----	DSNAOCLI	DSNCLICS	177310CF02BC61C8	CJUNELL			
----	DSNAOCLI	DSNCLIF4	177310CF0240AD09	CJUNELL			
----	DSNAOCLI	DSNCLINC	177310D1041D2C84	CJUNELL			
----	DSNAOCLI	DSNCLIQR	177310D20B53A754	CJUNELL			
----	DSNAOCLI	DSNCLIRR	177310D40AF15976	CJUNELL			
----	DSNAOCLI	DSNCLIRS	177310D5100739C0	CJUNELL			
----	DSNAOCLI	DSNCLIUR	177310D817B309F9	CJUNELL			
----	DSNASPCC	DSNACOL8	177E85D60B2B32CD	CJUNELL			
Command ==>				Scroll <u>PAGE</u>			
F1=Help	F2=Zoom	F3=Exit	F4=CRetriev	F5=RFind	F6=RChange		
F7=Up	F8=Down	F9=Swap	F10=Left	F11=Right	F12=Cancel		

**Note:**

1. The system option, **Show all catalog table columns**, affects which columns FM/Db2 displays when you use the Object List utility.
2. You can also customize which columns FM/Db2 displays when you use the Object List utility. For details, see the *File Manager Customization Guide*.

To view other columns on this panel, press the Right function key (F11).

For a complete list of columns, refer to “*Db2® catalog tables*” in the *DB2 for z/OS SQL Reference* relevant to your version of Db2®.

SEL

Line command area.

For a list of the line commands you can use on this panel, see [Table 22: Object list line commands on page 308](#).

Parent panels

- [Object List Utility panel on page 719](#)
- [Tables, Views and Aliases panel on page 843](#)
- [Indexes panel on page 697](#)
- [Application Plans panel on page 463](#)
- [Collections panel on page 471](#)
- [Stored Procedures panel on page 813](#)
- [Triggers panel on page 853](#)

- [Plan Table Rows panel on page 725](#)
- [Statement Table Rows panel on page 808](#)

Child panels

To display this panel...	Use/do this
Bind Package panel on page 471	Line command BI or CBI
Package Dependencies panel on page 724	Line command DEP
Free Package panel on page 683	Line command FRE
Grant privileges panels on page 689	Line command G
Details panels on page 618	Line command I
Plan Table Rows panel on page 725	Line command LPT
Privileges panels on page 736	Line command P
Package List panel on page 724	Line command PKL
Application Plans panel on page 463	Line command PL
Revoke privileges panels on page 766	Line command R
Rebind Package panel on page 740	Line command RBI
Display Row panel on page 619	Line command ROW
Table Spaces panel on page 834	Line command S
(ISPF panel)	Line command SQL
Tables, Views and Aliases panel on page 843	Line command TB
Tables, Views and Aliases panel on page 843	Line command V
Application Packages panel on page 460	Line command VER
Indexes panel on page 697	Line command X
Sort Fields panel on page 804	Primary command SORT

Related tasks

- [Working with object list panels on page 301](#)
- [Using the line command area \(Cmd\) on page 308](#)

Related references

- [SORT primary command on page 941](#)

Application Plans panel

You use the Application Plans panel to list application plans in the Db2® catalog.

Panel and field definitions

The columns that are displayed include the SEL field and columns of SYSIBM.SYSPLAN.

Process	Options	Utilities	Help			
FM/Db2 (DFG2)		Application Plans				Format <u>TABL</u>
Location:						
SEL	NAME	CREATOR	VALIDAEX	ISOLATEX	VALIDEX	OPERATEX
----	*#1-----	*#2-----	*#44-----	*#45-----	*#46-----	*#47-----
****	Top of data					****
----	DSNACLI	CJUNELL	Run time	Repeatable read	Yes	Yes
----	DSNEDCL	CJUNELL	Run time	Cursor stability	Yes	Yes
----	DSNESPCS	CJUNELL	Run time	Cursor stability	Yes	Yes
----	DSNESPRR	CJUNELL	Run time	Repeatable read	Yes	Yes
----	DSNHYCRD	CJUNELL	Run time	Cursor stability	Yes	Yes
----	DSNREXX	CJUNELL	Run time	Cursor stability	Yes	Yes
----	DSNTEP81	CJUNELL	Run time	Cursor stability	Yes	Yes
----	DSNTIA81	CJUNELL	Run time	Cursor stability	Yes	Yes
----	DSNTP481	CJUNELL	Run time	Cursor stability	Yes	Yes
----	DSNWZP	CJUNELL	Run time	Cursor stability	Yes	Yes
----	FMN2GEN	SHRIKES	Bind time	Cursor stability	Yes	Yes
Command ==>						Scroll <u>PAGE</u>
F1=Help	F2=Zoom	F3=Exit	F4=CRetriev	F5=RFind	F6=RChange	
F7=Up	F8=Down	F9=Swap	F10=Left	F11=Right	F12=Cancel	



Note:

1. The system option, **Show all catalog table columns**, affects which columns FM/Db2 displays when you use the Object List utility.
2. You can also customize which columns FM/Db2 displays when you use the Object List utility. For details, see the *File Manager Customization Guide*.

To view other columns on this panel, press the Right function key (F11).

For a complete list of columns, refer to “Db2® catalog tables” in the *DB2 for z/OS SQL Reference* relevant to your version of Db2®.

SEL

Line command area.

For a list of the line commands you can use on this panel, see [Table 22: Object list line commands on page 308](#).

Parent panels

- [Object List Utility panel on page 719](#)
- [Application Packages panel on page 460](#)
- [Collections panel on page 471](#)
- [Database Request Modules panel on page 591](#)

Child panels

To display this panel...	Use/do this
Bind Application Plan panel on page 470	Line command BI
Free Application Plan panel on page 683	Line command FRE
Grant privileges panels on page 689	Line command G
Details panels on page 618	Line command I
Plan Table Rows panel on page 725	Line command LPT
Database Request Modules panel on page 591	Line command M
Privileges panels on page 736	Line command P
Application Packages panel on page 460	Line command PKG
Package List panel on page 724	Line command PKL
Revoke privileges panels on page 766	Line command R
Rebind Application Plan panel on page 738	Line command RBI
Display Row panel on page 619	Line command ROW
Table Spaces panel on page 834	Line command S
(ISPF panel)	Line command SQL
Tables, Views and Aliases panel on page 843	Line command T
Tables, Views and Aliases panel on page 843	Line command V
Indexes panel on page 697	Line command X
Sort Fields panel on page 804	Primary command SORT

Related tasks

- [Working with object list panels on page 301](#)
- [Using the line command area \(Cmd\) on page 308](#)

Related references

- [SORT primary command on page 941](#)

Basic SELECT Prototyping panel

You use the Basic SELECT Prototyping (primary) panel to specify up to 15 tables to be used to construct a FROM clause as the starting point for prototyping a SELECT statement.

Panel and field definitions

Process	Options	Utilities	Help
FM/Db2 (DFG2)			Basic SELECT Prototyping
Enter the name(s) of the table(s) from which to retrieve data:			
	Owner	Name	
#1	DSN8810	+ EMP	+ Location _____
#2	DSN8810	+ EEMP	+ Database _____
#3	_____	+ _____	+ Tbl spc. _____
#4	_____	+ _____	+ _____
#5	_____	+ _____	+ _____
#6	_____	+ _____	+ _____
#7	_____	+ _____	+ _____
#8	_____	+ _____	+ _____
#9	_____	+ _____	+ _____
#10	_____	+ _____	+ _____
#11	_____	+ _____	+ _____
#12	_____	+ _____	+ _____
#13	_____	+ _____	+ _____
#14	_____	+ _____	+ _____
#15	_____	+ _____	+ _____
Command ==>			
F1=Help	F2=Split	F3=Exit	F4=Expand
F9=Swap	F10=Left	F11=Right	F12=Cancel
			F7=Backward F8=Forward

Owner

This field is optional. If specified, it is used to qualify the name field on the same line. If omitted, the current SQL ID is used.

Name

This field is required. It specifies the name of the table to be processed.

Location

This field is optional. If specified, it is used to qualify all the tables entered in the **Owner** and **Name** fields. If omitted, the current location is be used.

Database

This field is optional. If specified, all the tables entered in the **Owner** and **Name** fields must exist in the given database. If omitted, the tables can exist in any database at the specified or defaulted location.

Table space

This field is optional. If specified, all the tables entered in the **Owner** and **Name** fields must exist in the given table space. If omitted, the tables can exist in any table space at the specified or defaulted location, subject to any restriction imposed by the database specification.

After you have specified the table names on the primary Basic SELECT Prototyping panel, press Enter to display the secondary Basic SELECT Prototyping panel.

Process	Options	Utilities	Help
FM/Db2 (DFG2)		Basic SELECT Prototyping	Row 1 of 19
SELECT ? FROM ? WHERE ? ORDER BY ?			
Row count <u>ALL</u> Number of rows to display			
Select columns (S/A/D) or enter predicates to build the SELECT statement:			
S	LOp (Tab Column Name	Data Type(length) Op Value)
-	----	#1 EMPNO	CHAR(6) -----
-	----	#1 FIRSTNME	VARCHAR(12) -----
-	----	#1 MIDINIT	CHAR(1) -----
-	----	#1 LASTNAME	VARCHAR(15) -----
-	----	#1 WORKDEPT	CHAR(3) -----
-	----	#1 PHONENO	CHAR(4) -----
-	----	#1 HIREDATE	DATE(4) -----
-	----	#1 JOB	CHAR(8) -----
-	----	#1 EDLEVEL	SMALLINT(2) -----
-	----	#1 SEX	CHAR(1) -----
-	----	#1 BIRTHDATE	DATE(4) -----
-	----	#1 SALARY	DECIMAL(9,2) -----
-	----	#1 BONUS	DECIMAL(9,2) -----
-	----	#1 COMM	DECIMAL(9,2) -----
-	----	#2 DEPTNO	CHAR(3) -----
-	----	#2 DEPTNAME	VARCHAR(36) -----
-	----	#2 MGRNO	CHAR(6) -----
-	----	#2 ADMRDEPT	CHAR(3) -----
-	----	#2 LOCATION	CHAR(16) -----
**** End of data ****			
Command ==>			
F1=Help	F2=Split	F3=Exit	F4=Expand
F8=Forward	F9=Swap	F10=Left	F11=Right
			Scroll PAGE
			F7=Backward
			F12=Cancel

Row count

Enter a number in this field to control:

- The number of rows returned in the result set when the SQL statement is executed. Specifying 0 results in all qualifying rows being returned. Specifying *n* (when *n*>0) limits the number of rows returned to the lesser of: *n* rows, or the number of rows in the result table.
- Whether or not an "OPTIMIZE FOR *n* ROWS" clause is added to the SQL statement prior to execution. Specifying *n* (when *n*>0) results in the addition of "OPTIMIZE FOR *n* ROWS" to the SQL statement prior to execution. Specifying a 0 value does not add "OPTIMIZE FOR *n* ROWS" to the SQL statement. Specifying a non-zero value may improve Db2's use of resources when executing the SQL statement.

S

A selection column in which you can specify one of the following values for the column on that line:

S

Select. Adds the column name to the column list in the SELECT clause.

A

Select ascending. Adds the column name to the column list in the SELECT clause, and adds the column name with the keyword `ASC` to the column list in the ORDER BY clause.

D

Select descending. Adds the column name to the column list in the SELECT clause, and adds the column name with the keyword `DESC` to the column list in the ORDER BY clause.

LOp

Logical operator to join a new predicate to previous predicates. You can specify one of the following values for the column on that line:

- AND (the default operator)
- OR
- NOT (equivalent to "and not")
- NOR (equivalent to "or not")

(

Inserts an opening parenthesis at the start of the predicate added to the WHERE clause. Use an opening parenthesis in conjunction with a closing parenthesis to ensure the predicate for this column is evaluated before other (non-parenthesized) predicates.

Tab

The correlation name of the table containing the column on this line. This is an information-only field.

Column Name

The name of the column as held in the Db2® catalog. This is an information-only field.

Data Type(length)

The Db2® data type of the column and its length, or numeric precision and scale. This is an information-only field.

Op

Expression operator. You can specify one of the following values for the column on that line:

=

Equal. This is the default operator.

<>

Not equal.

>

Greater than.

<

Less than.

>=

Greater than or equal to.

<=

Less than or equal to.

IN

In *set*. If the value in the column is in the specified set of values (specified in **Value** field), the result of the expression is true. The IN expression operator generates the predicate IN *set* in the WHERE clause.

NI

Not in *set*. If the value in the column is not in the specified set of values (specified in **Value** field), the result of the expression is true. The NI expression operator generates the predicate NOT IN *set* in the WHERE clause.

LI

Like *pattern*. If the value in the column matches the pattern (specified in **Value** field), the result of the expression is true. The LI expression operator generates the predicate LIKE *pattern* in the WHERE clause.

NL

Not like *pattern*. If the value in the column does not match the pattern (specified in **Value** field), the result of the expression is true. The NL expression operator generates the predicate NOT LIKE *pattern* in the WHERE clause.

Value

The value to be used with the expression operator (specified in the **Op** field).

The format of the data you enter depends on the expression operator:

- For expression operators =, <>, >, <, >=, and <=:
 - For columns with an alphanumeric data type, specify a character string, optionally enclosed in quotation marks. If you do not enclose the string in quotation marks, FM/Db2 automatically adds the quotation marks around the string when it adds the generated predicate to the WHEN clause.

Examples:

```
SMITH  
'SMITH'  
SALES REP  
'SALES REP'
```

- For columns with a numeric data type, specify a numeric value.

Examples:

```
500
33.75
0
```

- You can also specify a column name as a value. The column name must be qualified with its correlation name.

Examples:

```
#1.WORKDEPT
#2.BONUS
```



Note: To enter a string that begins with a “#”, you must enclose the string in quotation marks.

- For expression operators IN and NI:
 - For columns with an alphanumeric data type, specify a list of character strings. Each character string *must* be enclosed in quotation marks and separated by a comma.

Examples:

```
'SMITH', 'JONES', 'BROWN'
'ANALYST', 'DESIGNER', 'OPERATOR', 'MANAGER'
```

- For columns with a numeric data type, specify a list of numeric values. Each value must be separated by a comma and, optionally, one or more spaces.

Examples:

```
101,102,103
45.5, 50.0, 65.5
```

- You can also specify a list of column names. Each column name must be qualified with its correlation name and be separated by a comma. Examples:

```
#1.ACCT, #1PROD, #2MAINT
#1.BONUS, #2.BONUS
```

- For the expression operator LI:
 - Specify a pattern (as a character string), optionally enclosed in quotation marks.



Note: You can only specify a pattern for columns with an alphanumeric data type.

If you do not enclose the pattern in quotation marks, FM/Db2 automatically adds the quotation marks around the pattern when it adds the generated predicate to the WHEN clause.

The pattern can contain an underscore (_) to represent any single character, or a percent sign (%) to represent a string of zero or more characters.

All of the following examples find the string “SMITH”:

```
'SMITH'
SMI
'SM%'
SMI
```

- Specify a column name as a value. The column name must be qualified with its correlation name.

Examples:

```
#1 . SEX
#1 . WORKDEPT
```

)

Inserts a closing parenthesis at the end of the predicate added to the WHERE clause. Use in conjunction with an opening parenthesis to ensure the predicate for this column is evaluated before other (non-parenthesized) predicates.

Parent panels

- [Tables, Views and Aliases panel on page 843](#)
- [SQL Prototyping, Execution and Analysis panel on page 806](#)

Child panels

To display this panel...	Use/do this
Select Statement Browse panel on page 782	Press Enter

Related tasks

- [Using basic SQL prototyping on page 382](#)

Related references

- [ALL primary command on page 870](#)
- [CANCEL primary command on page 873](#)
- [EXECUTE primary command on page 893](#)
- [RESET primary command on page 932](#)
- [SQL primary command on page 942](#)
- [UNDO primary command on page 945](#)

Bind Application Plan panel

FM/Db2 displays the Bind Application Plan panel if you use the BI line command against an item listed on the [Application Plans panel on page 463](#).

Bind Package panel

FM/Db2 displays the Bind Package panel if you use either the BI or CBI line command against an item listed on the [Application Packages panel on page 460](#).

Children of Table panel

FM/Db2 displays the Children of Table panel if you use the CHR line command against an item listed on the [Tables, Views and Aliases panel on page 843](#).

Collections panel

You use the Collections panel list to list collections in the Db2® catalog.

Panel and field definitions

The columns that are displayed include the SEL field and columns of SYSIBM.SYSPACKAGES.

<u>P</u> rocess	<u>O</u> ptions	<u>U</u> tilities	<u>H</u> elp
FM/Db2 (DFG2)		Collections	
Location:		Format <u>TABL</u>	
SEL	COLLID	PKG COUNT	
----	*-----1-----	-----*	
----	#2---#4	-----#4	
****	Top of data	****	
----	DSNACCOR	1	
----	DSNAOCLI	9	
----	DSNASPCC	12	
----	DSNEDCL	1	
----	DSNESPCC	1	
----	DSNESPCC	1	
----	DSNESPCC	1	
----	DSNESPCC	1	
----	DSNHYCRD	1	
----	DSNJAR	8	
----	DSNREXCS	1	
----	DSNREXRR	1	
Command ==>>		Scroll <u>PAGE</u>	
F1=Help	F2=Zoom	F3=Exit	F4=CRetriev
F7=Up	F8=Down	F9=Swap	F10=Left
			F11=Right
			F6=RChange
			F12=Cancel



Note:



1. The system option, **Show all catalog table columns**, affects which columns FM/Db2 displays when you use the Object List utility.
2. You can also customize which columns FM/Db2 displays when you use the Object List utility. For details, see the *File Manager Customization Guide*.

To view other columns on this panel, press the Right function key (F11).

For a complete list of columns, refer to “Db2® catalog tables” in the *DB2 for z/OS SQL Reference* relevant to your version of Db2®.

SEL

Line command area.

For a list of the line commands you can use on this panel, see [Table 22: Object list line commands on page 308](#).

Parent panels

- [Object List Utility panel on page 719](#)

Child panels

To display this panel...	Use/do this
Grant privileges panels on page 689	Line command G
Privileges panels on page 736	Line command P
Application Packages panel on page 460	Line command PKG
Package List panel on page 724	Line command PKL
Application Plans panel on page 463	Line command PL
Revoke privileges panels on page 766	Line command R
Display Row panel on page 619	Line command ROW
(ISPF panel)	Line command SQL
Sort Fields panel on page 804	Primary command SORT

Related tasks

- [Working with object list panels on page 301](#)
- [Using the line command area \(Cmd\) on page 308](#)

Related references

- [SORT primary command on page 941](#)

Column Attributes panel (alphanumeric)

The Column Attributes (alphanumeric) panel describes the formatting and data create attributes for an alphanumeric column.

Panel and field definitions

```

Process  Options  Utilities  Help
-----
FM/Db2 (DFG2)                Column Attributes

Fixed Attributes:
  Column name  LASTNAME
  Type        VARCHAR(15)

Use Attributes:
  Heading     _____
  Output width _____

Create Attributes:
  Filler      _____
  Action      _____
  Start character _____
  Pattern     _____
  Repeat user pattern _____ YES or NO

Scrambling Options:
Scramble Type  Enter "/" to select option
- 1. Random    - Value      Column In _____ Out _____
  2. Repeatable Dsn _____
  3. Translate
  4. Exit      Col Command
  5. ODPP      |_____ +
Command ==>
F1=Help      F2=Split    F3=Exit     F4=CRetrie v F7=Backward F8=Forward
F9=Swap      F10=Actions F12=Cancel

```

Column name

The name of the column.

Type

The Db2® data type of the column.

Heading

The alternative column heading.

Output width

The number of character positions used by view, edit, browse, and print functions to show the column in TABL display or print format.

Filler

The value placed in each byte of the column before any other operation in the construction of the column. The default value is a blank character.

char

This character, such as 0, is written in each byte.

X'cc'

This hexadecimal value, such as X'FF', is written in each byte.

Action

This column sets how the contents of the column are varied for each row. The default action is FX.

FX

Contents of the column remain *fixed*.

RA

Contents of the column are generated from characters selected at *random* from the specified pattern. A different set of characters is selected for each row.

RO

Contents of the column *rolled*. The specified pattern is shifted left one byte for each row until the first nonblank character of the pattern is in the first byte of the column. Then the pattern is shifted right one byte for each output row until it returns to its original position in the column. RO can only be used with a user-supplied pattern, not with an IBM®-supplied pattern (see following description for **Pattern**).

RP

Contents of the column are *rippled*. The specified pattern is shifted left one byte for each row and the truncated character is appended to the right end of the pattern.

SL

Contents of the column are *shifted left* for each row. The specified pattern is shifted left one character and filled to the right with a space. When all characters in the pattern have been shifted out, the original pattern is restored and the process is repeated.

SR

Contents of the column are *shifted right* for each row. The specified pattern is shifted right one character and filled to the left with a space. When all characters in the pattern have been shifted out, the original pattern is restored and the process is repeated.

TL

Contents of the column are *truncated on the left* for each row. The specified pattern is left-truncated (the leftmost character replaced with a space) one character at a time until all characters in the pattern have been truncated. Then the original pattern is restored and the process is repeated.

TR

Contents of the column are *truncated* on the *right* for each row. The specified pattern is right-truncated (the rightmost character replaced with a space) one character at a time until all characters in the pattern have been truncated. Then the original pattern is restored and the process is repeated.

WV

Contents of the column are *waved*. The specified pattern is shifted left one byte for each row until the first nonblank character of the pattern is in the first byte of the column. Then the original pattern is restored and the process repeated. WV can only be used with a user-supplied pattern, not with an IBM®-supplied pattern (see following description for **Pattern**).

Start character

Starting character used when you specify an IBM®-supplied pattern (AL, AN, or CO). The specified character must be one of the characters in the IBM®-supplied pattern. The default start character is the first character in the IBM®-supplied pattern.

Pattern

The pattern used when generating data for this column. You can specify either an IBM®-supplied pattern indicator or a quoted string containing a user-supplied pattern. The IBM®-supplied patterns you can specify are:

AL

Alphabetic. Characters A–Z inclusive.

AN

Alphanumeric. Characters A–Z, 0–9, inclusive.

CO

Collating sequence. All printable characters in the range X'40'–X'F9'.

If you provide a user-supplied pattern that is longer than the column, for actions other than RA and RP, the pattern is first truncated on the right to fit the receiving column before the specified action is performed. For the RA action, characters are randomly selected from the entire user-supplied pattern. For the RP action, the entire pattern is rippled for each row before it is truncated to fit the receiving column.

If you provide a user-supplied pattern that is shorter than the column, you can specify that you want the pattern repeated to fill the column.

Repeat user pattern

Specify YES if you have provided a user-supplied pattern that is shorter than the receiving column. This option has no effect when the RA action is specified. The default value is NO.

NO

Fill character used to pad the receiving column.

YES

Supplied pattern repeated as many times as necessary to fill the receiving column.



Note: IBM®-supplied patterns are always repeated in a column, as necessary.

Scrambling Options

These options control column scrambling used during copy, import, or export functions to produce test data.

Scramble Type

Specify one of the following values:

Blank

No scrambling is performed. Value or range specifications are saved but ignored for the associated function.

1 (Random)

Performs random scrambling. The same input value produces different output values on subsequent invocations.

2 (Repeatable)

Performs repeatable scrambling. The same input value produces the same output value on subsequent invocations.

3 (Translate)

Performs translation. The value data set is searched to find a matching input value. If a match is found, then the output value is taken from the output column of the matching record.

4 (Exit)

Invokes a scrambling user exit. FM/Db2 displays a panel where you can specify the user exit name and user exit parameters and options.

5 (ODPP)

Performs data scrambling using the ODPP command specified in the adjacent command field. This is the Optim™ Data Privacy Provider **Command** input area. The **Col** field is the left column position, which can be used to position to the error column when a syntax error occurs. Refer to the ODPP Syntax Guide for the command syntax.

The ODPP command is a scrollable field. Use the F10 and F11 keys to scroll left and right. Use the F4 key to expand the command into a separate window. This option is only available if File Manager has been customized to access ODPP, and the environment has been successfully initialised. For more information, see the *File Manager for z/OS® Customization Guide*.

Parent panels

- [Column Selection/Edit panel on page 485](#)

Child panels

None.

Related tasks

- [Editing the template on page 240](#)
- [Changing column attributes on page 101](#)
- [Changing the attributes for an alphanumeric column on page 102](#)

Column Attributes panel (DATE)

The Column Attributes (DATE) panel describes the formatting and data create attributes for a DATE column.

Panel and field definitions

<u>P</u> rocess	<u>O</u> ptions	<u>U</u> tilities	<u>H</u> elp
FM/Db2 (DFG2)		Column Attributes	
Fixed Attributes:			
Column name	BIRTHDATE		
Type	DATE		
Format	dd.mm.yyyy		
Use Attributes:			
Heading	_____		
Output width	_____		
Create Attributes:			
Date value	_____		
	(Use = for date now, * for runtime date)		
Increment	0 _____		
Command ==> _____			
F1=Help	F2=Split	F3=Exit	F4=CRetriev
F9=Swap	F10=Actions	F12=Cancel	F7=Backward F8=Forward

Column name

The name of the column.

Type

The Db2® data type of the column.

Format

The format in which the date is displayed or printed.

Heading

The alternative column heading.

Output width

The number of character positions used by view, edit, and print functions to show the column in TABL display or print format.

Date value

The initial value a column is to contain. Valid values are:

start date

A date in a valid Db2® or local format.

*** (asterisk)**

The date the data is created. Not valid if the Db2® installation date format is LOCAL.

=

The current date. Not valid if the Db2® installation date format is LOCAL.

Increment

A integer that represents the number of days to add to the date each cycle.

The default increment value is 0.

Parent panels

- [Column Selection/Edit panel on page 485](#)

Child panels

None.

Related tasks

- [Editing the template on page 240](#)
- [Changing column attributes on page 101](#)
- [Table 25: Date and Time field formats on page 434](#)

Column Attributes panel (numeric)

The Column Attributes (numeric) panel describes the formatting and data create attributes for a numeric column.

Panel and field definitions

Process	Options	Utilities	Help
FM/Db2 (DFG2)		Column Attributes	
Fixed Attributes:			
Column name		SALARY	
Type		DECIMAL(9,2)	
Use Attributes:			
Heading		_____	
Output width		_____	
Leading zeros		<u>NO</u>	YES or NO
Create Attributes:			
Start value		_____	
End value		_____	
Increment		_____	
Cycle		_____	
Scrambling Options:			
Scramble Type		Enter "/" to select option	
1. Random		Value	Column In _____ Out _____
2. Repeatable Dsn		_____	
3. Translate		_____	
4. Exit	Col	Command	
5. ODPP	<u>1</u>	_____ +	
Command ==>			
F1=Help	F2=Split	F3=Exit	F4=CRetriev F7=Backward F8=Forward
F9=Swap	F10=Actions	F12=Cancel	

Column name

The name of the column.

Type

The Db2® data type of the column.

Heading

The alternative column heading.

Output width

The number of character positions used by view, edit, and print functions to show the column in TABL display or print format.

Leading zeros

Specifies whether leading zeros are to be shown when this field is displayed or printed in SNGL or TABL display or print format. Specify YES if you want leading zeros shown. Specify NO if you want leading zeros replaced with blanks.

Start value

The initial value a column is to contain, before being adjusted by the specified increment. The value must be a number that the column can hold without truncation or loss of data. The value is converted to the appropriate numeric data type if required. For a column containing decimal places, the value specified cannot contain more decimal places than specified by the column definition. If you specify a negative number, the sign is honored, even if the column is unsigned. If the column is a floating-point column, the start value can be specified as a floating-point number consisting of a mantissa and an exponent (such as -1.14579E01). The mantissa consists

of an optional sign (+ or -) followed by 1 to 16 digits. The mantissa can also contain a decimal point. The exponent consists of the letter E, an optional sign (+ or 0), and 1 or 2 digits.

The default start value is 0.

End value

The maximum value (if the increment is a positive number) or minimum value (if the increment is a negative number) a column is to contain. The value must be a number that the column can hold without truncation or loss of data. The value is converted to the appropriate numeric data type if required. For a column containing decimal places, the value specified cannot contain more decimal places than specified by the column definition. If you specify a negative number, the sign is honored, even if the column is unsigned. If the column is a floating-point column, the end value can be specified as a floating-point number consisting of a mantissa and an exponent (such as -1.14579E01). The mantissa consists of an optional sign (+ or -) followed by 1 to 16 digits. The mantissa can also contain a decimal point. The exponent consists of the letter E, an optional sign (+ or 0), and 1 or 2 digits.

The default end value is the largest positive or negative number the column can contain.

Increment

The positive or negative number by which the value in the column is adjusted for each row (or cycle of rows). The increment value must be a number that the column can hold without truncation or loss of data. The increment value is converted to the appropriate numeric data type if required. For a column containing decimal places, the value specified cannot contain more decimal places than specified by the column definition. If the column is a floating-point column, the increment can be specified as a floating-point number consisting of a mantissa and an exponent (such as -1.14579E01). The mantissa consists of an optional sign (+ or -) followed by 1 to 16 digits. The mantissa can also contain a decimal point. The exponent consists of the letter E, an optional sign (+ or 0), and 1 or 2 digits.

For the first row (or cycle of rows), the column is set to the start value you specify. For each subsequent row (or cycle of rows), the increment is added to the value in the column. This process continues while the calculated value in the column does not exceed the specified end value. That is, while the calculated value is less than or equal to the end value if the increment is a positive number, or greater than or equal to the end value if the increment is a negative number. When the end value is exceeded, the value in the column remains unchanged for all subsequent rows.

If the increment value is zero, the value in the column is always set to the start value.

The default increment is 0.

Cycle

The number of output rows that are generated before the increment value is applied to the column value. For example, if you specify a column start value of 100, an increment value of 10, and a cycle value of 3, the column in the first 3 rows contains 100, 110 in next 3 rows, 120 in the next 3 rows, and so on.

If cycle is zero, the value in the column is always set to the start value.

The default cycle is 1.

Scrambling Options

These options control column scrambling used during copy, import, or export functions to produce test data.

Scramble Type

Specify one of the following values:

Blank

No scrambling is performed. Value or range specifications are saved but ignored for the associated function.

1 (Random)

Performs random scrambling. The same input value produces different output values on subsequent invocations.

2 (Repeatable)

Performs repeatable scrambling. The same input value produces the same output value on subsequent invocations.

3 (Translate)

Performs translation. The value data set is searched to find a matching input value. If a match is found, then the output value is taken from the output column of the matching record.

4 (Exit)

Invokes a scrambling user exit. FM/Db2 displays a panel where you can specify the user exit name and user exit parameters and options.

5 (ODPP)

Performs data scrambling using the ODPP command specified in the adjacent command field. This is the Optim™ Data Privacy Provider **Command** input area. The **Col** field is the left column position, which can be used to position to the error column when a syntax error occurs. Refer to the ODPP Syntax Guide for the command syntax.

The ODPP command is a scrollable field. Use the F10 and F11 keys to scroll left and right. Use the F4 key to expand the command into a separate window. This option is only available if File Manager has been customized to access ODPP, and the environment has been successfully initialised. For more information, see the *File Manager Customization Guide*.



Note: For numeric columns, setting **Leading zeros** to YES causes leading zeros to be scrambled when random or repeatable scrambling (**Value** option blank) has been requested.



For example:

- With **Leading zeros** set to YES, 00123 may produce 56872 (zeros changed).
- With **Leading zeros** set to NO, 00123 may produce 00343 (zeros unchanged).

For repeatable scrambling, setting **Leading zeros** to YES guarantees a unique result.

Parent panels

- [Column Selection/Edit panel on page 485](#)

Child panels

None.

Related tasks

- [Editing the template on page 240](#)
- [Changing column attributes on page 101](#)
- [Changing the attributes for a numeric column on page 103](#)

Column Attributes panel (TIME)

The Column Attributes (TIME) panel describes the formatting and data create attributes for a TIME column.

Panel and field definitions

<u>P</u> rocess	<u>O</u> ptions	<u>U</u> tilities	<u>H</u> elp
FM/Db2 (DFG2)	Column Attributes		
Fixed Attributes:			
Column name	COL9_TIME		
Type	TIME		
Format	hh.mm AM or PM		
Use Attributes:			
Heading	_____		
Output width	_____		
Create Attributes:			
Time value	_____		
(Use = for time now, * for runtime time)			
Command ==>			
F1=Help	F2=Split	F3=Exit	F4=CRetriev F7=Backward F8=Forward
F9=Swap	F10=Actions	F12=Cancel	

Column name

The name of the column.

Type

The Db2® data type of the column.

Format

The format in which the time is displayed or printed.

Heading

The alternative column heading.

Output width

The number of character positions used by view, edit, and print functions to show the column in TABL display or print format.

Time value

The initial value a column is to contain. Valid values are:

start time

A time in a valid Db2® or local format.

*** (asterisk)**

The time the data is created. Not valid if the Db2® installation time format is LOCAL.

=

The current time. Not valid if the Db2® installation time format is LOCAL.

Parent panels

- [Column Selection/Edit panel on page 485](#)

Child panels

None.

Related tasks

- [Editing the template on page 240](#)
- [Changing column attributes on page 101](#)
- [Table 25: Date and Time field formats on page 434](#)

Column Attributes panel (TIMESTAMP)

The Column Attributes (TIMESTAMP) panel describes the formatting and data create attributes for a TIMESTAMP column.

Panel and field definitions

Process	Options	Utilities	Help
FM/Db2 (DFG2)			Column Attributes
Fixed Attributes:			
Column name	TSTAMP		
Type	TIMESTAMP (3) WITH TIME ZONE		
Format	CCYY-MM-DD-HH.MM.SS.NNNsHH:MM		
Use Attributes:			
Heading	_____		
Output width	_____		
Create Attributes:			
Timestamp value	_____		
	(Use = for timestamp now, * for runtime timestamp)		
Command ==>			
F1=Help	F2=Split	F3=Exit	F4=CRetrieV F7=Backward F8=Forward
F9=Swap	F10=Actions	F12=Cancel	

The example shows a column defined as `TIMESTAMP(3) WITH TIME ZONE`. The Type value and the Format are different for columns with different `TIMESTAMP` data types.

Column name

The name of the column.

Type

The Db2® data type of the column.

Format

The format in which the timestamp is displayed or printed.

Heading

The alternative column heading.

Output width

The number of character positions used by view, edit, and print functions to show the column in TABL display or print format.

Timestamp value

The initial value a column is to contain. Valid values are:

start timestamp

A timestamp in the Db2® timestamp format.

*** (asterisk)**

The date and time the data is created.

=

The current date and time.

Parent panels

- [Column Selection/Edit panel on page 485](#)

Child panels

None.

Related tasks

- [Editing the template on page 240](#)
- [Changing column attributes on page 101](#)

Related references

- [Db2 data types on page 432](#)

Column Distribution panel

FM/Db2 displays the Column Distribution panel if you use the CDI line command against an item listed on the [Tables, Views and Aliases panel on page 843](#).

Column Part Statistics panel

FM/Db2 displays the Column Part Statistics panel if you use the PST line command against an item listed on the [Columns panel on page 491](#).

Column Selection/Edit panel

You use the Column Selection/Edit panel to edit a template.

Panel and field definitions

Process		Options		Utilities		Help			
FM/Db2 (DFG2)		Column Selection/Edit				Line 1 of 16			
TABLE FMUSER.EMP									
----- Row Selection Criteria ---- (Use SQL/PF4 for full screen edit) -----									
1 Sel: _____ +									
Cmd	Seq	SHEX	CL#	Column name	Data type(length)	Null	Default	Order	A/D
				**** Top of data ****					
---	---	S	1	EMPNO	CHARACTER(6)		None	---	---
---	---	S	2	FIRSTNME	VARCHAR(12)		None	---	---
---	---	S	3	MIDINIT	CHARACTER(1)		None	---	---
---	---	S	4	LASTNAME	VARCHAR(15)		None	---	---
---	---	S	5	WORKDEPT	CHARACTER(3)	Y	Null	---	---
---	---	S	6	PHONENO	CHARACTER(4)	Y	Null	---	---
---	---	S	7	HIREDATE	DATE	Y	Null	---	---
---	---	S	8	JOB	CHARACTER(8)	Y	Null	---	---
---	---	S	9	EDLEVEL	SMALLINT	Y	Null	---	---
---	---	S	10	SEX	CHARACTER(1)	Y	Null	---	---
---	---	S	11	BIRTHDATE	DATE	Y	Null	---	---
---	---	S	12	SALARY	DECIMAL(9,2)	Y	Null	---	---
Command		==>						Scroll PAGE	
F1=Help		F2=Split		F3=Exit		F4=SQL		F5=RFind	
F7=Up		F8=Down		F9=Swap		F10=Left		F11=Right	
								F6=RunTemp	
								F12=Cancel	

Object type and name

The object type (TABLE or VIEW) and the name of the Db2® object being processed.

Row Selection Criteria

Field where you can enter a freeform SQL WHERE clause or expression that limits the rows selected from Db2®.

If the template already contains row selection criteria, FM/Db2 shows the corresponding WHERE clause in this field.

Cmd

Prefix command area for entering template editor prefix commands:

S, SS, Sn, S*

Selecting (or deselecting) columns.

H, HH, Hn

Holding (or freeing) columns.

E

Changing the attributes of a column.

X

Displaying data for character columns in LHEX. The data for Binary and Varbinary columns is displayed in LHEX by default.

Seq

The display sequence number of the column (in a File Manager/Db2 editor session) indicating either of these:

- The sequence number you have entered to change the sequence of the displayed columns.
- The sequence number generated by FM/Db2 as a result of a hold template editor prefix command (H, HH, or Hn) being entered in the **Cmd** prefix entry area.

S

Column selection indicator. An asterisk (*) shows that the column is selected. Only selected columns appear in a File Manager/Db2 editor session.

H

Column hold indicator. An “H” shows that the column is held.

In TABL mode, held columns appear as the leftmost columns in a File Manager/Db2 editor session and are unaffected by scrolling left or right. In SNGL mode, held columns appear as the topmost columns in an editor session and are unaffected by scrolling up or down.

E

Data edit indicator. An “E” shows that the column has been previously edited to add information such as data create, column headings, or scrambling options.

X

LHEX indicator. An “X” shows that the data for the column is displayed in LHEX (Long Hexadecimal) format.

Cl#

The column number as defined in the Db2® catalog. The column number reflects the Db2® column number unless either of the following are true:

- The column is a generated column
- The column is not a column of the first table named in the SELECT statement used to create the result table

If either of these conditions is true, the column has a number greater than the maximum Db2® column number, for all specified columns in the first Db2® object named in the SELECT statement.

Column name

The name of the column.

Data type(length)

The Db2® data type (and optionally the length) of the column.

Null

Shows whether the column is defined as nullable.

Y

Nullable column

(blank)

Db2® null values are not permitted

Default

Default value information for the column:

Always

Either a ROWID or identity column defined with the **generated always** attribute.

Default

Either a ROWID or identity column defined with the **generated by default** attribute.

None

There is no default value for the column.

Null

The default value is the Db2® null value.

On type

The column has a default value that depends on the data type of the column:

Data type

Default value

Numeric

0

Fixed-length character data types

Blanks

Varying-length data types

String of length 0

DATE

Current date

TIME

Current time

TIMESTAMP

Current date and time

On value

The column has a default value that is defined in the DEFAULTVALUE column of the SYSIBM.SYSCOLUMNS catalog table.

SQLID

The default value is the value of the SQL authorization ID of the process at the time the default value is used.

USER

The default value is the value of the USER special register at the time the default value is used.

Order

An optional sequence number indicating how to order the data, based on the data values for the column, when the data is retrieved from Db2®.

A/D

Sort sequence indicator. You can only specify this if an order sequence number (**Order**) is also specified.

A

Ascending

D

Descending

Parent panels

- [Db2 View panel on page 613](#)
- [Db2 Edit panel on page 598](#)
- [Print Utility panel on page 733](#)
- [Copy Utility \("From"\) panel on page 498](#)
- [Export Utility \("From"\) panel on page 673](#)
- [Data Create Utility panel on page 587](#)

Child panels

To display this panel...	Use/do this
Table View panel on page 837	If parent panel is Db2® View and you press F3
Db2 View panel on page 613	If parent panel is Db2® View and you press F12
Table Edit panel on page 826	If parent panel is Db2® Edit and you press F3
Db2 Edit panel on page 598	If parent panel is Db2® Edit and you press F12
Table Browse panel on page 824	If parent panel is Db2® Browse and you press F3

To display this panel...	Use/do this
Db2 Browse panel on page 595	If parent panel is Db2® Browse and you press F12
Template Save panel on page 852	Press F3
Db2 Template Description panel on page 608	Primary command DESCRIBE
Export Utility ("To") panel on page 676	If parent panel is Export Utility and you press F3
Column Attributes panel (alphanumeric) on page 473	Line command E for an alphanumeric column
Column Attributes panel (numeric) on page 478	Line command E for a numeric column
Column Attributes panel (DATE) on page 477	Line command E for a DATE column
Column Attributes panel (TIME) on page 482	Line command E for a TIME column
Column Attributes panel (TIMESTAMP) on page 483	Line command E for a TIMESTAMP column
Row Selection Criteria panel on page 767	Enter 1 on the command line

Related tasks

- [Locating a column on page 139](#)
- [Restricting the data that FM/Db2 loads from Db2 on page 134](#)
- [Large numeric fields on page 165](#)
- [Copying data from one Db2 object to another on page 241](#)
- [Copying data from a VSAM or QSAM file on page 246](#)
- [Copying data to a VSAM or QSAM file on page 274](#)
- [Editing the template on page 240](#)
- [Running Print in batch on page 324](#)
- [Editing a template on page 81](#)
- [Using the SQL Edit session on page 92](#)
- [Manipulating columns on page 95](#)
- [Selecting columns on page 96](#)
- [Holding columns on the display when scrolling on page 97](#)
- [Changing the sequence of displayed or printed columns on page 98](#)
- [Changing the sequence of displayed or printed rows on page 100](#)
- [Changing the column heading on page 102](#)
- [Changing column attributes on page 101](#)

Related references

- [Db2 data types on page 432](#)
- [TEDIT primary command on page 943](#)

Columns panel

You use the Columns panel to list column object types in the Db2® catalog.

Panel and field definitions

The columns that are displayed include the SEL field and columns of SYSIBM.SYSCOLUMNS.

Process Options Utilities Help						
FM/Db2 (DFG2)		Columns			Format <u>TABL</u>	
SEL	NAME	TBCREATOR	TBNAME	COLNO	COLTYPE	LENGTH
*	*	*	*	*	*	*
----	#1-----1-----	#3-----	#2-----1-----	-----#4	#5-----	-----#6
****	Top of data	****				
_____	MAJSYS	CARLAND	PMR91932	1	CHAR	1
_____	ACTION	CARLAND	PMR91932	2	CHAR	1
_____	OBJFLD	CARLAND	PMR91932	3	CHAR	2
_____	SRCHCRIT	CARLAND	PMR91932	4	CHAR	2
_____	SCRTYPE	CARLAND	PMR91932	5	CHAR	1
_____	HEADTXT	CARLAND	PMR91932	6	CHAR	50
_____	SELTXT	CARLAND	PMR91932	7	CHAR	50
_____	INFOTXT	CARLAND	PMR91932	8	CHAR	79
_____	HELPTXT	CARLAND	PMR91932	9	CHAR	79
_____	PFKTX1	CARLAND	PMR91932	10	CHAR	79
_____	PFKTX2	CARLAND	PMR91932	11	CHAR	79
Command ==>				Scroll PAGE		
F1=Help	F2=Zoom	F3=Exit	F4=CRetriev	F5=RFind	F6=RChange	
F7=Up	F8=Down	F9=Swap	F10=Left	F11=Right	F12=Cancel	



Note:

1. The system option, **Show all catalog table columns**, affects which columns FM/Db2 displays when you use the Object List utility.
2. You can also customize which columns FM/Db2 displays when you use the Object List utility. For details, see the *File Manager Customization Guide*.

To view other columns on this panel, press the Right function key (F11).

For a complete list of columns, refer to “*Db2® catalog tables*” in the *DB2 for z/OS SQL Reference* relevant to your version of Db2®.

SEL

Line command area.

For a list of the line commands you can use on this panel, see [Table 22: Object list line commands on page 308](#).

Parent panels

- [Object List Utility panel on page 719](#)
- [Constraint Columns for panel on page 495](#)
- [Columns in Table panel on page 493](#)
- [Privileges panels on page 736](#)

Child panels

To display this panel...	Use/do this
Tables, Views and Aliases panel on page 843	Line command AT
See COMMENT panels on page 493	Line command COM
Column Distribution panel on page 485	Line command DI
Distinct Types panel on page 619	Line command DT
Grant privileges panels on page 689	Line command G
Columns panel on page 491	Line command H
Details panels on page 618	Line command I
Label Column panel on page 701	Line command LAB
Privileges panels on page 736	Line command P
Display Row panel on page 619	Line command ROW
Tables, Views and Aliases panel on page 843	Line command T
Indexes panel on page 697	Line command X
Sort Fields panel on page 804	Line command SORT

Related tasks

- [Working with object list panels on page 301](#)
- [Using the line command area \(Cmd\) on page 308](#)

Related references

- [SORT primary command on page 941](#)

Columns in Index panel

FM/Db2 displays the Columns in Index panel if you use the COL line command against an item listed on the [Indexes panel on page 697](#).

Columns in Table panel

FM/Db2 displays the Columns in Table panel if you use the COL line command against an item listed on:

- The [Tables, Views and Aliases panel on page 843](#), or
- The [Table Check Constraint Dependencies panel on page 826](#)

Comment panels

These panels are:

- Comment Column panel
- Comment Distinct Type panel
- Comment Procedure panel
- Comment Specific Function panel
- Comment Table panel
- Comment Trigger panel

FM/Db2 displays one of these panels when you specify the COM line command against an object displayed in a list of Db2® objects.

Compiler Language Selection panel

You use the Compiler Language Selection panel to set the language to be used for compiling the current source member to create a template. The default language is COBOL. This option is saved in your ISPF profile and persists from one FM/Db2 session to the next.

Panel and field definitions

<u>P</u> rocess	<u>O</u> ptions	<u>U</u> tilities	<u>H</u> elp
FM/Db2 (DFG2)		Compiler Language Selection	
Language Selection:			
Specify Default Compiler			
<u>1</u>	1. COBOL	Use the COBOL compiler	
	2. PL/I	Use the PL/I compiler	
	3. Auto detect	Determine which compiler to use	
	4. HLASM	Use the HLASM compiler	
Processing Options:			
Enter "/" to select option			
<u>0</u>	Override compiler options for template update		
<u>1</u>	Preserve copybook library		
<u>-</u>	Show copybook name with record type field name		
Command ==>			
F1=Help	F2=Split	F3=Exit	F7=Backward F8=Forward F9=Swap
F12=Cancel			

Language Selection

The following language can be specified for the compilation of the source member to create a template:

1. COBOL

Use the COBOL compiler. This is the default setting.

2. PL/I

Use the PL/I compiler.

3. Auto detect

Perform a heuristic analysis of the source and use the appropriate compiler.

4. HLASM

Use the HLASM compiler.

Processing Options

Override compiler options for template update

When selected, overrides the compiler options found in the template being updated with the current compiler options.

Foreground processing always overrides the compiler options for older templates that do not contain compiler options.

You should select this option for batch template update of older templates to generate compiler options in the JCL.

Preserve copybook library

Ensures that, if a copybook still exists in the library that it was previously found in and that library is in the list that the update is using, then that version of the copybook is used.

If you do not select this option, or the copybook no longer exists in the library it was previously found in, or that library is not in the list the update is using, then the utility searches the libraries in the order they are listed and uses the first version of the copybook that it finds.

Show copybook name with record type field name

Select this option to make the copybook name for a record layout visible during template edit and for an edit, view or browse session where a copybook or template is being used.



Note: For the editor session where the layout name is specified it is prefixed with the name of the associated copybook. This may cause the layout name to be truncated, depending on its length.

Parent panels

- [Set System Processing Options panel on page 797](#)

Child panels

None.

Related tasks

- [Compiler language selection \(option 0.4\) on page 63](#)
- [How FM/Db2 compiles a copybook into a template on page 77](#)

Constraint Columns for panel

FM/Db2 displays the Constraint Columns for panel if you use the COL line command against an item listed on the [Table Check Constraints panel on page 826](#).

Copy Options panel

You use the Copy Options panel to set the global (or initial) options used by the Copy utility (3.3). These options are saved in your ISPF profile and persist from one FM/Db2 session to the next.

The global Copy options are restored at the start of each Copy session and can be temporarily changed for a copy session by selecting **Edit Copy Options** on the Copy “To” entry panel.

Panel and field definitions

Process	Options	Utilities	Help
FM/Db2 (DFG2)		Copy Options	Global Settings
From Table Concurrency Option: Enter "/" to select option / Use uncommitted read		To Table Locking Option: Locking 1. None 2. Share mode 3. Exclusive mode	
Processing Options: Duplicate key processing 1. Ignore 2. Update Max duplicates ALL		Enter "/" to select option - Delete existing rows - Ignore RI/Constraint errors - Native unicode processing - Create audit trail	
Command ==>			
F1=Help	F2=Split	F3=Exit	F7=Backward F8=Forward F9=Swap
F12=Cancel			

Use uncommitted read

Indicates whether to enable retrieval of uncommitted data for the Copy session:

/

Retrieve data, including data not yet committed by another user or application program. The resultant SELECT statement used by FM/Db2 to retrieve table data has the suffix "WITH UR" appended. This allows reading through any locks which might be held on that table. The default is not selected.

(blank)

Only retrieve committed data from tables without write locks.



Note: If FM/Db2 attempts to retrieve data that has a write lock, an SQL error can result.

Locking

FM/Db2 provides options to lock the table to prevent other users from either updating or reading data. Use these options with caution.

1. None

FM/Db2 does not issue an explicit table lock for the object being copied. Locking of rows and pages within the object is managed by Db2® according to FM/Db2 concurrency options and Db2® installation and object definition options. This is the default setting.

2. Share mode

FM/Db2 issues a LOCK TABLE IN SHARE MODE statement before reading the data from Db2®. This restricts all other users to read-only operations on the object.

3. Exclusive mode

FM/Db2 issues a LOCK TABLE IN EXCLUSIVE MODE statement before reading the data from Db2®. This prevents all other users from accessing the object, unless the other process is running with an isolation level of uncommitted read.

Duplicate key processing

You can specify what action FM/Db2 takes if it encounters a duplicate key. Set this option to one of the following:

1. Ignore

Existence of duplicate key ignored. This is the default.

2. Update

Updates duplicate rows when Db2® returns a duplicate key error (SQL error code -803) in response to an INSERT SQL statement. When this option is selected, FM/Db2 attempts to update the existing row. All columns of the table that are part of at least one unique index are used to identify the row. No comparison is made between the copied row and the existing row prior to the update operation (that is, the update is done regardless of whether the copied row and existing row are the same). When using this option, it is recommended that a Db2® table name, rather than a view name, be specified. FM/Db2 does not attempt to update existing rows in a view defined on a view.

For _____ duplicates

Specifies the maximum number of duplicates permitted. Valid values are:

- A number in the range 0 to 2147483647. If FM/Db2 detects more than this number of duplicates during the copy process, the copy is canceled and all changes are rolled back.
- ALL. ALL is the default.

Delete existing rows

Determines whether FM/Db2 deletes all existing rows in the table before copying the data.

/

Delete all existing rows.

(blank)

Do not delete existing rows. This is the default setting.

Ignore RI/Constraint errors

Determines what processing occurs when the Copy utility encounters an SQLCODE-530 (RI error - no primary key) or SQLCODE-545 (Constraint error).

/

The Copy process ignores the error and continues with the next row. The row is not copied or updated and is not included in the copy count.

(blank)

Copy utility canceled. This is the default setting.

Native unicode processing

Determines how FM/Db2 processes Unicode encoded data when copying data between two Unicode encoded tables. When the option is enabled, Unicode encoded data is copied between Unicode encoded tables without the potential for character substitution. When the option is not enabled, the option has no effect; that is, the default processing is used. When either or both of the FROM or TO tables are not Unicode encoded, the option has no effect, even if enabled. When this option and the batch execution options are enabled, "NATIVE= YES" is shown in the generated JCL.

/

Process Unicode data natively.

(blank)

Do not process Unicode data natively. This is the default setting.

Create audit trail

Determines whether audit records are written for the current copy operation. This option may not appear depending on the installation choices made by the product installer. When the option is available, the default is to not write audit records.

Parent panels

- [Setting options for the current Copy session on page 245](#)
- [Copy Utility \("To"\) panel on page 506](#)

Child panels

None.

Related tasks

- [Setting options for the current Copy session on page 245](#)
- [Copy utility options \(option 3.3\) on page 66](#)

Copy Utility ("From") panel

You use the Copy Utility ("From") panel to enter the name of an object to be copied.

Panel and field definitions

Process	Options	Utilities	Help
FM/Db2 (DFG2)			Copy Utility
From Db2 Object:			
Location	_____	Database	_____ (optional)
Owner	DSN8810	Table space _____	(optional)
Name	EMP		+
Copy count	ALL	Number of rows to copy	
From Template:			
Data set name	_____		
Member	_____		
Processing Options:			
Template usage	Enter "/" , "A" always to select option		
3 1. Above	- Edit template		
2. Previous	- Copy panel values		
3. Generate from table	- Create audit trail (*)		
4. Generate/Replace			
Command '==>			
F1=Help	F2=Split	F3=Exit	F4=Expand F7=Backward F8=Forward
F9=Swap	F10=Left	F11=Right	F12=Cancel

Location

The location name for the Db2® object. You can specify a generic name to select from a list. If you enter a value in this field, synonym object names are not recognized or included in the selection list.

Database

The database name for the Db2® object. You can use this field to optionally specify a database to further define the object to be processed. If you enter a value in this field:

- The values displayed in the **Owner** and **Name** selection lists are limited to those values defined within the specified database.
- Synonym names are not recognized or included in the selection list.

Owner

The name of the owner of the object. You can specify a generic name to select from a list. To specify a synonym in the object **Name** field, either leave this field blank, or specify a generic name that includes the current SQLID or specify the current SQLID. Synonyms are not recognized or included on the table selection list if any of the **Table space**, **Database**, or **Location** fields are non-blank.

If the **Translate Db2® object names** option is selected, lowercase characters are converted to uppercase. If this option is not selected, lowercase characters are not converted to uppercase; in this situation, a lowercase owner name such as *“sysibm”* does not match *“SYSIBM”* in the Db2® catalog.

Table space

The table space name for the Db2® object. To further define the object to be processed, you can use this field to optionally specify a table space. If you enter a value in this field:

- The values displayed in the **Owner** and **Name** selection lists are limited to those values defined within the specified table space.
- Synonym names are not recognized, nor included in the selection list.

Name

The name of the object name to be processed. You can specify a generic name to select from a list. To specify a synonym in this field, type the name of the synonym and ensure that the **Owner** field is blank, contains a generic name that includes the current SQLID, or contains the current SQLID. Synonyms are not recognized or included in the table selection list if any of the **Table space**, **Database**, or **Location** fields are non-blank.

If the **Translate Db2® object names** option is selected, lowercase characters are converted to uppercase. If this option is not selected, lowercase characters are not converted to uppercase; in this situation, a lowercase owner name such as *"sysibm"* does not match *"SYSIBM"* in the Db2® catalog.

Copy count

The maximum number of rows to be copied from a Db2® object. It must be one of the following:

- A number in the range 1–99999999,
- An asterisk (*), or
- ALL. This is the default, where all rows selected from the Db2® object are copied.

When the *"From"* template includes a *"Row Selection Criteria"* (or WHERE clause), only those rows matching the selection criteria are considered eligible to be copied.

Data set name

The name of a data set that contains, or will contain, the template. It can be a fully-qualified data set name or a pattern. The name may include a member name or name pattern in parenthesis. If the member is specified here, the associated **Member** field must be empty.

Member

If you specified the name of a partitioned data set (PDS) without including a member name or name pattern in parenthesis in the **Data set name** field, then you can use this field to specify the member name or a member name pattern.

Template usage

The Copy Utility panel provides four options for template processing:

1. Above

Requires that you enter the name of a template data set (and optionally a member name) in the **Template** section of the panel. If you do not specify a member name, or if you specify a pattern, FM/Db2 displays a member selection list. After you have specified the member containing a template, processing continues using this template in place of the automatically-generated template for the table (for a detailed explanation, see Template Usage option 3).

2. Previous

Uses the last (previously used) template for this table.

3. Generate from table

Generates a template based on the information in the Db2® catalog for the specified table. This is the default setting. If you have specified a member name in the **Template** section of the panel, it is ignored. FM/Db2 generates the required template in memory.

4. Generate/Replace

Generates a template based on the information in the Db2® catalog for the specified table, and saves this information in the member specified in the **From Template** section of the panel. If the member already exists, it is replaced. Any prior customization is lost.

You can select the following option by entering a / or an "A":

Edit template

Use to edit the template before copying the data. The default is to not edit the template.

Copy panel values

Use to copy the Db2® object name and template details to the "To" panel. The default is to not copy any values to the "To" panel.

Create audit trail



Note: "*" is appended to the option name for SAF-controlled auditing when required by SAF rules.

Controls whether access to Db2® by FM/Db2 is written to the FM/Db2 audit log. This option only appears when SAF-rule controlled auditing is in effect.

FM/Db2 may write audit records to either SMF, or a data set.

When SAF rules are used to control FM/Db2 auditing, the decision to write audit records is based on the Db2® object name being processed, and the current userid (TSO logonid). Therefore auditing may be required when processing one Db2® object, but not another. In addition, it is possible that the auditing requirement cannot be changed for a particular Db2® object; this might be different for another Db2® object, and the requirement may be different for other TSO userids.

If you do not have the authority to change the audit setting when processing a particular Db2® object, FM/Db2 prompts you if you enter the wrong setting. If you do have the authority to set the audit setting for a particular Db2® object, FM/Db2 honors whatever value is specified in this field.

Parent panels

- [Utility Functions panel on page 864](#)
- [Tables, Views and Aliases panel on page 843](#)

Child panels

To display this panel...	Use/do this
Column Selection/Edit panel on page 485	Select Edit template
Copy Utility ("To") panel on page 506	Press Enter

Related concepts

- [Information stored in a template on page 73](#)
- [SAF-rule controlled auditing on page 69](#)

Related tasks

- [Selecting options on FM/Db2 panels on page 44](#)
- [Working with templates on page 72](#)
- [Where you can use templates on page 23](#)
- [Copying data from one Db2 object to another on page 241](#)
- [Copying data from a VSAM or QSAM file on page 246](#)
- [Copying data to a VSAM or QSAM file on page 274](#)
- [Specifying a data set and a member name on page 50](#)
- [FM/Db2 system options \(option 0.2\) on page 63](#)

COPY Utility (Index Spaces) panel

You use the COPY Utility (Index Spaces) panel to generate utility control statements using the COPY INDEXSPACE form of the COPY utility.

The format of the COPY Utility (Index Spaces) panel depends on which, if any, of the filter fields you specified on the Db2® Utilities panel:

- The panel shown in [Figure 118: COPY Utility \(Index Spaces\) panel—default format on page 503](#) is displayed by default, *or* if you specified information in the **Database name** filter field, the **Table/index space name** filter field, or both.
- The panel shown in [Figure 119: COPY Utility \(Index Spaces\) panel—alternative format on page 503](#) is displayed if you specified information in the **Table/index owner** filter field, the **Table/index name** filter field, or both.



Note: Indexes need to have been defined with the COPY YES clause. Indexes which have not been defined with the COPY YES clause cannot be selected for image copying in the panel.

Panel and field definitions

Figure 118. COPY Utility (Index Spaces) panel—default format

Process		Options		Utilities		Help	
FM/Db2 (DFG2)		COPY Utility (Index Spaces)				Row 1 to 8 of 8	
S	P	Index	Part'n	Allocation		Space	
e	R	Database Space	Number	Primary	Secdry		
l	C	Name					
—		BILLSDB1 XDEPT1	0	3	3	0	
—		BILLSDB1 XDEPT2	0	3	3	0	
—		BILLSDB1 XDEPT3	0	3	3	0	
—		BILLSDB1 XEMP1	1	3	3	0	
—		BILLSDB1 XEMP1	2	3	3	0	
—		BILLSDB1 XEMP1	3	3	3	0	
—		BILLSDB1 XEMP1	4	3	3	0	
—		BILLSDB1 XEMP2	0	3	3	0	
***** Bottom of data *****							
Command ==>						Scroll PAGE	
F1=Help		F2=Split		F3=Exit		F7=Backward F8=Forward F9=Swap	
F12=Cancel							

Figure 119. COPY Utility (Index Spaces) panel—alternative format

Process		Options		Utilities		Help	
FM/Db2 (DFG2)		COPY Utility (Index Spaces)				Row 1 to 8 of 8	
S	P	Index	Part'n	Allocation		Space	
e	R	Index Name	Number	Primary	Secdry		
l	C	Creator					
—		ARROWSB XDEPT1	0	3	3	0	
—		ARROWSB XDEPT2	0	3	3	0	
—		ARROWSB XDEPT3	0	3	3	0	
—		ARROWSB XEMP1	1	3	3	0	
—		ARROWSB XEMP1	2	3	3	0	
—		ARROWSB XEMP1	3	3	3	0	
—		ARROWSB XEMP1	4	3	3	0	
—		ARROWSB XEMP2	0	3	3	0	
***** Bottom of data *****							
Command ==>						Scroll PAGE	
F1=Help		F2=Split		F3=Exit		F7=Backward F8=Forward F9=Swap	
F12=Cancel							

Sel

Selection column. To select an index space, type S in this column. Selected index spaces show an asterisk (*) in the **PRC** column.

PRC

Processing indicator. An asterisk (*) indicates the index space is selected.

Database Name

The name of the database in which the index space is defined.

Index Space Name

The name of the index space.

Part'n Number

The partition number for the table space. This is 0 for a non-partitioned table space. A non-zero value indicates a partition of a partitioned table space. By default, when you select a non-partitioned table space for processing, the utility control statements do not include the DSNUM ALL parameter. When you select a partition, the utility control statements include a DSNUM *nnn* clause (*nnn* is the partition number you selected).

Primary

The primary allocation value for the table space. See the *DB2 Utility Guide and Reference* for a full explanation. This value gives some indication of the size of the table space (but is not definitive).

Secondary

The secondary allocation value for the table space. See the *DB2 Utility Guide and Reference* for a full explanation.

Space

The space allocation for the table space, as reported by the STOSPACE utility. See the *DB2 Utility Guide and Reference* for a full explanation. This value gives an accurate indication of the size of the table space when the STOSPACE utility was run.

Index Creator

The name of the index creator.

Index Name

The name of the index.

Parent panels

- [Db2 Utilities panel on page 610](#)

Child panels

None.

Related tasks

- [COPY utility on page 346](#)
- [COPY \(index spaces\) on page 348](#)

COPY Utility (Index Spaces) with LISTDEF panel

You use the COPY Utility (Index Spaces) with LISTDEF panel to generate utility control statements using the COPY TABLESPACE form of the COPY utility.

Panel and field definitions

Process	Options	Utilities	Help			
FM/Db2 (DFG2)		COPY Utility (Index Spaces)		Row 1 to 3 of 3		
P	R LISTDEF	COPYDDN	Full	Change	Limits	Report
Cmd C	Name	COPYDDN	Template	Copy	One	Two Only
___ *	FRED	SYSCOPY	N	Y	___	___ N
___ *	JAMES	SYSCOPY	N	Y	___	___ N
___	GEORGE	SYSCOPY	N	Y	___	___ N
***** Bottom of data *****						
Command ==> _____ Scroll PAGE						
F1=Help F2=Split F3=Exit F7=Backward F8=Forward F9=Swap						
F12=Cancel						

Cmd

You can enter commands in this field to manipulate the panel rows.

I(n)

Insert (n) new row(s)

R(n)

Repeat the current row (n times)

D(n)

Delete (n) row(s)

S(n)

Select (n) rows(s)

An asterisk (*) in the PRC column shows that the LISTDEF in the row is selected. The S command toggles the selection of rows; unselected rows become selected and selected rows become unselected.

LISTDEF Name

On entry to the panel, this field is set to the value in the **LISTDEF name** field in the Db2® Utilities panel.

Parent panels

- [Db2 Utilities panel on page 610](#)

Child panels

None.

Related tasks

- [COPY utility on page 346](#)
- [COPY \(index spaces\) on page 348](#)

Copy Utility ("To") panel

You use the Copy Utility ("To") panel to enter the name of the Db2® object that is the target of the copy operation. You also use this panel to specify the name of a template that is to provide the column mapping and initialization information.

Panel and field definitions

Process	Options	Utilities	Help
Copy from DSN8810.EMP			
To Db2 Object:			
Location	_____	Database . . _____	(optional)
Owner	FMNUSER	Table space _____	(optional)
Name	EEMP		
To Template:			
Data set name	_____		
Member	_____		
Processing Options:			
Template usage	Enter "/", "A" always to select option		
3 1. Above	- Edit copy options		
2. Previous	- Edit template mapping		
3. Generate from table	- Batch execution		
4. Generate/Replace			
Command ==>			
F1=Help	F2=Split	F3=Exit	F4=Expand F7=Backward F8=Forward
F9=Swap	F10=Left	F11=Right	F12=Cancel

Location

The location name for the Db2® object. You can specify a generic name to select from a list. If you enter a value in this field, synonym object names are not recognized or included in the selection list.

Database

The database name for the Db2® object. You can use this field to optionally specify a database to further define the object to be processed. If you enter a value in this field:

- The values displayed in the **Owner** and **Name** selection lists are limited to those values defined within the specified database.
- Synonym names are not recognized or included in the selection list.

Owner

The name of the owner of the object. You can specify a generic name to select from a list. To specify a synonym in the object **Name** field, either leave this field blank, or specify a generic name that includes the current SQLID or specify the current SQLID. Synonyms are not recognized or included on the table selection list if any of the **Table space**, **Database**, or **Location** fields are non-blank.

If the **Translate Db2® object names** option is selected, lowercase characters are converted to uppercase. If this option is not selected, lowercase characters are not converted to uppercase; in this situation, a lowercase owner name such as “*sysibm*” does not match “*SYSIBM*” in the Db2® catalog.

Table space

The table space name for the Db2® object. To further define the object to be processed, you can use this field to optionally specify a table space. If you enter a value in this field:

- The values displayed in the **Owner** and **Name** selection lists are limited to those values defined within the specified table space.
- Synonym names are not recognized, nor included in the selection list.

Name

The name of the object name to be processed. You can specify a generic name to select from a list. To specify a synonym in this field, type the name of the synonym and ensure that the **Owner** field is blank, contains a generic name that includes the current SQLID, or contains the current SQLID. Synonyms are not recognized or included in the table selection list if any of the **Table space**, **Database**, or **Location** fields are non-blank.

If the **Translate Db2® object names** option is selected, lowercase characters are converted to uppercase. If this option is not selected, lowercase characters are not converted to uppercase; in this situation, a lowercase owner name such as “*sysibm*” does not match “*SYSIBM*” in the Db2® catalog.

Data set name

The name of a data set that contains, or will contain, the template. It can be a fully-qualified data set name or a pattern. The name may include a member name or name pattern in parenthesis. If the member is specified here, the associated **Member** field must be empty.

Member

If you specified the name of a partitioned data set (PDS) without including a member name or name pattern in parenthesis in the **Data set name** field, then you can use this field to specify the member name or a member name pattern.

Template usage

The Copy Utility panel provides four options for template processing:

1. Above

Requires that you enter the name of a template data set (and optionally a member name) in the **Template** section of the panel. If you do not specify a member name, or if you specify a pattern, FM/Db2 displays a member selection list. After you have specified the member containing a template, processing continues using this template in place of the automatically-generated template for the table (for a detailed explanation, see Template Usage option 3).

2. Previous

Uses the last (previously used) template for this table.

3. Generate from table

Generates a template based on the information in the Db2® catalog for the specified table. This is the default setting. If you have specified a member name in the **Template** section of the panel, it is ignored. FM/Db2 generates the required template in memory.

4. Generate/Replace

Generates a template based on the information in the Db2® catalog for the specified table, and saves this information in the member specified in the **To Template** section of the panel. If the member already exists, it is replaced. Any prior customization is lost.

You can select the following options by entering a / or an "A":

Edit copy options

Displays the copy options panel. The default is not selected.

Edit template mapping

Use to edit the template for the table to which you are copying the data, before copying the data. The default is not selected.

Batch execution

Generates the JCL to perform the FM/Db2 Copy function as a batch job. You can edit the JCL and submit the job manually once the JCL has been generated. The default is not selected - the Copy job runs in the foreground.

Parent panels

- [Copy Utility \("From"\) panel on page 498](#)

Child panels

To display this panel...	Use/do this
Copy Options panel on page 495	Select Edit copy options
Template Mapping panel on page 850	Select Edit template mapping

Related tasks

- [Specifying a data set and a member name on page 50](#)
- [Selecting options on FM/Db2 panels on page 44](#)
- [Copying data from one Db2 object to another on page 241](#)
- [Mapping data on page 109](#)
- [Copying data from one Db2 object to another on page 241](#)

COPY Utility (Table Spaces) panel

You use the COPY Utility (Table Spaces) panel to generate utility control statements using the COPY TABLE SPACE form of the COPY utility.

Panel and field definitions

Process		Options		Utilities		Help					
FM/Db2 (DFG2)				COPY Utility (Table Spaces)				Row 1 to 12 of 233			
S	P	Table	F	Change	R						
e	R	Database	C	Limits	P	Part'n	Number	Allocation			
l	C	Name	P	One	Two	O	Number	Tables	Primary	Secdry	Space
—		BILLSDB1	Y	—	—	N	0	1	3	3	0
—		BILLSDB1	Y	—	—	N	1	1	3	3	0
—		BILLSDB1	Y	—	—	N	2	1	5	5	0
—		BILLSDB1	Y	—	—	N	3	1	3	3	0
—		BILLSDB1	Y	—	—	N	4	1	5	5	0
S		BILLSDB2	Y	—	—	N	0	2	180	180	0
—		CJMAODA	Y	—	—	N	0	1	5	5	48
—		CJMAODA	Y	—	—	N	1	1	3	3	144
—		CJMAODA	Y	—	—	N	2	1	5	5	144
—		CJMAODA	Y	—	—	N	3	1	3	3	48
—		CJMAODA	Y	—	—	N	4	1	5	5	144
—		CJMAODA	Y	—	—	N	0	4	40	20	192
Command ==>											
F1=Help		F2=Split		F3=Exit		F7=Backward		F8=Forward		F9=Swap	
										Scroll PAGE	
F12=Cancel											

Sel

Selection column. To select a table space, type S in this column. Selected table spaces show an asterisk (*) in the **PRC** column.

PRC

Processing indicator. An asterisk (*) indicates the table space is selected.

Database Name

The name of the database in which the table space is defined.

Table Space Name

The name of the table space.

FCP

Full Copy flag:

Y

Take a full image copy. This is the default setting.

N

Take a partial image copy.

Change Limits (One Two)

You can specify 1 or 2 values indicating the percentage of changed pages needed to trigger a partial image copy, and a full image copy. See the *DB2 Utility Guide and Reference* for a detailed explanation. A value entered in either of the **Change Limits** fields overrides the **FCP** setting.

RPO

Report Only. This only takes effect if you have specified a change limit value (see **Change Limits**).

Y

Only image copy information is displayed. Image copies are not taken, only recommended. FM/Db2 generates a DD DUMMY in the JCL for the SYSCOPY DD name.

N

Image copy information is displayed and image copies taken. This is the default setting.

The remaining columns of the ISPF table are display-only fields showing information from the Db2® catalog.

Part'n Number

The partition number for the table space. This is 0 for a non-partitioned table space. A non-zero value indicates a partition of a partitioned table space. By default, when you select a non-partitioned table space for processing, the utility control statements do not include the DSNUM ALL parameter. When you select a partition, the utility control statements include a DSNUM *nnn* clause (*nnn* is the partition number you selected).

Number Tables

The number of tables defined within the table space.

Primary

The primary allocation value for the table space. See the *DB2 Utility Guide and Reference* for a full explanation. This value gives some indication of the size of the table space (but is not definitive).

Secdry

The secondary allocation value for the table space. See the *DB2 Utility Guide and Reference* for a full explanation.

Space

The space allocation for the table space, as reported by the STOSPACE utility. See the *DB2 Utility Guide and Reference* for a full explanation. This value gives an accurate indication of the size of the table space when the STOSPACE utility was run.

Parent panels

- [Db2 Utilities panel on page 610](#)

Child panels

None.

Related tasks

- [COPY utility on page 346](#)

COPY Utility (Table Spaces) with LISTDEF panel

You use the COPY Utility (Table Spaces) with LISTDEF panel to generate utility control statements using the COPY TABLE SPACE form of the COPY utility, and with a LISTDEF provided.

Panel and field definitions

Process	Options	Utilities	Help
FM/Db2 (DFG2)		COPY Utility (Table Spaces)	Row 1 to 1 of 1
P			Change
R	LISTDEF	COPYDDN	Full Limits Report
Cmd C	Name	Template	Copy One Two Only
	FRED	SYSCOPY	Y ___ N
	JAMES	SYSCOPY	Y ___ N
***** Bottom of data *****			
Command ==> _____ Scroll PAGE			
F1=Help F2=Split F3=Exit F7=Backward F8=Forward F9=Swap			
F12=Cancel			

Cmd

You can enter commands in this field to manipulate the panel rows.

I(n)

Insert (n) new row(s)

R(n)

Repeat the current row (n times)

D(n)

Delete (n) row(s)

S(n)

Select (n) rows(s)

An asterisk (*) in the PRC column shows that the LISTDEF in the row is selected. The S command toggles the selection of rows; unselected rows become selected and selected rows become unselected.

LISTDEF Name

On entry to the panel, this field is set to the value in the **LISTDEF name** field in the Db2® Utilities panel.

Parent panels

- [Db2 Utilities panel on page 610](#)

Child panels

None.

Related tasks

- [COPY utility on page 346](#)
- [COPY \(table spaces\) on page 347](#)

Create Alias panel

You use the Create Alias panel to create an alias for a table or a view at the correct location.

Panel and field definitions

Process	Options	Utilities	Help
FM/Db2 (DFG2)			Create Alias
Alias Details:			
Owner	_____	+	(optional)
Name	_____		+
Table or View Details:			
Location	_____		
Owner	_____	+	
Name	_____		+
Command ==>			
F1=Help	F2=Split	F3=Exit	F4=Expand
F9=Swap	F10=Left	F11=Right	F7=Backward F8=Forward
		F12=Cancel	

Owner (Alias Details)

The owner of the alias you want to create (optional). If you leave this field blank, FM/Db2 uses the current SQL ID as a default ID. Otherwise, type the full name of the owner.

Name Alias Details

The name of the alias you want to create (mandatory).

Location

The location of the table or view for which you want to create an alias (optional). If you leave this field blank, FM/Db2 uses the location of the local Db2® system.

Owner (Table or View Details)

The owner of the table or view for which you want to create an alias (optional). If you leave this field blank, FM/Db2 uses the current SQL ID as a default ID. Otherwise, type the full name of the owner.

Name (Table or View Details)

The name of the table or view for which you want to create an alias (mandatory).

Parent panels

- [Db2 Object Functions panel on page 604](#)
- [Tables, Views and Aliases panel on page 843](#)
- [Synonyms panel on page 815](#)

Child panels

None.

Related tasks

- [Creating and dropping Db2 objects on page 203](#)
- [Creating an alias on page 230](#)

Create Auxiliary Table panel

You use the Create Auxiliary Table panel to create a new auxiliary table.

Panel and field definitions

Process	Options	Utilities	Help
FM/Db2 (DFG2)		Create Auxiliary Table	
Auxiliary table:			
Owner	_____	+	(optional)
Name	_____	+	
Table Space:			
Name	_____		
Database	_____		(optional)
Base Table:			
Owner	_____	+	(optional)
Name	_____	+	
Base Table Column:			
Name	_____		
Partition	_____		(optional)
Command ==> _____			
F1=Help	F2=Split	F3=Exit	F4=Expand
F9=Swap	F10=Left	F11=Right	F12=Cancel
			F7=Backward F8=Forward

Owner (Auxiliary Table)

Specifies the owner of the auxiliary table.

Name (Auxiliary Table)

Specifies the name of the auxiliary table.

Name (Table Space)

Specifies the LOB table space in which the auxiliary table is created.

Database (Table Space)

Specifies the database to which the specified table space belongs.

Owner (Base Table)

Specifies the owner of the base table containing the LOB column that is stored in the auxiliary table.

Name (Base Table)

Specifies the name of the base table containing the LOB column that is stored in the auxiliary table.

Name (Base Table Column)

Specifies the name of the LOB column in the base table that is stored in the auxiliary table.

Partition (Base Table Column)

For base tables defined in partitioned table spaces, specifies the partition of the base table for which this auxiliary table stores data.

Parent panels

- [Db2 Object Functions panel on page 604](#)

Child panels

None.

Related tasks

- [Creating and dropping Db2 objects on page 203](#)
- [Creating an auxiliary table on page 237](#)

Create Database panel

You use the Create Database panel to create a new database.

Panel and field definitions

Process	Options	Utilities	Help
FM/Db2 (DFG2)			Create Database
Database:			
Name	_____		(required)
Buffer Pools, Storage Groups:			
Storage group name	_____	+	(optional)
Buffer pool for table spaces	_____		(optional)
Buffer pool for indexes	_____		(optional)
Database Options:			
Database Usage		Data Encoding (only for user databases)	
- 1. User database (default)		- 1. EBCDIC (default)	
2. Work file database		2. ASCII	
3. Temporary database		3. UNICODE	
Member Selection:			
Member name	_____		(only valid for work file databases)
Command ==>			
F1=Help	F2=Split	F3=Exit	F4=Expand
F9=Swap	F10=Left	F11=Right	F12=Cancel

Name

Specify the name of the Db2® database you want to create.

Storage group name

Names the Db2® storage group to be used, as the default group for DASD allocation for table spaces and indexes in the database.

Buffer pool for table spaces

Specifies the default buffer pool name to be used for table spaces created within the database.

1. 8K buffers: (BP8K0-BP8K9)
2. 16K buffers: (BP16K0-BP16K9)



Note:

8K and 16K buffer pools are not supported for work file databases.

Buffer pool for indexes

Specifies the default buffer pool name to be used for the indexes created within the database.

Database Usage

1. User database (default)

Specifies the database is an ordinary database for general user tables and indexes.

2. Work file database

Specifies the database is a work file database for use in a data sharing environment.

Temporary database

Specifies the database is for declared temporary tables only.

Data Encoding (only for user databases)

1. EBCDIC (default)

Specifies the encoding scheme.

2. ASCII

Specifies the encoding scheme.

3. UNICODE

Specifies the encoding scheme.

Parent panels

- [Db2 Object Functions panel on page 604](#)
- [Databases panel on page 593](#)

Child panels

None.

Related tasks

- [Creating and dropping Db2 objects on page 203](#)
- [Creating a database on page 218](#)

Create Distinct Type panel

You use the Create Distinct Type panel to create a new distinct type.

Panel and field definitions

Process	Options	Utilities	Help
FM/Db2 (DFG2)	Create Distinct Type		
Distinct Type:			
Schema	_____	+ (optional)	
Name	_____		+
Source Data Type:			
Source Type	_____		+
Length/Precision	_____	(optional)	
Scale	_____	(optional)	
For Data		Encoding Method	
- 1. SBCS		- 1. EBCDIC	
2. Mixed		2. ASCII	
3. Bit		3. UNICODE	
Command ==>			
F1=Help	F2=Split	F3=Exit	F4=Expand
F9=Swap	F10=Left	F11=Right	F12=Cancel
			F7=Backward F8=Forward

Schema

The schema name in which to create the function.

Name

The name of the user-defined function.

Source Type

Db2® data type in which the distinct type is based.

Length/Precision

Data length of the distinct type. For distinct types based on the DECIMAL data type, this is the precision.

Scale

For distinct types based on the DECIMAL data type.

For Data

For non-DBCS data types (CHAR, VARCHAR and CLOB), specifies the subtype. BIT is not allowed for CLOB.

Encoding Method

1. EBCDIC (default)

Specifies the encoding scheme for the distinct data type.

2. ASCII

Specifies the encoding scheme for the distinct data type.

3. UNICODE

Specifies the encoding scheme for the distinct data type.

EBCDIC and ASCII specifies the encoding scheme for the distinct data type.

Parent panels

- [Db2 Object Functions panel on page 604](#)
- [Distinct Types panel on page 619](#)

Child panels

None.

Related tasks

- [Creating and dropping Db2 objects on page 203](#)
- [Creating a distinct type on page 233](#)

Create Function: Option List (1/2) panel

You use the Create Function: Option List (1/2) panel to specify information to define options for the function to be created.

Panel and field definitions

<u>P</u> rocess	<u>O</u> ptions	<u>U</u> tilities	<u>H</u> elp
FM/Db2 (DFG2)		Create Function: Option List (1/2)	
External Name . . .	_____	+ (usually optional)	
Scratchpad	_____	(optional)	
Package Collection	_____	+ (optional)	
WLM Environment . .	_____	+ (optional)	
Time Limit	_____	(CPU units - optional)	
Language (Required)	SQL	Security	
- 1. ASSEMBLE	- 1. Reads SQL Data	- 1. Db2	
2. C	2. No SQL	2. User	
3. COBOL	3. Modifies SQL Data	3. Definer	
4. PLI	4. Contains SQL		
Parallelism			
- 1. Allowed			
2. Disallowed			
Run-time Options (optional)			
_____ +			
Command ==>			
F1=Help	F2=Split	F3=Exit	F4=Expand
F9=Swap	F10=Left	F11=Right	F12=Cancel
		F7=Backward	F8=Forward

External Name

Name of the MVS™ load module that contains the user-written code to implement the function.

Scratch Pad

Size of the scratch pad allocated by Db2® and passed to the function when it is called.

Package Collection

Specifies the package collection to be used when the function is run. If not specified, the invoking program's package collection is used.

Workload Manager Environment

Specifies the MVS™ workload manager environment in which the function is to run.

Time Limit (CPU units)

Limit on processor service units used by a single invocation of the function.

LANGUAGE (Required)

Application programming language of the function:

SQL

Specifies what type of SQL statements the function contains:

Security

Specifies the interaction of the function with an external security product:

Parallel

Specifies if Db2® can consider parallelism for the function:

Run-time options

Specifies the Language Environment® run-time options to be used for the function.

Parent panels

- [Create Function panel on page 521](#)

Child panels

None.

Related tasks

- [Creating a function on page 234](#)

Create Function: Option List (2/2) panel

You use the Create Function: Option List (2/2) panel to further specify information to define options for the function to be created.

Panel and field definitions

```

Process  Options  Utilities  Help
-----
FM/Db2 (DFG2)          Create Function Option List (2/2)

Enter '/' to select option
- Main Program
- Stay Resident
- / Deterministic
- Called on null input
- No external action
- Final Call
- DBINFO argument passed

Command ==>
F1=Help      F2=Split    F3=Exit     F4=CRetriev  F7=Backward  F8=Forward
F9=Swap      F10=Action  F12=Cancel
    
```

You can select the following options by entering a `/`:

Main Program

The program runs as a main routine, otherwise it runs as a subroutine.

Stay Resident

The function load module remains in memory when the function ends.

Deterministic

The function always returns the same result for the same set of input values.

Called on Null Input

The function is called even if one or more of the input parameters has a null value.

No external action

The function does not take any action that changes the state of an object Db2® does not manage.

Final Call

A final call is made to the function to allow it to perform any required cleanup operations.

DBINFO Argument Passed

Additional Db2® information is passed when the function is called.

Parent panels

- [Create Function panel on page 521](#)

Child panels

None.

Related tasks

- [Creating a function on page 234](#)

Create Function panel

You use the Create Function panel to create a new function.

Panel and field definitions

<u>P</u> rocess	<u>O</u> ptions	<u>U</u> tilities	<u>H</u> elp
FM/Db2 (DFG2)		Create Function	
Function:			
Schema	_____ + (optional)		
Name	FUN1 _____ +		
Unique Name	_____ + (optional)		
Function Creation:			
Creation Options			
5	1. Parameters	(optional, usually required)	
	2. Parameter Types	(optional, define parameters first)	
	3. Returned data type	(required)	
	4. Option List	(required)	
	5. Option List (More)	(optional)	
	6. Create the Function		
Command ==>			
F1=Help	F2=Split	F3=Exit	F4=Expand
F9=Swap	F10=Left	F11=Right	F12=Cancel
		F7=Backward	F8=Forward

Schema

The schema name in which to create the function.

Name

The name of the user-defined function.

Unique Name

Specifies a unique name for the function that is used by certain SQL statements and Db2® commands.

Creation Options

Specify the number of the creation option you want to use:

1. Parameters

Displays the Create Function Parameters panel for defining parameters for the function.

2. Parameter Types

Displays the Create Function Parameter Types panel for specifying additional type information for the function parameters.

3. Returned data type

Displays the Create Function: Returned Data Type panel for specifying the data type returned by the function.

4. Option List

Displays the Create Function Option List (1/2) panel for specifying various options for further defining the function.

5. Option List (More)

Displays the Create Function Option List (2/2) panel for specifying additional options for the function.

6. Create the Function

When you have finished specifying parameter, data type, and option information as required, select this creation option to create the function.

Parent panels

- [Db2 Object Functions panel on page 604](#)
- [Functions panel on page 684](#)

Child panels

To display this panel...	Use/do this
Create Function: Parameters panel on page 524	Creation option 1
Create Function: Parameter Types panel on page 522	Creation option 2
Create Function: Returned Data Type panel on page 525	Creation option 3
Create Function: Option List (1/2) panel on page 518	Creation option 4
Create Function: Option List (2/2) panel on page 519	Creation option 5

Related tasks

- [Creating and dropping Db2 objects on page 203](#)
- [Creating a function on page 234](#)

Create Function: Parameter Types panel

You use the Create Function: Parameter Types panel to specify additional type information for the function parameters.

Panel and field definitions

Process	Options	Utilities	Help
FM/Db2 (DFG2)	Create Function: Parameter Types		Row 1 to 1 of 1
Parameter Name	+ Data Type(Length)	+ (Y/N)	As LOC <-----Like Table/View-----> Owner + Name +
PAR1	CHAR(3)		
***** Bottom of data *****			
Command ==>			
F1=Help	F2=Split	F3=Exit	F4=Expand
F9=Swap	F10=Left	F11=Right	F12=Cancel
			Scroll PAGE
			F7=Backward F8=Forward

Parameter Name

As defined using option 1.

Data Type (Length)

As defined using option 1.

As LOC (Y/N)

For LOB data types, specifies whether a locator for the parameter is passed instead of the value itself:

Y

Locator passed

N

Value passed

Owner

Defines the parameter as a locator to a transition table.

Like Table/View Name

The owner and name specify a table or view with columns that match those of the transition table.

Parent panels

- [Create Function panel on page 521](#)

Child panels

None.

Related tasks

- [Creating a function on page 234](#)

Create Function: Parameters panel

You use the Create Function: Parameters panel to define parameters for the function.

Panel and field definitions

```

  Process  Options  Utilities  Help
-----
FM/Db2 (DFG2)          Create Function Parameters          Row 1 to 1 of 1
                        <---(For Built in Data Types)----->
C                                <DEC>
M                                <FL>  For   User Defined
D Parameter Name  + Data Type      + Len  Pr Sc Data  Data Type      +
  NAME           CHAR              20
-----
***** Bottom of data *****

Command ==> _____ Scroll PAGE
F1=Help      F2=Split    F3=Exit     F4=Expand   F7=Backward F8=Forward
F9=Swap      F10=Left   F11=Right  F12=Cancel
    
```

Cmd

This field is used for entering commands.

Parameter Name

As defined using option 1.

Data Type

This field is used for entering the data type for the column being defined.

Len

This field is (optionally) used for entering the length, and optionally the scale of the column. The numeric fields such as INTEGER, REAL, no length specification is required. For character fields, only a single length specification is required. For decimal fields, you can specify a length and a scale.

DEC

For a decimal number. The first integer is the precision number. That is, the total number of digits which can range from 1 to 31. The second integer is the scale of the number. That is the number of digits to the right of the decimal point, which can range from 0 to the precision of the number.

FL

For a floating-point number. If integer is between 1 and 21 inclusive, the format is single precision floating-point. If the integer is between 22 and 53 inclusive, the format is double precision floating-point.

Pr Sc

The scale is the total number of digits in the fractional part of the number and the precision is the total number of digits in the number.

For Data

The definitions for character and character large object (CLOB) allow the specification of an optional 'FOR DATA' clause. This field is used to specify the appropriate value.

User Defined Data Type

Specifies the data type of the column is a distinct type (a user defined-data type). The length, precision and scale of the column are respectively the length, precision and scale of the source type of the distinct type. The privilege set must implicitly or explicitly include the USAGE privilege on the distinct type.

Parent panels

- [Create Function panel on page 521](#)

Child panels

None.

Related tasks

- [Creating a function on page 234](#)

Create Function: Returned Data Type panel

You use the Create Function: Returned Data Type panel to specify the data type returned by the function.

Panel and field definitions

Process	Options	Utilities	Help
FM/Db2 (DFG2)	Create Function: Returned Data Type		
Returns:			
Schema	_____	+ (optional, for user-defined types)	
Data Type	_____	+	
Length/Precision	_____	(optional)	
Scale	_____	(optional)	
For Data	Encoding Method		
- 1. SBCS	- 1. EBCDIC		
- 2. Mixed	- 2. ASCII		
- 3. Bit	- 3. UNICODE		
Cast From:			
Data Type	_____	+ (optional)	
Length/Precision	_____	(optional)	
Scale	_____	(optional)	
For Data	Encoding Method		
- 1. SBCS	- 1. EBCDIC		
- 2. Mixed	- 2. ASCII		
- 3. Bit	- 3. UNICODE		
As Locator:			
Enter "/" to select option			
Return a locator to the value (LOB data type only)			
Command ==>			
F1=Help	F2=Split	F3=Exit	F4=Expand F7=Backward F8=Forward
F9=Swap	F10=Left	F11=Right	F12=Cancel

Schema

Specifies the schema name that qualifies a user-defined data type.

Data Type (Returns)

Specifies the data type returned by the function.

Length/Precision (Returns)

Specifies the length for built-in data types. For the decimal data type this is the precision.

Scale (Returns)

For the DECIMAL data type only.

For Data (Returns)

1.SBCS

Only for built in data types.

2.Mixed

Only for built in data types.

3.Bit

Only for built in data types.

Encoding Method (Returns)

Only for built-in data types. Specifies the actual data type returned by the function. See note below.

Data Type (Cast From)

Specifies the data type returned by the function.

Length/Precision (Cast From)

Specifies the length for built-in data types. For the decimal data type this is the precision.

Scale (Cast From)

For the DECIMAL data type only.

For Data (Cast From)**1.SBCS**

Only for built in data types.

2.Mixed

Only for built in data types.

3.Bit

Only for built in data types.

Encoding Method (Cast From)

See note below.

As Locator

For LOB data types, specifies that a locator for the parameter is returned instead of the value itself.



Note: If “*Cast From*” is not specified, then the “*Returns*” **Encoding Method** defines the data type returned by the function to the invoking statement. If “*Cast From*” is specified, then the “*Cast From*” **Encoding Method** is the data type returned by the function and the “*Returns*” **Encoding Method** is the data type passed to the invoking statement by Db2® (having “*cast*” it from the “*Cast From*” data type).

Parent panels

- [Create Function panel on page 521](#)

Child panels

None.

Related tasks

- [Creating a function on page 234](#)

Create Index panel

You use the Create Index panel to create an index for a pre-existing base table.

Panel and field definitions

```

Process  Options  Utilities  Help
-----
FM/Db2 (DFG2)                                Create Index

New Index:
Owner . . . . . _____ + (optional)
Name . . . . . _____ +
Table Owner . . . . _____ + (optional)
Table Name . . . . _____ +
Buffer Pool . . . . _____ (optional, BP0-BP49)

Index Creation:
Creation Options
 2 1. Index type (optional)
   2. Index columns (required, except on auxiliary tables)
   3. Allocation (optional, usually needed)
   4. Index options (optional)
   5. Partitions (partitioned indexes only)
   6. Partition values (required for partitioned indexes)
   7. Create the index

Command ==>
F1=Help    F2=Split    F3=Exit    F4=Expand    F7=Backward  F8=Forward
F9=Swap    F10=Left    F11=Right  F12=Cancel
    
```

Owner

The owner of the index.

Name

The name of the index. This is a required field.

Table Owner

The SQLID used to create the table on which the index is being defined.

Table Name

The name of the table on which the index is being created. This is a required field. You can enter the name of the table on which the index is created. A validation check needs to be performed to verify that the table exists.

Buffer Pool

The name of the buffer pool in which the index data sets are created.

Creation Options

Specify the number of the creation option you want to use:

1. Index type

To specify information to define the type of index to be created. Displays the Create Index: Type panel.

2. Index columns

To select the columns that comprise the index. Displays the Create Index: Column Selection panel.

3. Allocation

To specify the space requirements for the index being created. displays the Create Index: Allocation panel.

4. Index options

To specify information to define options for the index to be created. Displays the Create Index: Options panel.

5. Partitions

To specify space information for index partitions. displays the Create Index: Partitions panel.

6. Partition values

To specify limit values for index entries in each partition. displays the Create Index: Partition Values panel.

7. Create the index

When you have finished specifying details for the index to be created, select this creation option to create the index.

Parent panels

- [Db2 Object Functions panel on page 604](#)
- [Tables, Views and Aliases panel on page 843](#)
- [Indexes panel on page 697](#)
- [Explain Utilities panel on page 662](#)

Child panels

To display this panel...	Use/do this
Create Index: Type panel on page 537	Creation option 1
Create Index: Column Selection panel on page 531	Creation option 2
Create Index: Allocation panel on page 530	Creation option 3
Create Index: Options panel on page 532	Creation option 4
Create Index: Partitions panel on page 534	Creation option 5
Create Index: Partition Values panel on page 535	Creation option 6

Related tasks

- [Creating an index on page 231](#)

Create Index: Allocation panel

You use the Create Index: Allocation panel to specify the space requirements for the index being created.

Panel and field definitions

```

Process  Options  Utilities  Help
-----
FM/Db2 (DFG2)                Create Index: Allocation

Data Set Parameters:
VCAT name . . . . _____ (for user-defined data sets only)
Storage group name _____ +

Space Requirements for Storage Group:
Primary space . . 20 _____ (in kilobytes)
Secondary space . 10 _____ (in kilobytes)

Free Space Options:
Free pages . . . . ____ (0-255, default 0)
Free space . . . . ____ (0-99 percent, default 10)

Command ==>> _____
F1=Help      F2=Split      F3=Exit      F4=Expand      F7=Backward  F8=Forward
F9=Swap      F10=Left     F11=Right   F12=Cancel

```

VCAT name

User-defined data sets.

Storage group name

Db2-defined data sets (STOGROUP name)

Primary space

Specifies the minimum primary space allocation for a managed Db2® data set.

Secondary space

Specifies the minimum secondary space allocation for a managed Db2® data set.

Free pages

Valid values are 0-255. For a detailed description, see *DB2 for z/OS SQL Reference*.

Free space

Valid values are 0-99. For a detailed description, see *File Manager User's Guide and Reference for IMS Data*.

Parent panels

- [Create Index panel on page 527](#)

Child panels

None.

Related tasks

- [Creating an index on page 231](#)

Create Index: Column Selection panel

You use the Create Index: Column Selection panel to select the columns that comprise the index.

Panel and field definitions

<u>P</u> rocess	<u>O</u> ptions	<u>U</u> tilities	<u>H</u> elp
FM/Db2 (DFG2)		Create Index: Column Selection	Row 1 to 1 of 1
New Index:			
Owner			+
Name	IND1		+
Table owner			+
Table name	TABLE1		+
Sel Ord (A/D)	Column Name	Datatype(length)	+ Null Attr.
_____	COL1	CHAR(3)	
***** Bottom of data *****			
Command ==>			
F1=Help	F2=Split	F3=Exit	F4=Expand
F9=Swap	F10=Left	F11=Right	F12=Cancel
			Scroll PAGE
			F8=Forward

Owner

The name of the owner of the new index.

Name

The name of the new index.

Table owner

The SQLID used to create the table on which the index is being defined.

Table name

The table on which the index is created.

The bottom half of the panel shows a table that can be scrolled in the usual ISPF manner.

Sel

An input selection field. This is where you identify the columns that make up the index. You can enter **s** to select or deselect any column. You can also type a number against a column, to indicate the ordering of the columns in the index.

Order

A display-only field. Possible values are spaces, indicating this column is not part of the index; or a number, indicating that this column has been selected as part of the index, and its order among the selected columns.

(A/D)

Indicates how the values in the column are to be indexed. If **Sel** is blank, but **A/D** is not blank, it is as if **Sel** contains "S". The available options are:

A

Ascending. This is the default. If you do not specify a value, this field is filled with an "A" when the panel is redisplayed.

D

Descending

Column Name

The name of the column.

Data Type(length)

The Db2® data type of the column.

Null Attribute

Shows whether column allows null values.

Parent panels

- [Create Index panel on page 527](#)

Child panels

None.

Related tasks

- [Creating an index on page 231](#)

Create Index: Options panel

You use the Create Index: Options panel to specify information to define options for the index to be created.

Panel and field definitions

Process	Options	Utilities	Help
FM/Db2 (DFG2)	Create Index Options		
Data Storage Options:			
Enter '/' to select option			
/ Close when not in use			
- Erase data on delete			
- Defer building index			
/ Define data set now			
- Allow COPY of index			
Group Buffer Pool Usage:			
Write to the group buffer pool			
- 1. Changed			
- 2. All			
- 3. None			
Command ==>			
F1=Help	F2=Split	F3=Exit	F4=CRetrieval
F9=Swap	F10=Actions	F12=Cancel	F7=Backward F8=Forward

You can use the first group of input fields to select the appropriate option with the '/' selection character. The following section describes the options:

Close when not in use

This corresponds to the CLOSE YES/NO clause. It relates to how Db2® handles open data sets when the limit for the maximum number of open data sets is reached.

Erase data on delete

This corresponds to the ERASE YES/NO clause in the 'USING' block. ERASE YES means that the data sets associated with the partition are overwritten with binary zeros when the partition is deleted (dropped).

Defer building index

This corresponds to the DEFER YES/NO clause. The default value is DEFER NO, meaning that the index is built when the CREATE INDEX statement is executed.

Define data set now

This corresponds to the DEFINE YES/NO clause. The default value is DEFINE YES, meaning that the data sets used for the index are created when the CREATE INDEX statement is executed.

Allow COPY of index

This corresponds to the COPY YES/NO clause. The default value is COPY NO, meaning that it is not possible to use the COPY utility against the index.

The second input field on the panel contains three options relating to the use of the grouped buffer pool. You can select the required option by typing the appropriate number. This corresponds to the GBPCACHE clause in the create statement syntax.

Parent panels

- [Create Index panel on page 527](#)

Child panels

None.

Related tasks

- [Creating an index on page 231](#)

Create Index: Partitions panel

You use the Create Index: Partitions panel to specify space information for index partitions.

Panel and field definitions

Process	Options	Utilities	Help
FM/Db2 (DFG2)		Create Index: Partitions	Row 1 to 1 of 1
New Index:			
Owner			+
Name	IND1		+
Table owner			+
Table name	TABLE1		+
Parttn.	VCAT	STOGRROUP	Primary
Cmd Number	Name	Name +	Space
1			Space
			Erase Free %
			Data? Pages Free Caching
***** Bottom of data *****			
Command ==>>>			
F1=Help	F2=Split	F3=Exit	F4=Expand
F9=Swap	F10=Left	F11=Right	F12=Cancel
			F7=Backward
			F8=Forward
			Scroll PAGE

Owner

The name of the owner of the new index.

Table owner

The SQLID used to create the table on which the index is being defined.

Name

The name of the new index.

Table name

The table on which the index is created.

Cmd

An input selection field. When the panel is first displayed, the table contains 1 row, with default values entered. To define additional partitions type 'l' in the selection field and press Enter. You can also type 'R' to repeat the current definition. Other valid selection commands are i and r followed by an integer.

Parttn. Number

A sequential number showing the number of partitions defined. This is a display only field.

VCAT Name

The VCAT name used to define user-specified data sets. This is an input field. It is mutually exclusive with the STOGROUP parameter.

STOGROUP name

The Db2® storage group name in which the index data set is defined. This is an input field. It is mutually exclusive with the VCAT parameter.

Primary Space

The primary space allocation for the partition, entered in kilobytes.

Secndry Space

The secondary space allocation for the partition, entered in kilobytes.

Erase Data?

A YES/NO value corresponding to the ERASE YES/NO clause.

Free Pages

Free pages results in Db2® leaving an empty page every n pages (n is what is specified).

% Free

The value specified here results in Db2® leaving $n\%$ (n is what is specified) of each page free.

Grp BP Caching

This corresponds to the GBPCACHE clause of the create statement (for each partition). These options only apply in a data sharing environment.

Parent panels

- [Create Index panel on page 527](#)

Child panels

None.

Related tasks

- [Creating an index on page 231](#)

Create Index: Partition Values panel

You use the Create Index: Partition Values panel to specify limit values for index entries in each partition.

Panel and field definitions

```

Process  Options  Utilities  Help
-----
FM/Db2 (DFG2)          Create Index: Partition Values          Row 1 to 6 of 6

New Index:
Owner . . . . . +
Name . . . . . FRED                      +
Table owner . . . . FMNUSER              +
Table name . . . . EMP                    +

Parttn.
Number  Column Name          Value          +
  1     EMPNO                _____
        FIRSTNME            _____
        MIDINIT             _____
  2     EMPNO                _____
        FIRSTNME            _____
        MIDINIT             _____
***** Bottom of data *****

Command ==>
F1=Help      F2=Split    F3=Exit     F4=Expand   F7=Backward F8=Forward
F9=Swap      F10=Left   F11=Right   F12=Cancel
    
```

Owner

The name of the owner of the new index.

Name

The name of the new index.

Table owner

The SQLID used to create the table on which the index is being defined.

Table name

The table on which the index is created.

Parttn. Number

A sequential number showing the number of partitions defined. This is a display-only field.

Column Name

The name of the column.

Value

The smallest unit of data that is manipulated in SQL.

Parent panels

- [Create Index panel on page 527](#)

Child panels

None.

Related tasks

- [Creating an index on page 231](#)

Create Index: Type panel

You use the Create Index: Type panel to specify information to define the type of index to be created.

Panel and field definitions

Process	Options	Utilities	Help
FM/Db2 (DFG2)	Create Index Type		
Index Type Options:			
Uniqueness			
1	1. Non-Unique		
2	2. Unique		
3	3. Unique Not Null		
Clustering Index Option:			
Enter '/' to select option			
/	Clustering Index (required for partitioned indexes)		
Non-Partitioned Index:			
Piecesize _____	Multiplier	
		1. K (1024)	
		2. M (1048576)	
		3. G (1073741824)	
(Specify the partitions for a partitioned index using Create Index option 5)			
Command ==>			
F1=Help	F2=Split	F3=Exit	F4=CRetriev F7=Backward F8=Forward
F9=Swap	F10=Actions	F12=Cancel	

1. Non-Unique

Duplicate index values are permitted.

2. Unique

Distinct values for all entries in the index.

3. Unique Not Null

Distinct values for all not null entries in the index.

Clustering Index Option

Enter a "/" to specify a clustering index (CLUSTER keyword).

Piecesize

You can specify a maximum addressability for each piece (data set of a non-partitioning index). The values entered must be powers of 2, and the valid values depend on the multiplier.

- If the multiplier is K, valid values are 2**n between 256 and 67 108 864 inclusive.
- If the multiplier is M, valid values are 2**n between 1 and 66 536 inclusive.
- If the multiplier is G, valid values are 2**n between 1 and 64 inclusive.

Parent panels

- [Create Index panel on page 527](#)

Child panels

None.

Related tasks

- [Creating an index on page 231](#)

Create Procedure panel

You use the Create Procedure panel to create a new procedure.

Panel and field definitions

Process	Options	Utilities	Help
FM/Db2 (DFG2)			Create Procedure
Stored Procedure:			
Schema . . .	_____		+ (optional)
Name	_____		+
Result Sets .	_____		(optional)
Stored Procedure Creation:			
Creation Options			
– 1. Parameters			(optional, usually required)
2. Parameter Types			(optional, define parameters first)
3. Option List			(required)
4. Option List (More)			(optional)
5. Create the Procedure			
Command ==>>			
F1=Help	F2=Split	F3=Exit	F4=Expand
F9=Swap	F10=Left	F11=Right	F12=Cancel
			F7=Backward F8=Forward

Schema

The name of the schema in which the procedure is defined.

Name

The name of the stored procedure.

Result Sets

Specifies the maximum number of dynamic result sets that can be returned by the stored procedure.

Creation Options

Specify the number of the creation option you want to use:

1. Parameters

To specify information to define the parameters for a procedure to be created. Displays the Create Procedure: Parameters panel.

2. Parameter Types

To specify information to define the parameter types in relation to tables or views, and to specify the parameter type. Displays the Create Procedure: Parameter Types panel.

3. Option List

To specify information to define options for the procedure to be created. Displays the Create Procedure: Option List (1/2) panel.

4. Option List (More)

To further specify information to define options for the procedure to be created. Displays the Create Procedure: Option List (2/2) panel.

5. Create the Procedure

When you have finished specifying details for the stored procedure to be created, select this creation option to create the stored procedure.

Parent panels

- [Db2 Object Functions panel on page 604](#)
- [Stored Procedures panel on page 813](#)

Child panels

To display this panel...	Use/do this
Create Procedure: Parameters panel on page 543	Creation option 1
Create Procedure: Parameter Types panel on page 542	Creation option 2
Create Procedure: Option List (1/2) panel on page 539	Creation option 3
Create Procedure: Option List (2/2) panel on page 541	Creation option 4

Related tasks

Create Procedure: Option List (1/2) panel

You use the Create Procedure: Option List (1/2) panel to specify information to define options for the procedure to be created.

Panel and field definitions

Process	Options	Utilities	Help
FM/Db2 (DFG2) Create Procedure Option List (1/2)			
External Name	_____		+ (optional)
Package Collection	_____		+ (optional)
Workload Manager Environment	_____		+ (optional)
Time Limit (CPU units)	_____		(CPU units - optional)
LANGUAGE (Required) SQL Security			
- 1. ASSEMBLE	- 1. Reads SQL Data	- 1. Db2	
2. C	2. No SQL	2. User	
3. COBOL	3. Modifies SQL Data	3. Definer	
4. PL/I	4. Contains SQL		
Parameter Style			
- 1. DB2SQL			
2. General			
3. General with nulls			
Run-time Options (optional)			
_____ +			
Command ==>			
F1=Help	F2=Split	F3=Exit	F4=Expand
F9=Swap	F10=Left	F11=Right	F12=Cancel
	F7=Backward	F8=Forward	

External Name

Name of the MVS™ load module that contains the user-written code to implement the procedure.

Package Collection

Specifies the package collection to be used when the procedure is run. If not specified, the invoking program's package collection is used.

Workload Manager Environment

Specifies the MVS™ workload manager environment in which the procedure is to run.

Time Limit (CPU units)

Limit on processor service units used by a single invocation of the procedure.

Language

Application programming language of the procedure.

SQL

Specifies what type of SQL statements the procedure contains.

Security

Specifies the interaction of the procedure with an external security product.

Parameter Style

1. DB2SQL

Additional parameters containing Db2® information are passed to the procedure.

2. General

Only the parameters on the call statement are passed to the procedure and they cannot be null.

3. General with nulls

A vector of null indicators is passed in addition to the parameters on the call statement.

Parent panels

- [Create Procedure panel on page 538](#)

Child panels

None.

Related tasks

- [Creating a procedure on page 235](#)

Create Procedure: Option List (2/2) panel

You use the Create Procedure: Option List (2/2) panel to further specify information to define options for the procedure to be created.

Panel and field definitions

```

  Process  Options  Utilities  Help
  FM/Db2 (DFG2)          Create Procedure Option List (2/2)

  Enter '/' to select option
  - Main Program
  - Stay Resident
  - Deterministic
  - DBINFO argument passed
  - Commit on return

  Command ==>
  F1=Help      F2=Split      F3=Exit      F4=CRetriev  F7=Backward  F8=Forward
  F9=Swap      F10=Actions   F12=Cancel
  
```

Main Program

If checked, the program runs as a main routine, otherwise it runs as a subroutine.

Stay Resident

If checked, the function load module remains in memory when the function ends.

Deterministic

If checked, indicates the function always returns the same result for the same set of input values.

DBINFO argument passed

If checked, indicates that additional Db2® information is passed when the function is called.

Commit on return

If checked, indicates that Db2® issues a commit when the stored procedure returns.

Parent panels

- [Create Procedure panel on page 538](#)

Child panels

None.

Related tasks

- [Creating a procedure on page 235](#)

Create Procedure: Parameter Types panel

You use the Create Procedure: Parameter Types panel to specify information to define the parameter types in relation to tables or views, and to specify the parameter type.

Panel and field definitions

<u>P</u> rocess	<u>O</u> ptions	<u>U</u> tilities	<u>H</u> elp
FM/Db2 (DFG2)		Create Procedure: Parameter Types	Row 1 to 1 of 1
Parameter Name	+ Data Type(Length)	As LOC <-----Like Table/View----->	IN
PARAM1	CHAR(3)	+ (Y/N) Owner + Name	+ INOUT
***** Bottom of data *****			
Command ==>			Scroll PAGE
F1=Help	F2=Split	F3=Exit	F4=Expand
F9=Swap	F10=Left	F11=Right	F12=Cancel

Parameter Name

The name of the parameter.

Data Type(Length)

The data type of the parameter.

As LOC (Y/N)

For LOB data types, specifies that a locator for the parameter is passed instead of the value itself.

Owner

Defines the parameter as a locator to a transition table.

Like Table/View Name

The owner and name specify a table or view with columns that match those of the transition table.

IN OUT INOUT

Specifies whether the parameter can be used for input only, output only, or both input and output. Valid values are:

IN

Identifies the parameter as an input parameter.

OUT

Identifies the parameter as an output parameter.

INOUT

Identifies the parameter as both an input and output parameter.

Parent panels

- [Create Procedure panel on page 538](#)

Child panels

None.

Related tasks

- [Creating a procedure on page 235](#)

Create Procedure: Parameters panel

You use the Create Procedure: Parameters panel to specify information to define the parameters for a procedure to be created.

For Data

The definitions for character and character large object (CLOB) allow the specification of an optional 'FOR DATA' clause. This field is used to specify the appropriate value.

User Defined Data Type

Specifies the data type of the column is a distinct type (a user defined-data type). The length, precision and scale of the column are respectively the length, precision and scale of the source type of the distinct type. The privilege set must implicitly or explicitly include the USAGE privilege on the distinct type.

Parent panels

- [Create Procedure panel on page 538](#)

Child panels

None.

Related tasks

- [Creating a procedure on page 235](#)

Create Synonym panel

You use the Create Synonym panel to create a new synonym.

Panel and field definitions

<u>P</u> rocess	<u>O</u> ptions	<u>U</u> tilities	<u>H</u> elp
FM/Db2 (DFG2)		Create Synonym	
Synonym Details:			
Name	<u>DBNAME</u>		+
Table or View Details:			
Owner			+
Name	<u>TABLE1</u>		+
Command ==>			
F1=Help	F2=Split	F3=Exit	F4=CRetrieV F7=Backward F8=Forward
F9=Swap	F10=Actions	F12=Cancel	

Name (Synonym Details)

The name of the synonym that is being created.

Owner

The owner of the table.

Name (Table or View Details)

The name of the table.

Parent panels

- [Db2 Object Functions panel on page 604](#)
- [Synonyms panel on page 815](#)

Child panels

None.

Related tasks

- [Creating a synonym on page 233](#)

Create Table panel

You use the Create Table panel to create a new table.

Panel and field definitions

<u>P</u> rocess	<u>O</u> ptions	<u>U</u> tilities	<u>H</u> elp
FM/Db2 (DFG2)		Create Table	
New Table:			
Owner	_____	+	(optional)
Name	<u>TABLE1</u>	_____	+
Database	_____		(optional)
Table Space	_____		(optional)
Model Table/View: (optional)			
Owner	_____	+	
Name	_____	_____	+
Usage:			
<u>1</u>	1. Generate LIKE clause		
	2. Load table information		
Table Creation:			
Creation Options	(Use option 1 before options 2, 4-9)		
<u>1</u>	1. Columns (normally required, invalid with model LIKE)		
	2. Nulls/default values (optional)		
	3. Table options (editproc,validproc,more; optional)		
	4. Unique Constraints (primary/unique keys; optional)		
	5. Referential Constraints (foreign keys; optional)		
	6. Check constraints (optional)		
	7. Procedure exits (optional)		
	8. Generate values (optional)		
	9. Create the table		
Command ==>			
F1=Help	F2=Split	F3=Exit	F4=Expand
F9=Swap	F10=Left	F11=Right	F12=Cancel
	F7=Backward	F8=Forward	

Owner (New Table)

The name of the owner of the new table.

Name (New Table)

The name of the new table.

Database

The name of the database in which the new table is to be created.

Table Space

The name of the table space in which the new table is to be created.

Owner (Model Table/View)

The name of the owner of the model table.

Name (Model Table/View)

The name of the model table.

Creation Options

Specify the number of the creation option you want to use:

1. Columns

To specify information to define the columns for a table to be created. Displays the Create Table: Columns panel.

2. Nulls/default values

To specify information to define the null attributes and default values for the columns of the table. Displays the Create Table: Nulls and Default Values panel.

3. Table options

To specify information to define options for the table you are creating. Displays the Create Table: Options panel.

4. Unique Constraints

To specify information to define a primary key and up to three additional unique keys for the table you are creating. Displays the Create Table: Unique Constraints panel.

5. Referential Constraints

To specify information to define one or more column referential constraints for the table. Displays the Create Table: Column Referential Constraints panel.

6. Check Constraints

To specify information to define column check constraints for the table. Displays either the Create Table: Column Check Constraints panel or the Create Table: Table Check Constraints panel.

7. Procedure exits

To specify information to define procedure exits for the table you are creating. Displays the Create Table: Procedure Exits panel.

8. Generate values

To specify information to define generated values for identity or ROWID columns in the table.
Displays the Create Table: Generate Values panel.

9. Create the table

When you have finished specifying details for the table to be created, select this creation option to create the table.

Parent panels

- [Db2 Object Functions panel on page 604](#)
- [Table Spaces panel on page 834](#)
- [Tables, Views and Aliases panel on page 843](#)

Child panels

To display this panel...	Use/do this
Create Table: Columns panel on page 562	Creation option 1
Create Table: Nulls and Default Values panel on page 568	Creation option 2
Create Table: Options panel on page 571	Creation option 3
Create Table: Unique Constraints panel on page 579	Creation option 4
Create Table: Column Referential Constraints panel on page 561	Creation option 5 ²³
Create Table: Column Check Constraints panel on page 559	Creation option 6
Create Table: Procedure Exits panel on page 573	Creation option 7
Create Table: Generate Values panel on page 565	Creation option 8
Create Table: Model Load panel on page 566	24
Create Table: Columns panel on page 562	23

23. When you select Table Creation option 5 (**Referential Constraints**) on the main Create Table panel, FM/Db2 displays either the Column Referential Constraints panel ([Create Table: Column Referential Constraints panel on page 561](#)) or the Table Referential Constraints panel ([Create Table: Table Referential Constraint panel on page 576](#)). To change from one panel to the other, press the F5 function key.

24. The Create Table Model Load panel is displayed when you:

- Initially specify, or subsequently change, the **Model Table/View** details,
- Select Usage option 2 (**Load table information**), and
- Press Enter.

Related tasks

- [Creating a table on page 221](#)

Create Table Space panel

You use the Create Table Space panel to create a new table space.

Panel and field definitions

<u>P</u> rocess	<u>O</u> ptions	<u>U</u> tilities	<u>H</u> elp
FM/Db2 (DFG2)		Create Table Space	
Table Space Definition:			
Name	_____	(required)	
Database	_____	(optional)	
Buffer pool	_____	(optional: BPn, BP8Kn, BP16Kn, BP32Kn)	
Table Space Creation:			
Creation Options			
<u>1</u>	1. Table space type	(optional, usually needed)	
	2. Table space allocation	(optional, usually needed)	
	3. Data storage options	(optional)	
	4. Locking options	(optional)	
	5. Data sharing options	(optional)	
	6. Partitions	(partitioned table spaces only)	
	7. Create the table space		
Command ==>			
F1=Help	F2=Split	F3=Exit	F4=CRetriev
F9=Swap	F10=Actions	F12=Cancel	F7=Backward F8=Forward

Name

The name of the table space you want to create.

Database

The name of the database in which the table space is to be created.

Buffer pool

The name of the buffer pool to be used for the table space.

Creation Options

Specify the number of the creation option you want to use:

1. Table space type

To specify information to define the type of table space to be created. Displays the Create Table Space: Type panel.

2. Table space allocation

To specify information to define the data set and space allocation for the table space to be created. Displays the Create Table Space: Allocation panel.

3. Data storage options

To specify information to define data storage options for the table space to be created. Displays the Create Table Space: Data Storage Options panel.

4. Locking options

To specify information to define the locking options for the table space to be created. Displays the Create Table Space: Locking Options panel.

5. Data sharing options

To specify information to define the data sharing options for the table space to be created. Displays the Create Table Space: Data Sharing Options panel.

6. Partitions

To specify information to define the partitions for a partitioned table space to be created. Displays the Create Table Space: Define Partitions panel.

7. Create the table space

When you have finished specifying details for the table space to be created, select this creation option to create the table space.

Parent panels

- [Db2 Object Functions panel on page 604](#)
- [Databases panel on page 593](#)
- [Table Spaces panel on page 834](#)

Child panels

To display this panel...	Use/do this
Create Table Space: Type panel on page 558	Creation option 1
Create Table Space: Allocation panel on page 551	Creation option 2
Create Table Space: Data Storage Options panel on page 553	Creation option 3
Create Table Space: Locking Options panel on page 557	Creation option 4
Create Table Space: Data Sharing Options panel on page 552	Creation option 5
Create Table Space: Define Partitions panel on page 555	Creation option 6

Related tasks

- [Creating and dropping Db2 objects on page 203](#)
- [Creating a table space on page 219](#)

Create Table Space: Allocation panel

You use the Create Table Space: Allocation panel to specify information to define the data set and space allocation for the table space to be created.

Panel and field definitions

Process	Options	Utilities	Help
FM/Db2 (DFG2)			Create Table Space: Allocation
Dataset Parameters:			
VCAT name	_____		(for user defined data sets only)
Storage group name . .	_____	+	(only if VCAT name omitted)
Space Requirements (Only if Storage Group Name specified):			
Primary space	_____		KB
Secondary space . .	_____		KB
Free Space and Rows per Data Page:			
Free pages	_____		(0,255 inclusive, default value is 0)
Free space	_____		(0-99 inclusive, default value is 5)
Maximum rows per page	_____		(1-255 inclusive, default value is 255)
Command ==>			
F1=Help	F2=Split	F3=Exit	F4=Expand
F9=Swap	F10=Left	F11=Right	F12=Cancel

VCAT name

Specifies the first data set for the table space is managed by the user.

Storage group name

Specifies Db2@ defines and manages the data sets for the table space.

Primary space

Specifies the minimum primary space allocation for a Db2@ managed data set.

Secondary space

Specifies the minimum secondary space allocation for a Db2@ managed data set.

Free pages

Specifies how often to leave a page of free space when the table space or partition is loaded or reorganized.

Free space

The total amount of unused space in a page.

Maximum rows per page

Specifies the maximum number of rows that Db2@ considers placing on each data page.

Parent panels

- [Create Table Space panel on page 549](#)

Child panels

None.

Related tasks

- [Creating a table space on page 219](#)

Create Table Space: Data Sharing Options panel

You use the Create Table Space: Data Sharing Options panel to specify information to define the data sharing options for the table space to be created.

Panel and field definitions

Process	Options	Utilities	Help												
FM/Db2 (DFG2)	Create Table Space: Data Sharing Options														
Selective Partition Locking: Enter '/' to select option _ Use selective partition locking															
Group Buffer Pool Usage: Write to the Group Buffer Pool _ 1. Changed 2. All 3. System 4. None															
Command ==> <table border="0" style="width: 100%; border-collapse: collapse;"> <tr> <td style="border-right: 1px solid black; padding-right: 10px;">F1=Help</td> <td style="border-right: 1px solid black; padding-right: 10px;">F2=Split</td> <td style="border-right: 1px solid black; padding-right: 10px;">F3=Exit</td> <td style="border-right: 1px solid black; padding-right: 10px;">F4=CRetriev</td> <td style="border-right: 1px solid black; padding-right: 10px;">F7=Backward</td> <td>F8=Forward</td> </tr> <tr> <td style="border-right: 1px solid black; padding-right: 10px;">F9=Swap</td> <td style="border-right: 1px solid black; padding-right: 10px;">F10=Actions</td> <td style="border-right: 1px solid black; padding-right: 10px;">F12=Cancel</td> <td colspan="3"></td> </tr> </table>				F1=Help	F2=Split	F3=Exit	F4=CRetriev	F7=Backward	F8=Forward	F9=Swap	F10=Actions	F12=Cancel			
F1=Help	F2=Split	F3=Exit	F4=CRetriev	F7=Backward	F8=Forward										
F9=Swap	F10=Actions	F12=Cancel													

You can select the following option by entering a "/" in the selection field at the top of the panel:

Selective Partition Locking

See *DB2 for z/OS SQL Reference* for a detailed explanation of selective partition locking, and the software prerequisites.

Group Buffer Pool Usage

1. Changed

When there is inter-Db2 R/W interest on the table space or partition updated pages are written to the group buffer pool. When there is no inter-Db2 R/W interest, the group buffer pool is not used.

2. All

Indicates that pages are to be stored in a cache in the group buffer pool as they are read in from DASD.

3. System

Indicates that only changed system pages within the LOB table space are to be stored in a cache in the group buffer pool.

4. None

Indicates that no pages are to be stored in a cache in the group buffer pool.

Parent panels

- [Create Table Space panel on page 549](#)

Child panels

None.

Related tasks

- [Creating a table space on page 219](#)

Create Table Space: Data Storage Options panel

You use the Create Table Space: Data Storage Options panel to specify information to define data storage options for the table space to be created.

Panel and field definitions

```

Process  Options  Utilities  Help
-----
FM/Db2 (DFG2)  Create Table Space: Data Storage Options

Data Storage Options:
  Enter '/' to select option
  Use data compression
  / Close when not in use
  / Erase data on delete
  / Define dataset now
  / INSERT uses clustering index
  / Track modified pages
  / Log changes to LOB columns

Encoding Method:
  Data Encoding
  - 1. EBCDIC
  - 2. ASCII

Command ==>>
F1=Help      F2=Split      F3=Exit      F4=CRetriev  F7=Backward  F8=Forward
F9=Swap      F10=Actions   F12=Cancel

```

Use data compression

This corresponds to the COMPRESS YES/NO clause. COMPRESS YES means that Db2® stores the data in compressed format.

Close when not in use

This corresponds to the CLOSE YES/NO clause. It relates to how Db2® handles open data sets when the limit for the maximum number of open data sets is reached.

Erase data on delete

This corresponds to the ERASE YES/NO clause of the 'USING' block (see *DB2 for z/OS SQL Reference*). ERASE YES means that Db2® data sets are overwritten with binary zeros when they are dropped (deleted).

Define dataset now

This corresponds to the DEFINE YES/NO clause. DEFINE YES means that Db2® defines the data sets for the table space when the create statement is executed. DEFINE NO means creation is delayed until data is placed in the table space.

INSERT uses clustering index

This corresponds to the MEMBER CLUSTER clause.

Track modified pages

This corresponds to the TRACKMOD YES/NO clause. It relates to a feature where changes to data pages are recorded in the table space map pages. The default setting is TRACKMOD YES. There are restrictions on this clause when LOB is specified.

Log changes to LOB columns

This corresponds to the LOG YES/NO clause. LOG YES can only be specified for a LOB table space.

Data encoding

Covers the encoding method option. For OS/390® systems, the default format is EBCDIC .

EBCDIC

Specifies the encoding scheme.

ASCII

Specifies the encoding scheme.

UNICODE

Specifies the encoding scheme.

Parent panels

- [Create Table Space panel on page 549](#)

Child panels

None.

Related tasks

- [Creating a table space on page 219](#)

Create Table Space: Define Partitions panel

You use the Create Table Space: Define Partitions panel to specify information to define the partitions for a partitioned table space to be created.

Panel and field definitions

<u>P</u> rocess	<u>O</u> ptions	<u>U</u> tilities	<u>H</u> elp							
FM/Db2 (DFG2)	Create Table Space: Define Partitions		Row 1 to 1 of 1							
New Table Space:										
Name										
Database										
Pt. No.	VCAT Name	STOGROUP Name +	Primary Space	Secndry Space	Erase Data	Free Pages	% Free	Use Data Cmpr?	Group BP Caching	Track Mod
1										
***** Bottom of data *****										
Command ==>										
F1=Help	F2=Split	F3=Exit	F4=Expand	F7=Backward	Scroll PAGE					
F9=Swap	F10=Left	F11=Right	F12=Cancel	F8=Forward						

Cmd

Use the following line commands to manipulate the panel rows containing partition information:

I

Insert one new row.

In

Insert *n* new rows.

R

Repeat the current row.

Rn

Repeat the current row *n* times.

D

Delete one row.

Dn

Delete *n* rows.

Pt. No.

Partition number

VCAT Name

This is used to specify user-defined data sets. It is mutually exclusive with a STOGROUP name.

STOGROUP Name

This is used to specify a (Db2®) storage group name. Specifying a storage group name means that Db2® creates the data sets for the partition. It is mutually exclusive with a VCAT name.

Primary Space

This is used to specify the primary space allocation for the partition (in kilobytes).

Secondary Space

This is used to specify the secondary space allocation for the partition (in kilobytes).

Erase Data

This corresponds to the ERASE YES/NO clause in the 'USING' block. ERASE YES means that the data sets associated with the partition are overwritten with binary zeros when the partition is deleted (dropped).

Free Pages

Free pages results in Db2® leaving an empty page every n pages (n is what is specified).

% Free

The value specified here results in Db2® leaving $n\%$ (n is what is specified) of each page free.

Use Data Cmpr?

This corresponds to the COMPRESS NO/YES clause. YES means the data is stored in compressed format.

Group BP Caching

This corresponds to the GBPCACHE clause of the create statement (for each partition). This option only applies in a data sharing environment.

TRACK MOD

Specifies whether Db2® tracks modified pages in the space map pages of the table space or partition. Do not specify TRACKMOD for a LOB table space. For a table space in a TEMP database, Db2® uses TRACKMOD NO regardless of the value specified.

Parent panels

- [Create Table Space panel on page 549](#)

Child panels

None.

Related tasks

- [Creating a table space on page 219](#)

Create Table Space: Locking Options panel

You use the Create Table Space: Locking Options panel to specify information to define the locking options for the table space to be created.

Panel and field definitions

<u>P</u> rocess	<u>O</u> ptions	<u>U</u> tilities	<u>H</u> elp
FM/Db2 (DFG2)	Create Table Space: Locking Options		
Locking Options:			
Locksize parameter			
– 1. ANY	Db2 determines the appropriate lock size		
2. Table space	segmented table spaces only		
3. Table	not for LOB table spaces		
4. Page	not for LOB table spaces		
5. Row	only for LOB table spaces		
6. LOB			
Application Locking:			
Maximum Locks _____ (SYSTEM (default) or 0-2147483647)			
Command ==>			
F1=Help	F2=Split	F3=Exit	F4=CRetrie v F7=Backward F8=Forward
F9=Swap	F10=Actions	F12=Cancel	

Locksize parameter

Specify the LOCKSIZE parameter:

1. ANY

Specifies Db2® can use any lock size.

2. Table space

Specifies Db2® can use table space lock.

3. Table

Specifies Db2® can use table locks.

4. Page

Specifies Db2® can use page locks.

5. Row

Specifies Db2® can use row locks.

6. LOB

Specifies Db2® can use LOB locks.

Maximum Locks

The maximum number of page, row, or LOB locks an application process can hold simultaneously in the table space. Valid values are: 0–2147483647 or “SYSTEM”.

Parent panels

- [Create Table Space panel on page 549](#)

Child panels

None.

Related tasks

- [Creating a table space on page 219](#)

Create Table Space: Type panel

You use the Create Table Space: Type panel to specify information to define the type of table space to be created.

Panel and field definitions

Process	Options	Utilities	Help
FM/Db2 (DFG2)			Create Table Space: Type
Table Space Type Option			
<u>1</u>	1. Normal		(default)
	2. Large		(not valid if a partition size is specified)
	3. LOB		(large object table space)
Select either non-partitioned or partitioned below			
Non-Partitioned Table Space:			
	Segment size	___	KB (4,8,..,64 for segmented table space)
Partitioned Table Space:			
	No. of partitions . . .	_____	(1-254 for partitioned table space)
	Max. partition size . .	___	GB (blank,1,2,4,8,16,32,64)
Command ==>			
F1=Help	F2=Split	F3=Exit	F4=CRetriev F7=Backward F8=Forward
F9=Swap	F10=Actions	F12=Cancel	

Table Space Type Option

Specify the type option:

1. Normal

Identifies the table space is a normal (non-LOB) table space.

2. Large

Identifies that each partition of a partitioned table space has a maximum partition size of 4 GB.

This relates to a deprecated SQL option, therefore it is preferable to use Max. Partition Size. If

Large is specified, then **No. of partitions** must also be specified.

3. LOB (large object)

Identifies the table space as LOB table space. If LOB is specified, neither **Segment size** or **No. of partitions** can be specified.

LOB means Large Object. A LOB table space is used to store data that does not fit within a single table space page. Examples of LOBs might include such things as photographs, video files, or sound files.

Segment size

Indicates that the table space is separated and specifies how many pages are in each segment. This cannot be specified with Large, LOB or either of the partitioned table space options.

No. of partitions

Indicates that the table space is partitioned and specifies the number of partitions. This is required if Large is specified or if Max. partition size is specified with LOB or segment size.

Max. partition size

Indicates that the maximum size of each partition or for LOB table spaces, the maximum size of each data set. This requires the specification of LOB or No. of partitions. This cannot be specified with Large or Segment size.

Parent panels

- [Create Table Space panel on page 549](#)

Child panels

None.

Related tasks

- [Creating a table space on page 219](#)

Create Table: Column Check Constraints panel

You use the Create Table: Column Check Constraints panel to specify information to define column check constraints for the table.

Panel and field definitions

Process	Options	Utilities	Help
FM/Db2 (DFG2)		Create Table: Column Check Constraints	Row 1 to 1 of 1
Owner			+
Name	TAB1		+
Database			
Table Space			
Se1 Column Name	+ Data Type(Length)	+ Constraint Name	+ Check Condition +
COL1	CHAR(3)		
***** Bottom of data *****			
Command ==>			Scroll PAGE
F1=Help	F2=Split	F3=Exit	F4=Expand
F8=Forward	F9=Swap	F10=Left	F11=Right
			F5=Tabcons
			F7=Backward
			F12=Cancel

Sel

Type **s** in this field to display a scrollable panel that use to specify a check condition up to the maximum length permitted by Db2®. See the description for the **Check Condition** entry field.

Column Name

The name of the column in the table you are creating.

Data Type(Length)

The data type and length of the column in the table you are creating.

Constraint Name

The name of the constraint. This is an optional field.

Check Condition

SQL expression defining the column check constraint.

If you need to specify a check condition that is too long to fit in the entry field on the panel, enter **s** in the **Sel** field to display a panel. If a long check condition already exists and you alter the part of the check condition displayed on the Column Check Constraints panel, FM/Db2 displays the same panel that you can use to confirm the changes you have made.



Note: FM/Db2 does not validate the check condition you specify.

Parent panels

- [Create Table panel on page 546](#)

Child panels

None.

Related tasks

- [Creating a table on page 221](#)

Create Table: Column Referential Constraints panel

You use the Create Table: Column Referential Constraints panel to specify information to define one or more column referential constraints for the table.

Panel and field definitions

```

Process  Options  Utilities  Help
-----
FM/Db2 (DFG2)  Create Table: Column Referential Constraints  Row 1 to 1 of 1

Owner  . . . . .
Name   . . . . . TAB1
Database . . . . .
Table Space . . . . .

Column Name      Constrnt <----- Parent Table -----> ON
+ Name  + Owner  + Name          + Column      + DLT
COL1
***** Bottom of data *****

Command ==>
F1=Help      F2=Split    F3=Exit     F4=Expand   F5=Tabcons  F7=Backward
F8=Forward   F9=Swap     F10=Left    F11=Right   F12=Cancel

```

Column Name

The foreign key. This is the column in the table being created that is to be related to an equivalent column (the parent key) in the parent table.

Constrnt Name

Optionally use this field to specify the name of the constraint.

Owner

Optionally use this field to qualify the name of the parent table.

Name

The name of the table containing the parent key. This field is mandatory.

Column

The parent key. Specify the name of the column in the parent table to which you want the foreign key (in **Column Name**) related. The parent key must be a primary or unique key on the parent table. If you leave the **Parent Table Column** field blank, the foreign key is related to the primary key of the parent table.

ON DLT

Determines the type of ON DELETE clause, if any, that FM/Db2 generates in the CREATE TABLE statement.

Valid values are:

(blank)

No ON DELETE clause generated

R

ON DELETE RESTRICT

N

ON DELETE NO ACTION

C

ON DELETE CASCADE

S

ON DELETE SET NULL

Parent panels

- [Create Table panel on page 546](#)

Child panels

None.

Related tasks

- [Creating a table on page 221](#)

Create Table: Columns panel

You use the Create Table: Columns panel to specify information to define the columns for a table to be created.

Panel and field definitions

Process	Options	Utilities	Help
FM/Db2 (DFG2)		Create Table: Columns	Row 1 to 1 of 1
Owner			+
Name	TAB1		+
Database			
Table Space			
<---(For Built in Data Types)----->			
<DEC>			
Cmd	Column Name	+ Data Type	Len Pr Sc Data User-defined Data Type
COL1		CHAR	3
***** Bottom of data *****			
Command ==>			
F1=Help	F2=Split	F3=Exit	F4=Expand
F9=Swap	F10=Left	F11=Right	F12=Cancel
			Scroll PAGE
			F7=Backward
			F8=Forward

Cmd

Line command area. Use the following line commands to manipulate the panel rows containing column information:

In

Insert *n* new rows.

Rn

Repeat the current row *n* times. (See following note.)

Dn

Delete *n* rows.



Note: When you repeat a row, FM/Db2 repeats only the column information shown on this panel and the Nulls and Default Values panel. All other information is cleared.

Column Name

The name of the column.

Data Type

The data type of the column.

Len

The length of the column being defined. Only use this field for columns with a string data type.

Pr, Sc

The precision and scale for numeric data types.

For a decimal number:

- Specify the precision (1–31) in the **Pr** field and the scale (0 to the precision of the number) in the **Sc** field.

For a single-precision floating point number:

- If you have specified a data type of FLOAT, specify the precision (1–21) in the **Pr** field and leave the **Sc** field blank.
- If you have specified a data type of REAL, leave the **Pr** and **Sc** fields blank.

For a double-precision floating point number:

- If you have specified a data type of FLOAT, specify the precision (22–53) in the **Pr** field or leave the **Pr** field blank, and leave the **Sc** field blank.
- If you have specified a data type of DOUBLE, leave the **Pr** and **Sc** fields blank.

For a binary integer, leave the **Pr** and **Sc** fields blank.

For Data

The subtype to be used in the FOR *subtype* DATA clause. Only specify a non-blank value for character string columns with a data type of CHAR, VARCHAR, LONG VARCHAR, or CLOB. Valid values are:

(Blank)

FOR DATA clause not generated.

SBCS (or S)

FOR SBCS DATA clause generated.

MIXED (or M)

FOR MIXED DATA clause generated.

BIT (or B)

FOR BIT DATA clause generated. Do not specify BIT for a CLOB column.

User-defined Data Type

Specifies the data type of the column is a distinct type (a user defined-data type). The length, precision and scale of the column (if applicable) are respectively the length, precision and scale of the source type of the distinct type.

Parent panels

- [Create Table panel on page 546](#)

Child panels

None.

Related tasks

- [Creating a table on page 221](#)

Related references

- [Db2 data types on page 432](#)
- [Create Table: Nulls and Default Values panel on page 568](#)

Create Table: Generate Values panel

You use the Create Table: Generate Values panel to specify information to define generated values for identity or ROWID columns in the table.

Panel and field definitions

<u>P</u> rocess	<u>O</u> ptions	<u>U</u> tilities	<u>H</u> elp
FM/Db2 (DFG2)	Create Table: Generate Values		Row 1 to 1 of 1
Owner			+
Name	TAB1		+
Database			
Table Space			
Column Name	+ Data Type (Length)	Gen (A/D)	As Idty (Y/N)
			Start value
			Incr value
			Caching Option (0=NO CACHE)
COL1	CHAR(3)	-	-
***** Bottom of data *****			
Command ==>			Scroll PAGE
F1=Help	F2=Split	F3=Exit	F4=Expand
F9=Swap	F10=Left	F11=Right	F12=Cancel
			F7=Backward
			F8=Forward

Column Name

The name of the column in the table you are creating for which you want Db2® to create values.

Gen (A/D)

Determines when Db2® generates values for the column. Valid values are:

(blank)

Values not generated for this column.

A

Values always generated for this column when a new row is inserted into the table.

D

Values generated for this column when a new row is inserted unless a value is specified.

As Idty (Y/N)

Identifies whether the column is the identity column for the table (there can be only one).

N (or blank)

Column is not an identity column.

Y

Column is the identity column for the table.

Start value

Starting value for generating identity column values (integer).

Incr value

Interval between consecutive generated identity column values (non-zero integer).

Caching Option

An integer specifying how many preallocated values of the identity column are kept in memory to improve performance. Valid values:

0

Generates a NO CACHE clause.

n

Generates a NO CACHE *n* clause. *n* must be 2 or more.

Parent panels

- [Create Table panel on page 546](#)

Child panels

None.

Related tasks

- [Creating a table on page 221](#)

Create Table: Model Load panel

You use the Create Table: Model Load panel to control what information about a model table is loaded into the ISPF variables and tables used to generate the CREATE TABLE statement. The panel also allows you to specify whether the load is a refresh of the current information, or adds to it.

Panel and field definitions

Process	Options	Utilities	Help
FM/Db2 (DFG2)	Create Table: Model Load		
Press enter to load the selected information for the model table/view, or press PF3 (End) or PF12 (Cancel) to cancel the load.			
Model Table/View:			
Owner	FMUSER		+
Name	MODEL2		+
Model Load Options:			
Enter '/' to load			
/ Basic table information	/ Unique key information	Refresh/Add	
/ Column information	/ Referential constraints	1. Refresh	
/ Primary key information	/ Check constraints	2. Add	
Load single-column referential constraints as			
1. Column referential constraints			
2. Table referential constraints			
Command ==>			
F1=Help	F2=Split	F3=Exit	F4=Expand
F9=Swap	F10=Left	F11=Right	F12=Cancel
		F7=Backward	F8=Forward

Owner

The name of the owner of the model table.

Name

The name of the model table.

Basic table information

Database name, table space name if explicitly defined for the model table, and all the table options values for the model table or view. (See following Note.)

Column information

Column names and data types, and nulls and default values specifications for the model table or view. (See following Note.)

Primary key information

Column order in the primary key of the model table.

Unique key information

Column order for the first three unique keys in the model table.

Referential constraints

Referential constraints for the model table.

Check constraints

Check constraints for the model table.

1. (Refresh)

Discard all current CREATE TABLE information, whether manually entered or from a previous load, and load the new selected information for the model table or view.

2. (Add)

Add the selected type of information for the model table or view to the current information for the new table.



Note: If you select the Add option, you can only select **Basic table information** and **Column information**. FM/Db2 only loads basic table information if the target field is blank.

Load single-column referential constraints as

If the model table has referential constraints, whether you want single-column referential constraints loaded as *column* referential constraints or *table* referential constraints.

1. Column referential constraints

Single-column referential constraints associated with the foreign key column.

2. Table referential constraints

Single-column referential constraints not associated with the foreign key column. (The associated constraint names are kept regardless of the level of the currently connected Db2® system.)

Parent panels

- [Create Table panel on page 546](#)

Child panels

None.

Related tasks

- [Creating a table on page 221](#)

Create Table: Nulls and Default Values panel

You use the Create Table: Nulls and Default Values panel to specify information to define the null attributes and default values for the columns of the table.

Panel and field definitions

<u>P</u> rocess	<u>O</u> ptions	<u>U</u> tilities	<u>H</u> elp
FM/Db2 (DFG2)		Create Table: Nulls and Default Values	Row 1 to 1 of 1
Owner			+
Name	TAB1		+
Database			
Table Space			
Se1 Column Name	+ Data Type(Length)	+ Nulls	Default Value +
COL1	CHAR(3)		
***** Bottom of data *****			
Command ==> _____ Scroll PAGE			
F1=Help	F2=Split	F3=Exit	F4=Expand
F9=Swap	F10=Left	F11=Right	F12=Cancel
			F7=Backward F8=Forward

Owner

The name of the owner of the table.

Name

The name of the table.

Database

The name of the database in which the table is to be created.

Table Space

The name of the table space in which the table is to be created.

Sel

Type s in this field to display a panel that you use to enter a long default value (up to 512 characters) for the column. See the description for the **Default Value** field.

Column Name

The name of the column.

Data Type (Length)

The data type and, where applicable, the length of the column.

Nulls

Determines if the field can contain null values, and the default value (if any) to be used for the column when a row is inserted in the table without explicitly specifying a value for the column. Valid values are:

(blank)

Permit nulls and use null as the default value. No NOT NULL or WITH DEFAULT clause is generated in the CREATE TABLE statement.

For non-identity columns, leaving the **Nulls** field blank and specifying DN are equivalent. For identity columns only, a blank value in the **Nulls** field is equivalent to specifying NN.

NN

Disallow nulls, with no default value. A **NOT NULL** clause is generated in the CREATE TABLE statement.

ND

Disallow nulls, and use the default value in the **Default Value** field or the system-defined non-null default value. A **NOT NULL WITH DEFAULT** clause is generated in the CREATE TABLE statement.

NU

Disallow nulls, and use the value of the user special register at the time of insert or load as the default value. A **NOT NULL WITH DEFAULT USER** clause is generated in the CREATE TABLE statement.

NS

Disallow nulls, and use the SQL authorization ID of the process at the time of insert or load as the default value. A **NOT NULL WITH DEFAULT CURRENT SQLID** clause is generated in the CREATE TABLE statement.

DN

Permit nulls and use null as the default value. A **DEFAULT NULL** clause is generated in the CREATE TABLE statement.

DD

Permit nulls, and use the default value in the **Default Value** field or the system-defined non-null default value. A **WITH DEFAULT** clause is generated in the CREATE TABLE statement.

DU

Permit nulls, and use the value of the user special register at the time of insert or load as the default value. A **WITH DEFAULT USER** clause is generated in the CREATE TABLE statement.

DS

Permit nulls, and use the SQL authorization ID of the process at the time of insert or load as the default value. A **WITH DEFAULT CURRENT SQLID** clause is generated in the CREATE TABLE statement.

Default Value

The value that a column contains when a row is inserted. If you specify a constant, you must specify either ND or DD in the **Nulls** field; otherwise, leave this field blank.

If you need to specify a default value that is too long to fit in the field on the panel, enter **s** in the **Sel** field to display a panel. If a long default value already exists and you alter the part of the value displayed in the **Default Value** field, FM/Db2 displays the same panel that you can use to confirm the changes you have made.

The following points apply to the **Default Value** field:

- In most cases, when you specify a character string as a default value, you do not need to enclose the string in quotation marks. FM/Db2 places quotation marks around unquoted character strings when it generates the SQL.
- You must enclose a character string in quotation marks when the string contains trailing blanks.

Specify "Twenty characters ", as:

```
'Twenty characters '
```

- If the string contains quotation marks, represent each quotation mark with two quotation marks.

Specify "It's Diana's house" as:

```
It''s Diana''s house
```

Specify "Captain Cook sailed on the 'Endeavour'" as:

```
Captain Cook sailed on the ''Endeavour''
```



Note: If the string starts and ends with quotation marks, place the entire string within quotation marks and represent each quotation mark contained within the string with two quotation marks.

Specify "Harry's Practice" as:

```
''Harry''s Practice''
```

- If the data type of the column is a distinct type, specify the default value only (FM/Db2 generates the required casting function for the distinct type). If the distinct type is based on a string data type, enclose the constant within quotation marks.

Parent panels

- [Create Table panel on page 546](#)

Child panels

None.

Related tasks

- [Creating a table on page 221](#)

Create Table: Options panel

You use the Create Table: Options panel to specify information to define options for the table you are creating.

Panel and field definitions

```

  Process  Options  Utilities  Help
  -----
FM/Db2 (DFG2)                Create Table: Options

Processing Options, Internal Identifiers.:
EDITPROC . . . DSN8EAE1          (optional)
VALIDPROC . . . _____      (optional)
OBID value . . _____        (optional)

Audit and Data Storage Options:
  Audit Options                Data Storage Options
  - 1. None (default)          - 1. EBCDIC (default)
  - 2. Changes                  - 2. ASCII
  - 3. All                      - 3. UNICODE

Logging and Table Deletion Options:
  Enter '/' to select option
  - Log data capture changes (default is not to log)
  - Restrict drop of table (default is to allow)

Command ==>
  F1=Help      F2=Split    F3=Exit      F4=CRetriev  F7=Backward  F8=Forward
  F9=Swap      F10=Actions  F12=Cancel
  
```

EDITPROC

If the table you are creating requires an EDITPROC clause, specify the name of the edit procedure here. The default is not to use an EDITPROC clause. An edit procedure transforms data at row level within Db2® before presentation.

VALIDPROC

If the table you are creating requires a VALIDPROC clause, specify the name of the validation procedure here. The default is not to use a VALIDPROC clause. A validation procedure validates data at row level before it is added.

OBID value

Use this field, if necessary, to specify the integer for the OBID clause for the table you are creating. Db2® assigns an (internal) object identifier value to each Db2® object. There are circumstances where it is desirable to specify the value for a Db2® object instead of using the Db2-assigned value. An example is where there are two parallel Db2® subsystems, with the same objects defined in each, and where every matching object has the same OBID value.

Audit Options

Db2® provides 3 auditing options which determine the type of access to the table that causes auditing to be performed:

1. None

No auditing performed. This is the default setting.

2. Changes

Auditing performed when changes are made to the table.

3. All

Auditing performed when the table is accessed.

Data Storage Options

The encoding scheme for string data stored in the table. FM/Db2 uses the selected option when it generates the CCSID clause in the CREATE TABLE statement.

1. EBCDIC

String data encoded using EBCDIC CCSIDs. This is the default setting.

2. ASCII

String data encoded using ASCII CCSIDs.

3. UNICODE

UNICODE string data encoded using UNICODE CCSIDs.

Log data capture changes

Whether additional information is logged for INSERT, UPDATE and DELETE operations.

Slash (/)

FM/Db2 generates a DATA CAPTURE CHANGES clause in the CREATE TABLE statement.

(blank)

FM/Db2 generates a DATA CAPTURE NONE clause in the CREATE TABLE statement. This is the default setting.

Restrict drop of table

Whether the table cannot be dropped. You can use this option to prevent the accidental deletion of tables.

Slash (/)

FM/Db2 generates a WITH RESTRICT ON DROP in the CREATE TABLE statement.

(blank)

FM/Db2 allows the table to be dropped. This is the default setting.

Parent panels

- [Create Table panel on page 546](#)

Child panels

None.

Related tasks

- [Creating a table on page 221](#)

Create Table: Procedure Exits panel

You use the Create Table: Procedure Exits panel to specify information to define procedure exits for the table you are creating.

Panel and field definitions

<u>P</u> rocess	<u>O</u> ptions	<u>U</u> tilities	<u>H</u> elp
FM/Db2 (DFG2)		Create Table: Procedure Exits	Row 1 to 1 of 1
Owner			+
Name	EMP		+
Database			
Table Space			
Column Name	+ Name	+ Parameters	+
COL1			
***** Bottom of data *****			
Command ==>			
F1=Help	F2=Split	F3=Exit	F4=Expand
F9=Swap	F10=Left	F11=Right	F12=Cancel
			Scroll PAGE
			F7=Backward
			F8=Forward

Column Name

The name of the column in the table you are creating.

Name

The program name of the field procedure exit.

Parameters

A list of parameters passed to the field procedure exit when it is called. The list must be comma-delimited and enclosed in parenthesis as required by the SQL syntax.

Parent panels

- [Create Table panel on page 546](#)

Child panels

None.

Related tasks

- [Creating a table on page 221](#)

Create Table: Table Check Constraints panel

You use the Create Table: Table Check Constraints panel to specify information to define table check constraints for the table.

Panel and field definitions

<u>P</u> rocess	<u>O</u> ptions	<u>U</u> tilities	<u>H</u> elp
FM/Db2 (DFG2)	Create Table: Column Check Constraints		Row 1 to 1 of 1
Owner			+
Name	TAB1		+
Database			
Table Space			
Se1 Column Name	+ Data Type(Length)	+ Constraint Name	+ Check Condition
COL1	CHAR(3)		
***** Bottom of data *****			
Command ==>		Scroll PAGE	
F1=Help	F2=Split	F3=Exit	F4=Expand
F8=Forward	F9=Swap	F10=Left	F11=Right
			F5=Tabcons
			F12=Cancel
			F7=Backward

Cmd

Line command area. Use the following line commands to manipulate the panel rows containing table check constraint information:

In

Insert *n* new rows.

Rn

Repeat the current row *n* times.

Dn

Delete *n* rows.

S

Select a row. FM/Db2 displays a scrollable panel that you use to specify a check condition up to the maximum length allowed by Db2®. See the description for the **Check Condition** field.

Constraint Name

The name of the constraint. This is an optional field.

Check Condition

SQL expression defining the table check constraint.

If you need to specify a check condition that is too long to fit in the field on the panel, enter **s** in the **Cmd** field to display a panel. If a long check condition already exists and you alter the part of the check condition displayed on the Table Check Constraints panel, FM/Db2 displays the same panel that you can use to confirm the changes you have made.



Note: FM/Db2 does not validate the check condition you specify.

Parent panels

- [Create Table panel on page 546](#)

Child panels

None.

Related tasks

- [Creating a table on page 221](#)

Create Table: Table Referential Constraint panel

You use the Create Table: Table Referential Constraint panel to specify the foreign key and parent key columns for a table referential constraint.

Panel and field definitions

```

Process  Options  Utilities  Help
-----
FM/Db2 (DFG2)      Create Table: Table Referential Constraint  Row 1 to 1 of 1

Constraint:
Name      . . . . . CON1
Parent Table Owner  . .
Parent Table Name . . . EMP

Order Column Name      Data Type(Length) Parent Key Column
___ COL1                CHAR(3)
***** Bottom of data *****

Command ==> _____ Scroll PAGE
F1=Help      F2=Split      F3=Exit      F7=Backward  F8=Forward  F9=Swap
F12=Cancel
    
```

Name

The name of the constraint.

Parent Table Owner

The name of the parent table owner.

Parent Table Name

The name of the parent table.

Order

Enter **S** or a number to add a column to the foreign key. When you enter **S**, FM/Db2 generates the next highest number for the key. To deselect a column that is already selected, clear the displayed number by overtyping it with spaces.



Note: The actual numbers are not important; FM/Db2 uses their relative order to define the column order for the key.

Column Name

The name of the column in the table you are creating.

Data Type(Length)

The data type of the column in the table you are creating.

Parent Key Column

Specify the name of the column in the parent table that you want to relate to the foreign key column (**Column Name**) you have ordered. If you leave this field blank, FM/Db2 relates the foreign key to the primary key of the parent table.



Note: If you have selected more than one column for the foreign key (by entering **S** or a number in the **Order** field), the corresponding Parent Key Columns must all be blank or all be filled.

Parent panels

- [Create Table: Table Referential Constraints panel on page 577](#)

Child panels

None.

Related tasks

- [Creating a table on page 221](#)

Create Table: Table Referential Constraints panel

You use the Create Table: Table Referential Constraints panel to specify information to define one or more table referential constraints for the table.

Panel and field definitions

Process	Options	Utilities	Help
FM/Db2 (DFG2)	Create Table: Table Referential Constraints		Row 1 to 1 of 1
Constrnt		<----- Parent table ----->	ON
Cmd Name + Foreign key columns...	+ Owner	+ Name	+ DLT
CON1		EMP	-
***** Bottom of data *****			
Command ==>			Scroll PAGE
F1=Help	F2=Split	F3=Exit	F4=Expand
F8=Forward	F9=Swap	F10=Left	F11=Right
			F6=Colcons
			F7=Backward
			F12=Cancel

Cmd

Line command area. Use the following line commands to manipulate the panel rows containing table referential constraint information:

In

Insert *n* new rows.

Rn

Repeat the current row *n* times.

Dn

Delete *n* rows.

S

Select the row and display the Referential Constraint panel.

Constrnt Name

The name of the constraint. This is an optional field.

Foreign key columns...

A list of the columns currently selected as the foreign key for this constraint. FM/Db2 displays only as many columns as fit in the available space.

Parent Table Owner

Optionally use this field to qualify the name of the parent table.

Parent Table Name

The name of the table containing the parent key. This field is mandatory.

ON DLT

See details for the **ON DLT** field as described in [Create Table: Column Referential Constraints panel on page 561](#).

Parent panels

- [Create Table panel on page 546](#)

Child panels

To display this panel...	Use/do this
Create Table: Table Referential Constraint panel on page 576	Enter S in Cmd field

Related tasks

- [Creating a table on page 221](#)

Related references

- [Create Table: Table Referential Constraint panel on page 576](#)

Create Table: Unique Constraints panel

You use the Create Table: Unique Constraints panel to specify information to define a primary key and up to three additional unique keys for the table you are creating.

Panel and field definitions

<u>P</u> rocess	<u>O</u> ptions	<u>U</u> tilities	<u>H</u> elp
FM/Db2 (DFG2)	Create Table: Unique Constraints		Row 1 to 1 of 1
Constraint Names (optional):			
Primary Key .			+
Unique Key 1 .			+
Unique Key 2 .			+
Unique Key 3 .			+
<---- Column Order in Key ---->			
Primary	Unique1	Unique2	Unique3
Column Name			+ Datatype(length)
COL1			CHAR(3)
***** Bottom of data *****			
Command ==>			
F1=Help	F2=Split	F3=Exit	F4=Expand
F9=Swap	F10=Left	F11=Right	F12=Cancel
			Scroll PAGE
			F7=Backward F8=Forward

Primary

If not blank, shows the relative order of the column for the primary key.

Unique1

If not blank, shows the relative order of the column for the first unique key.

Unique2

If not blank, shows the relative order of the column for the second unique key.

Unique3

If not blank, shows the relative order of the column for the third unique key.

Column Name

The name of the column.

Datatype(length)

The data type and, if applicable, the length of the column.

Parent panels

- [Create Table panel on page 546](#)

Child panels

None.

Related tasks

- [Creating a table on page 221](#)

Create Trigger panel

You use the Create Trigger panel to create a new trigger.

Panel and field definitions

Process	Options	Utilities	Help
FM/Db2 (DFG2)		Create Trigger	
Trigger:			
Schema	_____	+ (optional)
Name	_____	+
Trigger Creation:			
Creation Options			
1	1. Details		(required)
	2. Search Conditions		(optional)
	3. SQL Statement		(required)
	4. Create the Trigger		
Command ==>			
F1=Help	F2=Split	F3=Exit	F4=Expand
F9=Swap	F10=Left	F11=Right	F12=Cancel

Schema

Name of schema.

Name

Name of new trigger.

Creation Options

Specify the number of the creation option you want to use:

1. Details

To specify information to define the type of trigger to be created. Displays the Create Trigger: Details panel.

2. Search Conditions

To specify information to define the optional search condition to restrict the execution of the trigger. Displays the Create Trigger: Search Condition panel.

3. SQL statement

To specify SQL statements to be executed when the trigger is activated. displays the Create Trigger: SQL statement panel.

4. Create the Trigger

When you have finished specifying details for the trigger to be created, select this creation option to create the trigger.

Parent panels

- [Db2 Object Functions panel on page 604](#)
- [Triggers panel on page 853](#)

Child panels

To display this panel...	Use/do this
Create Trigger: Details panel on page 582	Creation option 1
Create Trigger: Search Condition panel on page 584	Creation option 2
Create Trigger: SQL statement panel on page 584	Creation option 3

Related tasks

- [Creating a trigger on page 236](#)

Create Trigger: Details panel

You use the Create Trigger: Details panel to specify information to define the type of trigger to be created.

Panel and field definitions

Process	Options	Utilities	Help
FM/Db2 (DFG2)	Create Trigger: Details		
Trigger:			
Order (required)	Type (required)		
- 1. No cascade before	- 1. Insert		
2. After	2. Delete		
	3. Update		
Columns (optional, separate by comma)			+
Trigger Table:			
Owner	_____	+ (optional)	
Name	_____		+
Referencing Old:			
Correlation name .	_____	+ (optional)	
Table identifier .	_____	+ (optional, after trigger)	
Referencing New:			
Correlation name .	_____	+ (optional)	
Table identifier .	_____	+ (optional, after trigger)	
Executed (Required)			
- 1. For each modified row			
2. Once (After Trigger)			
Command ==>			
F1=Help	F2=Split	F3=Exit	F4=Expand
F9=Swap	F10=Left	F11=Right	F12=Cancel
		F7=Backward	F8=Forward

No cascade before

Defines the trigger as a before trigger.

After

Defines the trigger as an after trigger.

Type**Insert**

The trigger is executed when a row is inserted in the trigger table.

Delete

The trigger is executed when a row is deleted from the trigger table.

Update

The trigger is executed when a row is updated from the trigger table.

Columns

Specifies a list of columns to restrict the execution of an update trigger to updates on the specified columns.

Name

Name of the table against which an action causes the trigger to be executed.

Owner

Owner of the trigger table.

Old correlation name

Correlation name used to reference rows as they were before the triggering SQL operation.

New correlation name

Correlation name used to reference rows as they were after the triggering SQL operation.

Old table identifier

Temporary table identifier used to reference the complete set of rows as they were before the SQL operation.

New table identifier

Temporary table identifier used to reference the complete set of rows as they were after the SQL operation.

1. For each modified row

The trigger option is executed for each modified row of the trigger table.

2. Once (After Trigger)

The trigger action is executed only once for the triggering SQL operation.

Parent panels

- [Create Trigger panel on page 580](#)

Child panels

None.

Related tasks

- [Creating a trigger on page 236](#)

Create Trigger: Search Condition panel

You use the Create Trigger: Search Condition panel to specify information to define the optional search condition to restrict the execution of the trigger. You do not need to type the WHEN keyword and enclosing parentheses for the condition; they are added automatically if omitted.

Panel and field definitions

Process	Options	Utilities	Help		
FM/Db2 (DFG2)		Trigger Search Condition			
Search Condition (Optional)					
<hr/>					
<hr/>					
<hr/>					
<hr/>					
<hr/>					
<hr/>					
<hr/>					
<hr/>					
<hr/>					
<hr/>					
<hr/>					
<hr/>					
Command ==>					
F1=Help	F2=Split	F3=Exit	F4=Expand	F7=Backward	F8=Forward
F9=Swap	F10=Left	F11=Right	F12=Cancel		

Search Condition

Freeform entry area for the search condition. The triggered SQL statements are executed only if the search condition evaluates to true or is omitted.

Parent panels

- [Create Trigger panel on page 580](#)

Child panels

None.

Related tasks

- [Creating a trigger on page 236](#)

Create Trigger: SQL statement panel

Panel and field definitions

Process	Options	Utilities	Help
FM/Db2 (DFG2)		Create View	Top of data
View:			
Owner	_____ + (optional)	
Name	_____ +	
Fullselect clause (required)			
_____ +			
_____ +			
Column names (optional, separated by commas)			
_____ +			
_____ +			
With Check Option (Optional):			
Option			
- 1. With Cascaded Check Option			
- 2. With Local Check Option			
Command ==>			
F1=Help	F2=Split	F3=Exit	F4=Expand
F9=Swap	F10=Left	F11=Right	F12=Cancel
		F7=Backward	F8=Forward

Owner

The name of the owner of the view.

Name

The name of the view to be created.

Subselect clause

SQL subselect clause defines the contents of the view.

Column names

A list of column names defining the names of the view columns. Must be specified if the subselect clause result table contains duplicate or unnamed columns. If specified, must contain the same number of columns as the subselect clause result table.

With Check Option

Controls whether or not inserted rows must conform to the view definition.

1. With Cascaded Check Option

Generates WITH CASCADED CHECK OPTION clause.

2. With Local Check Option

Generates WITH LOCAL CHECK OPTION clause.

Parent panels

- [Db2 Object Functions panel on page 604](#)

Child panels

None.

Related tasks

- [Creating a view on page 230](#)

Create View Source Statements panel**Panel and field definitions**

```

  _Process  _Options  _Utilities  _Help
  -----
  FM/Db2 (DFG2)          Create View Source Statements
  Valid primary commands are: BRW - Browse  E - Edit  EX - Edit/Execute
  -----
  create view keistw.v1 (col1, col2 ) as select tbname, tbcreator from sysibm.sys
  ffields

  Command ==>
  F1=Help      F2=Split      F3=Exit      F4=CRetriev  F7=Backward  F8=Forward
  F9=Swap      F10=Actions   F12=Cancel

```

Parent panels

- [Tables, Views and Aliases panel on page 843](#)

Child panels

None.

Related tasks**Data Create Utility panel**

You use the Data Create Utility panel to populate a Db2® table with a specified number of rows of data.

Panel and field definitions

Process	Options	Utilities	Help
FM/Db2 (DFG2)		Data Create Utility	
Db2 Object:			
Location		Database	(optional)
Owner	FMUSER	+ Table space	(optional)
Name	LONGTABLENAMEMORETHAN18CHARS +		
Create Count	1	Number of rows to create	
Template:			
Data set name	_____		
Member	_____		
Processing Options:			
Template usage	Enter "/" , "A"lways to select option		
3 1. Above	- Edit template		
2. Previous	- Batch execution		
3. Generate from table	- Create audit trail (*)		
4. Generate/Replace			
Command '==> _____			
F1=Help	F2=Split	F3=Exit	F4=Expand F7=Backward F8=Forward
F9=Swap	F10=Left	F11=Right	F12=Cancel

Location

The location name for the Db2® object. You can specify a generic name to select from a list. If you enter a value in this field, synonym object names are not recognized or included in the selection list.

Database

The database name for the Db2® object. You can use this field to optionally specify a database to further define the object to be processed. If you enter a value in this field:

- The values displayed in the **Owner** and **Name** selection lists are limited to those values defined within the specified database.
- Synonym names are not recognized or included in the selection list.

Owner

The name of the owner of the object. You can specify a generic name to select from a list. To specify a synonym in the object **Name** field, either leave this field blank, or specify a generic name that includes the current SQLID or specify the current SQLID. Synonyms are not recognized or included on the table selection list if any of the **Table space**, **Database**, or **Location** fields are non-blank.

If the **Translate Db2® object names** option is selected, lowercase characters are converted to uppercase. If this option is not selected, lowercase characters are not converted to uppercase; in this situation, a lowercase owner name such as *“sysibm”* does not match *“SYSIBM”* in the Db2® catalog.

Table space

The table space name for the Db2® object. To further define the object to be processed, you can use this field to optionally specify a table space. If you enter a value in this field:

- The values displayed in the **Owner** and **Name** selection lists are limited to those values defined within the specified table space.
- Synonym names are not recognized, nor included in the selection list.

Name

The name of the object name to be processed. You can specify a generic name to select from a list. To specify a synonym in this field, type the name of the synonym and ensure that the **Owner** field is blank, contains a generic name that includes the current SQLID, or contains the current SQLID. Synonyms are not recognized or included in the table selection list if any of the **Table space**, **Database**, or **Location** fields are non-blank.

If the **Translate Db2® object names** option is selected, lowercase characters are converted to uppercase. If this option is not selected, lowercase characters are not converted to uppercase; in this situation, a lowercase owner name such as *“sysibm”* does not match *“SYSIBM”* in the Db2® catalog.

Create Count

Specify the number of rows you want to create in the Db2® table. This is a required field and must be in the range 1–2147483647. The default is 1.

Data set name

If you are using a specific template to specify the data initialization details, (see option 1 in **Template usage**), specify the name of the template data set. It can be a fully-qualified data set name or a pattern. The name may include a member name or name pattern in parenthesis. If the member is specified here, the associated **Member** field must be empty.

Member

If you specified the name of a partitioned data set (PDS) without including a member name or name pattern in parenthesis in the **Data set name** field, then you can use this field to specify the member name or a member name pattern.

Processing Options

You can use these options to specify which template you want to use for the create process, and whether you want to edit the template before the create process.

Template usage

The Data Create Utility panel provides four options for template processing:

1. Above

Requires that you enter the name of a template data set (and optionally a member name) in the **Template** section of the panel. If you do not specify a member name, or if you specify a pattern, FM/Db2 displays a member selection list. After you have specified the member containing a template, processing continues using this template in place of the automatically-generated template for the table (for a detailed explanation, see Template Usage option 3).

2. Previous

Uses the last (previously used) template for this table.

3. Generate from table

Generates a template based on the information in the Db2® catalog for the specified table. This is the default setting. If you have specified a member name in the **Template** section of the panel, it is ignored. FM/Db2 generates the required template in memory.

4. Generate/Replace

Generates a template based on the information in the Db2® catalog for the specified table, and saves this information in the member specified in the **Db2® Template** section of the panel. If the member already exists, it is replaced. Any prior customization is lost.

You can select the following options by entering a / or an "A":

Edit template

Use to edit the template before creating the data. The default is not selected.

Batch execution

Builds the necessary JCL to perform the Create function in a batch job. The generated JCL is displayed using the ISPF editor, where you can review the JCL and submit the job for batch processing. The default is not selected.

Create audit trail

Controls whether access to Db2® by FM/Db2 is written to the FM/Db2 audit log. This option only appears when SAF-rule controlled auditing is in effect.

FM/Db2 may write audit records to either SMF, or a data set.

When SAF rules are used to control FM/Db2 auditing, the decision to write audit records is based on the Db2® object name being processed, and the current userid (TSO logonid). Therefore auditing may be required when processing one Db2® object, but not another. In addition, it is possible that the auditing requirement cannot be changed for a particular Db2® object; this might be different for another Db2® object, and the requirement may be different for other TSO userids.

If you do not have the authority to change the audit setting when processing a particular Db2® object, FM/Db2 prompts you if you enter the wrong setting. If you do have the authority to set the audit setting for a particular Db2® object, FM/Db2 honors whatever value is specified in this field.

Parent panels

- [Utility Functions panel on page 864](#)

Child panels

To display this panel...	Use/do this
Column Selection/Edit panel on page 485	Select Edit template

Related tasks

- [Populating a Db2 table with data on page 239](#)
- [Specifying a data set and a member name on page 50](#)
- [Selecting options on FM/Db2 panels on page 44](#)
- [Working with templates on page 72](#)
- [SAF-rule controlled auditing on page 69](#)

Database Request Modules panel

You use the Database Request Modules panel to list the DBRMs in the Db2® catalog.

Panel and field definitions

The columns that are displayed include the SEL field and columns of SYSIBM.SYSDBRM.

<u>P</u> rocess	<u>O</u> ptions	<u>U</u> tilities	<u>H</u> elp			
FM/Db2 (DFG2)		Database Request Modules (DBRMs)			Format <u>TABL</u>	
Location:						
SEL	NAME	PDSNAME	TIMESTEX	PLNAME	PLCREATOR	
----	*-----*	*-----*	*-----*	*-----*	*-----*	
	#1-----	#3-----1-----2-----	#18-----1-----	#4-----	#5-----	
****	Top of data	****				
	DSNTIAD DB2V810.DFA2.DBRMLIB.DATA		17A07E9719351199	DSNTIA81	CJUNELL	
****	End of data	****				
Command ==>>						
F1=Help	F2=Zoom	F3=Exit	F4=CRetriev	F5=RFind	F6=RChange	Scroll PAGE
F7=Up	F8=Down	F9=Swap	F10=Left	F11=Right	F12=Cancel	



Note:



1. The system option, **Show all catalog table columns**, affects which columns FM/Db2 displays when you use the Object List utility.
2. You can also customize which columns FM/Db2 displays when you use the Object List utility. For details, see the *File Manager Customization Guide*.

To view other columns on this panel, press the Right function key (F11).

For a complete list of columns, refer to “Db2® catalog tables” in the *DB2 for z/OS SQL Reference* relevant to your version of Db2®.

SEL

Line command area.

For a list of the line commands you can use on this panel, see [Table 22: Object list line commands on page 308](#).

Parent panels

- [Object List Utility panel on page 719](#)
- [Application Plans panel on page 463](#)

Child panels

To display this panel...	Use/do this
(ISPF panel)	Line command B
Details panels on page 618	Line command I
Application Plans panel on page 463	Line command PL
Display Row panel on page 619	Line command ROW
Sort Fields panel on page 804	Primary command SORT

Related tasks

- [Working with object list panels on page 301](#)
- [Using the line command area \(Cmd\) on page 308](#)

Related references

- [SORT primary command on page 941](#)

Database Structure panel

FM/Db2 displays the Database Structure panel if you use the DS line command against an item listed on:

- The [Databases panel on page 593](#), or
- The [Table Spaces panel on page 834](#)

Databases panel

You use the Databases panel to list database object types in the Db2® catalog.

Panel and field definitions

The columns that are displayed include the SEL field and columns of SYSIBM.SYSDATABASE.

Process Options Utilities Help									
FM/Db2 (DFG2) Databases									
Location: Format TABL									
SEL	NAME	CREATOR	STGROUP	BPOOL	DBID	CREATEDBY	TYPEEX	GROUP+	MEMBER
*	*	*	*	*	*	*	*	*	*
----	#1-+-----	#2-+-----	#3-+-----1-	#4-+-----	-----#5	#7-+-----	#20-+-----	#11-+--	
****	Top of data ****								
_____	ABC	SHRIKE2	DDDDDDDDDD	BP0	270	SHRIKE2			
_____	DSN8D81A	CJUNELL	DSN8G810	BP0	259	CJUNELL			
_____	DSN8D81P	CJUNELL	DSN8G810	BP0	260	CJUNELL			
_____	DSNATPDB	CJUNELL	SYSDEFLT	BP0	257	CJUNELL			
_____	DSNDB04	SYSIBM	SYSDEFLT	BP0	4	SYSIBM			
_____	DSNDB06	SYSIBM			6	SYSIBM			
_____	DSNDB07	CJUNELL	SYSDEFLT	BP0	7	CJUNELL	WORKFILE		
_____	DSNRGFDB	CJUNELL	SYSDEFLT	BP0	258	CJUNELL			
_____	DSNRLST	CJUNELL	SYSDEFLT	BP0	256	CJUNELL			
_____	FUNTBDB	SHRIKES	SYSDEFLT	BP8K0	271	SHRIKES			
_____	JLV3D81A	SHRIKES	JLV3G810	BP0	266	SHRIKES			
Command ==>									
F1=Help	F2=Zoom	F3=Exit	F4=CRetrie	F5=RFind	Scroll PAGE				
F7=Up	F8=Down	F9=Swap	F10=Left	F11=Right	F6=RChange				
					F12=Cancel				



Note:

1. The system option, **Show all catalog table columns**, affects which columns FM/Db2 displays when you use the Object List utility.
2. You can also customize which columns FM/Db2 displays when you use the Object List utility. For details, see the *File Manager Customization Guide*.

To view other columns on this panel, press the Right function key (F11).

For a complete list of columns, refer to “Db2® catalog tables” in the *DB2 for z/OS SQL Reference* relevant to your version of Db2®.

SEL

Line command area.

For a list of the line commands you can use on this panel, see [Table 22: Object list line commands on page 308](#).

Parent panels

- [Object List Utility panel on page 719](#)
- [Table Spaces panel on page 834](#)
- [Tables, Views and Aliases panel on page 843](#)
- [Indexes panel on page 697](#)

Child panels

To display this panel...	Use/do this
Alter Database panel on page 444	Line command A
Create Database panel on page 514	Line command CR
Create Table Space panel on page 549	Line command CRS
See Drop panels on page 621	Line command DR
Database Structure panel on page 592	Line command DS
Grant privileges panels on page 689	Line command G
Generate SQL From Db2 Catalog panel on page 686	Line command GEN
Details panels on page 618	Line command I
Recovery Information panel on page 755	Line command ICS
Privileges panels on page 736	Line command P
Revoke privileges panels on page 766	Line command R
Display Row panel on page 619	Line command ROW
Table Spaces panel on page 834	Line command S
Tables, Views and Aliases panel on page 843	Line command T
Indexes panel on page 697	Line command X
Sort Fields panel on page 804	Primary command SORT

Related tasks

- [Working with object list panels on page 301](#)
- [Using the line command area \(Cmd\) on page 308](#)

Related references

- [SORT primary command on page 941](#)

Db2® Browse panel

You use the Db2® Browse panel to enter the name of an object to be browsed. You also use this panel to specify the name of a template that describes a logical view of the object.

Panel and field definitions

Process	Options	Utilities	Help
FM/Db2 (DFG2)			Db2 Browse
Specify the Db2 Object:			
Location	_____	Database	_____ (optional)
Owner	FMUSER	+	Table space _____ (optional)
Name	EMP		_____ +
Start position . . .	1		
Row count	100	Number of rows to browse	
Template:			
Data set name . . .	'FMUSER.TEMPLATE'		
Member	SALARY		
Processing Options:			
Template usage	Enter "/", "A"lways to select option		
3 1. Above	- Edit options		
2. Previous	- Edit template		
3. Generate from table	- Re-edit template		
4. Generate/Replace			
Command ==>			
F1=Help	F2=Split	F3=Exit	F4=Expand F7=Backward F8=Forward
F9=Swap	F10=Left	F11=Right	F12=Cancel

Location

The location name for the Db2® object. You can specify a generic name to select from a list. If you enter a value in this field, synonym object names are not recognized or included in the selection list.

Database

The database name for the Db2® object. You can use this field to optionally specify a database to further define the object to be processed. If you enter a value in this field:

- The values displayed in the **Owner** and **Name** selection lists are limited to those values defined within the specified database.
- Synonym names are not recognized or included in the selection list.

Owner

The name of the owner of the object. You can specify a generic name to select from a list. To specify a synonym in the object **Name** field, either leave this field blank, or specify a generic name that includes the current SQLID or specify the current SQLID. Synonyms are not recognized or included on the table selection list if any of the **Table space**, **Database**, or **Location** fields are non-blank.

If the **Translate Db2® object names** option is selected, lowercase characters are converted to uppercase. If this option is not selected, lowercase characters are not converted to uppercase; in this situation, a lowercase owner name such as “*sysibm*” does not match “*SYSIBM*” in the Db2® catalog.

Table space

The table space name for the Db2® object. To further define the object to be processed, you can use this field to optionally specify a table space. If you enter a value in this field:

- The values displayed in the **Owner** and **Name** selection lists are limited to those values defined within the specified table space.
- Synonym names are not recognized, nor included in the selection list.

Name

The name of the object name to be processed. You can specify a generic name to select from a list. To specify a synonym in this field, type the name of the synonym and ensure that the **Owner** field is blank, contains a generic name that includes the current SQLID, or contains the current SQLID. Synonyms are not recognized or included in the table selection list if any of the **Table space**, **Database**, or **Location** fields are non-blank.

If the **Translate Db2® object names** option is selected, lowercase characters are converted to uppercase. If this option is not selected, lowercase characters are not converted to uppercase; in this situation, a lowercase owner name such as “*sysibm*” does not match “*SYSIBM*” in the Db2® catalog.

Start position

Indicates where FM/Db2 is to begin loading rows from the result table into the FM/Db2 editor.

If you specify a value greater than 1 (the default), FM/Db2 skips n-1 rows of the result table before loading rows into the FM/Db2 editor. If the **Row count** value is `ALL` (or `0` or `*`), when the data is displayed you can scroll up to see the rows that were skipped. For a fixed **Row count** value, you cannot scroll backwards to see any skipped rows.

Row count

Use this option to specify the maximum number of rows to be retrieved from Db2® and loaded into memory for the Browse session. You can specify a value in the range 1–999999999 or, to indicate that all rows are to be retrieved, specify `ALL`, `0`, or `*`. The default value is 100.

A Browse session only applies to those rows fetched from Db2® and loaded into the FM/Db2 editor. It does not apply to any unfetched rows. This means that the `FIND` primary command only applies to those rows fetched from Db2®.



Note: When you are browsing large tables, use the value of `ALL`, `0`, or `*` with caution as it is possible to encounter storage problems. The amount of storage required by the editor depends on both the



number of rows retrieved, and the row length. Use the row selection criteria section of the template to limit the number of rows retrieved.

Data set name

The name of a data set that contains, or will contain, the template. It can be a fully-qualified data set name or a pattern. The name may include a member name or name pattern in parenthesis. If the member is specified here, the associated **Member** field must be empty.

Member

If you specified the name of a partitioned data set (PDS) without including a member name or name pattern in parenthesis in the **Data set name** field, then you can use this field to specify the member name or a member name pattern.

Template usage

The Db2® Browse panel provides four options for template processing:

1. Above

Requires that you enter the name of a template data set (and optionally a member name) in the **Template** section of the panel. If you do not specify a member name, or if you specify a pattern, FM/Db2 displays a member selection list. After you have specified the member containing a template, processing continues using this template in place of the automatically-generated template for the table (for a detailed explanation, see Template Usage option 3).

2. Previous

Uses the last (previously used) template for this table.

3. Generate from table

Generates a template based on the information in the Db2® catalog for the specified table. This is the default setting. If you have specified a member name in the **Template** section of the panel, it is ignored. FM/Db2 generates the required template in memory.

4. Generate/Replace

Generates a template based on the information in the Db2® catalog for the specified table, and saves this information in the member specified in the **Template** section of the panel. If the member already exists, it is replaced. Any prior customization is lost.

You can select this option to change the options for the current editor session:

Edit options

Enter one of these:

A / or an "A"

Displays the first FM/Db2 editor options panel, prior to displaying the data for the Db2® object being processed.

A number in the range 1–8

Displays the *n*th FM/Db2 editor options panel directly where *n* is the value entered.

You can select the following options by entering a / or an "A":

Edit template

Select this option to edit the template before browsing the data.

Re-edit template

Select this option to control the navigation between panels within the Browse dialog. This option controls the behavior of the F3 and F12 keys when pressed from within a Browse session.

Parent panels

- [Table Browse panel on page 824](#) (when BROWSE primary command entered)
- [Table Edit panel on page 826](#) (when BROWSE primary command entered)
- [Table View panel on page 837](#) (when BROWSE primary command entered)
- [Primary Option Menu panel on page 728](#) (when "B" entered on command line)
- [Tables, Views and Aliases panel on page 843](#) (when B line command entered)

Child panels

To display this panel...	Use/do this
Table Browse panel on page 824	No options selected and press Enter
Editor Options (1 of 8) panel on page 625	Select Edit options
Column Selection/Edit panel on page 485	Select Edit template or Re-edit template

Related tasks

- [Viewing and changing Db2 data on page 119](#)
- [Selecting options on FM/Db2 panels on page 44](#)
- [Specifying a data set and a member name on page 50](#)
- [Where you can use templates on page 23](#)
- [Working with templates on page 72](#)
- [View and Edit options \(options 1 and 2\) on page 65](#)

Db2® Edit panel

You use the Db2® Edit panel to enter the name of an object to be edited. You also use this panel to specify the name of a template that describes a logical view of the object.

Panel and field definitions

Process	Options	Help
FM/Db2 (DFG2)		Db2 Edit
Specify the Db2 Object:		
Location	_____	Database . . _____ (optional)
Owner	FMUSER _____ +	Table space _____ (optional)
Name	EMP _____ +	
Start position . . .	1 _____	
Row count	100 _____	Number of rows to edit
Template:		
Data set name . . .	'FMUSER.TEMPLATE' _____	
Member	SALARY _____	
Processing Options:		
Template usage		Enter "/", "A" always to select option
3 1. Above		- Edit options
2. Previous		- Edit template
3. Generate from table		- Re-edit template
4. Generate/Replace		- Create audit trail
Command '==>		
F1=Help	F2=Split	F3=Exit
F4=Expand	F7=Backward	F8=Forward
F9=Swap	F10=Left	F11=Right
F12=Cancel		

Location

The location name for the Db2® object. You can specify a generic name to select from a list. If you enter a value in this field, synonym object names are not recognized or included in the selection list.

Database

The database name for the Db2® object. You can use this field to optionally specify a database to further define the object to be processed. If you enter a value in this field:

- The values displayed in the **Owner** and **Name** selection lists are limited to those values defined within the specified database.
- Synonym names are not recognized or included in the selection list.

Owner

The name of the owner of the object. You can specify a generic name to select from a list. To specify a synonym in the object **Name** field, either leave this field blank, or specify a generic name that includes the current SQLID or specify the current SQLID. Synonyms are not recognized or included on the table selection list if any of the **Table space**, **Database**, or **Location** fields are non-blank.

If the **Translate Db2® object names** option is selected, lowercase characters are converted to uppercase. If this option is not selected, lowercase characters are not converted to uppercase; in this situation, a lowercase owner name such as *“sysibm”* does not match *“SYSIBM”* in the Db2® catalog.

Table space

The table space name for the Db2® object. To further define the object to be processed, you can use this field to optionally specify a table space. If you enter a value in this field:

- The values displayed in the **Owner** and **Name** selection lists are limited to those values defined within the specified table space.
- Synonym names are not recognized, nor included in the selection list.

Name

The name of the object name to be processed. You can specify a generic name to select from a list. To specify a synonym in this field, type the name of the synonym and ensure that the **Owner** field is blank, contains a generic name that includes the current SQLID, or contains the current SQLID. Synonyms are not recognized or included in the table selection list if any of the **Table space**, **Database**, or **Location** fields are non-blank.

If the **Translate Db2® object names** option is selected, lowercase characters are converted to uppercase. If this option is not selected, lowercase characters are not converted to uppercase; in this situation, a lowercase owner name such as *"sysibm"* does not match *"SYSIBM"* in the Db2® catalog.

Start position

Indicates where FM/Db2 is to begin loading rows from the result table into the FM/Db2 editor.

If you specify a value greater than 1 (the default), FM/Db2 skips n-1 rows of the result table before loading rows into the FM/Db2 editor. If the **Row count** value is `ALL` (or `0` or `*`), when the data is displayed you can scroll up to see the rows that were skipped. For a fixed **Row count** value, you cannot scroll backwards to see any skipped rows.

Row count

Use this option to specify the maximum number of rows to be retrieved from Db2® and loaded into memory for the editor session. You can specify a value in the range 1–999999999 or, to indicate that all rows are to be retrieved, specify `ALL`, `0`, or `*`. The default value is 100.

A File Manager/Db2 editor session only applies to those rows fetched from Db2® and loaded into the editor. It does not apply to any unfetched rows. This means that the **FIND** and **CHANGE** primary commands only apply to those rows fetched from Db2®.



Note: When you are editing large tables, use the value of 0 with caution as it is possible to encounter storage problems. The amount of storage required by the editor depends on both the number of rows retrieved, and the row length. Use the row selection criteria section of the template to limit the number of rows retrieved.

Data set name

The name of a data set that contains, or will contain, the template. It can be a fully-qualified data set name or a pattern. The name may include a member name or name pattern in parenthesis. If the member is specified here, the associated **Member** field must be empty.

Member

If you specified the name of a partitioned data set (PDS) without including a member name or name pattern in parenthesis in the **Data set name** field, then you can use this field to specify the member vname or a member name pattern.

Template usage

The Db2® Edit panel provides four options for template processing:

1. Above

Requires that you enter the name of a template data set (and optionally a member name) in the **Template** section of the panel. If you do not specify a member name, or if you specify a pattern, FM/Db2 displays a member selection list. After you have specified the member containing a template, processing continues using this template in place of the automatically-generated template for the table (for a detailed explanation, see Template Usage option 3).

2. Previous

Uses the last (previously used) template for this table.

3. Generate from table

Generates a template based on the information in the Db2® catalog for the specified table. This is the default setting. If you have specified a member name in the **Template** section of the panel, it is ignored. FM/Db2 generates the required template in memory.

4. Generate/Replace

Generates a template based on the information in the Db2® catalog for the specified table, and saves this information in the member specified in the **Template** section of the panel. If the member already exists, it is replaced. Any prior customization is lost.

Edit options

The default is not selected. Select this option to change the options for the current editor session by entering one of the following values:

A / or an "A"

Displays the first FM/Db2 editor options panel, prior to displaying the data for the Db2® object being processed.

A number in the range 1–8

Displays the *n*th FM/Db2 editor options panel directly where *n* is the value entered.

Any options that you set last only for the duration of the current Edit session, and override any conflicting global options. To permanently change the Edit options, select option 0.2.

You can select the following options by entering a / or an "A":

Edit template

Select this option to edit the template before editing the data. The default is not selected.

Re-edit template

Select this option to control the navigation between panels within the Edit dialog. This option controls the behavior of the F3 and F12 keys when pressed from within an Edit session. The default is not selected.

Create audit trail



Note: "*" is appended to the option name for SAF-controlled auditing when required by SAF rules.

Determines if FM/Db2 generates an audit trail report of all successful modifications to Db2® data made during an Edit session:

/

Audit trail report generated.

(blank)

Audit trail report not generated.



Note: The ability to change this option depends on installation options within the Db2® subsystem to which FM/Db2 is connected. The **Create an audit trail** option can be:

- Permanently selected ("/" shown in the option). Audit trail reporting occurs for Edit processing. You cannot change the setting of the option.
- Permanently deselected (blank shown in the option). Audit trail reporting does not occur for Edit processing. You cannot change the setting of the option.
- Optional. Type a "/" in the option to generate audit reporting for all Edit processing; otherwise, type a space in the option to suppress audit trail reporting of any Edit processing.

At the end of your FM/Db2 session, the **Create an audit trail** option that you specify can be saved to your ISPF profile, or it can be set to blank (audit trail report not selected), depending on the installation options within the Db2® subsystem to which FM/Db2 is connected. The audit installation options for the currently connected Db2® system can be determined by selecting option 7 from the HELP pull down menu. When the auditing option is "OPTIONAL, OFF", the Create an audit trail option is always reset to blank (not selected) at the start of a File Manager/Db2 session. This means that, for an audit log to be written, auditing must be explicitly selected each time a new FM/Db2 session is started.

Further, when this option is selected, there is no distinction between the global setting for the audit option, and any value entered using 'edit options' on the Db2® edit panel. For more information, see the *File Manager Customization Guide* or see your systems administrator.

Parent panels

- [Primary Option Menu panel on page 728](#)
- [Tables, Views and Aliases panel on page 843](#)

Child panels

To display this panel...	Use/do this
Table Edit panel on page 826	No options selected and press Enter
Editor Options (1 of 8) panel on page 625	Select Edit options by typing a /, an "A", or "1"
Editor Options (2 of 8) panel on page 630	Select Edit options by typing a "2"
Editor Options (3 of 8) panel on page 634	Select Edit options by typing a "3"
Editor Options (4 of 8) panel on page 641	Select Edit options by typing a "4"
Editor Options (5 of 8) panel on page 645	Select Edit options by typing a "5"
Editor Options (6 of 8) panel on page 649	Select Edit options by typing a "6"
Editor Options (7 of 8) panel on page 652	Select Edit options by typing a "7"
Column Selection/Edit panel on page 485	Select Edit template or Re-edit template

Related tasks

- [Viewing and changing Db2 data on page 119](#)
- [Selecting options on FM/Db2 panels on page 44](#)
- [Specifying a data set and a member name on page 50](#)
- [Where you can use templates on page 23](#)
- [Working with templates on page 72](#)
- [View and Edit options \(options 1 and 2\) on page 65](#)

Db2® Location Selection panel

You use the Db2® Location Selection panel to display all the available remote locations. You can only access remote locations that have been defined to your local Db2® subsystem.

Panel and field definitions

Process	Opti	Db2 Location Selection				Row 1 to 4 of 4
FM/Db2 (DFG2)		Select one of the Db2 locations from the list.				
Specify the Db2		Sel Location	Linkname	LU Name	IP Address	
Location .		- QXPMVS6DB2D	MVS6DB2D	?	?	
Owner . . .		- QXPMVS8DB2D	MVS8DB2D	MVS8DB2D	?	
Name . . .		- QXPMVS8DB26	MVS8DB26	?	?	
		- QXPMVS8DB62	MVS8DB62	MVS8DB62	?	
Template:		***** Bottom of data *****				
Data set nam						
Member . .						
Processing Opti						
Template usa						
1 1. Above						
2. Previo						
3. Genera						
4. Genera						
Command ==>		Command ==>				
F1=Help	F	F1=Help	F2=Split	F3=Exit	F7=Backward	
F9=Swap	F1	F8=Forward	F9=Swap	F12=Cancel		

Parent panels

Asterisk (*) or pattern entered in **Location** field on any FM/Db2 panel (except) Object List Utility.

Child panels

None.

Related tasks

- [Specifying a Db2 object name on page 45](#)
- [Remote Db2 Location Selection panel on page 759](#)

Db2® Object Functions panel

You use the Db2® Object Functions panel to create and drop Db2® objects.

Panel and field definitions

Process	Options	Utilities	Help
FM/Db2 (DFG2)	Db2 Object Functions		
C Create object		D Drop object	
Processing Options:			
Object Type			
—	1. Database	5. Alias	9. Function
	2. Table space	6. Index	10. Stored procedure
	3. Table	7. Synonym	11. Trigger
	4. View	8. Distinct type	12. Auxiliary Table (Create)
Enter "/" to select option			
_ Confirm object drop			
Command ==>>>			
F1=Help	F2=Split	F3=Exit	F4=CRetrieval
F9=Swap	F10=Actions	F12=Cancel	F7=Backward F8=Forward

You can select the following option by entering a "/":

Object Type

Used to specify the type of Db2® object to process. The default is 3 (**Table**).

Confirm object drop

Indicates if you want FM/Db2 to display a confirmation panel each time you enter a DR(op) command against an object

Parent panels

- [Utility Functions panel on page 864](#)

Child panels

To display this panel...	Use/do this
Create Database panel on page 514	Select object type Database and enter <code>c</code>
Create Table Space panel on page 549	Select object type Table space and enter <code>c</code>
Create Table panel on page 546	Select object type Table and enter <code>c</code>
Create View panel on page 585	Select object type View and enter <code>c</code>
Create Alias panel on page 512	Select object type Alias and enter <code>c</code>

To display this panel...	Use/do this
Create Index panel on page 527	Select object type Index and enter <input type="text"/>
Create Synonym panel on page 545	Select object type Syntax and enter <input type="text"/>
Create Distinct Type panel on page 516	Select object type Distinct type and enter <input type="text"/>
Create Function panel on page 521	Select object type Function and enter <input type="text"/>
Create Procedure panel on page 538	Select object type Stored procedure and enter <input type="text"/>
Create Trigger panel on page 580	Select object type Trigger and enter <input type="text"/>
Create Auxiliary Table panel on page 513	Select object type Auxiliary table and enter <input type="text"/>
Select object type Database and enter <input type="text"/>	
Select object type Table space and enter <input type="text"/>	
Select object type Table and enter <input type="text"/>	
Select object type View and enter <input type="text"/>	
Select object type Alias and enter <input type="text"/>	
Select object type Index and enter <input type="text"/>	
Select object type Syntax and enter <input type="text"/>	
Select object type Distinct type and enter <input type="text"/>	
Select object type Function and enter <input type="text"/>	
Select object type Stored procedure and enter <input type="text"/>	
Select object type Trigger and enter <input type="text"/>	

Related tasks

- [Creating and dropping Db2 objects on page 203](#)

Db2® Save Error Action panel

You use the Db2® Save Error Action panel to determine the type of error, and what action you can take, when an error occurs during a File Manager/Db2 Edit session.

Panel and field definitions

```

FM/Db2 (DFG2)          Db2 Save Error Action          Row 1 to 1 of 1
                        Db2 Save Error Action
Db2 reported a No Primary Key error while attempting to save this row.

Relationship      : RPAA                      (See below for key column details)
Parent table     : FMNUSER.ACT
Dependent table  : FMNUSER.PROJACT

Explanation: The insert or update operation on this line would have resulted
in a foreign key value for which there is no corresponding primary key value.

Instructions: Type REDIT on the command line to edit the parent table shown
above. Press Enter or enter EXIT to return to the Edit session and correct
the error. Press the CANCEL key to end the Edit session. Any changes
made since the last commit point are lost.

Parent Column Name  Depndnt Column Name  Value
ACTNO              ACTNO                000999

Command ==>
C  F1=Help          F2=Split      F3=Exit       F7=Backward   Scroll PAGE
   F8=Forward      F9=Swap      F12=Cancel    F6=RChange
                                     12=Cancel

```

Related tasks

- [Example of correcting an error during an Edit session on page 201](#)

Db2® Subsystem Selection panel

You use the Db2® Subsystem Selection menu to select the Db2® subsystem to which you want FM/Db2 to connect.

Panel and field definitions

```

Process  Help
-----
FM/Db2 (DFG1)          Db2 Subsystem Selection          Row 1 of 38
Command ==>          Scroll CSR

Sel SSID Status      Description                      Prefix
-----
- DFG1 ACTIVE       Db2 Version 12 group with DFG1   -DFG1
- DFH1 ACTIVE       Db2 Version 12 group with DFH1   -DFH1
- DF31 ACTIVE       Db2 Version 13.1 - FMD1 DF31     -DF31
- DF11 INACTIVE     Db2 Version 12 - FMD1 DF11       -DF11

F1=Help      F2=Split      F3=Exit      F5=Refresh   F6=Show      F7=Up
F8=Down      F9=Swap      F12=Cancel

```



Note: The Db2® Subsystem Selection panel shown here shows an inactive Db2® subsystem. Your systems administrator might have customized the list so that, for example, only active Db2® subsystems appear. For more information, see your systems administrator or see the *File Manager Customization Guide*.

The fields on the Db2® Subsystem Selection menu are:

Sel

Selection field. Enter **s** or **/** to select the Db2® subsystem shown on that line.

SSID

The subsystem ID. This ID is displayed in the **Db2® SSID** field on the Primary Option Menu and shows to which Db2® subsystem FM/Db2 is currently connected.

Status

Shows status of the Db2® subsystem:

ACTIVE

Db2® system is active and is available for connection.

GROUP

Db2® system is in a Db2® data sharing environment and is available for connection.

INACTIVE

Db2® system is not active and is not available for connection.

UNAVAIL.

FM/Db2 has not been installed on a subsystem or Db2® data sharing group, or FM/Db2 is not available for connection.

Description

The descriptive name of the Db2® subsystem.

Prefix

Command prefix for the Db2® subsystem.

Parent panels

- [Primary Option Menu panel on page 728](#)

Child panels

None.

Related tasks

- [Selecting the Db2 subsystem when more than one is available on page 30](#)

Db2® Template Description panel

You use the Db2® Template Description panel to add a description to the template you are creating or modifying.

Panel and field definitions

```

S          Db2 Template Description          S
F
C  Template
T    Data set . . : SHRIKE2.FM.TEMPLATE(EMP)
-
1  Source
C    Db2 Object : EMP
    Subsystem  : DFG2      Release : 1015
    Created . . . : 2013/08/09 12:40:22
    Modified . . : 2013/09/12 11:59:45
    Description . . _____
                    . _____
                    . _____
                    . _____
                    . _____
C  Command ==>
    F1=Help      F2=Split      F3=Exit      F7=Backward  F8=Forward
    F9=Swap      F12=Cancel

```

Template Data set

The name of the partitioned data set where the template is stored.

Db2® Object

The name of the Db2® object from which the template was built.

Subsystem

The subsystem ID of the Db2® subsystem where the Db2® object resides.

Release

The Db2® version, release, and modification level of the Db2® subsystem on which the object resides.

Created

The date that the template was created from the copybook.

Modified

The date that the template was last modified.

Description

The description of the template. Use this field to enter or modify the description of the template.

Parent panels

- [Column Selection/Edit panel on page 485](#)

Child panels

None.

Related tasks

- [Editing a template on page 81](#)

Db2® Utilities panel

You use the Db2® Utilities panel to generate Db2® utility jobs to copy, load, rebuild, reorganize and collect statistics on Db2® objects.

Panel and field definitions

Process	Options	Utilities	Help
FM/Db2 (DFG2)			Db2 Utilities
Processing Options:			
Db2 Utility:	(valid obj)	Object Type:	Specification:
<u>1</u> 1. COPY	(2,3)	<u>2</u> 1. Tables	<u>1</u> 1. Object name
2. LOAD	(1)	2. Table spaces	2. LISTDEF
3. REBUILD	(4,5)	3. Index spaces	
4. RECOVER	(2,3)	4. Indexes	
5. REORG	(2,4)	5. Indexes for table spaces	
6. RUNSTATS	(2,4)		
7. UNLOAD	(1,2)		
Db2 Object Details: (* for list in any field)			
Database _____		
Table/Index space	. _____		
Table or Index:			
Owner _____ +		
Name _____ +		
LISTDEF Details: (* unavailable)			
LISTDEF name	. . . _____		
Command ==>			
F1=Help	F2=Split	F3=Exit	F4=Expand F7=Backward F8=Forward
F9=Swap	F10=Left	F11=Right	F12=Cancel

The Db2® Utilities panel shows a list of the available utilities on the left side of the “Processing Options” section, and a list of Db2® object types on the right. Each Db2® utility applies to only certain object types. For example, the LOAD utility only applies to Db2® tables. The valid object types for each utility are shown under the heading “Valid Db2® Obj”.

The panel shows a **Specification** section and a **LISTDEF name** field. A selection of LISTDEF means that a LISTDEF name is to be specified as the object of the utility; otherwise, the object name of the type specified in object type is to be specified.

In the **Specification** section, you can select:

1. Object name

The object specified in **Db2® Object Details** is used as the object of the utility. The default is 2 (**Table spaces**).

2. LISTDEF

The name specified in **LISTDEF name** is used as the object of the utility. The default is 1 (**Object name**).

Db2® Utility

Specifies the Db2® utility to be executed. The default is 1 (**Copy**).



Note: The LOAD syntax does not have a LISTDEF clause. If you select LOAD in the **Db2® Utility** section and LISTDEF in the **Specification** section, FM/Db2 issues a warning message.

In the **LISTDEF name** section, if you have specified [2](#) (LISTDEF) in the **Specification** section, specify the name of the LISTDEF you want to use.

You specify the objects to be processed by the Db2® utility at the bottom of the panel.

Database

The name of the database for the object.

Table/Index space

The name of the table space or index space for the object.

Owner

The name of the owner of the table or index for the object.

Name

The name of the table or index for the object.

Parent panels

- [Primary Option Menu panel on page 728](#)
- [Table Spaces panel on page 834](#)
- [Tables, Views and Aliases panel on page 843](#)
- [Indexes panel on page 697](#)

Child panels

To display this panel...	Use/do this
COPY Utility (Table Spaces) panel on page 509	Db2® utility: COPY; object type: Table space; specification: Object name
COPY Utility (Table Spaces) with LISTDEF panel on page 511	Db2® utility: COPY; object type: Table space; specification: LISTDEF
COPY Utility (Index Spaces) panel on page 502	Db2® utility: COPY; object type: Index space; specification: Object name
COPY Utility (Index Spaces) with LISTDEF panel on page 504	Db2® utility: COPY; object type: Index space; specification: LISTDEF

To display this panel...	Use/do this
LOAD Utility panel on page 706	Db2® utility: LOAD; object type: Tables; specification: Object name
LOAD Utility panel using Db2 templates on page 707	Db2® utility: LOAD; object type: Tables; specification: LISTDEF
REBUILD Utility (Indexes) panel on page 745	Db2® utility: REBUILD; object type: Indexes; specification: Object name
REBUILD (Indexes) with LISTDEF panel on page 747	Db2® utility: REBUILD; object type: Indexes; specification: LISTDEF
REBUILD (Indexes for Table Spaces) panel on page 741	Db2® utility: REBUILD; object type: Indexes for Table space; specification: Object name
RECOVER Utility (Table Spaces) panel on page 751	Db2® utility: RECOVER; object type: Table space; specification: Object name
RECOVER Utility (Table Spaces) with LISTDEF panel on page 753	Db2® utility: RECOVER; object type: Table space; specification: LISTDEF
RECOVER Utility (Index Spaces) panel on page 748	Db2® utility: RECOVER; object type: Index spaces; specification: Object name
REORG Utility (Table Spaces) panel on page 763	Db2® utility: REORG; object type: Table space; specification: Object name
REORG Utility (Indexes) panel on page 760	Db2® utility: REORG; object type: Indexes; specification: Object name
REORG Utility (Indexes) with LISTDEF panel on page 761	Db2® utility: REORG; object type: Indexes; specification: LISTDEF
RUNSTATS Utility (Table Spaces) panel on page 775	Db2® utility: RUNSTATS; object type: Table space; specification: Object name

To display this panel...	Use/do this
RUNSTATS Utility (Table Spaces) with LISTDEF panel on page 777	Db2® utility: RUNSTATS; object type: Table space; specification: LISTDEF
RUNSTATS Utility (Indexes) panel on page 772	Db2® utility: RUNSTATS; object type: Indexes; specification: Object name
RUNSTATS Utility (Indexes) with LISTDEF panel on page 774	Db2® utility: RUNSTATS; object type: Indexes; specification: LISTDEF
UNLOAD Utility (Tables) "From" panel on page 860	Db2® utility: UNLOAD; object type: Tables; specification: Object name
UNLOAD Utility (Table Spaces) panel on page 857	Db2® utility: UNLOAD; object type: Table spaces; specification: Object name
UNLOAD Utility (Table Spaces) with LISTDEF panel on page 858	Db2® utility: UNLOAD; object type: Table spaces; specification: LISTDEF

Related tasks

- [Generating batch JCL for Db2 utility jobs on page 339](#)

Db2® View panel

You use the Db2® View panel to enter the name of an object to be edited (but without the ability to save any changes you make). You also use this panel to specify the name of a template that describes a logical view of the object.

Panel and field definitions

Process	Options	Help
FM/Db2 (DFG2)		Db2 View
Specify the Db2 Object:		
Location	_____	Database . . _____ (optional)
Owner	FMUSER + _____	Table space _____ (optional)
Name	EMP _____	+
Start position	1 _____	
Row count	100 _____	Number of rows to edit
Template:		
Data set name	'FMUSER.TEMPLATE' _____	
Member	SALARY _____	
Processing Options:		
Template usage		Enter "/", "A" always to select option
3 1. Above		- Edit options
2. Previous		- Edit template
3. Generate from table		- Re-edit template
4. Generate/Replace		- Create audit trail (*)
Command '==> _____		
F1=Help	F2=Split	F3=Exit
F4=Expand	F7=Backward	F8=Forward
F9=Swap	F10=Left	F11=Right
F12=Cancel		

Location

The location name for the Db2® object. You can specify a generic name to select from a list. If you enter a value in this field, synonym object names are not recognized or included in the selection list.

Database

The database name for the Db2® object. You can use this field to optionally specify a database to further define the object to be processed. If you enter a value in this field:

- The values displayed in the **Owner** and **Name** selection lists are limited to those values defined within the specified database.
- Synonym names are not recognized or included in the selection list.

Owner

The name of the owner of the object. You can specify a generic name to select from a list. To specify a synonym in the object **Name** field, either leave this field blank, or specify a generic name that includes the current SQLID or specify the current SQLID. Synonyms are not recognized or included on the table selection list if any of the **Table space**, **Database**, or **Location** fields are non-blank.

If the **Translate Db2® object names** option is selected, lowercase characters are converted to uppercase. If this option is not selected, lowercase characters are not converted to uppercase; in this situation, a lowercase owner name such as "sysibm" does not match "SYSIBM" in the Db2® catalog.

Table space

The table space name for the Db2® object. To further define the object to be processed, you can use this field to optionally specify a table space. If you enter a value in this field:

- The values displayed in the **Owner** and **Name** selection lists are limited to those values defined within the specified table space.
- Synonym names are not recognized, nor included in the selection list.

Name

The name of the object name to be processed. You can specify a generic name to select from a list. To specify a synonym in this field, type the name of the synonym and ensure that the **Owner** field is blank, contains a generic name that includes the current SQLID, or contains the current SQLID. Synonyms are not recognized or included in the table selection list if any of the **Table space**, **Database**, or **Location** fields are non-blank.

If the **Translate Db2® object names** option is selected, lowercase characters are converted to uppercase. If this option is not selected, lowercase characters are not converted to uppercase; in this situation, a lowercase owner name such as “*sysibm*” does not match “*SYSIBM*” in the Db2® catalog.

Start position

Indicates where FM/Db2 is to begin loading rows from the result table into the FM/Db2 editor.

If you specify a value greater than 1 (the default), FM/Db2 skips n-1 rows of the result table before loading rows into the FM/Db2 editor. If the **Row count** value is `ALL` (or `0` or `*`), when the data is displayed you can scroll up to see the rows that were skipped. For a fixed **Row count** value, you cannot scroll backwards to see any skipped rows.

Row count

Use this option to specify the maximum number of rows to be retrieved from Db2® and loaded into memory for the editor session. You can specify a value in the range 1–999999999 or, to indicate that all rows are to be retrieved, specify `ALL`, `0`, or `*`. The default value is 100.

A File Manager/Db2 editor session only applies to those rows fetched from Db2® and loaded into the editor. It does not apply to any unfetched rows. This means that the **FIND** and **CHANGE** primary commands only apply to those rows fetched from Db2®.



Note: When you are editing large tables, use the value of 0 with caution as it is possible to encounter storage problems. The amount of storage required by the editor depends on both the number of rows retrieved, and the row length. Use the row selection criteria section of the template to limit the number of rows retrieved.

Data set name

The name of a data set that contains, or will contain, the template. It can be a fully-qualified data set name or a pattern. The name may include a member name or name pattern in parenthesis. If the member is specified here, the associated **Member** field must be empty.

Member

If you specified the name of a partitioned data set (PDS) without including a member name or name pattern in parenthesis in the **Data set name** field, then you can use this field to specify the member name or a member name pattern.

Template usage

The Db2® View panel provides four options for template processing:

1. Above

Requires that you enter the name of a template data set (and optionally a member name) in the **Template** section of the panel. If you do not specify a member name, or if you specify a pattern, FM/Db2 displays a member selection list. After you have specified the member containing a template, processing continues using this template in place of the automatically-generated template for the table (for a detailed explanation, see Template Usage option 3).

2. Previous

Uses the last (previously used) template for this table.

3. Generate from table

Generates a template based on the information in the Db2® catalog for the specified table. This is the default setting. If you have specified a member name in the **Template** section of the panel, it is ignored. FM/Db2 generates the required template in memory.

4. Generate/Replace

Generates a template based on the information in the Db2® catalog for the specified table, and saves this information in the member specified in the **Template** section of the panel. If the member already exists, it is replaced. Any prior customization is lost.

You can select this option to change the options for the current editor session:

Edit options

Enter one of these:

A / or an "A"

Displays the first FM/Db2 editor options panel, prior to displaying the data for the Db2® object being processed.

A number in the range 1–8

Displays the *n*th FM/Db2 editor options panel directly where *n* is the value entered.

You can select the following options by entering a / or an "A":

Edit template

Select this option to edit the template before editing the data.

Re-edit template

Select this option to control the navigation between panels within the Edit dialog. This option controls the behavior of the F3 and F12 keys when pressed from within an Edit session.

Create audit trail



Note: "*" is appended to the option name for SAF-controlled auditing when required by SAF rules.

Controls whether access to Db2® by FM/Db2 is written to the FM/Db2 audit log. This option only appears when SAF-rule controlled auditing is in effect.

FM/Db2 may write audit records to either SMF, or a data set.

When SAF rules are used to control FM/Db2 auditing, the decision to write audit records is based on the Db2® object name being processed, and the current userid (TSO logonid). Therefore auditing may be required when processing one Db2® object, but not another. In addition, it is possible that the auditing requirement cannot be changed for a particular Db2® object; this might be different for another Db2® object, and the requirement may be different for other TSO userids.

If you do not have the authority to change the audit setting when processing a particular Db2® object, FM/Db2 prompts you if you enter the wrong setting. If you do have the authority to set the audit setting for a particular Db2® object, FM/Db2 honors whatever value is specified in this field.

Parent panels

- [Primary Option Menu panel on page 728](#)
- [Tables, Views and Aliases panel on page 843](#)

Child panels

To display this panel...	Use/do this
Table View panel on page 837	No options selected and press Enter
Editor Options (1 of 8) panel on page 625	Select Edit options
Column Selection/Edit panel on page 485	Select Edit template or Re-edit template

Related tasks

- [Viewing and changing Db2 data on page 119](#)
- [Selecting options on FM/Db2 panels on page 44](#)
- [Specifying a data set and a member name on page 50](#)
- [Where you can use templates on page 23](#)

- [Working with templates on page 72](#)
- [View and Edit options \(options 1 and 2\) on page 65](#)

Db2I Primary Option Menu panel

You use the Db2I Primary Option Menu panel to interface to Db2® Interactive.

Panel and field definitions

```
COMMAND ===>                Db2I PRIMARY OPTION MENU                SSID: DFA2

Select one of the following Db2 functions and press ENTER.

 1 SPUFI                      (Process SQL statements)
 2 DCLGEN                      (Generate SQL and source language declarations)
 3 PROGRAM PREPARATION        (Prepare a Db2 application program to run)
 4 PRECOMPILE                 (Invoke Db2 precompiler)
 5 BIND/REBIND/FREE          (BIND, REBIND, or FREE plans or packages)
 6 RUN                        (RUN an SQL program)
 7 Db2 COMMANDS              (Issue Db2 commands)
 8 UTILITIES                 (Invoke Db2 utilities)
 D Db2I DEFAULTS            (Set global parameters)
 X EXIT                      (Leave Db2I)

F1=HELP    F2=SPLIT    F3=END    F4=RETURN    F5=RFIND    F6=RCHANGE
F7=UP      F8=DOWN     F9=SWAP   F10=LEFT   F11=RIGHT   F12=RETRIEVE
```

Parent panels

- [Primary Option Menu panel on page 728](#)

Child panels

None.

Related tasks

- [Interfacing with Db2 Interactive on page 430](#)

Details panels

These panels are:

- Database Details panel
- Table Space Details panel
- Table Details panel
- View Details panel

- Index Details panel
- Column Details panel
- Synonym Details panel
- Application Plan Details panel
- Package Details panel
- DBRM Details panel
- Distinct Type Details panel
- Function Details panel
- Procedure Details panel
- Trigger Details panel

FM/Db2 displays one of these panels when you specify the I line command against an object displayed in a list of Db2® objects.

Child panels

None.

Display Row panel

FM/Db2 displays the Display Row panel if you use the ROW line command on any panel where you can use the ROW line command.

Related tasks

Distinct Types panel

You use the Distinct Types panel to list the distinct types in the Db2® catalog.

Panel and field definitions

The columns that are displayed include the SEL field and columns of SYSIBM.SYSDATATYPES.

```

Process  Options  Utilities  Help
-----  -
FM/Db2 (DFG2)                               Distinct Types
Location:                                     Format TABL
                                           +
SEL      SCHEMA  NAME      OWNER    CREATEDBY  SOURCESHEMA  SOURCETYPE  METATYEX
-----  -
---- #1---- #3----- #2---- #4----- #5-----1-- #6----- #18-----1-
**** Top of data ****
----- SHRIKE2 DT1      SHRIKE2  SHRIKE2  SYSIBM    CHAR        Distinct Ty
----- SHRIKES CHAR80  SHRIKE2  SHRIKE2  SYSIBM    CHAR        Distinct Ty
**** End of data ****

Command ==>
F1=Help      F2=Zoom      F3=Exit      F4=CRetriev  F5=RFind     F6=RChange
F7=Up        F8=Down      F9=Swap      F10=Left     F11=Right    F12=Cancel
    
```



Note:

1. The system option, **Show all catalog table columns**, affects which columns FM/Db2 displays when you use the Object List utility.
2. You can also customize which columns FM/Db2 displays when you use the Object List utility. For details, see the *File Manager Customization Guide*.

To view other columns on this panel, press the Right function key (F11).

For a complete list of columns, refer to “Db2® catalog tables” in the *DB2 for z/OS SQL Reference* relevant to your version of Db2®.

SEL

Line command area.

For a list of the line commands you can use on this panel, see [Table 22: Object list line commands on page 308](#).

Parent panels

- [Object List Utility panel on page 719](#)
- [Schemas panel on page 779](#)
- [Functions panel on page 684](#)

Child panels

To display this panel...	Use/do this
See Comment panels on page 493	Line command COM

To display this panel...	Use/do this
Create Distinct Type panel on page 516	Line command CR
See Drop panels on page 621	Line command DR
Grant privileges panels on page 689	Line command G
Generate SQL From Db2 Catalog panel on page 686	Line command GEN
Details panels on page 618	Line command I
Privileges panels on page 736	Line command P
Line command PS	
Revoke privileges panels on page 766	Line command R
Display Row panel on page 619	Line command ROW
Schemas panel on page 779	Line command SCH
Tables, Views and Aliases panel on page 843	Line command T
Sort Fields panel on page 804	Primary command SORT

Related tasks

- [Working with object list panels on page 301](#)
- [Using the line command area \(Cmd\) on page 308](#)

Related references

- [SORT primary command on page 941](#)

Drop panels

These panels are:

- Drop Alias panel
- Drop Database panel
- Drop Distinct Type panel
- Drop Function panel
- Drop Index panel
- Drop Stored Procedure panel
- Drop Synonym Procedure panel
- Drop Table panel
- Drop Table Space panel

- Drop Trigger panel
- Drop View panel

FM/Db2 displays one of these panels when you specify the DR line command against an object displayed in a list of Db2® objects.

You use the appropriate Drop panel when you want to drop a Db2® object.

If you have checked the **Confirm object drop** option on the Db2® Object Functions panel, the Object List Utility panel, or the Explain Utilities panel, before dropping the Db2® object FM/Db2 displays the Drop Confirmation panel.

Child panels

- [Drop Confirmation panel on page 622](#)

Related tasks

- [Dropping Db2 objects on page 238](#)

Drop Confirmation panel

FM/Db2 displays the Drop Confirmation panel when you have specified that you want to drop a Db2® object *and* you have checked the **Confirm object drop** option on the Db2® Object Functions panel or the Explain Utilities panel.

To proceed with the drop, press Enter; to cancel the drop, press the Cancel function key (F12).

Panel and field definitions

```

Process  Options  Utilities  Help
-----
FM/Db2 (DFG2)                Drop Confirmation
Table   : "ADDRESS BOOK"
Instruction:
  Press Enter to confirm drop.
  (The table will be dropped)
  (Warning: All dependent objects will also be dropped.)

  Press CANCEL or EXIT to cancel drop.

  Type SQL to generate the SQL for the drop statement only.

Command ==>
F1=Help      F2=Split    F3=Exit     F4=CRetriev F7=Backward F8=Forward
F9=Swap      F10=Actions F12=Cancel
    
```

Parent panels

- [Db2 Object Functions panel on page 604](#)
- [Db2 Object Functions panel on page 604](#)

Child panels

None.

Related tasks

- [Dropping Db2 objects on page 238](#)

Related references

- [Db2 Object Functions panel on page 604](#)

Edit/Execute SQL (Data Set) panel

You use the Edit/Execute SQL (Data Set) panel to edit and execute SQL statements contained in a data set.

Panel and field definitions

Process	Options	Utilities	Help
FM/Db2 (DFE2)	Edit/Execute SQL (Data Set)		
Input Data Set:			
Data set name	_____		
Member	_____		
Volume	_____		
SELECT statement options:			
Row count	<u>100</u>	Number of rows to browse	
Processing Options:			
Execution options		Enter "/" to select option	
___ First column		/ Edit data set	
___ Last column		/ Execute SQL from data set	
___ Comment chars		- Re-edit data set after execution	
		- Create audit trail (*)	
Command ==> _____			
F1=Help	F2=Split	F3=Exit	F7=Backward F8=Forward F9=Swap
F12=Cancel			

Data set name

The name of the data set or PDS member containing the SQL statements you want to edit. It can be a fully-qualified data set name or a pattern. The name may include a member name or name pattern in parenthesis. If the member is specified here, the associated **Member** field must be empty.

Member

If you specified the name of a partitioned data set (PDS) without including a member name or name pattern in parenthesis in the **Data set name** field, then you can use this field to specify the member name or a member name pattern.

Volume serial

The serial number of the volume that contains the data set (if applicable).

Row count

Limits the rows loaded into the FM/Db2 editor when the SQL statement being processed is a SELECT statement. To load all rows for the SELECT statement, specify "*" or ALL in this field.

First column

First data column. When generating SQL statements, FM/Db2 ignores any data to the left of this column number. If you do not specify a value, the statements are assumed to start in column 1.

Last column

Last data column. When generating SQL statements, FM/Db2 ignores any data to the right of this column number. If you do not specify a value, the statements are assumed to continue to the end of the data set record.

Comment chars

Use this option to specify one or two characters (for example "--") that denote records in the data set that are comment lines. If the specified characters appear as the first nonblank characters in a data set record (and that part of the statement is not in a quoted string), FM/Db2 ignores the record.

Edit data set

FM/Db2 starts an ISPF Edit session for the specified member or data set.

Use this option to use a library of SQL statements that you can maintain ready for execution.

To leave the Edit session, use the Exit function key (F3). Any changes you have made are saved.

Execute SQL from data set

FM/Db2 reads the data set or member, executes the SQL statements that it can extract, returning the results if applicable.

To execute the next SQL statement in the data set or member after FM/Db2 displays a result table or error panel, use the Exit function key (F3).

To return to the Edit and Execute SQL Statements from a Data Set panel without executing the statements, or at any time when an error or result panel has been displayed, use the Cancel function key (F12).

Re-edit data set after execution

After FM/Db2 has completed executing the statements in the data set, it restarts the Edit session (instead of returning to the Edit and Execute SQL Statements from a Data Set panel).

Create audit trail



Note: "*" is appended to the option name for SAF-controlled auditing when required by SAF rules.

Controls whether access to Db2® by FM/Db2 is written to the FM/Db2 audit log. This option only appears when SAF-rule controlled auditing is in effect.

FM/Db2 may write audit records to either SMF, or a data set.

When SAF rules are used to control FM/Db2 auditing, the decision to write audit records is based on the Db2® object name being processed, and the current userid (TSO logonid). Therefore auditing may be required when processing one Db2® object, but not another. In addition, it is possible that the auditing requirement cannot be changed for a particular Db2® object; this might be different for another Db2® object, and the requirement may be different for other TSO userids.

If you do not have the authority to change the audit setting when processing a particular Db2® object, FM/Db2 prompts you if you enter the wrong setting. If you do have the authority to set the audit setting for a particular Db2® object, FM/Db2 honors whatever value is specified in this field.

Parent panels

- [SQL Prototyping, Execution and Analysis panel on page 806](#)

Child panels

None.

Related tasks

- [Editing and executing SQL statements from a data set on page 421](#)
- [Specifying a data set and a member name on page 50](#)
- [SAF-rule controlled auditing on page 69](#)

Editor Options (1 of 8) panel

Use the eight Editor Options panels (1 to 8) to set your default editor options.

If you get to this panel from the Set Processing Options panel or from the action bar, these options are saved in your ISPF profile and persist from one FM/Db2 session to the next.

Otherwise (if you get to this panel by selecting **Edit options** on the Db2® View panel or the Db2® Edit panel), then any changes you make to these options last only for the life of the current FM/Db2 editor session.

Panel and field definitions

Process	Options	Utilities	Help
FM/Db2 (DFG2)		Editor Options (1 of 8)	Global Settings
Display Format:	Initial display format	Editor CAPS Setting:	Enter "/" to select option
1. Previous		/ Initially ON	
2. Table		Audit Option:	Enter "/" to select option
3. Single		/ Create audit trail	
More Options:	Enter "/" to select option		
/ Optimization, large table and data sampling options			
/ Table/Single format, prefix area and shadow options			
/ Key, index and export options			
/ Varying length and nullable column options			
/ Enter key and commit processing options			
/ Concurrency and locking options			
/ XML and LOB column processing options			
Command ==>			
F1=Help	F2=Split	F3=Exit	F7=Backward F8=Forward F9=Swap
F11=NxtPage	F12=Cancel		

Initial display format

Use this section of the Editor Options panel to specify how editor panels appear at the start of a File Manager/Db2 editor session. Set this option to one of the following:

1. Previous

The display format field (**Format**) on the View or Edit panel is prefilled with the value specified in the previous FM/Db2 editor session. This is the default setting.

2. Table

The View or Edit panel is displayed in TABLE display format.

3. Single

The View or Edit panel is displayed in SNGL display format.

Editor CAPS Setting

Indicates the initial setting of CAPS in a File Manager/Db2 editor session and whether you can change the setting. When this option is available for update, the default is not selected.

Initially ON (fixed at installation)

CAPS set to ON. You cannot change the setting by means of the edit options.

Initially OFF (fixed at installation)

CAPS set to OFF. You cannot change the setting by means of the edit options.

Enter "/" to select option ... Initially ON

You can change the CAPS setting:

/

Set CAPS to ON

(blank)

Set CAPS to OFF

Create audit trail

Determines if FM/Db2 generates an audit trail report of all successful modifications to Db2® data made during an Edit session:

/

Audit trail report generated.

(blank)

Audit trail report not generated.

**Note:**

1. The display of this option depends on whether SAF-rule controlled auditing is in effect and if auditing is to occur for the Db2® system. See [SAF-rule controlled auditing on page 69](#).
2. The ability to change this option depends on installation options within the Db2® subsystem to which FM/Db2 is connected. The **Create an audit trail** option can be:
 - Permanently selected (“/” shown in the option). Audit trail reporting occurs for Edit processing. You cannot change the setting of the option.
 - Permanently deselected (blank shown in the option). Audit trail reporting does not occur for Edit processing. You cannot change the setting of the option.
 - Optional. Type a “/” in the option to generate audit reporting for all Edit processing; otherwise, type a space in the option to suppress audit trail reporting of any Edit processing.

At the end of your FM/Db2 session, the **Create an audit trail** option that you specify can be saved to your ISPF profile, or it can be set to blank (audit trail report not selected), depending on the installation options within the Db2® subsystem to which FM/Db2 is connected. The audit installation options for the currently connected Db2® system can be determined by selecting option 7 from the HELP pull down menu. When the auditing option is “*OPTIONAL, OFF*”, the Create an audit trail option is always reset to blank (not selected) at the start of a File Manager/Db2 session. This means that, for an audit log to be written, auditing must be explicitly selected each time a new FM/Db2 session is started. Further, when this option is selected, there is no distinction between the global setting for the audit option, and any value entered using 'edit options' on the Db2® edit panel. For more information, see the *File Manager Customization Guide* or see your systems administrator.

More options

These options control whether FM/Db2 displays the further editor options panels. The default for each option is selected.

The FM/Db2 editor options are too numerous to fit on a single panel. To access additional options, select the fields in this section of the panel.

To navigate to the other options panels, press the PF key assigned to `NxtPage` (PF11 by default). To return to the previous panel, press the PF key assigned to `PrvPage` (PF10 by default).

You can omit the display of one or more of the additional options panels by de-selecting the appropriate field in the "More options" section of the panel.

Optimization, large table and data sampling options

Indicates whether you want the second Editor Options panel displayed when you navigate between Editor Options panels using the `NxtPage` function key (F11) or the `PrvPage` function key (F10).

/

Display the second Editor Options panel

(blank)

Do not display the second Editor Options panel

Table/Single format, prefix area and shadow options

Indicates whether you want the third Editor Options panel displayed when you navigate between Editor Options panels using the `NxtPage` function key (F11) or the `PrvPage` function key (F10).

/

Display the third Editor Options panel

(blank)

Do not display the third Editor Options panel

Key, index and export options

Indicates whether you want the fourth Editor Options panel displayed when you navigate between Editor Options panels using the `NxtPage` function key (F11) or the `PrvPage` function key (F10).

/

Display the fourth Editor Options panel

(blank)

Do not display the fourth Editor Options panel

Varying length and nullable column options

Indicates whether you want the fifth Editor Options panel displayed when you navigate between Editor Options panels using the `NxtPage` function key (F11) or the `PrvPage` function key (F10).

/

Display the fifth Editor Options panel

(blank)

Do not display the fifth Editor Options panel

Enter key and commit processing options

Indicates whether you want the sixth Editor Options panel displayed when you navigate between Editor Options panels using the `NxtPage` function key (F11) or the `PrvPage` function key (F10).

/

Display the sixth Editor Options panel

(blank)

Do not display the sixth Editor Options panel

Concurrency and locking options

Indicates whether you want the seventh Editor Options panel displayed when you navigate between Editor Options panels using the `NxtPage` function key (F11) or the `PrvPage` function key (F10).

/

Display the seventh Editor Options panel

(blank)

Do not display the seventh Editor Options panel

XML and LOB column processing options

Indicates whether you want to display the eighth Editor Options panel when you navigate between Editor Options panels by using the `NxtPage` function key (F11) or the `PrvPage` function key (F10).

/

Display the eighth Editor Options panel

(blank)

Do not display the eighth Editor Options panel

Parent panels

- [Set Processing Options panel on page 795](#)
- [Db2 View panel on page 613](#)
- [Db2 Edit panel on page 598](#)
- [Db2 Browse panel on page 595](#)
- [Action bar pull-down menu on page 436](#)

Child panels

To display this panel...	Use/do this
Editor Options (2 of 8) panel on page 630	Press the NxtPage function key (F11)

Related tasks

- [View and Edit options \(options 1 and 2\) on page 65](#)
- [Setting default processing options on page 60](#)
- [Setting options for the current FM/Db2 editor session on page 123](#)
- [Selecting a display format on page 149](#)
- [Installation settings that affect CAPS on page 176](#)

Editor Options (2 of 8) panel

You use the Editor Options panel (2 of 7) to set your default editor options.



Note: See the description for the Editor Options (1 of 8) panel ([Editor Options \(1 of 8\) panel on page 625](#)) about how long any changes you make to these options last.

Panel and field definitions

Process	Options	Utilities	Help
FM/Db2 (DFG2)	Editor Options (2 of 8)		Global Settings
Optimization Options: Enter "/" to select option _ Use row count value Optimize for . . . 0 _____ Rows		Large Table Options: Scrollable cursor type 1 1. Insensitive 2. Sensitive static	
Data Sampling: Sampling type 1 1. None 2. Clustered sampling 3. Random sampling Sampling limit . . 0 _____		Clustered Sampling: Initial skip count 0 _____ Include count . . . 1 _____ Skip count 0 _____ Random Sampling: Sampling frequency 0.01 _____ Sampling seed . . . 0 _____	
Command ==> _____ F1=Help F2=Split F3=Exit F7=Backward F8=Forward F9=Swap F10=PrvPage F11=NxtPage F12=Cancel			

Use row count value

This option influences Db2® optimization.

When FM/Db2 prepares an SQL statement to access Db2® data, the number of rows in the result table may affect the method used by Db2® to produce the result table. In some cases, Db2® uses a different, more

efficient, access method if it is known that only a few rows of an otherwise very large result table are required. This option enables an additional clause to be added to the SQL statement used by FM/Db2 when accessing Db2®. The OPTIMIZE FOR *nnn* ROWS clause is documented in the *SQL Reference* manual for the appropriate version of Db2®. The default is selected.

Enter a number in the range 0-999999 inclusive. This option and the **Use row count value** option combine in these ways:

Use row count value option selected

The value specified for **Row count** on the editor function entry panel is used, unless ALL (also 0, *) is specified. In the latter case, the **Optimize for** value is considered. A zero value results in no a OPTIMIZE FOR clause. Any other value results in an OPTIMIZE FOR *nnn* ROWS clause being added. *nnn* is the value entered in the **Optimize for** option. The default for the **Optimize for** option is 0.

Use row count value option not selected

The **Optimize for** value is considered. A zero value results in a no OPTIMIZE FOR clause. Any other value results in an OPTIMIZE FOR *nnn* ROWS clause being added. *nnn* is the value entered in the **Optimize for** option

Scrollable cursor type

Controls the access method used by FM/Db2 when processing large Db2® objects.

The FM/Db2 editor can operate in two modes. When there is sufficient memory available, FM/Db2 loads all of the rows for the result table into the editor. For Db2® objects with large result tables, FM/Db2 loads only a small number of rows initially and keeps only a small number of rows in memory during the editor session. This is achieved using Db2® scrollable cursors. The type of cursor specified can influence the behavior of the editor, particularly in edit mode. The default is 1 (**Insensitive**).

1. Insensitive

An insensitive cursor operates like a point-in-time snapshot of the result table. The number of rows in the result table is fixed, and is not changed by insert, update, or delete operations made to the table by other processes. FM/Db2 always uses an insensitive cursor in browse or view modes.

2. Sensitive static

A sensitive static cursor also has a fixed number of rows in the result table, however delete and update operations made using the cursor are reflected the next time the row is processed by the cursor. In addition, update and delete operations made to the underlying table may cause the row to be no longer visible when processed by the cursor.

A sensitive static cursor is only used in edit mode.

Sampling type

Controls whether data sampling is used.

Data sampling enables a subset of the rows in a Db2® object to be loaded into the editor. The default is 1 (**None**). The possible values for this option are:

1. None

All rows of the object are eligible for inclusion, this is the default.

2. Clustered sampling

A specified number of rows are loaded into the editor.

3. Random sampling

Each row of the object is considered for inclusion in the editor. A random number generator and a frequency are used to determine whether the row is actually loaded.

When data sampling is selected, you also need to consider these options:

Sampling limit

For both clustered and random sampling.

Initial skip count

For clustered sampling.

Include count

For clustered sampling.

Skip count

For clustered sampling.

Sampling frequency

For random sampling.

Sampling seed

For random sampling.

Clustered Sampling

Clustered data sampling divides the data into consecutive groups of rows. The number of rows in each group is the sum of these values:

- Initial skip count
- Include count
- (Final) skip count

Within each group, the number of rows specified in **Initial skip count** are ignored. The number of rows in **Include count** are sampled (added to the editor session). Finally, the number of rows specified in the **Skip count** are ignored. Sampling then recommences with the next group of rows.

These options apply only to clustered data sampling. Any values specified are ignored when clustered data sampling is not in use.

Initial skip count

Controls how many rows are initially skipped in each clustered sample group. It can be zero, or a positive integer. The default is 0.

Include count

Controls how many rows are sampled in each clustered sample group. It must be a positive integer. The default is 1.

Skip count

Controls how many rows are skipped at the end of each clustered sample group. It can be zero, or a positive integer. The default is 0.

Random Sampling

Random data sampling uses a random number generator, together with the sampling frequency to determine whether a row is included in the sample. These options apply only to random data sampling. Any values specified are ignored when random data sampling is not in use.

Sampling limit

A value that sets a maximum for the number of rows in the data sample. A zero value indicates that there is no limit on the number of rows in the data sample. The default is 0.

Sampling frequency

Controls the sampling frequency for random data sampling. The default is 0.01.

Enter a value in the range 0.000000001 to 0.999999999 inclusive. To sample approximately 10% of rows enter a frequency of 0.1. To sample approximately 1% of rows enter a frequency of 0.01.

Sampling seed

A value used to initiate the random number generator used for random data sampling. The default is 0.

Enter a integer in the range 0 to 2147483647 inclusive. A zero value indicates that FM/Db2 should use the system clock to initiate the random number generator. Specify a zero value, when repeatability of data samples is not required. Any non-zero value used to initiate the random number generator ensures that data samples are repeatable, given the same table and other input conditions.

Parent panels

You can go to the Editor Options (1 of 8) panel from the *parent* panels shown below. To go to the Editor Options (2 of 8) panel, you then press the NxtPage function key (F11).

- [Set Processing Options panel on page 795](#)
- [Db2 View panel on page 613](#)
- [Db2 Browse panel on page 595](#)

- [Db2 Edit panel on page 598](#)
- [Action bar pull-down menu on page 436](#)

You can only display the Editor Options (2 of 8) panel if the **Optimization, large table and data sampling options** option on the Editor Options (1 of 8) panel is selected.

Child panels

To display this panel...	Use/do this
Editor Options (1 of 8) panel on page 625	Press the PrvPage function key (F10)
Editor Options (3 of 8) panel on page 634	Press the NxtPage function key (F11)

Related tasks

- [View and Edit options \(options 1 and 2\) on page 65](#)
- [Setting default processing options on page 60](#)
- [Setting options for the current FM/Db2 editor session on page 123](#)
- [Data sampling on page 167](#)
- [Large table options on page 167](#)

Editor Options (3 of 8) panel

You use the Editor Options (3 of 8) panel to set your default editor options.



Note: See the description for the Editor Options (1 of 8) panel ([Editor Options \(1 of 8\) panel on page 625](#)) about how long any changes you make to these options last.

Panel and field definitions

<u>P</u> rocess	<u>O</u> ptions	<u>U</u> tilities	<u>H</u> elp
FM/Db2 (DFG2)	Editor Options (3 of 8)		Global Settings
Table Display Format:		Prefix Area:	
Enter "/" to select option		Prefix length . . . A (A,6,7,8,9)	
/ Show data type		Enter "/" to select option	
/ Show scale line		/ Display prefix area	
/ Show column number		- Show prefix area on the right	
		- Show SQLCODE	
Single Display Format:		Shadow Lines:	
Enter "/" to select option		Enter "/" to select option	
- Show data type		/ Show excluded shadow lines	
/ Show keys, indexes			
- Show column number			
- Left justify numerics			
- Show char position range			
Command ==>			
F1=Help	F2=Split	F3=Exit	F7=Backward F8=Forward F9=Swap
F10=PrvPage	F11=NxtPage	F12=Cancel	

Table Display Format Options

Use this section of the Editor Options panel to specify the information you want displayed in table display format (TABL):

Show data type

Indicates if you want FM/Db2 to display data type information. The default is selected.

/

Show the data type for each column displayed in table display format.

FM/Db2 displays an additional line (immediately below the line containing the column reference numbers, if displayed) showing the data type for each column.

(blank)

Do not show data type information.

Show scale line

Indicates if you want FM/Db2 to display scale line information. The default is selected.

/

Show a scale line for each column displayed in table display format.

The scale shows the left and right boundary of the data for the column and, for non-numeric data types, positioning information.

FM/Db2 displays the scale line immediately above the first line of data. The scale line also displays information about primary and foreign keys, and unique indexes.

(blank)

Do not show scale line information.

Show column number

Indicates if you want FM/Db2 to display column number information. The default is selected.

/

Show the column number (as defined in the Db2® catalog) for each column displayed in table display format.

FM/Db2 displays the column numbers immediately below the line containing the column names.

(blank)

Do not show column number information.

Prefix Area

These options controls the prefix area in a File Manager/Db2 editor session.

Prefix length

Controls the width of the prefix area in a File Manager/Db2 editor session.

The FM/Db2 editor can display a prefix area on either the left, or the right of the screen. The width of the prefix area can be 6, 7, 8 or 9 characters. The default is 6, specified by typing A in the field. You can type a different value to set the width of the prefix area to your preference. Note that the prefix area does not appear in a File Manager/Db2 browse session, and only appears in a File Manager/Db2 view or edit session when the **Display prefix area** option is selected. You can alter the prefix length from within an editor session using the PREFIX editor primary command.

Display prefix area

Controls whether the prefix area is displayed in a File Manager/Db2 edit or view session. The default is selected.

The FM/Db2 editor can optionally display a prefix area, where prefix commands may be entered.

/

Display the prefix area.

(blank)

Do not display the prefix area.

You can turn the prefix area on or off from within a File Manager/Db2 editor session (edit and view only) by issuing the PREFIX editor primary command.

Show prefix area on the right

Controls the location of the FM/Db2 editor's prefix area. The default is not selected.

The FM/Db2 editor can display the prefix area on either the left, or the right of the screen.

/

Display the prefix area on the right of the screen.

(blank)

Display the prefix area on the left of the screen.

**Note:**

1. The prefix area does not appear in a File Manager/Db2 browse session.
2. This option has no effect unless the **Display prefix area** option is selected.
3. You can move the prefix area, from within the FM/Db2 editor, by issuing the PREFIX LEFT or PREFIX RIGHT editor primary commands.

Show SQLCODE

Controls whether the FM/Db2 editor shows the SQLCODE in the prefix area, when an insert, update, or delete operation for a row fails. The default is not selected.

FM/Db2 processes changes to data in the edit session one row at a time. If Db2® returns an error when the change is presented to Db2®, FM/Db2 shows either =ERR or an SQLCODE in the prefix area for the row.

/

FM/Db2 editor shows the SQLCODE in the prefix area.

(blank)

FM/Db2 editor shows the =ERR in the prefix area.

Single display Format Options

Use this section of the Editor Options panel to specify the information you want displayed in single display format (SNGL).

Show data type

Indicates if you want FM/Db2 to display data type information. The default is not selected.

/

Show the data type for each column displayed in single display format.

FM/Db2 displays an additional column (immediately to the right of the column containing the name of the column) showing the data type for each column.



Note: When you are displaying data in single display mode, you can toggle the display of data type information by using the TYPE primary command.

(blank)

Do not show data type information.

Show keys, indexes

Indicates if you want FM/Db2 to display information showing if a column is a part of a key or index. The default is selected.

/

Show an additional column, 4 characters wide, indicating if the column is part of a key or index.



Note: When you are displaying data in single display mode, you can toggle the display of index information by using the INDEXINF primary command.

(blank)

Do not show key or index information.

Show column number

Indicates if you want FM/Db2 to display column number information. The default is not selected.

/

Show the column number (as defined in the Db2® catalog) for each column displayed in single display format.

FM/Db2 displays an additional column (the leftmost on the panel) containing the column numbers.



Note:



1. When you are displaying data in single display mode, you can toggle the display of column numbers by using the REFS primary command.
2. In single display mode, when FM/Db2 displays the column number, it also displays the column heading “*Rdf*” (as the second column heading from the left). The “*Rdf*” column is unused by FM/Db2 and can be ignored.

(blank)

Do not show column number information.

Left justify numerics

Indicates if you want FM/Db2 to display numeric data left-justified, in single display format. The default is not selected.

/

Data for numeric columns is displayed left-justified. That is, the first characters of any numbers are shown at the extreme left of the column.

(blank)

Data for numeric columns is displayed right-justified. That is, the data is displayed so that the last character of each number is shown at the extreme right of the column.

Show char position range

Indicates that you want FM/Db2 to show the start and end character positions for long character columns, in SNGL display mode. The default is not selected.

/

When the data for a character column requires two or more rows on the SNGL display, the second and subsequent rows include a character position range, for example, *ssss-nnnn*. *ssss* is the character position of the first character shown in the row. *nnnn* is the character position of the last character shown in the row.

(blank)

The character position range is not shown.

You can toggle the character position on and off from within the editor using the CHARPOS editor primary command.

Show excluded shadow lines

Controls whether a shadow line, which indicates one or more excluded rows, is displayed. The default is selected.

The FM/Db2 editor allows rows to be excluded from display, using the EXCLUDE editor primary command, or the X (and its variations) editor prefix commands. Like the ISPF editor, excluded rows are shown using a shadow line. Each shadow line marks the location of one or more contiguous excluded rows. However, unlike the ISPF editor, the excluded shadow lines can be hidden from display by de-selecting this option.

/

Display excluded shadow lines.

(blank)

Do not display excluded shadow lines.

You can change the display status of excluded rows, from within the FM/Db2 editor, by issuing the SHADOW X OFF or SHADOW X ON commands.

Parent panels

You can go to the Editor Options (1 of 8) panel from the "parent" panels shown below. To go to the Editor Options (3 of 8) panel, you then press the NxtPage function key (F11) twice.

- [Set Processing Options panel on page 795](#)
- [Db2 View panel on page 613](#)
- [Db2 Browse panel on page 595](#)
- [Db2 Edit panel on page 598](#)
- [Action bar pull-down menu on page 436](#)

You can only display the Editor Options (3 of 8) panel if the **Table/Single format, prefix area and shadow options** option on the Editor Options (1 of 8) panel is selected.

Child panels

To display this panel...	Use/do this
Editor Options (2 of 8) panel on page 630	Press the PrvPage function key (F10)
Editor Options (4 of 8) panel on page 641	Press the NxtPage function key (F11)

Related concepts

- [TABL display format on page 150](#)
- [SNGL display format on page 152](#)

Related tasks

- [View and Edit options \(options 1 and 2\) on page 65](#)
- [Setting default processing options on page 60](#)

- [Setting options for the current FM/Db2 editor session on page 123](#)
- [Selecting a display format on page 149](#)
- [Managing the prefix area on page 162](#)
- [Showing or hiding excluded rows on page 161](#)

Editor Options (4 of 8) panel

You use the Editor Options (4 of 8) panel to set your default editor options.



Note: See the description for the Editor Options (1 of 8) panel ([Editor Options \(1 of 8\) panel on page 625](#)) about how long any changes you make to these options last.

Panel and field definitions

<u>P</u> rocess	<u>O</u> ptions	<u>U</u> tilities	<u>H</u> elp
FM/Db2 (DFG2)	Editor Options (4 of 8)		Global Settings
Primary and Foreign Keys, Indexes:			
Enter "/" to select option			
/ Allow updates to primary key			
/ Show primary key			
/ Show foreign key			
/ Show index indicators			
/ Show nullable column indicators			
Export Command:			
Enter "/" to select option			
_ Show export options			
Command ==>>			
F1=Help	F2=Split	F3=Exit	F7=Backward F8=Forward F9=Swap
F10=PrvPage	F12=Cancel		

Allow updates to primary key

Indicates if you can edit the primary key information. The default is selected.

/

Changes to primary key information allowed.

(blank)

Changes to primary key information not allowed.

Show primary key

Indicates if you want FM/Db2 to display primary key information. The default is selected.

/

Include information showing the columns that comprise the primary key for the table.

In table display format, FM/Db2 shows the primary key information only if you have also specified that the scale line is to be displayed (see **Show scale line** in [Editor Options \(3 of 8\) panel on page 634](#)). The scale line shows a “P” in the first position of each column that forms part of the table's primary key.

In single display format, if the **Show keys, indexes** option is selected (see **Show keys, indexes** in [Editor Options \(3 of 8\) panel on page 634](#)), FM/Db2 displays an additional column, immediately to the left of the **Column name** column (and immediately to the right of the **Column number** column, if displayed). This column is 4 characters wide. The presence of a “P” in the first position of the column indicates that the column is part of the table's primary key.

(blank)

Do not include information showing the columns that comprise the primary key for the table.

Show foreign key

Indicates if you want FM/Db2 to display foreign key information. The default is selected.

/

Include information showing the columns that are part of a foreign key.

In table display format, FM/Db2 shows the foreign key information only if you have also specified that the scale line is to be displayed (see [Editor Options \(3 of 8\) panel on page 634](#)). The scale line shows an “F” in the fourth position of each column that forms part of a foreign key.

In single display format, if the **Show keys, indexes** option is selected (see [Editor Options \(3 of 8\) panel on page 634](#)), FM/Db2 displays an additional column, immediately to the left of the **Column name** column (and immediately to the right of the **Column number** column, if displayed). This column is 4 characters wide. The presence of an “F” in the fourth position of the column indicates that the column is part of a foreign key.

(blank)

Do not include information showing the columns that are part of a foreign key.





1. For tables with multiple foreign keys defined, the indicator character cannot be used to distinguish between columns that are part of the same foreign key or part of different foreign keys.
2. The foreign key information is only displayed if it is stored in the template. If the **Retrieve foreign key information when building templates** system option was not selected when the template for the object was built, no foreign key indicators are displayed.

Show index indicators

Indicates if you want FM/Db2 to display index information. The default is selected.

/

Include information showing the columns that are part of an index.

The INCLUDE option of the CREATE INDEX command can be used to append columns to the set of index key columns of a unique index. Such columns form part of the unique index but are not part of the unique index key.

In table display format, FM/Db2 shows the index information only if you have also specified that the scale line is to be displayed (see [Editor Options \(3 of 8\) panel on page 634](#)).

- In the second position of the scale line, a “U” is displayed for each column that forms part of a unique index and part of the unique index key.
- In the second position of the scale line, an “I” is displayed for each column that forms part of a unique index, but is not part of the unique key.
- In the third position of the scale line, an “N” is displayed for each column that forms part of a non-unique index.

See [Table Edit panel on page 826](#).

In single display format, if the **Show keys, indexes** option is selected (see [Editor Options \(3 of 8\) panel on page 634](#)), FM/Db2 displays an additional column, immediately to the left of the **Column name** column (and immediately to the right of the **Column number** column, if displayed). This column is 4 characters wide.

- In the second position of this column, a “U” is displayed for each column that forms part of a unique index and part of the unique index key.
- In the second position of this column, an “I” is displayed for each column that forms part of a unique index, but is not part of the unique key.
- In the third position of this column, an “N” is displayed for each column that forms part of a non-unique index.

(blank)

Do not include information showing the columns that are part of an index.



Note: For tables with multiple foreign keys defined, the indicator character cannot be used to distinguish between columns that are part of the same index or part of different indexes.

Show nullable column indicators

Indicates if you want FM/Db2 to display nullable status for each column. The default is not selected.

/

Include information showing the columns can contain NULL values.

In table display format, FM/Db2 shows the nullable column information only if you have also specified that the scale line is to be displayed (see [Editor Options \(3 of 8\) panel on page 634](#)).

In the first position of the scale line, an **n** is displayed for each column that allows NULL values.

(blank)

Do not include information showing the columns are nullable.



Note: When the column is part of the primary key of the table, the first position will contain a **P** showing the column belongs to PRIMARY KEY. In this situation, the column will always be not nullable.

Show export options

The EXPORT primary command can be issued in a File Manager/Db2 editor session to export data to a external file. Issuing the EXPORT command can optionally display the first of the export options panels, where you can specify the data format for the export operation. The default is not selected.

/

The EXPORT primary command dialog displays the first of the export options panels.

(blank)

The EXPORT primary command dialog does not display the first of the export options panels.

Parent panels

You can go to the Editor Options (1 of 8) panel from the "parent" panels shown below. To go to the Editor Options (4 of 8) panel, you then press the NxtPage function key (F11) three times.

- [Set Processing Options panel on page 795](#)
- [Db2 View panel on page 613](#)
- [Db2 Browse panel on page 595](#)

- [Db2 Edit panel on page 598](#)
- [Action bar pull-down menu on page 436](#)

You can only display the Editor Options (4 of 8) panel if the **Key, index and export options** option on the Editor Options (1 of 8) panel is selected.

Child panels

To display this panel...	Use/do this
Editor Options (3 of 8) panel on page 634	Press the PrvPage function key (F10)
Editor Options (5 of 8) panel on page 645	Press the NxtPage function key (F11)

Related tasks

- [View and Edit options \(options 1 and 2\) on page 65](#)
- [Setting default processing options on page 60](#)
- [Setting options for the current FM/Db2 editor session on page 123](#)
- [Editing related tables on page 188](#)
- [Copying data to a VSAM or QSAM file on page 274](#)

Editor Options (5 of 8) panel

You use the Editor Options (5 of 8) panel to set your default editor options.



Note: See the description for the Editor Options (1 of 8) panel ([Editor Options \(1 of 8\) panel on page 625](#)) about how long any changes you make to these options last.

Panel and field definitions

<u>P</u> rocess	<u>O</u> ptions	<u>U</u> tilities	<u>H</u> elp
FM/Db2 (DFG2)	Editor Options (5 of 8)		Global Settings
Varying Length Columns:			
Enter "/" to select option			
/	Disable input delimiter		String Delimiters:
/	Show end of string		Input #
/	Remove trailing spaces		Display ≤
Columns that allow Null Values:			
Enter "/" to select option			
-	Convert spaces to Db2 null		Null Column Indicators:
			Input @
			Display -
Zoned Timestamp Columns:			
Enter "/" to select option			
/	Auto-size display width		
Command ==>			
F1=Help	F2=Split	F3=Exit	F7=Backward F8=Forward F9=Swap
F10=PrvPage	F12=Cancel		

Disable input delimiter

This option is used to disable processing for the Input string delimiter. By default this option is not selected. When a change is made to a varying field, FM/Db2 scans the entire varying field from left to right, looking for the first occurrence of the Input string delimiter character. If an occurrence is found, the field is truncated at the character before the location of the Input string delimiter. The default is not selected.

Consider disabling the Input string delimiter when:

- The Db2@ object being processed contains VARCHAR fields that cannot be displayed in full, without scrolling. In this situation a change to the field may trigger silent truncation when the input string delimiter is present in a part of the field that is not currently visible on the display.
- A VARCHAR field is used to store data other than readable text, for example binary data, or data that has an internal format. In this situation the data may contain a character that matches the input string delimiter character, leading to unwanted truncation if the data in that field is changed.

Show end of string

This option only applies to the processing of varying-length (VARCHAR) input fields. The default is selected. Specifies if the end of a varying-length string is to be indicated using the delimiter specified in the **String delimiters: Display** option.

/

Show the end of a varying-length string using the delimiter specified in the **String delimiters: Display** option. If the string is of maximum length, the delimiter character is not shown.

(blank)

Do not show the end of a varying-length string.

Remove trailing spaces

This option only applies to the processing of varying-length (VARCHAR) input fields. The default is selected. When you enter a value that is less than the maximum length for the column, determines if FM/Db2 removes trailing spaces:

/

Remove trailing spaces and store the specified value using the minimum length string.

(blank)

Do not remove trailing spaces.

String Delimiters

These options control the end of string delimiter when entering and displaying data in a varying column.

Input

This option only applies to the processing of varying-length (VARCHAR) input fields.

For input, FM/Db2 sets the end-of-string delimiter character to this value. If you enter data that requires one or more trailing spaces in a varying-length field, you can use this option to provide a character of your choice to indicate the end of the string. The default value is the number sign (#).

Valid values: any character.

Display

This option only applies to the processing of varying-length (VARCHAR) input fields. FM/Db2 sets the end-of-string delimiter character, for display, to a this value. If you have also selected **Show end of string**, FM/Db2 displays the value in the field, terminated with the delimiter character you have selected. If the column is of maximum length, the delimiter character is not shown. The default value is the *“less than”* sign (<).

Valid values: any character.

Convert spaces to Db2® null

When any column that allows null values is changed so that it contains only spaces, the value of the column is set to null.

If the column is defined as NOT NULL, the column remains unchanged. The default is not selected.

Null Column Indicators

These options allow the specification of characters to represent the Db2® null value when entering and displaying data.

Input

A single character which, when entered in the first byte of an input field, causes FM/Db2 to update the value for the column to NULL. The default value is the "at" symbol (@).

Valid values: any character

If the column allows null values, when you enter this character in the first byte of the input field, FM/Db2 updates the value for the column to NULL. Any non-blank character following the indicator invalidates the action.

If the column is defined as NOT NULL, FM/Db2 treats the character in the same way as any other input character.

Display

A single character indicating that the column contains a null value (as opposed to, for example, blanks). The default value is the underscore character "_".

Valid values: any character

Auto-size display width

An option that modifies the default display width for applicable columns in TABL display mode. The option applies to zoned timestamp columns only. The default is selected.

This option is only applicable when a Db2® system that supports zoned timestamp data types is connected. Zoned timestamps were first included with Db2® version 10.

/

Allows FM/Db2 to automatically adjust the display width for zoned timestamp columns to that needed to display the data.

(blank)

FM/Db2 shows zoned timestamp columns with a field width in the range 147 - 160 characters. Most of the data displayed will be blank, because the maximum required display width for a zoned timestamp excluding the use of exits and field procs is 39 characters.

Parent panels

You can go to the Editor Options (1 of 8) panel from the "parent" panels shown below. To go to the Editor Options (5 of 8) panel, you then press the NxtPage function key (F11) four times.

- [Set Processing Options panel on page 795](#)
- [Db2 View panel on page 613](#)
- [Db2 Browse panel on page 595](#)
- [Db2 Edit panel on page 598](#)
- [Action bar pull-down menu on page 436](#)

You can only display the Editor Options (5 of 8) panel if the **Varying length and nullable column options** option on the Editor Options (1 of 8) panel is selected.

Child panels

To display this panel...	Use/do this
Editor Options (4 of 8) panel on page 641	Press the PrvPage function key (F10)
Editor Options (6 of 8) panel on page 649	Press the NxtPage function key (F11)

Related tasks

- [View and Edit options \(options 1 and 2\) on page 65](#)
- [Setting default processing options on page 60](#)
- [Setting options for the current FM/Db2 editor session on page 123](#)
- [Varying-length columns on page 174](#)
- [Null values and VARCHAR processing on page 174](#)

Editor Options (6 of 8) panel

You use the Editor Options (6 of 8) panel to set your default editor options.



Note: See the description for the Editor Options (1 of 8) panel ([Editor Options \(1 of 8\) panel on page 625](#)) about how long any changes you make to these options last.

Panel and field definitions

<u>P</u> rocess	<u>O</u> ptions	<u>U</u> tilities	<u>H</u> elp
FM/Db2 (DFG2)	Editor Options (6 of 8)		Global Settings
Enter Key Processing:			
Enter key usage			
<u>1</u> 1. No action 2. Save data 3. Save data and commit changes			
Commit Options:			
Enter "/" to select option			
/ Commit when save issued - Commit when no save errors			
Auto Commit (Changes):			
Auto-commit count 0 _____			
Command ==>			
F1=Help	F2=Split	F3=Exit	F7=Backward F8=Forward F9=Swap
F10=PrvPage	F12=Cancel		

Enter key usage

Set this option to one of the following:

1. No action

This is the default setting. No special action is taken when the Enter key is pressed and no other operations are pending. Any changes made during an Edit session are only presented to Db2® when an explicit SAVE command is issued, or at the end of the Edit session.

2. Save data

All pending changes are submitted to Db2® for processing whenever the Enter key is pressed (and no other operations are pending). Successful changes are not committed until the end of the Edit session, unless the **Commit changes when Save issued** option is selected. Rows for which there was an unsuccessful change are marked with “=ERR”, “ERR R”, or the SQLCODE in the prefix area (see [Show SQLCODE on page 637](#)).

3. Save data and commit changes

All pending changes are submitted to Db2® for processing whenever the Enter key is pressed (and no other operations are pending). Rows for which there was an unsuccessful change are marked with “=ERR”, “ERR R”, or the SQLCODE in the prefix area (see [Show SQLCODE on page 637](#)). FM/Db2 issues an explicit Db2® commit at the end of the save process; however, this only occurs if:

- No save errors were encountered, or
- **Commit when no save errors** is turned off.

Committing the changes to Db2® is an irrevocable process.

Commit when save issued

The default for this option is selected. The setting for this option may have been fixed by the product installer. FM/Db2 issues an explicit Db2® commit at the end of the save process; however, this only occurs if:

- No save errors were encountered, or
- **Commit when no save errors** is turned off.

Note that the Enter key processing options **Save data** and **Save data and commit changes** behave as though an explicit save command had been issued when the Enter key was pressed.

Commit when no save errors

The default for this option is not selected. The setting for this option may have been fixed by the product installer.

When this option is not selected, FM/Db2 issues an explicit Db2® commit at the end of the save process, regardless of whether any errors were encountered during the save process.

When this option is selected, FM/Db2 only issues an explicit Db2® commit at the end of the save process when no errors were encountered during the save process.

Auto-commit count

The default action, indicated by a zero value, is that no automatic Db2® commit points are during the editor SAVE process. When a positive value is specified, FM/Db2 issues an automatic Db2® commit point whenever there have been *value* successful changes during the SAVE process (where *value* is the value specified for **Auto-commit count**). Specifying a non-zero value can cause multiple Db2® commit points to be issued during the SAVE process.

Example:

With an auto-commit count of 2 and 11 successful changes processed during a SAVE process, five Db2® commit points are issued. The changes for the last row processed remain uncommitted.

Parent panels

You can go to the Editor Options (1 of 8) panel from the “parent” panels shown below. To go to the Editor Options (6 of 6) panel, you then press the NxtPage function key (F11) five times.

- [Set Processing Options panel on page 795](#)
- [Db2 View panel on page 613](#)
- [Db2 Browse panel on page 595](#)
- [Db2 Edit panel on page 598](#)
- [Action bar pull-down menu on page 436](#)

You can only display the Editor Options (6 of 8) panel if the **Enter key and commit processing options** option on the Editor Options (1 of 8) panel is selected.

Child panels

To display this panel...	Use/do this
Editor Options (5 of 8) panel on page 645	Press the PrvPage function key (F10)
Editor Options (7 of 8) panel on page 652	Press the NxtPage function key (F11)

Related tasks

- [View and Edit options \(options 1 and 2\) on page 65](#)
- [Setting default processing options on page 60](#)
- [Setting options for the current FM/Db2 editor session on page 123](#)
- [Ending a File Manager/Db2 editor session on page 130](#)

Editor Options (7 of 8) panel

You use the Editor Options (7 of 8) panel to set your default editor options.



Note: See the description for the Editor Options (1 of 8) panel ([Editor Options \(1 of 8\) panel on page 625](#)) about how long any changes you make to these options last.

Panel and field definitions

<u>P</u> rocess	<u>O</u> ptions	<u>U</u> tilities	<u>H</u> elp
FM/Db2 (DFG2)	Editor Options (7 of 8)		Global Settings
Concurrency Options: Enter "/" to select option - Read-only access / Commit after data fetch - Skip locked rows		SQL Cursor Concurrency Options: Concurrency 1 0. Uncommitted read 1 1. No with clause 2. Cursor stability 3. Read stability 4. Read stability keep locks 5. Repeatable read 6. Repeatable read keep locks	
Edit Locking Option: Locking 1 1. None 2. Share mode 3. Exclusive mode		Keep locks option 1 1. Use/Keep share locks 2. Use/Keep update locks 3. Use/Keep exclusive locks	
Command ==>> _____ F1=Help F2=Split F3=Exit F7=Backward F8=Forward F9=Swap F10=PrvPage F12=Cancel			

Concurrency options

For a detailed explanation about this subject, refer to the Db2 UDB for z/OS Administration Guide.

Concurrency options affect the way Db2® takes row and page locks for data in a Db2® table. Locking options affect the way Db2® takes table locks. When a table locking option is specified, it overrides any concurrency option.

In general terms, specifying a higher value for the concurrency option reduces the likelihood of deadlocks when editing an object, at the expense of other users' ability to access and change data.

FM/Db2 provides options that can minimize Db2® locking, and the duration of the Db2® locks taken, when FM/Db2 accesses Db2® and retrieves data for a File Manager/Db2 editor session.

FM/Db2 also provides options to lock the table to prevent other users from either updating or reading data. The locking options should be used with caution.

Note that both the concurrency and table locking options only apply to the initial fetch of data from Db2®. If either of the commit options **Commit changes when save issued** or **Commit changes when no save errors** is specified, each commit point releases any locks held by Db2® against the table. For more information, see the description about **Enter Key Processing, Commit Options** in [Editor Options \(6 of 8\) panel on page 649](#).

After each commit point, FM/Db2 re-locks the table if a table-locking option has been specified; however, other Db2® users may access the table between the time of the commit point and FM/Db2 re-locking the table.



Note:

1. Use table locking options with caution.
2. For the table locking option to be effective, the Db2® object must be a table. It is not possible to lock a view.
3. Any concurrency option applies to the initial fetch of data from Db2® only.
4. Any concurrency or locking option persists only until the next commit point. See below for more information.
5. Set the **Concurrency** option to 0.

FM/Db2 provides options for accessing data in “*read-only*” mode, and for reducing the life of the Db2® locks taken when data is retrieved from Db2®. It also provides control over the locking mechanism used when data is retrieved from Db2®.

Read-only access

If you select this option, FM/Db2 accesses data from Db2® in “*read-only*” mode, by adding the FOR FETCH ONLY clause to the SQL statement used to retrieve data from Db2®. By default, this option is not selected.

Selecting this option does not prevent edit operations from occurring.

Note that, for a File Manager/Db2 Browse session, the FOR FETCH ONLY clause is always added to the SQL statement used to retrieve data from Db2®.

Commit after data fetch

The default for this option is selected. The value for this option may have been fixed by the product installer. If you select this option, FM/Db2 issues an explicit COMMIT when the data from the FM/Db2 Edit session was retrieved from Db2®. This releases all Db2® locks taken when the data for the FM/Db2 Edit session is retrieving. It also releases any explicit table locks taken when a locking shared or exclusive option is specified.

This option is recommended in high concurrency environments, where it is important to minimize the duration of any Db2® locks held.

Selecting this option does not prevent edit operations from occurring; however, it increases the likelihood of errors when changed data is presented to Db2® for validation. This is because other processes are free to change the Db2® data for which a copy is stored in the FM/Db2 Edit session. Therefore, when a change made in the FM/Db2 Edit session is presented to Db2®, the original data might have changed, resulting in various SQL errors.

Note that, for a File Manager/Db2 Browse or View session, FM/Db2 always issues an EXPLICIT commit once the data for the Browse session has been retrieved from Db2®.

Skip locked rows

Use this option to control whether a searched DELETE statement ignores or skips any rows that are incompatibly locked by other processes. The default is not selected.

Edit Locking Option

When FM/Db2 operates in edit mode only, use this option to control whether FM/Db2 explicitly locks the Db2® object that is being processed. This option applies to tables only, not to objects that are defined on a table such as views. This option may have been fixed by the product installer. When the option is available for update, the default is 1 (**None**).

1. None

FM/Db2 does not issue an explicit lock before accessing data for the table. This is the default choice.

2

FM/Db2 issues a statement that locks the table in share mode before accessing data for the table. The data from the table can be read by other tasks. However, the table cannot be updated by other processes until the FM/Db2 edit session ends. Use this option with caution to guarantee access to the table.

3

FM/Db2 issues a statement that locks the table in exclusive mode before accessing data for the table. The data from the table cannot be either read or written by other processes until the FM/Db2 edit session ends. Use this option with extreme caution to guarantee access to the table.

SQL Cursor Concurrency Options (Concurrency)

FM/Db2 can add a WITH clause to the SQL statement used to fetch data from Db2®. When a WITH clause is specified, Db2® takes locks (of varying levels) against either rows or pages within the table, as the data is accessed. The following options are possible. The default is 1 (**No with clause**).

0. Uncommitted read

Db2® locking is disabled. The data retrieved from Db2® may be inconsistent if another process is rolled back after the data access. Use this option in a high concurrency environment.

1. No with clause

This is the default value and recommended for most application programs. FM/Db2 does not add a WITH clause to the SELECT statement for the table. Any rows retrieved by FM/Db2 initially have a S(hare) lock. With this option it is possible that other processes can update the table you are editing.

2. Cursor stability

A row or page lock is held only long enough for the cursor to move to another row or page.

3. Read stability

A row or page lock is held for rows or pages that are read by the editor at least until the next commit point.

4. Read stability keep locks

A row or page lock is held for rows or pages that are read by the editor at least until the next commit point. The **Read stability** option takes an “S” or “U” lock, while this option takes an “X” lock on affected rows or pages.

5. Repeatable read

A row or page lock is held for all accessed rows, qualifying or not, at least until the next commit point. FM/Db2 can return to a previously read page and read the same row again, and the data is not changed and no new rows are inserted.

6. Repeatable read keep locks

This option is similar to the **Repeatable read** option, except that FM/Db2 takes an “X” lock, rather than a “S” or “U” lock.

SQL Cursor Concurrency Options (Keep locks option)

FM/Db2 can add a WITH clause to the SQL statement used to fetch data from Db2®. When a WITH clause is specified, Db2® takes locks (of varying levels) against either rows or pages within the table, as the data is accessed. The following options are possible. The default is 1 (**Use/Keep share locks**).

1. Use/Keep share locks

FM/Db2 does not issue an explicit table lock for the object being edited. Locking of rows and pages within the object is managed by Db2® according to FM/Db2 concurrency options and Db2® installation and object definition options.

2. Use/Keep update locks

FM/Db2 issues a LOCK TABLE IN SHARE MODE statement before reading the data from Db2®. This restricts all other users to read-only operations on the object. If either the Enter key option **Save data and commit changes**, or the **Commit changes when SAVE issued** option is selected, any commit point take during the Edit session releases the table lock. FM/Db2 re-issues the lock immediately after the commit point. However, other processes can access the table between the time of the commit point and FM/Db2 re-locking the table.

3. Use/Keep exclusive locks

FM/Db2 issues a LOCK TABLE IN EXCLUSIVE MODE statement before reading the data from Db2®. This prevents all other users from accessing the object, unless the other process is running with an isolation level of uncommitted read. If either the Enter key option **Save data and commit changes**, or the **Commit changes when SAVE issued** option is selected, any commit point take during the Edit session releases the table lock. FM/Db2 re-issues the lock immediately after the commit point. However, other processes can access the table between the time of the commit point and FM/Db2 re-locking the table.

Parent panels

You can go to the Editor Options (1 of 8) panel from the “parent” panels shown below. To go to the Editor Options (7 of 8) panel, you then press the NxtPage function key (F11) six times.

- [Set Processing Options panel on page 795](#)
- [Db2 View panel on page 613](#)
- [Db2 Browse panel on page 595](#)
- [Db2 Edit panel on page 598](#)
- [Action bar pull-down menu on page 436](#)

You can only display the Editor Options (7 of 8) panel if the **Concurrency and locking options** option on the Editor Options (1 of 8) panel is selected.

Child panels

To display this panel...	Use/do this
Editor Options (6 of 8) panel on page 649	Press the PrvPage function key (F10)

Related tasks

- [View and Edit options \(options 1 and 2\) on page 65](#)
- [Setting default processing options on page 60](#)
- [Setting options for the current FM/Db2 editor session on page 123](#)

Editor Options (8 of 8) panel

You use the Editor Options (8 of 8) panel to set your default editor options.



Note: See the description for the Editor Options (1 of 8) panel ([Editor Options \(1 of 8\) panel on page 625](#)) about how long any changes you make to these options last.

Panel and field definitions

<u>P</u> rocess	<u>O</u> ptions	<u>U</u> tilities	<u>H</u> elp
FM/Db2 (DFG2)	Editor Options (8 of 8)		Global Settings
LOB and XML Columns:			
Enter "/" to select option			
_ Show part/all data		Max characters	. . 0
LOB Display Format:			
Initial display format		LOB Piece Size:	
<u>3</u>	1. Previous	<u>2</u>	1. Table display size
	2. Table		2. Single display size
	3. Single		3. Manual ... 100
Command ==>			
F1=Help	F2=Split	F3=Exit	F7=Backward F8=Forward F9=Swap
F10=PrvPage	F12=Cancel		

Show part/all data

When the Db2® object contains LOB (BLOB, CLOB or DBCLOB), or XML columns, you can display some, or possibly all of the data within those columns. The default action is not selected, in which case no data is displayed. The LOB and XML column appears in the editor as a column heading only, with no data displayed.

To display some, or possibly all, of the data in a LOB or XML column, select the option. You must also specify a maximum number of characters to displayed using the Max characters option.

Note that you can display all of the data in a LOB or XML column using the LOBBRWS, LOBVIEW, LOBEDIT, XMLBRWS, XMLVIEW and XMLEDIT editor primary commands.

Max characters

This option works in conjunction with the Show part/all data option. You can specify a value in the range 0-1000. The default is 0. When the Show part/all data option is selected, and a non-zero value is specified for the Max characters option, FM/Db2 retrieves and displays that many characters of the LOB or XML data in the editor session.

Initial Display Format

Use this section of the Editor Options panel to specify how editor panels appear at the start of a File Manager/Db2 LOB editor session. This option works with the Split LOBs into pieces using option. The default is 3 (**Single**). Set this option to one of the following:

1. Previous

The display format field (Format) on the LOB editor panel is pre-filled with the value specified in the previous FM/Db2 LOB editor session.

2. Table

The LOB Editor panel is displayed in TABLE display format. When this option is selected it is suggested that the Split LOBs into pieces using option be set to *"Table display size"*.

3. Single

The LOB Editor panel is displayed in SNGL display format. This is the default setting. When this option is selected it is suggested that the Split LOBs into pieces using option be set to *"Single display size"*.

Split LOBs into pieces using

This option determines the size of the pieces, when FM/Db2 displays a LOB column in the LOB editor. LOB data can be very large, and a 3270 display is not well suited to displaying large columns directly, so the LOB editor breaks the LOB column into pieces, and displays those pieces as though the LOB column was actually a table with a single varying column.

The length of the varying column is the maximum length of any piece. The default is 2 (**Single display size**). This option works in conjunction with the Initial Display Format option (for LOBs) as follows:

1. Table Display size

The size of each piece is approximately the same as the number of characters displayed on a single line in TABL display format. The actual number of characters displayed depends on the terminal characteristics. This may not be the best choice when processing large objects because of the large number of pieces required.

2. Single Display size

The size of each piece is approximately the same as the number of characters displayed on the terminal in SNGL display format. The actual number of characters displayed depends on the terminal characteristics. On a 24x80 terminal the value is approximately 850; on a 48x132 terminal the value is approximately 4250.

This allows large amounts of data to be displayed at one time – when compared with the Table Display size option.

Usage tip 1: Turn on the character position range indicator by issuing the CHARPOS command. This shows the starting and ending character position for each row of data on the display.

Usage tip 2: You can use the NEXT (PF11 by default) and PREVIOUS (PF10 by default) PFKeys to scroll through the LOB data. The character position range indicator values show the absolute position from the start of the LOB, rather than the relative position within each piece of the LOB.

3. Manual

You can specify your preference for the piece size by specifying '3'.

Enter your preference for piece size in the Manual input field. A value in the range 60-32760 is required. The default is 100.

Parent panels

You can go to the Editor Options (1 of 8) panel from the “parent” panels shown below. To go to the Editor Options (8 of 8) panel, you then press the NxtPage function key (F11) seven times.

- [Set Processing Options panel on page 795](#)
- [Db2 View panel on page 613](#)
- [Db2 Browse panel on page 595](#)
- [Db2 Edit panel on page 598](#)
- [Action bar pull-down menu on page 436](#)

You can only display the Editor Options (8 of 8) panel if the **XML and LOB column processing** options on the Editor Options (1 of 8) panel is selected.

Child panels

To display this panel...	Use/do this
Editor Options (7 of 8) panel on page 652	Press the PrvPage function key (F10)

Related tasks

- [View and Edit options \(options 1 and 2\) on page 65](#)
- [Setting default processing options on page 60](#)
- [Setting options for the current FM/Db2 editor session on page 123](#)

Enter and Execute Db2® Commands panel

You use the Enter and Execute Db2® Commands panel to enter Db2® commands and view the output returned by Db2®.

If you do not have the authority to change the audit setting when processing a particular Db2® object, FM/Db2 prompts you if you enter the wrong setting. If you do have the authority to set the audit setting for a particular Db2® object, FM/Db2 honors whatever value is specified in this field.

SQL statement

Freeform SQL statement entry area. If you want to enter more than one SQL statement, you must separate the statements with a semicolon (;).

Parent panels

- [SQL Prototyping, Execution and Analysis panel on page 806](#)

Child panels

None.

Related tasks

- [Entering SQL statements on page 417](#)
- [Executing SQL statements on page 418](#)
- [Explaining SQL on page 419](#)
- [SAF-rule controlled auditing on page 69](#)

Related references

- [DOWN primary command on page 885](#)
- [EXECUTE primary command on page 893](#)
- [EXPLAIN primary command on page 894](#)
- [SQL primary command on page 942](#)
- [UP primary command on page 945](#)

EXPLAIN Interpretation panel

FM/Db2 displays the EXPLAIN Interpretation panel if you use the I line command against an item listed on:

- The [Plan Table Rows panel on page 725](#), or
- The [Statement Table Rows panel on page 808](#)

Explain Utilities panel

You use the Explain Utilities panel to select functions to support the use of the Db2® EXPLAIN SQL statement.

Panel and field definitions

Process	Options	Utilities	Help
FM/Db2 (DFG2)	Explain Utilities		
L	List plan table rows		
C	Create plan table	D	Drop plan table
CF	Create function table	DF	Drop function table
CS	Create statement table	DS	Drop statement table
CX	Create plan table index		
Table Identification Criteria:			
Owner _____	+	
Database _____		
Table space _____		
Row Identification Criteria:			
Plan name _____		
DBRM/package name _____	+	
Collection ID _____	+	
Enter "/" to select option			
Confirm object drop			
Command ==>			
F1=Help	F2=Split	F3=Exit	F4=Expand
F9=Swap	F10=Left	F11=Right	F12=Cancel
			F7=Backward F8=Forward

L

List a plan table. FM/Db2 displays the rows of the specified plan table. If you leave the **Plan table owner** field blank, FM/Db2 uses your current SQL ID. You can qualify the rows by **Plan name**, **DBRM/package name**, and **Collection ID**. You can list any related statement table and function table rows, if they exist, using line commands from the plan table. The table name for a plan table is always PLAN_TABLE.

C

Create a plan table. A plan table is needed for the SQL EXPLAIN statement. If you leave the **Plan table owner** field blank, FM/Db2 uses your current SQL ID. You can optionally use the **Database** and **Table space** fields to define the database and table space to be used when the plan table is created. The table name for a plan table is always PLAN_TABLE.

CF

Create a function table, where the SQL EXPLAIN statement can store information about how function references are resolved. FM/Db2 uses the **Plan table owner** field (or, if it is left blank, your current SQL ID) as the owner of the function table. The table name for a function table is always DSN_FUNCTION_TABLE.

CS

Create a statement table, where the SQL EXPLAIN statement can store the estimated costs for an SQL statement. FM/Db2 uses the **Plan table owner** field (or, if it is left blank, your current SQL ID) as the owner of the statement table. The table name for a statement table is always DSN_STATEMNT_TABLE.

CX

Create an index on the plan table for the Db2® optimizer. An index on the plan table is recommended if you use Db2® optimizer hints.

U

Upgrade a plan table to the current Db2® version. Use this option to add columns so that the plan table is at the level that Db2® supports.

D

Drop plan table.

DF

Drop function table.

DS

Drop statement table.

Plan table owner

See function descriptions below.

Database

See function descriptions below.

Table space

See function descriptions below.

Plan name

See function descriptions below.

DBRM/package name

See function descriptions below.

Collection ID

See function descriptions below.

Confirm object drop

Indicates if you want FM/Db2 to display a confirmation panel each time you enter a DR(op) command against an object

Parent panels

- [SQL Prototyping, Execution and Analysis panel on page 806](#)

Child panels

To display this panel...	Use/do this
Plan Table Rows panel on page 725	Function L
Create Index panel on page 527	Function CX

Related tasks

- [Managing tables used by SQL explain on page 422](#)

Export Options (1 of 3) panel

You use the Export Options (1 of 3) panel to set various options that affect the way in which FM/Db2 operates. These options are saved in your ISPF profile and persist from one FM/Db2 session to the next.

Panel and field definitions

Figure 120. Export Options (1 of 3) panel

<u>P</u> rocess	<u>O</u> ptions	<u>U</u> tilities	<u>H</u> elp
FM/Db2 (DFG2)	Export Options - (1 of 3)		Global Settings
Data Format:			
1	1. FM/Db2 (SQLDA) format		Enter "/" to select option
	2. Db2 UNLOAD format		/ Native unicode processing
	3. DSNTIAUL format		
	4. User defined		
	5. Delimited variables (CSV)		
Execution options:			
Select option			
2	1. Online		Enter "/" to select option
	2. Batch	-->	- Batch data set creation
	3. Batch, using Db2 UNLOAD	-->	Edit Db2 UNLOAD options
More Options:			
Enter "/" to select option			
/	Null indicators / CSV options		(For user-defined, CSV data formats)
	Data type format		(For user-defined data format)
Command ==>			
F1=Help	F2=Split	F3=Exit	F7=Backward F8=Forward F9=Swap
F11=NxtPage	F12=Cancel		

Data format

The format in which Export Utility unloads data:

- FM/Db2 (SQLDA) format. Db2® internal format. This is the default.
- Db2® external (or unload) format.
- Db2® DSNTIAUL unload format. This is the format used by the Db2® DSNTIAUL sample program.
- User-defined format.
- Delimited Variables (CSV) format.

FM/Db2 writes the data to the output file as a comma-delimited (CSV) file.

The data for each column appears in the output record in column number order, and each data value is separated from the next by a separator character.

Db2® data exported in this way cannot be imported using Import (option 3.6). The data is intended for use by a spreadsheet application program.

Native unicode processing

Determines how FM/Db2 processes Unicode encoded data when exporting data from a table to a dataset. Normally data stored in Db2® in Unicode is converted automatically to the CCSID of the Db2® plan, typically CCSID 37. This automatic translation results in conversion errors when a Unicode character does not have an equivalent code point in CCSID 37. When data is exported in "native Unicode" format, the automatic translation of data from unicode to the CCSID of the Db2® plan is suppressed. This ensures that there are no data conversion errors, but means the data is not directly visible using z/OS® utilities such as the editor. Use this option if the data is to be transferred to other systems that support Unicode data. When the option is not enabled, the option has no effect; that is, the default processing is used. When the data being exported is not Unicode encoded, the option has no effect, even if enabled.

/

Process Unicode data natively.

(blank)

Do not Process Unicode data natively. This is the default setting.

Execution Options

Online

The export is run in foreground.

Batch

Builds the necessary JCL to perform the Export utility in a batch job, and displays it in an edit session so that you can review the JCL prior to submitting the job.

Batch, using Db2® utility

Selecting this option runs the export using the Db2® UNLOAD utility.

Generates the JCL for the UNLOAD job, and displays it in an edit session so that you can review the JCL prior to submitting the job.

The default is **Batch**.

Batch data set creation

This option only applies when batch execution is selected, and is ignored for online execution. You use this option to defer the creation of the export data set to batch job execution time. When this option is not selected, FM/Db2 determines whether the export data set exists before generation of the batch job JCL. If the data set does not exist, you are prompted to create it.

The default is not selected, which means that export data set creation is not deferred to batch job execution time. When you set the execution option to **Batch, using Db2® utility**, this option is automatically selected and cannot be changed.

Edit Db2® UNLOAD options

Used in conjunction with option **3 Batch, using Db2® UNLOAD**. The UNLOAD Options panel is displayed after you press the Exit function key (F3). The default is not selected.

More Options**Null indicators / CSV options**

If selected, you can navigate to the Export Options (2 of 3) panel by pressing the NxtPage function key (F11).

This option is only selectable if you have also selected either the data format option **4. User defined** or **5. Delimited variables (CSV)**

When this option is displayed, the default is not selected.

Data type format

If selected, you can navigate to the Export Options (3 of 3) panel by pressing the NxtPage function key (F11).

This option is only selectable if you have also selected the data format option **4. User defined**.

When this option is displayed, the default is not selected.

Parent panels

- [Set Utility Options panel on page 803](#)

Child panels

To display this panel...	Use/do this
Export Options (2 of 3) panel on page 667	Select the Null indicators / CSV options option (data format option 4 or 5 must also be selected), and press the NxtPage function key (F11).

Related tasks

- [Setting default processing options on page 60](#)
- [FM/Db2 system options \(option 0.2\) on page 63](#)
- [Copying data to a VSAM or QSAM file on page 274](#)

Export Options (2 of 3) panel

You use the Export Options (2 of 3) panel to set various options that affect the way in which FM/Db2 operates. These options are saved in your ISPF profile and persist from one FM/Db2 session to the next.

Panel and field definitions

Figure 121. Export Options (2 of 3) panel

<u>P</u> rocess	<u>O</u> ptions	<u>U</u> tilities	<u>H</u> elp
FM/Db2 (DFG2)	Export Options - (2 of 3)		Global Settings
Null Indicators:			
Usage			
<u>1</u>	1. Separate	<u>1</u>	1. Before
	2. None	<u>2</u>	2. After
		<u>3</u>	3. User defined
Type			
		<u>1</u>	1. One byte
		<u>2</u>	2. Two byte
Indicator			
		<u>_</u>	Char
		<u>-1</u>	Integer
CSV Options			
Enter "/" to select option			
<u>-</u>	Include column headers	<u>1</u>	1. Character --> <u>_</u>
<u>-</u>	"ASIS" encapsulation		2. Integer --> <u>-1</u>
<u>-</u>	Quoted values		
<u>-</u>	Single quotes		
<u>-</u>	Leading zeros	<u>1</u>	1. Character --> <u>_</u>
<u>/</u>	Include leading blanks		2. Integer --> <u>-1</u>
<u>-</u>	Include trailing blanks		3. None --> <u>_</u>
Null indicator			
		<u>1</u>	1. Character --> <u>_</u>
			2. Integer --> <u>-1</u>
			3. None --> <u>_</u>
Command ==>			
F1=Help	F2=Split	F3=Exit	F7=Backward F8=Forward F9=Swap
F10=PrvPage	F11=NxtPage	F12=Cancel	

Usage

For nullable columns, determines whether fields in the exported data correspond to the null indicator:

Separate

A null indicator is output, taking into account the settings for Placement, Type and Indicator.

None

No fields in the exported data correspond to the null indicator.

The default is 1 (**Separate**).

Placement

Determines where the null indicator is placed:

Before

The null indicator is placed before the data for the column to which it applies.

After

The null indicator is placed after the data for the column to which it applies.

User defined

A 1-byte (character format) or 2-byte (signed integer format) null indicator is placed somewhere in the output record. Placement depends on mapping the null indicator to a corresponding field in the output record.

The default is 1 (**Before**).

Type

Determines the type of null indicator to be used:

One byte

1-byte (character format) null indicator.

Two byte

2-byte (signed integer format) null indicator.

The default is 2 (**Two byte**).

Indicator

Determines the value of the null indicator:

Char

The character used as the 1-byte (character format) null indicator. The default is blank.

Integer

The integer used as the 2-byte (signed integer format) null indicator. The default is an integer value of -1.

CSV Options

The following options are available when the **Delimited variables (CSV)** data format option is specified on the Export Options (1 of 3) panel.

Include column headers

Select this option to produce comma-delimited column headers as the first export record. The default is not selected.

"ASIS" encapsulation

Determines whether automatic encapsulation of column data is disabled. Select this option when the data has already been encapsulated in a user-defined character, prior to storage in Db2®. The default is not selected.

Quoted values

Select this option to enclose the CSV output field value in either double or single quotes. By default, output fields within a CSV file that contain an embedded delimiter, and fields consisting only of blanks, are enclosed in quotes. For single quotes, additionally select the **Single quotes** option.

Single quotes

Select this option to enclose output field values in single quote instead of double quotes.

Leading zeros

Select this option to format all numeric fields with leading zeros.

Include leading blanks

When the **Delimited variables (CSV)** data format option is specified on the Export Options (1 of 3) panel, Db2 CHAR or VARCHAR data containing leading blanks include the blanks when written to the exported file. If the Db2 data contains only blanks and no other characters, then choose both "Include leading blanks" and "Include trailing blanks" to cause all of the blanks to be written to the exported file. The default is to include leading blanks.

Include trailing blanks

When the **Delimited variables (CSV)** data format option is specified on the Export Options (1 of 3) panel, Db2 CHAR or VARCHAR data containing trailing blanks include the blanks when written to the exported file. If the Db2 data contains only blanks and no other characters, then choose both "Include trailing blanks" and "Include leading blanks" to cause all of the blanks to be written to the exported file. The default is to not include trailing blanks.

Separator character

The character used to separate data when the **Delimited variables (CSV)** data format option is specified on the Export Options (1 of 3) panel. The default separator character is a comma.

Null indicator type

Character

A character used to represent a null value when the **Delimited variables (CSV)** data format option is specified on the Export Options (1 of 3) panel. If Type 1 is specified, the default character used to represent a null value is underscore.

Integer

An integer used to represent a null value when the **Delimited variables (CSV)** data format option is specified on the Export Options (1 of 3) panel. If Type 2 is specified, the default value used to represent a null value is -1.

None

When the **Delimited variables (CSV)** data format option is specified on the Export Options (1 of 3) panel, and Type 3 is specified, null values within the Db2 data are represented by an empty field in the exported file.

Parent panels

- [Set Utility Options panel on page 803](#)

Child panels

To display this panel...	Use/do this
Export Options (1 of 3) panel on page 665	Press the PrvPage function key (F10)

To display this panel...	Use/do this
Export Options (3 of 3) panel on page 671	Press the NxtPage function key (F11) (the data format option 4. User defined , and the Data type format option, on the Export Options (1 of 3) panel must be selected).

Related tasks

- [Setting default processing options on page 60](#)
- [FM/Db2 system options \(option 0.2\) on page 63](#)
- [Copying data to a VSAM or QSAM file on page 274](#)

Export Options (3 of 3) panel

You use the Export Options (3 of 3) panel to set various options that affect the way in which FM/Db2 operates. These options are saved in your ISPF profile and persist from one FM/Db2 session to the next.

Panel and field definitions

Figure 122. Export Options (3 of 3) panel

Process	Options	Utilities	Help
FM/Db2 (DFG2)	Export Options - (3 of 3)		Global Settings
Decimal Data:			
Select option			
<u>1</u> 1. Internal (packed) format			
2. Zoned format			
3. External format			
Integer Data:			
Enter "/" to select option			
_ External format			
Floating Point Data:			
Enter "/" to select option			
_ External format			
Graphic Data (fixed length):			
Enter "/" to select option			
_ Use shift-out/shift-in (SOSI) characters			
Command ==>			
F1=Help	F2=Split	F3=Exit	F7=Backward F8=Forward F9=Swap
F10=PrvPage	F11=NxtPage	F12=Cancel	

Decimal Data

Internal (packed) format

Any decimal field occupies the minimum number of bytes needed to represent the data as a packed decimal field.

Zoned format

In Zoned format the field occupies the number of bytes equal to the precision.

External format

In External format the field occupies the number of bytes equal to the precision + 2.

The default is 1 (**Internal (packed) format**).

Integer Data

External format

In External format the field occupies 6 bytes for smallint(2), 11 bytes for integer(4), 20 bytes for bigint.

The default is not selected.

Floating Point Data

External format

In External format the field occupies 14 bytes for float(4), 23 bytes for float(8).

The default is not selected.

Graphic Data (fixed length)

Use shift-out/shift-in (SOSI) characters

Use shift-out/shift-in (SOSI) characters to enclose the exported graphic fixed length data.

The default is not selected.



Note: External format is the same format that is used to display data in FM/Db2 Editor.

Parent panels

- [Set Utility Options panel on page 803](#)

Child panels

To display this panel...	Use/do this
Export Options (2 of 3) panel on page 667	Press the PrvPage function key (F10)

Related tasks

- [Setting default processing options on page 60](#)
- [FM/Db2 system options \(option 0.2\) on page 63](#)
- [Copying data to a VSAM or QSAM file on page 274](#)

Export Utility ("From") panel

You use the Export Utility panel to specify the name of the Db2® object that contains the data to be exported, the (optional) name of a template data set, and processing options.

Panel and field definitions

Process	Options	Utilities	Help
FM/Db2 (DFG2)		Export Utility	
From Db2 Object:			
Location	_____	Database	_____ (optional)
Owner	FMUSER	Table space _____	(optional)
Name	EMP		+
Export Count	ALL	Number of rows to export	
From Template:			
Data set name	_____		
Member	_____		
Processing Options:			
Template usage	Enter "/", "A" always to select option		
3 1. Above	- Edit options		
2. Previous	- Edit template		
3. Generate from table	- Create audit trail (*)		
4. Generate/Replace			
Command ==>			
F1=Help	F2=Split	F3=Exit	F4=Expand
F9=Swap	F10=Left	F11=Right	F12=Cancel
		F7=Backward	F8=Forward

Location

The location name for the Db2® object. You can specify a generic name to select from a list. If you enter a value in this field, synonym object names are not recognized or included in the selection list.

Database

The database name for the Db2® object. You can use this field to optionally specify a database to further define the object to be processed. If you enter a value in this field:

- The values displayed in the **Owner** and **Name** selection lists are limited to those values defined within the specified database.
- Synonym names are not recognized or included in the selection list.

Owner

The name of the owner of the object. You can specify a generic name to select from a list. To specify a synonym in the object **Name** field, either leave this field blank, or specify a generic name that includes the current SQLID or specify the current SQLID. Synonyms are not recognized or included on the table selection list if any of the **Table space**, **Database**, or **Location** fields are non-blank.

If the **Translate Db2® object names** option is selected, lowercase characters are converted to uppercase. If this option is not selected, lowercase characters are not converted to uppercase; in this situation, a lowercase owner name such as *“sysibm”* does not match *“SYSIBM”* in the Db2® catalog.

Table space

The table space name for the Db2® object. To further define the object to be processed, you can use this field to optionally specify a table space. If you enter a value in this field:

- The values displayed in the **Owner** and **Name** selection lists are limited to those values defined within the specified table space.
- Synonym names are not recognized, nor included in the selection list.

Name

The name of the object name to be processed. You can specify a generic name to select from a list. To specify a synonym in this field, type the name of the synonym and ensure that the **Owner** field is blank, contains a generic name that includes the current SQLID, or contains the current SQLID. Synonyms are not recognized or included in the table selection list if any of the **Table space**, **Database**, or **Location** fields are non-blank.

If the **Translate Db2® object names** option is selected, lowercase characters are converted to uppercase. If this option is not selected, lowercase characters are not converted to uppercase; in this situation, a lowercase owner name such as *“sysibm”* does not match *“SYSIBM”* in the Db2® catalog.

Export Count

The number of rows to be exported. This indicates the number of rows to be read from the Db2® table. It can be either a number in the range 1–99999999, or *, or ALL. The default is ALL, where all rows selected from the Db2® object are exported.

Data set name

The name of the data set or PDS member containing the template for the *“From”* table. It can be a fully-qualified data set name or a pattern. The name may include a member name or name pattern in parenthesis. If the member is specified here, the associated **Member** field must be empty.

Member

If you specified the name of a partitioned data set (PDS) without including a member name or name pattern in parenthesis in the **Data set name** field, then you can use this field to specify the member name or a member name pattern.

Template usage

The Export Utility “*From*” panel provides four options for template processing:

1. Above

Requires that you enter the name of a template data set (and optionally a member name) in the **From Template** section of the panel. If you do not specify a member name, or if you specify a pattern, FM/Db2 displays a member selection list. After you have specified the member containing a template, processing continues using this template in place of the automatically-generated template for the table (see Template usage option 3).

2. Previous

Uses the last (previously used) template for this table.

3. Generate from table

Generates a template based on the information in the Db2® catalog for the specified table. This is the default setting. If you have specified a member name in the **From Template** section of the panel, it is ignored. FM/Db2 generates the required template in memory.

4. Generate/Replace

Generates a template based on the information in the Db2® catalog for the specified table, and saves this information in the member specified in the **From Template** section of the panel. If the member already exists, it is replaced. Any prior customization is lost.

You can select the following options by entering a / or an “A”:

Edit options

Select this option to display the first of the Export Options panels. The default is not selected.

Edit template

Select this option to edit the template before exporting the data. The default is not selected.

Create audit trail



Note: “(*)” is appended to the option name for SAF-controlled auditing when required by SAF rules.

Controls whether access to Db2® by FM/Db2 is written to the FM/Db2 audit log. This option only appears when SAF-rule controlled auditing is in effect.

FM/Db2 may write audit records to either SMF, or a data set.

When SAF rules are used to control FM/Db2 auditing, the decision to write audit records is based on the Db2® object name being processed, and the current userid (TSO logonid). Therefore auditing may be required when processing one Db2® object, but not another. In addition, it is possible that the auditing requirement cannot be changed for a particular Db2® object; this might be different for another Db2® object, and the requirement may be different for other TSO userids.

If you do not have the authority to change the audit setting when processing a particular Db2® object, FM/Db2 prompts you if you enter the wrong setting. If you do have the authority to set the audit setting for a particular Db2® object, FM/Db2 honors whatever value is specified in this field.

Parent panels

- [Utility Functions panel on page 864](#)

Child panels

To display this panel...	Use/do this
Export Utility ("To") panel on page 676	Select Edit template
Column Selection/Edit panel on page 485	Do not select Edit template
Export Options (1 of 3) panel on page 665	Select Edit options

Related tasks

- [Copying data to a VSAM or QSAM file on page 274](#)
- [Specifying a data set and a member name on page 50](#)
- [Selecting options on FM/Db2 panels on page 44](#)
- [Working with templates on page 72](#)
- [SAF-rule controlled auditing on page 69](#)

Export Utility ("To") panel

You use the Export "To" panel to specify the name of the data set that contains the data to be exported, the (optional) name of a template data set, and processing options.

Panel and field definitions

Process	Options	Utilities	Help
From DSN81010.EMP			
Command ==>			
To Partitioned, Sequential or VSAM Data Set:			
Data set name . . .	_____		
Member	_____		
Volume	_____		
To Copybook or Template:			
Data set name . . .	_____		
Member	_____		
Processing Options:			
Template/Copybook usage	Disposition	Enter "/", "A"lways	
<u>3</u> 1. Above	<u>2</u> 1. Old or Reuse	_ View options	
2. Previous	2. Mod	<u>A</u> Edit template mapping	
3. Generate from table	Generated copybook		
4. Generate/Replace	<u>1</u> 1. No display		
5. None. (CSV output)	2. View		
6x. Gen/Rep copybook (x=AOP)	3. Edit		
Command ==>			
F1=Help	F2=Split	F3=Exit	F7=Backward F8=Forward F9=Swap
F12=Cancel			

Data set name (To Partitioned, Sequential or VSAM Data Set)

The name of the output data set.

Member (To Partitioned, Sequential or VSAM Data Set)

The output member name (if applicable).

Volume

The volume serial number if the data set is not catalogued.

Data set name (To Copybook or Template)

The name of the sequential or partitioned data set that contains the copybook or template that describes the data set. It can be a fully-qualified data set name or a pattern. The name may include a member name or name pattern in parenthesis. If the member is specified here, the associated **Member** field must be empty.

Member (To Copybook or Template)

If you specified the name of a partitioned data set (PDS) without including a member name or name pattern in parenthesis in the **Data set name** field, then you can use this field to specify the member name or a member name pattern.

Template usage

The Export Utility "To" panel provides five options for template processing:

1. Above

Requires that you enter the name of a copybook or template in the **To Copybook or Template** section of the panel. If you do not specify a member name, or if you specify a pattern, FM/Db2 displays a member selection list. After you have specified the member containing a copybook or template, processing continues using this template in place of the automatically-generated template for the table (see Template usage option 3).

2. Previous

Uses the last (previously used) template for this table.

3. Generate from input

Generates a template based on the input template, but which includes only those columns selected in the input template. If you have specified a data set name in the **To Copybook or Template** section of the panel, it is ignored. The generated template is not saved.

4. Generate and save

Generates a template based on the input template, but which includes only those columns selected in the input template. This option requires you to enter the name of a template data set (and optionally a member name) in the **To Copybook or Template** section of the panel. If you do not specify a member name, or if you specify a pattern, FM/Db2 displays a member selection list. The generated template is saved.

5. None. (CSV output)

FM/Db2 does not use an output template. This option is only valid when the export data format is set to CSV.

Gen/Rep copybook (x=AOP)

Generates and saves a copybook that describes the exported data. This option requires you to enter the name of a copybook data set (and optionally a member name) in the *"To Copybook or Template"* section of the panel. If you do not specify a member name, or if you specify a pattern, FM/Db2 displays a member selection list. The generated copybook is saved, replacing any member with the same name.

- Specify 6A to generate and save a High Level Assembler copybook.
- Specify 6O to generate and save a COBOL copybook.
- Specify 6P to generate and save a PL/I copybook.

Disposition

The disposition for the data set that contains the exported data.

1. Old or Reuse

Specify '1' when the export data set exists, and the exported data is to replace any existing data.

2. Mod

Specify '2' in one of the following conditions:

- The export data does not exist, and needs to be created.
- The export data set exists, and the exported data is to be added to any existing data.

You can select the following options by entering a / or an "A":

Edit options

Select this option to display the second of the Export Options panels. The default is not selected.

Edit template mapping

Use to edit the template for the partitioned, sequential, or VSAM data set to which you are exporting the data, before exporting the data. The default is not selected.



Note: Template mapping does not apply for CSV output. See the template usage option **5. None. (CSV output)**.

Parent panels

- [Export Utility \("From"\) panel on page 673](#)
- [Column Selection/Edit panel on page 485](#)

Child panels

To display this panel...	Use/do this
Template Mapping panel on page 850	Select Edit template mapping

Related tasks

- [Copying data to a VSAM or QSAM file on page 274](#)
- [Specifying a data set and a member name on page 50](#)
- [Exported data formats on page 279](#)
- [Selecting options on FM/Db2 panels on page 44](#)
- [Working with templates on page 72](#)

Field Selection/Edit panel

You use the Field Selection/Edit panel to specify the records you want to select when you use the Import utility function (option 3.6).

Panel and field definitions

Process	Options	Help
File Manager	Field Selection/Edit	Line 1 of 27
----- Criteria - Enter 1 or 2 to specify expression by field -----		
1 Id :		+
2 Sel: #9 = 'B00'		+
Offset	0	
Cmd Seq	SHE Ref	Field Name
		**** Top of data ****
	1 1	\$\$\$01
	S 2 2	EMPNO
	3 2	len
	S 4 2	FIRSTNME
	S 5 2	MIDINIT
	6 2	len
	S 7 2	LASTNAME
	8 2	null
	S 9 2	WORKDEPT
	10 2	null
	S 11 2	PHONENO
Command	===>	Scroll
F1=Help	F2=Split	F3=Exit
F7=Up	F8=Down	F9=Swap
	F4=Expand	F5=RFind
	F10=Left	F11=Right
		F6=RunTemp
		F12=Cancel

1 Id, 2 Sel

Use option 1 and 2 to specify record identification and selection criteria by field.

If an expression has not previously been updated by field, you can enter the expression on the adjacent line which is left and right scrollable with the Left function key (F10) and the Right function key (F11), and expandable with the Expand function key (F4). The “+” and “-” indicators at the end of the field denote the directions (right and left respectively) in which you can scroll.

If an expression has previously been entered by field, this line is protected. To change back to a freeform REXX expression, select the “by field” option (by entering 1 or 2 on the command line) and delete the expression. When you return to this panel the line is available for input (unless it is a dynamic template in which case you must specify the expression).



Note: For more information about specifying record selection criteria, see the File Manager User's Guide and Reference.

Cmd

Prefix command area. Used to enter a template editor prefix command.

Seq

Sequence field. Used to order fields for display in a File Manager/Db2 editor session and printing data using the Print utility.

SHE

Select/Hold/Edit field. Shows the field status:

S

The field has been selected for processing.

H

The field has been selected to be held on the edit display.

E

The field has been previously edited to add information such as data create, field headings, and scrambling options.

Ref

Field reference. Shows the field reference number assigned to the field name. Field reference numbers are assigned to all fields in a record, and are used to identify fields in selection criteria expressions.

Field Name

Shows the level number and field name of the field. If the field is an array, the dimensions are shown in brackets after the field name. If the field has been selected for processing, the field name is highlighted.

Picture

For COBOL, shows the picture clause. For HLASM shows the DC or DS operand. For PL/I, shows the length and scale (if non zero) for binary and packed fields. Also shows the bit length for bit fields.

Type

Shows the data type of the field:

AN

Alphanumeric (includes alphabetic, and group items)

BI

Binary

BT

Bit

DB

DBCS

FE

Floating point (external)

FP

Floating point (internal)

G

Graphic

PD

Packed decimal (internal decimal)

VC

Variable Character

VD

Variable DBCS

VG

Variable Graphic

ZC

Character Null terminated

ZD

Zoned decimal (external decimal)

ZE

Zoned decimal edited

ZG

Graphic Null terminated

Z2

DBCS Null terminated

Start

Shows the start column of the field. For variable located fields the start location is based on the maximum length of the record.

Length

Shows the length of the field. For a level-01 field, if the record is variable-length, the length shown is the maximum record length.

Record identification criteria

Used to specify the criteria that FM/Db2 uses to identify this record type. FM/Db2 first uses the record length to identify record type.

For fixed-length records (as defined by the record definition in the template, not the data set attributes), the length of the record read must exactly match the length of the corresponding record definition in the template.

For variable-length records, the length of the record read must be equal to or greater than the minimum length and equal to or less than maximum length of the corresponding record definition in the template.

If FM/Db2 cannot match the length of a record to one of the record definitions in the template, the record is not selected for processing. If the length of a record matches more than one record definition in the template, and no further record identification criteria is specified, FM/Db2 uses the first matching record type in the template. Therefore, if the record length of each different record type in the file is not unique, you should use this field to specify some unique identification criteria.

Record selection criteria

Used to specify the criteria that FM/Db2 uses to select records for processing. You can use this field to limit the records of a given record type that you want to process. If you do not provide any record selection criteria, all records of this record type are selected for processing (if the record type itself has been selected for processing).

Parent panels

- [Import Utility \("From"\) panel on page 693](#)

Child panels

None.

Related tasks

- [Copying data from a VSAM or QSAM file on page 246](#)

FM/Db2 Release News panel

FM/Db2 displays the FM/Db2 Release News panel if you:

1. Select **Help** from the Action bar menu, and
2. Select **8. News about FM/Db2...** from the drop-down menu.

Foreign Keys for Table panel

FM/Db2 displays the Foreign Keys for Table panel if you use the FK line command against an item listed on the [Tables, Views and Aliases panel on page 843](#).

Free Application Plan panel

FM/Db2 displays the Free Application Plan panel if you use the FRE line command against an item listed on the [Application Plans panel on page 463](#).

Free Package panel

FM/Db2 displays the Free Package panel if you use the FRE line command against an item listed on the [Application Packages panel on page 460](#).

From Column Mapping panel

Panel and field definitions

```

Process  Options  Utilities  Help
-----
FM/Db2 (DFG2)                From Column Mapping
To Db2 object . . . : DSN8810.EEMP
From Db2 object . . . : DSN8810.EMP
To column . . . . : #15 RID
From column . . . . :

Sel  Cl#  From Column          Data Type(length)
----  --  -
      1  ***** Top of data *****
      2  Delete "From column"
      3  EMPNO                CHARACTER(6)
      4  FIRSTNME             VARCHAR(12)
      5  MIDINIT             CHARACTER(1)
      6  LASTNAME            VARCHAR(15)
      7  WORKDEPT            CHARACTER(3)
      8  PHONENO            CHARACTER(4)
      9  HIREDATE           DATE
     10  JOB                 CHARACTER(8)
     11  EDLEVEL            SMALLINT
     12  SEX                 CHARACTER(1)
Command ==>
F1=Help      F2=Split      F3=Exit      F4=CRetriev  F7=Up        Scroll PAGE
F9=Swap      F12=Cancel

```

Parent panels

- [Template Mapping panel on page 850](#)

Child panels

To display this panel...	Use/do this
Template Mapping panel on page 850	Press F3 or F12

Functions panel

You use the Functions panel to display information about the functions you have selected.

Panel and field definitions

The columns that are displayed include the SEL field and columns of SYSIBM.SYSROUTINES.

Process	Options	Utilities	Help		
FM/Db2 (DFG2)		Functions			Format <u>TABL</u>
Location:					
SEL	SCHEMA	NAME	ORIGINEX	OWNER	ROUTINEX
----	*-----*	*-----*	*-----*	*-----*	*-----*
----	#1-----	#3-----	#90-----1-----	#2-----	#89-----1-----2---
****	Top of data ****				
----	SHRIKE2	DT1	System generated	SHRIKE2	Function/Cast Function
----	SHRIKE2	CHAR	System generated	SHRIKE2	Function/Cast Function
----	SHRIKE2	DT1	System generated	SHRIKE2	Function/Cast Function
----	SHRIKES	CHAR80	System generated	SHRIKE2	Function/Cast Function
----	SHRIKES	CHAR	System generated	SHRIKE2	Function/Cast Function
----	SHRIKES	CHAR80	System generated	SHRIKE2	Function/Cast Function
----	SHRIKES	DOCMATCH	External	SHRIKES	Function/Cast Function
****	End of data ****				
Command ==>					Scroll <u>PAGE</u>
F1=Help	F2=Zoom	F3=Exit	F4=CRetriev	F5=RFind	F6=RChange
F7=Up	F8=Down	F9=Swap	F10=Left	F11=Right	F12=Cancel

**Note:**

1. The system option, **Show all catalog table columns**, affects which columns FM/Db2 displays when you use the Object List utility.
2. You can also customize which columns FM/Db2 displays when you use the Object List utility. For details, see the *File Manager Customization Guide*.

To view other columns on this panel, press the Right function key (F11).

For a complete list of columns, refer to “*Db2® catalog tables*” in the *DB2 for z/OS SQL Reference* relevant to your version of Db2®.

SEL

Line command area.

For a list of the line commands you can use on this panel, see [Table 22: Object list line commands on page 308](#).

Parent panels

- [Object List Utility panel on page 719](#)
- [Schemas panel on page 779](#)

Child panels

To display this panel...	Use/do this
Alter External Scalar Function panel on page 445	Line command A
See Comment panels on page 493	Line command COM

To display this panel...	Use/do this
Create Function panel on page 521	Line command CR
See Drop panels on page 621	Line command DR
Grant privileges panels on page 689	Line command G
Generate SQL From Db2 Catalog panel on page 686	Line command GEN
Details panels on page 618	Line command I
Privileges panels on page 736	Line command P
Routine Parameters panel on page 767	Line command PARM
Application Packages panel on page 460	Line command PKG
	Line command PS
Revoke privileges panels on page 766	Line command R
Distinct Types panel on page 619	Line command RDT
Display Row panel on page 619	Line command ROW
Schemas panel on page 779	Line command SCH
Sort Fields panel on page 804	Primary command SORT

Related tasks

- [Working with object list panels on page 301](#)
- [Using the line command area \(Cmd\) on page 308](#)

Related references

- [SORT primary command on page 941](#)

Generate SQL From Db2® Catalog panel

You use the Generate SQL From Db2® Catalog panel to specify how the generation of SQL from the Db2® catalog should work. You can specify which SQL statement types FM/Db2 should generate, and optionally which names and values should be changed.

Panel and field definitions

Process	Options	Utilities	Help
FM/Db2 (DFG2)	Generate SQL From Db2 Catalog		
Generate SQL statements for database : DSN8D10A +			
SQL statement types to be generated from the Db2 catalog:			
CREATE DATABASE	Y	GRANT access ON DATABASE . . .	Y
CREATE TABLESPACE	Y	GRANT access ON TABLESPACE . .	Y
CREATE TABLE	Y	GRANT access ON TABLE	Y
CREATE VIEW	Y	GRANT access ON VIEW	Y
CREATE INDEX	Y	ALTER TABLE ADD FOREIGN KEY . .	Y
CREATE SYNONYM	Y	LABEL ON	Y
CREATE ALIAS	Y	COMMENT ON	Y
CREATE TRIGGER	Y		
New names/values for generated SQL (leave blank to use current values):			
Object owner			+
Alloc TS size as	DEFINED	(DEFINED, USED, or ALLOC)	
Database name			
Storage group for TS			+
Storage group for IX			+
Target Db2 version		(Current Db2 version: 1015)	
Output file and execution mode:			
Data set name			
Data set disposition	OLD	(OLD, SHR, or MOD)	
Execution mode	BATCH	(BATCH or TSO)	
Commit statements per	-	(Db, tS, Tb, All, None)	
Db2 defaults handling	-	(Keep, or Remove)	
Command ==>			
F1=Help	F2=Split	F3=Exit	F4=Expand
F9=Swap	F10=Left	F11=Right	F12=Cancel

Generate SQL statements for database

Specify Y for each SQL statement type you want FM/Db2 to generate, and N for each SQL statement type you do not want generated.

Object owner

New owner (authorization ID) of the objects.

Alloc TS size as

Specifies how to generate the primary quantity:

DEFINED

Use the size defined in the catalog

USED

Use the size that actually is used

ALLOCATED

Use the allocated size

USED and **ALLOCATED** require that the STOSPACE utility has been run for the storage groups for the objects being generated.

Database name

New database name for the objects.

Storage group for TS

New storage group for the table spaces.

Storage group for IX

New storage group for the indexes.

Target Db2® version

Db2® level of generated SQL statements.

Data set name

An existing valid SPUFI input data set name, or as `SYSOUT=x`. `SYSOUT=*` is the default if the field is blank.

Data set disposition

The disposition of the output data set.

Execution mode

Specify:

BATCH

Generates a batch job

TSO

Runs the generation online

Commit statements per

When to generate COMMIT statements:

D

For each database

S

For each table space

T

For each table

A

For all objects

N

Never

Db2® defaults handling

Specifies how Db2® default parameters should be handled:

K

Keep Db2® default parameters

R

Remove Db2® default parameters

Parent panels

- [Databases panel on page 593](#)
- [Table Spaces panel on page 834](#)
- [Tables, Views and Aliases panel on page 843](#)
- [Indexes panel on page 697](#)
- [Schemas panel on page 779](#)
- [Distinct Types panel on page 619](#)
- [Functions panel on page 684](#)
- [Stored Procedures panel on page 813](#)

Child panels

None.

Related tasks

- [Reverse engineering on page 317](#)

Grant privileges panels

These panels are:

- Grant Application Plan Privileges panel
- Grant Buffer Pool Privileges panel
- Grant Collection Privileges panel
- Grant Column Privileges panel
- Grant Database Privileges panel
- Grant Distinct Type Privileges panel
- Grant Function Privileges panel
- Grant Package Privileges panel
- Grant Schema Privileges panel
- Grant Sequence Privileges panel
- Grant Storage Group Privileges panel
- Grant Stored Procedure Privileges panel
- Grant System Privileges panel
- Grant Table Privileges panel
- Grant Table Space Use Privileges panel

FM/Db2 displays one of these panels if you use the Privileges utility function (3.5) to grant privileges for an object type, or if you specify the G line command against an object displayed in a list of Db2® objects.

Format of grant privilege panels

Each grant privilege panel shows:

- The available privileges for the object type, with a corresponding single-character entry field in which you can specify one of the following values:

Y

Grants the specified privilege to the grantee, but does not permit the grantee to grant this privilege to other users.

G

Grants the specified privilege to the grantee, and permits the grantee to grant this privilege to other users.

A blank in the field indicates that the grantee does not have the specified privilege.



Note: To change an *existing* privilege, you must first revoke the existing privilege before granting the new privilege (if applicable) as described in this section.

- A field (for some types of privilege there are two fields), that you use to specify the name of the object for which the privilege is to be granted.
- A **To** field. Use this to specify the SQLID of the user to whom the privilege is to be granted.

Related tasks

- [Displaying privileges on page 334](#)
- [Working with lists of Db2 objects on page 297](#)
- [Granting privileges on page 335](#)
- [Revoking privileges on page 337](#)

Import Options panel

You use the Import Options panel to set either global or local import options, depending on how the panel is displayed.

Panel and field definitions

Process	Options	Utilities	Help
FM/Db2 (DG03)		Import Options	Global Settings
Import dataset:			
Data format		CSV Options	
<u>1</u>	1. FM/Db2 (SQLDA) format	-	Headings
	2. Db2 UNLOAD format	-	DBCS
	3. DSNTIAUL format	-	Single quotes
	4. User defined	-	Null indicator
	5. CSV	↵	CSV delimiter
Import Options:			
Duplicate key processing		Enter "/" to select option	
<u>1</u>	1. Ignore	-	Delete existing rows
	2. Update		
	Max duplicates <u>ALL</u>		
Auto Commit (Changes):			
	Auto-commit count . <u>0</u>		
Command ==>			
F1=Help	F2=Split	F3=Exit	F7=Backward F8=Forward F9=Swap
F12=Cancel			

Data format

Allows you to specify the data format that corresponds to the template or copybook used:

1. FM/Db2 (SQLDA) format
2. Db2® UNLOAD format
3. DSNTIAUL format
4. User defined
5. CSV

The default is 1. (FM/Db2 (SQLDA) format).

Duplicate key processing

1. Ignore

Ignores duplicate rows. This is the default.

2. Update

Updates duplicate rows when Db2® returns a duplicate row error (SQLCODE -803) in response to an INSERT SQL statement. When you select this option, FM/Db2 attempts to update the existing row. All columns of the table that are part of at least one unique index are used to identify the row. No comparison is made between the imported row and the existing row prior to the update operation (that is, the update is done regardless of whether the imported row and existing row are the same). When you use this option it is recommended that you specify a Db2® table name, rather than a view name. FM/Db2 does not attempt to update existing rows in a view defined on a view.

Max duplicates

The maximum number of duplicates permitted.

Valid values: A number in the range 0–9999999999, or ALL. The default is ALL.

Auto-commit count

Use this option to take progressive Db2® commit points as records are imported. Any positive value entered will cause FM/Db2 to issue a Db2® commit automatically after the specified number of successful Db2® changes. A successful Db2® change is either the successful insert of a record; or the successful update of a row when a duplicate key error is encountered on the insert. The change counter is reset after each Db2® commit is issued, so multiple Db2® commit points may be issued. Specify a zero value if no progressive Db2® commit points are required; in this case the Db2® commit is deferred until the end of the import utility and any error encountered during the import will cause all changes to be backed out. The default for this option is 0.

CSV Options

Headings

Select this option if the CSV data set to be imported includes headings.

DBCS

Select this option if the CSV data set to be imported includes double-byte data (DBCS) characters wrapped in shift-in (x'0E') and shift-out (x'0F') characters.

Single quotes

Select this option if the CSV data set to be imported has single quote encapsulation.

Null indicator

Use this field to specify the null indicator value that was used to represent a null value in the CSV input data set. A nullable column will be set to null when the corresponding CSV value has:

- A non-blank null indicator value.
- A null CSV value. For example, two successive delimiters ',,'.

CSV delimiter

Use this field to specify an alternate delimiter value to the comma "," character.

Delete existing rows

Deletes all the rows in the target table before importing. The default is not selected; that is, no rows are deleted from the target table.

Parent panels

- [Set Utility Options panel on page 803](#)
- [Import Utility \("From"\) panel on page 693](#)
- [Import Utility \("To"\) panel on page 694](#)

Child panels

None.

Related tasks

Import Utility ("From") panel

Panel and field definitions

<u>P</u> rocess	<u>O</u> ptions	<u>U</u> tilities	<u>H</u> elp
FM/Db2 (DFG2)			Import Utility
From Partitioned, Sequential or VSAM Data Set:			
Data set name . . .	'FMNUSER.EXPORT'		
Member	_____		
Volume	_____		
Start position . . .	<u>1</u>		
Import Count . . .	<u>ALL</u>		Number of rows to import
From Copybook or Template:			
Data set name . . .	'FMNUSER.TEMPLATE'		
Member	<u>EXPORT1</u>		
Processing Options:			
Template usage		Enter "/", "A" always to select option	
<u>1</u> 1. Above		_ Edit options	
2. Previous		_ Edit template	
Command ==>			
F1=Help	F2=Split	F3=Exit	F7=Backward F8=Forward F9=Swap
F12=Cancel			

You can select the following options by entering a / or an "A" (see [Selecting options on FM/Db2 panels on page 44](#)):

Edit template

Use to edit the template for the table from which you are importing the data, before importing the data. The default is not selected. For more details, see [Working with templates on page 72](#).

Edit options

Select this option to display the Import Options panel. The default is not selected.

Parent panels

- [Utility Functions panel on page 864](#)

Child panels

To display this panel...	Use/do this
Import Options panel on page 690	Select Edit options
Field Selection/Edit panel on page 679	Select Edit template

Related tasks

- [Selecting options on FM/Db2 panels on page 44](#)
- [Working with templates on page 72](#)

Import Utility ("To") panel

Panel and field definitions

```

Process  Options  Utilities  Help
-----
                From SHRIKE2.EXPORT.EMP
Command ==>

To Db2 Object:
  Location . . . . . Database . . . . . (optional)
  Owner . . . . . SHRIKE2 + Table space . . . . . (optional)
  Name . . . . . _____ +

To Template:                From SHRIKE2.FM.TEMPLATE(EMP)
  Data set name . . .
  Member . . . . . _____

Processing Options:
  Template usage          Enter "/", "A" always to select option
  3 1. Above              - Edit options
  2. Previous             - Edit template mapping
  3. Generate from table  - Batch execution
  4. Generate/Replace    - Create audit trail (*)
                          - Use REXX proc
                          REXX proc name . . _____

Command ==>
F1=Help   F2=Split   F3=Exit   F4=Expand   F7=Backward  F8=Forward
F9=Swap   F10=Left   F11=Right F12=Cancel
    
```

Location

The location name for the Db2® object. You can specify a generic name to select from a list. If you enter a value in this field, synonym object names are not recognized or included in the selection list.

Database

The database name for the Db2® object. You can use this field to optionally specify a database to further define the object to be processed. If you enter a value in this field:

- The values displayed in the **Owner** and **Name** selection lists are limited to those values defined within the specified database.
- Synonym names are not recognized or included in the selection list.

Owner

The name of the owner of the object. You can specify a generic name to select from a list. To specify a synonym in the object **Name** field, either leave this field blank, or specify a generic name that includes the current SQLID or specify the current SQLID. Synonyms are not recognized or included on the table selection list if any of the **Table space**, **Database**, or **Location** fields are non-blank.

If the **Translate Db2® object names** option is selected, lowercase characters are converted to uppercase. If this option is not selected, lowercase characters are not converted to uppercase; in this situation, a lowercase owner name such as "sysibm" does not match "SYSIBM" in the Db2® catalog.

Table space

The table space name for the Db2® object. To further define the object to be processed, you can use this field to optionally specify a table space. If you enter a value in this field:

- The values displayed in the **Owner** and **Name** selection lists are limited to those values defined within the specified table space.
- Synonym names are not recognized, nor included in the selection list.

Name

The name of the object name to be processed. You can specify a generic name to select from a list. To specify a synonym in this field, type the name of the synonym and ensure that the **Owner** field is blank, contains a generic name that includes the current SQLID, or contains the current SQLID. Synonyms are not recognized or included in the table selection list if any of the **Table space**, **Database**, or **Location** fields are non-blank.

If the **Translate Db2® object names** option is selected, lowercase characters are converted to uppercase. If this option is not selected, lowercase characters are not converted to uppercase; in this situation, a lowercase owner name such as *“sysibm”* does not match *“SYSIBM”* in the Db2® catalog.

Data set name

The name of the data set or PDS member containing the template for the *“To”* table. It can be a fully-qualified data set name or a pattern. The name may include a member name or name pattern in parenthesis. If the member is specified here, the associated **Member** field must be empty.

Member

If you specified the name of a partitioned data set (PDS) without including a member name or name pattern in parenthesis in the **Data set name** field, then you can use this field to specify the member name or a member name pattern.

The Import Utility *“To”* panel provides four options for template processing:

1. Above

Requires that you enter the name of a template in the **To Template** section of the panel.

2. Previous

Uses the last (previously used) template for this table.

3. Generate from table

Generates a template based on the information in the Db2® catalog for the specified table. This is the default setting. If you have specified a data set name in the **To Template** section of the panel, it is ignored. FM/Db2 generates the required template in memory.

4. Generate/Replace

Generates a template based on the information in the Db2® catalog for the specified table, and saves this information in the data set specified in the **To Template** section of the panel. If the template already exists, it is replaced and any prior customization is lost.

You can select the following options by entering a / or an “A”:

Edit options

Select this option to display the Import Options panel. The default is not selected.

Edit template mapping

Use to edit the template for the table to which you are importing the data, before importing the data. The default is not selected.

Batch execution

Builds the necessary JCL to perform the Import utility in a batch job. The default is not selected.

Create audit trail

Note: "*" is appended to the option name for SAF-controlled auditing when required by SAF rules.

Controls whether access to Db2® by FM/Db2 is written to the FM/Db2 audit log. This option only appears when SAF-rule controlled auditing is in effect.

FM/Db2 may write audit records to either SMF, or a data set.

When SAF rules are used to control FM/Db2 auditing, the decision to write audit records is based on the Db2® object name being processed, and the current userid (TSO logonid). Therefore auditing may be required when processing one Db2® object, but not another. In addition, it is possible that the auditing requirement cannot be changed for a particular Db2® object; this might be different for another Db2® object, and the requirement may be different for other TSO userids.

If you do not have the authority to change the audit setting when processing a particular Db2® object, FM/Db2 prompts you if you enter the wrong setting. If you do have the authority to set the audit setting for a particular Db2® object, FM/Db2 honors whatever value is specified in this field.

Use REXX proc

Use this option to perform either of these actions:

- Enter a temporary REXX procedure for one-time use by entering an asterisk (*). FM/Db2 displays a REXX edit panel that you can use to create a new REXX procedure. The default is not selected.
- Specify the name of the member containing the REXX procedure you want to use. The member must belong to the PDS allocated to ddname FMNEXEC. You can enter any of the following:
 - The name of the member.
 - A member name pattern (other than *) to list all matching members. You can then select the required member by entering an **S** in the **SEL** field. A member name pattern can consist of any characters that are valid in a member name and the following two special pattern characters:

asterisk (*)

Represents any number of characters. As many asterisks as required can appear anywhere in a member name. For example, if you enter *d*, a list of all members in the data set whose name contains "d" is displayed.

percent sign (%)

A place-holding character representing a single character. As many percent symbols as necessary can appear anywhere in a member name. For example, if you enter `%%%`, a list of all members in the data set whose name is four characters in length is displayed.



Note: The default for the member name is blank. If you select this option but leave the **Use REXX proc** field blank, FM/Db2 displays a member name list. You can then select the required member by entering `s` in the **Sel** field.

Parent panels

- [Import Utility \("From"\) panel on page 693](#)
- [Field Selection/Edit panel on page 679](#)

Child panels

To display this panel...	Use/do this
Import Options panel on page 690	Select Edit options

Related tasks

- [Working with templates on page 72](#)
- [Selecting options on FM/Db2 panels on page 44](#)
- [Using a REXX procedure with the Import utility on page 252](#)
- [Enhancing the Import utility using a REXX procedure on page 263](#)
- [SAF-rule controlled auditing on page 69](#)

Index Parts panel

FM/Db2 displays the Index Parts panel if you use the PT line command against an item listed on the [Indexes panel on page 697](#).

Indexes panel

You use the Indexes panel to list index object types in the Db2® catalog.

Panel and field definitions

The columns that are displayed include the SEL field and columns of SYSIBM.SYSINDEXES.

Process Options Utilities Help					
FM/Db2 (DFG2)		Indexes		Format TABL	
Location:					
SEL	CREATOR	NAME	TBNAME	TBCREATOR	UNIQUEE ⁺
----	*-----1--	*-----1-----	*-----1-----	*-----1--	*-----
****	Top of data	****			
----	CARLAND	XPMR91932	PMR91932	CARLAND	Unique
----	DSN8810	XACT1	ACT	DSN8810	Unique
----	DSN8810	XACT2	ACT	DSN8810	Yes
----	DSN8810	XCONA1	TCONA	DSN8810	Yes
----	DSN8810	XDEPT1	DEPT	DSN8810	Unique
----	DSN8810	XDEPT2	DEPT	DSN8810	Duplica
----	DSN8810	XDEPT3	DEPT	DSN8810	Duplica
----	DSN8810	XDSPTXT1	TDSPTXT	DSN8810	Yes
----	DSN8810	XEMP1	EMP	DSN8810	Unique
----	DSN8810	XEMP2	EMP	DSN8810	Duplica
----	DSN8810	XEMPPROJACT1	EMPPROJACT	DSN8810	Yes
Command	===>				Scroll PAGE
F1=Help	F2=Zoom	F3=Exit	F4=CRetriev	F5=RFind	F6=RChange
F7=Up	F8=Down	F9=Swap	F10=Left	F11=Right	F12=Cancel



Note:

1. The system option, **Show all catalog table columns**, affects which columns FM/Db2 displays when you use the Object List utility.
2. You can also customize which columns FM/Db2 displays when you use the Object List utility. For details, see the *File Manager Customization Guide*.

To view other columns on this panel, press the Right function key (F11).

For a complete list of columns, refer to “Db2® catalog tables” in the *DB2 for z/OS SQL Reference* relevant to your version of Db2®.

SEL

Line command area.

For a list of the line commands you can use on this panel, see [Table 22: Object list line commands on page 308](#).

Parent panels

- [Object List Utility panel on page 719](#)
- [Databases panel on page 593](#)
- [Tables, Views and Aliases panel on page 843](#)
- [Columns panel on page 491](#)
- [Application Packages panel on page 460](#)

Child panels

To display this panel...	Use/do this
Alter Index panel on page 446	Line command A
Columns in Index panel on page 492	Line command COL
Create Index panel on page 527	Line command CR
Databases panel on page 593	Line command D
See Drop panels on page 621	Line command DR
Generate SQL From Db2 Catalog panel on page 686	Line command GEN
Details panels on page 618	Line command I
Recovery Information panel on page 755	Line command ICS
Application Packages panel on page 460	Line command PKG
Application Plans panel on page 463	Line command PL
Index Parts panel on page 697	Line command PT
Display Row panel on page 619	Line command ROW
Tables, Views and Aliases panel on page 843	Line command T
Db2 Utilities panel on page 610	Line command UTL
Sort Fields panel on page 804	Primary command SORT

Related tasks

- [Working with object list panels on page 301](#)
- [Using the line command area \(Cmd\) on page 308](#)

Related references

- [SORT primary command on page 941](#)

Indexes and Columns for panel

FM/Db2 displays the Indexes and Columns for panel if you use the XC line command against an item listed on the [Tables, Views and Aliases panel on page 843](#).

ISPF Primary Option panel

Panel and field definitions

Menu	Utilities	Compilers	Options	Status	Help
ISPF Primary Option Menu					
0	Settings	Terminal and user parameters		User ID . . :	FMUSER
1	View	Display source data or listings		Time. . . :	15:11
2	Edit	Create or change source data		Terminal. :	3278
3	Utilities	Perform utility functions		Screen. . :	1
4	Foreground	Interactive language processing		Language. :	ENGLISH
5	Batch	Submit job for language processing		Appl ID . :	ISR
6	Command	Enter TSO or Workstation commands		TSO logon :	ISPFPROC
7	Dialog Test	Perform dialog testing		TSO prefix:	FMUSER
9	IBM Products	IBM program development products		System ID :	FMD2
10	SCLM	SW Configuration Library Manager		MVS acct. :	USER
11	Workplace	ISPF Object/Action Workplace		Release . . :	ISPF 5.0
F	File Manager	File Manager for z/OS®			
FD	FM/Db2	File Manager/Db2	◀	New	
Option ==>					
	F1=Help	F2=Split	F3=Exit	F7=Backward	F8=Forward
	F10=Actions	F12=Cancel			F9=Swap

Parent panels

- None.

Child panels

To display this panel...	Use/do this
Primary Option Menu panel on page 728	Select option for FM/Db2

Related tasks

ISPF Settings panel

You use the ISPF Settings panel display and modify selected ISPF parameters.

Related tasks

- [ISPF settings \(option 0.11\) on page 65](#)

Label Column panel

Panel and field definitions

<u>P</u> rocess	<u>O</u> ptions	<u>U</u> tilities	<u>H</u> elp
FM/Db2 (DFG2)		Label Column	
LABEL ON COLUMN			
Table owner	BUDGER2	+	
Table name	DEPT	+	
Column name	DEPTNAME		
IS			
Label		+	
Command ==>			
F1=Help	F2=Split	F3=Exit	F4=Expand
F9=Swap	F10=Left	F11=Right	F12=Cancel
		F7=Backward	F8=Forward

Parent panels

- [Columns panel on page 491](#)
- [Constraint Columns for panel on page 495](#)
- [Columns in Table panel on page 493](#)

Child panels

None.

Related tasks

Label Table panel

Panel and field definitions

<u>P</u> rocess	<u>O</u> ptions	<u>U</u> tilities	<u>H</u> elp
FM/Db2 (DFG2)		Label Table	
LABEL ON TABLE			
Owner	BUDGER2	+	
Name	EMP	+	
IS			
Label		+	
Command ==>			
F1=Help	F2=Split	F3=Exit	F4=Expand
F9=Swap	F10=Left	F11=Right	F12=Cancel
		F7=Backward	F8=Forward

Parent panels

- [Tables, Views and Aliases panel on page 843](#)

Child panels

None.

Related tasks

LISTCAT Output Display panel

FM/Db2 displays the LISTCAT Output Display panel when you use the LC line command on the Recovery Information panel or the Table Space Parts panel.

LISTDEF Options panel

You use the LISTDEF Options panel to collect information used in generating LISTDEF statements and the proper JCL statement to access the LISTDEF library in a utility batch job.

Panel and field definitions

<u>P</u> rocess	<u>O</u> ptions	<u>U</u> tilities	<u>H</u> elp
FM/Db2 (DFG2)	LISTDEF Options		Global Settings
Enter RESET to restore installation defaults.			
LISTDEF Library Option:			
JCL DD statement:		No DD stmt is generated if field is blank	
//	SYSLISTD DD	_____	
//	DD	_____	
//	DD	_____	
//	DD	_____	
Initial Utility Statement Option:			
Utility statement:		No statement is generated if field is blank	
	LISTDEF	_____	

Additional statements:			
Enter "/" to select options			
- Use additional statements			
- Edit additional statements			
Command ==>			
F1=Help	F2=Split	F3=Exit	F4=CRetriev
F8=Forward	F9=Swap	F10=Actions	F12=Cancel
F6=Reset	F7=Backward		

JCL DD statement

The information used to generate the JCL DD statement. This information is:

DD name

A read-only field. This holds the value specified in the **LISTDEFDD DD name** field of the OPTIONS Options panel ([OPTIONS Options panel on page 721](#)). If the library field is blank then no DD statement is generated in the utility batch job. The default is blank.

Text values

The values entered on these four lines are used directly to generate the DD statement, provided that the **DD name** field is not blank.

Utility statement

This value is used to generate the initial utility statements. If the field is blank, and the **Use additional statements** option is not selected, then no LISTDEF statement is generated into the utility batch job. If the field is non-blank, then the specified LISTDEF is generated with any additional LISTDEF statements supplied when the Use additional statements option is selected. The default is blank.

Use additional statements

If this option is set then more than one LISTDEF statement may be generated into the utility batch job. Select the **Edit additional statements** option to edit additional statements. Only LISTDEF specifications that have non-blank input fields are used in the generation. The default is not selected.

If this option is not selected, then only a non-blank value in the **Utility statement** field is used to generate the LISTDEF statement.

Edit additional statements

When you select this option and press Enter, the Additional LISTDEF Statements panel ([Additional LISTDEF Statements panel on page 440](#)) is displayed. After you have entered values on this panel and exited the panel, this option is deselected. The additional statements are used when you select the Use additional statements option. The default is not selected.

The LISTDEF Library Option panel has an installation-defined default. You can restore the default for the library option by entering the RESET command or pressing the RESET PF key. Each subsystem has its own installation-defined defaults. RESET also clears the **Use additional statements** option and any values in the **Utility statement** fields.

For more information, see LISTDEF and OPTIONS statements in *DB2 Utility Guide and Reference*.

Child panels

To display this panel...	Use/do this
Additional LISTDEF Statements panel on page 440	Select the Edit additional statements option.

Related tasks

- [RESET primary command on page 932](#)
- [Setting options for Db2 utilities on page 341](#)
- [Db2 Utility LISTDEF options \(option 3.UL\) on page 67](#)

LOAD from panel

You use the LOAD Utility: "To" template panel to specify the template for the target Db2® table when you use the LOAD utility.

Panel and field definitions

Process	Options	Utilities	Help
Load from template LODINDDN			
Target Db2 Table:			
Owner	FMNUSER		+
Name	EMP		+
To Template:			
Data set name	_____		
Member	_____		
Processing Options:			
Template usage	Enter "/", "A"lways to select option		
<u>3</u> 1. Above	_ Edit LOAD utility options		
2. Previous	_ Edit template mapping		
3. Generate from table			
4. Generate/Replace			
Command ==>			
F1=Help	F2=Split	F3=Exit	F4=Expand
F9=Swap	F10=Left	F11=Right	F12=Cancel
			F7=Backward
			F8=Forward

Table owner

The name of the owner for the target table. You can specify a generic object name to select from a list. This field is mandatory.

Table name

The name of the target table. You can specify at generic object name to select from a list. This field is mandatory.

Data set name

The name of the data set or PDS member containing the template for the "To" object. It can be a fully-qualified data set name or a pattern. The name may include a member name or name pattern in parenthesis. If the member is specified here, the associated **Member** field must be empty.

Member

If you specified the name of a partitioned data set (PDS) without including a member name or name pattern in parenthesis in the **Data set name** field, then you can use this field to specify the member name or a member name pattern.

Template usage

The LOAD Utility: “To” template panel provides four options for template processing:

1. Above

Requires that you enter the name of a template in the **To Template** section of the panel.

2. Previous

Uses the last (previously used) template for this table.

3. Generate from table

Generates a template based on the information in the Db2® catalog for the specified table. This is the default setting. If you have specified a data set name in the **To Template** section of the panel, it is ignored. FM/Db2 generates the required template in memory.

4. Generate/Replace

Generates a template based on the information in the Db2® catalog for the specified table, and saves this information in the data set specified in the **To Template** section of the panel. If the template already exists, it is replaced and any prior customization is lost.

You can select the following options by entering a / or an “A”:

Edit load utility options

Displays the Load Utility Options panel

Edit template mapping

Use to edit the template for the table to which you are importing the data, before importing the data.

Parent panels

- [LOAD Utility - Using Templates panel on page 708](#)

Child panels

To display this panel...	Use/do this
LOAD Utility Options panel on page 710	Select Edit LOAD utility options
Template Mapping panel on page 850	Select Edit template mapping

Related tasks

- [LOAD utility on page 349](#)
- [Working with templates on page 72](#)
- [Selecting options on FM/Db2 panels on page 44](#)

LOAD Utility panel

You use the LOAD Utility panel to specify details about the data you want to load.

Panel and field definitions

```

Process  Options  Utilities  Help
-----
FM/Db2 (DB26)                                LOAD Utility

Input Data:
Data set name . . . _____
Member . . . . . _____
Volume . . . . . _____

Utility Control Statements:
Data set name . . . _____
Member . . . . . _____

Target Db2 Table:
Table owner . _____ Database . . _____ (optional)
Table name . _____ Table space _____ (optional)

Select Option:
1 1. The data is described by utility control statements
2 2. The data is described by a template or copybook

Command ==>
F1=Help      F2=Split    F3=Exit     F4=CRetriev F7=Backward F8=Forward
F9=Swap      F10=Actions F12=Cancel
    
```

Data set name (Input Data)

A sequential or partitioned data set that contains the data to be loaded into the Db2® table. Specify a generic data set name to select from a list. It can be a fully-qualified data set name or a pattern. The name may include a member name or name pattern in parenthesis. If the member is specified here, the associated **Member** field must be empty.

Member (Input Data)

If you specified the name of a partitioned data set (PDS) without including a member name or name pattern in parenthesis in the **Data set name** field, then you can use this field to specify the member name or a member name pattern.

Volume

The volume serial number if the data set is not cataloged.

Data set name (Utility Control Statements)

A sequential or partitioned data set that contains the Db2® load utility control statements. Specify a generic data set name to select from a list. It can be a fully-qualified data set name or a pattern. The name may include a member name or name pattern in parenthesis. If the member is specified here, the associated **Member** field must be empty.

Member (Utility Control Statements)

If you specified the name of a partitioned data set (PDS) without including a member name or name pattern in parenthesis in the **Data set name** field, then you can use this field to specify the member name or a member name pattern.

Table owner

The name of the owner for the target table. You can specify a generic object name to select from a list. This field is mandatory.

Database

A fully or partially-qualified database name to limit the list of object names to the specified databases.

Table name

The name of the target table. You can specify a generic object name to select from a list. This field is mandatory.

Table space

A fully or partially-qualified table space name to limit the list of object names to the specified table spaces.

1. The data is described by utility control statements

Use the supplied Db2® load utility control statements when generating a Db2® load utility batch job.

2. The data is described by a template or copybook

Use a template or copybook when generating a Db2® load utility batch job.

Parent panels

- [Db2 Utilities panel on page 610](#)

Child panels

To display this panel...	Use/do this
LOAD Utility - Using Templates panel on page 708	Select option 2

Related tasks

- [LOAD utility on page 349](#)

LOAD Utility panel using Db2® templates

You use the LOAD Utility using Db2® templates panel to load new data into tables and build or extend any indexes defined on those tables.

Panel and field definitions

Process	Options	Utilities	Help
FM/Db2 (DFG2)			LOAD Utility
Input Data:			
Template name . . .	LODINDDN		
Target Db2 Table:			
Owner	_____	+	Database . . _____ (optional)
Name	_____		Table space _____ (optional)
			+
Command ==>			
F1=Help	F2=Split	F3=Exit	F4=Expand
F9=Swap	F10=Left	F11=Right	F12=Cancel

Parent panels

- [Db2 Utilities panel on page 610](#)

Child panels

To display this panel...	Use/do this
LOAD Utility - Using Templates panel on page 708	Press Enter

Related tasks

- [LOAD utility on page 349](#)

LOAD Utility - Using Templates panel

You use the LOAD Utility - Using Templates panel to specify the "From" copybook or template that describes the input data.

Panel and field definitions

<u>P</u> rocess	<u>O</u> ptions	<u>U</u> tilities	<u>H</u> elp
FM/Db2 (DFG2) LOAD Utility - Using Templates			
Input Data Template or Copybook:			
Data set name . . . _____			
Member _____			
Processing Options:			
Template usage Enter "/", "A"lways to select option			
<u>1</u> 1. Above _ View template			
2. Previous			
Command ==> _____			
F1=Help F2=Split F3=Exit F7=Backward F8=Forward F9=Swap			
F12=Cancel			

Data set name

A sequential or partitioned data set that contains the data to be loaded into the Db2® table. Specify a generic data set name to select from a list. It can be a fully-qualified data set name or a pattern. The name may include a member name or name pattern in parenthesis. If the member is specified here, the associated **Member** field must be empty.

Member

If you specified the name of a partitioned data set (PDS) without including a member name or name pattern in parenthesis in the **Data set name** field, then you can use this field to specify the member name or a member name pattern.

Template usage

The LOAD Utility - Using Templates panel provides two options for template processing:

1. Above

Requires that you enter the name of a template in the **Input Data Template or Copybook** section of the panel.

2. Previous

Uses the last (previously used) template for this table.

You can select the following option by entering a / or an "A":

View template

Select this option to edit the "To" template.

Parent panels

- [LOAD Utility panel on page 706](#)

Child panels

To display this panel...	Use/do this
Record Type Selection panel on page 748	Select Edit template
LOAD from panel on page 704	Press Enter

Related tasks

- [LOAD utility on page 349](#)
- [Selecting options on FM/Db2 panels on page 44](#)

LOAD Utility Options panel

You use the LOAD Utility Options panel to specify the options that apply when you use the LOAD utility to transfer data.

These options are saved in your ISPF profile and persist from one FM/Db2 session to the next.

Panel and field definitions

```

  Process  Options  Utilities  Help
  -----
  FM/Db2 (DFG2)                Load Utility Options                Global Settings

  Utility Options:
  Enter "/" to select option
  [ ] Preformat unused pages
  [ / ] Log changes                --NO-->  _ Do not set COPY pending flag
  [ ] Use IEEE floating point
  [ ] Allow substitution chars
  [ ] Enforce constraints
  [ ] Resume (append new data)    --NO-->  _ Replace existing data
  [ ]                               _ Reuse existing dataset
  [ ] Build indexes in parallel
  [ ]   Number of index keys 10_____

  CCSID Values:
  SBCS data . . . . . 0_____ (0 for installation default)
  Mixed DBCS data . . . . . 0_____ (0 for installation default)
  DBCS data . . . . . 0_____ (0 for installation default)

  Discarded Records:
  Maximum discards . . . . 0_____ (0 means no limit)

  Encoding Scheme
  1 1. EBCDIC
  2 2. ASCII
  3 3. UNICODE

  Command ==> _____
  F1=Help    F2=Split    F3=Exit    F7=Backward  F8=Forward  F9=Swap
  F12=Cancel
  
```

Preformat unused pages

Indicates whether the allocated file space for a table is preformatted to enable quicker INSERT processing. The default is not selected.

Log changes

Indicates whether Db2® logs details in the Db2® log of the rows that are loaded. The default is selected.

Do not set COPY pending flag

If **Log changes** is not selected, indicates whether Db2® is *not* to set the table space in COPY pending status. The default is not selected.

Use IEEE floating point

Indicates whether floating-point numbers are in IEEE Binary Floating Point (BFP) format. The default is not selected.

Allow substitution chars

Indicates whether the LOAD utility accepts substitution characters in a string. The default is not selected.

Enforce constraints

Indicates whether the LOAD utility enforces check constraints and referential constraints. The default is selected.

Resume (append new data)

Indicates whether records are loaded into an empty or non-empty table space, without existing data being deleted. The default is not selected.

Replace existing data

If **Resume (append new data)** is not selected, indicates whether the table space and all its indexes are reset to empty before records are loaded. The default is not selected.

Reuse existing dataset

If **Resume (append new data)** is selected, indicates whether the LOAD utility logically resets and reuses Db2-managed data sets without deleting and redefining them. The default is not selected.

Build indexes in parallel

Indicates whether index keys are sorted in parallel during LOAD. The default is not selected.

Number of index keys

An estimated number of index keys to sort. The default is 10.

SBCS data

The coded character set for SBCS data in the input file. The default is 0.

Mixed DBCS data

The coded character set for mixed DBCS data in the input file. The default is 0.

DBCS data

The coded character set for DBCS data in the input file. The default is 0.

Maximum discards

The maximum number of discarded records allowed before LOAD abends. The default is 0.



Note: FM/Db2 does not attempt to validate every possible combination of load utility options. In particular, some combinations of options fail given the current state of the Db2® object being loaded. This can mean that the Db2® load utility job will fail if an invalid combination of options has been specified. If this occurs examine the failing messages for the Db2® LOAD utility job and respond accordingly.

Encoding Scheme

Indicates the encoding scheme for the data to be loaded. The encoding scheme applies to character and graphic data only.

1. EBCDIC

The data is encoded by using an EBCDIC CCSID. This is the default.

2. ASCII

The data is encoded by using an ASCII CCSID.

3. UNICODE

The data is encoded in unicode (either CCSID 1208 or CCSID 1200).

Parent panels

- None.

Child panels

None.

Related tasks

- [Db2 LOAD utility options \(option 3.L\) on page 67](#)
- [LOAD utility on page 349](#)

Manage Db2® Privileges panel

You use the Manage Db2® Privileges panel to display, grant, and revoke Db2® privileges.

Panel and field definitions

Process	Options	Utilities	Help
FM/Db2 (DFG2)		Manage Db2 Privileges	
blank Display privileges		G Grant privileges	
R Revoke privileges			
Object Identification Criteria:			
Location	_____	Enter * for list	
Owner	_____	+	
Name	_____	+	
In	_____	+	Database/table/collection/schema
Processing Options:			
Object Type			
3	1. Database	7. Collection	13. Buffer pool
	2. Table space	8. Schema	14. System
	3. Table	9. Type	15. Sequence
	4. Column	10. Function	
	5. Plan	11. Stored procedure	
	6. Package	12. Storage group	
Command ==>			
F1=Help	F2=Split	F3=Exit	F4=Expand
F9=Swap	F10=Left	F11=Right	F12=Cancel
			F7=Backward F8=Forward

Location

The location of the objects you want listed.

Owner

The name of the person who created the Db2® object.

Name

The name of the Db2® object.

In

An optional field you can use to qualify certain object types.

Object Type

The type of Db2® object against which privilege operations are to be performed. The default is 3 (**Tables**).

Parent panels

- [Utility Functions panel on page 864](#)

Child panels

To display this panel...	Use/do this
Privileges panels on page 736	Blank command line
Grant privileges panels on page 689	"G" on command line
Revoke privileges panels on page 766	"R" on command line

Related tasks

- [Managing Db2 privileges on page 332](#)

Object List Line Commands panel

FM/Db2 displays the Object List Line Commands panel if you use the ? line command against an item listed on one of these panels:

- [Application Plans panel on page 463](#)
- [Collections panel on page 471](#)
- [Columns panel on page 491](#)
- [Database Request Modules panel on page 591](#)
- [Databases panel on page 593](#)
- [Distinct Types panel on page 619](#)
- [Functions panel on page 684](#)
- [Indexes panel on page 697](#)
- [Application Packages panel on page 460](#)
- [Schemas panel on page 779](#)
- [Stored Procedures panel on page 813](#)
- [Synonyms panel on page 815](#)
- [Table Spaces panel on page 834](#)
- [Tables, Views and Aliases panel on page 843](#)
- [Triggers panel on page 853](#)

Related tasks

- [Line command query \(?\) on page 314](#)

Object List Options (1 of 2) panel

You use the FM/Db2 Object List Options (1 of 2) panel to set various options that affect the way in which FM/Db2 operates. These options are saved in your ISPF profile and persist from one FM/Db2 session to the next.

Panel and field definitions

Figure 123. FM/Db2 Object List Options (1 of 2) panel

Process	Options	Utilities	Help
FM/Db2 (DFG2)	FM/Db2 Object List Options (1 of 2)		Global Settings
Object List Utility Options:			
Enter "/" to select option			
- Show all catalog table columns			
- Show "unused" catalog table columns			
- Show "internal use only" catalog table columns			
/ Use automatic column sizing			
/ Use extended column name headings			
/ Interpret columns containing codes			
/ Modify order of columns displayed			
Row count 1000		Maximum number of rows to fetch	
More Options:			
Enter "/" to select option			
/ Display widths, filtering			
Command ==>			
F1=Help	F2=Split	F3=Exit	F7=Backward F8=Forward F9=Swap
F10=PrvPage	F11=NxtPage	F12=Cancel	

Show all catalog table columns

Display of catalog table information includes every available column, including any columns marked as "unused" or "internal use only" in the *DB2 for z/OS SQL Reference*. This option overrides any settings for the **Show "unused" catalog table columns** and **Show "internal use only" catalog table columns** options.

The default is not selected.

Show "unused" catalog table columns

Display of catalog table information includes columns marked as "unused" in the *DB2 for z/OS SQL Reference*. This option can be overridden by selecting the **Show all catalog table columns** option.

The default is not selected.

Show "internal use only" catalog table columns

Display of catalog table information includes columns marked as "internal use only" in the *DB2 for z/OS SQL Reference*. This option can be overridden by selecting the **Show all catalog table columns** option.

The default is not selected.

Use automatic column sizing

Varying-length (VARCHAR) columns of the catalog table being displayed may be automatically sized, based on the data stored within the column. Automatic column sizing determines the longest data value in each varying column as the data is read from Db2®. This value is then used to set the display width for the column, prior to the data being displayed.

The default is selected.

Use extended column name headings

Column names for the catalog table being processed are replaced by longer, more meaningful, column headings.

The default is selected.

Interpret columns containing codes

Selected columns in the Db2® catalog table being processed are expanded, based on the value stored within the column. This feature typically operates on one-character columns that contain a code. As an example, the TYPE column in SYSIBM.SYSTABLES is a one-character code containing A,G,M,T,V, or X. The expanded text for these codes is "Alias", "Created global temporary table", "Materialized query table", "Table", "View", and "Auxiliary Table".

This option is useful if you are not familiar with the meanings of the codes in the various Db2® catalog tables. Selecting this option overrides any setting for the **Use extended column name headings** option, and sets that option on.

The default is selected.

Modify order of columns displayed

Columns in the Db2® catalog table may be re-ordered from the order as defined in the Db2® catalog. In addition certain columns may be marked as held. This feature is intended to place the most important columns from the catalog table on the left of the display, in the most logical order. These columns are held, and do not move when scrolling left and right.

The default is selected.

Row count

Limits the number of rows fetched from the Db2® catalog. The value entered applies to:

- Object List selection panels displayed by FM/Db2 functions such as the editor, print, copy, import, export, and data create. For more information on object list selection, see [Specifying a Db2 object name on page 999](#). Note that FM/Db2 functions such as edit, copy, print, and so on also have a **Row count** field on the function entry panel. Once an object has been selected, the function entry **Row count** field acts to control the number of rows processed in the specified Db2® object.
- Object lists displayed by these FM/Db2 functions:
 - Object List Utility (3.4).
 - Object Privileges Utility (3.5).
 - Explain Utilities (4.5).

A value of 0 or ALL specifies no limit; all rows from the relevant catalog tables are fetched and displayed. When you specify 0, FM/Db2 accesses the Db2® catalog using *large mode*, thereby minimizing storage usage for the list of Db2® objects.

If you experience "insufficient storage" conditions, you can specify a value to limit the number of rows fetched from Db2®. Another way to limit the number of rows fetched in the Object List utility (option 3.4) is to specify selection criteria on the function entry panel.

The default is 1000.

Display widths, filtering

Select this option to navigate to the second Object List Options panel. The default is selected. The Object List utility displays information in Db2® catalog tables. Some of the columns within those tables are defined as varying columns with potentially very long maximum lengths.

You can use the **Use automatic column sizing** option to reduce the maximum display width for varying columns to the maximum that is needed to display the data for each column.

Additional control can be achieved by specifying minimum and maximum display widths for the various column types shown on the panel. All values are optional. (See [Object List Options \(2 of 2\) panel on page 717](#). A minimum value ensures that the display width is at least the value specified, even if there is no displayable data for the column in all rows processed. Specifying a minimum value does not prevent the display width expanding, if needed, to accommodate longer data.

Parent panels

- [Set Processing Options panel on page 795](#)

Child panels

To display this panel...	Use/do this
Object List Options (2 of 2) panel on page 717	Press the NxtPage function key (F11)

Related tasks

- [Setting default processing options on page 60](#)
- [FM/Db2 system options \(option 0.2\) on page 63](#)
- [TIME columns on page 165](#)
- [INDEXINF primary command on page 911](#)
- ["No Primary Key" errors on page 198](#)
- ["Row Not Found" errors on page 200](#)

Related references

- [SQL primary command on page 942](#)

Object List Options (2 of 2) panel

You use the FM/Db2 Object List Options (2 of 2) panel to set various options that affect the way in which FM/Db2 operates. These options are saved in your ISPF profile and persist from one FM/Db2 session to the next.

Panel and field definitions

Figure 124. FM/Db2 Object List Options (2 of 2) panel

<u>P</u> rocess	<u>O</u> ptions	<u>U</u> tilities	<u>H</u> elp
FM/Db2 (DFG2)	FM/Db2 Object List Options (2 of 2)		Global Settings
Display width for varying columns: Enter minimum and maximum values for each column type			
		Min	Max
Databases		<u>8</u>	<u>8</u>
Column names		<u>8</u>	<u>30</u>
Authorization identifiers		<u>8</u>	<u>16</u>
Object names		<u>8</u>	<u>30</u>
Remarks		<u>8</u>	<u>60</u>
Other		<u>8</u>	<u>60</u>
Filtering: Enter "/" to select option Reposition to first matching row			
Command ==> _____			
F1=Help	F2=Split	F3=Exit	F7=Backward F8=Forward F9=Swap
F10=PrvPage	F12=Cancel		

Allows you to specify the minimum and maximum display widths for the various column types shown on the object list panel. All values are optional.

Min

Ensures that the display width is at least the value specified, even if there is no displayable data for the column in all rows processed. Specifying a minimum value does not prevent the display width expanding, if needed, to accommodate longer data.

Max

Limits the maximum display width to the value specified, even if data in some rows has a longer width. Specifying a maximum value does not prevent the display width being set to a smaller value, if no rows have data exceeding the value specified.

The following column types are available:

Databases

The name of a Db2® database or table space. The default minimum and maximum values are both 8.

Column names

The name of a Db2® column. The default minimum and maximum values are 8, 30.

Authorization identifier

A Db2® authorization identifier, for example the current SQLID. The default minimum and maximum values are 8, 16.

Object Names

The name of a Db2® object, such as a table, view or alias. The default minimum and maximum values are 8, 30.

Remarks

Applies to columns that are used to store data that is entered by using the COMMENT ON or LABEL ON statements. The default minimum and maximum values are 8, 60.

Other

Applies to any column that does not match the preceding types. The default minimum and maximum values are 8, 60.

Reposition to first matching row

This setting affects how data is displayed after you change the filter values for one or more columns. Use filters to limit the rows that are displayed. The default is not selected.

When you select this setting, the data that is shown after you change the filter values is repositioned to the first matching row.

Parent panels

- [Set Processing Options panel on page 795](#)

Child panels

To display this panel...	Use/do this
Object List Options (1 of 2) panel on page 714	Press the PrvPage function key (F10)

Related tasks

- [Setting default processing options on page 60](#)
- [FM/Db2 system options \(option 0.2\) on page 63](#)
- [TIME columns on page 165](#)
- [INDEXINF primary command on page 911](#)
- ["No Primary Key" errors on page 198](#)
- ["Row Not Found" errors on page 200](#)

Related references

- [SQL primary command on page 942](#)

Object List Utility panel

You use the Object List Utility panel to specify details about the objects you want to list or print.

Panel and field definitions

```

Process  Options  Utilities  Help
-----
FM/Db2 (DFG2)                Object List Utility

blank Display object list          P Print object list

Object Identification Criteria:
Location . . . . . _____ Enter * for list
Owner . . . . . _____ +
Name . . . . . _____ +
Database/collect/schema _____ +

Additional Selection Criteria:
. . . . . Enter * to list catalog columns
Column . . . . . _____
Operator . . . . . _____
Value . . . . . _____ +

Processing Options:
Object Type          Enter ? to list all object types
3 1. Database        8. Package          15. Trigger
2. Table space      9. Collection        16. Storage group
3. Table/view/alias 10. DBRM             17. Sequence
4. Index            11. Schema           18. Role
5. Column           12. Distinct type    19. Trusted context
6. Synonym          13. Function
7. Plan             14. Stored procedure

Enter "/" to select option
/ Confirm object drop

When the object list is displayed, enter either:
"?" on the object list command field for the command prompt panel, or
"=" execute the previous command.
Command ==>
F1=Help    F2=Split    F3=Exit    F4=Expand    F7=Backward  F8=Forward
F9=Swap    F10=Left    F11=Right   F12=Cancel
    
```

Location

The location of the objects you want listed

Owner

The name of the person who created the Db2® object

Name

The name of the Db2® object

Database/collect/schema

The name of a database, a collection, or a schema

Column

Name of column in the relevant Db2® system catalog table

Operator

A valid SQL operator

Value

The value to be compared with the contents of the column

Object Type

The type of Db2® object that you want listed. The default is 3 (**Tables**).

Confirm object drop

Indicates if you want FM/Db2 to display a confirmation panel each time you enter a DR(op) command against an object

Parent panels

- [Utility Functions panel on page 864](#)

Child panels

To display this panel...	Use/do this
Databases panel on page 593	Object Type 1
Table Spaces panel on page 834	Object Type 2
Tables, Views and Aliases panel on page 843	Object Type 3
Indexes panel on page 697	Object Type 4
Columns panel on page 491	Object Type 5
Synonyms panel on page 815	Object Type 6
Application Plans panel on page 463	Object Type 7
Application Packages panel on page 460	Object Type 8
Collections panel on page 471	Object Type 9
Database Request Modules panel on page 591	Object Type 10
Schemas panel on page 779	Object Type 11
Distinct Types panel on page 619	Object Type 12
Functions panel on page 684	Object Type 13
Stored Procedures panel on page 813	Object Type 14
Triggers panel on page 853	Object Type 15

Related tasks

- [Working with lists of Db2 objects on page 297](#)

OPTIONS Options panel

You use the OPTIONS Options panel to collect information used in generating an OPTIONS statement in a utility batch job.

Panel and field definitions

Process	Options	Utilities	Help
FM/Db2 (DFG2)	OPTIONS Options		Global Settings
Processing Options:		RESET restores installation options	
4	1. Do not create		
	2. OFF		
	3. KEY		
	4. Use the below options		
	Enter "/" to select options		
	PREVIEW		
/	LISTDEFDD DD name	SYSLISTD	
/	TEMPLATEDD DD name	SYSTEMPL	
-	EVENT(Event spec)		
	Event spec:		

Command ==>			
F1=Help	F2=Split	F3=Exit	F4=CRetriev F6=Reset F7=Backward
F8=Forward	F9=Swap	F10=Actions	F12=Cancel

Processing Options

The options in capitals are keywords that are used in the OPTIONS statement if the option is selected. The default is 1 (**Do not create**). For more information, see OPTIONS statement in *DB2 Utility Guide and Reference*.

The processing options are:

1. Do not create

When this option is selected, FM/Db2 does not create the OPTIONS statement in a utility batch job.

2. OFF

When this option is selected, FM/Db2 restores all default options in a utility batch job.

3. KEY

When this option is selected, FM/Db2 uses the KEY clause in the OPTIONS statement.

You should only use this option when instructed to do so by IBM® Support. Enter the value provided by IBM® Support in the **KEY** field. The default for the **KEY** field is blank.

4. Use the below options:

When this option is selected, you can select other keywords for addition to the OPTIONS statement. The relevant keyword is only added to the OPTIONS statement if the option is selected. The options are:

PREVIEW

When this option is selected, the generated utility batch job, when executed, runs in PREVIEW mode. This option corresponds to the PREVIEW keyword in an OPTIONS statement. The default is not selected.

LISTDEFDD

When this option is selected, it specifies the DD name of the LISTDEF definition library. The default DD name for the input field is "SYSLISTD". You can enter a different DD name. The specified DD name appears as a read-only field in the [LISTDEF Options panel on page 702](#).

This option corresponds to the LISTDEFDD clause in an OPTIONS statement. The default is not selected.

TEMPLATEDD

When this option is selected, it specifies the DD name of the TEMPLATE definition library. The default DD name for the input field is "SYSTEMPL". You can enter a different DD name. The specified DD name appears as a read-only field in the [TEMPLATE Options \(1 of 2\) panel on page 846](#).

This option corresponds to the TEMPLATEDD clause in an OPTIONS statement. The default is not selected.

EVENT

When this option is selected, the utility batch job includes the specified events or events. Enter the events on the following lines. You must enter at least one. The values you enter are placed immediately after the EVENT keyword in the OPTIONS statement, without further validation by FM/Db2.

This option corresponds to the EVENT clause in an OPTIONS statement.

The default is not selected. The default for the **Event spec** field is blank.

All fields have installation-defined defaults. You can reset all values to the installation defaults (site policy) at will by using the RESET command or RESET PF Key. Each subsystem has its own installation-defined defaults.

As an example, the following clauses are added to any generated OPTION statement when the options in the figure are selected:

- LISTDEFDD SYSLISTD
- TEMPLATEDD SYSTEMPL

For the Db2® defaults settings of SYSLISTD for LISTDEFDD and SYSTEMPL for TEMPLATEDD, it is also acceptable to "optimize", which means to not generate these clauses, since they are the Db2® defaults.

Child panels

None.

Related tasks

- [RESET primary command on page 932](#)
- [Setting options for Db2 utilities on page 341](#)
- [Db2 Utility OPTIONS options \(option 3.UO\) on page 68](#)

Package Dependencies panel

FM/Db2 displays the Package Dependencies panel if you use the DEP line command against an item listed on the [Application Packages panel on page 460](#).

Child panels

None.

Related tasks

Package List panel

FM/Db2 displays the Package List panel if you use the PKL line command against an item listed on:

- The [Application Plans panel on page 463](#), or
- The [Application Packages panel on page 460](#), or
- The [Collections panel on page 471](#)

Related tasks

Parents of Table panel

FM/Db2 displays the Parents of Table panel if you use the PAR line command against an item listed on the [Tables, Views and Aliases panel on page 843](#).

Partitioned Table Statistics panel

FM/Db2 displays the Partitioned Table Statistics panel if you use the PST line command against an item listed on the [Tables, Views and Aliases panel on page 843](#).

Plan Dependencies panel

FM/Db2 displays the Plan Dependencies panel if you use the DEP line command against an item listed on the [Application Plans panel on page 463](#).

Plan Enabled/Disabled Connections panel

FM/Db2 displays the Plan Enabled/Disabled Connections panel if you use the EDC line command against an item listed on the [Application Plans panel on page 463](#).

Plan Table Rows panel

FM/Db2 displays the Plan Table Rows panel if you:

- Select option L (List plan table rows) on the Explain Utilities panel, or
- Enter the EXPLAIN primary command on the Enter, Execute and Explain SQL Statements with the **Show results** option selected.

Use this panel to display rows from a plan table.

Figure 125. Plan Table Rows panel (collection ID format)

```

  Process  Options  Utilities  Help
  FM/Db2 (DFG2)                Plan Table Rows                                Row 1 to 1 of 1

    Query Q  Collect.  Prognam  Pl M Ac M  I T  Table
    Number Bl (COLLID) (Packg)  No T Ty Co 0 No Owner + Table Name +
    _____* * * _____* * * * * * * * * * * * * * * * * * * * * * * * * * * * * *
    ____  42 1  FMN2APR4  FMN2D2I0  1  0 R  0  N  1  SYSIBM  SYSTABLES
    ***** END OF Db2 DATA *****

Command ==> _____ Scroll PAGE
F1=Help      F2=Split      F3=Exit      F4=Expand    F7=Backward  F8=Forward
F9=Swap      F10=Left      F11=Right    F12=Cancel

```

The Plan Table Rows panel shows you rows from a plan table:

C

Input field where you can enter one of the following line commands:

D

Delete row

DK

Delete rows for package

DP

Delete rows for plan

DQ

Delete rows for query number

FR

Show function table rows. FM/Db2 displays the Function Table Rows panel (not shown).

I

Interpret EXPLAIN data

IH

Insert optimizer hint

K

Show package

M

Show DBRM

P

Show plan

SR

Show statement table rows. FM/Db2 displays the Statement Table Rows panel (see [Statement Table Rows panel on page 808](#)).

T

Show table

UH

Update optimizer hint

X

Show index

Query Number

A number that identifies the SQL statement.

Q BI

Query block number: the number reflects the query's order of appearance in the EXPLAIN statement.

Collect.

Collection ID or blank for dynamic EXPLAIN. This information only is displayed for the COL format of the panel.

Applname

PLAN name or blank for dynamic EXPLAIN. This information only is displayed for the PLAN format of the panel.

Hint ID

Optimization hint ID or blank for dynamic EXPLAIN. This information only is displayed for the HINT format of the panel.

Progrname

DBRM/package name. This information only is displayed for the COL and PLAN formats of the panel.

Hint Used

The optimization hint used or blank for dynamic EXPLAIN. This information only is displayed for the HINT format of the panel.

PI No

Plan number. Indicates order in which the statement is run.

M T

Method: Join method that is used.

Ac Ty

Access type. Method of accessing the table.

M Co

Matching columns. Number of index keys used in an index scan.

I O

Index only. Whether only the index is accessed in this step.

T No

Table number. Position of the table in the statement.

Table Owner

Owner of the table being accessed.

Table Name

Name of the table being accessed.

Parent panels

- [Explain Utilities panel on page 662](#)

Child panels

To display this panel...	Use/do this
EXPLAIN Interpretation panel on page 662	Line command I

To display this panel...	Use/do this
Set Optimizer Hint panel on page 788	Line commands IH, UH
Application Packages panel on page 460	Line command K
Statement Table Rows panel on page 808	Line command SR
Tables, Views and Aliases panel on page 843	Line command T

Related tasks

- [Explaining SQL on page 419](#)
- [Managing tables used by SQL explain on page 422](#)

Related references

- [COL primary command on page 880](#)
- [PLAN primary command on page 926](#)
- [HINT primary command on page 910](#)

Primary Key for Table panel

FM/Db2 displays the Primary Key for Table panel if you use the PK line command against an item listed on the [Tables, Views and Aliases panel on page 843](#).

Primary Option Menu panel

You use the Primary Option Menu panel to select the FM/Db2 function you want to perform.

Panel and field definitions

<u>P</u> rocess	<u>O</u> ptions	<u>U</u> tilities	<u>H</u> elp
FM/Db2 (DF72)		Primary Option Menu	
0	Settings	Set processing options	User ID . . : SHRIKE2
1	View	View Db2 object	System ID : FMD2
2	Edit	Edit Db2 table	Appl ID . . : FMN2
3	Utilities	Perform utility functions	Version . . : 15.1.6
4	SQL	Prototype, execute and analyze SQL	Terminal . . : 3278
5	Db2I	Start Db2 Interactive	Screen . . . : 1
6	Command	Enter and execute a Db2 Command	Date : 2018/11/04
7	Template	Template utilities	Time : 11:22
X	Exit	Terminate FM/Db2	Db2 SSID . . : DF72
			SQL ID . . . : SHRIKE2
Command ==>			
F1=Help	F2=Split	F3=Exit	F4=Expand
F9=Swap	F10=Left	F11=Right	F12=Cancel
		F7=Backward	F8=Forward

Parent panels

- (z/OS® Primary Option Menu)

Child panels

To display this panel...	Use/do this
Set Processing Options panel on page 795	Option 0
Db2 View panel on page 613	Option 1
Db2 Edit panel on page 598	Option 2
Utility Functions panel on page 864	Option 3
SQL Prototyping, Execution and Analysis panel on page 806	Option 4
Db2I Primary Option Menu panel on page 618	Option 5
Enter and Execute Db2 Commands panel on page 659	Option 6
Db2 Browse panel on page 595	Enter "B" on command line

Related tasks

- [Viewing and changing Db2 data on page 119](#)

Print Audit Trail panel

You use the Print Audit Trail panel to specify the name of the Audit Trail data set to be used to generate an Audit Trail report.

Panel and field definitions

<u>P</u> rocess	<u>O</u> ptions	<u>U</u> tilities	<u>H</u> elp
FM/Db2 (DFG2)		Print Audit Trail	
Audit Trail:			
Data set name		_____	
Description		_____	
Processing Options:			
Enter "/" to select option		Formatted display options	
/	Print only changed columns	2	1. Hex Format
-	Keep data set after printing		2. Non-display Hex
/	Browse report	/	Highlight changes
-	Batch execution		
Command ==> _____			
F1=Help	F2=Split	F3=Exit	F7=Backward F8=Forward F9=Swap
F12=Cancel			

Data set name

The name of the Audit Trail data set to be used.

Description

A description for the report. If the descriptions contains blanks, you must enclose it in quotation marks. This field is optional.

You can select the following options by entering a "/" in the selection field:

Print only changed columns

Limits the amount of printed lines.

Keep data set after printing

Whether to keep or delete the data set after it is printed.

Browse report

The audit trail report is displayed using Print Browse (option 3.11).

Batch execution

Generates JCL for printing the audit trail report using a batch job. For command syntax, see the AUD function in File Manager User's Guide and Reference.

Hex Format

To produce an UPDOWN hexadecimal display below the standard field display.

Non-display Hex

To produce an UPDOWN hexadecimal display below the standard field display only for fields that contain non-displayable \ characters.

Highlight changes

Highlight the changed fields. An asterisk is placed to left of the before data to indicate the field has been changed.

Parent panels

- [Utility Functions panel on page 864](#)

Child panels

None.

Related tasks

- [Printing an audit trail report on page 328](#)

Print Utility Options panel

You use the Print Utility Options panel to set various options for the Print utility.

Panel and field definitions

```

  Process  Options  Utilities  Help
  -----
FM/Db2 (DFE2)                Print Utility Options

Processing Options:                Null Column Indicator:
  Print mode                        Display . . . . . _
  1 1. Table
  2 2. Single

Enter "/" to select option
/ Batch execution
/ Use uncommitted read
_ Print HEX representation

Command ==> _____
F1=Help      F2=Split      F3=Exit      F7=Backward  F8=Forward  F9=Swap
F12=Cancel

```

Print Mode

The format of the print output. The default is 1 (**Table**):

1. Table

In Table print mode (the default mode), the rows of the table are formatted into columns and printed horizontally across the page. Each column has a heading of either the column name or a heading specified by you. Multiple rows are printed on each page. Each column of the table is formatted according to the data type for that column. For example, numeric data types are printed

as whole or decimal numbers, and date and time columns are printed as dates or times. Print data might be truncated, depending on the LRECL of the print data set.

2. Single

In Single mode, only one column of the table is printed on each line of the page. The columns of the table are arranged vertically on the page, with the column header on the left of the page, and the data for that column on the right. Each column of the table is formatted according to the data type for that column. For example, numeric data types are printed as whole or decimal numbers, and date and time columns are printed as dates or times.

Display

Null Column Display Indicator. This option, applying to columns that allow Db2® nulls only, allows you to specify a character to represent the Db2® null value for the FM/Db2 print utility. The default is the underscore character.

Batch execution

Builds the necessary JCL to perform the Print function in a batch job. The generated JCL is displayed using the ISPF editor, where you can review the JCL and submit the job for batch processing. The default is selected, that is, the print is executed in batch.

Use uncommitted read

Enables data to be read that has not yet been committed. The default setting is selected; that is, FM/Db2 uses uncommitted read when retrieving the data from Db2®.



Note: If FM/Db2 attempts to retrieve data that has a write lock, an SQL error might result.

Print HEX representation

Prints the hexadecimal representation of the data. The default is not selected; that is, the data is not printed in hexadecimal format.

Parent panels

- [Set Processing Options panel on page 795](#)
- [Print Utility panel on page 733](#)

Child panels

None.

Related tasks

- [Printing the contents of a Db2 table on page 321](#)
- [Selecting options on FM/Db2 panels on page 44](#)

Print Utility panel

You use the Print Utility panel to print the contents of a table or view.

Panel and field definitions

Process	Options	Utilities	Help
FM/Db2 (DFG2)		Print Utility	
Db2 Object:			
Location	_____	Database	_____ (optional)
Owner	SYSIBM	+	Table space _____ (optional)
Name	SYSCOPY		_____ +
Row count	20	Number of rows to print	
Db2 Template:			
Data set name	_____		
Member	_____		
Processing Options:			
Print Mode	Template usage	Enter "/", "A" always to select	
3 1. Above		-	Edit options
2. Previous		-	Edit template
3. Generate from table		-	Create audit trail (*)
4. Generate/Replace			
Command ==>			
F1=Help	F2=Split	F3=Exit	F4=Expand
F9=Swap	F10=Left	F11=Right	F12=Cancel
	F7=Backward	F8=Forward	

Location

The location of the Db2® object. Leave this field blank if the table or view that you want to work with is at your current location. This field is optional.

database

The name of the database to which you want to restrict your selection. This field is optional.

Owner

The authorization ID of the owner of the Db2® object. This field is optional.

Table space

The name of the table space to which you want to restrict your selection. This field is optional.

Name

The name of the Db2® object.

Row count

The number of rows of the Db2® object you want to print.

Valid values:

0

All rows printed

1-99999999

Number of rows printed

ALL

All rows printed. This is the default.

Data set name

The name of the template data set. It can be a fully-qualified data set name or a pattern. The name may include a member name or name pattern in parenthesis. If the member is specified here, the associated **Member** field must be empty.

Member

If you specified the name of a partitioned data set (PDS) without including a member name or name pattern in parenthesis in the **Data set name** field, then you can use this field to specify the member name or a member name pattern.

Processing Options

You can use these options to specify, amongst other things, the format in which you want the data printed, which template you want to use for the print process, and whether you want to edit the template before the print process.

Template usage

The Print Utility panel provides four options for template processing:

1. Above

Requires that you enter the name of a template data set (and optionally a member name) in the **Template** section of the panel. If you do not specify a member name, or if you specify a pattern, FM/Db2 displays a member selection list. After you have specified the member containing a template, processing continues using this template in place of the automatically-generated template for the table (for a detailed explanation, see Template Usage option 3).

2. Previous

Uses the last (previously used) template for this table.

3. Generate from table

Generates a template based on the information in the Db2® catalog for the specified table. This is the default setting. If you have specified a member name in the **Template** section of the panel, it is ignored. FM/Db2 generates the required template in memory.

4. Generate/Replace

Generates a template based on the information in the Db2® catalog for the specified table, and saves this information in the member specified in the **Template**

section of the panel. If the member already exists, it is replaced. Any prior customization is lost.

You can select the following options by entering a “/” or an “A”:

Edit options

Use to display the FM/Db2 print utility options, prior to printing the data for the Db2® object. The default is not selected.

Edit template

Use to edit the template before printing the data. The default is not selected.

Create audit trail

Controls whether access to Db2® by FM/Db2 is written to the FM/Db2 audit log. This option only appears when SAF-rule controlled auditing is in effect.

FM/Db2 may write audit records to either SMF, or a data set.

When SAF rules are used to control FM/Db2 auditing, the decision to write audit records is based on the Db2® object name being processed, and the current userid (TSO logonid). Therefore auditing may be required when processing one Db2® object, but not another. In addition, it is possible that the auditing requirement cannot be changed for a particular Db2® object; this might be different for another Db2® object, and the requirement may be different for other TSO userids.

If you do not have the authority to change the audit setting when processing a particular Db2® object, FM/Db2 prompts you if you enter the wrong setting. If you do have the authority to set the audit setting for a particular Db2® object, FM/Db2 honors whatever value is specified in this field.

Parent panels

- [Utility Functions panel on page 864](#)
- [Tables, Views and Aliases panel on page 843](#)

Child panels

To display this panel...	Use/do this
Print Utility Options panel on page 731	Select Edit options
Column Selection/Edit panel on page 485	Select Edit template

Related tasks

- [Printing the contents of a Db2 table on page 321](#)
- [Selecting options on FM/Db2 panels on page 44](#)
- [Working with templates on page 72](#)
- [SAF-rule controlled auditing on page 69](#)

Privilege details panels

These panels are:

- Application Plan Privilege Details panel
- Column Privilege Details panel
- Database Privilege Details panel
- Distinct Type Usage Privilege Details panel
- Function Privilege Details panel
- Package Privilege Details panel
- Schema Privilege Details panel
- Stored Procedure Privilege Details panel
- Table Space Use Privilege Details panel
- Table/View Privilege Details panel

FM/Db2 displays one of these panels when you specify the I line command against an object displayed in a privilege list of Db2® objects.

Privileges panels

These panels are:

- Application Plan Privileges panel
- Collection Privileges panel
- Column Privileges panel
- Database Privileges panel
- Distinct Type Privileges panel
- Function Privileges panel
- Package Privileges panel
- Schema Privileges panel
- Stored Procedure Privileges panel
- Table Privileges panel
- Table Space Use Privileges panel

FM/Db2 displays one of these panels if you use the Privileges utility function (3.5) to display privilege details for an object type, or if you specify the P line command against an object displayed in a list of Db2® objects.

Format of privilege display panels

All of the privilege display panels use an ISPF table display of information retrieved from the Db2® catalog. You can scroll through the information in a typical ISPF manner. The information is presented in read-only format.

For each privilege display panel:

- You can use the **Cmd** field to enter a line command. The line commands you can enter vary according to the object type. To display a list of valid line commands for the type of objects you are viewing, enter a “?” in the **Cmd** field.
- Single-character fields show the current status for each privilege that can apply to the object type listed:

Blank

The grantee does not have the specified privilege.

Y

The grantee has the specified privilege, but cannot grant this privilege to other users.

G

The grantee has the specified privilege, and can grant this privilege to other users.

- At the top of each column of data, immediately below the column name, there are input fields. When the panel is initially displayed, all of these input fields contain an asterisk (*) indicating “all values”. You can use one or more of these input fields to restrict the list of objects listed. For example, by specifying `BRA` in the entry field below the **Grantor** column name on the Database Privileges panel shown in [Privileges panels on page 736](#), the list of databases is restricted to those where the name of the grantor starts with “BRA”.

Related tasks

- [Displaying privileges on page 334](#)
- [Working with lists of Db2 objects on page 297](#)

Rebind Application Plan panel

Panel and field definitions

Figure 126. Rebind Application Plan panel (1 of 2)

<u>P</u> rocess	<u>O</u> ptions	<u>U</u> tilities	<u>H</u> elp
FM/Db2 (DFG2)	Rebind Application Plan		
Verify rebind parameters:			
REBIND PLAN(
Plan name	FMN2PLN1		
) OWNER(
Plan owner	SHRIKES	+	
) QUALIFIER(
Qualifier	SHRIKES	+	(qualifier for unqualified SQL)
) ENABLE(
Enable connects . .			(use ? to get current values from the catalog)
) DISABLE(
Disable connects .			(use ? to get current values from the catalog)
)			
En/disable names .			(use ? to get current values from the catalog)
) PKLIST(
Package lists . . .			(use ? to get current values from the catalog)
) NOPKLIST(
No package list . .			(Yes or No to remove current package list)
) DEFER(PREPARE)/NODEFER(PREPARE)			
Defer prepare . . .	-		(Yes or No)
) CACHE(
Cache size	3072		(Cache size in bytes for authorization IDs)
) CURRENTDATA(
Inhibit blocking .	-		(Yes or No)
) CURRENT SERVER(
Server name			(blank=local, else first location)
DEGREE(
Parallelism	1		(1 or ANY)
) DISCONNECT(
Disconnect	E		(Explicit, Automatic or Conditional)
) DYNAMICRULES(
Dynamic rules . . .	-		(Run or Bind)
) ENCODING(
Encoding scheme . .			(ASCII, EBCDIC, UNICODE, ccsid)
) EXPLAIN(
Explain plan . . .	N		(Yes or No to explain access path)

Figure 127. Rebind Application Plan panel (2 of 2)

```

) FLAG(
  Bind messages . . . _      (Info, Warning, Error, Completion)
) IMMEDIATE(
  Group BP updates . N      (No or Yes)
) ISOLATION(
  Isolation level . . _     (CS, RR, RS, or UR)
) KEEP DYNAMIC(
  Keep dynamic SQL . N     (Yes or No)
) REOPT(VARS)/NOREOPT(VARS)
  Re-opt at exec . . N     (None, Always, Once, aUto)
) OPTHINT(
  Access path hint . _____ +
) PATH(
  UDT/UDF/STP path . _____ +
) PATHDEFAULT
  Default path . . . _     (Yes or No)
) RELEASE(
  Release at . . . . C     (Commit or Deallocate, Commit preferred)
) ROUNDING(
  DFP Rounding . . . _    (Ceiling, Down, Floor,
                          HalfDown, HalfEven, HalfUp, Up)
) SQLRULES(
  Connect2 rules . . D    (Db2 or STD)
) VALIDATE(
  Validation time . . B    (Run or Bind, Bind preferred)
) CONCURRENTACCESSRESOLUTION(
  Access Resolution . _   (Waitforoutcome or Usecurrentlycommitted)
) PROGAUTH(
  Progauth checking . _   (Disable or Enable)
)
Command ==>
  F1=Help      F2=Split      F3=Exit      F4=Expand      F7=Backward  F8=Forward
  F9=Swap      F10=Left     F11=Right   F12=Cancel

```

Parent panels

- [Application Plans panel on page 463](#)

Child panels

None.

Related tasks

Rebind Package panel

Panel and field definitions

Figure 128. Rebind Package panel (1 of 2)

<u>P</u> rocess	<u>O</u> ptions	<u>U</u> tilities	<u>H</u> elp
FM/Db2 (DFM3)		Rebind Package	More: +
Verify rebind parameters:			
REBIND PACKAGE(
Location	_____		
Collection	DSNUTIL		+
Package	DSNUGSQL	+ (
Version	_____		+
)) OWNER(
Package Owner . . .	ARROWSB		+
) QUALIFIER(
Qualifier	ARROWSB		+
) ENABLE((use ? to get current values from the catalog)			
Enable connects . .	_____		+
) DISABLE((use ? to get current values from the catalog)			
Disable connects . .	_____		+
) (use ? to get current values from the catalog)			
En/disable names . .	_____		+
PLANMGMT(
Plan management . .	_	(Off, Basic, Extended or blank)	
) APREUSE(
Reuse access paths	N	(None, Error or Warn)	
) APREUSESOURCE(
Package copy	_	(Current, Previous or Original)	
) APCOMPARE(
Comp access paths . .	_	(None, Error or Warn)	
) APRETAINDUP(
Retain old copies . .	Y	(Yes or No)	
) GETACCELARCHIVE(
Archived Accel data	_	(No or Yes)	
) QUERYACCELERATION((None, All, Enable, enableWithfailback, eligible)			
Acceleration option	_		
) CONCENTRATESTMT(
Concentrate stmt. . .	N	(No or Yes)	
) CURRENTDATA(
Inhibit blocking . .	N	(Yes or No)	
) DBPROTOCOL(
3 part protocol . . .	D	(DRDA)	
) DEFER(PREPARE) / DEFER(INHERITFROMPLAN) / NODEFER(PREPARE)			
Defer prepare	_	(Yes, Inherit or No)	
) DEGREE(
Parallelism	1	(1 or ANY)	
) DESCSTAT(
Describe SQL area . .	Y	(No or Yes)	
) DYNAMICRULES(
Dynamic rules	__	(Run, Bind, Define, Invoke)	
) ENCODING(
Encoding scheme . . .	EBCDIC	(ASCII, EBCDIC, UNICODE, ccsid)	

Figure 129. Rebind Package panel (2 of 2)

```

) EXPLAIN(
  Explain plan . . . N      (Yes, No or Only)
) FLAG(
  Bind messages . . . -      (Info, Warning, Error, Completion)
) IMMEDIATEWRITE(
  Group BP updates . N      (Inheritfromplan, No or Yes)
) ISOLATION(
  Isolation level . . ---    (CS, RR, RS, or UR)
) KEEP DYNAMIC(
  Keep dynamic SQL . N      (No or Yes)
) REOPT(VARS)/NOREOPT(VARS)
  Re-opt at exec . . N      (None, Always, Once, aUto)
) OPTHINT(
  Access path hint . _____ +
) PATH(
  UDT/UDF/STP path . _____ +
) PATHDEFAULT
  Default path . . . -      (Yes or No)
) RELEASE(
  Release at . . . . C      (Commit, Deallocate, Inheritfromplan)
) SWITCH(
  Package version . N      (Previous, Original)
) VALIDATE(
  Validation time . . B      (Run or Bind, Bind preferred)
) EXTENDEDINDICATOR(
  Extended Indicators ---    (No or Yes)
) CONCURRENTACCESSRESOLUTION(
  Access Resolution . -      (Waitforoutcome or Usecurrentlycommitted)
) BUSINESSSENSITIVE(
  Business Time Sens. Y      (Yes or No)
) SYSTEMSENSITIVE(
  System Time Sens. . Y      (Yes or No)
) ARCHIVESENSITIVE(
  Archive Sensitivity Y      (Yes or No)
) APPLCOMPAT(
  Appl. Compatibility V12R1  (V10R1 or V11R1)
)
Command ==> _____
F1=Help      F2=Split      F3=Exit      F4=Expand      F7=Backward  F8=Forward
F9=Swap      F10=Left     F11=Right   F12=Cancel

```

Parent panels

- [Application Packages panel on page 460](#)

Child panels

None.

Related tasks**REBUILD (Indexes for Table Spaces) panel**

You use the REBUILD (Indexes for Table Spaces) panel to generate utility control statements using the REBUILD INDEX (ALL) TABLESPACE form of REBUILD utility.

Panel and field definitions

Process		Options		Utilities		Help				
FM/Db2 (DFG2)		REBUILD (Indexes for Table Spaces)		Row 1 to 12 of 133						
S	P	Table	Part'n	WORKDDN	Sort	Sort	Sort			
e	R	Space	Number	Template	Device	Num	Keys			
l	C	Database	Reuse	WORKDDN	Type					
		DSN8D81A	DSN8S81D	0	N	SYSUT1	N	SYSALLDA	4	Y
		DSN8D81A	DSN8S81E	1	N	SYSUT1	N	SYSALLDA	4	Y
		DSN8D81A	DSN8S81E	2	N	SYSUT1	N	SYSALLDA	4	Y
		DSN8D81A	DSN8S81E	3	N	SYSUT1	N	SYSALLDA	4	Y
		DSN8D81A	DSN8S81E	4	N	SYSUT1	N	SYSALLDA	4	Y
		DSN8D81A	DSN8S81E	5	N	SYSUT1	N	SYSALLDA	4	Y
		DSN8D81A	DSN8S81P	0	N	SYSUT1	N	SYSALLDA	4	Y
		DSN8D81A	DSN8S81R	0	N	SYSUT1	N	SYSALLDA	4	Y
		DSN8D81A	DSN8S81S	0	N	SYSUT1	N	SYSALLDA	4	Y
		DSN8D81E	DSN8S81U	0	N	SYSUT1	N	SYSALLDA	4	Y
		DSN8D81P	DSN8S81C	0	N	SYSUT1	N	SYSALLDA	4	Y
		DSN8D81P	DSN8S81Q	0	N	SYSUT1	N	SYSALLDA	4	Y
Command ==>						Scroll PAGE				
F1=Help		F2=Split		F3=Exit		F7=Backward		F8=Forward		F9=Swap
F12=Cancel										

Sel

Selection column. To select a table space, type S in this column. Selected table spaces show an asterisk (*) in the **PRC** column.

PRC

Processing indicator. An asterisk (*) indicates the item is selected.

Database

The name of the database in which the table space is defined.

Table Space

The name of the table space.

Part'n Number

The partition number for the table space. This is 0 for a non-partitioned table space. For a partitioned table space, the number represents the partition of the table space. There is one row in the table for each partition of a partitioned table space. This is a display-only field.

Reuse

Controls whether Db2® deletes and redefines the index space data set as part of the rebuild operation:

YES

Keeps the existing data set.

NO

Deletes and redefines the index space data set.

WORKDDN

The ddname for the optional temporary work file used by the utility job. The value displayed is either SYSUT1, or another value if you have changed the default ddname. You can type a new value.

WORKDDN Template

Indicates whether the value of the associated **WORKDDN** field is a template name.

Sort Device Type

The device type used by the utility to allocate sort data sets. The value displayed is either SYSALLDA, or another value if you have changed the default device type. You can type a new value.

Sort Num

The number of sort data sets used by the utility. The value displayed is either 4, or another value if you have changed the default setting. You can type a new value.

Sort Keys

Controls whether the REBUILD utility rebuilds indexes in parallel:

YES

Builds the indexes in parallel.

NO

Does not build the indexes in parallel.

You can type a new value.

Parent panels

- [Db2 Utilities panel on page 610](#)

Child panels

None.

Related tasks

- [REBUILD utility on page 357](#)
- [REBUILD utility \(indexes for table spaces\) on page 359](#)
- [Loading data described by a copybook or template on page 353](#)

REBUILD (Indexes for Table Spaces) with LISTDEF panel

You use the REBUILD (Indexes for Table Spaces) with LISTDEF panel to generate utility control statements using the REBUILD INDEX TABLESPACE form of the REBUILD utility.

Panel and field definitions

```

Process  Options  Utilities  Help
-----  -
FM/Db2 (DFG2)          REBUILD (Indexes for Table Spaces)          Row 1 to 1 of 1

      P
      R LISTDEF
Cmd C Name              Reuse WORKDDN  WORKDDN  Device  Sort  Sort
      LDEF1              N  SYSUT1    N        SYSALLDA 4      Y
***** Bottom of data *****

Command ==>
F1=Help      F2=Split      F3=Exit      F7=Backward  F8=Forward  F9=Swap
F12=Cancel
    
```

Cmd

You can enter commands in this field to manipulate the panel rows.

I(n)

Insert (n) new row(s)

R(n)

Repeat the current row (n times)

D(n)

Delete (n) row(s)

S(n)

Select (n) rows(s)

An asterisk (*) in the PRC column shows that the LISTDEF in the row is selected. The S command toggles the selection of rows; unselected rows become selected and selected rows become unselected.

LISTDEF Name

On entry to the panel, this field is set to the value in the **LISTDEF name** field in the Db2® Utilities panel.

Parent panels

- [Db2 Utilities panel on page 610](#)

Child panels

None.

Related tasks

- [REBUILD utility on page 357](#)
- [REBUILD utility \(indexes for table spaces\) on page 359](#)

REBUILD Utility (Indexes) panel

You use the REBUILD Utility (Indexes) panel to generate utility control statements using the REBUILD INDEX (index_name) form of the REBUILD utility.

Panel and field definitions

Process	Options	Utilities	Help				
FM/Db2 (DFG2)		REBUILD Utility (Indexes)		Row 1 to 1 of 1			
P				Sort			
R	LISTDEF			WORKDDN	Device	Sort	Sort
Cmd	C Name	Reuse	WORKDDN	Template	Type	Num	Keys
	<u>LDEFNAME1</u>	N	<u>SYSUT1</u>	N	<u>SYSALLDA</u>	<u>4</u>	<u>Y</u>
***** Bottom of data *****							
Command ==>							
F1=Help	F2=Split	F3=Exit	F4=Expand	F7=Backward	Scroll PAGE		
F9=Swap	F10=Left	F11=Right	F12=Cancel	F8=Forward			

Cmd

Selection column. To select an index, type S in this column. Selected indexes show an asterisk (*) in the **PRC** column.

PRC

Processing indicator. An asterisk (*) indicates the item is selected.

Index Owner

The name of the owner of the index.

Index Name

The name of the index.

Part'n Number

The partition number for the index. This is 0 for a non-partitioned index. For a partitioned index, the number represents the partition of the index. There is one row in the table for each partition of a partitioned index. This is a display-only field.

Reuse

Controls whether Db2® deletes and redefines the index data set as part of the rebuild operation:

YES

Keeps the existing data set.

NO

Deletes and redefines the index data set.

WORKDDN

The ddname for the optional temporary work file used by the utility job. The value displayed is either SYSUT1, or another value if you have changed the default ddname. You can type a new value.

WORK DDN Template

Indicates whether the value of the associated **WORKDDN** field is a template name.

Sort Device Type

The device type used by the utility to allocate sort data sets. The value displayed is either SYSALLDA, or another value if you have changed the default device type. You can type a new value.

Sort Num

The number of sort data sets used by the utility. The value displayed is either 4, or another value if you have changed the default setting. You can type a new value.

Sort Keys

Controls whether the utility rebuilds indexes in parallel:

YES

Builds the indexes in parallel.

NO

Does not build the indexes in parallel.

Parent panels

- [Db2 Utilities panel on page 610](#)

Child panels

None.

Related tasks

- [REBUILD utility on page 357](#)
- [REBUILD utility \(indexes\) on page 358](#)
- [Loading data described by a copybook or template on page 353](#)

REBUILD (Indexes) with LISTDEF panel

You use the REBUILD (Indexes) with LISTDEF panel to generates utility control statements using the REBUILD INDEX TABLESPACE form of the REBUILD utility.

Panel and field definitions

Process	Options	Utilities	Help
FM/Db2 (DFG2)		REBUILD Utility (Indexes)	Row 1 to 2 of 2
P	R LISTDEF		Sort
Cmd C	Name	Reuse WORKDDN	Template Type Num Keys
	FRED	N SYSUT1	N SYSALLDA 4 Y
	* GEORGE	N SYSUT1	N SYSALLDA 4 Y
***** Bottom of data *****			
Command ==> _____ Scroll PAGE			
F1=Help F2=Split F3=Exit F7=Backward F8=Forward F9=Swap			
F12=Cancel			

Cmd

You can enter commands in this field to manipulate the panel rows.

I(n)

Insert (n) new row(s)

R(n)

Repeat the current row (n times)

D(n)

Delete (n) row(s)

S(n)

Select (n) rows(s)

An asterisk (*) in the PRC column shows that the LISTDEF in the row is selected. The S command toggles the selection of rows; unselected rows become selected and selected rows become unselected.

LISTDEF Name

On entry to the panel, this field is set to the value in the **LISTDEF name** field in the Db2® Utilities panel.

Parent panels

- [Db2 Utilities panel on page 610](#)

Child panels

None.

Related tasks

- [REBUILD utility on page 357](#)
- [REBUILD utility \(indexes\) on page 358](#)

Record Type Selection panel

Panel and field definitions

Process	Options	Utilities	Help			
File Manager		Record Type Selection		Line 1 of 2		
Cmd SIE	Field Name		Prompt	Offset	Length	
----	IE REC-TYPE01	**** Top of data ****		0	80	
----	SI REC-TYPE02			0	80	
		**** End of data ****				
Command ==>						Scroll PAGE
F1=Help	F2=Split	F3=Exit	F4=CRetriev	F5=RFind	F6=RunTemp	
F7=Up	F8=Down	F9=Swap	F12=Cancel			

Parent panels

- [LOAD Utility - Using Templates panel on page 708](#)

Child panels

None.

Related tasks

RECOVER Utility (Index Spaces) panel

You use the RECOVER Utility (Index Spaces) panel to generate utility control statements using the RECOVER INDEXSPACE form of the RECOVER utility. You can only copy and recover indexes that have been created with the COPY YES clause.

Panel and field definitions

Process	Options	Utilities	Help
FM/Db2 (DFG2)		RECOVER Utility (Index Spaces)	Row 1 to 7 of 7
S e l	Database	Index Space	DS Num
			ICDATE
			ICTIME
			Re- use
			Image Copy Data Set Name
—	GKDB1	XDEPT1	0 010914 072244 N GKELLY.GKDB1.XDEPT1.F00000.D257072
—	GKDB1	XDEPT1	0 010913 145941 N GKELLY.GKDB1.XDEPT1.F00000.D256145
—	GKDB1	XDEPT1	0 010913 145747 N GKELLY.GKDB1.XDEPT1.F00000.D256145
—	GKDB1	XDEPT1	0 010913 144945 N GKELLY.GKDB1.XDEPT1.F00000.D256144
—	UTILBIG1	T14RIX1	0 010701 160346 N OSPEED.ICOPY.UTILBIG1.T14RIX1.D182
—	UTILBIG1	UVBR1X1	0 010701 160524 N OSPEED.ICOPY.UTILBIG1.UVBR1X1.D182
—	UTILDB1	T1RIX1	0 010411 104512 N OSPEED.UTILDB1.T1RIX1.F00000.D1011
***** Bottom of data *****			
Command ==> _____ Scroll PAGE			
F1=Help F2=Split F3=Exit F7=Backward F8=Forward F9=Swap			
F12=Cancel			

The fields in the ISPF table part of the panel are:

Sel

Selection column. Type **s** to select an index.

PRC

Processing column. An asterisk (*) indicates the selected index spaces.

Database

The name of the database in which the index space is defined.

Index Space

The name of the index space.

DS Num

The partition number for this table space. Non-partitioned table spaces have a partition number of 0. For a partitioned table space, the number indicates the partition of the table space.

ICDATE

The date that the image copy was taken. The format is *yyymmdd*.

ICTIME

The time that the image copy was taken. The format is *hhmmss*.

Reuse

Reuse option:

Y

The data set for the index space is not deleted and is re-defined as part of the RECOVER utility processing.

N

The data set for the index space is deleted and redefined as part of the RECOVER utility processing.

Image copy data set name

The name (which must be cataloged) of the image copy data set. Note that the existence of an entry in the catalog table does not mean that the data set still exists.

Parent panels

- [Db2 Utilities panel on page 610](#)

Child panels

None.

Related tasks

- [RECOVER \(index spaces\) on page 362](#)

RECOVER Utility (Index Spaces) with LISTDEF panel

You use the RECOVER Utility (Index Spaces) with LISTDEF panel to generate utility control statements using the RECOVER INDEXSPACE form of the RECOVER utility.

Panel and field definitions

```

  Process  Options  Utilities  Help
  -----
  FM/Db2 (DFG2)          RECOVER Utility (Index Spaces)          Row 1 to 1 of 1

  P
  R LISTDEF
  Cmd C Name              Reuse
  ___ LDEF1                N
  ***** Bottom of data *****

  Command ==>> _____ Scroll PAGE
  F1=Help   F2=Split   F3=Exit   F7=Backward F8=Forward F9=Swap
  F12=Cancel
  
```

Cmd

You can enter commands in this field to manipulate the panel rows.

I(n)

Insert (n) new row(s)

R(n)

Repeat the current row (n times)

D(n)

Delete (n) row(s)

S(n)

Select (n) rows(s)

An asterisk (*) in the PRC column shows that the LISTDEF in the row is selected. The S command toggles the selection of rows; unselected rows become selected and selected rows become unselected.

LISTDEF Name

On entry to the panel, this field is set to the value in the **LISTDEF name** field in the Db2® Utilities panel.

Parent panels

- [Db2 Utilities panel on page 610](#)

Child panels

None.

Related tasks

- [RECOVER utility on page 360](#)
- [RECOVER \(index spaces\) on page 362](#)

RECOVER Utility (Table Spaces) panel

You use the RECOVER Utility (Table Spaces) panel to generate utility control statements using the RECOVER TABLESPACE form of the RECOVER utility.

Panel and field definitions

Process	Options	Utilities	Help
FM/Db2 (DFG2)		RECOVER Utility (Table Spaces)	Row 1 to 12 of 131
S P			
e R	Table	DS	T Re- bld
l C	Database Space	Num ICDATE ICTIME	p use Idx Image Copy Data Set Name
-	BILLSDB1 TS1D	0 010524 165000	F N Y OSPEED.BILLSDB1.TS1D.C00000.
-	CJMAODA CJMAOSD	0 010526 060718	F N Y CJMAON.DB26.SYSCOPY.CJMAODA.
-	CJMAODA CJMAOSE	0 010526 060719	F N Y CJMAON.DB26.SYSCOPY.CJMAODA.
-	CJMAODA CJMAOSE	3 010526 074016	F N Y CJMAON.DB26.CJMAODA.CJMAOSE.
-	CJMAODA CJMAOSP	0 010526 060719	F N Y CJMAON.DB26.SYSCOPY.CJMAODA.
-	CJMAODP CJMAOSC	0 010526 060729	F N Y CJMAON.DB26.COPYDDN.CJMAODP.
-	CJMAODP CJMAOSC	0 010526 060719	F N Y CJMAON.DB26.SYSCOPY.CJMAODP.
-	DSNDB01 SCT02	0 001228 150606	F N Y DB2.V7R1M0.IMAGCOPY.SCT02
-	DSNDB01 SPT01	0 001228 150608	F N Y DB2.V7R1M0.IMAGCOPY.SPT01
-	DSNDB01 SYSLGRNX	0 001228 150628	F N Y DB2.V7R1M0.IMAGCOPY.SYSLGRNX
-	DSNDB04 PLANRTAB	0 010419 133458	F N Y GRAHAMP.DSNDB04.PLANRTAB.F00
-	DSNDB04 USERS	0 010419 133500	F N Y GRAHAMP.DSNDB04.USERS.F00000
Command ==>		Scroll PAGE	
F1=Help	F2=Split	F3=Exit	F7=Backward F8=Forward F9=Swap
F12=Cancel			

The fields in the ISPF table part of the panel are:

Sel

Selection column. Type **s** to select a table space.

PRC

Processing column. An asterisk (*) indicates the selected table spaces.

Database

The name of the database in which the table space is defined.

Table Space

The name of the table space.

DS Num

The partition number for this table space. Non-partitioned table spaces have a part number of 0. For a partitioned table space, the number indicates the partition of the table space.

ICDATE

The date that the image copy was taken. The format is *yyymmdd*.

ICTIME

The time that the image copy was taken. The format is *hhmmss*.

Typ

The type of entry found in the SYSIBM.SYSCOPY table:

F

Full image copy.

I

Incremental image copy.

Reuse

Reuse option:

Y

The data set for the table space is not deleted and re-defined as part of the RECOVER utility processing.

N

The data set for the table space is deleted and redefined as part of the RECOVER utility processing.

Re-bld Idx

Rebuild indexes after recovery:

Y

A REBUILD INDEX (ALL) TABLE SPACE command is included in the JCL to perform a full rebuild of all of the indexes on all of the tables in the table space. This is the standard method for recovering a table space, and prevents the indexes being left in an unusable rebuild pending (RBDP) state.

N

Indexes not rebuilt.

Image copy data set name

The name (which must be cataloged) of the image copy data set. Note that the existence of an entry in the catalog table does not mean that the data set (still) exists.

Parent panels

- [Db2 Utilities panel on page 610](#)

Child panels

None.

Related tasks

- [RECOVER \(table spaces\) on page 360](#)

RECOVER Utility (Table Spaces) with LISTDEF panel

You use the RECOVER Utility (Table Spaces) with LISTDEF panel to generate utility control statements using the RECOVER INDEXSPACE form of the RECOVER utility.

Panel and field definitions

<u>P</u> rocess	<u>O</u> ptions	<u>U</u> tilities	<u>H</u> elp
FM/Db2 (DFG2)		RECOVER Utility (Table Spaces)	Row 1 to 2 of 2
P			
R	LISTDEF		
Cmd C	Name	Reuse	
*	FRED	N	
	GEORGE	N	
***** Bottom of data *****			
Command ==> _____ Scroll PAGE			
F1=Help	F2=Split	F3=Exit	F7=Backward F8=Forward F9=Swap
F12=Cancel			

Cmd

You can enter commands in this field to manipulate the panel rows.

I(n)

Insert (n) new row(s)

R(n)

Repeat the current row (n times)

D(n)

Delete (n) row(s)

S(n)

Select (n) rows(s)

An asterisk (*) in the PRC column shows that the LISTDEF in the row is selected. The S command toggles the selection of rows; unselected rows become selected and selected rows become unselected.

LISTDEF Name

On entry to the panel, this field is set to the value in the **LISTDEF name** field in the Db2® Utilities panel.

Parent panels

- [Db2 Utilities panel on page 610](#)

Child panels

None.

Related tasks

- [RECOVER utility on page 360](#)
- [RECOVER \(table spaces\) on page 360](#)

Recovery Information panel

FM/Db2 displays the Recovery Information panel if you use the ICS line command against an item listed on:

- The [Databases panel on page 593](#), or
- The [Table Spaces panel on page 834](#), or
- The [Indexes panel on page 697](#)

Related tables panel

You use the Related tables panel to display information about the tables related to the table being edited when you issued the REDIT command.

The panel displays a selection list showing all the Db2® objects that are directly related to the object being edited by an RI constraint. This includes tables that are parent tables in a relationship with the table being edited, and tables that are dependent tables in a relationship with the table being edited.

Panel and field definitions

Process	Options	Utilities	Help		
FM/Db2 (DFE2)	Related tables for: DSN8910.EMP				Top of 4
4 rows	4 rows	4 rows	4 rows	4 rows	Format <u>TABL</u>
SEL	RELATED	RELATED	RELATIONSHIP	RELATIONSHIP	COUNT
	TABLE	TABLE	NAME	TYPE	OF FOREIGN
	OWNER	NAME			KEY COLUMNS
	*	*	*	*	* *
	#1-+-----	#2-+-----	#3-+-----1--	#9-+-----	-----#6 #10-+-----
****	Top of data	****			
-----	DSN8910	DEPT	RDE	DEPENDENT	1 SET NULL
-----	DSN8910	EMPPROJECT	REPAE	DEPENDENT	1 RESTRICT
-----	DSN8910	PROJ	RESPEMP	DEPENDENT	1 RESTRICT
-----	DSN8910	DEPT	RED	PARENT	1 SET NULL
****	End of data	****			
Command ==>					Scroll <u>PAGE</u>
F1=Help	F2=Zoom	F3=Exit	F4=CRetriev	F5=RFind	F6=RChange
F7=Up	F8=Down	F9=Swap	F10=Left	F11=Right	F12=Cancel

The entries shown on the Related tables panel depend on the cursor position when you issued the REDIT command:

- If the cursor was not on the data for a column that is part of a foreign, parent or primary key, all related tables are shown.
- If the cursor was on the data for a column that is part of a foreign, parent or primary key, only the related tables that include that column in a foreign, parent or primary key are shown.

The columns that are displayed include the SEL field, and columns of SYSIBM.SYSRELS.

SEL

Selection column. You can issue any of these line commands against the Db2® objects in the list:

A

Alter table.

ALS

Show aliases.

B

Browse table. (See Note 1)

C

Copy table.

CDI

Show column distribution statistics.

CH

Show child (dependent) tables.

CHR

Show child (dependent) relations.

CK

Show table check constraints.

COL

Show columns.

CON

Show table (unique and primary) constraints.

D

Show database.

E

Edit table. (See Note 1)

EE

Edit table - new session. (See Note 3)

FK

Show foreign keys.

I

Details about table or view.

KEY

Show relationship keys. (See Note 2)

P

Show privileges.

PA

Show parent tables.

PAR

Show parent relations.

PK

Show primary key.

PKG

Show packages.

PL

Show plans.

PR

Print table.

PST

Show partition statistics.

ROW

Show all columns for this row.

S

Show table spaces.

SYN

Show synonyms.

V

View table. (See Note 1)

VE

View table - new session. (See Note 3)

VW

Show views.

X

Show indexes.

XC

Show indexes and index columns.



Note:

1. The E, B, and V commands edit, browse, or view the object by stacking a new FM/Db2 editor session on top of the existing FM/Db2 editor session. You cannot return to the original FM/Db2 editor session without first ending the new FM/Db2 editor session.
2. For a parent relationship type, the KEY command shows the primary keys for the two tables in the relationship.

For a dependent relationship type, the KEY command shows the foreign key columns for the two tables in the relationship.

3. The EE and VE commands edit (or view) the object by starting a new ISPF logical session (split screen) and then starting a File Manager/Db2 editor session in the new logical session.
 - When the REDIT command was issued and the cursor was not located on the data for a column that is part of a parent, primary or foreign key, the new FM/Db2 editor session shows all rows of the table.
 - When the REDIT command was issued with the cursor located on the data for a column that is part of a parent, primary or foreign key, the new FM/Db2 editor session only shows those rows related to the row where the cursor was located.

The FM/Db2 editor session of the related table may have no rows when:

- For a dependent table, there are no rows in the table with a matching foreign key value.
- For a parent table, the foreign key value contains one or more columns with the Db2® null value.

Parent panels

- [Table Browse panel on page 824](#)
- [Table Edit panel on page 826](#)
- [Table View panel on page 837](#)

Child panels

Various. Depends on which line command entered.

Related tasks

- [Specifying a Db2 object name on page 45](#)
- [Listing related tables on page 189](#)
- [Displaying or printing a list of objects on page 298](#)
- [Db2 Location Selection panel on page 603](#)

Remote Db2® Location Selection panel

You use the Remote Db2® Location Selection panel to display all the available remote locations. You can only access remote locations that have been defined to your local Db2® subsystem.

Panel and field definitions

<u>P</u> rocess	<u>O</u> ptions	<u>U</u> tilities	<u>H</u> elp
FM/Db2 (DFG2)		Remote Db2 Location Selection	Row 1 to 4 of 4
Sel Location			
*			
—	QXPMVS8DB2D		
—	QXPMVS8DB26		
—	QXPMVS6DB2D		
—	QXPMVS8DB62		
***** END OF Db2 DATA *****			
Command ==>			
F1=Help	F2=Split	F3=Exit	F4=CRetriev
F9=Swap	F12=Cancel	F7=Up	F8=Down
			Scroll PAGE

Sel

Selection column. Type s to select a location.

Location

The name of the location.

Parent panels

An asterisk (*) or pattern entered in the **Location** field on any Object List utility panel.

Child panels

None.

Related tasks

- [Specifying a Db2 object name on page 45](#)
- [Displaying or printing a list of objects on page 298](#)
- [Db2 Location Selection panel on page 603](#)

REORG Utility (Indexes) panel

You use the REORG Utility (Indexes) panel to generate utility control statements using the REORG INDEX form of the REORG utility.

Panel and field definitions

Process	Options	Utilities	Help								
FM/Db2 (DFG2)		REORG Utility (Indexes)		Row 1 to 12 of 344							
S P				U	C	C				Reuse	
e R	Index			Prt	n	l	l	Cls	Leaf	Off	Data
l C	Owner + Name		+	Num	i	g	d	Rat	Dist	Pos	Set
-	fmb2	TABLE19_UNIQUE		0	U	Y	Y	?	?	?	N
-	fmb2!	TABLE20_UNIQUE		0	U	Y	Y	?	?	?	N
-	thing	ix1		0	U	Y	N	?	?	?	N
-	ARROWSB	T1_IX1		0	P	Y	Y	?	?	?	N
-	ARROWSB	T3_IX1		0	P	Y	Y	?	?	?	N
-	ARROWSB	XDEPT1		0	P	N	N	?	?	?	N
-	ARROWSB	XDEPT2		0	D	N	N	?	?	?	N
-	ARROWSB	XDEPT3		0	D	N	N	?	?	?	N
-	ARROWSB	XEMP1		1	P	Y	Y	?	?	?	N
-	ARROWSB	XEMP1		2	P	Y	Y	?	?	?	N
-	ARROWSB	XEMP1		3	P	Y	Y	?	?	?	N
-	ARROWSB	XEMP1		4	P	Y	Y	?	?	?	N
Command ==>>											
F1=Help	F2=Split	F3=Exit	F4=Expand	F7=Backward	Scroll PAGE						
F9=Swap	F10=Left	F11=Right	F12=Cancel	F8=Forward							

Sel

Selection column. Type **s** to select an index.

PRC

Processing column. An asterisk (*) indicates the selected index.

Index Creator

The name of the creator of the index.

Index Name

The name of the index.

Part Num

The partition number for the index. For a non-partitioned index, this is 0. Partitioned indexes appear as multiple rows, one row for each partition of the index. This is a display-only field

Uni

The UNIQUERULE flag for the index, from the SYSINDEXES catalog table

Clg

The CLUSTERING flag for the index, from the SYSINDEXES catalog table.

Cld

The CLUSTERED flag for the index, from the SYSINDEXES catalog table.

Cls Rat

The CLUSTERRATIO flag for the index, from the SYSINDEXES catalog table.

Leaf Dist

The LEAFDIST flag for the index, from the SYSINDEXPART catalog table.

Off Pos

This is a display-only field. This value indicates the number of rows relocated out of their optimal position for the index. If the CARD value for the index is greater than zero, the value is calculated using the expression:

$$(AVG(NEAROFFPOS + FAROFFPOS) * 100)/CARD$$

This value helps you identify indexes that might require organization. For more information, see the *DB2 Utility Guide and Reference*.

Reuse Data set

Whether Db2® physically deletes and redefines the data sets for the index:

Y

Data set for the index reused.

N

Data set for the index not reused. This is the default setting.

Parent panels

- [Db2 Utilities panel on page 610](#)

Child panels

None.

Related tasks

- [REORG \(indexes\) on page 366](#)

REORG Utility (Indexes) with LISTDEF panel

You use the REORG Utility (Indexes) with LISTDEF panel to generate utility control statements using the REORG INDEX form of the REORG utility.

Panel and field definitions

<u>P</u> rocess	<u>O</u> ptions	<u>U</u> tilities	<u>H</u> elp
FM/Db2 (DFG2)		REORG Utility (Indexes)	Row 1 to 2 of 2
P		Reuse	
R	LISTDEF	Data	
Cmd C	Name	Set	
	<u>F</u> RED	<u>N</u>	
<u>*</u>	<u>J</u> AMES	<u>N</u>	
***** Bottom of data *****			
Command ==>			Scroll <u>P</u> AGE
F1=Help	F2=Split	F3=Exit	F7=Backward F8=Forward F9=Swap
F12=Cancel			

Cmd

You can enter commands in this field to manipulate the panel rows.

I(n)

Insert (n) new row(s)

R(n)

Repeat the current row (n times)

D(n)

Delete (n) row(s)

S(n)

Select (n) rows(s)

An asterisk (*) in the PRC column shows that the LISTDEF in the row is selected. The S command toggles the selection of rows; unselected rows become selected and selected rows become unselected.

LISTDEF Name

On entry to the panel, this field is set to the value in the **LISTDEF name** field in the Db2® Utilities panel.

Parent panels

- [Db2 Utilities panel on page 610](#)

Child panels

None.

Related tasks

- [REORG utility on page 363](#)
- [REORG \(indexes\) on page 366](#)

REORG Utility (Table Spaces) panel

You use the REORG Utility (Table Spaces) panel to generate utility control statements using the REORG TABLESPACE form of the REORG utility.

Panel and field definitions

Process		Options	Utilities	Help				
FM/Db2 (DFG2)		REORG Utility (Table Spaces)					Row 1 to 12 of 229	
S	P	Table	Avg	Avg	Unload		Reuse	
e	R	Database	Prt	Ind	Off	External	Log	
l	C	Name	Num	Ref	Pos	(Y/N)	(Y/N)	
		Space					Data	
		Name					Set	
—		BILLSDB1 TS1D	0	?	?	N	N	
—		BILLSDB1 TS1E	1	?	?	N	N	
—		BILLSDB1 TS1E	2	?	?	N	N	
—		BILLSDB1 TS1E	3	?	?	N	N	
—		BILLSDB1 TS1E	4	?	?	N	N	
—		BILLSDB2 UTILTS1	0	?	?	N	N	
—		CJMAODA CJMAOSD	0	0	0	N	N	
—		CJMAODA CJMAOSE	1	0	0	N	N	
—		CJMAODA CJMAOSE	2	?	?	N	N	
—		CJMAODA CJMAOSE	3	0	0	N	N	
—		CJMAODA CJMAOSE	4	?	?	N	N	
—		CJMAODA CJMAOSP	0	0	0	N	N	
Command ==>								
F1=Help		F2=Split	F3=Exit		F7=Backward		F8=Forward	
F12=Cancel							Scroll PAGE	F9=Swap

Sel

Selection column. Type **s** to select a table space.

PRC

Processing column. An asterisk (*) indicates the selected table space.

Database Name

The name of the database in which the table space is defined.

Table Space Name

The name of the table space.

Prt Num

The partition number for the table space. This is 0 for a non-partitioned table space. Partitioned table spaces appear as multiple rows, one row for each partition of the table space. This is a display-only field.

Avg Ind Ref

This is a display-only field. This is an average value for the number of rows relocated out of their original position. If the table space/partition's cardinality is greater than zero, the calculated value is:

$$(AVG(NEARINDREF + FARINDREF) * 100)/CARD$$

This value helps you identify table spaces that might require organization. For more information about these values, see the *DB2 Utility Guide and Reference*.

Avg Off Pos

This is a display-only field. This is an average value for the number of rows relocated out of their optimal position for all indexes within the table space or partition. The average is for all indexes which have a CARD value greater than zero, using the expression:

$$(AVG(NEAROFFPOS + FAROFFPOS) * 100)/CARD$$

This value helps you identify table spaces that might require organization. For more information, see the *DB2 Utility Guide and Reference*.

Unload External (Y/N)

Whether the REORG process leaves the data in external format and therefore acts as an *unload utility*.

Y

REORG processing halts at the unload phase and leaves the data in external format in the SYSREC00 data set. Load control cards are produced in the SYSPUNCH data set. The data produced is in a format suitable for loading into any similar table structure, in any Db2® subsystem. The DD names in the job and resultant SYSPUNCH are compatible with the DSNTIAUL sysrec naming (for example, SYSREC00), therefore the FM/Db2 LOAD Utility can accept both formats, without requiring any JCL editing before submission.

N

Full REORG performed.

Log (Y/N)

LOG option:

Y

Changes written to the Db2® log.

N

Changes not written to the Db2® log. This is the default setting.

For more information, see the *DB2 Utility Guide and Reference*.

Reuse Data Set

Reuse option:

Y

The data set for the table space is not deleted and re-defined as part of the RECOVER utility processing.

N

The data set for the table space is deleted and redefined as part of the RECOVER utility processing.

Parent panels

- [Db2 Utilities panel on page 610](#)

Child panels

None.

Related tasks

- [REORG \(table spaces\) on page 364](#)

REORG Utility (Table Spaces) with LISTDEF panel

You use the REORG Utility (Table Spaces) with LISTDEF panel to generate utility control statements using the REORG TABLESPACE form of the REORG utility.

Panel and field definitions

<u>P</u> rocess	<u>O</u> ptions	<u>U</u> tilities	<u>H</u> elp
FM/Db2 (DFG2)		REORG Utility (Table Spaces)	Row 1 to 2 of 2
P		Unload	Reuse
R	LISTDEF	External Log	Data
Cmd C	Name	(Y/N)	(Y/N) Set
*	FRED	N	N N
	JAMES	N	N N
***** Bottom of data *****			
Command ==> _____ Scroll PAGE			
F1=Help F2=Split F3=Exit F7=Backward F8=Forward F9=Swap			
F12=Cancel			

Cmd

You can enter commands in this field to manipulate the panel rows.

I(n)

Insert (n) new row(s)

R(n)

Repeat the current row (n times)

D(n)

Delete (n) row(s)

S(n)

Select (n) rows(s)

An asterisk (*) in the PRC column shows that the LISTDEF in the row is selected. The S command toggles the selection of rows; unselected rows become selected and selected rows become unselected.

LISTDEF Name

On entry to the panel, this field is set to the value in the **LISTDEF name** field in the Db2® Utilities panel.

Parent panels

- [Db2 Utilities panel on page 610](#)

Child panels

None.

Related tasks

- [REORG utility on page 363](#)
- [REORG \(table spaces\) on page 364](#)

Revoke privileges panels

These panels are:

- Revoke Application Plan Privileges panel
- Revoke Buffer Pool Privileges panel
- Revoke Collection Privileges panel
- Revoke Column Privileges panel
- Revoke Database Privileges panel
- Revoke Distinct Type Privileges panel
- Revoke Function Privileges panel
- Revoke Package Privileges panel
- Revoke Schema Privileges panel
- Revoke Sequence Privileges panel

- Revoke Storage Group Privileges panel
- Revoke Stored Procedure Privileges panel
- Revoke System Privileges panel
- Revoke Table Privileges panel
- Revoke Table Space Use Privileges panel

FM/Db2 displays one of these panels if you use the Privileges utility function (3.5) to revoke privileges for an object type, or if you specify the R line command against an object displayed in a list of Db2® objects.

Format of revoke privilege panels

The revoke privileges panels are similar to the corresponding grant privilege panels. However, in place of the **To** field, the revoke privileges panels contain the following fields:

- A **From** field. Use this field to specify the SQLID of the user for whom the privileges are to be revoked (the revokee).
- A **By** field. Use this field to specify the SQLID of the user who granted the privileges (the grantor), or “ALL” to indicate all grantors.

Related tasks

Routine Parameters panel

FM/Db2 displays the Routine Parameters panel if you use the PARM line command against an item listed on:

- The [Functions panel on page 684](#), or
- The [Stored Procedures panel on page 813](#)

Row Selection Criteria panel

You use the Row Selection Criteria panel to specify row selection criteria by column.

Panel and field definitions

Process	Options	Utilities	Help
FM/Db2 (DFG2)		Row Selection Criteria	Line 1 of 14
Cmd	Con	Column name	Op Value
<->	-	<-----1-----2-----3----->	<-> <-----1-----2----->
***	***	Top of data	***
---	---	EMPNO	---
---	AND	FIRSTNME	---
---	AND	MIDINIT	---
---	AND	LASTNAME	---
---	AND	WORKDEPT	---
---	AND	PHONENO	---
---	AND	HIREDATE	---
---	AND	JOB	---
---	AND	EDLEVEL	---
---	AND	SEX	---
---	AND	BIRTHDATE	---
---	AND	SALARY	---
---	AND	BONUS	---
---	AND	COMM	---
Command ==>			
F1=Help	F2=Split	F3=Exit	F4=CRetriev
F7=Up	F8=Down	F9=Swap	F10=Left
			F5=RFind
			F11=Right
			F6=RunTemp
			F12=Cancel
			Scroll PAGE

Cmd

Prefix command column.

You can use the following prefix commands when editing row selection criteria by column:

A

Identifies the line after which data is to be moved or copied.

B

Identifies the line before which data is to be moved or copied.

C

Copy one line.

Cn

Copy *n* rows.

CC

Copy block of lines. Mark start and end of block.

D

Delete one line.

Dn

Delete *n* lines.

DD

Delete block of lines. Mark start and end of block.

M

Move one line.

Mn

Move *n* lines.

MM

Move block of lines. Mark start and end of the block.

R

Repeat one line.

Rn

Repeat *n* lines.

RR

Repeat block of lines. Mark start and end of the block.

RRn

Repeat block of lines *n* times. Mark start and end of block.

Con

Connector column.

You specify the AND and OR connectors in this column. The default value is AND. You can use abbreviations. For example, if you overwrite the existing connector, AND, with o, FM/Db2 generates an OR connector.

Connectors are only relevant to lines containing expressions (that is, where you have specified an operator in the **Op** column).

You can overwrite the existing connector with one of the following values:

AND or &

FM/Db2 generates an AND connector in the resultant WHERE clause.

OR or |

FM/Db2 generates an OR connector in the resultant WHERE clause.

(

Left parenthesis column.

If you need to define the sequence of evaluation for the resultant WHERE clause by enclosing part of the clause in parentheses, use this column to type a left parenthesis "(" at the appropriate point.

You can only use a parenthesis on a line containing expressions (that is, where you have specified an operator in the **Op** column). The number of left parentheses must match the number of right parentheses.

Column name

The name of the column.

On 80-byte screens, FM/Db2 displays either the column name details (the default) or the data type details for the column. To toggle between FM/Db2 displaying the **Column name** and **Data type(length)** details, press the PF11 function key.

Data type(length)

The Db2® data type and, where applicable, length of the column.

On 80-byte screens, FM/Db2 displays either the column name details (the default) or the data type details for the column. To toggle between FM/Db2 displaying the **Column name** and **Data type(length)** details, press the PF11 function key.

Op

Operator column. Operators are used to create expressions. When you type an operator in the **Op** column, it indicates that you want FM/Db2 to form an expression using the column name on that line of the panel, the operator you have specified and, with the exception of the operators NL, ~NL, and>NNL, the contents of the **Value** column.

FM/Db2 supports the following operators:

= or EQ

True if the terms are equal (numerically, or when padded).

~= or NE

True if the terms are not equal (inverse of =)

> or GT

Greater than

< or LT

Less than

>= or GE

Greater than or equal to

\= or -<

Not less than

<= or LE

Less than or equal

\> or ->

Not greater than

LK

LIKE predicate. Column must not be numeric.

-LK or NLK

NOT LIKE. Column must not be numeric.

BTW

BETWEEN. **Value** must be in the form *value1,value2*.

-BT or NBT

NOT BETWEEN. **Value** must be in the form *value1,value2*.

IN

IN. **Value** must be in the form *value1,value2,...*

-IN or NIN

NOT IN. **Value** must be in the form *value1,value2,...*

NL

IS NULL. **Value** must be blank.

-NL or>NNL

IS NOT NULL. **Value** must be blank.

RG

Range. **Value** must be in the form *value1,value2*.

NR

Not in range. **Value** must be in the form *value1,value2*.

Value

The character or numeric constant to be used with the specified operator and column name to create an expression in the resultant WHERE clause.

When the operator is NL, -NL, or>NNL, the Value column must be blank. For all other operators, the Value column must not be blank

For operators that support more than one value (BTW, -BT, NBT, IN, -IN, NIN, RG, or NR), the values must be separated by commas. For operators IN, -IN, or NIN, and the column is alphanumeric, you must enclose each value in quotation marks.

If the data type of the column is alphanumeric, the value can be:

- A character string not starting or ending with a single quotation mark. and not containing any embedded quotation marks or commas. The case of the string is ignored.
- A character string enclosed in single quotation marks. The string can contain blanks and commas, but not any embedded quotation marks. The case of the string is ignored.

If the data type of the column is numeric, the value must be numeric.

For DATE, TIME, and TIMESTAMP columns, if you specify a “=” in the **Value** field, FM/Db2 displays the current date, time, or timestamp values respectively in the required format.

)

Right parenthesis column.

If you need to define the sequence of evaluation for the resultant WHERE clause by enclosing part of the clause in parentheses, use this column to type a right parenthesis (“)”) at the appropriate point.

You can only use parentheses on lines containing expressions (that is, where you have specified an operator in the **Op** column). The number of left parentheses must match the number of right parentheses.

Parent panels

- [Column Selection/Edit panel on page 485](#)

Child panels

None.

Related tasks

- [Selecting rows on page 83](#)

RUNSTATS Utility (Indexes) panel

You use the RUNSTATS Utility (Indexes) panel to generate utility control statements using the RUNSTATS INDEX form of the RUNSTATS utility.

Panel and field definitions

Process	Options	Utilities	Help
FM/Db2 (DFG2)		RUNSTATS Utility (Indexes)	Row 1 to 12 of 341
S P			Report Update
e R	Index	Index	Part'n Stats Option
l C	Owner +	Name	+ Number (Y/N) (A/P/S/N)
-	fmb2	TABLE19_UNIQUE	0 N A
-	fmb2!	TABLE20_UNIQUE	0 N A
-	thing	ix1	0 N A
-	ARROWSB	T1_IX1	0 N A
-	ARROWSB	T3_IX1	0 N A
-	ARROWSB	XDEPT1	0 N A
-	ARROWSB	XDEPT2	0 N A
-	ARROWSB	XDEPT3	0 N A
-	ARROWSB	XEMP1	1 N A
-	ARROWSB	XEMP1	2 N A
-	ARROWSB	XEMP1	3 N A
-	ARROWSB	XEMP1	4 N A
Command ==>			Scroll PAGE
F1=Help	F2=Split	F3=Exit	F4=Expand F7=Backward F8=Forward
F9=Swap	F10=Left	F11=Right	F12=Cancel

Sel

Selection column. Type **s** to select an index.

PRC

Processing column. An asterisk (*) indicates the selected index.

Index Creator

The name of the creator of the index.

Index Name

The name of the index.

Part'n Number

The partition number for the index. A zero indicates a non-partitioned index. A non-zero value indicates the partition number of a partitioned index.

Report Stats (Y/N)

Whether a report outlining the results of the utility is written to the SYSPRINT DDNAME:

Y

Report written to the SYSPRINT DDNAME.

N

Report not written to the SYSPRINT DDNAME. This is the default setting.

For more information, see the *DB2 Utility Guide and Reference*.

Update Option (A/P/S/N)

Indicates which catalog tables (if any) are updated by the RUNSTATS utility. The available options are:

A

All. All catalog tables are updated. This is the default setting.

P

Access path only. Statistics related to access path selection are updated

S

Space only. Only statistics related to space information are updated

N

None. No catalog tables are updated.

Parent panels

- [Db2 Utilities panel on page 610](#)

Child panels

None.

Related tasks

- [RUNSTATS \(indexes\) on page 370](#)

RUNSTATS Utility (Indexes) with LISTDEF panel

You use the RUNSTATS Utility (Indexes) with LISTDEF panel to generate utility control statements using the RUNSTAT INDEX form of the RUNSTAT utility.

Panel and field definitions

```

Process  Options  Utilities  Help
-----  -
FM/Db2 (DFG2)          RUNSTATS Utility (Indexes)          Row 1 to 2 of 2

P
R LISTDEF          Report Update
                  Stats Option
Cmd C Name          (Y/N) (A/P/S/N)
___ * FRED          N      A
___  JAMES          N      A
***** Bottom of data *****

Command ==>> _____ Scroll PAGE
F1=Help      F2=Split    F3=Exit     F7=Backward F8=Forward  F9=Swap
F12=Cancel
    
```

Cmd

You can enter commands in this field to manipulate the panel rows.

I(n)

Insert (n) new row(s)

R(n)

Repeat the current row (n times)

D(n)

Delete (n) row(s)

S(n)

Select (n) rows(s)

An asterisk (*) in the PRC column shows that the LISTDEF in the row is selected. The S command toggles the selection of rows; unselected rows become selected and selected rows become unselected.

LISTDEF Name

On entry to the panel, this field is set to the value in the **LISTDEF name** field in the Db2® Utilities panel.

Parent panels

- [Db2 Utilities panel on page 610](#)

Child panels

None.

Related tasks

- [RUNSTATS utility on page 368](#)
- [RUNSTATS \(indexes\) on page 370](#)

RUNSTATS Utility (Table Spaces) panel

You use the RUNSTATS Utility (Table Spaces) panel to generate either RUNSTATS TABLESPACE or RUNSTATS INDEX control statements, depending on the value selected for the **Indexes Only** column.

Panel and field definitions

Process	Options	Utilities	Help
FM/Db2 (DFG2)		RUNSTATS Utility (Table Spaces)	Row 1 to 12 of 237
S P e R l C	Database Name	Table Space Name	Part'n Number Tables
			Indexes Only (Y/N)
			Report Stats (Y/N)
			Update Option (A/P/S/N)
—	BILLSDB1	TS1D	0 1 N N A
—	BILLSDB1	TS1E	1 1 N N A
—	BILLSDB1	TS1E	2 1 N N A
—	BILLSDB1	TS1E	3 1 N N A
—	BILLSDB1	TS1E	4 1 N N A
—	BILLSDB2	UTILTS1	0 2 N N A
—	CJMAODA	CJMAOSD	0 1 N N A
—	CJMAODA	CJMAOSE	1 1 N N A
—	CJMAODA	CJMAOSE	2 1 N N A
—	CJMAODA	CJMAOSE	3 1 N N A
—	CJMAODA	CJMAOSE	4 1 N N A
—	CJMAODA	CJMAOSP	0 4 N N A
Command ==>			Scroll PAGE
F1=Help	F2=Split	F3=Exit	F7=Backward F8=Forward F9=Swap
F12=Cancel			

Sel

Selection column. Type **s** to select a table space.

PRC

Processing column. An asterisk (*) indicates the selected table space.

Database Name

The name of the database in which the table space is defined.

Table Space Name

The name of the table space.

Part'n Number

The partition number for the table space. A zero value indicates a non-partitioned table space; a non-zero value indicates the partition number.

Number Tables

The number of tables in the table space.

Indexes Only (Y/N)

Whether RUNSTATS is performed for only the indexes in the table spaces (without gathering statistics for the tables in the table space itself):

Y

RUNSTATS performed for indexes only.

N

RUNSTATS performed for tables and indexes. This is the default setting.

Report Stats (Y/N)

Whether a report outlining the results of the utility is written to the SYSPRINT DDNAME:

Y

Report written to the SYSPRINT DDNAME.

N

Report not written to the SYSPRINT DDNAME. This is the default setting.

For more information, see the *DB2 Utility Guide and Reference*.

Update Option (A/P/S/N)

Indicates which catalog tables (if any) are updated by the RUNSTATS utility:

A

All. All catalog tables are updated. This is the default setting.

P

Access path only. Statistics related to access path selection are updated.

S

Space only. Only statistics related to space information are updated.

N

None. No catalog tables are updated.

Parent panels

- [Db2 Utilities panel on page 610](#)

Child panels

None.

Related tasks

- [RUNSTATS \(table spaces\) on page 369](#)

RUNSTATS Utility (Table Spaces) with LISTDEF panel

You use the RUNSTATS Utility (Table Spaces) with LISTDEF panel to generate utility control statements using the RUNSTAT TABLESPACE form of the RUNSTAT utility.

Panel and field definitions

Process	Options	Utilities	Help
FM/Db2 (DFG2)		RUNSTATS Utility (Table Spaces)	Row 1 to 2 of 2
P		Report	Update
R	LISTDEF	Stats	Option
Cmd	C Name	(Y/N)	(A/P/S/N)
	FRED	N	A
	* GEORGE	N	A
***** Bottom of data *****			
Command ==> _____ Scroll PAGE			
F1=Help F2=Split F3=Exit F7=Backward F8=Forward F9=Swap			
F12=Cancel			

Cmd

You can enter commands in this field to manipulate the panel rows.

I(n)

Insert (n) new row(s)

R(n)

Repeat the current row (n times)

D(n)

Delete (n) row(s)

S(n)

Select (n) rows(s)

An asterisk (*) in the PRC column shows that the LISTDEF in the row is selected. The S command toggles the selection of rows; unselected rows become selected and selected rows become unselected.

LISTDEF Name

On entry to the panel, this field is set to the value in the **LISTDEF name** field in the Db2® Utilities panel.

Parent panels

- [Db2 Utilities panel on page 610](#)

Child panels

None.

Related tasks

- [RUNSTATS utility on page 368](#)
- [RUNSTATS \(table spaces\) on page 369](#)

Schemas panel

You use the Schemas panel to list information about the schemas you have selected.

Panel and field definitions

The columns that are displayed include the SEL field and columns of various catalog tables.

Process	Options	Utilities	Help		
FM/Db2 (DFG2)		Schemas			Format <u>TABL</u>
Location:					
SEL	SCHEMA	UDTS	UDFS	STPS	TRGS
	*	*	*	*	*
----	#2--+-	-----#3	-----#4	-----#5	-----#6
****	Top of data	****			
----	SHRIKE2	1	3	0	2
----	SHRIKES	1	4	0	1
----	SQLJ	0	0	7	0
----	SYSPROC	0	0	10	0
----	SYSIBM	0	0	13	0
****	End of data	****			
Command ==>					Scroll <u>PAGE</u>
F1=Help	F2=Zoom	F3=Exit	F4=CRetriev	F5=RFind	F6=RChange
F7=Up	F8=Down	F9=Swap	F10=Left	F11=Right	F12=Cancel



Note:

1. The system option, **Show all catalog table columns**, affects which columns FM/Db2 displays when you use the Object List utility.
2. You can also customize which columns FM/Db2 displays when you use the Object List utility. For details, see the *File Manager Customization Guide*.

To view other columns on this panel, press the Right function key (F11).

For a complete list of columns, refer to “*Db2® catalog tables*” in the *DB2 for z/OS SQL Reference* relevant to your version of Db2®.

SEL

Line command area.

For a list of the line commands you can use on this panel, see [Table 22: Object list line commands on page 308](#).

Parent panels

- [Object List Utility panel on page 719](#)
- [Distinct Types panel on page 619](#)
- [Functions panel on page 684](#)
- [Stored Procedures panel on page 813](#)
- [Triggers panel on page 853](#)

Child panels

To display this panel...	Use/do this
Distinct Types panel on page 619	Line command DT
Functions panel on page 684	Line command F
Generate SQL From Db2 Catalog panel on page 686	Line command GEN
Stored Procedures panel on page 813	Line command O
Privileges panels on page 736	Line command P
Revoke privileges panels on page 766	Line command R
Display Row panel on page 619	Line command ROW
Triggers panel on page 853	Line command TR
Sort Fields panel on page 804	Primary command SORT

Related tasks

- [Working with object list panels on page 301](#)
- [Using the line command area \(Cmd\) on page 308](#)

Related references

- [SORT primary command on page 941](#)

Scramble Exit Specification panel

The Scramble Exit Specification panel allows you to provide the name of a scramble exit, a constant to be passed to the exit, and to specify whether numeric fields are to be formatted before the value is passed to the exit.

Panel and field definitions

Figure 130. Scramble Exit Specification panel

Process	Options	Utilities	Help
FM/Db2 (DFG2)	Scramble Exit Specification		
Fixed Attributes:			
Column name	COLCARD		
Type	INTEGER		
Scramble Exit:			
Program name	_____		
Optional constant	_____	+	
Scramble Exit Processing Options:			
Format Option			
1.	None		
2.	Format		
3.	Leading Zeros		
Command ==>			
F1=Help	F2=Split	F3=Exit	F4=Expand
F9=Swap	F10=Left	F11=Right	F12=Cancel
	F7=Backward	F8=Forward	

Program name

A 1 to 8 character valid load module member name that identifies the scramble exit invoked during a copy operation for this output column. The exit must be in the form of a load module, in any load library available to FM/Db2 at the time of the copy process, either by a STEPLIB DD statement, or in LINKLIST, or LPALIST.

Optional constant

A constant value that is passed to the exit for each call type. To enter a hexadecimal value, press F4 or enter the EXPAND command with the cursor positioned in this field and use the command HEX ON from the expand window.

Format Option

This option is only displayed for numeric columns and allows you to request FM/Db2 to pass the value specified in **Optional constant** to the exit in one of the following forms:

1. None

Field value passed to the exit in the internal format.

2. Format

Field value passed to the exit as displayed numeric with leading zeros suppressed.

3. Leading Zeros

Field value passed to the exit as displayed numeric with leading zeros.

Parent panels

- [Column Attributes panel \(alphanumeric\) on page 473](#)
- [Column Attributes panel \(numeric\) on page 478](#)

Related tasks

- [Scrambling data on page 286](#)

Select Statement Browse panel

FM/Db2 displays the Select Statement Browse panel if the **Use edit (instead of browse) to display results** option is not selected, and you press Enter when one of these panels is displayed:

- [Basic SELECT Prototyping panel on page 465](#)
- [Advanced SELECT Prototyping panel on page 442](#)

Related tasks

- [Systems Options \(1 of 4\) panel on page 817](#)

Select Statement Edit panel

FM/Db2 displays the Select Statement Edit panel if the **Use edit (instead of browse) to display results** option is selected, and you press Enter when one of these panels is displayed:

- [Basic SELECT Prototyping panel on page 465](#)
- [Advanced SELECT Prototyping panel on page 442](#)

Related tasks

- [Systems Options \(1 of 4\) panel on page 817](#)

Sequences panel

You use the Sequences panel to display information about the sequences you have selected.

Panel and field definitions

The columns that are displayed include the SEL field and columns of SYSIBM.SYSSEQUENCES.

Figure 131. Sequences panel

Process	Options	Utilities	Help			
FM/Db2 (DFG2)				Sequences		0 of 1
1 rows fetched						Format TABL
SEL	SCHEMA	OWNER	NAME	SEQTYPEX	SEQUENCEID	CREATEDBY
----	*#1-----*	*#2-----*	*#3-----*	*#24-----1-----*	*#5-----*	*#6-----*
****	Top of data	****				
****	SHRIKES	SHRIKES	SEQUENCE1	Sequence object	256	SHRIKES
****	End of data	****				
Command ==>				Scroll PAGE		
F1=Help	F2=Zoom	F3=Exit	F4=CRetriev	F5=RFind	F6=RChange	
F7=Up	F8=Down	F9=Swap	F10=Left	F11=Right	F12=Cancel	

To view other columns on this panel, press the Right function key (F11).

For a complete list of columns, refer to “*Db2® catalog tables*” in the *DB2 for z/OS SQL Reference* relevant to your version of Db2®.

SEL

Line command area.

For a list of the line commands you can use on this panel, see [Table 22: Object list line commands on page 308](#).

Parent panels

- [Object List Utility panel on page 719](#)

Child panels

To display this panel...	Use/do this
Create Sequence panel	Line command CR
Sequence Dependencies panel	Line command DEP
Drop Sequence panel	Line command DR
Grant Sequence Privileges panel	Line command G
Display Row panel on page 619	Line command ROW

Related tasks

- [Working with object list panels on page 301](#)
- [Using the line command area \(Cmd\) on page 308](#)

Related references

- [SORT primary command on page 941](#)

Related tasks

- [Managing tables used by SQL explain on page 422](#)

Set Batch Job Card Information panel

You use the Set Batch Job Card Information panel to specify a JCL jobcard that FM/Db2 is to use whenever it generates a batch job. You can also specify a JOBLIB or other statements.

These options are saved in your ISPF profile and persist from one FM/Db2 session to the next.

Panel and field definitions

Process	Options	Utilities	Help														
FM/Db2 (DFG2) Set Batch Job Card Information																	
Set processing options as required and enter EXIT (F3) to save your changes.																	
Batch Submission Job Statement Information:																	
_____ _____ _____ _____ _____ _____ _____																	
<table style="width: 100%; border-top: 1px solid black; border-bottom: 1px solid black;"> <tr> <td style="width: 15%; padding: 2px;">Command ==>></td> <td style="width: 15%; padding: 2px;">F1=Help</td> <td style="width: 15%; padding: 2px;">F2=Split</td> <td style="width: 15%; padding: 2px;">F3=Exit</td> <td style="width: 15%; padding: 2px;">F4=CRetriev</td> <td style="width: 15%; padding: 2px;">F6=Reset</td> <td style="width: 15%; padding: 2px;">F7=Backward</td> </tr> <tr> <td style="padding: 2px;"></td> <td style="padding: 2px;">F8=Forward</td> <td style="padding: 2px;">F9=Swap</td> <td style="padding: 2px;">F10=Actions</td> <td style="padding: 2px;">F12=Cancel</td> <td style="padding: 2px;"></td> <td style="padding: 2px;"></td> </tr> </table>				Command ==>>	F1=Help	F2=Split	F3=Exit	F4=CRetriev	F6=Reset	F7=Backward		F8=Forward	F9=Swap	F10=Actions	F12=Cancel		
Command ==>>	F1=Help	F2=Split	F3=Exit	F4=CRetriev	F6=Reset	F7=Backward											
	F8=Forward	F9=Swap	F10=Actions	F12=Cancel													

Batch Submission Job Statement Information

The JCL job card information that is used for any batch job that is created.

Child panels

None.

Related tasks

- [Job card specifications \(option 0.3\) on page 63](#)

Set COBOL Processing Options panel

You use the Set COBOL Processing Options panel to customize how FM/Db2 compiles COBOL copybooks to generate FM/Db2 templates.

These options are saved in your ISPF profile and persist from one FM/Db2 session to the next.

Panel and field definitions

<u>P</u> rocess	<u>O</u> ptions	<u>U</u> tilities	<u>H</u> elp
FM/Db2 (DFG2)		Set COBOL Processing Options	
Additional SYSLIB data sets:			
1.	_____		
2.	_____		
3.	_____		
4.	_____		
5.	_____		
6.	_____		
7.	_____		
8.	_____		
9.	_____		
10.	_____		
COBOL REPLACE Options:			
	From string		To string
1.	_____	by	_____
2.	_____	by	_____
3.	_____	by	_____
4.	_____	by	_____
5.	_____	by	_____
COBOL Compiler Options:			
Enter "/" to select option			
	<input type="checkbox"/> DBCS		<input type="checkbox"/> Decimal-point is comma
	<input type="checkbox"/> Arith(extend)		<input type="checkbox"/> Mixed case field names
Additional options _____			
Maximum Return Code to be accepted from compiler <u>04</u> (0-99)			
Command ==>			
F1=Help	F2=Split	F3=Exit	F7=Backward F8=Forward F9=Swap
F12=Cancel			

Additional SYSLIB data sets

When you use one of the preceding FM/Db2 functions, if the COBOL copybook that you specify uses COPY compiler-directing statements to include other members that do not belong to the same PDSs as the copybooks, then you need to specify those other PDSs here.

Here's why: members included by COPY compiler-directing statements must be found in the SYSLIB concatenation. When you specify a copybook on a File Manager/Db2 panel, the SYSLIB concatenation consists of the PDS of the copybook, plus up to ten additional PDSs that you can specify on this panel. These PDSs are searched in order (PDS of the copybook, followed by these additional PDSs, 1-10.)

COBOL REPLACE options

"From" and "To" pseudo-text character strings for the REPLACE compiler-directing statement.

If the COBOL copybook contains characters that you want to replace with other characters before compiling the copybook into a template, then use these replacing options.

For example, if the copybook contains colon characters (:) that you want to remove before compiling, then specify `::::` as a "From" string and `====` as the matching "To" string.

For details on specifying "From" and "To" strings for REPLACE, see the *IBM COBOL Language Reference*.

COBOL Compiler Options

Compiler options to be used when compiling a COBOL copybook into a template:

DBCS

Instructs File Manager to use the DBCS compiler option.

Decimal-point is comma

Uses the "Decimal-point is comma" SPECIAL-NAMES paragraph when compiling COBOL copybooks.

Arith(extend)

Uses the Arith(extend) COBOL compile option when compiling COBOL copybooks.

Mixed case field names

Retains the original case of the field name as coded in the COBOL copybook.

Maximum Return Code

Sets the maximum warning/error code accepted from the compiler, when compiling a copybook. Any code higher than specified causes FM/Db2 to display a pop-up panel, in which you can review the compilation and decide about future processing.

Additional options

Additional COBOL compiler options which are added via the CBL statement when a COBOL compile is run to build or update a template. These options are validated during the compilation process. To avoid compilation errors, ensure that the syntax is correct and that any additional data sets required by these options are allocated before invoking File Manager.

Child panels

None.

Related tasks

- [COBOL compiler specifications \(option 0.5\) on page 63](#)

Set HLASM Processing Options panel

The HLASM Processing Options panel controls various options used by the HLASM compiler to generate templates from your HLASM copybooks.

Panel and field definitions

```

Process  Options  Help
-----
File Manager                Set HLASM Processing Options

Additional SYSLIB data sets:
1. -----
2. -----
3. -----
4. -----
5. -----
6. -----
7. -----
8. -----
9. -----
10. -----

HLASM Compiler Options:

Enter "/" to select option
-  DBCS
-  NOALIGN

Additional options -----

Maximum Return Code to be accepted from compiler 04 (0-99)
Command ==>-----
F1=Help      F2=Split    F3=Exit     F7=Backward F8=Forward  F9=Swap
F10=Actions  F12=Cancel

```

Additional SYSLIB data sets

A concatenation of up to 10 SYSLIB data sets may be entered, these data sets are searched in the order specified for COPY or INCLUDE members for the compilation.

HLASM Compiler Options for Copybooks

Compiler options to be used when compiling a HLASM copybook into a template:

DBCS

If selected, use the DBCS compiler option.

NOALIGN

If selected, use the NOALIGN compiler option.

Additional options

Additional HLASM compiler options which are added via the *PROCESS statement when the assembler is run to build or update a template. These options are validated during the assembly process. To avoid assembly errors please ensure the syntax is correct.

Parent panels

- [Set System Processing Options panel on page 797](#)
- [Set Processing Options panel on page 795](#)

Child panels

- None.

Comments

- [HLASM compiler specifications \(option 0.6\) on page 64](#)

Set Optimizer Hint panel

Panel and field definitions

Process	Options	Utilities	Help
FM/Db2 (DFG2)		Set Optimizer Hint	
Insert a hint for the optimizer into FMUSER.PLAN_TABLE.			
Columns Considered by the Optimizer:			
Query number . . .	<u>1</u>		
Query block number	<u>1</u>		
Application plan . . .			(blank for packages)
DBRM/package . . .	<u>MGRMAIN</u>		
Collection	<u>FMN2PLN1</u>		(blank for plans)
Version			
Access method . . .	<u>0</u>		(0, 1, 2, 3, or 4)
Access type			(I, I1, N, R, M, MX, MI, MU)
Table owner	<u>SYSIBM</u>		
Table name	<u>SYSTABLES</u>		
Correlation name . .			
Table number	<u>1</u>		
Index owner			
Index name			(required for access type I, I1, or N)
Sort new table . . .	<u>N</u>		
Sort composite . . .	<u>N</u>		
Prefetch	<u>S</u>		(' ', S, or L)
Parallelism	<u>?</u>		(?, I, C, or X)
Access degree . . .	<u>?</u>		(? lets Db2 decide)
Join degree	<u>?</u>		(? lets Db2 decide)
Hint ID			(required hint ID)
Comment			
Command ==>			
F1=Help	F2=Split	F3=Exit	F4=CRetriev F7=Backward F8=Forward
F9=Swap	F10=Actions	F12=Cancel	

Parent panels

- [Plan Table Rows panel on page 725](#)

Child panels

None.

Related tasks

Set Output Data Set Allocation Options panel

Panel and field definitions

Figure 132. Set Output Data Set Allocation Options panel

<u>P</u> rocess	<u>O</u> ptions	<u>H</u> elp					
File Manager		Set Output Data Set Allocation Options					
Set processing options as desired and enter EXIT (F3) to save your changes. Enter RESET to restore installation defaults.							
Data set	Space Units	Primary Quantity	Secondary Quantity	Management Class	Storage Class	Data Class	Device Type
Audit Log	CYL	16	8				SYSALLDA
Print	CYL	64	32				SYSALLDA
Trace	CYL	64	32				SYSALLDA
SHOWSQL	TRK	20	20				SYSALLDA
Edit XML	TRK	20	20				SYSALLDA
Command ==>							
F1=Help	F2=Split	F3=Exit	F4=CRetriev	F6=Reset	F7=Backward		
F8=Forward	F9=Swap	F10=Actions	F12=Cancel				

FM/Db2 may allocate data sets, depending on function. The allocation attributes for Audit Log, Print, Trace, SHOWSQL (used to display SQL) and XML Edit can be specified here. The Audit Log, Print, and Trace data sets are always permanent (catalogued) data sets. SHOWSQL data sets may be either temporary or permanent. XML Edit data sets are always temporary data sets. Temporary data sets have a high level qualifier like SYSxxxxx and are deleted automatically when the FM/Db2 function ends.

Any allocation values specified on this panel might be changed by SMS as part of the allocation process, and temporary data sets might be allocated to VIO, depending on SMS and other system settings.

Space Units

Defines the unit of primary and secondary space to be allocated.

BLK

Block of average size.

KB

Kilobyte, a kilobyte is 1024 bytes.

MB

Megabyte, a megabyte is 1048576 bytes.

TRK

Track of a direct access storage device (DASD).

CYL

Cylinder of a DASD.

Primary Quantity

Amount of DASD space to be used for primary space allocation. The range depends on the space unit specified and the DASD device type.

Secondary Quantity

Amount of DASD space to be used for secondary space allocation. The range depends on the space unit specified and the DASD device type.

Management Class

Name of a management class defined in your Storage Management System (SMS) installation. Do not enter a value on a system without SMS.

Storage Class

Name of a storage class defined in your Storage Management System (SMS) installation. Do not enter a value on a system without SMS.

Data Class

Name of a data class defined in your Storage Management System (SMS) installation. Do not enter a value on a system without SMS.

Device Type

Specifies the device type of the volume to contain the data set. Enter an IBM® device type or a generic device name that is supported by your system.

Parent panels

- [Set Processing Options panel on page 795](#)

Child panels

- None.

Comments

- None.

Set PL/I Processing Options panel

You use the Set PL/I Processing Options panel to customize how FM/Db2 compiles PL/I copybooks to generate FM/Db2 templates.

These options are saved in your ISPF profile and persist from one FM/Db2 session to the next.

Panel and field definitions

Process	Options	Utilities	Help
FM/Db2 (DFG2)	Set PL/I Processing Options		
Additional SYSLIB data sets:			
1.	_____		
2.	_____		
3.	_____		
4.	_____		
5.	_____		
6.	_____		
7.	_____		
8.	_____		
9.	_____		
10.	_____		
PL/I Compiler Options for Copybooks:			
Enter "/" to select option			
_ GRAPHIC		_ UNALIGNED	
_ 63 bit binary		_ 31 digit decimal	
Additional options			
Maximum Return Code to be accepted from compiler <u>04</u> (0-99)			
Command ==>			
F1=Help	F2=Split	F3=Exit	F7=Backward F8=Forward F9=Swap
F12=Cancel			

Additional SYSLIB data sets

Any additional SYSLIB data sets to be used in the compilation of PL/I copybooks.

PL/I Compiler Options

These options determine how FM/Db2 compiles PL/I copybooks to generate FM/Db2 templates.

Additional SYSLIB data sets

The names of data sets to be searched if your copybooks contain references to other PL/I copybooks.

GRAPHIC

Select this option if the copybook contains DBCS or mixed data.

UNALIGNED

Select this option if fields are not aligned on full-word boundaries.

63 bit binary

Select this option if you require support for 63 bit binary numbers. The PL/I compiler option LIMITS(FIXEDBIN(63)) is used when you select this option.

31 digit decimal

Select this option if you require support for 31 digit decimal numbers. The PL/I compiler option LIMITS(FIXEDDEC(31)) is used when you select this option.

Additional options

Additional PL/I compiler options which are added via the *PROCESS statement when a PL/I compile is run to build or update template. These options are validated during the compile process. To avoid compile errors ensure that the syntax is correct and that any additional data sets required by these options are allocated before invoking File Manager.

For details on the effects of using these options, see the *IBM VisualAge PL/I for OS/390 Programming Guide*.

Maximum Return Code

Sets the maximum warning/error code accepted from the compiler when compiling a copybook. Any code higher than specified causes FM/Db2 to display a pop-up panel, in which you can review the compilation and decide about future processing.

Child panels

None.

Related tasks

- [Setting default processing options on page 60](#)

Set Print Processing Options panel

You use the Set Print Processing Options panel to control processing of the current FM/Db2 session.

These options are saved in your ISPF profile and persist from one FM/Db2 session to the next.

Panel and field definitions

```

Process  Options  Help
-----
FM/Db2 (DFE2)          Set Print Processing Options

Print Options:
Output destination      Record length      Enter "/" to select option
 1 1. SYSPRINT          2 1. 80             _ Page skip
 2. Terminal            2. 132             / Wide print
 3. Data set            / Translate non-printable chars
 4. REXX                _ Uppercase message text

Data set DISP
 2 1. OLD
 2. MOD

Data set name . . . FMUSER.FMN.LIST
Output class . . . A
Lines per page . . . 50
Record limits . . . (1,*) (n,m) n=begin column, m=end column

Command ==> -----
F1=Help      F2=Split    F3=Exit     F4=CRetriev F6=Reset    F7=Backward
F8=Forward   F9=Swap     F10=Actions F12=Cancel
    
```

Output destination

Specifies where print output is sent, except for batch execution.

SYSPRINT

Send print output to the current SYSPRINT allocation.

Terminal

Send print output to the TSO terminal.

Data set

Output is accumulated in the print data set specified in the **Data set name** field. This data set can be browsed using the PB command, or sent for printing to the JES spool queue with class specified in the **Output class** field using the PRINT command while browsing.

REXX

Send output to a REXX stem variable. Each line corresponds to a variable named FILEM.*nnn*. FILEM.0 contains the line count.

When you use the PRINT primary command in Print Browse (option 3.9), or if you specify batch execution in a File Manager/Db2 panel, then print output is always sent to a SYSOUT class.

Record length

Specifies the line length of print output.

80

The line length of print output is 80 characters, suitable for a terminal.

132

The line length of print output is 132 characters, suitable for a printer.



Note: Record length is not applicable when:

- The data is printed in TABL format, or
- You specify the wide format for the compare output listing

In either of the above cases, when data is printed the line length is determined from the number and size of fields printed. If this length is greater than the record length specified for the data set, the print line is truncated. The maximum print line length is 32760.

Data set DISP

Specifies the disposition of a print data set.

OLD

The print data set is cleared before each print operation, and print output is written from the beginning of the data set.

MOD

Default setting. Print output is appended to the existing print data set.

Page skip

If selected, print output from each function begins on a new page.

Wide print

If selected, for to-be-allocated (new) print output datasets (online) or for SYSPRINT allocation (in batch), FM/Db2 uses the maximum record length/blocksize of 32756/32760 and record format of VBA.

If not selected, for to-be-allocated (new) print output datasets (online) or for SYSPRINT allocation (in batch), FM/Db2 uses the record length/blocksize of 133/137 and record format of VBA.



Note: This setting only applies when the output dataset is newly-allocated during execution. It is ignored for pre-allocated print output datasets.

Translate non-printable chars

Specifies how FM/Db2 should translate non-printable characters.

If selected, non-printable characters are translated to blanks using a translate table.

If not selected, no translation is performed. Use PRTRTRANS=OFF to support special print chains. This may make printing faster.

For instructions on altering the print translate table, see the *File Manager Customization Guide*.

Uppercase message text

All message text is translated to uppercase.

Data set name

If you specified the **Output destination** as **3** (Data set), then after you enter the PRINT command while executing the Print Browse (PB) function, FM/Db2 sends print output to this temporary data set.

The default is *userid.FMN.LIST*, unless changed in your FM/Db2 installation.

Output class

The class of the JES spool queue to be used when the PRINT command is issued while browsing the temporary print data set.

Lines per page

Specifies the number of lines printed on each page of print output. You can specify a value from 1 to 999. The default is 60.

Record limits

When data is printed in CHAR or LHEX print format, limits print output for each record (or OAM object).

(1,*)

The entire record (or block) is printed.

(n,m)

Print output is limited to the data from columns (bytes) *n* through *m*. An asterisk (*) specified for *m* indicates the end of the record.

Parent panels

- [Set System Processing Options panel on page 797](#)

Child panels

None.

Related tasks

- [Print settings \(option 0.1\) on page 62](#)
- [PRINT primary command on page 928](#)
- [Looking at the print output from your FM/Db2 session on page 326](#)

Set Processing Options panel

You use the Set Processing Options panel to navigate to other panels from which you can set various types of options that affect the behavior of FM/Db2 panels. These options are saved in your ISPF profile and persist from one FM/Db2 session to the next.

Panel and field definitions

Process	Help
FM/Db2 (DFG2)	Set Processing Options
0	System System Options
1	View View options
2	Edit Edit options
3	Utilities
3.1	Print Print utility options
3.3	Copy Copy utility options
3.4	Object List Object list utility options
3.6	Import Import utility options
3.7	Export Export utility options
3.L	Load Db2 LOAD utility options
3.U.L	LISTDEF Db2 Utility LISTDEF options
3.U.O	OPTIONS Db2 Utility OPTIONS options
3.U.T	TEMPLATE Db2 Utility TEMPLATE options
3.U.U	Unload Db2 Unload utility options
Command ==> _____	
F1=Help	F2=Split F3=Exit F7=Backward F8=Forward F9=Swap
F12=Cancel	

0 System Options

Displays the Set System Processing Options panel

1 View

Displays the first Editor Options panel

2 Edit

Displays the first Editor Options panel

3 Utilities

Displays the Set Utilities Processing Options panel

3.1 Print

Displays the Print Utility Options panel

3.3 Copy

Displays the Copy Options panel

3.4 Object List

Displays the FM/Db2 Object List Options (1 of 2) panel

3.6 Import

Displays the Import Options panel

3.7 Export

Displays the first Export Options panel

3.L LOAD

Displays the Load Utility Options panel

3.UL LISTDEF

Displays the LISTDEF Options panel

3.UO OPTIONS

Displays the OPTIONS Options panel

3.UT TEMPLATE

Displays the TEMPLATE Options (1 of 2) panel

3.UU Unload

Displays the UNLOAD Options panel

Parent panels

- [Primary Option Menu panel on page 728](#)

Child panels

To display this panel...	Use/do this
Set System Processing Options panel on page 797	Option 0
Set Print Processing Options panel on page 792	Option 0.1
Systems Options (1 of 4) panel on page 817	Option 0.2
Set Batch Job Card Information panel on page 784	Option 0.3

To display this panel...	Use/do this
Compiler Language Selection panel on page 493	Option 0.4
Set COBOL Processing Options panel on page 785	Option 0.5
Set HLASM Processing Options panel on page 787	Option 0.6
Set PL/I Processing Options panel on page 790	Option 0.7
Set Temporary Data Set Allocation Options panel on page 800	Option 0.8
Set Output Data Set Allocation Options panel on page 789	Option 0.9
ISPF Settings panel on page 700	Option 0.10
Editor Options (1 of 8) panel on page 625	Option 1 or 2
Set Utility Options panel on page 803	Option 3
Print Utility Options panel on page 731	Option 3.1
Copy Options panel on page 495	Option 3.3
Object List Options (1 of 2) panel on page 714	Option 3.4
Import Options panel on page 690	Option 3.6
Export Options (1 of 3) panel on page 665	Option 3.7
LOAD Utility Options panel on page 710	Option 3.L
LISTDEF Options panel on page 702	Option 3.UL
OPTIONS Options panel on page 721	Option 3.UO
TEMPLATE Options (1 of 2) panel on page 846	Option 3.UT
UNLOAD Options panel on page 854	Option 3.UU

Related tasks

- [Setting default processing options on page 60](#)

Set System Processing Options panel

You use the Set System Processing Options panel to navigate to other options panels.

Panel and field definitions

Process	Help
FM/Db2 (DFG2)	Set System Processing Options
1 Print	Print settings
2 System	FM/Db2 system options
3 Batch	Job card specifications
4 LANG	Compiler language selection
5 COBOL	COBOL compiler specifications
6 HLASM	HLASM compiler specifications
7 PL/I	PL/I compiler specifications
8 Temporary	Temporary Data Set Allocations
9 Output	Output Data Set Allocations
10 Trace	Trace options
11 ISPF	ISPF settings
Command ==>	
F1=Help	F2=Split F3=Exit F7=Backward F8=Forward F9=Swap
F12=Cancel	

1 Print

Displays the Set Print Processing Options panel

2 System

Displays the first FM/Db2 System Options panel

3 Batch

Displays the Set Batch Job Card Information panel

4 LANG

Displays the Compiler Language Selection panel

5 COBOL

Displays the Set COBOL Processing Options panel

6 HLASM

Displays the Set HLASM Processing Options panel

7 PL/I

Displays the Set PL/I Processing Options panel

8 Temporary

Displays the Set Temporary Data Set Allocation Options panel

9 Output

Displays the Set Output Data Set Allocation Options panel

10 Trace

Displays the Set Trace options panel

11 ISPF

Displays the ISPF Settings panel

For a description of the fields on the ISPF Settings panel, see the relevant *z/OS ISPF User's Guide Vol II*.

Parent panels

- [Set Processing Options panel on page 795](#)

Child panels

To display this panel...	Use/do this
Set Print Processing Options panel on page 792	Option 1
Systems Options (1 of 4) panel on page 817	Option 2
Set Batch Job Card Information panel on page 784	Option 3
Compiler Language Selection panel on page 493	Option 4
Set COBOL Processing Options panel on page 785	Option 5
Set HLASM Processing Options panel on page 787	Option 6
Set PL/I Processing Options panel on page 790	Option 7
Set Temporary Data Set Allocation Options panel on page 800	Option 8
Set Output Data Set Allocation Options panel on page 789	Option 9
Set Trace options panel on page 801	Option 10
ISPF Settings panel on page 700	Option 11

Related tasks

- [Setting default processing options on page 60](#)

Set Temporary Data Set Allocation Options panel

Panel and field definitions

Figure 133. Set Temporary Data Set Allocation Options panel

Process	Options	Help
FM/Db2 (DFG2)	Set Temporary Data Set Allocation Options	
Set processing options as desired and enter EXIT (F3) to save your changes. Enter RESET to restore installation defaults.		
Temporary data set allocation defaults:		
Unit	SYSALLDA	leave blank for default
Data class	_____	leave blank for default
Storage class	_____	leave blank for default
Management class	_____	leave blank for default
Default High Level Qualifiers:		
Temporary Data Sets	_____	HLQ (opt. &USER/&PREFIX)
Command ==>		
F1=Help	F2=Split	F3=Exit
F4=CRetriev	F6=Reset	F7=Backward
F8=Forward	F9=Swap	F10=Actions
F12=Cancel		

Temporary data set allocation defaults

Unit

Can be one of these:

- A 3-digit hexadecimal device number.
- A 4-digit hexadecimal device number prefixed with a slash (/).
- Device type (generic name).
- Group name (installation-defined symbolic name).

Data class

Name of a data class defined in your Storage Management System (SMS) installation. Do not enter a value on a system without SMS.

Storage class

Name of a storage class defined in your Storage Management System (SMS) installation. Do not enter a value on a system without SMS.

Management class

Name of a management class defined in your Storage Management System (SMS) installation. Do not enter a value on a system without SMS.

Default High Level Qualifiers

Temporary Data Sets

Can be any multi-level qualifier, which is used by File Manager as the high-level qualifier (HLQ) in names of created datasets. You can use these symbols as part of the HLQ:

&USER

Represents the user ID.

&PREFIX

Represents the TSO prefix.

The default is none (unless changed in your File Manager installation).

Parent panels

- [Set Processing Options panel on page 795](#)

Child panels

- None.

Comments

- None.

Set Trace options panel

The Set Trace options panel allows you to view and modify parameters that control the Trace output produced by FM/Db2 when it is run in debug mode.

Panel and field definitions

Figure 134. Set Trace options panel

Process	Options	Help
FM/Db2 (DFE2)	Set Trace options	
Trace Options:		
Trace destination		
3	1. FMNTRC	
	2. Terminal	
	3. Data set	
Data set name	JHELVON.FMN.TRACE	
Output class	. A	
Trace limit	. 500	
Command ==>		
F1=Help	F2=Split	F3=Exit
F4=CRetrieve	F6=Reset	F7=Backward
F8=Forward	F9=Swap	F10=Actions
F12=Cancel		

Trace destination

Specifies where debug trace FM/Db2 output is to be sent:

FMNTRC

Send trace output to the current FMNTRC allocation.

Terminal

Send trace output to the terminal.

Data set

Send trace output to the temporary data set specified by the **Data set name** field.

Data set name

The temporary trace data set where FM/Db2 trace output is directed when the Data set trace destination is specified.

Output class

The class of the JES spool queue to be used when the PRINT command is issued when browsing the temporary trace data set.

Trace limit

When run in debug mode, FM/Db2 writes the Trace output to a buffer (as for normal debug mode), but the buffer is only written to the Trace destination, if FM/Db2 abnormally terminates.

This field specifies the number of Trace statements that are retained in the buffer. If you specify a value of zero, background debug mode is turned off.

Parent panels

[Set System Processing Options panel on page 797](#)

Child panels

None.

Related tasks**Set Utility Options panel**

You use the Set Utility Processing Options panel to navigate to other options panels.

Panel and field definitions

Process	Help
FM/Db2 (DFG2)	Set Utility Processing Options
1 Print	Print utility options
3 Copy	Copy utility options
4 Object list	Object list utility options
6 Import	Import utility options
7 Export	Export utility options
L LOAD	Db2 LOAD utility options
UL LISTDEF	Db2 Utility LISTDEF options
UO OPTIONS	Db2 Utility OPTIONS options
UT TEMPLATE	Db2 Utility TEMPLATE options
UU Unload	Db2 Unload utility options
Command ==>	
F1=Help	F2=Split F3=Exit F7=Backward F8=Forward F9=Swap
F12=Cancel	

1 Print

Displays the Copy Options panel

3 Copy

Displays the Copy Options panel

4 Object list

Displays the FM/Db2 Object List Options (1 of 2) panel

6 Import

Displays the Import Options panel

7 Export

Displays the first Export Options panel

L LOAD

Displays the Load Utility Options panel

UL LISTDEF

Displays the LISTDEF Options panel

UO OPTIONS

Displays the OPTIONS Options panel

UT TEMPLATE

Displays the TEMPLATE Options (1 of 2) panel

UU Unload

Displays the UNLOAD Options panel

Parent panels

- [Set Processing Options panel on page 795](#)

Child panels

To display this panel...	Use/do this
Copy Options panel on page 495	Option 3
Object List Options (1 of 2) panel on page 714	Option 4
Import Options panel on page 690	Option 6
Export Options (1 of 3) panel on page 665	Option 7
LOAD Utility Options panel on page 710	Option L
LISTDEF Options panel on page 702	Option UL
OPTIONS Options panel on page 721	Option UO
TEMPLATE Options (1 of 2) panel on page 846	Option UT
UNLOAD Options panel on page 854	Option UU

Related tasks

- [Setting default processing options on page 60](#)

Sort Fields panel

You use the Sort Fields panel to sort multiple columns within the current object list.

Panel and field definitions

Process	Options	Utilities	Help	
FM/Db2 (DFG2)			Sort Fields	Row 1 to 11 of 43
Sort				
Column	Asc/ Desc	Column Name	Column Type	Db2 Column Number
		*	*	*
0	ASC	NAME	VARCHAR	1
0	ASC	CREATOR	CHAR	2
0	ASC	TYPE	CHAR	3
0	ASC	DBNAME	CHAR	4
0	ASC	TSNAME	CHAR	5
0	ASC	DBID	SMALLINT	6
0	ASC	OBID	SMALLINT	7
0	ASC	COLCOUNT	SMALLINT	8
0	ASC	EDPROC	CHAR	9
0	ASC	VALPROC	CHAR	10
0	ASC	CLUSTERTYPE	CHAR	11
Command ==>				Scroll PAGE
F1=Help	F2=Split	F3=Exit	F4=CRetriev	F7=Backward
F9=Swap	F10=Actions	F12=Cancel	F8=Forward	

Sort Column Number

The relative position of this column in the sort sequence. Specify 1 for the most significant column, 2 for the next significant, and so on.

Asc/Desc

Indicates if you want FM/Db2 to sort the column in ascending or descending sequence:

ASC

Ascending. To change from DESC, overwrite with ASC or A.

DESC

Descending. To change from ASC, overwrite with DESC or D.

Column Name

The name of the column as held in the Db2® catalog table.

Column Type

The data type of the column.

Db2® Column Number

The number of the column as held in the Db2® catalog table.

Parent panels

The Sort Fields panel is displayed when you enter `SORT` on the command line from any object list and the cursor is *not* positioned within any column.

Child panels

To display this panel...	Use/do this
Databases panel on page 593	Object Type 1
Table Spaces panel on page 834	Object Type 2
Tables, Views and Aliases panel on page 843	Object Type 3
Indexes panel on page 697	Object Type 4
Columns panel on page 491	Object Type 5
Synonyms panel on page 815	Object Type 6
Application Plans panel on page 463	Object Type 7
Application Packages panel on page 460	Object Type 8
Collections panel on page 471	Object Type 9
Database Request Modules panel on page 591	Object Type 10
Schemas panel on page 779	Object Type 11
Distinct Types panel on page 619	Object Type 12
Functions panel on page 684	Object Type 13
Stored Procedures panel on page 813	Object Type 14
Triggers panel on page 853	Object Type 15

Related tasks

- [Sorting the displayed data on page 316](#)

SQL Prototyping, Execution and Analysis panel

You use the SQL Prototyping, Execution and Analysis panel to select the FM/Db2 SQL function you want to use.

Panel and field definitions

<u>P</u> rocess	<u>O</u> ptions	<u>U</u> tilities	<u>H</u> elp
FM/Db2 (DFG2)	SQL Prototyping, Execution and Analysis		
1 Basic	Prototype SELECT statements (basic)		
2 Advanced	Prototype SELECT statements (advanced)		
3 Enter	Enter, execute and explain SQL statements		
4 Edit	Edit and execute SQL statements from a data set		
5 Utility	Manage tables used by SQL explain		
Command ==>			
F1=Help	F2=Split	F3=Exit	F7=Backward F8=Forward F9=Swap
F12=Cancel			

1 (Basic)

Use this option to build and execute a basic SELECT statement.

2 (Advanced)

Use this option to build and execute a complex SELECT statement.

3 (Enter)

Use this option to enter, execute, and explain SQL statements.

4 (Edit)

Use this option to edit and execute SQL statements from a data set.

5 (Utility)

Use this option to select utilities to support the use of the Db2® EXPLAIN statement.

Parent panels

- [Primary Option Menu panel on page 728](#)

Child panels

To display this panel...	Use/do this
Basic SELECT Prototyping panel on page 465	Option 1
Advanced SELECT Prototyping panel on page 442	Option 2
Enter, Execute and Explain SQL Statements panel on page 660	Option 3
Edit/Execute SQL (Data Set) panel on page 623	Option 4
Explain Utilities panel on page 662	Option 5

Related tasks

- [Using basic SQL prototyping on page 382](#)
- [Using advanced SQL prototyping on page 391](#)
- [Entering, executing, and explaining SQL statements on page 416](#)
- [Editing and executing SQL statements from a data set on page 421](#)
- [Managing tables used by SQL explain on page 422](#)

Statement Table Rows panel

FM/Db2 displays the Statement Table Rows panel if you use the SR line command against an item listed on the [Plan Table Rows panel on page 725](#).

Use this panel to display the rows from a table.

Figure 135. Statement Table Rows panel (collection ID format)

```

Process  Options  Utilities  Help
-----
FM/Db2 (DFG2)                Statement Table Rows                Row 1 to 1 of 1
C          Query COLLECT. Prognam Stmt  C  Estimated  Estimated
  Number (COLLID) (PACKG) Type   C Serv. Units  Proc. ms Reason
-----* *-----*-----*-----* *-----*-----*
__ 2001071003 FMN2TEST MGRMAIN  SELECT A          13          3
***** END OF Db2 DATA *****

Command ==>
F1=Help      F2=Split      F3=Exit      F4=CRetriev  F7=Backward  F8=Forward
F9=Swap      F10=Actions   F12=Cancel
    
```

The Statement Table Rows panel shows you rows from a statement table:

C

Input field where you can enter one of the following line commands:

DK

Delete rows for package

DP

Delete rows for plan

DQ

Delete rows for query number

I

Interpret EXPLAIN data

K

Show package

M

Show DBRM

P

Show plan

Query Numb

A number that identifies the SQL statement.

Applname

PLAN name or blank for dynamic EXPLAIN. This information only is displayed for the PLAN format of the panel.

Collect.

Collection name. This information only is displayed for the COL format of the panel.

Progrname

DBRM/package name.

Stmt Type

Statement type.

C C

Cost category:

A

Not using default values.

B

Using default values when calculating costs.

Est. SU

Estimated processor cost in service units.

Est. P ms.

Estimated processor cost in milliseconds.

Reason

A string indicating the reason for putting an estimate into cost category B (see **C C**).

Parent panels

- [Plan Table Rows panel on page 725](#)

Child panels

To display this panel...	Use/do this
EXPLAIN Interpretation panel on page 662	Line command I
Application Packages panel on page 460	Line command K

Related tasks

- [Managing tables used by SQL explain on page 422](#)

Storage Group(s) panel

You use the Stored Group(s) panel to display information about the storage groups you have selected.

Panel and field definitions

The columns that are displayed include the SEL field and columns of SYSIBM.SYSTOGROUP.

Figure 136. Storage Group(s) panel

```

  Process  Options  Utilities  Help
-----
FM/Db2 (DFG2)          Storage Group(s)
Location:                                     Format TABL
+
SEL  NAME      CREATOR  VCATNAME      SPACE  SPCDATE  CREATEDBY  STATSTIME
---- *-----*-----*-----*-----*-----*-----*
---- #1-----#2-----#3-----#5 #6-----#8-----#9-----1-----
**** Top of data ****
----- DSN8G810 CJUNELL  DFA2          0          CJUNELL  0001-01-01-00.
----- JLV3G810 SHRIKES  DFA2          0          SHRIKES  0001-01-01-00.
----- JOHNG810 SHRIKES  DFA2          0          SHRIKES  0001-01-01-00.
----- KPS8G810 SHRIKES  DFA2          0          SHRIKES  0001-01-01-00.
----- KPSAG810 SHRIKES  DFA2          0          SHRIKES  0001-01-01-00.
----- SYSDEFLT CJUNELL  DFA2          0          CJUNELL  0001-01-01-00.
**** End of data ****

Command ==>>
F1=Help      F2=Zoom      F3=Exit      F4=CRetriev  F5=RFind     F6=RChange
F7=Up        F8=Down      F9=Swap      F10=Left     F11=Right    F12=Cancel
  
```

 **Note:**



1. The system option, **Show all catalog table columns**, affects which columns FM/Db2 displays when you use the Object List utility.
2. You can also customize which columns FM/Db2 displays when you use the Object List utility. For details, see the *File Manager Customization Guide*.

To view other columns on this panel, press the Right function key (F11).

For a complete list of columns, refer to “Db2® catalog tables” in the *DB2 for z/OS SQL Reference* relevant to your version of Db2®.

SEL

Line command area.

For a list of the line commands you can use on this panel, see [Table 22: Object list line commands on page 308](#).

Parent panels

- [Object List Utility panel on page 719](#)

Child panels

To display this panel...	Use/do this
Databases panel on page 593	Line command D
Storage Group Usage Privileges panel on page 812	Line command P
Table Space Parts panel on page 834	Line command PT
Display Row panel on page 619	Line command ROW
Table Spaces panel on page 834	Line command S
Volumes panel on page 868	Line command VOL
Indexes panel on page 697	Line command X
Index Parts panel on page 697	Primary command XPT

Related tasks

- [Working with object list panels on page 301](#)
- [Using the line command area \(Cmd\) on page 308](#)

Related references

- [SORT primary command on page 941](#)

Related tasks

- [Managing tables used by SQL explain on page 422](#)

Storage Group Usage Privileges panel

Figure 137. Storage Group Usage Privileges panel

Process	Options	Utilities	Help				
FM/Db2 (DFG2)				Storage Group Usage Privileges for DSN8G810			
							Format <u>TABL</u>
SEL	GRANTOR	GRANTEE	QUALIFIER	NAME	AUTHHOEX	OBTYPPEEX	USEAUTEX
----	*#1-----	*#2-----	*#3-----	*#4-----	*#15-----	*#16-----1---	*#17---
****	Top of data		****				
----	CJUNELL	CJUNELL		DSN8G810	SYSADM	Storage Group	Grant
----	CJUNELL	PUBLIC		DSN8G810	SYSADM	Storage Group	Yes
----	SHRIKE2	ID1		DSN8G810	SYSADM	Storage Group	Yes
****	End of data		****				
Command ==>				Scroll <u>PAGE</u>			
F1=Help	F2=Zoom	F3=Exit	F4=CRetriev	F5=RFind	F6=RChange		
F7=Up	F8=Down	F9=Swap	F10=Left	F11=Right	F12=Cancel		



Note: To view other columns on this panel, press the Right function key (F11).

For a complete list of columns, refer to “*Db2® catalog tables*” in the *DB2 for z/OS SQL Reference* relevant to your version of Db2®.

SEL

Line command area.

For a list of the line commands you can use on this panel, see [Table 22: Object list line commands on page 308](#).

Parent panels

- [Storage Group\(s\) panel on page 810](#)

Child panels

To display this panel...	Use/do this
Grant Storage Group Privileges panel	Line command G
Storage Group Use Privilege Details panel	Line command I

To display this panel...	Use/do this
Revoke Storage Group Privileges panel	Line command R
Display Row panel on page 619	Line command ROW

Related tasks

- [Working with object list panels on page 301](#)
- [Using the line command area \(Cmd\) on page 308](#)

Related tasks

- [Managing tables used by SQL explain on page 422](#)

Stored Procedures panel

You use the Stored Procedures panel to display information about the stored procedures you have selected.

Panel and field definitions

The columns that are displayed include the SEL field and columns of SYSIBM.SYSROUTINES.

Process	Options	Utilities	Help			
FM/Db2 (DFG2)		Stored Procedures				Format <u>TABL</u>
Location:						
SEL	SCHEMA	NAME	ORIGINEX	OWNER	ROUTINEX	CREATEDB
----	*-----*	*-----*	*-----*	*-----*	*-----*	*-----*
	#1-----	#3-----1-----	#90-+---	#2-+---	#89-+-----1-----	#5-+---
****	Top of data					****
----	SYSPROC	DSNWZP	External	CJUNELL	Stored procedure	CJUNELL
----	SYSPROC	DSNWSPM	External	CJUNELL	Stored procedure	CJUNELL
----	SYSPROC	DSNUTILS	External	CJUNELL	Stored procedure	CJUNELL
----	SYSPROC	DSNUTILU	External	CJUNELL	Stored procedure	CJUNELL
----	SYSPROC	DSNTPSMP	External	CJUNELL	Stored procedure	CJUNELL
----	SYSPROC	WLM_REFRESH	External	CJUNELL	Stored procedure	CJUNELL
----	SQLJ	INSTALL_JAR	External	CJUNELL	Stored procedure	CJUNELL
----	SQLJ	REPLACE_JAR	External	CJUNELL	Stored procedure	CJUNELL
----	SQLJ	REMOVE_JAR	External	CJUNELL	Stored procedure	CJUNELL
----	SYSPROC	DSNACICS	External	CJUNELL	Stored procedure	CJUNELL
----	SYSPROC	DSNACCOR	External	CJUNELL	Stored procedure	CJUNELL
Command ==>>						Scroll <u>PAGE</u>
F1=Help	F2=Split	F3=Exit	F4=Expand	F7=Backward	F8=Forward	
F9=Swap	F10=Left	F11=Right	F12=Cancel			



Note:



1. The system option, **Show all catalog table columns**, affects which columns FM/Db2 displays when you use the Object List utility.
2. You can also customize which columns FM/Db2 displays when you use the Object List utility. For details, see the *File Manager Customization Guide*.

To view other columns on this panel, press the Right function key (F11).

For a complete list of columns, refer to “Db2® catalog tables” in the *DB2 for z/OS SQL Reference* relevant to your version of Db2®.

SEL

Line command area.

For a list of the line commands you can use on this panel, see [Table 22: Object list line commands on page 308](#).

Parent panels

- [Object List Utility panel on page 719](#)
- [Schemas panel on page 779](#)

Child panels

To display this panel...	Use/do this
Alter Stored Procedure panel on page 447	Line command A
See Comment panels on page 493	Line command COM
Create Procedure panel on page 538	Line command CR
See Drop panels on page 621	Line command DR
Grant privileges panels on page 689	Line command G
Generate SQL From Db2 Catalog panel on page 686	Line command GEN
Details panels on page 618	Line command I
Privileges panels on page 736	Line command P
Routine Parameters panel on page 767	Line command PARM
Application Packages panel on page 460	Line command PKG
	Line command PS
Revoke privileges panels on page 766	Line command R
Display Row panel on page 619	Line command ROW

To display this panel...	Use/do this
Schemas panel on page 779	Line command SCH
Sort Fields panel on page 804	Primary command SORT

Related tasks

- [Working with object list panels on page 301](#)
- [Using the line command area \(Cmd\) on page 308](#)

Synonym Dependencies panel

FM/Db2 displays the Synonym Dependencies panel if you use the SYN line command against an item listed on:

- The [Application Plans panel on page 463](#), or
- The [Application Packages panel on page 460](#)

Synonyms panel

You use the Synonyms panel to list synonyms in the Db2® catalog.

Panel and field definitions

The columns that are displayed include the SEL field and columns of SYSIBM.SYSSYNONYMS.

<u>P</u> rocess	<u>O</u> ptions	<u>U</u> tilities	<u>H</u> elp		
FM/Db2 (DFG2)				Synonyms	
Location:				Format <u>TABL</u>	
SEL	CREATOR	NAME	TBCREATOR	TBNAME	CREATEDBY
	*	*	*	*	*
----	#2-----	#1-----1-----	#4-----1--	#3-----1-----	#6-----
****	Top of data ****				
----	CJUNELL	ACT	DSN8810	ACT	CJUNELL
----	CJUNELL	DEPT	DSN8810	DEPT	CJUNELL
----	CJUNELL	EMP	DSN8810	EMP	CJUNELL
----	CJUNELL	EMPPROJECT	DSN8810	EMPPROJECT	CJUNELL
----	CJUNELL	PROJ	DSN8810	PROJ	CJUNELL
----	CJUNELL	PROJECT	DSN8810	PROJECT	CJUNELL
----	CJUNELL	TCONA	DSN8810	TCONA	CJUNELL
----	CJUNELL	TDSPTXT	DSN8810	TDSPTXT	CJUNELL
----	CJUNELL	TOPTVAL	DSN8810	TOPTVAL	CJUNELL
----	CJUNELL	VACT	DSN8810	VACT	CJUNELL
----	CJUNELL	VASTRDE1	DSN8810	VASTRDE1	CJUNELL
Command ==>				Scroll <u>PAGE</u>	
F1=Help	F2=Zoom	F3=Exit	F4=CRetriev	F5=RFind	F6=RChange
F7=Up	F8=Down	F9=Swap	F10=Left	F11=Right	F12=Cancel



Note:



1. The system option, **Show all catalog table columns**, affects which columns FM/Db2 displays when you use the Object List utility.
2. You can also customize which columns FM/Db2 displays when you use the Object List utility. For details, see the *File Manager Customization Guide*.

To view other columns on this panel, press the Right function key (F11).

For a complete list of columns, refer to “Db2® catalog tables” in the *DB2 for z/OS SQL Reference* relevant to your version of Db2®.

SEL

Line command area.

For a list of the line commands you can use on this panel, see [Table 22: Object list line commands on page 308](#).

Parent panels

- [Object List Utility panel on page 719](#)
- [Tables, Views and Aliases panel on page 843](#)

Child panels

To display this panel...	Use/do this
Create Synonym panel on page 545	Line command CR
Create Alias panel on page 512	Line command CRA
See Drop panels on page 621	Line command DR
Details panels on page 618	Line command I
Display Row panel on page 619	Line command ROW
Tables, Views and Aliases panel on page 843	Line command T
Sort Fields panel on page 804	Primary command SORT

Related tasks

- [Working with object list panels on page 301](#)
- [Using the line command area \(Cmd\) on page 308](#)

Related references

- [SORT primary command on page 941](#)

Systems Options (1 of 4) panel

You use the FM/Db2 Systems Options (1 of 4) panel to set various options that affect the way in which FM/Db2 operates. These options are saved in your ISPF profile and persist from one FM/Db2 session to the next.

Panel and field definitions

Figure 138. FM/Db2 System Options (1 of 4) panel

<u>P</u> rocess	<u>O</u> ptions	<u>U</u> tilities	<u>H</u> elp
FM/Db2 (DFG2)	FM/Db2 System Options (1 of 4)		Global Settings
Uppercase Translation:			
Enter "/" to select option			
/ Translate Db2 object names			
/ Translate input SQL statements			
Encapsulation of SQL Identifiers in Double Quotes:			
Use double quotes			
3 1. For Db2 SQL reserved words			
2. For IBM and Db2 SQL reserved words			
3. Always			
More Options:			
Enter "/" to select option			
/ Arbitrary select statements, time display format, template creation			
/ CCSID warning option			
/ Editor choice for viewing output data, members; cancel confirmation			
Command ==>			
F1=Help	F2=Split	F3=Exit	F7=Backward F8=Forward F9=Swap
F11=NxtPage	F12=Cancel		

Translate Db2® object names

Translates Db2® object owner and Db2® object name to uppercase. (The Db2® object location is always translated to uppercase.) The default is selected.

If you do not select this option, the Db2® object owner and Db2® object name remain as entered by the user.

Translate input SQL statements

Translates any free-form SQL statements entered to uppercase. The default is selected.

If you do not select this option, any free-form SQL statements entered remain as entered by the user.

Encapsulation of SQL Identifiers in Double Quotes

The SQL identifiers encapsulated in double quotation marks in SQL statements generated by FM/Db2. You can select one of the following:

- **1. For Db2® SQL reserved words**

If your Db2® objects include column names that are Db2® SQL reserved words, you must enclose these column names in double quotation marks. Use this option to only enclose identifiers that are Db2® SQL reserved words in double quotation marks. Any other identifiers appear in SQL statements without encapsulating double quotation marks. This option is recommended if you are using the SQL

primary command (see [SQL primary command on page 942](#)) to generate and save SQL statements for later use.

- **2. For IBM® and Db2® SQL reserved words**

Use this option to recognize any identifiers that are either a Db2® SQL reserved word, or an IBM® SQL reserved word, and enclose these words in double quotation marks. Any other identifiers appear in SQL statements without encapsulating double quotation marks.

- **3. Always.** This is the default setting. This option applies to view, edit, browse, print, copy, import and export functions only and results in all identifiers being enclosed in double quotation marks in SQL statements generated by FM/Db2.



Note:

1. For information about the rules covering the construction of SQL identifiers, see the *DB2 for z/OS SQL Reference*.
2. In general, you can use any uppercase alphabetic character and three special characters (\$, _, and @) in an SQL identifier without special consideration. If your identifier includes lowercase characters, spaces, or other characters, then you must enclose the identifier in double quotation marks. FM/Db2 detects identifiers with lowercase and other unusual characters and encloses these in double quotation marks. This occurs regardless of the encapsulation option selected.
3. The lists of Db2® and IBM® SQL reserved words used by FM/Db2 are the latest available. When connected to an older release of Db2®, if you have selected either options 1 or 2, FM/Db2 might recognize an identifier as a reserved word, even though the identifier is not defined as a reserved word in the earlier release of Db2®.

Parent panels

- [Set System Processing Options panel on page 797](#)

Child panels

To display this panel...	Use/do this
Systems Options (2 of 4) panel on page 819	Press the NxtPage function key (F11)

Related tasks

- [Setting default processing options on page 60](#)
- [FM/Db2 system options \(option 0.2\) on page 63](#)
- [TIME columns on page 165](#)
- [INDEXINF primary command on page 911](#)

- ["No Primary Key" errors on page 198](#)
- ["Row Not Found" errors on page 200](#)

Related references

- [SQL primary command on page 942](#)

Systems Options (2 of 4) panel

You use the FM/Db2 Systems Options (2 of 4) panel to set various options that affect the way in which FM/Db2 operates. These options are saved in your ISPF profile and persist from one FM/Db2 session to the next.

Panel and field definitions

Figure 139. FM/Db2 System Options (2 of 4) panel

Process	Options	Utilities	Help
FM/Db2 (DFG2)	FM/Db2 System Options (2 of 4)		Global Settings
Arbitrary SQL Select Statements:			
Editor option			
1. Browse			
2. View			
3. Edit			
Display Format for DATE/TIME Columns:			
Time display format		Date display format	
1. ISO (HH.MM.SS)		1. ISO (yyyy-mm-dd)	
2. JIS (HH:MM:SS)		2. EVR (dd.mm.yyyy)	
3. Db2 DSNHDECP setting		3. USA (mm/dd/yyyy)	
		4. Db2 DSNHDECP setting	
Catalog Queries and Template Creation:			
Enter "/" to select option			
/ Use uncommitted read when accessing the Db2 catalog			
- Retrieve foreign key information when building templates			
Command ==>			
F1=Help	F2=Split	F3=Exit	F7=Backward F8=Forward F9=Swap
F10=PrvPage	F11=NxtPage	F12=Cancel	

Arbitrary SQL Select Statements

The type of editor that is used when the result table is displayed. The result table is generated by a freeform SQL statement. The default is 1 (**Browse**).

You can select one of the following options:

Browse

FM/Db2 uses **Browse** to display the result table. No prefix area is displayed and you cannot change the data.

View

FM/Db2 uses **View** to display the result table. You can change the data by using editor commands, or by over-typing data. However, the changes cannot be saved to Db2@.

Edit

FM/Db2 uses **Edit** to display the result table. You can change the data by using editor commands, or by over-typing data. You can possibly save the changes to Db2®. If you choose to disable this option when you install the product, this option might not be available.

Display Format for DATE/TIME Columns

Time display format

The external format for data retrieved from Db2® TIME data type columns. The default for this option is '1' (**ISO**). You can select one of the following:

- **1. ISO** (HH.MM.SS). This is the default format.
- **2. JIS** (HH:MM:SS)
- **3. Db2 DSNHDECP setting** (uses the external format set in the Db2® DSNHDECP module).

Depending on the time format used, information can be lost when data is retrieved from Db2® (for example, the USA format, which discards the seconds portion of any time). If LOCAL is specified (a time format exit is in use), ensure that there is no loss of information when the time value is converted to an external format. When you use this option, you can encounter:

- SQLCODE 100 (row not found) conditions when attempting to delete or update tables that contain a TIME column.
- Removal of the seconds portion of any TIME column (the seconds value is set to 00) in print, copy, or export operations.

Date display format

The external format for data retrieved from Db2® DATE data type columns. The default for this option is '1' (**ISO**). You can select one of the following:

- **1. ISO** (yyyy-mm-dd). This is the default format.
- **2. EUR** (dd.mm.yyyy)
- **3. USA** (mm/dd/yyyy)
- **4. Db2 DSNHDECP setting** (uses the external format set in the Db2® DSNHDECP module).

This setting applies to data displayed in the editor.

Use uncommitted read when accessing the Db2® catalog

This option ensures that all Db2® catalog accesses for the view, edit, print, copy, export and import functions use the uncommitted read option (that is, no locks are taken against the Db2® catalog). The default is selected.

Retrieve foreign key information when building templates

FM/Db2 stores information about primary keys, indexes and foreign keys in the template for an object. This information is retrieved from the Db2® catalog and stored at template creation time, and can be displayed in a File Manager/Db2 editor session. Retrieval of the foreign key information can result in slow response if an additional index has not been built on the SYSIBM.SYSFOREIGNKEYS catalog table (see the *File Manager Customization Guide* for details). The default for this option is not selected. When this option is not selected, any templates generated do not contain any foreign key information.

Parent panels

- [Systems Options \(1 of 4\) panel on page 817](#)

Child panels

To display this panel...	Use/do this
Systems Options (1 of 4) panel on page 817	Press the PrvPage function key (F10)
Systems Options (3 of 4) panel on page 821	Press the NxtPage function key (F11)

Related tasks

- [Setting default processing options on page 60](#)
- [FM/Db2 system options \(option 0.2\) on page 63](#)
- [TIME columns on page 165](#)
- [INDEXINF primary command on page 911](#)
- ["No Primary Key" errors on page 198](#)
- ["Row Not Found" errors on page 200](#)

Related references

- [SQL primary command on page 942](#)

Systems Options (3 of 4) panel

You use the FM/Db2 Systems Options (3 of 4) panel to set various options that affect the way in which FM/Db2 operates. These options are saved in your ISPF profile and persist from one FM/Db2 session to the next.

Panel and field definitions

Figure 140. FM/Db2 System Options (3 of 4) panel

```

Process  Options  Utilities  Help
-----
FM/Db2 (DFG2)          FM/Db2 System Options (3 of 4)          Global Settings

CCSID Warning Message:
Enter "/" to select option
_ Initially ON

CURRENT DECFLOAT ROUNDING MODE:
Select value
E C. ROUND_CEILING
D. ROUND_DOWN
F. ROUND_FLOOR
G. ROUND_HALF_DOWN
E. ROUND_HALF_EVEN
H. ROUND_HALF_UP
U. ROUND_UP

Command ==>>
F1=Help      F2=Split    F3=Exit     F7=Backward F8=Forward  F9=Swap
F10=PrvPage  F11=NxtPage F12=Cancel
    
```

CCSID Warning Message

The setting for this option may have been fixed by the product installer. When this option is available for update, the default is not selected.

You can set your preferred initial system CCSID Warning message option by changing this option. To request a warning message to be displayed when the CCSID of the terminal differs from the CCSID of the plan, select the option. To suppress the displaying of a warning message when the CCSID of the terminal differs from the CCSID of the plan, do not select the option.

CURRENT DECFLOAT ROUNDING MODE

Sets the current decimal floating point rounding mode for the currently connected Db2® system. The default for this option is **E**.

For a detailed explanation of the various decimal floating point rounding modes you can specify, see the *Db2® SQL Reference*.

Setting the option causes FM/Db2 to issue an SQL statement that changes the CURRENT DECFLOAT ROUNDING MODE special register.

Parent panels

- [Systems Options \(2 of 4\) panel on page 819](#)

Child panels

To display this panel...	Use/do this
Systems Options (2 of 4) panel on page 819	Press the PrvPage function key (F10)

To display this panel...	Use/do this
Systems Options (4 of 4) panel on page 823	Press the NxtPage function key (F11)

Related tasks

- [Setting default processing options on page 60](#)
- [FM/Db2 system options \(option 0.2\) on page 63](#)

Systems Options (4 of 4) panel

You use the FM/Db2 Systems Options (4 of 4) panel to set various options that affect the way in which FM/Db2 operates. These options are saved in your ISPF profile and persist from one FM/Db2 session to the next.

Panel and field definitions

Figure 141. FM/Db2 System Options (4 of 4) panel

```

  Process  Options  Utilities  Help
  -----
FM/Db2 (DFE2)          FM/Db2 System Options (4 of 4)          Global Settings

Editor choice for viewing output data, members:
  Enter "/" to select option
  / Use File Manager editor

Cancel Confirmation:
  Enter "/" to select option
  / Immediately discard template changes

Command ==>
  F1=Help      F2=Split      F3=Exit      F7=Backward  F8=Forward  F9=Swap
  F10=PrvPage  F11=NxtPage   F12=Cancel

```

Use File Manager editor

This option controls which editor is invoked when viewing or browsing a member from a member selection panel or when viewing generated output. Select this option to invoke the File Manager editor. If the option is not selected, the ISPF Browse, View or Edit facility is invoked when available. The default for this option is selected.

Cancel confirmation

This option controls whether a warning panel is displayed when you change a template and issue a cancel command. The default is not selected.

When you select this option, unsaved changes to a template are discarded without a warning panel being displayed.

Child panels

To display this panel...	Use/do this
Systems Options (3 of 4) panel on page 821	Press the PrvPage function key (F10)

Related tasks

- [Setting default processing options on page 60](#)
- [FM/Db2 system options \(option 0.2\) on page 63](#)

Table Browse panel

Panel and field definitions

```

Process  Options  Utilities  Help
-----
FM/Db2 (DFG2)                Table Browse                3 rows fetched
TABLE FMUSER.EMP                Format TABL
EMPNO  FIRSTNME  MIDINIT  LASTNAME  WORKDEPT  PHONENO  HIREDATE  JOB
#1     #2           #3       #4        #5        #6       #7       #8  +
CH(6)  VARCHAR(12)  CH(1)    VARCHAR(15)  CH(3)    CH(4)    DATE     CH(8)
PU--> <-----1-> - <-----1-----> n-N    n-->    n----> n---->
**** Top of data ****
000010 CHRISTINE<  I      HAAS<      A00      3978      01/01/1965  PRES
000110 VINCENZO<  G      LUCCHESI<  A00      3490      05/16/1958  SALESR
200010 DIAN<      J      HEMMINGER< A00      3978      01/01/1965  SALESR
**** End of data ****

Command ==> _____ Scroll PAGE
F1=Help      F2=Zoom      F3=Exit      F4=CRetriev  F5=RFind     F6=RChange
F7=Up        F8=Down      F9=Swap      F10=Left     F11=Right    F12=Cancel
    
```

Figure 142. Sample data

Process	Options	Utilities	Help	
FM/Db2 (DFG2)		Table Browse		44 rows fetched
TABLE FMUSER.EMP				Format TABL
EMPNO	FIRSTNME	MIDINIT	LASTNAME	WORKDEPT
#1	#2	#3	#4	#5
CH(6)	VARCHAR(12)	CH(1)	VARCHAR(15)	CH(3)
PHONO				PHONENO
				HIREDATE
				JOB
PU-->	<-----1->	-	<-----1----->	<-NF
				<-->
				<----->
				<----->
**** Top of data ****				
000010	CHRISTINE<	I	HAAS<	A00
000020	MICHAEL<	L	THOMPSON<	B01
000030	SALLY<	A	KWAN<	C01
000050	JOHN<	B	GEYER<	E01
000060	IRVING<	F	STERN<	D11
000070	EVA<	D	PULASKI<	D21
000090	EILEEN<	W	HENDERSON<	E11
000100	THEODORE<	Q	SPENSER<	E21
000110	VINCENZO<	G	LUCCHESI<	A00
000120	SEAN<		O'CONNELL<	A00
000130	DOLORES<	M	QUINTANA<	C01
000140	HEATHER<	A	NICHOLLS<	C01
000150	BRUCE<		ADAMSON<	D11
000160	ELIZABETH<	R	PIANKA<	D11
000170	MASATOSHI<	J	YOSHIMURA<	D11
000180	MARILYN<	S	SCOUTTEN<	D11
000190	JAMES<	H	WALKER<	D11
000200	DAVID<		BROWN<	D11
000210	WILLIAM<	T	JONES<	D11
000220	JENNIFER<	K	LUTZ<	D11
000230	JAMES<	J	JEFFERSON<	D21
000240	SALVATORE<	M	MARINO<	D21
000250	DANIEL<	S	SMITH<	D21
000260	SYBIL<	V	JOHNSON<	D21
000270	MARIA<	L	PEREZ<	D21
000280	ETHEL<	R	SCHNEIDER<	E11
000290	JOHN<	R	PARKER<	E11
000300	PHILIP<	X	SMITH<	E11
000310	MAUDE<	F	SETRIGHT<	E11
000320	RAMLAL<	V	MEHTA<	E21
000330	WING<		LEE<	E21
000340	JASON<	R	GOUNOT<	E21
200010	DIAN<	J	HEMMINGER<	A00
200120	GREG<		ORLANDO<	A00
200140	KIM<	N	NATZ<	C01
200170	KIYOSHI<		YAMAMOTO<	D11
200220	REBA<	K	JOHN<	D11
200240	ROBERT<	M	MONTEVERDE<	D21
200280	EILEEN<	R	SCHWARTZ<	E11
200310	MICHELLE<	F	SPRINGER<	E11
200330	HELENA<		WONG<	E21
200340	ROY<	R	ALONZO<	E21
**** End of data ****				
Command ==>				
F1=Help	F2=Zoom	F3=Exit	F4=CRetriev	F5=RFind
F7=Up	F8=Down	F9=Swap	F10=Left	F11=Right
				F6=RChange
				F12=Cancel

Parent panels

- [Db2 Browse panel on page 595](#)
- [Column Selection/Edit panel on page 485](#)

Child panels

None.

Related tasks

Table Check Constraint Dependencies panel

FM/Db2 displays the Table Check Constraint Dependencies panel if you use the DEP line command against an item listed on the [Table Check Constraints panel on page 826](#).

Table Check Constraint Details panel

FM/Db2 displays the Table Check Constraint panel if you use the I line command against an item listed on the [Table Check Constraints panel on page 826](#).

Table Check Constraints panel

FM/Db2 displays the Table Check Constraints panel if you use the CK line command against an item listed on the [Tables, Views and Aliases panel on page 843](#).

Table Edit panel

Panel and field definitions

Process	Options	Utilities	Help				
FM/Db2 (DFG2)			Table Edit	42 rows fetched			
TABLE FMUSER.EMP				Format <u>TABL</u>			
EMPNO	FIRSTNME	MIDINIT	LASTNAME	WORKDEPT	PHONENO	HIREDATE	
#1	#2	#3	#4	#5	#6	#7	
CH(6)	VARCHAR(12)	CH(1)	VARCHAR(15)	CH(3)	CH(4)	DATE	
PU-->	<-----1->	-	<-----1----->	n-N	n-->	n----->	
000000	****	Top of data	****				
000001	000010	CHRISTINE<	I	HAAS<	A00	3978	01.01.1965
000002	000020	MICHAEL<	L	THOMPSON<	B01	3476	10.10.1973
000003	000030	SALLY<	A	KWAN<	C01	4738	05.04.1975
000004	000050	JOHN<	B	GEYER<	E01	6789	17.08.1949
000005	000060	IRVING<	F	STERN<	D11	6423	14.09.1973
000006	000070	EVA<	D	PULASKI<	D21	7831	30.09.1980
000007	000090	EILEEN<	W	HENDERSON<	E11	5498	15.08.1970
000008	000100	THEODORE<	Q	SPENSER<	E21	0972	19.06.1980
000009	000110	VINCENZO<	G	LUCCHESI<	A00	3490	16.05.1958
000010	000120	sean<		O'CONNELL<	A00	2167	05.12.1963
000011	000130	DOLORES<	M	QUINTANA<	C01	4578	28.07.1971
000012	000140	HEATHER<	A	NICHOLLS<	C01	1793	15.12.1976
000013	000150	BRUCE<	A	ADAMSON<	D11	4510	12.12.1972
Command ==>						Scroll <u>PAGE</u>	
F1=Help	F2=Zoom	F3=Exit	F4=CRetriev	F5=RFind	F6=RChange		
F7=Up	F8=Down	F9=Swap	F10=Left	F11=Right	F12=Cancel		

Prefix area

In TABL format mode, you can enter the following commands in the prefix area of the data display:

A

Identifies the row after which data is to be moved or copied.

B

Identifies the row before which data is to be moved or copied.

C

Copy one row.

Cn

Copy *n* rows.

CC

Copy block of rows. Mark start and end of block.

D

Delete one row.

Dn

Delete *n* rows.

DD

Delete block of rows. Mark start and end of block.

E

Display a panel containing information about why a change to this row failed. The E command is only valid when a row is marked in error. Rows marked in error have “=ERR”, “ERR R”, or the SQLCODE in the prefix field.

F

Display the first row of a block of excluded rows.

Fn

Display the first *n* rows of a block of excluded rows.

FS

Change the display format to SNGL and display the row.

G

Get the data stored on the clipboard. Rows saved on the clipboard with the S, Sn or SS prefix commands can only be retrieved from the clipboard with the G prefix command during the same Edit session. The clipboard is a temporary memory buffer that is cleared when you exit from the Db2® Edit function panel (and FM/Db2 returns you to the Primary Option Menu).

I

Insert one row. The row is initialized using the row description of the currently displayed row. For each column, if it has a default value (DEFAULT="value", and not just the DEFAULT keyword), then it is initialized to that value. Otherwise, the column is initialized according to its data type:

Character strings

Set to blanks

Numeric

Set to zeros

Row identifier

Set to blanks

DATE

Set to the current date

TIME

Set to the current time

TIMESTAMP

Set to the current date and time



Note: If a column of the inserted row can contain a null value, it is set to the null value and the null column display indicator is displayed in the displayed column.

For more information about setting the value of the null column display indicator, see [View and Edit options \(options 1 and 2\) on page 65](#).

Related tasks

- [View and Edit options \(options 1 and 2\) on page 65](#)

Related references

- [Db2 data types on page 432](#)

In

Insert *n* empty rows.

IP

Insert a primary key. In an Edit session of a related parent table only, insert a row with the key columns set to the key value that originally caused the error in the dependent table of the relationship.

IPn

Insert *n* primary keys. In an Edit session of a related parent table only, insert *n* rows with the key columns set to the key value that originally caused the error in the dependent table of the relationship. If you attempt to save the data, it results in duplicate key errors for the second and all subsequent inserted rows, as primary key values must be unique.

J

Join together two or more records - as shown in TABL display mode - into a single, longer record. The record where the prefix command is issued is the record that becomes longer. Any repetition count (for example, “*J4*”) is ignored. The J command can only be issued against a visible record. The join process continues downwards from the current location until:

- The new length for the record would exceed the maximum allowed.
- The last record in the editor session is encountered.

This prefix command is only available in a File Manager/Db2 LOB editor session.

L

Display the last row of a block of excluded rows.

Ln

Display the last *n* rows of a block of excluded rows.

LC

Convert all uppercase characters in a row to lowercase.



Note: The LC (*LCn*, *LCC*) command affects *all* characters in a row, not just characters in columns with a CHAR or VARCHAR data type. Therefore, numeric data, such as binary data or packed decimal data, can be corrupted when you use these commands.

LCn

Convert all uppercase characters in *n* rows to lowercase. (See note for **LC**.)

LCC

Convert all uppercase characters in a block of rows to lowercase. Mark start and end of block. (See note for **LC**.)

M

Move one row.

Mn

Move *n* rows.

MM

Move block of rows. Mark start and end of the block.

O

Overlay one row.

On

Overlay *n* rows.

OO

Overlay block of rows. Mark start and end of the block.

P

Identifies the row preceding which data is to be moved or copied .

R or "

Repeat one row.

Rn or "n

Repeat *n* rows.

RE

Edit a related table. You can use the RE prefix command to edit the related table when the row is marked with a error caused by a referential constraint.

You can only enter the RE prefix command against a row marked in error, where the rightmost position of the prefix area contains an "R". RE starts another FM/Db2 *dependent* edit session, in a new ISPF logical session. The new (dependent) FM/Db2 Edit session is for the related table in the relationship that caused the referential constraint error. For more details, see [Editing related tables on page 188](#).



Note: When you use the RE prefix command for a row whose prefix area contains "*=ERR* R", take care to avoid the editor interpreting the RE command as an R prefix command instead by ensuring the "*RE*" is followed by one or more blanks).

The RE command lets you quickly identify and resolve referential constraint errors. After you use the RE command to edit a related table, you cannot save data until you end the dependent Edit session of the related table.

This restriction also applies to tables that are part of a larger referential structure. For example, say A, B and C are related tables and A and B are part of a relationship in which A is the parent table, and B and C are part of a relationship in which B is the parent table. If you edit table A, then use the RE command to edit related table B, then use the RE command in the Edit session of table B to edit table C, it would result in 3 FM/Db2 Edit sessions. The Edit sessions for tables B and C are both dependent edit sessions of the Edit session for table A. You cannot save data in the Edit session for table A until you end the Edit sessions for tables B and C.

RR or ""

Repeat block of rows. Mark start and end of the block.

RRn or ""n

Repeat block of rows *n* times. Mark start and end of block.

S

Save row on clipboard. The clipboard is a temporary memory buffer that is cleared when you exit from the Db2® Edit function panel (and FM/Db2 returns you to the Primary Option Menu).

Sn

Save *n* rows on the clipboard.

SP

Split a single record into multiple pieces, the length of each piece depends on the terminal characteristics. Each piece appears in TABL display mode with the end of the record marker displayed - in other words all of the data for each piece is visible in TABL display mode without the need to scroll.

This prefix command is only available in a File Manager/Db2 LOB editor session.

SS

Save blocks of rows on the clipboard. Mark start and end of block.

UC

Convert all lowercase characters in a row to uppercase.



Note: The UC (UC*n*, UCC) command affects *all* characters in a row, not just characters in columns with a CHAR or VARCHAR data type. Therefore, numeric data, such as binary data or packed decimal data, can be corrupted when you use these commands.

UCn

Convert all lowercase characters in *n* rows to uppercase. (See note for **UC**.)

UCC

Convert all lowercase characters in a block of rows to uppercase. Mark start and end of block. (See note for **UC**.)

X

Exclude row from display. If the display of excluded row shadow lines is enabled (see [SHADOW primary command on page 937](#)), a shadow line is shown indicating how many rows are being excluded at this position. To display an excluded row, use the F or LA prefix command.

Xn

Exclude *n* rows from display. If the display of excluded row shadow lines is enabled (see [SHADOW primary command on page 937](#)), a shadow line is shown indicating how many rows are being excluded at this position.

XX

Exclude block of rows from display. Mark start and end of block. If the display of excluded row shadow lines is enabled (see [SHADOW primary command on page 937](#)), a shadow line is shown indicating how many rows are being excluded at this position.

.xxxx

Label a row. The label, xxxx, is a string of 1 to 4 alphabetic characters, that does not start with the character "Z" (labels starting with "Z" are system labels). Labels can be assigned to any row. Labels cannot be assigned to shadow lines.

Parent panels

- [Db2 Edit panel on page 598](#)
- [Column Selection/Edit panel on page 485](#)

Child panels

None.

Related tasks

Table Edit (related) panel

Panel and field definitions

```

Process  Options  Utilities  Help
-----
;
FM/Db2 (DFG2)                Table Edit (related)                Parent table
DPDNT FMNUSER.PROJACT        NAME FMNUSER.ACT        Format TABL
      ACTNO ACTKWD ACTDESC
      #1 #2 #3
      SMINT CH(6)  VARCHAR(20)
      PU--+K <--+> <-----1----->
000000 **** Top of data ****
000001 10 MANAGE MANAGE/ADVISE<
000002 20 ECOST ESTIMATE COST<
000003 30 DEFINE DEFINE SPECS<
000004 40 LEADPR LEAD PROGRAM/DESIGN<
000005 50 SPECS WRITE SPECS<
000006 60 LOGIC DESCRIBE LOGIC<
000007 70 CODE CODE PROGRAMS<
000008 80 TEST TEST PROGRAMS<
000009 90 ADMQS ADM QUERY SYSTEM<
000010 100 TEACH TEACH CLASSES<
000011 110 COURSE DEVELOP COURSES<
000012 120 STAFF PERS AND STAFFING<
000013 130 OPERAT OPER COMPUTER SYS<
000014 140 MAINT MAINT SOFTWARE SYS<
000015 150 ADMSYS ADM OPERATING SYS<
000016 160 ADMDB ADM DATA BASES<
000017 170 ADMDC ADM DATA COMM<
000018 180 DOC DOCUMENT<
000019 **** End of data ****

```

Parent panels

This panel appears when you use the REDIT primary command from within an error information panel (providing the error information panel offers REDIT as an option) when a referential integrity error has occurred.

Child panels

None.

Related tasks

Table Selection panel

You use the Table Selection panel to select a table from a list of tables produced when you have used an asterisk (*) or a pattern when specifying a Db2® object name.

Panel and field definitions

<pre> Process Opti FM/Db2 (DB26) Specify the Db2 Location . Owner . . . Name . . . Template: Data set nam Member . . Processing Opti Template usa 3 1. Above 2. Previo 3. Genera 4. Genera Command ==> F1=Help F F9=Swap F1 </pre>	<pre> ----- Table Selection ----- Row 1 to 9 of 9 Select one of the tables from the list. S Owner Name Database Space Type - FMDB2 AUX_EMP_RESUME FMDB2DL FMDB2SN AUX TABLE - FMDB2 EEMP FMDB2DA FMDB2SR TABLE - FMDB2 EMP FMDB2DA FMDB2SE TABLE - FMDB2 EMP_PHOTO_RESUME FMDB2DL FMDB2SB TABLE - FMDB2 EMPPROJACT FMDB2DA FMDB2SP TABLE - FMDB2 VEMP FMDB2DA FMDB2SE VIEW - FMDB2 VEMPDPT1 FMDB2DA FMDB2SE VIEW - FMDB2 VEMPLP FMDB2DA FMDB2SE VIEW - FMDB2 VEMPPROJACT FMDB2DA FMDB2SP VIEW ***** Bottom of data ***** Command ==> F1=Help F2=Split F3=Exit F7=Backward F8=Forward F9=Swap F12=Cancel </pre>
---	---

S

Selection column. To select a table, type **s**.

Owner

The name of the owner of the table.

Name

The name of the table.

Database

The name of the database containing the table.

Table Space

The name of the table space containing the table.

Type

The Db2® object type.

Parent panels

This panel appears when you enter an asterisk (*) or pattern in one or more of the following fields when specifying a Db2® object name: **Owner, Name, Database, Table space**.

Child panels

None.

Related tasks

- [Specifying a Db2 object name on page 45](#)

Table Space Parts panel

FM/Db2 displays the Table Space Parts panel if you use the PT line command against an item listed on the [Table Spaces panel on page 834](#).

Table Spaces panel

You use the Table Spaces panel to list table space object types in the Db2® catalog.

Panel and field definitions

The columns that are displayed include the SEL field and columns of SYSIBM.SYSTABLESPACE.

Process		Options		Utilities		Help	
FM/Db2 (DFG2)				Table Spaces			
Location:				Format <u>TABL</u>			
SEL	NAME	CREATOR	DBNAME	DBID	OBID	PSID	BPOOL
*	*	*	*	*	*	*	*
----	#1--+-	#2--+-	#3--+-	----	----	----	#7--+-
----	----	----	----	----	----	----	----
****	Top of data						****
----	DEPTRV8R	YEH	DSNDB04	4	41	42	BP0
----	DSN32K01	CJUNELL	DSNDB07	7	3	4	BP32K
----	DSN4K01	CJUNELL	DSNDB07	7	1	2	BP0
----	DSN8S81C	CJUNELL	DSN8D81P	260	1	2	BP0
----	DSN8S81D	CJUNELL	DSN8D81A	259	1	2	BP0
----	DSN8S81E	CJUNELL	DSN8D81A	259	3	4	BP0
----	DSN8S81P	CJUNELL	DSN8D81A	259	7	8	BP0
----	DSN8S81Q	CJUNELL	DSN8D81P	260	3	4	BP0
----	DSN8S81R	CJUNELL	DSN8D81A	259	5	6	BP0
----	DSN8S81S	CJUNELL	DSN8D81A	259	9	10	BP0
----	DSNASDMA	CJUNELL	DSNATPDB	257	5	6	BP0
Command ==>				Scroll <u>PAGE</u>			
F1=Help	F2=Zoom	F3=Exit	F4=CRetriev	F5=RFind	F6=RChange		
F7=Up	F8=Down	F9=Swap	F10=Left	F11=Right	F12=Cancel		

**Note:**

1. The system option, **Show all catalog table columns**, affects which columns FM/Db2 displays when you use the Object List utility.
2. You can also customize which columns FM/Db2 displays when you use the Object List utility. For details, see the *File Manager Customization Guide*.

To view other columns on this panel, press the Right function key (F11).

For a complete list of columns, refer to “*Db2® catalog tables*” in the *DB2 for z/OS SQL Reference* relevant to your version of Db2®.

SEL

Line command area.

For a list of the line commands you can use on this panel, see [Table 22: Object list line commands on page 308](#).

Parent panels

- [Object List Utility panel on page 719](#)
- [Databases panel on page 593](#)
- [Tables, Views and Aliases panel on page 843](#)
- [Application Packages panel on page 460](#)

Child panels

To display this panel...	Use/do this
Alter Table Space panel on page 460	Line command A
Create Table Space panel on page 549	Line command CR
Create Table panel on page 546	Line command CRT
Databases panel on page 593	Line command D
See Drop panels on page 621	Line command DR
Database Structure panel on page 592	Line command DS
Grant privileges panels on page 689	Line command G
Generate SQL From Db2 Catalog panel on page 686	Line command GEN
Details panels on page 618	Line command I
Recovery Information panel on page 755	Line command ICS
Privileges panels on page 736	Line command P
Table Space Parts panel on page 834	Line command PT
Revoke privileges panels on page 766	Line command R
Display Row panel on page 619	Line command ROW
Tables, Views and Aliases panel on page 843	Line command T
Db2 Utilities panel on page 610	Line command UTL
Sort Fields panel on page 804	Primary command SORT

Related tasks

- [Working with object list panels on page 301](#)
- [Using the line command area \(Cmd\) on page 308](#)

Related references

- [SORT primary command on page 941](#)

Table View panel

Panel and field definitions

Process	Options	Utilities	Help	
FM/Db2 (DFG2)			Table View	
TABLE FMUSER.EMP				42 rows fetched
EMPNO	FIRSTNME	MIDINIT	LASTNAME	WORKDEPT
#1	#2	#3	#4	#5
CH(6)	VARCHAR(12)	CH(1)	VARCHAR(15)	CH(3)
PU-->	<-----1->	-	<-----1----->	n-N
				n-->
				n----->
000000	****	Top of data	****	
000001	000010	CHRISTINE<	I	HAAS<
000002	000020	MICHAEL<	L	THOMPSON<
000003	000030	SALLY<	A	KWAN<
000004	000050	JOHN<	B	GEYER<
000005	000060	IRVING<	F	STERN<
000006	000070	EVA<	D	PULASKI<
000007	000090	EILEEN<	W	HENDERSON<
000008	000100	THEODORE<	Q	SPENSER<
000009	000110	VINCENZO<	G	LUCCHESI<
000010	000120	sean<		O'CONNELL<
000011	000130	DOLORES<	M	QUINTANA<
000012	000140	HEATHER<	A	NICHOLLS<
000013	000150	BRUCE<	A	ADAMSON<
Command	===>			Scroll
F1=Help	F2=Zoom	F3=Exit	F4=CRetriev	F5=RFind
F7=Up	F8=Down	F9=Swap	F10=Left	F11=Right
				F6=RChange
				F12=Cancel

Prefix area

In TABL format mode, you can enter the following commands in the prefix area of the data display:

- A**
Identifies the row after which data is to be moved or copied.
- B**
Identifies the row before which data is to be moved or copied.
- C**
Copy one row.
- Cn**
Copy *n* rows.
- CC**
Copy block of rows. Mark start and end of block.
- D**
Delete one row.
- Dn**
Delete *n* rows.
- DD**
Delete block of rows. Mark start and end of block.

E

Display a panel containing information about why a change to this row failed. The E command is only valid when a row is marked in error. Rows marked in error have “=ERR”, “ERR R”, or the SQLCODE in the prefix field.

F

Display the first row of a block of excluded rows.

Fn

Display the first *n* rows of a block of excluded rows.

FS

Change the display format to SNGL and display the row.

G

Get the data stored on the clipboard. Rows saved on the clipboard with the S, Sn or SS prefix commands can only be retrieved from the clipboard with the G prefix command during the same Edit session. The clipboard is a temporary memory buffer that is cleared when you exit from the Db2® Edit function panel (and FM/Db2 returns you to the Primary Option Menu).

I

Insert one row. The row is initialized using the row description of the currently displayed row. For each column, if it has a default value (DEFAULT="value", and not just the DEFAULT keyword), then it is initialized to that value. Otherwise, the column is initialized according to its data type:

Character strings

Set to blanks

Numeric

Set to zeros

Row identifier

Set to blanks

DATE

Set to the current date

TIME

Set to the current time

TIMESTAMP

Set to the current date and time



Note: If a column of the inserted row can contain a null value, it is set to the null value and the null column display indicator is displayed in the displayed column.



For more information about setting the value of the null column display indicator, see [View and Edit options \(options 1 and 2\) on page 65](#).

Related tasks

- [View and Edit options \(options 1 and 2\) on page 65](#)

Related references

- [Db2 data types on page 432](#)

In

Insert n empty rows.

IP

Insert a primary key. In an Edit session of a related parent table only, insert a row with the key columns set to the key value that originally caused the error in the dependent table of the relationship.

IPn

Insert n primary keys. In an Edit session of a related parent table only, insert n rows with the key columns set to the key value that originally caused the error in the dependent table of the relationship. If you attempt to save the data, it results in duplicate key errors for the second and all subsequent inserted rows, as primary key values must be unique.

L

Display the last row of a block of excluded rows.

Ln

Display the last n rows of a block of excluded rows.

LC

Convert all uppercase characters in a row to lowercase.



Note: The LC (LCn, LCC) command affects *all* characters in a row, not just characters in columns with a CHAR or VARCHAR data type. Therefore, numeric data, such as binary data or packed decimal data, can be corrupted when you use these commands.

LCn

Convert all uppercase characters in n rows to lowercase. (See note for **LC**.)

LCC

Convert all uppercase characters in a block of rows to lowercase. Mark start and end of block. (See note for **LC**.)

M

Move one row.

Mn

Move *n* rows.

MM

Move block of rows. Mark start and end of the block.

P

Identifies the row preceding which data is to be moved or copied .

R or "

Repeat one row.

Rn or "n

Repeat *n* rows.

RE

Edit a related table. You can use the RE prefix command to edit the related table when the row is marked with a error caused by a referential constraint.

You can only enter the RE prefix command against a row marked in error, where the rightmost position of the prefix area contains an "R". RE starts another FM/Db2 *dependent* edit session, in a new ISPF logical session. The new (dependent) FM/Db2 Edit session is for the related table in the relationship that caused the referential constraint error. For more details, see [Editing related tables on page 188](#).



Note: When you use the RE prefix command for a row whose prefix area contains "*=ERR R*", take care to avoid the editor interpreting the RE command as an R prefix command instead by ensuring the "*RE*" is followed by one or more blanks).

The RE command lets you quickly identify and resolve referential constraint errors. After you use the RE command to edit a related table, you cannot save data until you end the dependent Edit session of the related table.

This restriction also applies to tables that are part of a larger referential structure. For example, say A, B and C are related tables and A and B are part of a relationship in which A is the parent table, and B and C are part of a relationship in which B is the parent table. If you edit table A, then use the RE command to edit related table B, then use the RE command in the Edit session of table B to edit table C, it would result in 3 FM/Db2 Edit sessions. The Edit sessions for tables B and C are both dependent edit sessions of the Edit session for table A. You cannot save data in the Edit session for table A until you end the Edit sessions for tables B and C.

RR or ""

Repeat block of rows. Mark start and end of the block.

RRn or ""n

Repeat block of rows *n* times. Mark start and end of block.

S

Save row on clipboard. The clipboard is a temporary memory buffer that is cleared when you exit from the Db2® Edit function panel (and FM/Db2 returns you to the Primary Option Menu).

Sn

Save *n* rows on the clipboard.

SS

Save blocks of rows on the clipboard. Mark start and end of block.

UC

Convert all lowercase characters in a row to uppercase.



Note: The UC (UC*n*, UCC) command affects *all* characters in a row, not just characters in columns with a CHAR or VARCHAR data type. Therefore, numeric data, such as binary data or packed decimal data, can be corrupted when you use these commands.

UCn

Convert all lowercase characters in *n* rows to uppercase. (See note for **UC**.)

UCC

Convert all lowercase characters in a block of rows to uppercase. Mark start and end of block. (See note for **UC**.)

X

Exclude row from display. If the display of excluded row shadow lines is enabled (see [SHADOW primary command on page 937](#)), a shadow line is shown indicating how many rows are being excluded at this position. To display an excluded row, use the F or LA prefix command.

Xn

Exclude *n* rows from display. If the display of excluded row shadow lines is enabled (see [SHADOW primary command on page 937](#)), a shadow line is shown indicating how many rows are being excluded at this position.

XX

Exclude block of rows from display. Mark start and end of block. If the display of excluded row shadow lines is enabled (see [SHADOW primary command on page 937](#)), a shadow line is shown indicating how many rows are being excluded at this position.

.xxxx

Label a row. The label, xxxx, is a string of 1 to 4 alphabetic characters, that does not start with the character "Z" (labels starting with "Z" are system labels). Labels can be assigned to any row. Labels cannot be assigned to shadow lines.

Parent panels

- [Db2 View panel on page 613](#)
- [Column Selection/Edit panel on page 485](#)

Child panels

None.

Related tasks

Table/View/Alias Selection panel

You use the Table/View/Alias Selection panel to select a table, view, or alias from a list produced when you have used an asterisk (*) or a pattern when specifying a Db2® object name.

Panel and field definitions

Table/View/Alias Selection Row 1 to 13 of 39

Select one of the tables/views/aliases from the list.

S	Owner	+ Table/View/Alias Name	+ Database	Space	Type
—	FMNUSER	ACT	JOHND81A	JOHNS81P	TABLE
—	FMNUSER	DEPT	JOHND81A	JOHNS81D	TABLE
—	FMNUSER	EACT	JOHND81A	JOHNS81R	TABLE
—	FMNUSER	EDEPT	JOHND81A	JOHNS81R	TABLE
—	FMNUSER	EEMP	JOHND81A	JOHNS81R	TABLE
—	FMNUSER	EEPA	JOHND81A	JOHNS81R	TABLE
—	FMNUSER	EMP	JOHND81A	JOHNS81E	TABLE
—	FMNUSER	EMPPROJACT	JOHND81A	JOHNS81P	TABLE
—	FMNUSER	EPROJ	JOHND81A	JOHNS81R	TABLE
—	FMNUSER	EPROJACT	JOHND81A	JOHNS81R	TABLE
—	FMNUSER	MAP_TBL	JOHND81P	JOHNS81Q	TABLE
—	FMNUSER	PARTS	JOHND81A	JOHNS81S	TABLE
—	FMNUSER	PROJ	JOHND81A	JOHNS81P	TABLE

Command ==>

F1=Help	F2=Split	F3=Exit	F4=Expand	F7=Backward
F8=Forward	F9=Swap	F10=Left	F11=Right	F12=Cancel

S

Selection column. To select a table, type s.

Owner

The name of the owner of the table.

Table/View/Alias Name

The name of the table, view, or alias.

Database

The name of the database containing the table.

Table Space

The name of the table space containing the table.

Type

The Db2® object type.

Parent panels

This panel appears when you enter an asterisk (*) or pattern in one or more of the following fields when specifying a Db2® object name: **Owner, Name, Database, Table space**.

Child panels

None.

Related tasks

- [Specifying a Db2 object name on page 45](#)

Tables, Views and Aliases panel

You use the Tables, Views and Aliases panel to list table, view, and alias object types in the Db2® catalog.

Panel and field definitions

The columns that are displayed include the SEL field and columns of SYSIBM.SYSTABLES.

Process	Options	Utilities	Help		
FM/Db2 (DFG2)		Tables, Views and Aliases			44 of 1000
Location:					Format <u>TABL</u>
SEL	TABLE OWNER	TABLE NAME	DATABASE NAME	OBJECT TYPE	
	*	*	*	*	+
----	#2---+-----1-----+	#1---+-----1-----+-----2-----+	#4---+-----	#61---+-----1-----	
----	DMYAPP	TABLES	DSNDB06	View	
----	DMYAPP	TABLESPACE	DSNDB06	View	
----	DMYAPP	VIEWS	DSNDB06	View	
----	DSB81010	EMP_COPY	DSN00245	Table	
----	DSN81010	ACT	DSN8D10A	Table	
----	DSN81010	CATALOG	DSN8D10X	Table	
----	DSN81010	CUSTOMER	DSN8D10X	Table	
----	DSN81010	DEPT	DSN8D10A	Table	
----	DSN81010	EACT	DSN8D10A	Table	
----	DSN81010	EDEPT	DSN8D10A	Table	
----	DSN81010	EEMP	DSN8D10A	Table	
Command	===>			Scroll	PAGE
F1=Help	F2=Zoom	F3=Exit	F4=CRetriev	F5=RFind	F6=RChange
F7=Up	F8=Down	F9=Swap	F10=Left	F11=Right	F12=Cancel



Note:

1. The system option, **Show all catalog table columns**, affects which columns FM/Db2 displays when you use the Object List utility.
2. You can also customize which columns FM/Db2 displays when you use the Object List utility. For details, see the *File Manager Customization Guide*.

To view other columns on this panel, press the Right function key (F11).

For a complete list of columns, refer to “Db2® catalog tables” in the *DB2 for z/OS SQL Reference* relevant to your version of Db2®.

SEL

Line command area.

For a list of the line commands you can use on this panel, see [Table 22: Object list line commands on page 308](#).

Parent panels

This panel appears when you specify the T line command against an object displayed in a list of Db2® objects.

Child panels

To display this panel...	Use/do this
Alter Table panel on page 448	Line command A
Alter Table - ADD CHECK Constraint panel on page 449	Line command ADD

To display this panel...	Use/do this
Tables, Views and Aliases panel on page 843	Line command ALS
Tables, Views and Aliases panel on page 843	Line command AT
Db2 Browse panel on page 595	Line command B
Tables, Views and Aliases panel on page 843	Line command BT
Copy Utility ("From") panel on page 498	Line command C
Column Distribution panel on page 485	Line command CDI
Tables, Views and Aliases panel on page 843	Line command CH
Children of Table panel on page 471	Line command CHR
Table Check Constraints panel on page 826	Line command CK
Columns in Table panel on page 493	Line command COL
See Comment panels on page 493	Line command COM
Create Table panel on page 546	Line command CR
Create Alias panel on page 512	Line command CRA
Create Index panel on page 527	Line command CRX
Columns in Table panel on page 493	Line command CS
Databases panel on page 593	Line command D
See Drop panels on page 621	Line command DR
Db2 Edit panel on page 598	Line command E
Foreign Keys for Table panel on page 683	Line command FK
Grant privileges panels on page 689	Line command G
Generate SQL From Db2 Catalog panel on page 686	Line command GEN
Details panels on page 618	Line command I
Label Table panel on page 701	Line command LAB
Privileges panels on page 736	Line command P
Tables, Views and Aliases panel on page 843	Line command PA
Parents of Table panel on page 724	Line command PAR
Primary Key for Table panel on page 728	Line command PK
Application Packages panel on page 460	Line command PKG

To display this panel...	Use/do this
Application Plans panel on page 463	Line command PL
Print Utility panel on page 733	Line command PR
Revoke privileges panels on page 766	Line command R
Display Row panel on page 619	Line command ROW
Table Spaces panel on page 834	Line command S
Basic SELECT Prototyping panel on page 465	Line command SEL
Synonyms panel on page 815	Line command SYN
Tables, Views and Aliases panel on page 843	Line command T
Db2 Utilities panel on page 610	Line command UTL
Db2 View panel on page 613	Line command V
Create View Source Statements panel on page 587	Line command VS
Indexes panel on page 697	Line command X
Indexes and Columns for panel on page 699	Line command XC
Sort Fields panel on page 804	Primary command SORT

Related tasks

- [Working with object list panels on page 301](#)
- [Using the line command area \(Cmd\) on page 308](#)

Related references

- [SORT primary command on page 941](#)

TEMPLATE Options (1 of 2) panel

You use the TEMPLATE Options (1 of 2) panel to enter information used by FM/Db2 to generate TEMPLATE statements and the proper JCL statement to access the TEMPLATE library in a utility batch job.

Panel and field definitions

Process	Options	Utilities	Help
FM/Db2 (DFG2)	TEMPLATE Options (1 of 2)		Global Settings
Enter RESET to restore installation defaults.			More: +
TEMPLATE Library Option:			
JCL DD statement: No DD stmt is generated if field is blank			
//	SYSTEMPL DD	_____	
//	DD	_____	
//	DD	_____	
//	DD	_____	
Initial Utility Statement Option:			
Utility statement: No statement is generated if field is blank			
	TEMPLATE	_____	

Additional statements:			
Enter "/" to select options			
- Use additional statements			
- Edit additional statements			
Command ==>			
F1=Help	F2=Split	F3=Exit	F4=CRetriev
F8=Forward	F9=Swap	F11=NxtPage	F12=Cancel
		F6=Reset	F7=Backward

JCL DD statement

The information used to generate the JCL DD statement. This information is:

DD name

A read-only field. This holds the value that was specified in the **TEMPLATEDD DD name** field on the **OPTIONS Options panel** ([OPTIONS Options panel on page 721](#)). If the library field is blank then no DD statement is generated in the utility batch job.

Text values

The values entered on these four lines are used directly to generate the DD statement, provided that the **DD name** field is not blank. The default is blank.

Utility statement

The field of the Utility statement is used to generate the initial utility statements. If the field is blank, and the **Use additional statements** option is not selected, then no TEMPLATE statement is generated into the utility batch job. If the input field is non-blank, then the specified TEMPLATE is generated with any additional TEMPLATE statements supplied when the **Use additional statements** option is selected. The default is blank.

Use additional statements

If this option is set then more than one TEMPLATE statement may be generated into the utility batch job. Select the Edit additional statements option to edit additional statements. Only TEMPLATE specifications that have non-blank input fields are used in the generation. The default is not selected.

If this option is not selected, then only a non-blank value in the **Utility statement** field is used to generate the TEMPLATE statement.

Edit additional statements

When you select this option and press Enter, the Additional TEMPLATE Statements panel ([Additional TEMPLATE Statements panel on page 441](#)) is displayed. After you have entered values on this panel and exited the panel, this option is deselected. The additional statements are used when you select the Use additional statements option. The default is not selected.

The TEMPLATE Library Option panel has an installation-defined default. You can restore the default for the library option by entering the RESET command or pressing the RESET PF key. Each subsystem has its own installation-defined defaults. RESET also clears the **Use additional statements** option and any values in the **Utility statement** fields.

For more information, see TEMPLATE and OPTIONS statements in *DB2 Utility Guide and Reference*.

Child panels

To display this panel...	Use/do this
Additional LISTDEF Statements panel on page 440	Select the Edit additional statements option.
TEMPLATE Options (2 of 2) panel on page 848	Press F11

Related tasks

- [RESET primary command on page 932](#)
- [Setting options for Db2 utilities on page 341](#)
- [Db2 Utility TEMPLATE options \(option 3.UT\) on page 68](#)

TEMPLATE Options (2 of 2) panel

You use the TEMPLATE Options (2 of 2) panel to enter more information used by FM/Db2 to generate TEMPLATE statements and the proper JCL statement to access the TEMPLATE library in a utility batch job.

Panel and field definitions

Process	Options	Utilities	Help
FM/Db2 (DFG2)	TEMPLATE Options (2 of 2)		Global Settings
Enter RESET to restore installation defaults.			
Utility DD-Keyword Option:			
COPY Statement:			
	COPYDDN template name .	_____	
LOAD Statement:			
	INDDN template name .	_____	
REBUILD INDEX Statement:			
	WORKDDN template name .	_____	
REORG TABLESPACE Statement:			
	UNLDDN template name .	_____	
UNLOAD Statement:			
	PUNCHDDN template name	_____	
	UNLDDN template name .	_____	
Command ==>			
F1=Help	F2=Split	F3=Exit	F6=Reset
F9=Swap	F10=PrvPage	F12=Cancel	F7=Backward F8=Forward

COPYDDN template name

A new FM/Db2 default setting for a COPYDDN clause. The original default is the DD-name SYSCOPY. The default value for this field is blank.

INDDN template name

A new FM/Db2 default setting for a INDDN clause. The original default is the DD-name SYSREC00. The default value for this field is blank.

WORKDDN template name

A new FM/Db2 default setting for a WORKDDN clause. The original default is SYSUT1. The default value for this field is blank.

UNLDDN template name

A new FM/Db2 default setting for a UNLDDN clause. The default value for this field is blank.

The UNLDDN clause is only generated if the Unload External option of the REORG Utility (Table Spaces) panel ([REORG Utility \(Table Spaces\) panel on page 763](#)) is set to "Y".

The original default is either the DD-name SYSREC00 or SYSREC. It depends on a number of factors including what options are chosen.

PUNCHDDN template name

A new FM/Db2 default setting for the PUNCHDDN clause. The original default is the DD-name SYSPUNCH. The default value for this field is blank.

UNLDDN template name

A new FM/Db2 default setting for the UNLDDN clause. The original default is the DD-name SYREC00. The default value for this field is blank.

Parent panels

- [TEMPLATE Options \(1 of 2\) panel on page 846](#)

Child panels

None.

Related tasks

- [RESET primary command on page 932](#)
- [Setting options for Db2 utilities on page 341](#)
- [COPY utility on page 346](#)
- [LOAD utility on page 349](#)
- [Loading data described by a copybook or template on page 353](#)
- [REBUILD utility \(indexes\) on page 358](#)
- [REORG \(table spaces\) on page 364](#)
- [UNLOAD utility on page 372](#)
- [UNLOAD \(tables\) on page 373](#)
- [UNLOAD \(table spaces\) on page 378](#)
- [Db2 Utility TEMPLATE options \(option 3.UT\) on page 68](#)

Template Mapping panel

You use the Template Mapping panel to specify the columns in the source (the *"From"* columns) you want transferred to the columns in the target (the *"To"* columns) when you are moving (copying) data.

Panel and field definitions

Process	Options	Utilities	Help					
FM/Db2 (DFG2)				Template Mapping			Line 1 of 16	
To	FMUSER.EEMP							
From	FMUSER.EEMP							
Cmd	CL#	To Column name	Datatype	NI	CL#	From Column name	Datatype	NI
		**** Top of data ****						
---	1	EMPNO	CH(6)	NN	1	EMPNO	CH(6)	NN
---	2	FIRSTNME	VC(12)	NN	2	FIRSTNME	VC(12)	NN
---	3	MIDINIT	CH(1)	NN	3	MIDINIT	CH(1)	NN
---	4	LASTNAME	VC(15)	NN	4	LASTNAME	VC(15)	NN
---	5	WORKDEPT	CH(3)		5	WORKDEPT	CH(3)	
---	6	PHONENO	CH(4)		6	PHONENO	CH(4)	
---	7	HIREDATE	DATE		7	HIREDATE	DATE	
---	8	JOB	CH(8)		8	JOB	CH(8)	
---	9	EDLEVEL	SMINT		9	EDLEVEL	SMINT	
---	10	SEX	CH(1)		10	SEX	CH(1)	
---	11	BIRTHDATE	DATE		11	BIRTHDATE	DATE	
---	12	SALARY	DEC(9,2)		12	SALARY	DEC(9,2)	
---	13	BONUS	DEC(9,2)		13	BONUS	DEC(9,2)	
---	14	COMM	DEC(9,2)		14	COMM	DEC(9,2)	
S	15	RID	CH(4)					
---	16	TSTAMP	TIMESTAMP					
		**** End of data ****						
Command	==>						Scroll	PAGE
F1=Help	F2=Split	F3=Exit	F4=CRetriev	F5=RFind	F6=RunTemp			
F7=Up	F8=Down	F9=Swap	F12=Cancel					

TO

The "To" Db2® object. The Db2® object to which data will be imported.

FROM

The "From" data set. The name of the import data set.

Cmd

Prefix command area, used to enter a template editor prefix command. S or E to edit the column mapping.

CL# (TO)

The "To" column number. The number of the column in the "To" template.

Column name (TO)

The "To" column name. The name of the column in the "To" template.

Datatype (TO)

The "To" data type. The data type and, optionally, the length of the column in the "To" template.

NI (TO)

The "To" Null Indicator. The null indicator for the column in the "To" template:

(blank)

The column allows null values

NN

The column does not allow null values.

Cl# (FROM)

The "From" column number. The number of the column in the "From" template.

Column name (FROM)

The "From" column name. The name of the column in the "From" template.

Datatype (FROM)

The "From" data type. The data type and, optionally, the length of the column in the "From" template.

NI (FROM)

The "From" Null Indicator. The null indicator for the column in the "From" template:

(blank)

The column allows null values

NN

The column does not allow null values.

Parent panels

- [Copy Utility \("To"\) panel on page 506](#)
- [Import Utility \("To"\) panel on page 694](#)
- [Export Utility \("To"\) panel on page 676](#)
- [LOAD from panel on page 704](#)

Child panels

To display this panel...	Use/do this
From Column Mapping panel on page 684	Enter "S" in Cmd field

Related tasks

- [Specifying your own mapping on page 110](#)
- [Copying data from one Db2 object to another on page 241](#)
- [Copying data from a VSAM or QSAM file on page 246](#)
- [Copying data to a VSAM or QSAM file on page 274](#)
- [LOAD utility on page 349](#)

Template Save panel

FM/Db2 displays the Template Save panel if you press F3 when the [Column Selection/Edit panel on page 485](#) is displayed.

Triggers panel

You use the Triggers panel to display information about the triggers you have selected.

Panel and field definitions

The columns that are displayed include the SEL field and columns of SYSIBM.SYSTRIGGERS.

Process	Options	Utilities	Help					
FM/Db2 (DFG2)		Triggers						Format <u>TABL</u>
Location:								
SEL	NAME	SCHEMA	SEQNO	DBID	OBID	OWNER	CREATEDBY	TBNAME
----	#1-----1--	#2-----	----#3	----#4	----#5	#6-----	#7-----	#8-----
****	Top of data	****						
	NEW_EMPLOYEE	SHRIKES	1	261	7	SHRIKES	SHRIKES	EMPLOYEE_
	SDAFSDFSAD	SHRIKE2	1	259	64	SHRIKE2	SHRIKE2	DEPT
	TRIGGER1	SHRIKE2	1	259	63	SHRIKE2	SHRIKE2	EMP
****	End of data	****						
Command ==>		Scroll <u>PAGE</u>						
F1=Help	F2=Zoom	F3=Exit	F4=CRetriev	F5=RFind	F6=RChange			
F7=Up	F8=Down	F9=Swap	F10=Left	F11=Right	F12=Cancel			



Note:

1. The system option, **Show all catalog table columns**, affects which columns FM/Db2 displays when you use the Object List utility.
2. You can also customize which columns FM/Db2 displays when you use the Object List utility. For details, see the *File Manager Customization Guide*.

To view other columns on this panel, press the Right function key (F11).

For a complete list of columns, refer to “*Db2® catalog tables*” in the *DB2 for z/OS SQL Reference* relevant to your version of Db2®.

SEL

Line command area.

For a list of the line commands you can use on this panel, see [Table 22: Object list line commands on page 308](#).

Parent panels

- [Object List Utility panel on page 719](#)
- [Schemas panel on page 779](#)

Child panels

To display this panel...	Use/do this
See Comment panels on page 493	Line command COM
Create Trigger panel on page 580	Line command CR
See Drop panels on page 621	Line command DR
Details panels on page 618	Line command I
Application Packages panel on page 460	Line command PKG
Privileges panels on page 736	Line command PS
Display Row panel on page 619	Line command ROW
Schemas panel on page 779	Line command SCH
(ISPF panel)	Line command SQL
Tables, Views and Aliases panel on page 843	Line command T
Sort Fields panel on page 804	Primary command SORT

Related tasks

- [Working with object list panels on page 301](#)
- [Using the line command area \(Cmd\) on page 308](#)

Related references

- [SORT primary command on page 941](#)

UNLOAD Options panel

You use the UNLOAD Options panel to enter information that is used in generating an UNLOAD statement in a utility batch job.

Panel and field definitions

Process	Options	Utilities	Help
FM/Db2 (DFG2)		UNLOAD Options	Global Settings
Utility Options:			
Enter "/" to select option			
/	Allow data changes	--YES-->	Isolation Level
/	Use IEEE floating point	2	1. Cursor stability
/	Allow substitution chars		2. Uncommitted rows
/	Allow padding		
Number of Records Value:			
	Maximum in Error 2		(0 or negative means no limit)
Character Representation Options:			
	Encoding Scheme		CCSID Values
2	1. Preserve encoding scheme		SBCS data . . . 0
	2. EBCDIC		Mixed DBCS data 0
	3. ASCII		DBCS data . . . 0
	4. UNICODE		
Command ==>			
F1=Help	F2=Split	F3=Exit	F4=CRetriev F7=Backward F8=Forward
F9=Swap	F10=Actions	F12=Cancel	

Allow data changes

When this option is selected, you must supply a value for the Isolation Level. The default is selected.

If not selected, FM/Db2 adds the SHRLEVEL REFERENCE clause to the UNLOAD utility control statements, meaning that during the unload operation, rows of the tables can be read, but can not be inserted, updated, nor deleted by other Db2® threads.

Isolation Level

This parameter comes into effect when the Allow data changes parameter is selected. The default is 1 (**Cursor stability**). Valid values are:

1 (Cursor stability)

FM/Db2 omits a SHRLEVEL clause to the UNLOAD utility statement. This is equivalent to adding a SHRLEVEL CHANGE ISOLATION CS clause to the UNLOAD utility control statement, meaning that rows can be read, inserted, updated, and deleted from the table space or partition while the data is being unloaded and that the UNLOAD utility reads rows in cursor stability mode.

2 (Uncommitted rows)

FM/Db2 adds a SHRLEVEL CHANGE ISOLATION UR clause to the UNLOAD utility control statement. This means that rows can be read, inserted, updated, and deleted from the table space or partition while the data is being unloaded and that uncommitted rows, if they exist, are unloaded.

Use IEEE floating point

When this option is selected, FM/Db2 adds the FLOAT IEEE clause to the UNLOAD utility control statements.

If not selected, no clause is added; this means that the Db2® UNLOAD utility output format of the numeric floating point numbers are produced in S/390® hexadecimal Floating Point (HFP) format. The default is not selected.

Allow substitution chars

When this option is not selected, FM/Db2 adds the NOSUBS clause to the UNLOAD utility control statement. This means that substitution characters are not allowed in strings. The substitution character that is attempted while unloading data is treated as a conversion error.

The default is selected. A substitution character is sometimes placed in a string when that string is being converted from ASCII to EBCDIC, or converted from one CCSID to another. For example, substitution occurs when a character (sometimes referred to as a code point) that exists in the source CCSID (code page) does not exist in the target CCSID (code page).

Allow padding

When this option is selected, the NOPAD clause is not added to the UNLOAD utility control statements. The default is selected.

If not selected, FM/Db2 adds the NOPAD clause to the UNLOAD utility control statements.

The Db2® default for UNLOAD processing is to pad variable length columns in the unloaded records to their maximum length, and the unloaded records have the same length for each table. Select the item if you wish to use the Db2® defined default behavior.

When padding is performed:

- The padded data fields are preceded by the length fields that indicate the size of the actual data without the padding.
- When the output records are reloaded using the LOAD utility, padded data fields are treated as varying length data.

Maximum in Error

This option specifies the value for the maximum number of records in error that are allowed. The unloading process terminates when this value is reached. FM/Db2 adds a MAXERR clause with specified value to the UNLOAD utility statements. The default value is 1.

Encoding Scheme

This option specifies the encoding scheme used by the generated UNLOAD utility control statement for all output data of the character type. Valid values are:

1 (Preserve encoding scheme)

The encoding scheme of the source data is preserved (default).

2

EBCDIC is the encoding scheme for all output data of the character type.

3

ASCII is the encoding scheme for all output data of the character type.

4

UNICODE is the encoding scheme for all output data of the character type.

CCSID Values

This option specifies the values for the coded character set identifiers (CCSIDs) for the data in the output data sets. If you specify one or more non-zero values for the **SBCS data**, **Mixed DBCS data** and **DBCS data** fields, FM/Db2 adds a CCSID clause to the UNLOAD utility control statements. If all are zero, no CCSID clause is added.

SBCS data

Specifies the CCSID value for single byte character set (SBCS) data in output records, including data unloaded in the external character formats.

Mixed DBCS data

Specifies the CCSID value for mixed double byte character set (DBCS) data in output records, including data unloaded in the external character formats.

DBCS data

Specifies the CCSID value for DBCS data in output records, including data unloaded in the external character formats.

Zero is the default value for each of the above three CCSID value fields.

With the example settings shown in the figure, the following clauses are added to any generated UNLOAD:

- SHRLEVEL CHANGE ISOLATION UR
- FLOAT IEEE
- NOSUB
- MAXERR 2
- EBCDIC

Child panels

None.

Related tasks

- [Setting options for Db2 utilities on page 341](#)
- [UNLOAD \(tables\) on page 373](#)
- [Null indicator byte processing on page 377](#)
- [UNLOAD \(table spaces\) on page 378](#)
- [Db2 Unload utility options \(option 3.UU\) on page 68](#)

UNLOAD Utility (Table Spaces) panel

You use the UNLOAD Utility (Table Spaces) panel to generate utility control statements using the UNLOAD TABLESPACE form of the UNLOAD utility.

Panel and field definitions

Process		Options	Utilities	Help		
FM/Db2 (DFG2)		UNLOAD Utility (Table Spaces)			Row 1 to 13 of 157	
S P	Table	Part'n	Allocation		Space	
e R Database	Space	Range . Part'n	Number	Primary	Secdry	
l C Name	Name	One Two	Number Tables			
—	DSN8D81A	DSN8S81D	0 1	5	5	48
—	DSN8D81A	DSN8S81E	1 1	3	3	144
—	DSN8D81A	DSN8S81E	2 1	5	5	144
—	DSN8D81A	DSN8S81E	3 1	3	3	48
—	DSN8D81A	DSN8S81E	4 1	5	5	144
—	DSN8D81A	DSN8S81E	5 1	5	5	144
—	DSN8D81A	DSN8S81P	0 4	40	20	192
—	DSN8D81A	DSN8S81R	0 6	5	5	0
—	DSN8D81A	DSN8S81S	0 1	5	5	0
—	DSN8D81E	DSN8S81U	0 1	3	2	0
—	DSN8D81P	DSN8S81C	0 3	40	20	192
—	DSN8D81P	DSN8S81Q	0 1	40	20	0
—	DSNATPDB	DSNATPTS	0 2	4	4	0
Command ==>						Scroll PAGE
F1=Help	F2=Split	F3=Exit	F7=Backward	F8=Forward	F9=Swap	
F12=Cancel						

Parent panels

- [Db2 Utilities panel on page 610](#)

Child panels

None.

Related tasks

- [UNLOAD utility on page 372](#)
- [UNLOAD \(table spaces\) on page 378](#)
- [Where you can use templates on page 23](#)

UNLOAD Utility (Table Spaces) with LISTDEF panel

You use the UNLOAD Utility (Table Spaces) with LISTDEF panel to generate utility control statements using the UNLOAD TABLESPACE form of the UNLOAD utility.

Panel and field definitions

```

  Process  Options  Utilities  Help
  FM/Db2 (DFG2)          UNLOAD Utility (Tables)          Row 1 to 2 of 2

  P
  R LISTDEF
Cmd C Name
  * FRED
  JAMES
***** Bottom of data *****

Command ==>          Scroll PAGE
F1=Help      F2=Split    F3=Exit      F7=Backward  F8=Forward  F9=Swap
F12=Cancel

```

Cmd

You can enter commands in this field to manipulate the panel rows.

I(n)

Insert (n) new row(s)

R(n)

Repeat the current row (n times)

D(n)

Delete (n) row(s)

S(n)

Select (n) rows(s)

An asterisk (*) in the PRC column shows that the LISTDEF in the row is selected. The S command toggles the selection of rows; unselected rows become selected and selected rows become unselected.

LISTDEF Name

On entry to the panel, this field is set to the value in the **LISTDEF name** field in the Db2® Utilities panel.

Parent panels

- [Db2 Utilities panel on page 610](#)

Child panels

None.

Related tasks

- [UNLOAD utility on page 372](#)
- [UNLOAD \(table spaces\) with LISTDEF specified on page 380](#)
- [Where you can use templates on page 23](#)

UNLOAD Utility (Tables) "From" panel

You use the UNLOAD Utility (Tables) "From" panel to specify the name of the Db2® object that contains the data to be unloaded, the (optional) name of a template data set, and processing options.

Panel and field definitions

```

Process  Options  Utilities  Help
-----
FMN2PEYI FG2)          UNLOAD Utility (Tables)
Command ==>>

From Db2 Object:
Location . . . . . _____ Database . . _____ (optional)
Owner . . . . . DSN81010 + Table space _____ (optional)
Name . . . . . EMP _____ +

Unload Count . . . ALL _____ Number of rows to unload

From Template:
Data set name . . . _____
Member . . . . . _____

Processing Options:
Template usage          Enter "/", "A"lways to select option
 3 1. Above             _ Edit UNLOAD options
   2. Previous          _ Edit template
   3. Generate from table
   4. Generate/Replace

Command ==>>
F1=Help      F2=Split    F3=Exit     F4=Expand   F7=Backward F8=Forward
F9=Swap      F10=Left   F11=Right  F12=Cancel
    
```

Edit UNLOAD options

Select this option to edit the UNLOAD options. The default is not selected.

Edit template

Select this option to edit the template. The default is not selected.

Parent panels

- [Db2 Utilities panel on page 610](#)

Child panels

To display this panel...	Use/do this
UNLOAD Utility (Tables) "To" panel on page 861	Press Enter

Related tasks

- [UNLOAD utility on page 372](#)
- [UNLOAD \(tables\) on page 373](#)
- [Where you can use templates on page 23](#)

UNLOAD Utility (Tables) "To" panel

You use the UNLOAD Utility (Tables) "To" panel to specify the name of the data set that will contain the data to be unloaded, the (optional) name of a template data set, and processing options.

Panel and field definitions

<u>P</u> rocess	<u>O</u> ptions	<u>U</u> tilities	<u>H</u> elp
FMN2PEYO om DSN81010.EMP			NOPAD specified
Command ==>			
Output Sequential Data Set:			
Data set name . . .	_____		
Volume	_____		
To Copybook or Template:			
Data set name . . .	_____		
Member	_____		
Processing Options:			
Template usage	Disposition	Enter "/", "A"lways	
<u>4</u> 1. Above	<u>2</u> 1. Old or Reuse	_ View UNLOAD options	
2. Previous	2. Mod	_ Edit template mapping	
3. Generate from input			
4. Generate and save			
5. None			
Command ==>			
F1=Help	F2=Split	F3=Exit	F7=Backward F8=Forward F9=Swap
F12=Cancel			

Data set name

The name of the data set or PDS member that contains the unloaded data. The name can be a fully qualified data set name or a pattern. The name cannot include a member name, which is a restriction that is imposed by the Db2® UNLOAD utility.

Volume

The volume serial number if the data set is not cataloged.

Data set name (To Copybook or Template)

The name of the sequential or partitioned data set that contains the copybook or template that describes the data set. It can be a fully qualified data set name or a pattern. The name might include a member name or name pattern in parentheses. If the member is specified, the associated **Member** field must be empty.

Member (To Copybook or Template)

If you specified the name of a partitioned data set (PDS) without including a member name or name pattern in parentheses in the **Data set name** field, you can use this field to specify the member name or a member name pattern.

Template usage

The **Unload Utility "To"** panel provides five options for template processing:

1. Above

You must enter the name of a copybook or template in the **To Copybook or Template** section of the panel. If you do not specify a member name or if you specify a pattern, FM/Db2 displays a member selection list. After you specified the member that contains a copybook or template, processing continues by using this template instead of the template that is automatically generated for the table (see Template usage option 3).

2. Previous

Uses the last template or the template that was previously used for this table.

3. Generate from input

Generates a template based on the input template. However, the template includes the columns that are selected in the input template only. If you specified a data set name in the **To Copybook or Template** section of the panel, this option is ignored. The template that is generated is not saved.

4. Generate and save

Generates a template based on the input template. However, the template includes the columns that are selected in the input template only. To enable this option, you must enter the name of a template data set and optionally a member name in the **To Copybook or Template** section of the panel. If you do not specify a member name, or if you specify a pattern, FM/Db2 displays a member selection list. The generated template is saved.

5. None.

FM/Db2 does not use an output template.

Disposition

The disposition for the data set that contains the unloaded data.

1. Old or Reuse

Specify '1' when the unload data set exists, and the unloaded data is to replace any existing data.

2. Mod

Specify '2' in one of the following conditions. This is the default.

- The unload data does not exist, and it is to be created.
- The unload data set exists, and the unloaded data is to be added to any existing data.

View UNLOAD options

Select this option to show the view of the current UNLOAD options. The default is not selected.

Edit template mapping

Use to edit the template for the partitioned, sequential, or VSAM data set to which you are unloading the data, before you unload the data. The default is not selected.

Parent panels

- [UNLOAD Utility \(Tables\) "From" panel on page 860](#)

Child panels

None.

Related tasks

- [UNLOAD utility on page 372](#)
- [UNLOAD \(tables\) on page 373](#)
- [Specifying a data set and a member name on page 50](#)
- [Letting FM/Db2 do the mapping on page 110](#)
- [Specifying your own mapping on page 110](#)

UNLOAD Utility (Tables) with LISTDEF panel

You use the UNLOAD Utility (Tables) with LISTDEF panel to generate utility control statements using the UNLOAD TABLESPACE form of the UNLOAD utility.

Panel and field definitions

```

  Process  Options  Utilities  Help
  -----
  FM/Db2 (DFG2)                UNLOAD Utility (Tables)                Row 1 to 1 of 1

      P
      R LISTDEF
  Cmd C Name
      FRED
  ***** Bottom of data *****

  Command ==> _____ Scroll PAGE
  F1=Help    F2=Split    F3=Exit    F7=Backward  F8=Forward  F9=Swap
  F12=Cancel

```

Cmd

You can enter commands in this field to manipulate the panel rows.

I(n)

Insert (n) new row(s)

R(n)

Repeat the current row (n times)

D(n)

Delete (n) row(s)

S(n)

Select (n) rows(s)

An asterisk (*) in the PRC column shows that the LISTDEF in the row is selected. The S command toggles the selection of rows; unselected rows become selected and selected rows become unselected.

LISTDEF Name

On entry to the panel, this field is set to the value in the **LISTDEF name** field in the Db2® Utilities panel.

Parent panels

- [Db2 Utilities panel on page 610](#)

Child panels

None.

Related tasks

- [UNLOAD utility on page 372](#)
- [UNLOAD \(tables\) with LISTDEF specified on page 378](#)
- [Where you can use templates on page 23](#)

Utility Functions panel

You use the Utility Functions panel to select the FM/Db2 utility you want to use.

Panel and field definitions

<u>P</u> rocess	<u>O</u> ptions	<u>U</u> tilities	<u>H</u> elp
FM/Db2 (DFG2)		Utility Functions	
1	Print	Print Db2 table or view	
2	Objects	Create and drop Db2 objects	
3	Copy	Copy data within Db2	
4	Object List	Display and process Db2 object lists	
5	Privileges	Manage Db2 privileges	
6	Import	Import sequential or VSAM data into Db2	
7	Export	Export Db2 data to sequential or VSAM data set	
8	Create	Create Db2 test data	
9	Utilities	Db2 utility job generation	
10	Audit trail	Print audit trail report	
11	Print browse	Browse FM/Db2 print data set	
Command ==>			
F1=Help	F2=Split	F3=Exit	F7=Backward F8=Forward F9=Swap
F12=Cancel			

1 Print

Print Db2® table or view

2 Objects

Create and drop Db2® objects

3 Copy

Copy data within Db2®

4 Object List

Display and process Db2® object lists

5 Privileges

Manage Db2® privileges

6 Import

Import sequential or VSAM data into Db2®

7 Export

Export Db2® data to a sequential or VSAM data set

8 Create

Create Db2® test data

9 Utilities

Db2® utility job generation

10 Audit trail

Print an audit trail report

11 Print browse

Browse your print output

Parent panels

- [Primary Option Menu panel on page 728](#)

Child panels

To display this panel...	Use/do this
Print Utility panel on page 733	Option 1
Db2 Object Functions panel on page 604	Option 2
Copy Utility ("From") panel on page 498	Option 3
Object List Utility panel on page 719	Option 4
Manage Db2 Privileges panel on page 712	Option 5
Import Utility ("From") panel on page 693	Option 6
Export Utility ("From") panel on page 673	Option 7
Data Create Utility panel on page 587	Option 8
Db2 Utilities panel on page 610	Option 9
Print Audit Trail panel on page 729	Option 10

Related tasks

- [Printing the contents of a Db2 table on page 321](#)
- [Creating and dropping Db2 objects on page 203](#)
- [Copying data from one Db2 object to another on page 241](#)
- [Working with lists of Db2 objects on page 297](#)
- [Managing Db2 privileges on page 332](#)
- [Copying data from a VSAM or QSAM file on page 246](#)
- [Copying data to a VSAM or QSAM file on page 274](#)
- [Populating a Db2 table with data on page 239](#)
- [Generating batch JCL for Db2 utility jobs on page 339](#)
- [Printing an audit trail report on page 328](#)
- [Looking at the print output from your FM/Db2 session on page 326](#)
- [Working with object list panels on page 301](#)
- [Using the line command area \(Cmd\) on page 308](#)

Value List Edit panel

This panel allows you to to create and edit value lists to be used in field scrambling.

Panel and field definitions

Figure 143. Value List Edit panel

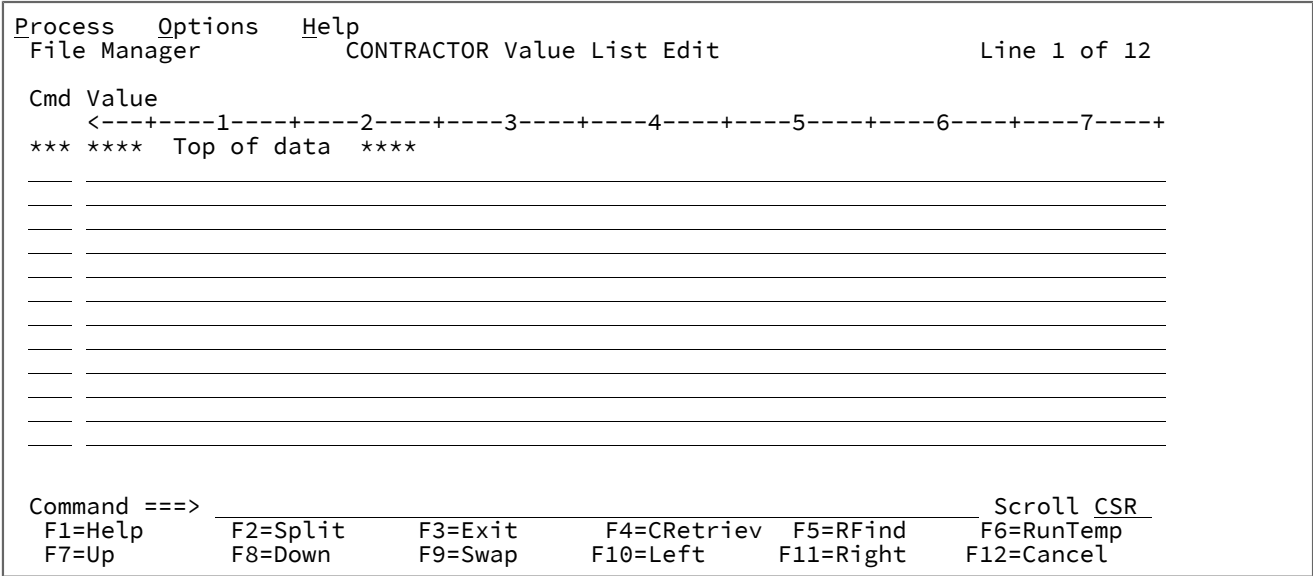

Cmd

Prefix command field. Allows you to copy, insert, move, repeat or delete lines. Available commands are:

- A**
Identifies the line after which data is to be moved or copied.
- B**
Identifies the line before which data is to be moved or copied.
- C**
Copy one line.
- Cn**
Copy *n* lines.
- CC**
Copy block of lines. Marks the start and end of the block.
- D**
Delete one line.
- Dn**
Delete *n* lines.

DD

Delete block of lines. Marks the start and end of the block.

I

Insert one empty line.

In

Insert *n* empty lines.

M

Move one line.

Mn

Move *n* lines.

MM

Move block of lines. Marks the start and end of the block.

R

Repeat line once.

Rn

Repeat line *n* times.

RR

Repeat block of lines. Marks the start and end of the block.

RRn

Repeat block of lines *n* times. Marks the start and end of the block.

Value

A value that can be used when field scrambling is in effect.

Parent panels

- [Column Attributes panel \(alphanumeric\) on page 473](#)
- [Column Attributes panel \(numeric\) on page 478](#)

Related tasks

- [Specifying and editing a value list on page 108](#)
- [Scrambling data on page 286](#)

Volumes panel

Figure 144. Volumes panel

```

  Process  Options  Utilities  Help
-----
FM/Db2 (DFG2)                               Volume(s) for DSN8G810
                                           Format TABL

SEL      SGNAME    SGCREATOR  VOLID
      *          *          *
      #1----- #2----- #3-----1-----
**** Top of data ****
      DSN8G810 CJUNELL *
**** End of data ****

Command ==>
F1=Help      F2=Zoom      F3=Exit      F4=CRetriev  F5=RFind     F6=RChange
F7=Up        F8=Down      F9=Swap      F10=Left     F11=Right    F12=Cancel

```



Note: To view other columns on this panel, press the Right function key (F11).

For a complete list of columns, refer to “*Db2@ catalog tables*” in the *DB2 for z/OS SQL Reference* relevant to your version of Db2@.

SEL

Line command area.

For a list of the line commands you can use on this panel, see [Table 22: Object list line commands on page 308](#).

Parent panels

- [Storage Group\(s\) panel on page 810](#)

Child panels

To display this panel...	Use/do this
Display Row panel on page 619	Line command ROW

Related tasks

- [Working with object list panels on page 301](#)
- [Using the line command area \(Cmd\) on page 308](#)

Related tasks

- [Managing tables used by SQL explain on page 422](#)

Chapter 18. FM/Db2 commands

This chapter describes the syntax and parameters for the primary commands that you can use in various FM/Db2 panels.

You enter primary commands on the command line of a panel.

Where the syntax allows you to specify more than one operand, you can use either a blank or a comma as a separator between each operand.

For example, both of the following commands are correct:

```
SORT col_num1 col_num2
SORT col_num1, col_num2
```

ABOUT primary command

The ABOUT command displays the current FM/Db2 version number and the PTF number of the File Manager Db2® component in a window. The popup also shows the copyright information and any notes that are shipped with the product.

Syntax

▶ ABOUT ▶

Availability

Available on all panels

Related tasks

[Checking your FM/Db2 version on page 28](#)

ALL primary command

Use the ALL primary command to select all columns from all, or one, of the tables you have specified on the primary Basic SELECT Prototyping panel.

▶ ALL { * } ▶
 { #n }

Parameters

Asterisk (*)

Selects all columns from all the specified tables.

#n

Selects all columns from the table associated with correlation name #n.

Availability

[Basic SELECT Prototyping panel on page 465](#)

Related tasks

[Using basic SQL prototyping on page 382](#)

BACKWARD primary command

The BACKWARD primary command scrolls backwards (up) through your data.

The amount (number of rows or columns) scrolled is determined by either an optional parameter or, if no parameter is entered, by the amount indicated in the **Scroll** field.

Syntax

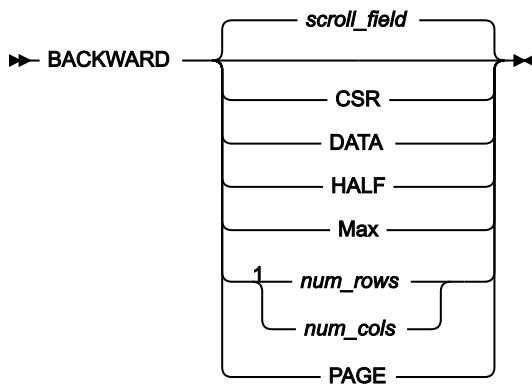

Notes:

¹ *num_rows* available in TABL display format; *num_cols* available in SNGL display format.

scroll_field

Scroll backwards by the amount indicated in the **Scroll field**. This is the default value if no parameter is used.

CSR

Scroll backwards to the cursor position.

DATA

Scroll backwards one row (TABL) or column (SNGL) less than a page of data.

HALF

Scroll backwards half a page of data.

Max

Scroll to top of the table. This has the same effect as TOP command.

num_rows

Scroll backwards *num_rows* rows. Valid range: 1–9999. Available in TABL display format.

num_cols

Scroll backwards *num_cols* columns. Valid range: 1–9999. Available in SNGL display format.

PAGE

Scroll backwards one page of data.

Availability

- [Table Browse panel on page 824](#)
- [Table Edit panel on page 826](#)

Related tasks

- [Viewing and changing Db2 data on page 119](#)

BOTTOM primary command

The BOTTOM primary command scrolls to the last page of data.

Syntax

▶ Bottom ◀

Availability

- [Table Browse panel on page 824](#)
- [Table Edit panel on page 826](#)
- [Table View panel on page 837](#)

Related tasks

- [Viewing and changing Db2 data on page 119](#)
- [Scrolling on page 157](#)

BROWSE primary command

The BROWSE primary command starts a new FM/Db2 Browse editor session.

Syntax

Figure 145. For editor panels

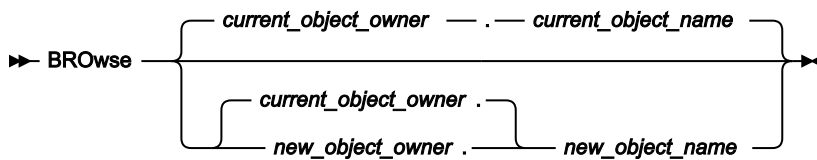

Figure 146. For Primary Option Menu panel

►► B ◀

current_object_owner

The name of the owner of the object in the current FM/Db2 editor session.

current_object_name

The name of the object in the current FM/Db2 editor session.

new_object_owner

The name of the owner of the object to be pre-filled in the entry panel for the new FM/Db2 editor session.

new_object_name

The name of the object to be pre-filled in the entry panel for the new FM/Db2 editor session.

Availability

- [Table Browse panel on page 824](#)
- [Table Edit panel on page 826](#)
- [Table View panel on page 837](#)
- [Primary Option Menu panel on page 728](#)

Related tasks

- [Viewing and changing Db2 data on page 119](#)

CANCEL primary command

The CANCEL primary command ends the current FM/Db2 editor session without saving any changes.

In an editor session, the CANCEL primary command ends the current FM/Db2 editor session and any dependent related sessions. In Edit only, if you have made changes to your data, you are asked to confirm that you want to cancel your Edit session. Cancellation of an Edit session causes any uncommitted changes to the data (in the current or in a dependent related session) to be lost.

Note that FM/Db2 may issue Db2® commit points during an Edit session, depending on the current setting of the **Enter Key Processing** and **Commit Options** options (see [Editor Options \(6 of 8\) panel on page 649](#)). If commit points have been issued, CANCEL will only discard changes made since the last commit point.

If you have selected the Edit Commit Option **Whenever Enter is pressed**, the Db2® table is updated whenever you press Enter after having made a change. CANCEL in this situation does not reverse any changes made before the last time you pressed Enter.

QUIT is a synonym for CANCEL.

Syntax

▶ CANCEL ◀

Availability

Available on most FM/Db2 panels

Related tasks

- [Viewing and changing Db2 data on page 119](#)
- [Working with templates on page 72](#)
- [Working with SQL statements on page 382](#)

CAPS primary command

The CAPS command determines whether data in the data area is to be translated to uppercase on input (CAPS ON), or whether it is to be left alone (CAPS OFF). The CAPS command overrides any previously issued CASE command. By default, lowercase data is not translated to uppercase.

Syntax

▶ CAPS { ON | OFF } ◀

CAPS ON

Translates all data in rows that are changed by overtyping from lowercase to uppercase, and translates replacement data specified in the CHANGE command from lowercase to uppercase.

CAPS ON only affects rows changed after the CAPS ON command is entered.

CAPS OFF

Does not translate changed records to uppercase.

Availability

- [Table Browse panel on page 824](#)
- [Table Edit panel on page 826](#)
- [Table View panel on page 837](#)

Related tasks

- [Installation settings that affect CAPS on page 176](#)
- [Viewing and changing Db2 data on page 119](#)

CASE primary command

The CASE command determines whether data in the data area is translated to uppercase on input (CASE UPPER), or whether it is left unchanged (CASE MIXED). The CASE command overrides any previously issued CAPS command. By default, lowercase data is not translated to uppercase.

Syntax

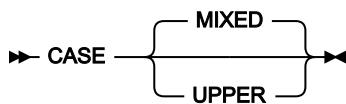

CASE MIXED

Does not translate changed or new rows to uppercase.

CASE UPPER

Translates all new rows from lowercase to uppercase, and translates all data in changed rows from lowercase to uppercase, regardless of how the rows are changed.

Availability

- [Table Browse panel on page 824](#)
- [Table Edit panel on page 826](#)
- [Table View panel on page 837](#)

Related tasks

- [Installation settings that affect CAPS on page 176](#)
- [Viewing and changing Db2 data on page 119](#)

CHANGE primary command

In a File Manager/Db2 editor session, use the CHANGE command to locate and replace one or more occurrences of a character string or numeric value in the data being edited.



Note: If you limit the number of rows loaded into the FM/Db2 editor (by either specifying a row limit or a WHERE clause), the CHANGE command applies only to the data in the FM/Db2 editor session.

To find a string without changing it, use the FIND primary command.

If you have zoomed in on a row, the CHANGE command affects only that row.

If the CHANGE command changes data, FM/Db2 places the cursor at the end (when scanning forward), or start (when scanning backwards), of the changed string or numeric data type column. If necessary, FM/Db2 scrolls to bring the string into view. If the changed data is in an excluded row, the excluded row is displayed.

Syntax

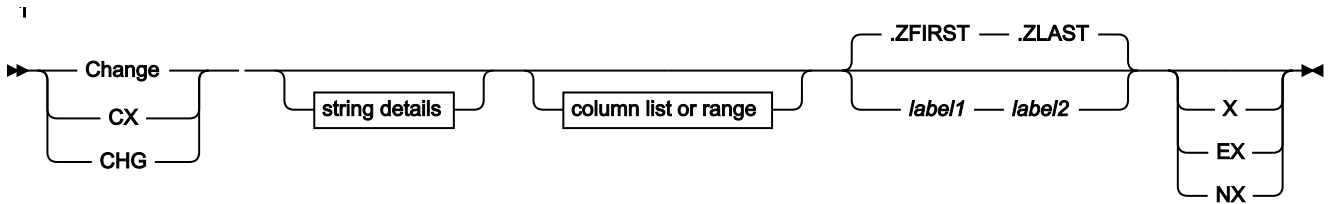

string details

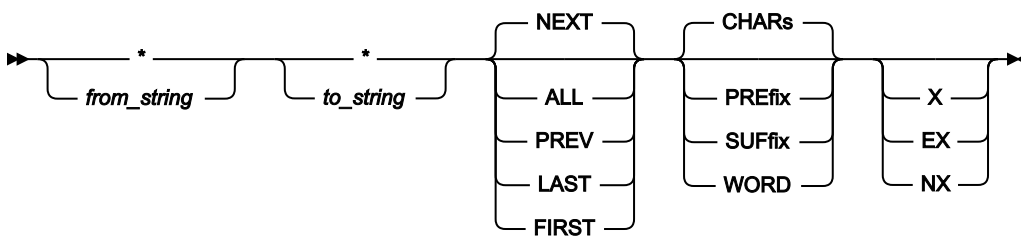

column list or range

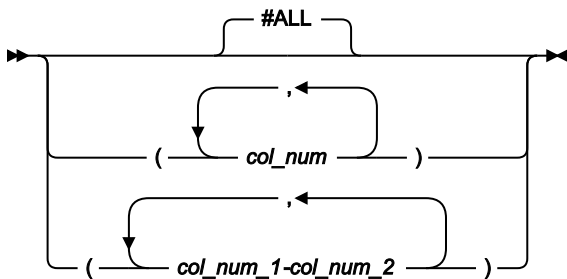

Notes:

¹ You can specify parameters in any order.

*** (asterisk)**

When used in place of the search string, uses the search string specified on the previous CHANGE command as the search string.

When used in place of the replacement string, uses the replacement string specified on the previous CHANGE command as the replacement string.

The position of the * is important for CHANGE. If it is positioned before a string, it indicates the previous search argument; that is, it is treated as the first string. If a string is found prior to the *, then it is treated as the second string (the change argument), taking the change argument from the previous CHANGE command. To use both the previous search string and the previous change string, specify `CHANGE * *`.

from_string

The string you want to search for. The string, which can be up to 100 characters in length, can be:

- A character string not starting or ending with a single quotation mark and not containing any embedded blanks or commas. The case of the string is ignored. Uppercase and lowercase representations of the same character match. For example, the following command changes the strings `black`, `Black`, and `BLACK`:

```
CHANGE black white
```

- A character string enclosed in single quotation marks. The string can contain blanks and commas. The case of the string is ignored. For example, `'Exact string'` matches `'exact string'`.
- C followed by a character string enclosed in quotation marks (C'Frog'), or a character string enclosed in quotation marks followed by c ('Frog'C). The string can contain blanks and commas. The string must match exactly (including case). For example, `C'Exact string'` does not match `C'exact string'`.
- P preceded or followed by a picture string enclosed in single or double quotation marks to describe a type of string to be found rather than the exact characters. It can contain blanks, alphabetic and numeric characters which represent themselves, or any of the special characters listed here, each of which represents a class of characters:

=

Any character.

@

Alphabetic characters.

#

Numeric characters.

\$

Special characters.

& notsym;

Non-blank characters.

.

Invalid characters.

-

Non-numeric characters.

<

Lowercase alphabets.

>

Uppercase alphabets.

- X followed by a hexadecimal string enclosed in single quotation marks (`x'c1c2'`).
- A numeric value (only when you limit the search by specifying column numbers, and only when the column being searched is a numeric column).

to_string

The string you want to replace *from_string*. The string, which can be up to 100 characters in length, can be:

- A character string not starting or ending with a single quotation mark and not containing any embedded blanks or commas. If CAPS ON or CASE UPPER is in effect, then *to_string* is converted to uppercase.
- A character string enclosed in single quotation marks. The string can contain blanks and commas. If CAPS ON or CASE UPPER is in effect, then *to_string* is converted to uppercase. The string can be a null string (`' '`).
- C followed by a character string enclosed in quotation marks (`C'Frog'`), or a character string enclosed in quotation marks followed by `c` (`'Frog'C`). The string can contain blanks and commas. Case is respected and retained. The string can be a null string (`c''`).
- P preceded or followed by a picture string enclosed in single or double quotation marks to describe the change to be made. You can change characters from uppercase to lowercase or from lowercase to uppercase, or leave the field the same using these string special characters.

=

Any character.

<

Lowercase alphabetics.

>

Uppercase alphabetics.

Examples of picture strings used with the CHANGE command:

```
c p'<' p'>' #3
```

Uppercase characters in column 3.

```
c p'>' '-' #2
```

Change any uppercase to "not sign" column 2 (note: "not sign" has no special meaning in a "to" string).

```
c p'<#' p'>=#' #1
```

Change any lowercase, any number to uppercase, the number found in column 1.

When this notation is used, numeric, bit and unicode fields (for SNGL and TABL display formats) are excluded from the search process.

- X followed by a hexadecimal string enclosed in single quotation marks (`x'c1c2'`). Case is respected and retained (the hexadecimal values are used exactly as specified).
- A numeric value.

NEXT

This is the default setting. Causes the search to begin at the cursor location (if the cursor is within the data portion of the display) or the beginning of the first row displayed, and searches ahead to find the next occurrence of the string. If the next occurrence of the string is in an excluded row and you do not limit the search to non-excluded rows, only the first excluded row containing the string is shown.

ALL

Causes the search to begin at the top of the data and find and replace all occurrences of the string. If you do not limit the search to non-excluded rows, the string is replaced in all rows (excluded and non-excluded). Any excluded rows affected by the change are redisplayed.

FIRST

Causes the search to begin at the beginning of the table and search ahead.

LAST

Causes the search to begin at the end of the table and search backwards.

PREV

Causes the search to begin at the cursor location (if the cursor is within the data portion of the display) or the beginning of the first row displayed, and searches backwards to find the string.

CHARS

Matches the search string anywhere in the data.

PREFIX

Matches the search string wherever it appears as a prefix in the data. To be a prefix, the matched text must be preceded by a non-alphanumeric character or be the start of a line or field, and must be followed by an alphanumeric character.

SUFFIX

Matches the search string wherever it appears as a suffix in the data. To be a suffix, the matched text must be preceded by an alphanumeric character, and must be followed by a non-alphanumeric character or be the end of a line or field.

WORD

Matches the search string wherever it appears as a word in the data. To be a word, the matched text must be preceded by a non-alphanumeric character or be the start of a line or field, and must be followed by a non-alphanumeric character or be the end of a line or field.

#ALL

Each column is searched according to its template attributes.

col_num

The Db2® column number (specified as #*n*) of a column to be included in the data search. Multiple column numbers must be separated by a comma or, if enclosed in brackets, separated by a blank or comma.

col_num_1

The first field reference of a range of fields. It cannot be subscripted. If the *col_num_1* field reference value is less than the lowest displayed field reference value, the lowest displayed field reference value is used.

col_num_2

The last field reference of a range of fields. It cannot be subscripted. If the *col_num_2* field reference value is greater than the highest displayed field reference value, the highest displayed field reference value is used.

The *col_num_1* and *col_num_2* field reference values must be separated by a hyphen (-). Spaces are permitted between the hyphen and the field reference values.

If *col_num_1* is a higher value than *col_num_2*, the search process reverses the operands.

label1

Label identifying the start of a range of rows. The label must start with a period (.) followed by one to four alphabetic characters (no numeric or special characters). Labels starting with the letter "Z" indicate an editor-assigned label.

label2

Label identifying the end of a range of rows. The label must start with a period (.) followed by one to four alphabetic characters (no numeric or special characters). Labels starting with the letter "Z" indicate an editor-assigned label.

EX

Excluded rows only.

NX

Non-excluded rows only.

X

Same as EX.

Availability

- [Table Edit panel on page 826](#)

Related tasks

- [Changing data with the CHANGE command on page 178](#)

COL primary command

When you use the SQL prototyping, execution and analysis option (4), you can use the COL primary command:

- On the Plan Table Rows panel to switch panel format to show the collection ID.
- On the Statement Table Rows panel to switch panel format to show the collection ID.

Syntax

►► COL ◄◄

Availability

Available on all panels [Plan Table Rows panel on page 725](#)

Related tasks

[Working with SQL statements on page 382](#)

CHARPOS primary command

In SNGL display mode only, the CHARPOS command displays, or hides, the “*character position range*” for long character or graphic columns. The command is used to dynamically turn on or off the “*column position range*” information.

Syntax

►► COLCHARPOS ◄◄

The CHARPOS command is a *toggle* command. Each time you enter the command the display status of the “*column position range*” is reversed.

When displayed, the “*character position range*” information is displayed below the column name for the second and subsequent rows used to display data for long columns. Here is an example:

Column	Data
HIGH2KEY	(this row has data for chars 1-103 of column HIGH2KEY)
104-206	(this row has data for chars 104-206 of column HIGH2KEY)
207-309	(this row has data for chars 207-309 of column HIGH2KEY)

Availability

- [Table Browse panel on page 824](#)
- [Table Edit panel on page 826](#)
- [Table View panel on page 837](#)

Related tasks

- [Locating a column on page 139](#)
- [Locating a row or column in a list of Db2 objects on page 307](#)

DELCOL primary command

In the row selection criteria panel of the File Manager template editor, the DELCOL command removes any column expression entered against one or all columns. Any affected column name and, when displayed, data type fields that are editable are changed to protected. You can also enter the DC prefix command against a column to achieve the same result.

Syntax

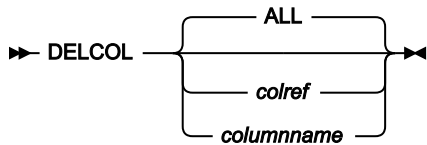

colref

A reference to a single column, for example, #4.

columnname

The name of a column in the Db2® object or result table being processed.

DELCOL with no parameters deletes all column expressions and changes all column name fields and, when displayed, data type fields to protected.

DELCOL with either a column reference or a column name removes any column expression for the specified column and changes the specified column name field and, when displayed, data type fields to protected.

Availability

- [Row Selection Criteria panel on page 767](#)

Related tasks

- [Row selection by column on page 83](#)

DELETE primary command

The DELETE primary command deletes rows from the data being edited.

Syntax

Figure 147. TABL display format

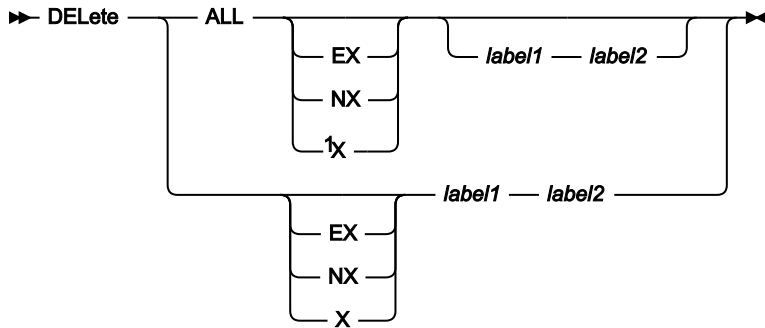

Notes:

¹ If none of these parameters (EX, NX, or X) are specified, then the DELETE command applies to both excluded and non-excluded rows.

Figure 148. SNGL display format

DELETED

ALL

Causes the DELETE command to delete all rows (or all excluded or non-excluded rows) within the specified range of rows (or within the entire table, if you do not specify a range).

If you do not specify the ALL parameter, then the DELETE command deletes only the first row (or only the first excluded or non-excluded row) within the specified range.

EX

Excluded rows only.

NX

Non-excluded rows only.

X

Same as EX.

label1

Label identifying the start of a range of rows. The label must start with a period (.) followed by one to four alphabetic characters (no numeric or special characters). Labels starting with the letter "Z" indicate an editor-assigned label.

label2

Label identifying the end of a range of rows. The label must start with a period (.) followed by one to four alphabetic characters (no numeric or special characters). Labels starting with the letter "Z" indicate an editor-assigned label.

Availability

- [Table Edit panel on page 826](#)

Related tasks

- [Deleting rows on page 186](#)

DESCRIBE primary command

The DESCRIBE primary command displays the Db2® Template Description panel where you can enter the required description for the template.

Syntax

►► DESCRIBE ◄◄

Availability

- [Column Selection/Edit panel on page 485](#)

Related tasks

- [Editing a template on page 81](#)

DESELECT primary command

In advanced SELECT prototyping, if you enter the Deselect primary command and the cursor is not currently placed on an element in the currently displayed fragment, the currently displayed fragment and its dependent fragments are removed from the syntax, and control returns to the parent of the currently displayed fragment. If the currently displayed fragment is the top fragment, this has the same effect as CANCEL or END.

If you enter the Deselect primary command with the cursor placed on a fragment field in the currently displayed fragment, the selected fragment and its dependent fragments are removed from the syntax, and control remains in the currently displayed fragment.

If the deselected fragment is the last selected (or only) item in a repeat instance, the entire instance is deleted.

Syntax

►► Deselect ◄◄

Availability

[Advanced SELECT Prototyping panel on page 442](#)

Related tasks

[Using advanced SQL prototyping on page 391](#)

DOWN primary command

The DOWN primary command scrolls down (forward) through your data.

The amount (number of rows or columns) scrolled is determined by either an optional parameter or, if no parameter is entered, by the amount indicated in the **Scroll** field.

Syntax

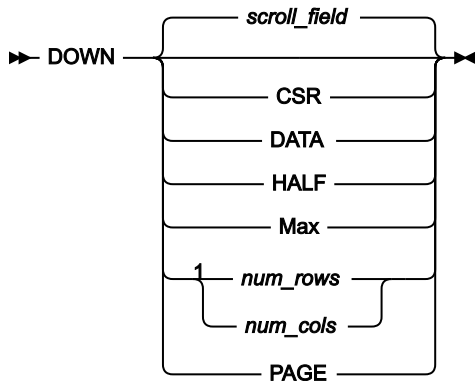

Notes:

¹ *num_rows* available in TABL display format; *num_cols* available in SNGL display format.

scroll_field

Scroll down by the amount indicated in the **Scroll field**. This is the default value if no parameter is used.

CSR

Scroll down to the cursor position.

DATA

Scroll down one row (TABL) or column (SNGL) less than a page of data.

HALF

Scroll down half a page of data.

Max

Scroll to bottom of table. This has the same effect as the BOTTOM command.

num_rows

Scroll down *num_rows* rows. Valid range: 1–9999. Available in TABL display format.

num_cols

Scroll down *num_cols* columns. Valid range: 1–9999. Available in SNGL display format.

PAGE

Scroll down one page of data.

Examples

DOWN 8

Scrolls down 8 lines.

DOWN

Scrolls down the number of lines indicated by the **Scroll** field.

DOWN M

Scrolls down to the last page of data.

Availability

- [Table Browse panel on page 824](#)
- [Table Edit panel on page 826](#)
- [Table View panel on page 837](#)
- [Enter, Execute and Explain SQL Statements panel on page 660](#)

Related tasks

- [Viewing and changing Db2 data on page 119](#)
- [Scrolling on page 157](#)
- [Entering, executing, and explaining SQL statements on page 416](#)

EDIT primary command

The EDIT primary command starts a new FM/Db2 Edit session.

Syntax

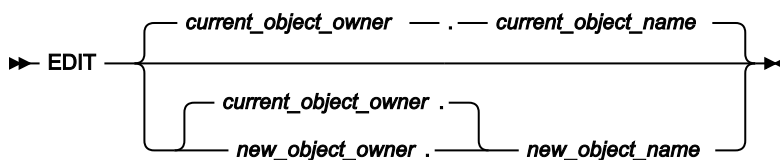

current_object_owner

The name of the owner of the object in the current FM/Db2 editor session.

current_object_name

The name of the object in the current FM/Db2 editor session.

new_object_owner

The name of the owner of the object to be pre-filled in the entry panel for the new FM/Db2 editor session.

new_object_name

The name of the object to be pre-filled in the entry panel for the new FM/Db2 editor session.

Availability

- [Table Browse panel on page 824](#)
- [Table Edit panel on page 826](#)
- [Table View panel on page 837](#)

Related tasks

- [Viewing and changing Db2 data on page 119](#)

EDITCOL primary command

In the row selection criteria panel of the File Manager template editor, the EDITCOL command changes the column name and, when displayed, the data type fields from protected to editable. This command allows a column name expression to be entered. You can also enter the EC prefix command against a column to achieve the same result.

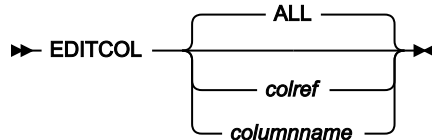
Syntax***colref***

A reference to a single column, for example, #4.

columnname

The name of a column in the Db2® object or result table being processed.

EDITCOL with no parameters changes all column name fields and, when displayed, data type fields from protected to editable.

EDITCOL with either a column reference or column name changes the specified column name field and, when displayed, data type fields from protected to editable.

Availability

- [Row Selection Criteria panel on page 767](#)

Related tasks

- [Row selection by column on page 83](#)

END primary command

END is a pseudonym for FILE.

- In View or Browse, the END primary command:
 - Ends the View or Browse editor session.
- In Edit, the END primary command:
 - Saves any uncommitted changes and ends the Edit session.
 - Fails if Db2® reports errors when FM/Db2 attempts to save changes made in the Edit session, or there are dependent edit sessions of related tables.
- When you edit a template, the END primary command:
 - Displays the save panel where you can save the template as another name.

Syntax

►► END ◄◄

Availability

- [Table Browse panel on page 824](#)
- [Table Edit panel on page 826](#)
- [Table View panel on page 837](#)
- [Column Selection/Edit panel on page 485](#)

Related tasks

- [Viewing and changing Db2 data on page 119](#)
- [Working with templates on page 72](#)

EXCLUDE primary command

The EXCLUDE primary command excludes from display certain rows in the data being viewed, browsed, or edited.

You can only use the EXCLUDE primary command in TABL display format.

To redisplay excluded rows, enter the command:

```
RESET
```

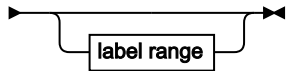
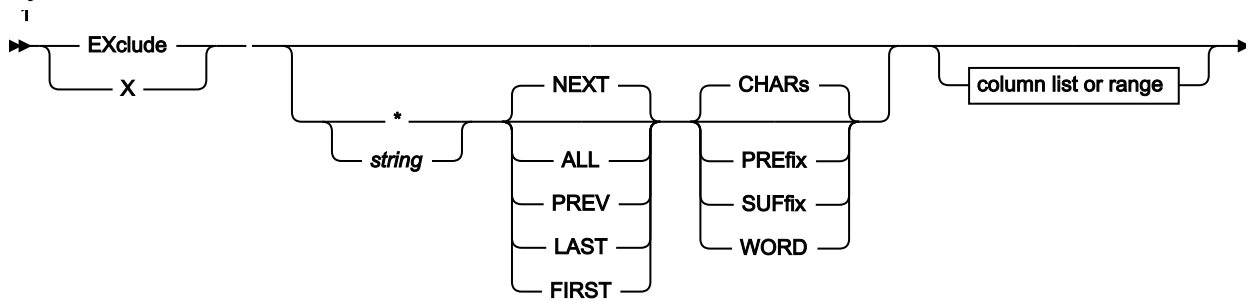
Syntax

column list or range

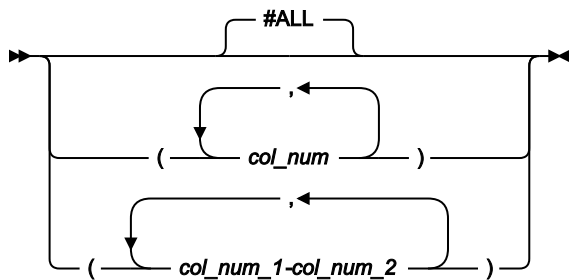

label range



Notes:

¹ You can specify parameters in any order.

*** (asterisk)**

Uses the search string specified on the previous EXCLUDE command as the search string.

string

The search string you want to search for. Rows containing this string, within the limits imposed by the other EXCLUDE command parameters, are excluded. The string can be:

- A character string not starting or ending with a single quotation mark and not containing any embedded blanks or commas. The case of the string is ignored. Uppercase and lowercase representations of the same character match. For example, "Mixed string" matches "MIXED string".
- A character string enclosed in single quotation marks. The string can contain blanks and commas. The case of the string is ignored. For example, "Exact string" matches "exact string".

- C followed by a character string enclosed in quotation marks (C'Frog'), or a character string enclosed in quotation marks followed by c ('Frog'C). The string can contain blanks and commas. The string must match exactly (including case). For example, "Exact string" does not match "exact string".
- P preceded or followed by a picture string enclosed in single or double quotation marks to describe a type of string to be found rather than the exact characters. It can contain blanks, alphabetic and numeric characters which represent themselves, or any of the special characters listed here, each of which represents a class of characters:

=

Any character.

@

Alphabetic characters.

#

Numeric characters.

\$

Special characters.

& notsym;

Non-blank characters.

.

Invalid characters.

-

Non-numeric characters.

<

Lowercase alphabets.

>

Uppercase alphabets.

Examples of picture strings used with the EXCLUDE command:

```
ex p'. ' #4
```

Exclude invalid character in column 4.

```
ex p'###'
```

Exclude 3-digit number.

```
ex '@1'p #1
```

Exclude label a1,b1,c1, (and so on) in column 1.

```
ex p'<'
```

Exclude the next lowercase alphabetic character.

```
ex p'~' #2
```

Exclude the next non-blank in column 2.

When this notation is used, numeric, bit and unicode fields (for SNGL and TABL display formats) are excluded from the search process.

- X followed by a hexadecimal string enclosed in single quotation marks For example, X'C1C2'.
- A numeric value (only when you limit the search by specifying column numbers, and only when the column being searched is a numeric column).

NEXT

This is the default setting. Causes the search to begin at the cursor location (if the cursor is within the data portion of the display) or the beginning of the first row displayed, and searches ahead to find the next occurrence of *string* in a row that is not already excluded.

ALL

Causes the search to begin at the top of the data and find all occurrences of *string*. If not specified, the search begins at the cursor location (if the cursor is within the data portion of the display) or the beginning of the first row displayed, and searches ahead to find the next occurrence of *string* in a row that is not already excluded.

The command EXCLUDE ALL excludes all displayed rows.

FIRST

Causes the search to begin at the beginning of the table and search ahead.

LAST

Causes the search to begin at the end of the table and search backwards.

PREV

Causes the search to begin at the cursor location (if the cursor is within the data portion of the display) or the beginning of the first row displayed, and searches backwards to find the string.

CHARS

Matches the search string anywhere in the data.

PREFIX

Matches the search string wherever it appears as a prefix in the data. To be a prefix, the matched text must be preceded by a non-alphanumeric character or be the start of a line or field, and must be followed by an alphanumeric character.

SUFFIX

Matches the search string wherever it appears as a suffix in the data. To be a suffix, the matched text must be preceded by an alphanumeric character, and must be followed by a non-alphanumeric character or be the end of a line or field.

WORD

Matches the search string wherever it appears as a word in the data. To be a word, the matched text must be preceded by a non-alphanumeric character or be the start of a line or field, and must be followed by a non-alphanumeric character or be the end of a line or field.

#ALL

Each column is searched according to its template attributes.

col_num

The Db2® column number (specified as #*n*) of a column to be included in the data search. Multiple column numbers must be separated by a comma or, if enclosed in brackets, separated by a blank or comma.

col_num_1

The first field reference of a range of fields. It cannot be subscripted. If the *col_num_1* field reference value is less than the lowest displayed field reference value, the lowest displayed field reference value is used.

col_num_2

The last field reference of a range of fields. It cannot be subscripted. If the *col_num_2* field reference value is greater than the highest displayed field reference value, the highest displayed field reference value is used.

The *col_num_1* and *col_num_2* field reference values must be separated by a hyphen (-). Spaces are permitted between the hyphen and the field reference values.

If *col_num_1* is a higher value than *col_num_2*, the search process reverses the operands.

label1

Label identifying the start of a range of rows. The label must start with a period (.) followed by one to four alphabetic characters (no numeric or special characters). Labels starting with the letter "Z" indicate an editor-assigned label.

label2

Label identifying the end of a range of rows. The label must start with a period (.) followed by one to four alphabetic characters (no numeric or special characters). Labels starting with the letter "Z" indicate an editor-assigned label.

Availability

- [Table Browse panel on page 824](#)
- [Table View panel on page 837](#)
- [Table Edit panel on page 826](#)

Related tasks

- [Excluding rows on page 159](#)

EXECUTE primary command

You use the EXECUTE primary when you are working with SQL statements.

For basic SELECT prototyping, the EXECUTE command executes the SELECT statement.



Note: Before you use the EXECUTE primary command, you must have selected at least one column.

For advanced SELECT prototyping, the EXECUTE primary command executes the prototyped command if it is syntactically complete. FM/Db2 displays a result table similar to the Select Statement Browse panel.

When you use the Enter, Execute and Explain SQL Statements panel, the EXECUTE primary command executes the SQL statements in the statement entry area. The EXECUTE primary command is executed by default when you press Enter and the command line is blank.

Syntax

▶ EXECUTE ◀

Availability

- [Basic SELECT Prototyping panel on page 465](#)
- [Advanced SELECT Prototyping panel on page 442](#)
- [Enter, Execute and Explain SQL Statements panel on page 660](#)

Related tasks

- [Using basic SQL prototyping on page 382](#)
- [Using advanced SQL prototyping on page 391](#)
- [Entering, executing, and explaining SQL statements on page 416](#)

EXPAND primary command

The EXPAND primary command displays a panel for inputting or editing long row selection criteria. You use this command from the Column Selection/Edit panel (you must position the cursor on the **Row Selection Criteria** input field).

Syntax

▶ EXPAND ◀

Availability

- [Column Selection/Edit panel on page 485](#)

Related tasks

- [Selecting rows on page 83](#)

EXPLAIN primary command

The EXPLAIN primary command explains the SQL statements in the statement entry area. FM/Db2 builds an SQL EXPLAIN statement using the contents of the statement entry area to build the FOR clause. If applicable, FM/Db2 also builds a SET QUERYNO clause using the contents of the **Query number** option or a generated value.

When you use the EXPLAIN primary command, FM/Db2 shows the information obtained by the generated SQL EXPLAIN statement in the Plan Table Rows panel.

Syntax

► EXPLAIN ◀

Availability

- [Enter, Execute and Explain SQL Statements panel on page 660](#)

Related tasks

- [Entering, executing, and explaining SQL statements on page 416](#)

EXPORT primary command

The EXPORT primary command starts a dialog that allows either the result table currently shown in the FM/Db2 editor session, or rows in the current FM/Db2 editor session, to be exported to a data set.

Syntax

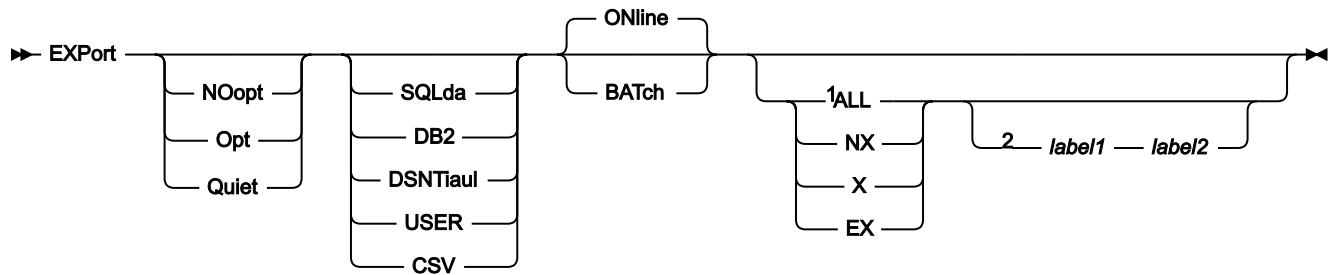

Notes:

¹ NX, X, EX valid for TABL format only.

² Label range valid for TABL format only.

NOOPT

Overrides the current setting for the **Show export options** option on the Editor Options (4 of 8) panel. The Export Options panel is not displayed.

The data format for the export is determined as follows: The current value for the export data format is used, unless a data format parameter is specified in the EXPORT command. In the latter case, the parameter specified in the EXPORT command overrides the current export data format value.

OPT

Overrides the current setting for the **Show export options** option on the Editor Options (4 of 8) panel. The Export Options panel is displayed.

QUIET

Overrides the current setting for the **Show export options** option on the Editor Options (4 of 8) panel. The Export Options panel is not displayed. This option also suppresses the display of the Export "To" panel. The current values specified on the Export "To" panel are used to process the EXPORT command.

SQLDA

Data is exported in FM/Db2 internal (SQLDA) format. This is equivalent to specifying 1 for the **Data Format** option on the Export Options (1 of 3) panel.

Db2®

Data is exported in Db2® unload format. This is equivalent to specifying 2 for the **Data Format** option on the Export Options (1 of 3) panel.

DSNTIAUL

Data is exported in same format as that used by the DSNTIAUL sample program. This is equivalent to specifying 3 for the **Data Format** option on the Export Options (1 of 3) panel.

USER

Data is exported in a user-defined data format. This is equivalent to specifying 4 for the **Data Format** option on the Export Options (1 of 3) panel.

CSV

Data is exported in a comma-separated variables (delimited) format. This is equivalent to specifying 5 for the **Data Format** option on the Export Options (1 of 3) panel.

ONLINE

The export is performed on-line.

BATCH

Generate a JCL deck to execute the export for the Db2® object or SQL SELECT statement in batch mode. You cannot specify BATCH with any of ALL|NX|X|EX.

ALL

Copies all rows in the current FM/Db2 editor session to the target data set.

NX

Copies all non-excluded rows in the current FM/Db2 editor session to the target data set.

X

Copies all excluded rows in the current FM/Db2 editor session to the target data set.

EX

Same as X.

label1

Label identifying the start of a range of rows to be processed. The label must start with a period (.) followed by one to four alphabetic characters (no numeric or special characters). Labels starting with the letter "Z" indicate an editor-assigned label.

label2

Label identifying the end of a range of rows to be processed. The label must start with a period (.) followed by one to four alphabetic characters (no numeric or special characters). Labels starting with the letter "Z" indicate an editor-assigned label.

Availability

- [Table Browse panel on page 824](#)
- [Table Edit panel on page 826](#)
- [Table View panel on page 837](#)

Related tasks

- [Excluding rows on page 159](#)

FILE primary command

FILE is a pseudonym for END.

- In View or Browse, the FILE primary command:
 - Ends the View or Browse session.
- In Edit, the FILE primary command:
 - Saves any uncommitted changes and ends the Edit session.
 - Fails if Db2® reports errors when FM/Db2 attempts to save changes made in the Edit session, or there are dependent edit sessions of related tables.
- When you edit a template, the FILE primary command:
 - Displays the save panel where you can save the template as another name.

Syntax

► FILE ◄

Availability

- [Table Browse panel on page 824](#)
- [Table Edit panel on page 826](#)
- [Table View panel on page 837](#)
- [Column Selection/Edit panel on page 485](#)

Related tasks

- [Viewing and changing Db2 data on page 119](#)
- [Working with templates on page 72](#)

FIND primary command

The FIND primary command searches the data for a character string or a numeric field with a particular numeric value.

In a File Manager/Db2 editor session, or the Object List utility:

- If the string or numeric value is found, then the FIND command positions the cursor at the beginning of the string or numeric field and, if necessary, automatically scrolls the found data into view.
- The FIND command highlights all occurrences of the search string or numeric value (even when you specify FIRST, LAST, PREV, NEXT, EX, NX, or X). To turn off the highlighting, enter the RESET FIND command.

In Print Browse:

- If the character string is found, the record containing the string is displayed at the top position.

To find the next occurrence of the same string, press the RFind function key (F5), enter FIND *, or enter the FIND command with no parameters. A message is displayed if the string cannot be found.



Note: FIND * does *not* repeat the previous FIND command with the same parameters. FIND * repeats the previous FIND command with the same string argument, but all other parameters revert to their default values unless specified.

Syntax

Figure 149. Editor session

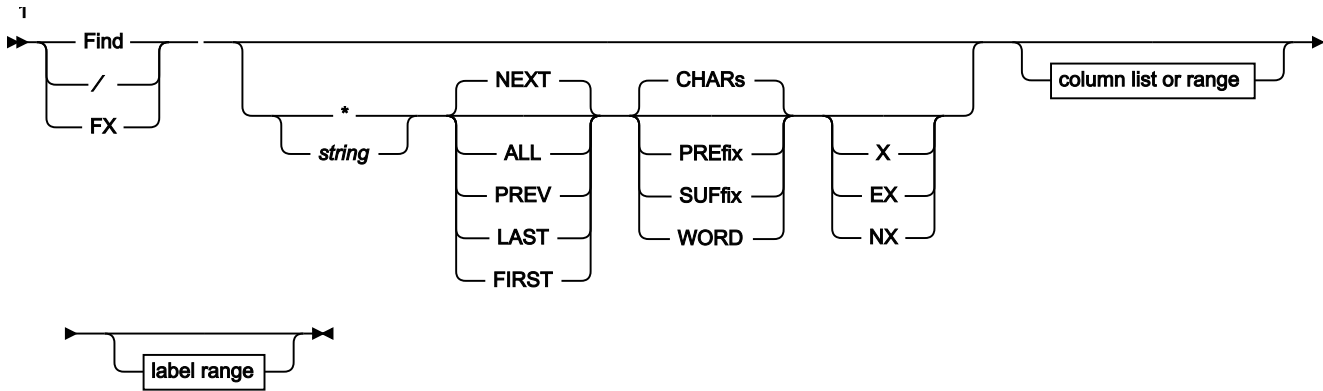

column list or range (SNGL or TABL display format)

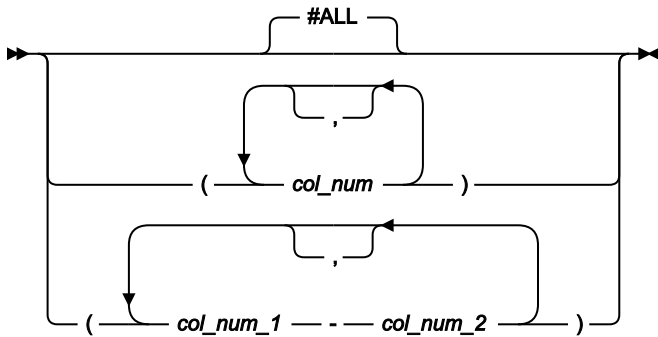

label range

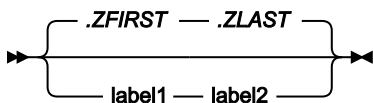

Notes:

¹ You can specify parameters in any order.

Figure 150. Object List utility

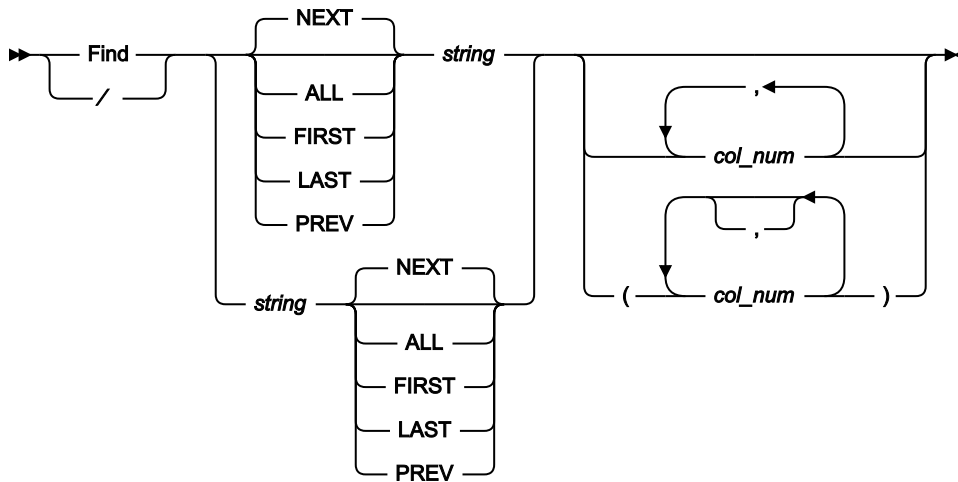
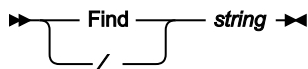

Figure 151. Print Browse



* (asterisk)

Uses the search string specified on the previous FIND command as the search string.

string

The string you want to search for. The string, that can be up to 100 characters in length, can be:

- A character string not starting or ending with a single quotation mark and not containing any embedded blanks or commas. The case of the string is ignored. Uppercase and lowercase representations of the same character match. For example, the following command finds the strings `black`, `Black`, and `BLACK`:

```
FIND black
```

- A character string enclosed in single quotation marks. The string can contain blanks and commas. The case of the string is ignored. For example, `'Exact string'` matches `'exact string'`.
- C followed by a character string enclosed in quotation marks (C'Frog'), or a character string enclosed in quotation marks followed by c ('Frog'C). The string can contain blanks and commas. The string must match exactly (including case). For example, `C'Exact string'` does not match `C'exact string'`.
- P preceded or followed by a picture string enclosed in single or double quotation marks to describe a type of string to be found rather than the exact characters. It can contain blanks, alphabetic and numeric characters which represent themselves, or any of the special characters listed here, each of which represents a class of characters:

=

Any character.

@

Alphabetic characters.

#

Numeric characters.

\$

Special characters.

& notsym;

Non-blank characters.

.

Invalid characters.

-

Non-numeric characters.

<

Lowercase alphabets.

>

Uppercase alphabets.

Examples of picture strings used with the FIND command:

```
find p'.' #3
```

Find invalid character in columns 3.

```
find p'###'
```

Find 3 digit number (for example, 101 but not 99).

```
find '@1'p #1
```

Find label a1,b1,c1, (and so on) in column 1.

```
find p'<'
```

Find lowercase alphabetic character.

```
find p'-' #2
```

Find non-blank character in column 2.

When this notation is used, numeric, bit and unicode fields (for SNGL and TABL display formats) are excluded from the search process.

- X followed by a hexadecimal string enclosed in single quotation marks. For example, `x'c1c2'`.
- (FM/Db2 editor session only.) A numeric value (only when you limit the search by specifying column numbers, and only when the column being searched is a numeric column).

NEXT

This is the default setting. Causes the search to begin at the cursor location (if the cursor is within the data portion of the display) or the beginning of the first row displayed, and searches ahead to find the next occurrence of *string*.

ALL

Causes the search to begin at the top of the data and find all occurrences of the string.



Note: Not-selected rows that are hidden from display or represented by shadow lines are not processed by the FIND command, even when the ALL parameter is specified.

FIRST

Causes the search to begin at the beginning of the table and search ahead.

LAST

Causes the search to begin at the end of the table and search backwards.

PREV

Causes the search to begin at the cursor location (if the cursor is within the data portion of the display) or the beginning of the first row displayed, and searches backwards to find the string.

CHARS

Matches the search string anywhere in the data.

PREFIX

Matches the search string wherever it appears as a prefix in the data. To be a prefix, the matched text must be preceded by a non-alphanumeric character or be the start of a line or field, and must be followed by an alphanumeric character.

SUFFIX

Matches the search string wherever it appears as a suffix in the data. To be a suffix, the matched text must be preceded by an alphanumeric character, and must be followed by a non-alphanumeric character or be the end of a line or field.

WORD

Matches the search string wherever it appears as a word in the data. To be a word, the matched text must be preceded by a non-alphanumeric character or be the start of a line or field, and must be followed by a non-alphanumeric character or be the end of a line or field.

#ALL

Each column is searched according to its template attributes.

col_num

The Db2® column number (specified as #*n*) of a column to be included in the data search. Multiple column numbers must be separated by a comma or, if enclosed in brackets, separated by a blank or comma.

col_num_1

The first field reference of a range of fields. It cannot be subscripted. If the *col_num_1* field reference value is less than the lowest displayed field reference value, the lowest displayed field reference value is used.

col_num_2

The last field reference of a range of fields. It cannot be subscripted. If the *col_num_2* field reference value is greater than the highest displayed field reference value, the highest displayed field reference value is used.

The *col_num_1* and *col_num_2* field reference values must be separated by a hyphen (-). Spaces are permitted between the hyphen and the field reference values.

If *col_num_1* is a higher value than *col_num_2*, the search process reverses the operands.

label1

(FM/Db2 editor session only.) Label identifying the start of a range of rows. The label must start with a period (.) followed by one to four alphabetic characters (no numeric or special characters). Labels starting with the letter "Z" indicate an editor-assigned label.

label2

(FM/Db2 editor session only.) Label identifying the end of a range of rows. The label must start with a period (.) followed by one to four alphabetic characters (no numeric or special characters). Labels starting with the letter "Z" indicate an editor-assigned label.

EX

Excluded rows only.

NX

Non-excluded rows only.

X

Same as EX.

Availability

- [Table Browse panel on page 824](#)
- [Table Edit panel on page 826](#)
- [Table View panel on page 837](#)
- Any Print Browse display panel
- [Collections panel on page 471](#)
- [Columns panel on page 491](#)
- [Databases panel on page 593](#)
- [Database Request Modules panel on page 591](#)
- [Distinct Types panel on page 619](#)
- [Functions panel on page 684](#)
- [Indexes panel on page 697](#)

- [Application Packages panel on page 460](#)
- [Application Plans panel on page 463](#)
- [Schemas panel on page 779](#)
- [Stored Procedures panel on page 813](#)
- [Synonyms panel on page 815](#)
- [Tables, Views and Aliases panel on page 843](#)
- [Table Spaces panel on page 834](#)
- [Triggers panel on page 853](#)
- [Storage Group\(s\) panel on page 810](#)

Related tasks

- [Viewing data in a File Manager/Db2 editor session on page 138](#)
- [Looking at the print output from your FM/Db2 session on page 326](#)
- [Finding a string in a list of Db2 objects on page 308](#)
- [Locating a row or column in a list of Db2 objects on page 307](#)

FMAP primary command

The FMAP command can be used to edit or view a column in a table using a template. If the column being mapped is shorter than the template mapping a warning message is issued when data is changed and any data which is beyond the end of the mapped field is ignored.

The row containing the column to be mapped must be at the top of the screen or the cursor may be positioned on the row when the FMAP command is issued.

If the column identification parameter is not specified and the cursor is positioned on a column that column is used. Otherwise a Field List Selection panel will be displayed.

If the template name is not specified a panel is displayed where this information can be supplied.

Syntax

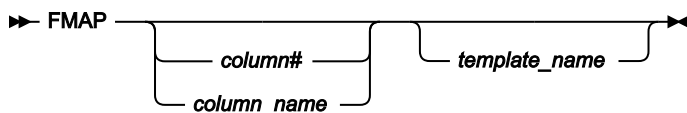

column#

The reference number of the column to be mapped.

column_name

The name of the column to be mapped.

template_name

The name of the template to be used to map the column. A partially or fully qualified data set name together with the member name can be specified.

Availability

- [Table Browse panel on page 824](#)
- [Table Edit panel on page 826](#)
- [Table View panel on page 837](#)

FORMAT primary command

The FORMAT primary command toggles between tabular display format (TABL) and single-row display format (SNGL). It has the same effect as changing the **Format** field (in the upper right corner of the panel).

Syntax

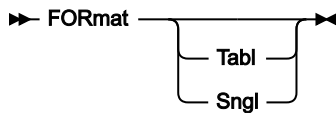

Tabl

In SNGL display format, changes to TABL display format and positions the current row at the top of the panel. This parameter is optional.

Sngl

In TABL display format, changes to SNGL display format and displays the row previously shown at the top of the panel. This parameter is optional.



Note:

1. You can also use the FS and FT primary commands to toggle between TABL and SNGL display formats.
2. In View and Edit, when in TABL display format, you can use the FS *prefix* command against a row to change to SNGL display format and display that row.

Availability

- [Table Browse panel on page 824](#)
- [Table Edit panel on page 826](#)
- [Table View panel on page 837](#)

Related tasks

- [Viewing and changing Db2 data on page 119](#)

FORWARD primary command

The FORWARD primary command scrolls forward (down) through your data.

The amount (number of rows or columns) scrolled is determined by either an optional parameter or, if no parameter is entered, by the amount indicated in the **Scroll** field.

Syntax

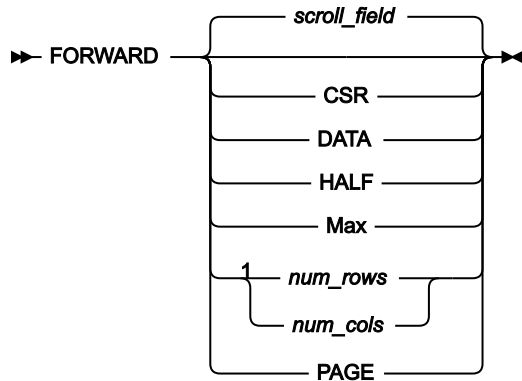

Notes:

¹ *num_rows* available in TABL display format; *num_cols* available in SNGL display format.

scroll_field

Scroll forward by the amount indicated in the **Scroll field**. This is the default value if no parameter is used.

CSR

Scroll forward to the cursor position.

DATA

Scroll forward one row (TABL) or column (SNGL) less than a page of data.

HALF

Scroll forward half a page of data.

Max

Scroll to bottom of table. This has the same effect as the BOTTOM command.

num_rows

Scroll forward *num_rows* rows. Valid range: 1–9999. Available in TABL display format.

num_cols

Scroll forward *num_cols* columns. Valid range: 1–9999. Available in SNGL display format.

PAGE

Scroll forward one page of data.

Availability

- [Table Browse panel on page 824](#)
- [Table Edit panel on page 826](#)
- [Table View panel on page 837](#)

Related tasks

- [Viewing and changing Db2 data on page 119](#)

FREE primary command

In the FM/Db2 editor, the FREE command removes any scrolling lock on one or more columns. You can set scrolling locks with the HOLD editor primary command or by using the H prefix command in the template editor.

Syntax

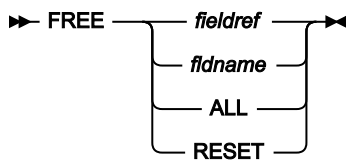

fieldref

A single field reference (for example, #1), a range (for example, #2-#5), or a list of single field references/ranges separated by spaces (for example, #1 #4 #6-#7). A single field specification is #n; n is a positive integer and cannot exceed the number of columns in the Db2® object or result table being processed.

fldname

The name of a column in the Db2® object or result table being processed. The column name can be preceded by a pound sign (#). Any value entered is translated to upper case if the "Translate Db2® object names" system's option is selected.

Examples

```
FREE ALL
```

Removes all scrolling locks.

```
FREE RESET
```

Removes all scrolling locks.

```
FREE #4
```

Removes any scrolling lock from column #4.

```
FREE #9 #2
```

Removes any scrolling lock from columns #2 and #9.

FREE #5-#9

Removes any scrolling lock from columns #5, #6, #7, #8, and #9.

Availability

- [Db2 Browse panel on page 595](#)
- [Db2 Edit panel on page 598](#)
- [Db2 View panel on page 613](#)
- Any panels displayed with the Object List utility (3.4)

Related tasks

- [Viewing and changing Db2 data on page 119](#)
- [Working with lists of Db2 objects on page 297](#)

FS primary command

In TABL display format, you can use the FS primary command to change to SNGL display format. The row currently displayed at the top of the panel in TABL display format is shown in SNGL display format.

The FS primary command has the same effect as changing the **Format** field (in the upper right corner of the panel) from *"TABL"* to *"SNGL"*.

Syntax

► FS ◄

Availability

- [Table Browse panel on page 824](#)
- [Table Edit panel on page 826](#)
- [Table View panel on page 837](#)

Related tasks

- [Viewing and changing Db2 data on page 119](#)

FT primary command

In SNGL display format, you can use the FT primary command to change to TABL display format. The row currently displayed in SNGL display format is shown at the top of the panel in TABL display format.

The FT primary command has the same effect as changing the **Format** field (in the upper right corner of the panel) from *"SNGL"* to *"TABL"*.

Syntax

► FT ◄

Availability

- [Table Browse panel on page 824](#)
- [Table Edit panel on page 826](#)
- [Table View panel on page 837](#)

Related tasks

- [Viewing and changing Db2 data on page 119](#)

HEX primary command

The HEX primary command sets or resets the hexadecimal display format.

Syntax

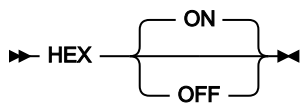

(no parameter)

Toggles the correct hexadecimal-display status. That is, it turns hexadecimal display ON if currently OFF, and turns hexadecimal display OFF if currently ON.

OFF

Display the data in character format.

ON

Display the hexadecimal representation of the data vertically (three lines for each byte).

Availability

- [Table Browse panel on page 824](#)
- [Table Edit panel on page 826](#)
- [Table View panel on page 837](#)

Related tasks

- [Displaying data in hexadecimal format on page 162](#)

HIDE primary command

In the FM/Db2 editor, the HIDE command removes a column from the data display. A hidden column can be displayed by using the SHOW editor primary command or by using the S prefix command in the template editor.

Syntax

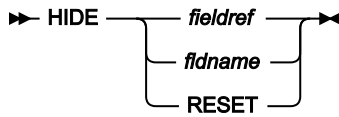

fieldref

A single field reference (for example, #1), a range (for example, #2-#5), or a list of single field references/ranges separated by spaces (for example, #1 #4 #6-#7). A single field specification is #n; n is a positive integer and cannot exceed the number of columns in the Db2® object or result table being processed.

fldname

The name of a column in the Db2® object or result table being processed. The column name can be preceded by a pound sign (#). Any value entered is translated to upper case if the "Translate Db2® object names" system's option is selected.

Examples

```
HIDE RESET
```

Shows all hidden columns.

```
HIDE #4
```

Does not display column #4.

```
HIDE #7 #1
```

Does not display columns #1 and #7

```
HIDE #2-#5
```

Does not display columns #2, #3, #4, and #5.

Availability

- [Db2 Browse panel on page 595](#)
- [Db2 Edit panel on page 598](#)
- [Db2 View panel on page 613](#)
- Any panels displayed with the Object List utility (3.4)

Related tasks

- [Viewing and changing Db2 data on page 119](#)
- [Working with lists of Db2 objects on page 297](#)

HINT primary command

When you use the SQL prototyping, execution and analysis option (4), you can use the HINT primary command:

- On the Plan Table Rows panel to switch panel format to show hint IDs and hints used
- On the Statement Table Rows panel to switch panel format to show hint IDs and hints used

Syntax

▶▶ HINT ◀◀

Availability

- [Plan Table Rows panel on page 725](#)
- [Statement Table Rows panel on page 808](#)

Related tasks

[Working with SQL statements on page 382](#)

HOLD primary command

In the FM/Db2 editor, the HOLD command sets a scrolling lock on one or more columns.

You can hold columns so that, if you scroll left or right in TABL display format, those columns are always displayed on the left of the panel (regardless of how far you scroll).

You can remove scrolling locks with the FREE editor primary command or by using the H prefix command in the template editor.

Syntax

▶▶ HOLD *fieldref* ◀◀
 fldname
 RESET

fieldref

A single field reference (for example, #1), a range (for example, #2-#5), or a list of single field references/ranges separated by spaces (for example, #1 #4 #6-#7). A single field specification is #n; n is a positive integer and cannot exceed the number of columns in the Db2® object or result table being processed.

fldname

The name of a column in the Db2® object or result table being processed. The column name can be preceded by a pound sign (#). Any value entered is translated to upper case if the "Translate Db2® object names" system's option is selected.

Examples

`HOLD RESET`

Removes all scrolling locks.

`HOLD #4`

Sets a scrolling lock on column #4.

`HOLD #9 #2`

Sets a scrolling lock on columns #9 and #2.



Note: The columns are held in the order that is specified, so the display shows (from left to right) columns #9 and #2 followed by the non-held columns.

`HOLD #5-#9`

Sets a scrolling lock on columns #5, #6, #7, #8, and #9.

Availability

- [Db2 Browse panel on page 595](#)
- [Db2 Edit panel on page 598](#)
- [Db2 View panel on page 613](#)
- Any panels displayed with the Object List utility (3.4)

Related tasks

- [Viewing and changing Db2 data on page 119](#)
- [Working with lists of Db2 objects on page 297](#)

INDEXINF primary command

The INDEXINF primary command shows or hides index information about each column when displayed in SNGL display format.

In SNGL display format, FM/Db2 displays an additional column (to the left of the column containing the column name) showing information about primary keys, foreign keys, unique indexes. (If you enter the INDEXINF primary command in TABL display format, the display is unaltered. However, if you change to SNGL display format, the display status of the additional column is reversed.)

If the index information is already displayed, the INDEXINF primary command removes it from display.



Note:



1. Information about primary keys, foreign keys, and unique indexes is only shown for tables (but not for views).
2. Foreign key information can only be displayed if the **Retrieve foreign key information when building templates** option is selected when the template is created.
3. The INDEXINF primary command has the same effect as selecting (or deselecting) the **Show keys, indexes and nullable columns** option.

Syntax

►► INDEXINF ◄◄

Availability

- [Table Browse panel on page 824](#)
- [Table Edit panel on page 826](#)
- [Table View panel on page 837](#)

Related tasks

- [Viewing and changing Db2 data on page 119](#)

INSRPT primary command

Insert repeat. In advanced SELECT prototyping, if the cursor is positioned on a repeatable item, FM/Db2 creates a new repeat instance and selects the element on which the cursor was placed.

Syntax

►► INSRPT ◄◄

Availability

[Advanced SELECT Prototyping panel on page 442](#)

Related tasks

[Using advanced SQL prototyping on page 391](#)

LEFT primary command

- In View or Edit:

In TABL display format, the LEFT primary command scrolls to the left of your data. (You cannot use LEFT in SNGL display format.)

The amount (number of panel columns) scrolled is determined by either an optional parameter or, if no parameter is entered, by the amount indicated in the **Scroll** field.

- When editing a template:

When you are editing a template, the LEFT primary command:

- Scrolls the **Row Selection Criteria** field on the Column Selection/Edit panel (the cursor must be positioned on the field at the time you issue the LEFT primary command)
- Toggles the display (on an 80-character screen) on the Row Selection Criteria panel between the **Column name** and **Data type(length)** details appearing (the cursor must not be positioned on a **Value** field at the time you issue the LEFT primary command)

Syntax

Figure 152. FM/Db2 editor session

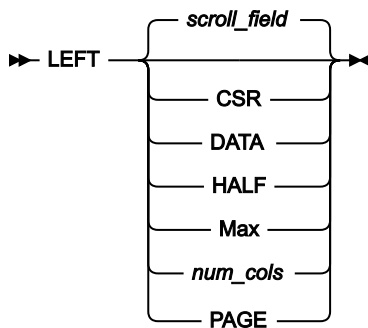

Figure 153. Template editing

▶ LEFT ◀

scroll_field

Scroll left by the amount indicated in the **Scroll field**. This is the default value if no parameter is used.

CSR

Scroll left to the cursor position.

DATA

Scroll left one panel column less than a page of data.

HALF

Scroll left half a page of data.

Max

Scroll to the beginning of the row.

num_cols

Scroll left *num_cols* panel columns. Valid range: 1–9999.

PAGE

Scroll left one page of data.

Availability

- [Table Browse panel on page 824](#)
- [Table Edit panel on page 826](#)
- [Table View panel on page 837](#)
- [Column Selection/Edit panel on page 485](#)
- [Row Selection Criteria panel on page 767](#)

Related tasks

- [Scrolling on page 157](#)
- [Scrolling the Row Selection Criteria field on page 91](#)
- [Changing the display \(80-character screens only\) on page 88](#)

LHEX primary command

In the FM/Db2 editor, the LHEX command displays the data for one or more columns in long hexadecimal format. In LHEX format, each character is shown as two hexadecimal characters, which are displayed from left to right. For example, '1' appears as 'F1' in LHEX format. Only (VAR)CHAR, (VAR)GRAPHIC, DATE, TIME, and TIMESTAMP columns are affected.

Syntax

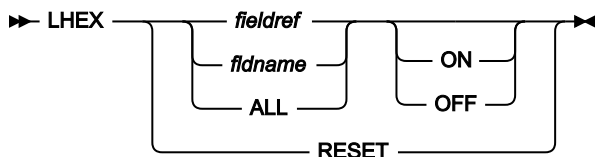

fieldref

A single field reference (for example, #1), a range (for example, #2-#5), or a list of single field references/ranges separated by spaces (for example, #1 #4 #6-#7). A single field specification is #n; n is a positive integer and cannot exceed the number of columns in the Db2® object or result table being processed.

fldname

The name of a column in the Db2® object or result table being processed. The column name can be preceded by a pound sign (#). Any value entered is translated to upper case if the "Translate Db2® object names" system's option is selected.

ON|OFF

Indicates whether to turn the LHEX option on or off. Omitting this parameter results in the command acting as a toggle; the field's current LHEX display status is reversed.

Examples

```
LHEX ALL ON
```

Displays the data for all eligible columns in long hex.

```
LHEX #4 ON
```

Displays the data for column #4 in long hex.

```
LHEX #9 #2 OFF
```

Displays the data for columns #9 and #2 in character format.

```
LHEX #5-#7 ON
```

Displays the data for columns #5, #6, and #7 in long hex.

Availability

- [Db2 Browse panel on page 595](#)
- [Db2 Edit panel on page 598](#)
- [Db2 View panel on page 613](#)
- Any panels displayed with the Object List utility (3.4)

Related tasks

- [Viewing and changing Db2 data on page 119](#)
- [Working with lists of Db2 objects on page 297](#)

LOBBRWS primary command

The LOBBRWS primary command starts a new FM/Db2 LOB editor session, in browse mode, for a LOB (BLOB, CLOB or DBCLOB) column. The Db2® object being processed must contain a LOB column.

The command is cursor sensitive. Type the command, move the cursor to the LOB column of interest and press Enter. A File Manager/Db2 LOB editor session, in browse mode, for the LOB column at the cursor position is displayed.

The command can also be issued without cursor positioning, in which case parameters may be required:

Syntax

Figure 154. In SNGL display format

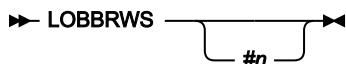
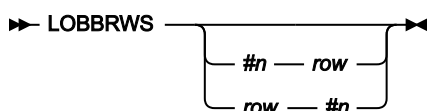

Figure 155. In TABL display format



#n

A valid reference. The data type for #n must be BLOB, CLOB or DBCLOB. #n can be omitted when the Db2® object contains only one LOB column. If #n is omitted when the Db2® object contains multiple LOB columns, FM/Db2 searches for the first selected LOB column, starting at #1.

row

A number that identifies a row in the editor session. A row number should not be specified when the command is issued in SNGL mode, the command applies to the currently displayed row.

Availability

- [Table Browse panel on page 824](#)
- [Table Edit panel on page 826](#)
- [Table View panel on page 837](#)

LOBEDIT primary command

The LOBEDIT primary command starts a new FM/Db2 LOB editor session, in edit mode, for a LOB (CLOB or DBCLOB) column. Edit of a BLOB is not supported. The Db2® object being processed must contain a LOB column.

The command is cursor sensitive. Type the command, move the cursor to the LOB column of interest and press Enter. A File Manager/Db2 LOB editor session, in edit mode, for the LOB column at the cursor position is displayed.



Note: Do not use the SAVE command in a LOBEDIT session because the LOB data will not be updated in the Db2 table.

The command can also be issued without cursor positioning, in which case parameters may be required:

Syntax

Figure 156. In SNGL display format



Figure 157. In TABL display format

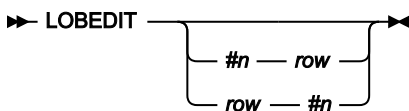

#n

A valid reference. The data type for #n must be a CLOB or DBCLOB. #n can be omitted when the Db2® object contains only one LOB column. If #n is omitted when the Db2® object contains multiple LOB columns, FM/Db2 searches for the first selected LOB column, starting at #1.

row

A number that identifies a row in the editor session. A row number should not be specified when the command is issued in SNGL mode, the command applies to the currently displayed row.

Availability

- [Table Edit panel on page 826](#)

LOBLEN primary command

The LOBLEN primary command displays the length for a LOB (BLOB, CLOB or DBCLOB) column. The Db2® object being processed must contain a LOB column.

The command is cursor sensitive. Type the command, move the cursor to the LOB column of interest and press Enter. The length for the LOB column at the cursor position is displayed.

The command can also be issued without cursor positioning, in which case parameters may be required:

Syntax

Figure 158. In SNGL display format

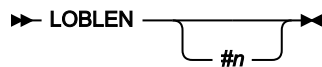
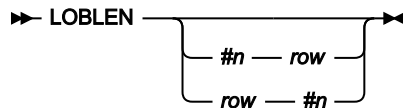

Figure 159. In TABL display format

**#n**

A valid reference. The data type for #n must be BLOB, CLOB or DBCLOB. #n can be omitted when the Db2® object contains only one LOB column. If #n is omitted when the Db2® object contains multiple LOB columns, FM/Db2 searches for the first selected LOB column, starting at #1.

row

A number that identifies a row in the editor session. A row number should not be specified when the command is issued in SNGL mode, the command applies to the currently displayed row.

Availability

- [Table Browse panel on page 824](#)
- [Table Edit panel on page 826](#)
- [Table View panel on page 837](#)

LOBVIEW primary command

The LOBVIEW primary command starts a new FM/Db2 LOB editor session, in view mode, for a LOB (BLOB, CLOB or DBCLOB) column. The Db2® object being processed must contain a LOB column

The command is cursor sensitive. Type the command, move the cursor to the LOB column of interest and press Enter. A File Manager/Db2 LOB editor session, in view mode, for the LOB column at the cursor position is displayed.

The command can also be issued without cursor positioning, in which case parameters may be required:

Syntax

Figure 160. In SNGL display format

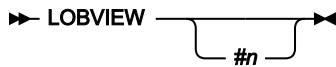
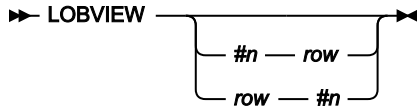

Figure 161. In TABL display format



#n

A valid reference. The data type for #n must be BLOB, CLOB or DBCLOB. #n can be omitted when the Db2® object contains only one LOB column. If #n is omitted when the Db2® object contains multiple LOB columns, FM/Db2 searches for the first selected LOB column, starting at #1.

row

A number that identifies a row in the editor session. A row number should not be specified when the command is issued in SNGL mode, the command applies to the currently displayed row.

Availability

- [Table Edit panel on page 826](#)
- [Table View panel on page 837](#)

LOCATE primary command

- When you use the LOCATE primary command in an editor session or the Object List utility:
 - FM/Db2 moves the display to the row, or first column, that matches the search criteria.
 - To move to a particular row, specify the row number. You can specify a label to move to a row to which that label has previously been assigned.

- To search for a particular column, specify either the column number (for example, #4), or part or all of a column name (for example, SAL). When you search for part or all of a column name, you can use one of the optional parameters to nominate the direction and starting point for the search. Where there may be ambiguity, use the FLD parameter to differentiate between a column name and a Db2® column number.
- When you use the LOCATE primary command in Print Browse (3.11):
 - Positions a specified line number at the top of the display.

Syntax

Figure 162. FM/Db2 editor session

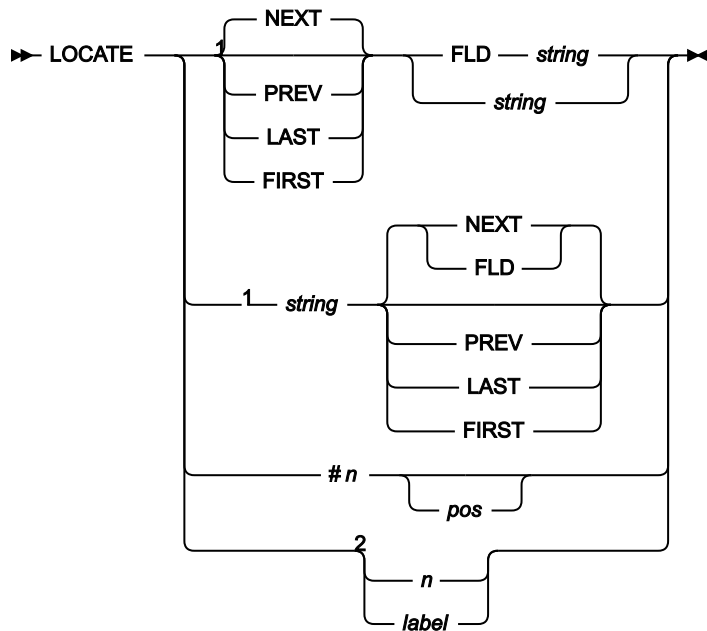

Notes:

- ¹ These forms of the locate command locate a column.
- ² These forms of the locate command locate a row.

Figure 163. Object List utility

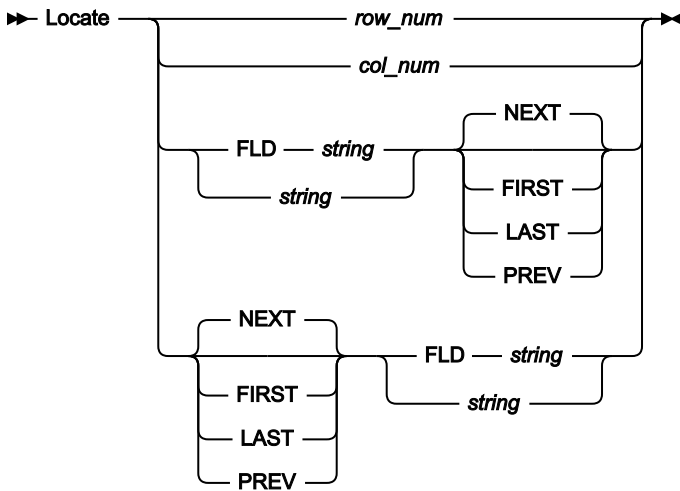

Figure 164. Print Browse

Locate — *line_number* →

string

A column name, or part of a column name

#n

A valid reference to a column.

pos

An integer representing a character position within a long (>50 characters) character or graphic column.

n

The sequence number of a row.

label

The label of a labeled row. *label* may be a user or system label.

row_num

The number of the row you want to locate. The row number is shown in the prefix area (TABL display mode), or in the upper right of the panel (SNGL display mode). For example, the following command locates row number 23:

```
LOCATE 23
```



Note: The row number is not shown when data is displayed with the Object List utility.

col_num

The Db2® column number (specified as #n) of the column you want to locate. For example, the following command locates column #12:

```
L #12
```

label

An existing user-assigned or editor-assigned label, identifying the row that you want to locate. The label must start with a period (.) followed by one to four alphabetic characters (no numeric or special characters). Labels starting with the letter “Z” indicate an editor-assigned label. For example:

```
LOCATE .HERE
```

locates a row marked with an existing label (.HERE)

```
L .ZLST
```

locates the last row.

FLD

Indicates to FM/Db2 that the string (*string*) following the FLD keyword is the name or part of the name of the column you want to locate. For example, the following command locates the column named #ITEMS:

```
L FLD #ITEMS
```

(In this case, if you omit the FLD parameter, the command `L #ITEMS` results in an error as FM/Db2 expects the # symbol to be followed by a numeric Db2® column number.)

string

The name (or part of a name) of the column you want to locate. The string can occur anywhere in the column name. For example, both of the following commands locate a column named “SALARY”:

```
L SAL
L ARY
```

NEXT

This is the default setting. In TABL display format, the search for *string* starts at (but excludes) the column currently displayed on the left of the screen and scans right. In SNGL display format, the search for *string* starts at (but excludes) the column currently displayed at the top of the screen and scans down. For example, both of the following commands locate the next column whose name contains the string “SAL”:

```
L NEXT SAL
L SAL NEXT
```

FIRST

In TABL display format, the search for *string* starts at (but excludes) the first column for the Db2® object and scans right. In SNGL display format, the search for *string* starts at (but excludes) the first column for the Db2® object and scans down. For example, both of the following commands locate the first column whose name contains the string “SAL”:

```
L FIRST SAL
L SAL FIRST
```

LAST

In TABL display format, the search for *string* starts at the last column for the Db2® object and scans left. In SNGL display format, the search for *string* starts at the last column for the Db2® object and scans up. For example, both of the following commands locate the last column whose name contains the string “SAL”:

```
L LAST SAL
L SAL LAST
```

PREV

In TABL display format, the search for *string* starts at the column currently displayed on the left of the screen and scans left. In SNGL display format, the search for *string* starts at the column currently displayed at the top of the screen and scans up. For example, both of the following commands locate the previous column whose name contains the string "SAL":

```
L PREV SAL
L SAL PREV
```

line_num

The line number you want positioned at the top of the display.

Availability

- [Table Browse panel on page 824](#)
- [Table Edit panel on page 826](#)
- [Table View panel on page 837](#)
- [Collections panel on page 471](#)
- [Columns panel on page 491](#)
- [Databases panel on page 593](#)
- [Database Request Modules panel on page 591](#)
- [Distinct Types panel on page 619](#)
- [Functions panel on page 684](#)
- [Indexes panel on page 697](#)
- [Application Packages panel on page 460](#)
- [Application Plans panel on page 463](#)
- [Schemas panel on page 779](#)
- [Stored Procedures panel on page 813](#)
- [Synonyms panel on page 815](#)
- [Tables, Views and Aliases panel on page 843](#)
- [Table Spaces panel on page 834](#)
- [Triggers panel on page 853](#)
- [Storage Group\(s\) panel on page 810](#)

Related tasks

- [Locating a row on page 138](#)
- [Locating a column on page 139](#)
- [Finding a string in a list of Db2 objects on page 308](#)
- [Locating a row or column in a list of Db2 objects on page 307](#)

LZERO primary command

The LZERO primary command toggles the global leading zero setting for the template.

If global leading zeros is set to `ON`, then the default leading zero setting for applicable numeric fields is `YES`, and a status indicator **LZERO** appears on the current panel.

If global leading zeros is set to `OFF`, then the default leading zero setting for applicable numeric fields is `NO`, and the status indicator is cleared.

Syntax

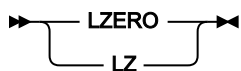

Availability

- [Column Selection/Edit panel on page 485](#)

NEW, NEWS primary command

The NEW (or NEWS) primary command displays a panel providing general information about the current FM/Db2 version and release.

Syntax



Availability

- All panels

NEXT primary command

Scrolls forward the number of rows specified.

Syntax

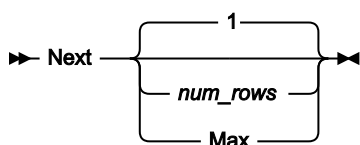

num_rows

Scroll forward *num_rows* rows. Valid range: 1–999999999.

Max

Scroll forward to make the last row visible.

Availability

- [Table Browse panel on page 824](#)
- [Table Edit panel on page 826](#)
- [Table View panel on page 837](#)

Related tasks

- [Viewing and changing Db2 data on page 119](#)
- [Scrolling on page 157](#)

NEXTRPT primary command

In advanced SELECT prototyping, if the cursor is positioned on a repeatable item within the syntax, the NEXTRPT primary command makes the next repeatable item current.

Syntax

▶ NEXTRPT ▶

Availability

[Advanced SELECT Prototyping panel on page 442](#)

Related tasks

[Using advanced SQL prototyping on page 391](#)

ORDER primary command

In the FM/Db2 editor, the ORDER command sets the display order for one or more columns in the TABL and SNGL display format.

Held columns are ordered in relation to other held columns. Unheld columns are ordered in relation to other unheld columns.

You can also specify a display order by typing a number in the SEQ column using the template editor.

Syntax

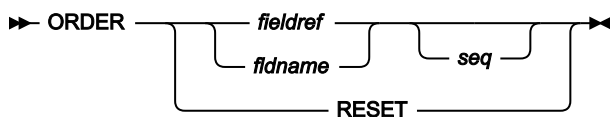

fieldref

A single field reference (for example, #1), a range (for example, #2-#5), or a list of single field references/ranges separated by spaces (for example, #1 #4 #6-#7). A single field specification is #n; n is a positive integer and cannot exceed the number of columns in the Db2® object or result table being processed.

fldname

The name of a column in the Db2® object or result table being processed. The column name can be preceded by a pound sign (#). Any value entered is translated to upper case if the "Translate Db2® object names" system's option is selected.

seq

A positive integer that indicates the relative order for the column among other ordered columns.

Examples

```
ORDER #9 #2
```

Displays columns #9 and #2 on the left.

```
ORDER #4 0
```

Removes #4 from the list of ordered columns.

```
ORDER #6 2
```

Displays column #6 as the second ordered column.

```
ORDER #5-#7 0
```

Removes columns #5 - #7 from the list of ordered columns.

Availability

- [Db2 Browse panel on page 595](#)
- [Db2 Edit panel on page 598](#)
- [Db2 View panel on page 613](#)
- Any panels displayed with the Object List utility (3.4)

Related tasks

- [Viewing and changing Db2 data on page 119](#)
- [Working with lists of Db2 objects on page 297](#)

PB primary command

The PB primary command lets you browse, and optionally purge, the print output from your current FM/Db2 editor session held in the print data set.

If you enter the PB primary command when you have not created any print output, FM/Db2 displays the message `Empty print data set.`

Syntax

▶▶ PB ▶▶

Availability

Available on all panels

Related tasks

- [Looking at the print output from your FM/Db2 session on page 326](#)

PLAN primary command

When you use the SQL prototyping, execution and analysis option (4), you can use the PLAN primary command:

- On the Plan Table Rows panel to switch panel format to show the plan name.
- On the Statement Table Rows panel to switch panel format to show the plan name.

Syntax

▶▶ PLAN ▶▶

Availability

[Plan Table Rows panel on page 725](#)

Related tasks

[Working with SQL statements on page 382](#)

PREFIX primary command

For TABL display format only, the PREFIX primary command sets the position and display state of the prefix area.

Syntax

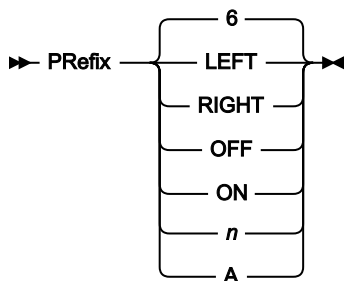

LEFT

Displays the prefix area on the left side.

RIGHT

Displays the prefix area on the right side.

OFF

Does not display the prefix area.

ON

Displays the prefix area at the position last set, with the display width last set.

n

Displays the prefix area at the position last set, with a display width of *n* digits. *n* must be in the range: 6–9.

A

Displays the prefix area at the position last set, with a display width of 6 digits or, if necessary, larger (up to 9 digits) in order to display the whole record number.

Availability

- [Table Edit panel on page 826](#)

Related tasks

- [Managing the prefix area on page 162](#)

PREVIOUS primary command

Scrolls backward the number of rows specified.

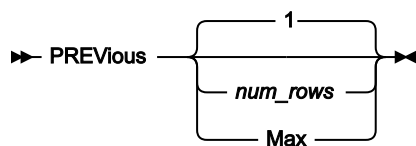
Syntax***num_rows***

Scroll backward *num_rows* rows. Valid range: 1–999999999.

Max

Scroll backward to make the first row visible.

Availability

- [Table Browse panel on page 824](#)
- [Table Edit panel on page 826](#)
- [Table View panel on page 837](#)

Related tasks

- [Viewing and changing Db2 data on page 119](#)
- [Scrolling on page 157](#)

PREVRPT primary command

In advanced SELECT prototyping, if the cursor is positioned on a repeatable item within the syntax, the PREVRPT primary command makes the previous repeatable item current.

Syntax

► PREVRPT ◄

Availability

[Advanced SELECT Prototyping panel on page 442](#)

Related tasks

[Using advanced SQL prototyping on page 391](#)

PRINT primary command

In Print Browse, the PRINT primary command transfers the contents of the print data set to a SYSOUT class.

You specify the print data set using the **PRINTDSN** entry field on the Set Print Processing Options panel.

The SYSOUT class is determined by one of the following (whichever is found to exist first):

- The class specified by SYSOUT=*c* in the **PRINTOUT** entry field on the Print Utility panel (unless this field contains a value other than SYSOUT=*c*)
- Your default TSO SYSOUT class (if defined)
- SYSOUT class A (if neither of the above apply)



Note: When you enter `PRINT` on the command line for any FM/Db2 panel other than the Print Browse panel, it is interpreted as the ISPF system command, PRINT, and records a snapshot of the physical screen image in the print data set.

Syntax

► PRINT ◄

Availability

Any Print Browse display panel

Related tasks

- [Looking at the print output from your FM/Db2 session on page 326](#)

PROTOCOL primary command

In the row selection criteria panel of the File Manager template editor, the PROTOCOL command changes the column name and, when displayed, the data type fields from editable to protected. Any column expression entered for a column is retained. You can also enter the PC prefix command against a column to achieve the same result. Use this command to protect a previously entered column expression from inadvertent changes.

Syntax

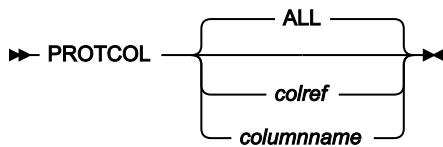

colref

A reference to a single column, for example, #4.

columnname

The name of a column in the Db2® object or result table being processed.

PROTOCOL with no parameters changes all column name fields and, when displayed, data type fields to protected.

PROTOCOL with either a column reference or column name changes the specified column name field and, when displayed, data type fields to protected.

Availability

- [Row Selection Criteria panel on page 767](#)

Related tasks

- [Row selection by column on page 83](#)

PURGE primary command

In Print Browse, the PURGE command purges the print output by clearing the print data set.

Syntax

```
►► PURGE ◄◄
```

Availability

A Print Browse display panel

Related tasks

- [Looking at the print output from your FM/Db2 session on page 326](#)

QUIT primary command

See [CANCEL primary command on page 873](#).

RCHANGE primary command

The RCHANGE primary command changes the next occurrence of the string or numeric value by repeating the previous CHANGE primary command.

Syntax

► RChange ◄

Availability

- [Table Edit panel on page 826](#)

Related tasks

- [Changing data with the CHANGE command on page 178](#)

RD primary command

The RD (*Record Dump*) primary command prints, for the number of rows specified, in dump format using the current display format (TABL or SNGL).

Syntax

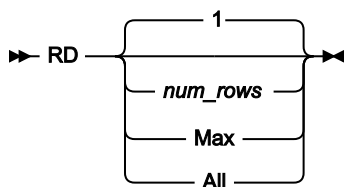

num_rows

Print *num_rows* rows, starting from the current row. Valid range: 1–999999999.

Max

Print all remaining rows, from the current row to the end of the Db2® object.

All

Print all rows in the Db2® object.

Availability

- [Table Browse panel on page 824](#)
- [Table Edit panel on page 826](#)
- [Table View panel on page 837](#)

Related tasks

- [Printing rows from a Db2 table on page 324](#)

REDIT primary command

When you issue the REDIT primary command from within an information panel for a referential integrity error, FM/Db2 displays an Edit session.

When you issue the REDIT primary command from within a File Manager/Db2 View or Edit editor session, FM/Db2 displays the Related tables panel listing information about the tables related to the table you are currently editing.

**Note:**

1. The REDIT primary command is not available in FM/Db2 Browse.
2. The REDIT command works with Db2® tables only. You cannot use the command with Db2® views.

Syntax

Figure 165. Syntax (when issued for a referential integrity error)

▶▶ REDIT ◀◀

Figure 166. Syntax (when issued from within a File Manager/Db2 editor session)

▶▶ REDIT  ◀◀

col_num

A Db2® column number (specified as #*n*).

Availability

- Within an information panel for a referential integrity error.
- From within a File Manager/Db2 editor session.

Related tasks

- [Starting an Edit session of a related table on page 191](#)
- [Listing related tables on page 189](#)

REFRESH primary command

The REFRESH primary command refreshes the list of Db2® subsystems on the Db2® Subsystem Selection menu.

Syntax

►► REFRESH ◄◄

Availability

[Db2 Subsystem Selection panel on page 607](#)

Related tasks

[Selecting the Db2 subsystem when more than one is available on page 30](#)

REFS primary command

The REFS primary command shows or hides the column number (as defined in the Db2® catalog) for each displayed column when in SNGL display format.

Syntax

►► REFS ◄◄

Availability

- [Table Browse panel on page 824](#)
- [Table Edit panel on page 826](#)
- [Table View panel on page 837](#)

Related tasks

- [Displaying the column number on page 164](#)

RESET primary command

In a File Manager/Db2 editor session, you use the RESET command to redisplay excluded rows, or to reset strings highlighted by the FIND command. You can also use the RESET command to reset pending prefix commands, or to remove labels from rows.

For basic SELECT prototyping, the RESET primary command clears previous information from the SELECT, WHERE, and ORDER BY clauses in the SELECT statement at the top of the Basic SELECT prototyping panel.

When you are viewing the Db2® utility options panels, the RESET primary command sets the values for each option back to the installation default.

Syntax

Figure 167. Standard

►► RESET ◄◄

Figure 168. FM/Db2 editor session

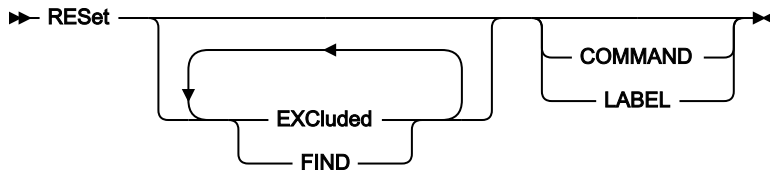

COMMAND

All pending prefix commands are reset.

EXCLuded

All excluded rows are redisplayed.

FIND

All strings highlighted by the FIND command are reset.

LABEL

All row labels are deleted.

Availability

- [Table View panel on page 837](#)
- [Table Browse panel on page 824](#)
- [Table Edit panel on page 826](#)
- [Basic SELECT Prototyping panel on page 465](#)

Related tasks

- [Viewing and changing Db2 data on page 119](#)
- [Using basic SQL prototyping on page 382](#)
- [Setting options for Db2 utilities on page 341](#)

RFIND primary command

The RFIND primary command repeats the search performed by the previous FIND primary command.

Syntax

►► RFind ◄◄

Availability

- [Table Browse panel on page 824](#)
- [Table Edit panel on page 826](#)
- [Table View panel on page 837](#)

Related tasks

- [Repeating the search on page 143](#)

RIGHT primary command

- In View or Edit:

In TABL display format, the RIGHT primary command scrolls to the right of your data. (You cannot use RIGHT in SNGL display format.)

The amount (number of panel columns) scrolled is determined by either an optional parameter or, if no parameter is entered, by the amount indicated in the **Scroll** field.

- When editing a template:

When you are editing a template, the RIGHT primary command:

- Scrolls the **Row Selection Criteria** field on the Column Selection/Edit panel (the cursor must be positioned on the field at the time you issue the RIGHT primary command)
- Toggles the display (on an 80-character screen) on the Row Selection Criteria panel between the **Column name** and **Data type(length)** details appearing (the cursor must not be positioned on a **Value** field at the time you issue the RIGHT primary command)

Syntax

Figure 169. View or Edit

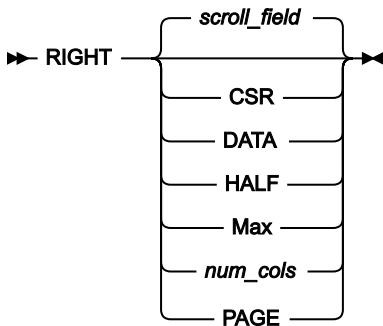

Figure 170. Template editing



scroll_field

Scroll right by the amount indicated in the **Scroll field**. This is the default value if no parameter is used.

CSR

Scroll right to the cursor position.

DATA

Scroll right one panel column less than a page of data.

HALF

Scroll right half a page of data.

Max

Scroll to the end of the row.

num_cols

Scroll right *num_cols* panel columns. Valid range: 1–9999.

PAGE

Scroll right one page of data.

Availability

- [Table Browse panel on page 824](#)
- [Table Edit panel on page 826](#)
- [Table View panel on page 837](#)
- [Column Selection/Edit panel on page 485](#)
- [Row Selection Criteria panel on page 767](#)

Related tasks

- [Scrolling on page 157](#)
- [Scrolling the Row Selection Criteria field on page 91](#)
- [Changing the display \(80-character screens only\) on page 88](#)

RP primary command

The RP (*Record Print*) primary command prints, for the number of rows specified, in character format using the current display format (TABL or SNGL).

Syntax

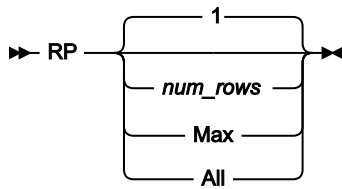

num_rows

Print *num_rows* rows, starting from the current row. Valid range: 1–999999999.

Max

Print all remaining rows, from the current row to the end of the Db2® object.

All

Print all rows in the Db2® object.

Availability

- [Table Browse panel on page 824](#)
- [Table Edit panel on page 826](#)
- [Table View panel on page 837](#)

Related tasks

- [Printing rows from a Db2 table on page 324](#)

RUNTEMP primary command

The RUNTEMP primary command runs the current function with the template changes you have made but does not save the changes. RUNTEMP is only available when you run a function that uses a template.

Syntax

▶▶ RUNTEMP ◀◀

Availability

- [Template Save panel on page 852](#)
- [Column Selection/Edit panel on page 485](#)

Related tasks

- [Viewing and changing Db2 data on page 119](#)
- [Printing the contents of a Db2 table on page 321](#)
- [Copying data from one Db2 object to another on page 241](#)

- [Copying data from a VSAM or QSAM file on page 246](#)
- [Copying data to a VSAM or QSAM file on page 274](#)
- [Populating a Db2 table with data on page 239](#)
- [LOAD utility on page 349](#)

SAVE primary command

In Edit, the SAVE primary command saves any uncommitted changes without ending the Edit session.

Syntax

► SAVE ◄

Availability

- [Table Edit panel on page 826](#)

Related tasks

- [Ending a File Manager/Db2 editor session on page 130](#)
- [Updating a primary key on page 194](#)

SAVEAS primary command

When you edit a template, the SAVEAS primary command displays the save panel where you can save the template as another name.

Syntax

► SAVEAS ◄

Availability

- [Column Selection/Edit panel on page 485](#)

Related tasks

- [Working with templates on page 72](#)

SHADOW primary command

The SHADOW command hides or shows shadow lines.



Note: Shadow lines represent rows that have been excluded from display by the EXCLUDE primary command.

Syntax

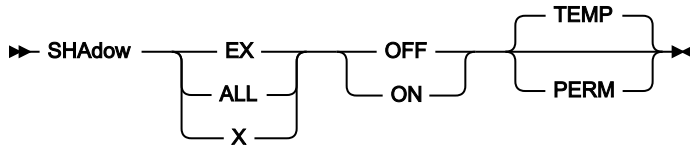

EX

Show or hide “excluded” rows shadow lines. This is the default setting.

ALL

Show or hide “excluded” rows shadow lines.

X

Same as EX.

OFF

Hide “excluded” rows shadow lines.

ON

Show “excluded” rows shadow lines.

TEMP

Shadow setting applies to the current FM/Db2 editor session only. This is the default setting.

PERM

Shadow setting is saved in your FM/Db2 profile, and applies to all FM/Db2 editor sessions until changed.

Availability

- [Table Browse panel on page 824](#)
- [Table Edit panel on page 826](#)
- [Table View panel on page 837](#)

Related tasks

- [Excluding rows on page 159](#)

SHOW primary command

The SHOW command restricts the list of Db2® subsystems shown on the Db2® Subsystem Selection menu.

Syntax

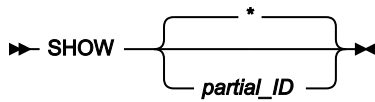

*

Show all Db2® subsystems.

partial_ID

The partial ID of a Db2® subsystem, starting or ending with an asterisk (*), or both. Shows all Db2® subsystems whose ID matches the partial ID specified.

Availability

- [Db2 Subsystem Selection panel on page 607](#)

Related tasks

- [Restricting the list of Db2 subsystems on page 34](#)

SHOW primary command

In the FM/Db2 editor, the SHOW command adds a hidden column to the data display. You can hide a column from display by using the HIDE editor primary command or by using the S prefix command in the template editor.

Syntax

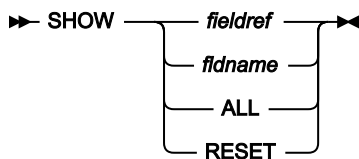

fieldref

A single field reference (for example, #1), a range (for example, #2-#5), or a list of single field references/ranges separated by spaces (for example, #1 #4 #6-#7). A single field specification is #n; n is a positive integer and cannot exceed the number of columns in the Db2® object or result table being processed.

fldname

The name of a column in the Db2® object or result table being processed. The column name can be preceded by a pound sign (#). Any value entered is translated to upper case if the "Translate Db2® object names" system's option is selected.

Examples

```
SHOW ALL
```

Shows all columns.

```
SHOW RESET
```

Shows all columns.

```
SHOW #4
```

Shows the data for column #4.

```
SHOW #7 #1
```

Shows the data for columns #1 and #7.

```
SHOW #2-#5
```

Shows the data for columns #2, #3, #4, and #5.

Availability

- [Db2 Browse panel on page 595](#)
- [Db2 Edit panel on page 598](#)
- [Db2 View panel on page 613](#)
- Any panels displayed with the Object List utility (3.4)

Related tasks

- [Viewing and changing Db2 data on page 119](#)
- [Working with lists of Db2 objects on page 297](#)

SHOWCOB primary command

The SHOWCOB command displays details showing which COBOL compiler is currently being used.

Syntax

```
►► SHOWCOB ◄◄
```

Availability

Available on all panels

Related tasks

- [Checking which COBOL compiler you're using on page 29](#)

SORT primary command

- In View or Edit, the SORT primary command changes the order of the data you are browsing or editing in TABL display format.

FM/Db2 sorts the data according to its hexadecimal representation using a hierarchy of keys, starting with the first specified column as the primary key, and subsequent specified columns as less significant keys. You specify the hierarchy left to right.

- When you use the Object List utility (3.4) to display a list of objects, you can sort a column in the current object list by issuing the SORT primary command with the cursor positioned on the column you want to sort.

Syntax

Figure 171. Syntax (View or Edit)

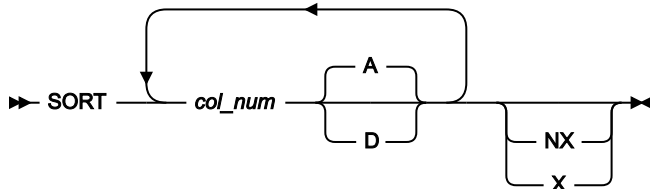

Figure 172. Syntax (Object List utility)

► SORT ◄

col_num

The Db2® column number (specified as #*n*) of a column to be used as the sort key. You can specify between 1 and 5 column numbers. Multiple column numbers must be separated by a blank.

A

Sort data in ascending sequence. This is the default sequence.

D

Sort data in descending sequence.

NX

Non-excluded rows only. Sorts rows as if any excluded rows did not exist.

X

Excluded rows only. Sorts excluded rows as if any non-excluded rows did not exist.

Availability

- [Db2 View panel on page 613](#)
- [Db2 Browse panel on page 595](#)

- [Db2 Edit panel on page 598](#)
- Any panels displayed with the Object List utility (3.4)

Related tasks

- [Viewing and changing Db2 data on page 119](#)
- [Working with lists of Db2 objects on page 297](#)

SQL primary command

The SQL primary command displays the SQL SELECT statement for the object you are processing. You can view the SELECT statement and save it in an ISPF data set for future reference.

When you enter the SQL command, the SELECT statement is presented in a standard ISPF EDIT panel. You can save the statement using the ISPF CREATE command. To do this:

1. On the command line, type `CREATE`.
2. In the prefix area of the top line of the SELECT statement, type `c9999`.
3. Press Enter.

You are asked to supply the data set and member name in which to save the SELECT statement. If the data set does not exist, you are asked to specify the allocation attributes to create it. You cannot use the attributes of the temporary data set displayed; you must provide the required attributes yourself.



Note: When you start an editor session from the function entry panel, the SELECT clause in the SQL statement includes every column of the table, even if you have edited the template and deselected one or more columns.

When you are working with SQL statements, any changes you make to the command in the ISPF Edit session are not preserved when you return to the prototyper.

Syntax

► SQL ◄

Availability

- [Table Browse panel on page 824](#)
- [Table Edit panel on page 826](#)
- [Table View panel on page 837](#)
- [Basic SELECT Prototyping panel on page 465](#)
- [Advanced SELECT Prototyping panel on page 442](#)
- [Enter, Execute and Explain SQL Statements panel on page 660](#)

Related tasks

- [Viewing and changing Db2 data on page 119](#)
- [Working with SQL statements on page 382](#)

SQLID primary command

The SQLID primary command allows you to change the SQLID to be used as part of the connection to Db2®.

Syntax

► SQLID *DB2_sqlid* ◄

DB2_sqlid

The required SQLID to be used as part of the connection to Db2®.

Availability

- The SQLID command can be issued on most FM/Db2 processing panels.

You cannot issue the command from:

- Pop-up panels
- Tutorial panels
- Panels displayed by ISPF. For example, the Audit log listing.

Related tasks

- [Specifying the SQLID on page 50](#)

TEDIT primary command

The TEDIT command displays the Column Selection/Edit panel from within a File Manager/Db2 editor session.

Syntax

► TEdit ◄

Availability

- [Table Edit panel on page 826](#)
- [Table Browse panel on page 824](#)
- [Table View panel on page 837](#)

Related tasks

- [Editing a template on page 81](#)

TOP primary command

The TOP primary command scrolls to the first page of data.

Syntax

▶▶ Top ▶▶

Availability

- [Table Browse panel on page 824](#)
- [Table Edit panel on page 826](#)
- [Table View panel on page 837](#)

Related tasks

- [Viewing and changing Db2 data on page 119](#)
- [Scrolling on page 157](#)

TP primary command

The TP primary command prints the current template.

Syntax

▶▶ TP ▶▶

Availability

- [Column Selection/Edit panel on page 485](#)

Related tasks

- [Printing a template on page 75](#)

TYPE primary command

The TYPE primary command shows or hides the data type (and, for non-numeric columns, the length of the column) for each displayed column when in SNGL display format.

Syntax

▶▶ TYpe ▶▶

Availability

- [Table Browse panel on page 824](#)
- [Table Edit panel on page 826](#)
- [Table View panel on page 837](#)

Related tasks

- [Displaying the data type on page 164](#)

UNDO primary command

Use the UNDO primary command to undo the last set of changes you made to the SELECT statement at the top of the Basic SELECT prototyping panel.

Syntax

▶← UNDO ↔

Availability

[Basic SELECT Prototyping panel on page 465](#)

Related tasks

[Using basic SQL prototyping on page 382](#)

UP primary command

The UP primary command scrolls up (backward) through your data.

The amount (number of rows or columns) scrolled is determined by either an optional parameter or, if no parameter is entered, by the amount indicated in the **Scroll** field.

Syntax

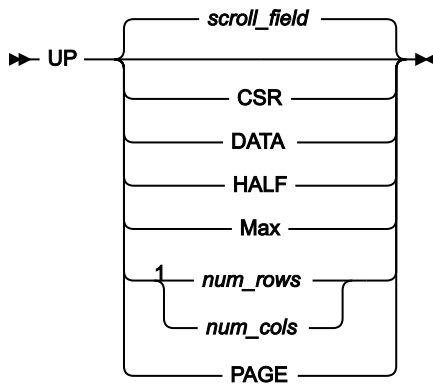

Notes:

¹ *num_rows* available in TABL display format; *num_cols* available in SNGL display format.

scroll_field

Scroll up by the amount indicated in the **Scroll field**. This is the default value if no parameter is used.

CSR

Scroll up to the cursor position.

DATA

Scroll up one row (TABL) or column (SNGL) less than a page of data.

HALF

Scroll up half a page of data.

Max

Scroll to top of the table. This has the same effect as TOP command.

num_rows

Scroll up *num_rows* rows. Valid range: 1–9999. Available in TABL display format.

num_cols

Scroll up *num_cols* columns. Valid range: 1–9999. Available in SNGL display format.

PAGE

Scroll up one page of data.

Availability

- [Table Browse panel on page 824](#)
- [Table Edit panel on page 826](#)
- [Table View panel on page 837](#)
- [Enter, Execute and Explain SQL Statements panel on page 660](#)

Related tasks

- [Viewing and changing Db2 data on page 119](#)
- [Scrolling on page 157](#)
- [Entering, executing, and explaining SQL statements on page 416](#)

VER primary command

The VER primary command displays the current FM/Db2 version number and the PTF number for each FM/Db2 component in a window. The window also indicates whether or not FM/Db2 is APF-authorized.

Syntax

▶ VER ◀

Availability

Available on all panels

Related tasks

[Checking your FM/Db2 version on page 28](#)

VIEW primary command

The VIEW primary command starts a new FM/Db2 View editor session.

Syntax

▶ VIEW { *current_object_owner* . *current_object_name* } [{ *current_object_owner* . *new_object_owner* } . { *new_object_name* }] ◀

current_object_owner

The name of the owner of the object in the current FM/Db2 editor session.

current_object_name

The name of the object in the current FM/Db2 editor session.

new_object_owner

The name of the owner of the object to be pre-filled in the entry panel for the new FM/Db2 editor session.

new_object_name

The name of the object to be pre-filled in the entry panel for the new FM/Db2 editor session.

Availability

- [Table Browse panel on page 824](#)
- [Table Edit panel on page 826](#)
- [Table View panel on page 837](#)

Related tasks

- [Viewing and changing Db2 data on page 119](#)

WIDTH primary command

The WIDTH command sets the display width for one or more columns in TABL display format. You can also specify a display width by specifying a value in the output width field on the column attributes panel in the template editor; use the E prefix command to access the column attributes panel.

Syntax

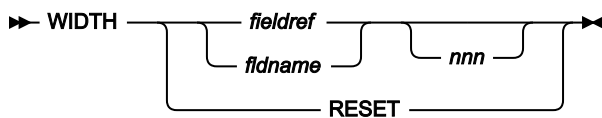

fieldref

A single field reference (for example, #1), a range (for example, #2-#5), or a list of single field references/ranges separated by spaces (for example, #1 #4 #6-#7). A single field specification is #*n*; *n* is a positive integer and cannot exceed the number of columns in the Db2® object or result table being processed.

fldname

The name of a column in the Db2® object or result table being processed. The column name can be preceded by a pound sign (#). Any value entered is translated to upper case if the "Translate Db2® object names" system's option is selected.

nnn

A positive integer that represents the desired display width for the fields. If this parameter is omitted, the display width is reset to the default value. The minimum value of *nnn* is 6. The maximum value of *nnn* depends on the data type:

Table 26. Maximum value of parameter *nnn* for different data types

Data Type	Maximum value of <i>nnn</i>
DATE, TIME, or BINARY	30
binary floating point	35
TIMESTAMP	42
DECIMAL	45

Table 26. Maximum value of parameter *nnn* for different data types (continued)

Data Type	Maximum value of <i>nnn</i>
decimal floating point	52
ZONED TIMESTAMP	165
Other data types	If the value of the display length is less than 20, the maximum value of <i>nnn</i> is 30. Otherwise, the maximum value of <i>nnn</i> is the value of the display length plus 10.

Examples

```
WIDTH #9 30
```

Sets the display width for column 9 to 30 bytes.

```
WIDTH #5-#7 20
```

Sets the display width for columns #5 - #7 to 20 bytes.

Availability

- [Db2 Browse panel on page 595](#)
- [Db2 Edit panel on page 598](#)
- [Db2 View panel on page 613](#)
- Any panels displayed with the Object List utility (3.4)

Related tasks

- [Viewing and changing Db2 data on page 119](#)
- [Working with lists of Db2 objects on page 297](#)

XMLBRWS primary command

The XMLBRWS primary command starts a new ISPF editor session, in browse mode, for an XML document. The Db2® object being processed must contain an XML column.

The command is cursor sensitive. Type the command, move the cursor to the XML column of interest and press Enter. An ISPF editor session, in browse mode, for the XML column at the cursor position is displayed.

The command can also be issued without cursor positioning, in which case parameters may be required:

Syntax

Figure 173. In SNGL display format

```
► XMLBRWS         ►
          └─ #n ─┘
```

Figure 174. In TABL display format

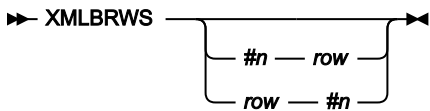

#n

A valid reference. The data type for #n must be XML. #n can be omitted when the Db2® object contains only one XML column. If #n is omitted when the Db2® object contains multiple XML columns, FM/Db2 searches for the first selected XML column, starting at #1.

row

A number that identifies a row in the editor session. A row number should not be specified when the command is issued in SNGL mode, the command applies to the currently displayed row.

Availability

- [Table Browse panel on page 824](#)
- [Table Edit panel on page 826](#)
- [Table View panel on page 837](#)

XMLEDIT primary command

The XMLEDIT primary command starts a new ISPF editor session, in edit mode, for an XML document. The Db2® object being processed must contain an XML column.

The command is cursor sensitive. Type the command, move the cursor to the XML column of interest and press Enter. An ISPF editor session, in edit mode, for the XML column at the cursor position is displayed.



Note: Do not use the SAVE command in an XMLEDIT session because the XML data will not be updated in the Db2 table.

The command can also be issued without cursor positioning, in which case parameters may be required:

Syntax

Figure 175. In SNGL display format



Figure 176. In TABL display format

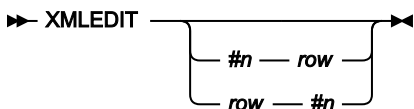

#n

A valid reference. The data type for *#n* must be XML. *#n* can be omitted when the Db2® object contains only one XML column. If *#n* is omitted when the Db2® object contains multiple XML columns, FM/Db2 searches for the first selected XML column, starting at #1.

row

A number that identifies a row in the editor session. A row number should not be specified when the command is issued in SNGL mode, the command applies to the currently displayed row.

Availability

- [Table Edit panel on page 826](#)

XMMLLEN primary command

The XMMLLEN primary command displays the length for an XML document. The Db2® object being processed must contain an XML column.

The command is cursor sensitive. Type the command, move the cursor to the XML column of interest and press Enter. The length for the XML document at the cursor position is displayed.

The command can also be issued without cursor positioning, in which case parameters may be required:

Syntax

Figure 177. In SNGL display format

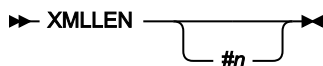
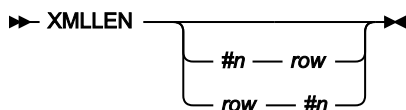

Figure 178. In TABL display format

**#n**

A valid reference. The data type for *#n* must be XML. *#n* can be omitted when the Db2® object contains only one XML column. If *#n* is omitted when the Db2® object contains multiple XML columns, FM/Db2 searches for the first selected XML column, starting at #1.

row

A number that identifies a row in the editor session. A row number should not be specified when the command is issued in SNGL mode, the command applies to the currently displayed row.

Availability

- [Table Browse panel on page 824](#)
- [Table Edit panel on page 826](#)
- [Table View panel on page 837](#)

XMLVIEW primary command

The XMLVIEW primary command starts a new ISPF editor session, in view mode, for an XML document. The Db2® object being processed must contain an XML column.

The command is cursor sensitive. Type the command, move the cursor to the XML column of interest and press Enter. An ISPF editor session, in view mode, for the XML column at the cursor position is displayed.

The command can also be issued without cursor positioning, in which case parameters may be required:

Syntax

Figure 179. In SNGL display format

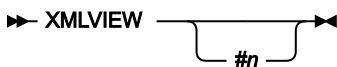
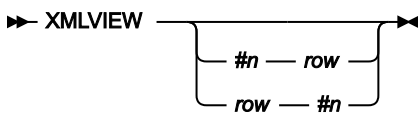

Figure 180. In TABL display format



#n

A valid reference. The data type for #n must be XML. #n can be omitted when the Db2® object contains only one XML column. If #n is omitted when the Db2® object contains multiple XML columns, FM/Db2 searches for the first selected XML column, starting at #1.

row

A number that identifies a row in the editor session. A row number should not be specified when the command is issued in SNGL mode, the command applies to the currently displayed row.

Availability

- [Table Edit panel on page 826](#)
- [Table View panel on page 837](#)

ZOOM primary command

In TABL display format, the ZOOM command zooms in on the row selected by the cursor, or the top row displayed if the cursor is not positioned on a row.

In SNGL display format, the ZOOM command shows the current row. If some columns have been deselected in the template, these columns are now shown.

Syntax

►► ZOOM ◄◄

Availability

- [Table Browse panel on page 824](#)
- [Table Edit panel on page 826](#)
- [Table View panel on page 837](#)

Related tasks

- [Zooming in to see all of a row on page 155](#)

Chapter 19. FM/Db2 functions

This chapter contains information about the FM/Db2 functions that can be executed in batch jobs.

The preferred method for generating the FM/Db2 batch utility control statements is to allow FM/Db2 to generate the required statements.

The syntax diagrams and keyword descriptions in this section are provided for reference only.

How to use this reference chapter

This chapter lists the FM/Db2 batch functions in alphabetical order.

The following subsections are supplied, where relevant, for each function:

Purpose

A short summary of what you can do with the function.

Usage notes

A more detailed explanation of how to use the function.

Syntax

A syntax diagram, followed by a parameter list. The parameter list describes the parameter, and shows (where appropriate) its default and other possible values. If you specify parameters that are not relevant to the function, File Manager ignores them. If you specify the same parameter more than once, File Manager uses the first value that you specify.

Batch example

A listing of a sample batch job.

Return codes

Lists the return codes that are specific to the function.

Related functions

Other functions that are related in some way (for example, the export and import functions can be used to transfer data between Db2® systems)

General tips about performance when you use File Manager functions

The following tips are provided as a guide to improving performance when using File Manager functions:

Use the FASTREXX subset of REXX

If a user PROC is required, it is strongly recommended that, rather than the full REXX language, the FASTREXX subset of REXX is used. File Manager provides a set of external REXX functions designed to allow many common tasks to be performed within the FASTREXX subset. See File Manager User's Guide and Reference Chapter 14, "Enhancing File Manager processing" for a discussion of FASTREXX.

Template and copybook processing

The utilities DBX and DBI allow a copybook or template to be specified for the target/input data set, respectively. The utilities DBX, DBI, DBC, D2G, and DBP optionally require a Db2® template that describes the Db2® object to be processed. When using these functions, consider the following performance-related points:

- File Manager can be most efficient if a template is used instead of a copybook. If a copybook must be used, specify the language of the copybook. (LANG=COBOL, LANG=HLASM, or LANG=PLI, instead of the default LANG=AUTO) for best performance.
- Template expressions should be written, if at all possible, using expressions suitable for File Manager internal processing. For more details, see File Manager User's Guide and Reference "Improving performance using internal expression processing".

FM/Db2 batch functions

This section describes the FM/Db2 functions that you can use in batch jobs. For more information about using these functions, see [Populating a Db2 table with data on page 239](#), [Copying data on page 241](#), and [Printing on page 321](#).

BATSQL (Batch SQL) batch command

Purpose

To run an SQL statement (delete, insert, or update) that might be issued directly. The number of rows that might be changed by the statement is so large that lock escalation on the target Db2® table is an issue. To avoid lock escalation problems, a three-stage process is used to run the statement:

1. An SQL select statement is generated. The result table for this statement includes all of the rows that are subject to delete, insert, or update.
2. Rows from the result table are retrieved and the requested operation (delete, insert, or update) is applied to each row. Rows can be retrieved either one-at-a-time, or in a rowset (more than one row is retrieved at once).
3. After the stipulated number of rows are processed, a Db2® commit is issued to release any locks currently held.

Usage

The FM/Db2 batch SQL utility can take these actions:

- Delete rows from a specified table. Potentially all rows might be deleted if no WHERE clause is specified.
- Update rows in a specified table. Potentially all rows might be updated if no WHERE clause is specified.
- Insert rows into a specified table, by using the result table from a full select to generate the rows to be inserted.
- Issue Db2® commits after a specified number of changes

The BATSQL is a batch-only function, there is no equivalent full-screen option. The BATSQL function runs a **single** SQL DELETE, INSERT, or UPDATE operation.

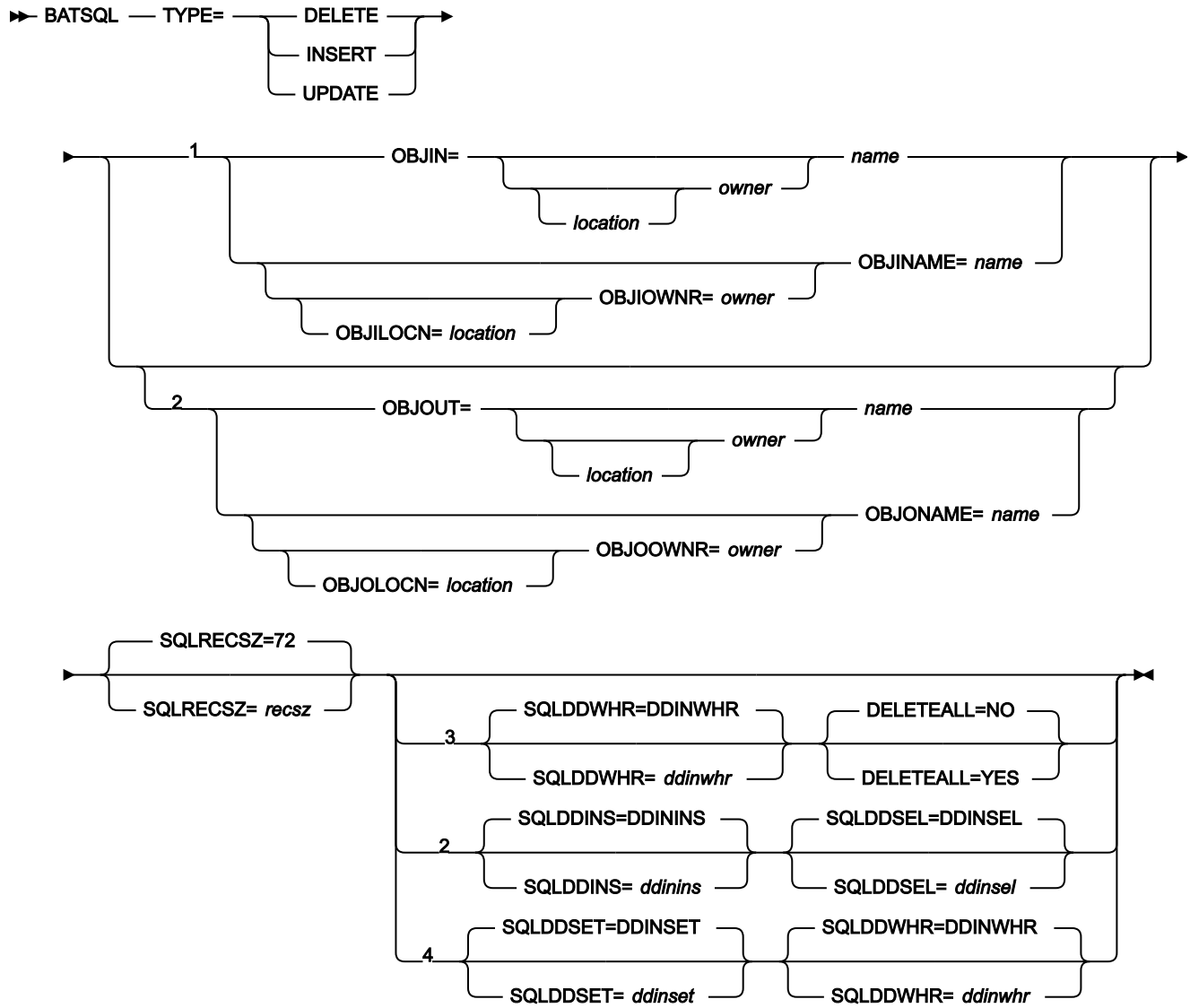

Notes:

- 1 TYPE=DELETE, UPDATE
- 2 TYPE=INSERT
- 3 TYPE=DELETE
- 4 TYPE=UPDATE

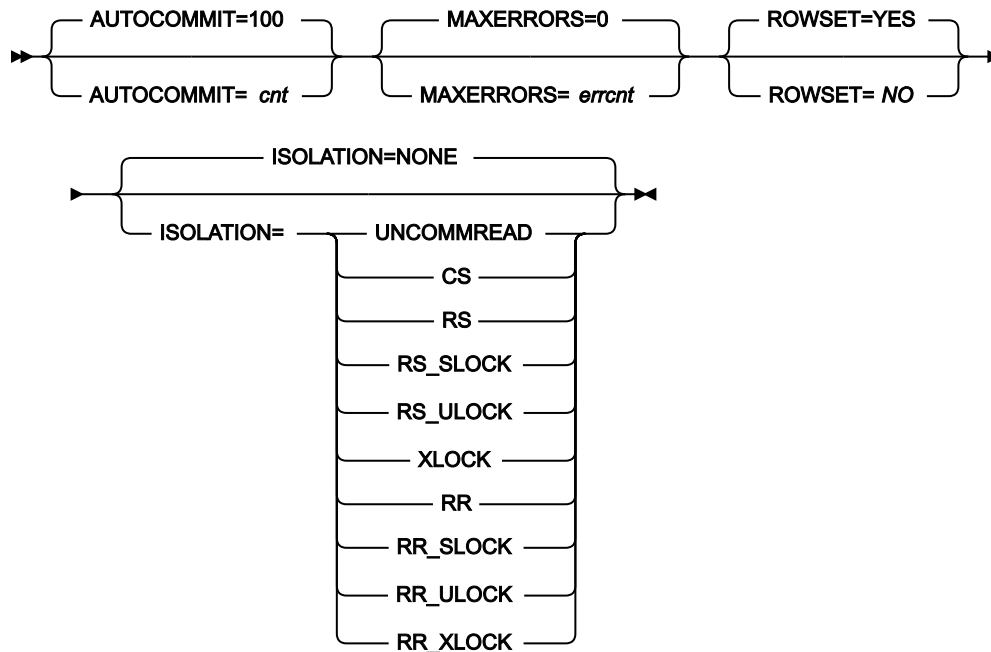
**AUTOCOMMIT=*cnt***

The number of successful operations that are processed before an automatic Db2® commit is issued. A value of zero indicates that no Db2® commits are issued until all rows are processed. Valid values are 0 - 2147483647.

The Db2® cursor that is used to read rows from the result table is declared 'WITH HOLD', so the Db2® commit does not close the cursor. Any locks that are associated with change activities are removed by the Db2® commit.

ISOLATION=*value*

An optional isolation specification to be included when the cursor that accesses the result table is declared. The default is NONE.

See the description of 'isolation clause' in the SQL Reference manual, 'SELECT' statement for a description of the values that can be specified.

UNCOMMREAD (UR) can be specified for TYPE=DELETE, UPDATE but is ignored and converted to CS.

MAXERRORS=*errcnt*

The maximum number of errors that can occur before a Db2® rollback is issued and function processing is terminated. When a row is processed, any negative SQLCODE is considered to be an error, and the error count is incremented by 1. When a rowset is processed, any negative SQLCODE is considered to be an error, and the error count is incremented by the number of rows in the current rowset. Valid values are 0 - 2147483647.

DELETEALL=<YES|NO>

A specification for delete processing, indicating that the intention is to delete all rows from the table. For TYPE=DELETE processing without a where clause, you must specify DELETEALL=YES.

This option is a safety feature, since specifying a delete without a where clause attempts to delete all rows from the table.

OBJIN=*location.owner.name*

Specifies three items:

- The optional name of the Db2® remote server (*location*) where the object is located.
- The optional name of the owner of the object (*owner*).
- The object name (*name*) to be processed.

When location is not specified, the current (local) Db2® server is used. When the owner is not specified, the object name is qualified with the current SQLID.

Use OBJIN when the fully qualified name fits on a single line in the JCL deck. The last usable column is column 71. When the fully qualified name does not fit on a single line in the JCL deck, use one or more of the OBJILOCN, OBJIOWNR, OBJINAME keywords to specify the object.

OBJILOCN=*location*

The optional name of the Db2® remote server (*location*) where the object is located. See [Specifying a Db2 object name on page 999](#).

OBJIOWNR=*owner*

The optional name of the owner of the object (*owner*) to be processed. See [Specifying a Db2 object name on page 999](#).

OBJINAME=*name*

The object name (*name*) for the object to be processed. See [Specifying a Db2 object name on page 999](#).



Note: Specify OBJIN, OBJILOCN, OBJIOWNR, and OBJINAME for TYPE=DELETE and TYPE=UPDATE.

ROWSET=<YES|NO>

A specification that indicates whether FM/Db2 should use rowset processing when it fetches rows, and possibly when it deletes and updates rows.

YES

Rowset processing should be used. The number of rows in each rowset is the same as the value specified for AUTOCOMMIT. If the AUTOCOMMIT keyword is omitted, the rowset size is the default (100 rows). Valid rowset sizes are 2 - 10000. When the AUTOCOMMIT value is outside this range, single-row processing is automatically selected.

NO

Use single-row processing.

OBJOUT=location.owner.name

Specifies three items:

- The optional name of the Db2® remote server (*location*) where the target object is located.
- The optional name of the owner of the target object (*owner*)
- The target object name (*name*) to be processed.

When location is not specified, the current (local) Db2® server is used. When the owner is not specified, the target object name is qualified with the current SQLID.

Use OBJOUT when the fully qualified name fits on a single line in the JCL deck. The last usable column is column 71. When the fully qualified name does not fit on a single line in the JCL deck, use one or more of the OBJILOCN, OBJIOWNR, OBJINAME keywords to specify the target object.

OBJLOCN=location

The optional name of the Db2® remote server (*location*) where the target object is located. See [Specifying a Db2 object name on page 999](#).

OBJOOWNR=owner

The optional name of the owner of the target object (*owner*) to be processed. See [Specifying a Db2 object name on page 999](#).

OBJONAME=name

The object name (*name*) for the target object to be processed. See [Specifying a Db2 object name on page 999](#).



Note: Specify OBJOUT, OBJLOCN, OBJOOWNR, and OBJONAME for TYPE=INSERT.

SQLDDWHR=ddinwhr (TYPE=DELETE, UPDATE)

The optional DD name that refers to a valid SQL where clause.

If this keyword is omitted, the where clause is assumed to be specified with DD DDINWHR.

For TYPE=DELETE, you can specify a null where clause, however you must also include the keyword DELETEALL=YES to process the delete statement.

SQLDDSET=ddinset (TYPE=UPDATE)

The optional DD name that refers to a valid SQL set clause (for TYPE=UPDATE only).

If this keyword is omitted, the set clause is assumed to be specified with DD DDINSET.

A SET clause must be specified.

SQLDDINS=*ddinins* (TYPE=INSERT)

The optional DD name that refers to a valid column list appropriate for an SQL insert statement, for example:

```
INSERT INTO <object> (column name1, column name2, ..)
```

If this keyword is omitted, the column list is assumed to be specified by using DD DDININS.

A list of column names is optional. If a list of column names is not specified, the result table from the select statement (specified by using SQLDDSEL) ought to have the same number of columns as the number of columns in the target table. Every column name in the list must be a column name of the target table.

SQLDDSEL=*ddinsel* (TYPE=INSERT)

The optional DD name that refers to a select statement that specifies the result table for the rows to be inserted into the target object.

If this keyword is omitted, the select statement is assumed to be specified with DD DDINSEL. A select statement that identifies the rows to be inserted, is required.

SQLRECSZ=*recsz*

The optional record size for all input data sets. The default is 72. When the SQL clauses are specified in-line in the JCL deck, do not specify a value greater than 72. Valid values are 40 - 32760.

Example**Hints and tips**

Rowset processing is automatically selected when an AUTOCOMMIT value of 2 - 10000 is specified.

For DELETE, INSERT and UPDATE processing, FM/Db2 fetches the rowset number of rows in a single fetch. For DELETE and UPDATE processing only, FM/Db2 attempts to delete or update rowset number of rows by using a single SQL statement.

For insert, each row is always inserted by using a single-row INSERT statement.

A large region size can be required when using rowset processing and a large rowset size. FM/Db2 needs sufficient storage to store the data for the specified rowset number of rows.

For delete and update processing that uses rowsets, it is possible that the delete or update operation for the rowset fails. When this failure occurs FM/Db2 tries the delete or update operation again, for every row of the rowset, using single-row processing. The error that is encountered for the rowset delete or update does not increment the error counter, however any error against a single-row delete or update does increment the error counter.

Example**Examples**

The examples refer to these table definitions:

```
CREATE TABLE RFM0681A."Names"
```



```

("Name_Identifier" INTEGER NOT NULL
,"Last_Name"      VARCHAR(16) NOT NULL
,"First_Name"     VARCHAR(16) NOT NULL
,"Second_Name"    VARCHAR(16) NOT NULL
,"Sex"            CHAR(1)      NOT NULL
,"Date_Of_Birth"  DATE         NOT NULL
);

CREATE TABLE RFM0681B."Names"
("Name_Identifier" INTEGER NOT NULL
,"Date_Of_Birth"   DATE
,"Sex"             CHAR(1)
,"First_Name"      VARCHAR(16)
,"Second_Name"     VARCHAR(16)
,"Last_Name"       VARCHAR(16)
);

```

Example 1

Delete all rows from the table that do not have a valid sex ('F' or 'M'). Issue a Db2® commit after every 50 successful delete operations. Stop if there are any errors.

```

//FMNDB2 EXEC PGM=FMNDB2,PARM=('SSID=DFXX,SQID=XXXXXXX')
//SYSPRINT DD SYSOUT=*
//FMNTSPRT DD SYSOUT=*
//DDINWHR DD *
WHERE ("Sex" <> 'M'
      AND "Sex" <> 'F')
/*
//SYSIN DD *
$$$FILEM BATSQI TYPE=DELETE,
$$$FILEM OBJIN=RFM0681A."Names",
$$$FILEM AUTOCOMMIT=50,
$$$FILEM MAXERRORS=1

```

Example 2

Update all rows from the table that have:

- A surname of 'Smith'
- A sex of 'm'

Change these rows to have:

- A surname of 'SMITH'
- A given name of 'JAMES'
- No second name
- A sex of 'M'

Issue a Db2® commit after every 100 successful update operations. Stop if there are more than 10 errors.

```

//FMNDB2 EXEC PGM=FMNDB2,PARM=('SSID=DFXX,SQID=XXXXXXX')

```

```

//SYSPRINT DD SYSOUT=*
//FMNTSPRT DD SYSOUT=*
//DDINSET DD *
SET ("Last_Name", "First_Name", "Second_Name", "Sex") =
    ('SMITH', 'JAMES', '', 'M')
/*
//DDINWHR DD *
WHERE "Last_Name" = 'Smith'
    AND "Sex" = 'm'
/*
//SYSIN DD *
$$$FILEM BATSQI TYPE=UPDATE,
$$$FILEM OBJIN=RFM0681A."Names",
$$$FILEM AUTOCOMMIT=100,
$$$FILEM MAXERRORS=10
/*

```

Example 3

Insert rows into RFM0681B."Names", using a select against RFM0681A."Names" to produce a result table.

Only insert rows when the "Name_Identifier" value is less than or equal to 100,000.

```

//FMNDB2 EXEC PGM=FMNDB2,PARM=('SSID=DFXX,SQID=XXXXXXX')
//SYSPRINT DD SYSOUT=*
//FMNTSPRT DD SYSOUT=*
//DDININS DD *
(
    "First_Name",
    "Second_Name",
    "Last_Name",
    "Sex",
    "Date_Of_Birth",
    "Name_Identifier"
)
/*
//DDINSEL DD *
SELECT
    "First_Name",
    "Second_Name",
    "Last_Name",
    "Sex",
    "Date_Of_Birth",
    "Name_Identifier"
FROM RFM0681A."Names"
WHERE "Name_Identifier" <= 100000
/*
//SYSIN DD *
$$$FILEM BATSQI TYPE=INSERT,
$$$FILEM OBJOUT=RFM0681B."Names",
$$$FILEM AUTOCOMMIT=50,
$$$FILEM MAXERRORS=100
/*

```

DBC (Copy) batch command

Purpose

To copy data from one Db2® object to another Db2® object. Both objects need to be accessible from the currently connected Db2® system.

Usage

The FM/Db2 copy utility can:

- Optionally delete all rows from the target table prior to copying any data.
- Select the rows and columns to be copied.
- Limit the total number of rows to be copied.
- Reformat data into one or more new columns.
- Initialize columns with a new value or pattern.

The FM/Db2 copy utility takes no account of any referential integrity relationships defined on the source Db2® object.

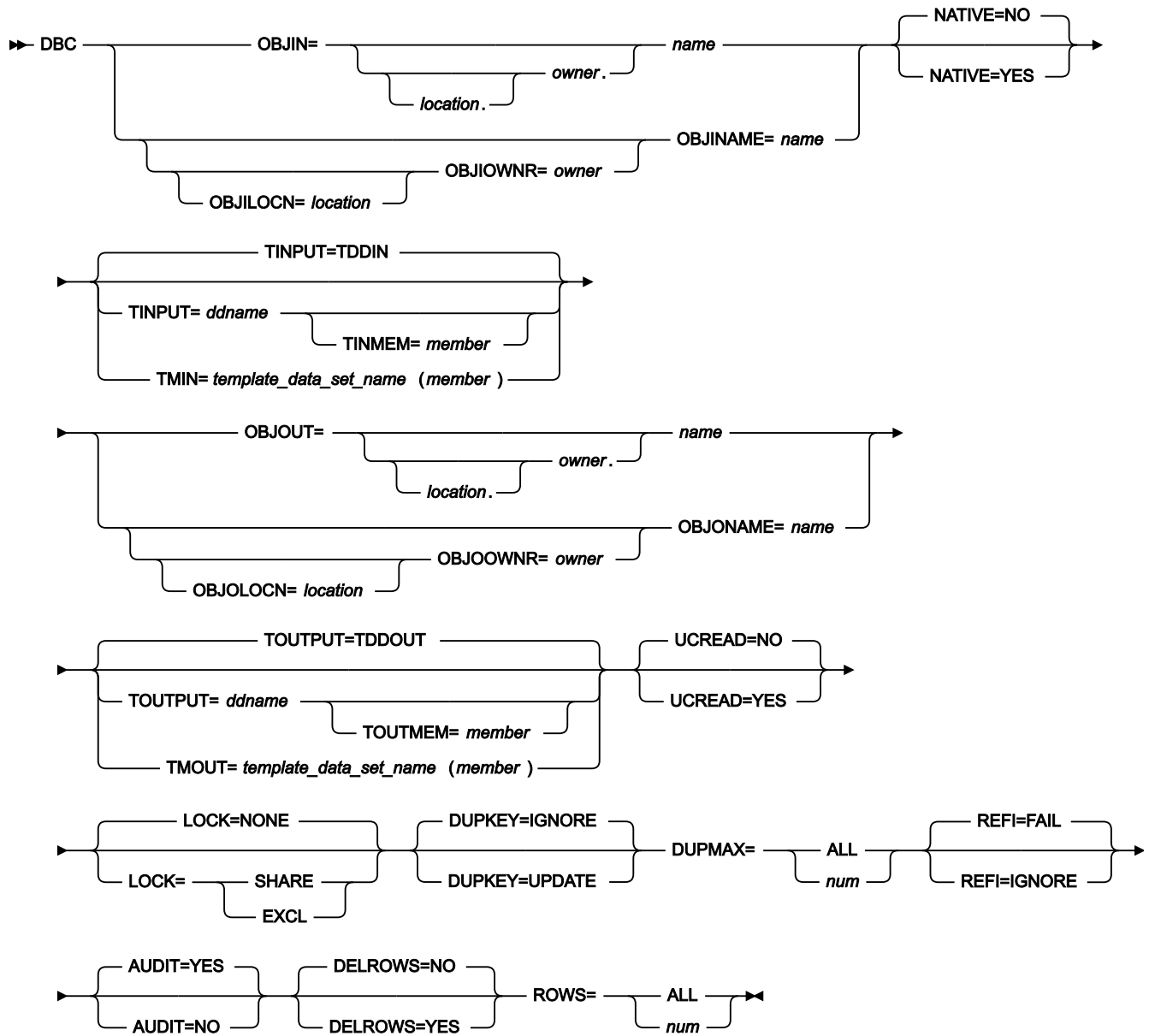

OBJIN=location.owner.name

The optional name of the Db2® remote server (*location*) where the source object is located; the optional name of the owner of the source object (*owner*) and the source object name (*name*) to be copied.

When *location* is not specified the current (local) Db2® server is used. When the *owner* is not specified the object name is qualified using the current SQLID. When FM/Db2 generates the utility control statements, the *owner* value is non-blank.

OBJIN should be used when the fully qualified name fits on a single line in the JCL deck. The last usable column is column 71. When the fully qualified name does not fit on a single line in the JCL deck, use one or more of the OBJILOCN, OBJIOWNR, OBJINAME keywords to specify the object.

OBJILOCN=*location*

The optional name of the Db2® remote server (*location*) where the source object is located. See [Specifying a Db2 object name on page 999](#).

OBJIOWNER=*owner*

The optional name of the owner of the source object (*owner*) to be copied. See [Specifying a Db2 object name on page 999](#).

OBJINAME=*name*

The object name (*name*) for the source object to be copied. See [Specifying a Db2 object name on page 999](#).

NATIVE

Specifies whether FM/Db2 should process Unicode encoded data natively when copying data between two Unicode encoded tables. This option can be ignored if the default processing of Unicode data is desired; that is, Unicode data is potentially substituted with error characters when copying data between Unicode tables.

YES

Process Unicode data natively.

NO

Do not Process Unicode data natively. This is the default.

TINPUT=*ddname*

Defines a reference to a DD statement for the data sets which contain the Db2® template that describes the source Db2® object to be copied. If you specify a concatenated DD, then you must provide the member name, *member*, via the TINMEM keyword. See [Specifying the template for a Db2 object on page 1000](#).

TINMEM=*member*

The name of the template member in the dataset(s) identified by the TINPUT parameter, if it has not been specified on the DD statement. This parameter must not be specified if the TMIN parameter is specified. See [Specifying the template for a Db2 object on page 1000](#).

TMIN=*template_data_set_name(member)*

The PDS (*template_data_set_name*) and member name (*member*) of the File Manager Db2® template that describes the source Db2® object to be copied. See [Specifying the template for a Db2 object on page 1000](#).

OBJOUT=*location.owner.name*

The optional name of the Db2® remote server (*location*) where the target object is located; the optional name of the owner of the target object (*owner*) and the target object name (*name*) to be copied.

When location is not specified the current (local) Db2® server is used. When the owner is not specified the object name is qualified using the current SQLID. When FM/Db2 generates the utility control statements, the owner value is non-blank.

OBJOUT should be used when the fully qualified name fits on a single line in the JCL deck. The last usable column is column 71. When the fully qualified name does not fit on a single line in the JCL deck, use one or more of the OBJLOCN, OBJOOWNER, OBJONAME keywords to specify the object.

OBJLOCN=*location*

The optional name of the Db2® remote server (*location*) where the target object is located. See [Specifying a Db2 object name on page 999](#).

OBJOOWNER=*owner*

The optional name of the owner of the target object (*owner*) to be copied. See [Specifying a Db2 object name on page 999](#).

OBJONAME=*name*

The object name (*name*) for the target object to be copied. See [Specifying a Db2 object name on page 999](#).

TOUTPUT=*ddname*

Defines a reference to a DD statement for the data sets which contain the Db2® template that describes the target Db2® object. If you specify a concatenated DD, then you must provide the member name, *member*, via the TOUTMEM keyword. See [Specifying the template for a Db2 object on page 1000](#).

TOUTMEM=*member*

The name of the template member in the dataset(s) identified by the TOUTPUT parameter, if it has not been specified on the DD statement. This parameter must not be specified if the TMOUT parameter is specified. See [Specifying the template for a Db2 object on page 1000](#).

TMOUT=*template_data_set_name(member)*

The PDS (*template_data_set_name*) and member name (*member*) of the FM/Db2 template that describes the target Db2® object. See [Specifying the template for a Db2 object on page 1000](#).

UCREAD

Specifies whether FM/Db2 should use uncommitted read, when accessing the source object:

YES

Uncommitted read is used. In this case, Db2® takes no locks when accessing the data in the source table, and it is possible that the data for a row changes after being read by FM/Db2, resulting in data inconsistencies.

NO

Uncommitted read is not used. This is the default.

LOCK

Specifies whether the source table should be locked, prior to copying data. The possible options are:

NONE

The default and recommended value. Any locks taken by Db2® depend on Db2® installation options, and options specified when the source object was created, unless negated by UCREAD=YES.

SHARE

FM/Db2 locks the source object in SHARE mode before copying data. This option is only effective for tables, it has no effect if the source object is a view. When an object is locked in SHARE mode, other users may read the object, but no updates by other users are possible.

EXCL

FM/Db2 locks the source object in EXCLUSIVE mode before copying the data. This option is only effective for tables, it has no effect if the source object is a view. When an object is locked in EXCLUSIVE mode, no other users may access the object at all, unless using uncommitted read.

DUPKEY

Specifies how FM/Db2 should respond to any duplicate key errors:

IGNORE

FM/Db2 ignores the error and continues processing. The row that caused the duplicate key error is not copied to the target Db2® object.

UPDATE

FM/Db2 attempts to update the existing row. The columns of the table that are part of the unique index that caused the SQLCODE-803 error are used to identify the row. No comparison is made between the copied row and the existing row prior to the update operation (that is, the update is done regardless of whether the copied row and existing row are the same). If there is more than one unique index defined on the target table, it is possible for an SQLCODE-803 to occur when the update is attempted. This is considered to be an update error.

DUPMAX

The number of duplicate key errors that are allowed before FM/Db2 terminates import processing:

ALL or 0

There is no limit.

num

The number of duplicate key errors allowed, up to a maximum of 2147483647.

REFI

Specifies whether to ignore errors arising from the violation of a check constraint (SQLCODE-545). The default is REFI=FAIL, meaning any check constraint error terminates copy processing. Otherwise (REFI=IGNORE) check constraint errors are ignored.

AUDIT

Specifies whether FM/Db2 is to write records to the FM/Db2 audit log:

YES

Write records to the FM/Db2 audit log. This is the default.

NO

Do not write records to the FM/Db2 audit log.

This option may be ignored if an installation audit option has been set that prevents a user modifying the installation setting.

DELROWS

Specifies whether FM/Db2 should attempt to delete all rows from the target table, prior to starting the copy operation:

YES

Attempt to delete all rows.

NO

Do not delete any rows. This is the default.

The deletion of rows from the target table is done using DELETE * FROM <object name> and fails if there are any referential integrity related errors arising from the deletion of rows.

ROWS

The maximum number of rows to be copied:

ALL

All rows from the source object are written to the target object.

num

The maximum number of rows to be copied. Valid range: 1-99999999.

Example**Examples**

Example 1: Copy the DSN8810.EMP table to a remote location. Delete all rows in the target table before copying the data. Use uncommitted read when accessing DSN8810.EMP. Audit the access to DSN8810.EMP.

```
//DBC JOB (acct),'name'
//* Copy DSN8810.EMP table to the same table at a remote location
//*
//FMNDB2 EXEC PGM=FMNDB2,PARM=('SSID=DSN1,SQID=ID1')
//STEPLIB DD DSN=FMN.SFMNMOD1,DISP=SHR
// DD DSN=DB2V810.DSN1.SDSNEXIT,DISP=SHR
// DD DSN=DB2.V810.SDSNLOAD,DISP=SHR
//SYSPRINT DD SYSOUT=*
//FMNTSPRT DD SYSOUT=*
//SYSTEM DD SYSOUT=*
```



```
//SYSIN DD *
$$$FILEM DBC OBJIN="DSN8810"."EMP",
$$$FILEM OBJOUT=REMLoc."DSN8810"."EMP",
$$$FILEM UCREAD=YES,
$$$FILEM LOCK=NONE,
$$$FILEM DUPKEY=IGNORE,
$$$FILEM DUPMAX=ALL,
$$$FILEM REFI=FAIL,
$$$FILEM AUDIT=YES,
$$$FILEM DELROWS=YES,
$$$FILEM ROWS=ALL
/*
```

Example 2: Copy the DSN8810.EMP table to a DSN8COPY.EMP. Update any rows in the target table that generate duplicate key errors, to a maximum of 100 duplicate key errors.

```
//DBC JOB (acct),'name'
/* Copy DSN8810.EMP table to a copy of the same table.
/*
//FMNDB2 EXEC PGM=FMNDB2,PARM=('SSID=DSN1,SQID=ID1')
//STEPLIB DD DSN=FMN.SFMNMOD1,DISP=SHR
// DD DSN=DB2V810.DSN1.SDSNEXIT,DISP=SHR
// DD DSN=DB2.V810.SDSNLOAD,DISP=SHR
//SYSPRINT DD SYSOUT=*
//FMNTSPRT DD SYSOUT=*
//SYSTEM DD SYSOUT=*
//SYSIN DD *
$$$FILEM DBC OBJIN="DSN8810"."EMP",
$$$FILEM OBJOUT="DSN8COPY"."EMP",
$$$FILEM LOCK=NONE,
$$$FILEM DUPKEY=UPDATE,
$$$FILEM DUPMAX=100,
$$$FILEM REFI=FAIL,
$$$FILEM ROWS=ALL
/*
```

Return codes

The return codes from the DBC function:

0

The function completed successfully

16

A serious error was encountered

Related functions

DBI

Import data from a sequential or VSAM file into a Db2® table ([DBI \(Import\) batch command on page 970](#))

DBX

Export data from a Db2® object to a sequential or VSAM file ([DBX \(Export\) batch command on page 979](#))

D2G

Create (generate) Db2® data ([D2G \(Data Generate\) batch command on page 994](#))

DBI (Import) batch command

Purpose

To import data, in a variety of formats, from a QSAM or VSAM file, into a Db2® object. The Db2® object must be accessible from the currently connected Db2® system.

Usage

The FM/Db2 import utility can:

- Optionally delete all rows from the target table prior to importing any data.
- Limit the number of records to be imported.
- Select the records to be imported.
- Map fields (using template mapping) in the import data set to columns in the target table, with appropriate data type and length conversions.
- Optionally update existing rows, when the values in an imported row's unique index columns match an existing table row.

A REXX procedure can be used during the import to modify mapped and converted data, prior to inserting it into the target Db2® table. Any REXX functions can be used at this point, and records can be dropped, or the import stopped via the REXX proc.

At the end of the import process the following statistics are shown:

- The count of rows successfully imported.
- The number of duplicate row errors.
- Optionally, the number of duplicate rows updated.
- Optionally, the number of duplicate row updates that failed.
- The number of rows in error.
- The number of rows skipped via template selection.
- The number of rows dropped by the REXX proc.

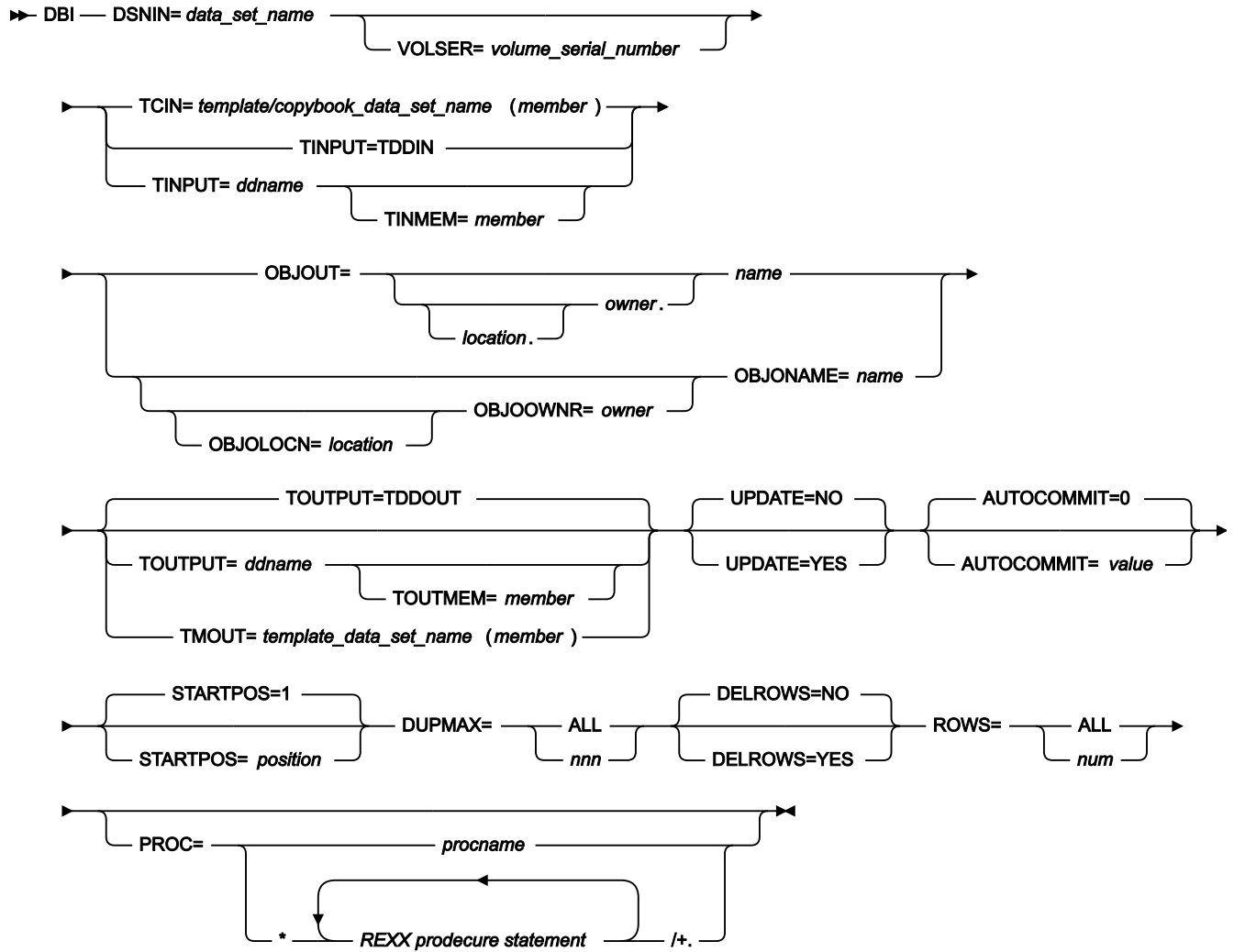

CSV import options

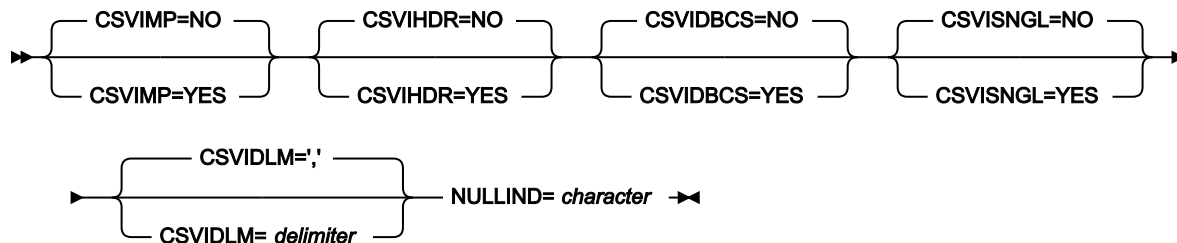
**DSNIN=***data_set_name*

The data set name containing the data to be imported. If the data set is partitioned, a member name is required.

VOLSER=*volume_serial_number*

The volume serial number for the input data set. This is only required for uncataloged data sets.

TINPUT=ddname

Defines a reference to a DD statement for the data sets which contains the template member that describes the record structure of your input data. The default is TDDIN.

TINMEM=member

The name of the template member in the dataset(s) identified by the TINPUT parameter, if it has not been specified on the DD statement. This parameter must not be specified if the TCIN parameter is specified.

TCIN=template/copybook_data_set_name(member)

The PDS (*template/copybook_data_set_name*) and member name (*member*) of the template or copybook that describes the record structure of the data to be imported. The JCL generated by FM/Db2 specifies TCIN. See [Specifying the template/copybook for a data set on page 1000](#).

OBJOUT=location.owner.name

The optional name of the Db2® remote server (*location*) where the target object is located; the optional name of the owner of the target object (*owner*) and the target object name (*name*) to be copied.

When location is not specified the current (local) Db2® server is used. When the owner is not specified the object name is qualified using the current SQLID. When FM/Db2 generates the utility control statements, the owner value is non-blank.

OBJOUT should be used when the fully qualified name fits on a single line in the JCL deck. The last usable column is column 71. When the fully qualified name does not fit on a single line in the JCL deck, use one or more of the OBJLOCN, OBJOOWNER, OBJONAME keywords to specify the object.

OBJLOCN=location

The optional name of the Db2® remote server (*location*) where the target object is located. See [Specifying a Db2 object name on page 999](#).

OBJOOWNER=owner

The optional name of the owner of the target object (*owner*) for the import. See [Specifying a Db2 object name on page 999](#).

OBJONAME=name

The object name (*name*) for the target object for the import. See [Specifying a Db2 object name on page 999](#).

TOUTPUT=ddname

Defines a reference to a DD statement for the data sets which contain the Db2® template that describes the target Db2® object. If you specify a concatenated DD, then you must provide the member name, *member*, via the TOUTMEM keyword. See [Specifying the template for a Db2 object on page 1000](#).

TOUTMEM=member

The name of the template member in the dataset(s) identified by the TOUTPUT parameter, if it has not been specified on the DD statement. This parameter must not be specified if the TMOUT parameter is specified. See [Specifying the template for a Db2 object on page 1000](#).

TMOUT=*template_data_set_name(member)*

The PDS (*template_data_set_name*) and member name (*member*) of the FM/Db2 template that describes the target Db2® object. See [Specifying the template for a Db2 object on page 1000](#).

UPDATE

Specifies whether FM/Db2 should attempt to update any rows that generate SQLCODE-803 (duplicate key) errors:

YES

FM/Db2 attempts to update the existing row. All columns of the table that are part of at least 1 unique index are used to identify the row. No comparison is made between the imported row and the existing row prior to the update operation (that is, the update is done regardless of whether the imported row and existing row are the same). When using this option it is recommended that a Db2® table name, rather than a view name, be specified. FM/Db2 does not attempt to update existing rows in a view defined on a view.

NO

No rows are updated. This is the default.

AUTOCOMMIT=*value*

Specifies a numeric value indicating how often FM/Db2 should issue a Db2® commit during the import. The default is zero, meaning that no Db2® commits are issued during the import operation. Any positive value results in FM/Db2 issuing a Db2® commit after value successful changes are made during the import. A successful change occurs when either a record is successfully inserted, or when a row is successfully updated after the attempted insert of the record resulted in a duplicate key error. The counter is reset after each Db2® commit is issued, therefore multiple Db2® commits may be issued. If an error occurs during the import and one or more Db2® commits have been issued, only the changes made subsequent to the last Db2® commit point are backed out.

STARTPOS=*position*

Specifies a numeric value indicating the starting record for the import. The default is 1, meaning FM/Db2 starts the import with the first record of the import file. Any value greater than 1 causes FM/Db2 to skip *position-1* records before commencing the import.

DUPMAX

The number of duplicate key errors that are allowed before FM/Db2 terminates import processing:

ALL or 0

There is no limit.

num

The number of duplicate key errors allowed, up to a maximum of 2147483647.

DELROWS

Specifies whether FM/Db2 should attempt to delete all rows from the target table, prior to starting the copy operation:

YES

Attempt to delete all rows.

NO

Do not delete any rows. This is the default.

The deletion of rows from the target table is done using DELETE * FROM <object name> and fails if there are any referential integrity related errors arising from the deletion of rows.

ROWS

The maximum number of records to be imported:

ALL

All records from the import data set are inserted into the target object.

num

The maximum number of records to be imported. Valid range: 1-99999999.

PROC

REXX procedure:

procname

The name of the REXX procedure to be used when processing import records.

*

An inline procedure. The * is followed by one or more REXX procedure statements, and the terminating "/+.".

CSV Import Options

CSVIMP

Default NO. Specify CSVIMP=YES when importing CSV data with a template.

CSVIHDR

Default NO. Specify YES if the CSV data set to be imported includes headings.

CSVIDBCS

Default NO. Specify YES if the CSV data set to be imported includes double-byte data (DBCS) characters wrapped in shift-in (x'0E') and shift-out (x'0F') characters.

CSVISNGL

Default NO. Specify YES option if the CSV data set to be imported has single quote encapsulation.

CSVIDL=delimiter

Default is the comma "," character. Use this keyword to specify an alternate delimiter value to the comma "," character.

NULLIND=character

Use this keyword to specify the null indicator value that was used to represent a null value in the CSV input data set. A nullable column will be set to null when the corresponding CSV value has:

1. A non-blank null indicator value.
2. A null CSV value. For example, two successive delimiters ',,'.

Example**Examples**

Example 1: Import data from a sequential file into DSN8810.EMP. Delete all rows in DSN8810.EMP before importing the data

```
//DBI JOB (acct),'name'
/* Import data from a sequential file into DSN8810.EMP.
/* Delete all the rows from the table before importing the data.
/*
//FMNDB2 EXEC PGM=FMNDB2,PARM=('SSID=DSN1,SQID=ID1')
//STEPLIB DD DSN=FMN.SFMNMOD1,DISP=SHR
// DD DSN=DB2V810.DSN1.SDSNEXIT,DISP=SHR
// DD DSN=DB2.V810.SDSNLOAD,DISP=SHR
//SYSPRINT DD SYSOUT=*
//FMNTSPRT DD SYSOUT=*
//SYSTEM DD SYSOUT=*
//SYSIN DD *
$$$FILEM DBI DSNIN=ID1.EXPORT.EMP.EXAMPLE1,
$$$FILEM TCIN=ID1.FM.TEMPLATE(EMP),
$$$FILEM OBJOUT="DSN8810"."EMP",
$$$FILEM UPDATE=NO,
$$$FILEM DUPMAX=ALL,
$$$FILEM DELROWS=YES,
$$$FILEM ROWS=ALL
/*
```

Example 2: Import data from a sequential file into DSN8810.EMP. Use REXX proc PROC1 to process each record in the sequential file before inserting the record. Update any rows that cause duplicate key errors, to a maximum of 50 duplicate key errors.

```
//DBI JOB (acct),'name'
/* Import data from a sequential file into DSN8810.EMP.
/*
//FMNDB2 EXEC PGM=FMNDB2,PARM=('SSID=DSN1,SQID=ID1')
//STEPLIB DD DSN=FMN.SFMNMOD1,DISP=SHR
// DD DSN=DB2V810.DSN1.SDSNEXIT,DISP=SHR
// DD DSN=DB2.V810.SDSNLOAD,DISP=SHR
//SYSPRINT DD SYSOUT=*
//FMNTSPRT DD SYSOUT=*
//SYSTEM DD SYSOUT=*
//FMNEXEC DD DSN=ID1.EXEC,DISP=SHR
```

```
//SYSIN DD *
$$FILEM DBI DSNIN=ID1.EXPORT.EMP.EXAMPLE1,
$$FILEM TCIN=ID1.FM.TEMPLATE(EMP),
$$FILEM OBJJOUT="DSN8810"."EMP",
$$FILEM UPDATE=YES,
$$FILEM DUPMAX=50,
$$FILEM DELROWS=NO,
$$FILEM ROWS=ALL,
$$FILEM PROC=PROC1
/*
```

Return codes

The return codes from the DBI function:

0

The function completed successfully

16

A serious error was encountered

Related functions

DBC

Copy data from one Db2® object to another ([DBC \(Copy\) batch command on page 963](#))

DBX

Export data from a Db2® object to a sequential or VSAM file ([DBX \(Export\) batch command on page 979](#))

D2G

Create (generate) Db2® data ([D2G \(Data Generate\) batch command on page 994](#))

DBP (Print) batch command

Purpose

To print the contents of a Db2® object in a variety of formats.

Usage

The FM/Db2 Print utility function can:

- Print data in table or single formats, in either character or HEX.
- Select the rows and columns to be printed.
- Limit the number of rows to be printed.

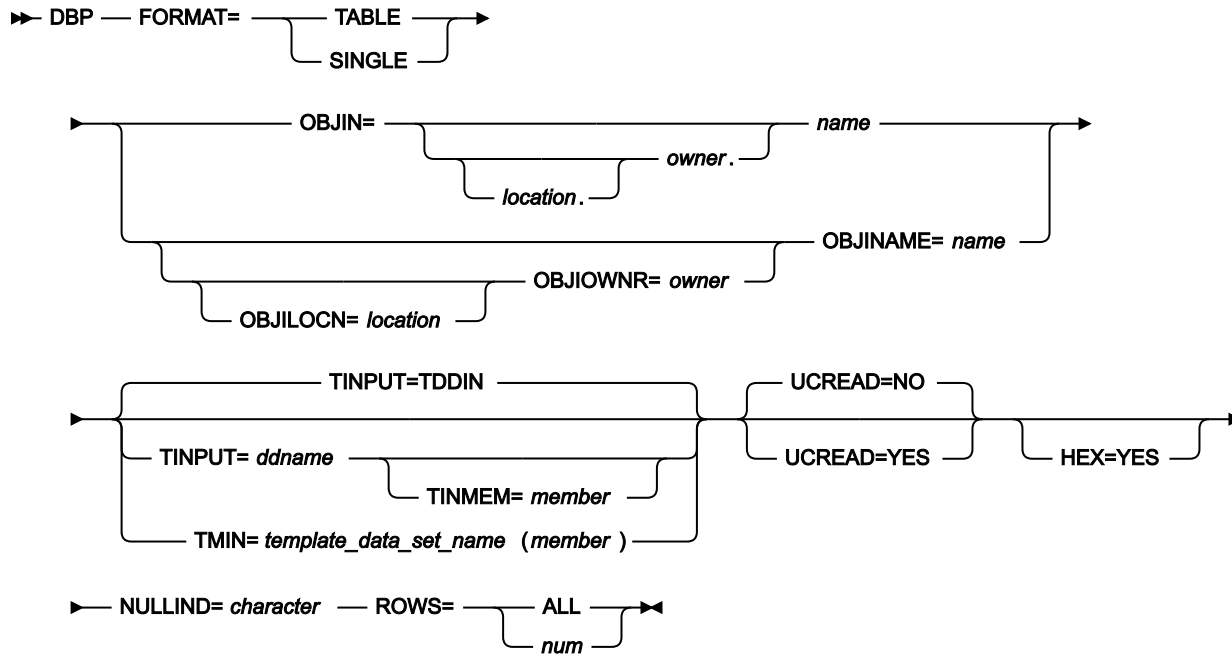

FORMAT

The formatting mode for the printed data:

TABLE

In table mode each row of the table occupies a single line, and columns appear left to right across the page.

SINGLE

In single mode each row of the table occupies multiple print lines. The first column of the object is printed on the first, and possibly more lines, followed by the second column and so on.

OBJIN=*location.owner.name*

The optional name of the Db2® remote server (*location*) where the object is located; the optional name of the owner of the object (*owner*) and the object name (*name*) to be printed.

When location is not specified the current (local) Db2® server is used. When the owner is not specified the object name is qualified using the current SQLID. When FM/Db2 generates the utility control statements, the owner value is non-blank.

OBJIN should be used when the fully qualified name fits on a single line in the JCL deck. The last usable column is column 71. When the fully qualified name does not fit on a single line in the JCL deck, use one or more of the OBJILOCN, OBJIOWNR, OBJINAME keywords to specify the object.

OBJILOCN=*location*

The optional name of the Db2® remote server (*location*) where the object to be printed is located. See [Specifying a Db2 object name on page 999](#).

OBJIOWNER=owner

The optional name of the owner of the object (*owner*) to be printed. See [Specifying a Db2 object name on page 999](#).

OBJNAME=name

The object name (*name*) for the object to be printed. See [Specifying a Db2 object name on page 999](#).

TINPUT=ddname

Defines a reference to a DD statement for the data sets which contain the Db2® template that describes the source Db2® object to be printed. If you specify a concatenated DD, then you must provide the member name, *member*, via the TINMEM keyword. See [Specifying the template for a Db2 object on page 1000](#).

TINMEM=member

The name of the template member in the dataset(s) identified by the TINPUT parameter, if it has not been specified on the DD statement. This parameter must not be specified if the TMIN parameter is specified. See [Specifying the template for a Db2 object on page 1000](#).

TMIN=template_data_set_name(member)

The PDS (*template_data_set_name*) and member name (*member*) of the File Manager template that describes the source Db2® object to be copied. See [Specifying the template for a Db2 object on page 1000](#).

UCREAD

Specifies whether FM/Db2 should use uncommitted read, when accessing the source object:

YES

Uncommitted read is used. In this case, Db2® takes no locks when accessing the data in the source table, and it is possible that the data for a row changes after being read by FM/Db2, resulting in data inconsistencies.

NO

Uncommitted read is not used. This is the default.

HEX=YES

Specifies that FM/Db2 should print the data in hexadecimal format. Omit this option if normal printing is required.

NULLIND=character

Defines the character used to indicate that the value for a column is the Db2® null value, in the printed data.

The default is the underscore character. The value for this character is set using the editor **Null Column**

Indicators: Display option. When specified in the File Manager utility control statements, the character must be a printable character other than a comma. The value cannot be enclosed in quotation marks.

ROWS

The maximum number of rows to be printed:

ALL

All rows from the source object are printed.

num

The maximum number of rows to be printed. Valid range: 1-99999999.

Example**Examples**

Example 1: Print data from DSN8810.EMP, in single mode. Use uncommitted read when accessing the Db2® data. Print the data in hexadecimal format.

```
//DBP JOB (acct),'name'
/* Print table DSN8810.EMP in SINGLE format.
/*
//FMNDB2 EXEC PGM=FMNDB2,PARM=('SSID=DSN1,SQID=ID1')
//STEPLIB DD DSN=FMN.SFMNMOD1,DISP=SHR
// DD DSN=DB2V810.DSN1.SDSNEXIT,DISP=SHR
// DD DSN=DB2.V810.SDSNLOAD,DISP=SHR
//SYSPRINT DD SYSOUT=*
//FMNTSPRT DD SYSOUT=*
//SYSTEM DD SYSOUT=*
//SYSIN DD *
$$$FILEM DBP FORMAT=SINGLE,
$$$FILEM OBJIN="DSN8810"."DEPT",
$$$FILEM UCREAD=YES,
$$$FILEM HEX=YES,
$$$FILEM NULLIND=_,
$$$FILEM ROWS=ALL
/*
```

Return codes

The return codes from the DBP function:

0

The function completed successfully

16

A serious error was encountered

Related functions

None.

DBX (Export) batch command**Purpose**

To export data from a Db2® object (table, view, synonym or alias) or the result table from a SELECT statement, in any local or distributed Db2® system, to a sequential or VSAM file.

Usage

The FM/Db2 Export Utility can export data from a Db2® table or view using one of the following methods:

File Manager

The output data set can be a sequential data set, a partitioned data set, or a VSAM file.

The Db2® UNLOAD utility

The output data set is constrained by the Db2® UNLOAD utility to be a sequential data set. Any reformatting of the output data is performed by the Db2® UNLOAD utility. Therefore some template mapping and re-formatting options that are available when using File Manager are not available.

The Db2® DSNTIAUL sample program

The output data set is constrained by the Db2® DSNTIAUL utility to be a sequential data set. Any reformatting of the output data is performed by the Db2® DSNTIAUL sample program utility. Therefore some template mapping and re-formatting options that are available when using File Manager are not available.

When exporting large volumes of data, the Db2® UNLOAD utility offers superior performance when compared with File Manager or the DSNTIAUL sample program.

You can choose a pre-defined (standard) export data format, or specify the data format using a copybook or template. You can specify that File Manager is to export the data, or use a Db2® utility or sample program to export the data. For a user-defined data format you can specify how the Db2® null indicator is represented (either one byte or two byte) and where the null indicator is located in the exported data. You can also specify that the data is to be exported in delimited format (comma separated variables).

Figure 181.

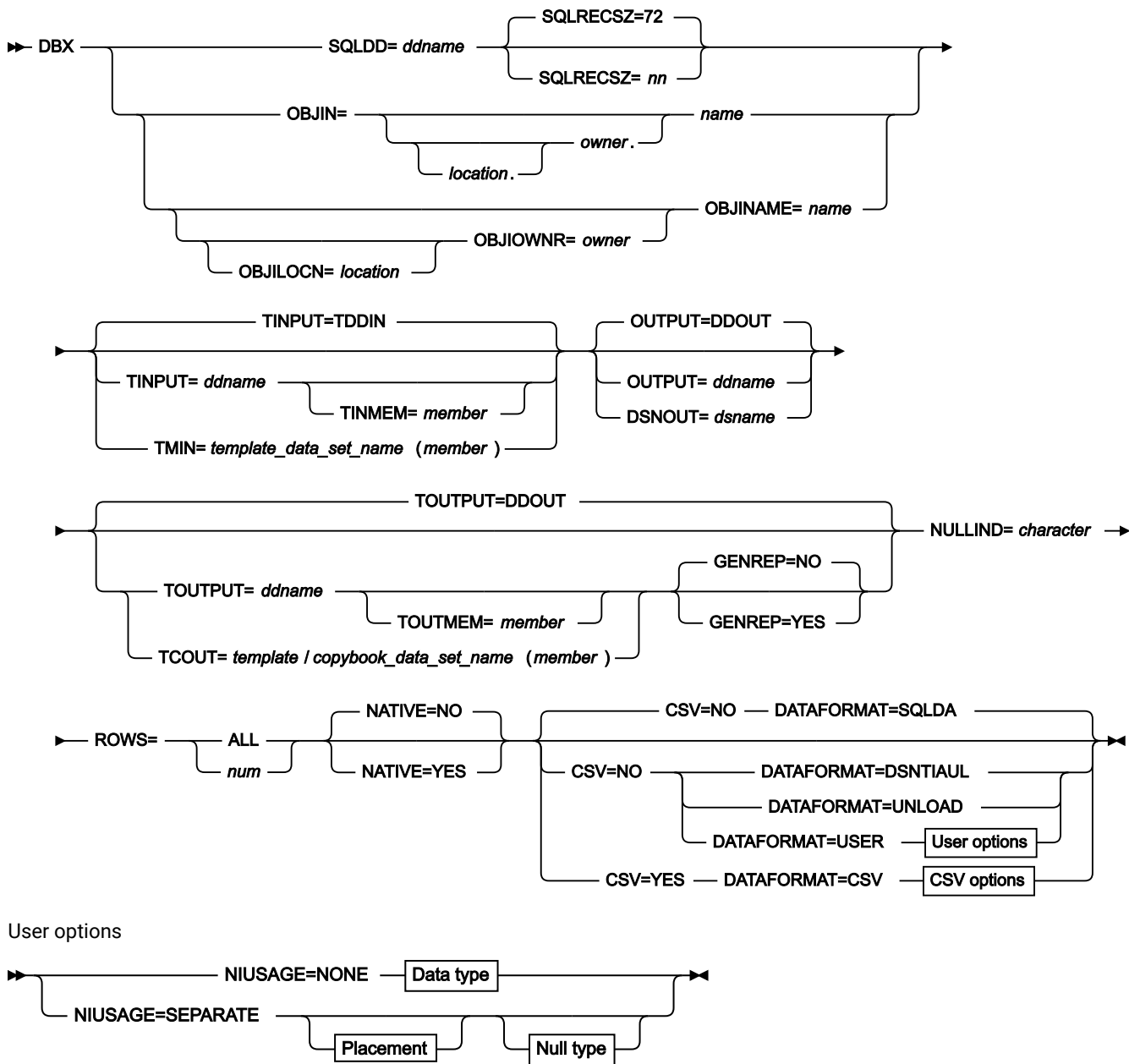

CSV options

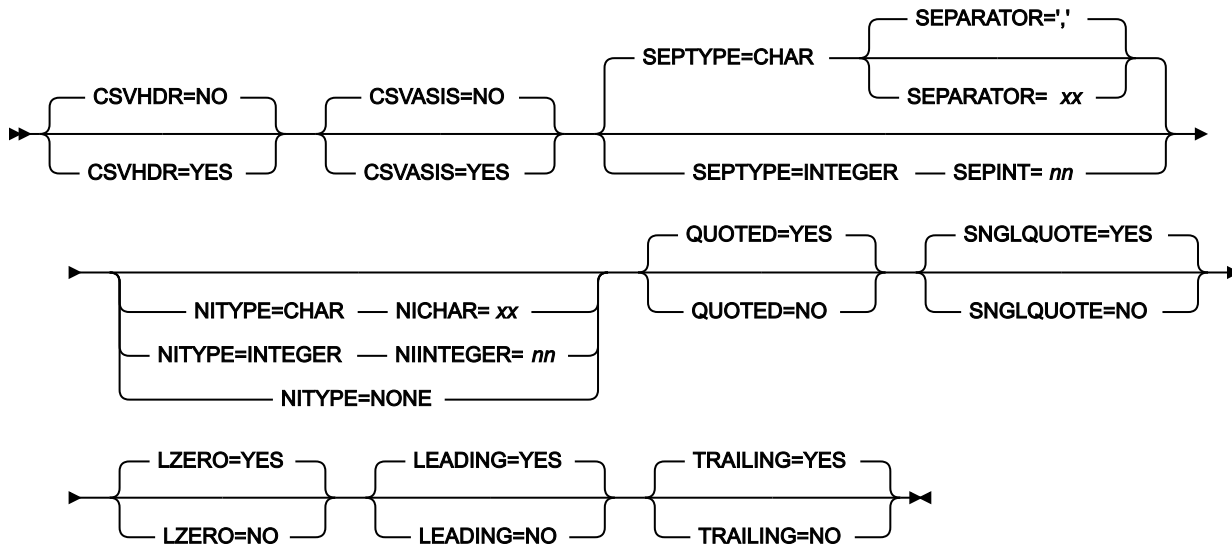

Placement

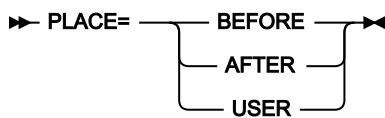

Null type

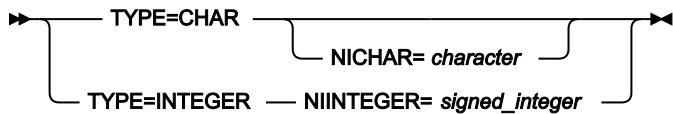

Data type

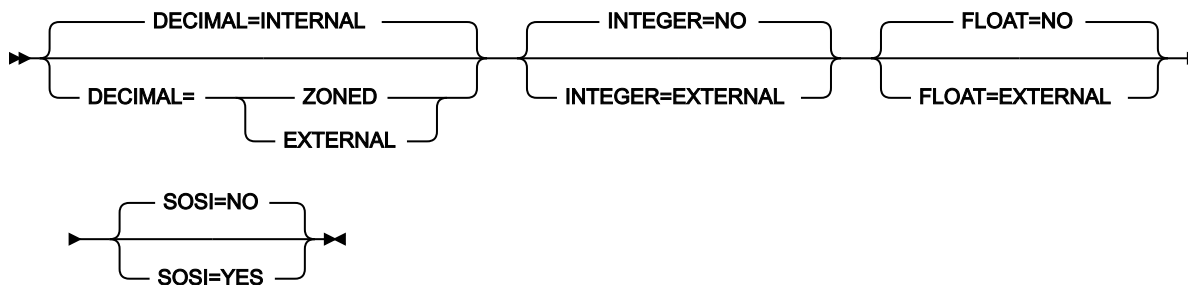

SQLDD=ddname

ddname is the DDNAME, specified in the JCL, that identifies either a data set containing an SQL SELECT statement to be processed, or a DDNAME used to specify an in-line SQL SELECT statement.

SQLRECSZ=nn

nn is the usable record size for the SQL statement. For in-line SQL statements, specified in the JCL, use a value of 72, to avoid problems with sequence numbers in columns 73-80 inclusive.

For a data set, set an appropriate value.

OBJIN=*location.owner.name*

The optional name of the Db2® remote server (*location*) where the object is located; the optional name of the owner of the object (*owner*) and the object name (*name*) to be exported.

When location is not specified the current (local) DB2® server is used. When the owner is not specified the object name is qualified using the current SQLID. When FM/DB2 generates the utility control statements, the owner value is non-blank.

OBJIN should be used when the fully qualified name fits on a single line in the JCL deck. The last usable column is column 71. When the fully qualified name does not fit on a single line in the JCL deck, use one or more of the OBJILOCN, OBJIOWNR, OBJJNAME keywords to specify the object.

OBJILOCN=*location*

The optional name of the Db2® remote server (*location*) where the object to be exported is located. See [Specifying a Db2 object name on page 999](#).

OBJIOWNR=*owner*

The optional name of the owner of the object (*owner*) to be exported. See [Specifying a Db2 object name on page 999](#).

OBJJNAME=*name*

The object name (*name*) for the object to be exported. See [Specifying a Db2 object name on page 999](#).

TINPUT=*ddname*

Defines a reference to a DD statement for the data sets which contain the Db2® template that describes the Db2® object to be exported. If you specify a concatenated DD, then you must provide the member name, *member*, via the TINMEM keyword. See [Specifying the template for a Db2 object on page 1000](#).

TINMEM=*member*

The name of the template member in the datasets identified by the TINPUT parameter, if it has not been specified on the DD statement. This parameter must not be specified if the TMIN parameter is specified. See [Specifying the template for a Db2 object on page 1000](#).

TMIN=*template_data_set_name(member)*

The PDS (*template_data_set_name*) and member name (*member*) of the FM/Db2 template that describes the Db2® object to be exported. See [Specifying the template for a Db2 object on page 1000](#).

OUTPUT=*ddname*

Defines a reference to a DD statement for the export data set. This keyword and the DSNOUT keyword are mutually exclusive. The JCL generated by FM/Db2 specifies OUTPUT=FMNOUT in the File Manager utility control statements, and an appropriate DD statement in the JCL.

DSNOUT=dsname

Defines the name of the export data set or an absolute path to the export HFS file (directory). This keyword and the OUTPUT keyword are mutually exclusive. The name may include a member name in parenthesis. An absolute path to an HFS file (directory) must be enclosed in apostrophes. If the data set name does not fit on one line, you can split it over more than one line.

TOUTPUT=ddname

Defines a reference to a DD statement for the data sets which contain the template member that describes the record structure of your output data. The default is TDDOUT.

TOUTMEM=member

The name of the template member in the dataset(s) identified by the TOUTPUT parameter, if it has not been specified on the DD statement. This parameter must not be specified if the TCOUT parameter is specified.

TCOUT=template/copybook_data_set_name(member)

The PDS (*template/copybook_data_set_name*) and member name (*member*) of the template or copybook that describes the record structure of the exported data. The JCL generated by FM/Db2 specifies TCOUT, when an output copybook or template is required. See [Specifying the template/copybook for a data set on page 1000](#).

GENREP

Whether to generate and save the output template to the data set specified on the TCOUT keyword or TDDOUT DD statement.

NO

Don't generate and save.

YES

Generate and save.

NULLIND=character

For CSV format only, defines the character used to indicate that the value for a column is the Db2® null value, in the exported data. The default is the underscore character. The value for this character is set using the editor **Null Column Indicators: Display** option. When specified in the File Manager utility control statements, the character must be a printable character other than a comma. The value cannot be enclosed in quotation marks.

NULLIND is always specified in the File Manager utility control statements. The value specified is ignored for all DATAFORMAT specifications other than CSV.

ROWS

The number of records to be exported:

ALL

All records selected from the object are written to the export data set.

num

The maximum number of records to be written to the export data set. Valid range: 1-99999999.

NATIVE

Specifies whether FM/Db2 should process Unicode encoded data natively when exporting data from a Unicode encoded table. This option can be ignored if the default processing of Unicode data is desired; that is, Unicode data is potentially substituted with error characters when copying data between Unicode tables.

YES

Process Unicode data natively.

NO

Do not Process Unicode data natively. This is the default.

CSV

Specifies whether the exported data is to be in delimited variables format or not:

NO

Export data is not to be in delimited format. This is the default.

YES

Export data is to be in delimited format.

DATAFORMAT

The data format for the exported data:

SQLDA

The default. Any nullable column is preceded by a 2-byte binary field containing the null indicator. This field contains -1 if the column has the null value and 0 otherwise. Any decimal field occupies 16 bytes, with the data left-justified in the field and trailing binary zeros. Any graphic or vargraphic field is followed by two bytes containing binary zeros.

UNLOAD

In this format any nullable column is preceded by a 1-byte field containing the null indicator. This field contains hexadecimal "FF" if the column had a null value and 0 otherwise. Any decimal field occupies the minimum number of bytes needed to represent the data as a packed decimal field. Variable length columns in the unloaded records are padded to their maximum length and the padded data fields are preceded by two-byte length fields that indicate the size of the actual data without the padding. CCSID conversion is not supported. The exported data is in the CCSID used to bind the FM/Db2 plan.

DSNTIAUL

Any nullable column is followed by a 1-byte field containing the null indicator. This field contains "?" if the column had a null value. Any decimal field occupies the minimum number of bytes needed to represent the data as a packed decimal field.

USER

The data format is defined by a user-specified copybook or template and template mapping. Alternatively the data format can be defined using the NIUSAGE, PLACE, TYPE (NICHAR, NIINTEGER), DECIMAL, INTEGER, FLOAT, and SOSI keywords.

CSV

The data is exported as delimited variables. The default delimiter is the comma, the SEPARATOR keyword can be used to specify a different delimiter. A copybook/template cannot be used to describe the delimited variables data format.

CSVHDR

Specifies whether column headers are to be produced on the first record of the export file when CSV=YES has been specified. Possible values are:

NO

Column headers not produced.

YES

Column headers produced.

CSVASIS

Specifies whether the automatic encapsulation for CSV data is disabled when the data contains the CSV separator character or a quote.

YES

Automatic encapsulation is disabled.

NO

Automatic encapsulation is enabled.

This option applies to character data other than pure DBCS data (GRAPHIC datatypes). One use of this option is to prevent double encapsulation of character data that has already been encapsulated with quotes before insertion into a DB2® table.

SEPTYPE=CHAR/INTEGER

Specifies, for CSV format only, the type of separator used to separate each field in the output.

CHAR

One or two characters is used to separate data in each field. Use the SEPARATOR keyword to specify the characters to be used.

INTEGER

A signed integer is used to specify a 2-byte separator. Use SEPINT to specify the signed integer to be used.

SEPARATOR='characters'

Specifies the one or two characters used to separate each field when exporting to CSV format. The default is the comma.

SEPINT=*signed_integer*

Specifies a signed integer used to separate each field when exporting to CSV format. The value specified is converted to the 2-byte signed representation of the integer. Examples:

`-1` results in a two-byte separator X'FFFF'

`257` results in a two-byte separator X'0101'

QUOTED

Specifies whether output field values are to be enclosed in quotes. The default is QUOTED=NO. If this option is specified, and SNGLQUOTE is not specified, or, SNGLQUOTE is set to NO, then output fields will be enclosed in double quotes.

YES

Enclose output field values in quotes.

NO

Default. Do not enclose output field values in quotes.

SNGLQUOTE

Specifies whether output fields values are to be enclosed in single quotes or double quotes. The default is SNGLQUOTE=NO.

YES

Enclose output field values in single quotes.

NO

Default. Enclose output field values in double quotes.

LZERO

Specifies whether numeric fields will be prefixed with leading zeros. The default is LZERO=NO.

YES

Prefix numeric fields with leading zeros.

NO

Default. Do not prefix numeric fields with leading zeros.

LEADING

Specifies if leading blanks within Db2 CHAR and VARCHAR columns are to be included in the CSV export data set. The default is LEADING=YES.

YES

Include leading blanks in the exported data set. If the value of the Db2 column is all blanks, and TRAILING=YES is specified, then all of the blanks are included in the exported data set.

NO

Do not include leading blanks in the exported data set.

TRAILING

Specifies if trailing blanks within Db2 CHAR and VARCHAR columns are to be included in the CSV exported data set. The default is TRAILING=NO.

YES

Include trailing blanks in the exported data set. If the value of the Db2 column is all blanks, and LEADING=YES is specified, then all of the blanks are included in the exported data set.

NO

Do not include trailing blanks in the exported data set.

PLACE

The location of any Db2® null indicator fields in the exported data:

BEFORE

The field for the Db2® null indicator appears immediately before the data for the column.

AFTER

The field for the Db2® null indicator appears immediately after the data for the column.

USER

The field for the Db2® null indicator is defined using a copybook or template, with template mapping.

NIUSAGE

Specifies, for DATAFORMAT=USER only, whether or not null indicators appear in the exported data. To specify null indicator usage for CSV format use the NITYPE, NICHAR, and NIINTEGER keywords.

NONE

The exported data is not to contain any DB2® null indicators. Using this option with a DB2® object that has nullable columns results in a loss of information, in that null indicators in the source record are not exported.

SEPARATE

The exported data is to contain DB2® null indicators. The position and data type of the null indicator fields is specified using the PLACE, TYPE, NICHAR, and NIINTEGER keywords.

TYPE=CHAR/INTEGER

The data format for the null indicator fields, for DATAFORMAT=USER only. The null indicator can be either a one-byte (character) or two-byte (signed integer) field. The character or integer used to indicate the DB2® null value can be specified using the NICHAR (TYPE=CHAR) or NIINTEGER (TYPE=INTEGER) keywords.

NITYPE=CHAR/INTEGER

The data format for the null indicator fields, for DATAFORMAT=CSV only. The null indicator can be either a one-byte (character) or two-byte (signed integer) field. The character or integer used to indicate the DB2® null value can be specified using the NICHAR (NITYPE=CHAR) or NIINTEGER (NITYPE=INTEGER) keywords.

NICHAR=*character*

The character used to indicate that a column has the DB2® null value. NICHAR should only be specified with DATAFORMAT=USER and TYPE=CHAR.

NIINTEGER=*signed_integer*

The integer used to indicate that a column has the DB2® null value. NIINTEGER should only be specified with DATAFORMAT=USER and TYPE=INTEGER. You can specify any signed integer in the range -32767 to 32768.

DECIMAL

Specifies the data format for any decimal columns in the exported data. Possible values are:

INTERNAL

Decimal data appears in internal packed decimal format.

ZONED

Decimal data appears as a string of zoned decimal digits.

EXTERNAL

Decimal data appears as a string of characters, the string represents the decimal number, for example '3.1415'.

INTEGER

Specifies the data format for any integer columns in the exported data. An integer column can be a SMALLINT, INTEGER or BIGINT. Possible values are:

NO

Integer data appears in internal format, occupying 2 bytes (SMALLINT), 4 bytes (INTEGER) or 8 bytes (BIGINT).

EXTERNAL

Integer data appears as a string of characters, the string represents the integer, for example, '42', '1000000'.

FLOAT

Specifies the data format for any floating point columns in the exported data. A floating point column is a REAL, FLOAT, DOUBLE or DECFLOAT column. Possible values are:

NO

The floating point data appears in internal format.

EXTERNAL

Floating point data appears as a string of characters, the string represents the number, for example '-1.000000000000000E+00'.

SOSI

Specifies whether the data for graphic data type columns (GRAPHIC, VARGRAPHIC) should be enclosed in shift-out/shift-in (sosi) characters. Possible values are:

NO

The graphics data is not enclosed in sosi characters.

YES

The graphics data is enclosed in sosi characters.

Example**Examples**

Example 1: Export data from Db2® sample table DSN8810.EMP to a sequential file, using SQLDA format. The output data set is allocated in the batch job.

```
//DBX JOB (acct),'name'
//* Export DSN8810.EMP table to a data set
//*
//FMNDB2 EXEC PGM=FMNDB2,PARM=('SSID=DSN1,SQID=ID1')
//STEPLIB DD DSN=FMN.SFMNMOD1,DISP=SHR
// DD DSN=DB2V810.DSN1.SDSNEXIT,DISP=SHR
// DD DSN=DB2.V810.SDSNLOAD,DISP=SHR
//SYSPRINT DD SYSOUT=*
//FMNTSPRT DD SYSOUT=*
//SYSTEM DD SYSOUT=*
//FMNOUT DD DISP=(MOD,CATLG,DELETE),UNIT=SYSALLDA,
// AVGREC=U,
// LRECL=144,RECFM=FB,DSORG=PS,
// SPACE=(144,(42,4),RLSE),
// DSN=ID1.EXPORT.EMP.SQLDA
//SYSIN DD *
$$$FILEM DBX OBJIN="DSN8810"."EMP",
$$$FILEM OUTPUT=FMNOUT,
$$$FILEM NULLIND=_,
$$$FILEM CSV=NO,
$$$FILEM DATAFORMAT=FMSQLDA,
$$$FILEM ROWS=ALL
/*
```

Example 2: Export data from Db2® sample table DSN8810.EMP to a sequential file, using Db2® UNLOAD format. The output data set is allocated in the batch job.

```
//DBX JOB (acct),'name'
//* Export DSN8810.EMP table to a data set
```

```

/*
//FMNDB2 EXEC PGM=FMNDB2,PARM=('SSID=DSN1,SQID=ID1')
//STEPLIB DD DSN=FMN.SFMNMOD1,DISP=SHR
// DD DSN=DB2V810.DSN1.SDSNEXIT,DISP=SHR
// DD DSN=DB2.V810.SDSNLOAD,DISP=SHR
//SYSPRINT DD SYSOUT=*
//FMNTSPRT DD SYSOUT=*
//SYSTEM DD SYSOUT=*
//FMNOUT DD DISP=(MOD,CATLG,DELETE),UNIT=SYSALLDA,
// AVGREC=U,
// LRECL=101,RECFM=FB,DSORG=PS,
// SPACE=(101,(42,4),RLSE),
// DSN=ID1.EXPORT.EMP.UNLOAD
//SYSIN DD *
$$FILEM DBX OBJIN="DSN8810"."EMP",
$$FILEM OUTPUT=FMNOUT,
$$FILEM NULLIND=_,
$$FILEM CSV=NO,
$$FILEM DATAFORMAT=UNLOAD,
$$FILEM ROWS=ALL
/*

```

Example 3: Export data from Db2® sample table DSN8810.EMP to a sequential file, using Db2® DSNTIAUL format. The output data set is allocated in the batch job.

```

//DBX JOB (acct),'name'
/* Export DSN8810.EMP table to a data set
/*
//FMNDB2 EXEC PGM=FMNDB2,PARM=('SSID=DSN1,SQID=ID1')
//STEPLIB DD DSN=FMN.SFMNMOD1,DISP=SHR
// DD DSN=DB2V810.DSN1.SDSNEXIT,DISP=SHR
// DD DSN=DB2.V810.SDSNLOAD,DISP=SHR
//SYSPRINT DD SYSOUT=*
//FMNTSPRT DD SYSOUT=*
//SYSTEM DD SYSOUT=*
//FMNOUT DD DISP=(MOD,CATLG,DELETE),UNIT=SYSALLDA,
// AVGREC=U,
// LRECL=101,RECFM=FB,DSORG=PS,
// SPACE=(101,(42,4),RLSE),
// DSN=ID1.EXPORT.EMP.DSNTIAUL
//SYSIN DD *
$$FILEM DBX OBJIN="DSN8810"."EMP",
$$FILEM OUTPUT=FMNOUT,
$$FILEM NULLIND=_,
$$FILEM CSV=NO,
$$FILEM DATAFORMAT=DSNTIAUL,
$$FILEM ROWS=ALL
/*

```

Example 4: Export data from a table with a long name containing spaces to a sequential file, using SQLDA format. The output data set is pre-allocated.

```

//DBX JOB (acct),'name'
/* Export a table with a long name to a data set
/*
//FMNDB2 EXEC PGM=FMNDB2,PARM=('SSID=DSN1,SQID=ID1')
//STEPLIB DD DSN=FMN.SFMNMOD1,DISP=SHR
// DD DSN=DB2V910.DSN1.SDSNEXIT,DISP=SHR

```

```
//          DD DSN=DB2.V910.SDSNLOAD,DISP=SHR
//SYSPRINT DD SYSOUT=*
//FMNTSPRT DD SYSOUT=*
//SYSTEM   DD SYSOUT=*
//FMNOUT   DD DISP=MOD,
//          DSN=ID1.EXPORT.EMP.EXAMPLE4
//SYSIN    DD *
$$$FILEM DBX OBJIOWNR=ID1,
$$$FILEM OBJJNAME='\$Very long table name to demonstrate how \$',
$$$FILEM '\$long names are handled\$',
$$$FILEM OUTPUT=FMNOUT,
$$$FILEM NULLIND=_,
$$$FILEM CSV=NO,
$$$FILEM DATAFORMAT=FMSQLDA,
$$$FILEM ROWS=ALL
/*
```

Example 5: Export data from Db2® sample table DSN8810.EMP to a sequential file, using a user-defined data format. The output data set is pre-allocated. In the user-defined data format:

- Null indicators are used (NIUSAGE=SEPARATE)
- Null indicators appear immediately after the data for the column (PLACE=AFTER)
- The null indicator is a two byte (signed integer) field (TYPE= INTEGER)
- The value used to indicate a column has the Db2® null value is -55.
- Any DECIMAL data type columns appear in external format (for example '3.1414')
- Any INTEGER data columns appear in external format (for example '1234')
- Any floating point data type columns appear in external format.

```
//DBX JOB (acct),'name'
/* Export DSN8810.EMP table to a data set
/*
//FMNDB2   EXEC PGM=FMNDB2,PARM=('SSID=DSN1,SQID=ID1')
//STEPLIB DD DSN=FMN.SFMNMOD1,DISP=SHR
//          DD DSN=DB2V910.DSN1.SDSNEXIT,DISP=SHR
//          DD DSN=DB2.V910.SDSNLOAD,DISP=SHR
//SYSPRINT DD SYSOUT=*
//FMNTSPRT DD SYSOUT=*
//SYSTEM   DD SYSOUT=*
//FMNOUT   DD DISP=MOD,
//          DSN=ID1.EXPORT.EMP.EXAMPLE5
//SYSIN    DD *
$$$FILEM DBX OBJJIN="DSN8910"."EMP",
$$$FILEM OUTPUT=FMNOUT,
$$$FILEM NULLIND=_,
$$$FILEM CSV=NO,
$$$FILEM DATAFORMAT=USER,
$$$FILEM NIUSAGE=SEPARATE,
$$$FILEM PLACE=AFTER,
$$$FILEM TYPE=INTEGER,
$$$FILEM NIINTEGER=-55,
$$$FILEM DECIMAL=EXTERNAL,
$$$FILEM INTEGER=EXTERNAL,
$$$FILEM FLOAT=EXTERNAL,
```



```
$$$FILEM ROWS=ALL
/*
```

Example 6: Export data from Db2® sample table DSN8810.EMP to a sequential file, using a CSV (delimited variables) format. The delimiter character is the '|' character. The output data set is pre- allocated.

```
//DBX JOB (acct),'name'
/* Export DSN8810.EMP table to a data set
/*
//FMNDB2 EXEC PGM=FMNDB2,PARM=('SSID=DSN1,SQID=ID1')
//STEPLIB DD DSN=FMN.SFMNMOD1,DISP=SHR
// DD DSN=DB2V910.DSN1.SDSNEXIT,DISP=SHR
// DD DSN=DB2.V910.SDSNLOAD,DISP=SHR
//SYSPRINT DD SYSOUT=*
//FMNTSPRT DD SYSOUT=*
//SYSTEM DD SYSOUT=*
//FMNOUT DD DISP=MOD,
// DSN=ID1.EXPORT.EMP.CSV
//SYSIN DD *
$$$FILEM DBX OBJIN="DSN8910"."EMP",
$$$FILEM OUTPUT=FMNOUT,
$$$FILEM NULLIND=_,
$$$FILEM CSV=YES,
$$$FILEM DATAFORMAT=CSV,
$$$FILEM SEPARATOR='|',
$$$FILEM ROWS=ALL
/*
```

Example 7: Export data from Db2® sample table DSN8810.EMP to a sequential file, using a CSV (delimited variables format). The delimiter character is 'X'FFFFF', defined using the NIUSAGE, TYPE and NIINTEGER keywords. The output data set is pre- allocated.

```
//DBX JOB (acct),'name'
/* Export DSN8810.EMP table to a data set
/*
//FMNDB2 EXEC PGM=FMNDB2,PARM=('SSID=DSN1,SQID=ID1')
//STEPLIB DD DSN=FMN.SFMNMOD1,DISP=SHR
// DD DSN=DB2V910.DSN1.SDSNEXIT,DISP=SHR
// DD DSN=DB2.V910.SDSNLOAD,DISP=SHR
//SYSPRINT DD SYSOUT=*
//FMNTSPRT DD SYSOUT=*
//SYSTEM DD SYSOUT=*
//FMNOUT DD DISP=MOD,
// DSN=ID1.EXPORT.EMP.CSV2
//SYSIN DD *
$$$FILEM DBX OBJIN="DSN8910"."EMP",
$$$FILEM OUTPUT=FMNOUT,
$$$FILEM NULLIND=_,
$$$FILEM CSV=YES,
$$$FILEM DATAFORMAT=CSV,
$$$FILEM NIUSAGE=CSV,
$$$FILEM TYPE=INTEGER,
$$$FILEM NIINTEGER=-1,
$$$FILEM ROWS=ALL
/*
```

Return codes

The return codes from the DBX function:

0

The function completed successfully

16

A serious error was encountered

Related functions

DBI

Import data from a sequential or VSAM file into a Db2® table ([DBI \(Import\) batch command on page 970](#))

DBC

Copy data from one Db2® object to another ([DBC \(Copy\) batch command on page 963](#))

D2G

Create (generate) Db2® data ([D2G \(Data Generate\) batch command on page 994](#))

D2G (Data Generate) batch command

Purpose

To load a Db2® object with test data.

Usage

The FM/Db2 Data Create utility function can:

- Limit the number of rows to be created.
- Specify how, on a column-by-column basis, each row is be initialized.

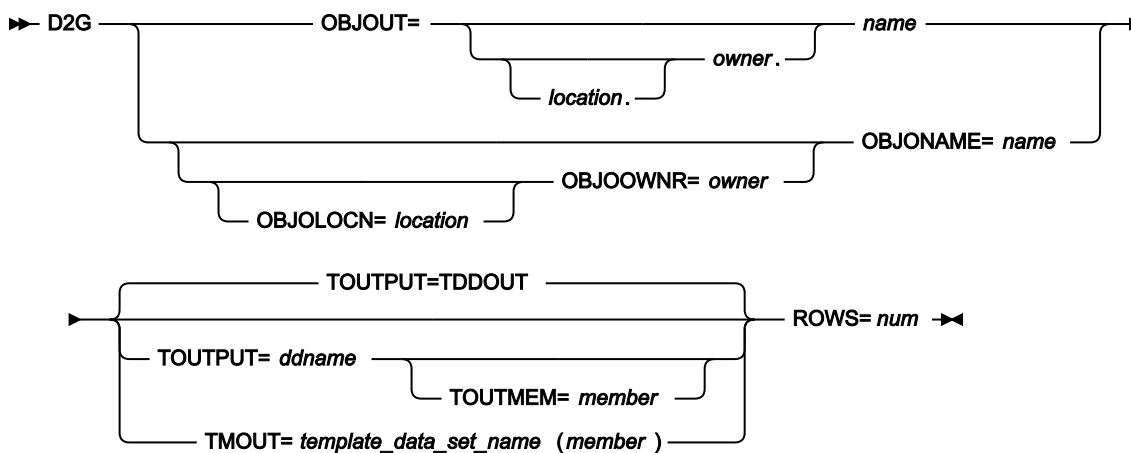

OBJOUT location.owner.object

The optional name of the Db2® remote server (*location*) where the object is located; the optional name of the owner of the object (*owner*) and the object name (*name*).

When *location* is not specified the current (local) Db2® server is used. When the *owner* is not specified the object name is qualified using the current SQLID. When FM/Db2 generates the utility control statements, the *owner* value is non-blank.

OBJOUT should be used when the fully qualified name fits on a single line in the JCL deck. The last usable column is column 71. When the fully qualified name does not fit on a single line in the JCL deck, use one or more of the OBJLOCN, OBJOOWNR, OBJONAME keywords to specify the object.

OBJLOCN=*location*

The optional name of the Db2® remote server (*location*) where the object is located. See [Specifying a Db2 object name on page 999](#).

OBJOOWNR=*owner*

The optional name of the owner of the object (*owner*). See [Specifying a Db2 object name on page 999](#).

OBJONAME=*name*

The object name (*name*) for the object. See [Specifying a Db2 object name on page 999](#).

TMOUT=*template_data_set_name(member)*

The PDS (*template_data_set_name*) and member name (*member*) of the FM/Db2 template that describes the Db2® object where the data is to be created. See [Specifying the template for a Db2 object on page 1000](#). The JCL generated by FM/Db2 always specifies TMOUT.

TOUTPUT=*ddname*

Defines a reference to a DD statement for the data sets which contain the template member that describes the record structure of your output data. The default is TDDOUT.

TOUTMEM=*member*

The name of the template member in the dataset(s) identified by the TOUTPUT parameter, if it has not been specified on the DD statement. This parameter must not be specified if the TCOU parameter is specified.

ROWS=*num*

The number of rows to be created. Valid range 1-99999999.

Example**Examples**

Example 1: Create 1000 rows of test data in table "ID1"."TABLE1". The initialization information for each column of the table are defined in template EMPDG.

```
//D2G JOB (acct),'name'
//* Create rows in table ID2.TABLE1.
/*
```

```
//FMNDB2 EXEC PGM=FMNDB2,PARM=( 'SSID=DSN1,SQID=ID1' )
//STEPLIB DD DSN=FMN.SFMNMOD1,DISP=SHR
// DD DSN=DB2V810.DSN1.SDSNEXIT,DISP=SHR
// DD DSN=DB2.V810.SDSNLOAD,DISP=SHR
//SYSPRINT DD SYSOUT=*
//FMNTSPRT DD SYSOUT=*
//SYSTEM DD SYSOUT=*
//SYSIN DD *
$$FILEM D2G OBJOUT="ID1"."TABLE1",
$$FILEM TMOUT=ID1.FM.TEMPLATE(EMPDG),
$$FILEM ROWS=1000
/*
```

Return codes

The return codes from the D2G function:

0

The function completed successfully

16

A serious error was encountered

Related functions

DBC

Copy data from one Db2® object to another ([DBC \(Copy\) batch command on page 963](#))

DBI

Import data from a sequential or VSAM file into a Db2® table ([DBI \(Import\) batch command on page 970](#))

DBX

Export data from a Db2® object to a sequential or VSAM file ([DBX \(Export\) batch command on page 979](#))

D2G

Create (generate) Db2® data ([D2G \(Data Generate\) batch command on page 994](#))

D2TP (Template create/update) batch command

Purpose

To create or update a template based on one Db2® object. The object must be accessible from the currently connected Db2® system.

Usage

The FM/Db2 template create/update utility creates a template if it does not exist, or updates the template if it does exist.

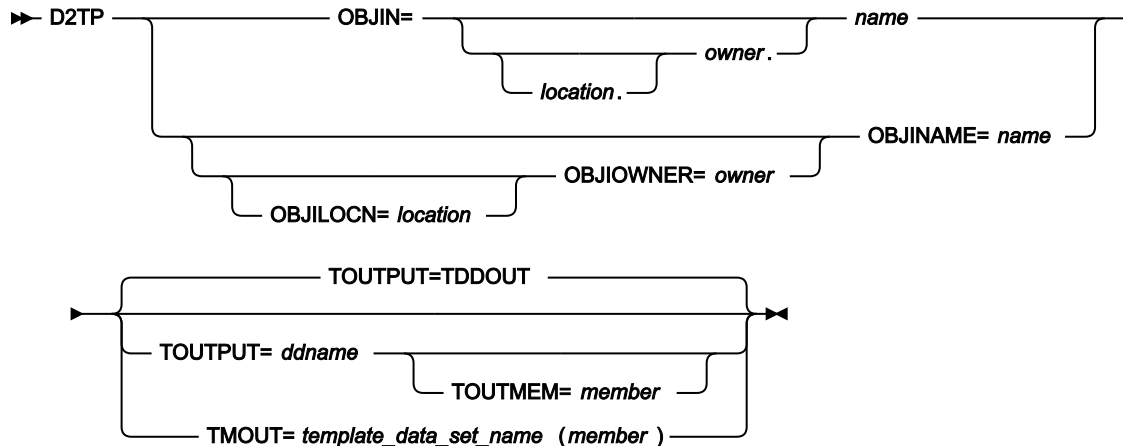

OBJIN location.owner.object

The optional name of the Db2® remote server (*location*) where the source object is located; the optional name of the owner of the source object (*owner*) and the source object name (*name*).

When *location* is not specified the current (local) Db2® server is used. When the *owner* is not specified the object name is qualified using the current SQLID. When FM/Db2 generates the utility control statements, the *owner* value is non-blank.

OBJIN should be used when the fully qualified name fits on a single line in the JCL deck. The last usable column is column 71. When the fully qualified name does not fit on a single line in the JCL deck, use one or more of the OBJILOCN, OBJIOWNER, OBJINAME keywords to specify the object.

OBJILOCN=*location*

The optional name of the Db2® remote server (*location*) where the source object is located. See [Specifying a Db2 object name on page 999](#).

OBJIOWNER=*owner*

The optional name of the owner of the source object (*owner*). See [Specifying a Db2 object name on page 999](#).

OBJINAME=*name*

The object name (*name*) for the source object. See [Specifying a Db2 object name on page 999](#).

TOUTPUT=*ddname*

Defines a reference to a DD statement for the data sets which contain the Db2® template that describes the target Db2® object. Concatenated DD statements are not supported and the referenced data set must be catalogued. If you have not specified a member name in the referenced DD statement, then you must provide a TOUTMEM keyword. If no TOUTPUT or TMOUT parameter has been provided, then TOUTPUT=TDDOUT is used. See [Specifying the template for a Db2 object on page 1000](#).

TOUTMEM=member

The name of the template member in the dataset identified by the TOUTPUT or TMOUT parameter. This parameter is ignored if the member name is provided with the DD statement or the TMOUT parameter. See [Specifying the template for a Db2 object on page 1000](#).

TMOUT=template_data_set_name(member)

The PDS (*template_data_set_name*) and member name (*member*) of the File Manager template that describes the target Db2® object. See [Specifying the template for a Db2 object on page 1000](#).

Example**Examples**

Example 1: Create a Db2® template for the DSN8810.EMP using TMOUT keyword.

```
//D2TPJOB (acct),'name'
/* Create template FMN.TEMPLATE(EMP) for DSN8810.EMP table
/*
//FMNDB2 EXEC PGM=FMNDB2,PARM=('SSID=DSN1,SQID=ID1')
//STEPLIB DD DSN=FMN.SFMNMOD1,DISP=SHR
// DD DSN=DB2V810.DSN1.SDSNEXIT,DISP=SHR
// DD DSN=DB2.V810.SDSNLOAD,DISP=SHR
//SYSPRINT DD SYSOUT=*
//FMNTSPRT DD SYSOUT=*
//SYSTEM DD SYSOUT=*
//SYSIN DD *
$$FILEM D2TP OBJIN="DSN8810"."EMP",
$$FILEM TMOUT=FMN.TEMPLATE(EMP)
/*
```

Example 2: Use TOUTPUT, TOUTMEM keywords to create output template for DSN8810.EMP

```
//D2TPJOB (acct),'name'
/* Create template FMN.TEMPLATE(EMP) for DSN8810.EMP table
/*
//FMNDB2 EXEC PGM=FMNDB2,PARM=('SSID=DSN1,SQID=ID1')
//STEPLIB DD DSN=FMN.SFMNMOD1,DISP=SHR
// DD DSN=DB2V810.DSN1.SDSNEXIT,DISP=SHR
// DD DSN=DB2.V810.SDSNLOAD,DISP=SHR
//TOUT DD DSN=FMN.TEMPLATE,DISP=SHR
//SYSPRINT DD SYSOUT=*
//FMNTSPRT DD SYSOUT=*
//SYSTEM DD SYSOUT=*
//SYSIN DD *
$$FILEM D2TP OBJIN="DSN8810"."EMP",
$$FILEM TOUTPUT=TOUT,TOUTMEM=EMP
/*
```

Example 3: Use Default output DD TDDOUT with TOUTMEM to create output template for DSN8810.EMP

```
//D2TPJOB (acct),'name'
/* Create template FMN.TEMPLATE(EMP) for DSN8810.EMP table
/*
//FMNDB2 EXEC PGM=FMNDB2,PARM=('SSID=DSN1,SQID=ID1')
//STEPLIB DD DSN=FMN.SFMNMOD1,DISP=SHR
```

```
//          DD DSN=DB2V810.DSN1.SDSNEXIT,DISP=SHR
//          DD DSN=DB2.V810.SDSNLOAD,DISP=SHR
//TDDOUT DD DSN=FMN.TEMPLATE,DISP=SHR
//SYSPRINT DD SYSOUT=*
//FMNTSPRT DD SYSOUT=*
//SYSTEM DD SYSOUT=*
//SYSIN DD *
$$FILEM D2TP OBJIN="DSN8810"."EMP",
$$FILEM TOUTMEM=EMP
/*
```

Example 4: Use Default output DD TDDOUT with member to create output template for DSN8810.EMP

```
//D2TPJOB (acct),'name'
/* Create template FMN.TEMPLATE(EMP) for DSN8810.EMP table
/*
//FMNDB2 EXEC PGM=FMNDB2,PARM=('SSID=DSN1,SQID=ID1')
//STEPLIB DD DSN=FMN.SFMNMOD1,DISP=SHR
//          DD DSN=DB2V810.DSN1.SDSNEXIT,DISP=SHR
//          DD DSN=DB2.V810.SDSNLOAD,DISP=SHR
//TDDOUT DD DSN=FMN.TEMPLATE(EMP),DISP=SHR
//SYSPRINT DD SYSOUT=*
//FMNTSPRT DD SYSOUT=*
//SYSTEM DD SYSOUT=*
//SYSIN DD *
$$FILEM D2TP OBJIN="DSN8810"."EMP"
/*
```

Example 5: Create 3 templates

```
//D2TPJOB (acct),'name'
/* Create template TOUT1-3 for DSN8810.EMP table
/*
//FMNDB2 EXEC PGM=FMNDB2,PARM=('SSID=DSN1,SQID=ID1')
//STEPLIB DD DSN=FMN.SFMNMOD1,DISP=SHR
//          DD DSN=DB2V810.DSN1.SDSNEXIT,DISP=SHR
//          DD DSN=DB2.V810.SDSNLOAD,DISP=SHR
//TOUT1 DD DSN=FMN.TEMPLATE(T1),DISP=SHR
//TOUT2 DD DSN=FMN.TEMPLATE(T2),DISP=SHR
//TOUT3 DD DSN=FMN.TEMPLATE(T3),DISP=SHR
//SYSPRINT DD SYSOUT=*
//FMNTSPRT DD SYSOUT=*
//SYSTEM DD SYSOUT=*
//SYSIN DD *
$$FILEM D2TP OBJIN="DSN8810"."EMP",TOUTPUT=TOUT1
$$FILEM D2TP OBJIN="DSN8810"."EMP",TOUTPUT=TOUT2
$$FILEM D2TP OBJIN="DSN8810"."EMP",TOUTPUT=TOUT3
/*
```

Specifying a Db2® object name

For those batch functions that require a Db2® object name, FM/Db2 automatically determines the appropriate keywords to specify the Db2® objects. For an input Db2® object this is OBJIN, or OBJILOCN (for location), OBJIOWNR (for owner) and OBJINAME (for name). For an output Db2® object this is OBJOUT, or OBJOLOCN (for location), OBJOOWNR (for owner) and OBJONAME (for name). The latter values are used when the OBJIN/OBJOUT value does not fit on a single line, or when the owner or name values contain special characters, for example, lowercase letters. In what follows, a special character is any

character other than the uppercase letters A-Z, the digits 0-9, the 3 characters reserved as alphabetic extenders for national languages (@#\$), and the underscore character (_).

When the owner or name value is split over two or more lines, the rules for continuing File Manager batch parameters must be observed. See the *File Manager User's Guide* for a full explanation. Briefly, each part of the value must be enclosed in apostrophes, and a comma must appear at the end of each line. The second and subsequent lines should include \$ \$FILEM followed by a space and the next part of the parameter value, enclosed in apostrophes. When the owner/name value contains special characters FM/Db2 automatically determines a unique two-character delimiter for the parameter value. The default is \\$, another delimiter is used if \\$ appears in the owner/name. The two-character delimiter appears at the start and finish of the owner/name value. When the owner/name value spans two or more lines, the two-character delimiter appears at the start and end of every line, and apostrophes are used at the start and end of each partial parameter value - to satisfy the continuation rules for File Manager batch parameters. When you code your own batch control statements and the owner/name values extend over 2 or more lines, you should specify each part of the name separately and not use OBJIN/OBJOUT. If the owner/name values contain special characters, you must specify a two-character delimiter at the start and end of the parameter value (or partial parameter value). The delimiter must not appear in the owner/name value, and the first character of the delimiter must be a special character except for apostrophe and quotation mark characters. When 2 character delimiters are used for an owner/name value, specify the owner/name exactly as is, do not double apostrophes or quotation characters, or omit any spaces.

Specifying the template for a Db2® object

The File Manager template for a Db2® object must be a File Manager/Db2 template that was generated by FM/Db2. Unlike the File Manager Base component, you cannot use a copybook to describe the structure of a Db2® object.

The JCL generated by FM/Db2 for the various batch functions uses the following batch keywords:

TMIN

For functions where there is an input Db2® object (export, print, copy, data create)

TMOUT

For functions where there is an output Db2® object (import, copy).

When it is necessary to specify the template data set name in the JCL statements, rather than via a File Manager batch keyword, you can use the alternative keywords TINPUT and TINMEM.

Specifying the template/copybook for a data set

To describe the structure of a data set you can use:

- A COBOL copybook
- A HLASM copybook
- A PL/I copybook
- A File Manager template

The JCL generated by FM/Db2 for the various batch functions always uses the TCIN or TCOU batch keywords, as described below:

TCIN

For functions where there is an input data set (import)

TCOU

For functions where there is an output data set (export)

When it is necessary to specify the template/copybook data set name in the JCL statements, rather than via a File Manager batch keyword, you can use the alternative keywords TINPUT and TINMEM, or TOUTPUT and TOUTMEM.

Appendix A. Messages

In this section, selected batch messages are listed in alphanumeric order. For each message, the information provided comprises:

- The message identifier.
- The text of the message.
- An explanation of the message.
- The required user response.

Messages issued by FM/Db2 have a unique alphanumeric identifier with the format:

```
FMNDannn
```

where:

a

Is an alphabetic character.

nnn

Is a 3-digit number.

When the message is issued by a batch function, the identifier is printed in front of the text of the message.

When the message is issued by an online function, the identifier is not displayed with the message. However, you can obtain the identifier of a message by typing `MSGID` on the command line and pressing Enter. This command causes the message identifier of the last message issued to be displayed on your screen.

Many of the online messages comprise a short message and long message. The short message is displayed in the upper right of the panel. The long message is only displayed if you press the F1 key when the short message is displayed.

FM/Db2 messages

FMNDA001

IBM® File Manager for z/OS® Version 15 Release 1

Explanation: Shows the version and release information for File Manager.

User response: No action required. Informational message.

FMNDA002

IBM® File Manager for z/OS® Db2® Component

Explanation: Shows the full component name for File Manager.

User response: No action required. Informational message.

FMNDA003

IBM® File Manager/Db2

Explanation: Shows the abbreviated component name for File Manager.**User response:** No action required. Informational message.

FMNDA004

Db2® Component

Explanation: Shows the short component name for File Manager.**User response:** No action required. Informational message.

FMNDA009

IBM® File Manager for z/OS® Version 15 Release 1 Db2 Component Licensed Materials - Property of IBM® and/or HCL5755-A03 Copyright IBM® Corporation 2001, 2017 - All Rights Reserved. Copyright HCL Technologies Ltd. 2017, 2024 - All Rights Reserved. Trademark of International Business Machines

Explanation: Shows the product name and copyright information for File Manager, Db2® component.**User response:** No action required. Informational message.

FMNDA011Panel *panel name* error. (short). PQUERY error processing ISPF panel *panel name*. (long)**Explanation:** An ISPF error was encountered issuing a PQUERY service for panel name *panel name*.**User response:** This is a File Manager internal error. Contact IBM® Support for assistance.

FMNDA012

Installation error. Db2® catalog table *Db2 catalog table name* is not available. Some FM/Db2 functions will be inoperative. Contact your Systems Programmer.

Explanation: FM/Db2 attempted to access the Db2® catalog table *Db2 catalog table name*. The access failed because *Db2 catalog table name* does not exist.**User response:** File Manager Db2® component requires access to various Db2® catalog tables for correct and optimal functionality. This message indicates an installation related problem. It is possible to define views of the Db2® catalog tables with a user-specified owner (example SYSIBMV), in place of the actual owner, (SYSIBM). One cause of this error is the use of a user-specified owner, but the views of the Db2® catalog tables with the user-specified owner do not exist (have not been created). Check the CATOWNER parameter, FMN2POPI macro in the FMN2POPT module. Check that views of the Db2® catalog tables, (for example SYSIBMV.SYSTABLES) exist. See *Preparing to customize FM/Db2* in the *File Manager for z/OS® Customization Guide* for more information.

FMNDA013

Installation error. SELECT access to Db2® catalog table *Db2 catalog table name* is required, but is not available. Some FM/Db2 functions will be inoperative. Contact your Systems Programmer.

Explanation: FM/Db2 attempted to access the Db2® catalog table *Db2 catalog table name*. The access failed. Access to *Db2 catalog table name* is essential to complete the current FM/Db2 function.

User response: FM/Db2 requires SELECT access to various Db2® catalog tables for correct and optimal functionality. This message indicates an installation problem; specifically that the Db2® authid used by the FM/Db2 user does not have SELECT access to the Db2® catalog table *Db2 catalog table name*. See *Preparing to customize FM/Db2* in the *File Manager for z/OS® Customization Guide*, and to point 8 in "Grant access to the Db2® catalogs", for more information. SELECT access to *Db2 catalog table name* needs to be GRANTED to the FM/Db2 user who encountered the error.

FMNDA014

Installation error. Access to column *column name* in Db2® catalog table *Db2 catalog table name* is required, but is not available. Some FM/Db2 functions will be inoperative. Contact your Systems Programmer.

Explanation: FM/Db2 attempted to access column *column name* of Db2® catalog table *Db2 catalog table name*. The access failed. SELECT access to column *column name* of *Db2 catalog table name* is essential to complete the current FM/Db2 function.

User response: FM/Db2 requires access to various Db2® catalog tables for correct and optimal functionality. This message indicates an installation related problem, specifically that the Db2® authid used by the FM/Db2 user does not have SELECT access on column *column name* in Db2® catalog table *Db2 catalog table name*. *Preparing to customize FM/Db2* in the *File Manager for z/OS® Customization Guide*, and to point 8 in the checklist "Grant access to the Db2® catalogs - required". SELECT access to column *column name* of *Db2 catalog table name* needs to be GRANTED to the FM/Db2 user who encountered the error.

FMNDA020

REQUIRED, BROWSE AUDITED

Explanation: Auditing is required, browse functions are subject to audit. Auditing options are specified in either the FMN2POPT module, or externally using a security product such as RACF®. See *File Manager for z/OS® Customization Guide* for more information. This message is displayed on the "Db2® connection Information" pop-up panel.

User response: No action required.

FMNDA021

REQUIRED, BROWSE NOT AUDITED

Explanation: Auditing is required, browse functions are not subject to audit. Auditing options are specified in either the FMN2POPT module or externally, using a security product such as RACF®. See *File Manager for z/OS® Customization Guide* for more information. This message is displayed on the "Db2® connection Information" pop-up panel.

User response: No action required.

FMNDA022

REQUIRED, SMF, BROWSE AUDITED

Explanation: Auditing is required, and auditing records are written to SMF, browse functions are subject to audit. Auditing options are specified in either the FMN2POPT module or externally, using a security product such as RACF®. See *File Manager for z/OS® Customization Guide* for more information. This message is displayed on the "Db2® connection Information" pop-up panel.

User response: No action required.

FMNDA023

REQUIRED, SMF, BROWSE NOT AUDITED

Explanation: Auditing is required, and auditing records are written to SMF, browse functions are not subject to audit. Auditing options are specified in either the FMN2POPT module or externally, using a security product such as RACF®. See *File Manager for z/OS® Customization Guide* for more information. This message is displayed on the "Db2® connection Information" pop-up panel.

User response: No action required.

FMNDA024

None

Explanation: FM/Db2 component does not write audit records. Auditing options are specified in either the FMN2POPT module, or externally using a security product such as RACF®. See *File Manager for z/OS® Customization Guide* for more information. This message is displayed on the "Db2® connection Information" pop-up panel.

User response: No action required.

FMNDA025

SAF-RULE CONTROLLED

Explanation: Auditing within FM/Db2 is controlled using SAF rules, defined using a security product such as RACF®. Auditing options are specified in either the FMN2POPT module or externally, using a security product such as RACF®. See *File Manager for z/OS® Customization Guide* for more information. This message is displayed on the "Db2® connection Information" pop-up panel.

User response: No action required.

FMNDA026

SAF-RULE CONTROLLED, AUDITING NOT ALLOWED

Explanation: Auditing within FM/Db2 is controlled using SAF rules, defined using a security product such as RACF®. These rules specifically prevent the writing of audit records by FM/Db2. Auditing options are specified in either the FMN2POPT module or externally, using a security product such as RACF®. See *File Manager for z/OS® Customization Guide* for more information. This message is displayed on the "Db2® connection Information" pop-up panel.

User response: No action required.

FMNDA027

DEMAND, BROWSE AUDITED

Explanation: Demand auditing is in effect, browse functions are subject to audit. Demand auditing means that an audit report is automatically printed at the end of the current editor session. Auditing options are specified in either the FMN2POPT module or externally, using a security product such as RACF®. See *File Manager for z/OS® Customization Guide* for more information. This message is displayed on the "Db2® connection Information" pop-up panel.

User response: No action required.

FMNDA028

DEMAND, BROWSE NOT AUDITED

Explanation: Demand auditing is in effect, browse functions are not subject to audit. Demand auditing means that an audit report is automatically printed at the end of the current editor session. Auditing options are specified in either the FMN2POPT module, or externally using a security product such as RACF®. See *File Manager for z/OS® Customization Guide* for more information. This message is displayed on the "Db2® connection Information" pop-up panel.

User response: No action required.

FMNDA030

OPTIONAL, OFF, BROWSE AUDITED

Explanation: Auditing is optional and initially off, browse functions are subject to audit. Auditing options are specified in either the FMN2POPT module, or externally using a security product such as RACF®. See *File Manager for z/OS® Customization Guide* for more information. This message is displayed on the "Db2® connection Information" pop-up panel.

User response: No action required.

FMNDA031

OPTIONAL, OFF, BROWSE NOT AUDITED

Explanation: Auditing is optional and initially off, browse functions are not subject to audit. This message is displayed on the "Db2® connection Information" pop-up panel.

User response: No action required.

FMNDA032

OPTIONAL, PROFILE, BROWSE AUDITED

Explanation: Auditing is optional and the current value is set based on the user ISPF profile. Browse functions are subject to audit. Auditing options are specified in either the FMN2POPT module or externally, using a security product such as RACF®. See *File Manager for z/OS® Customization Guide* for more information. This message is displayed on the "Db2® connection Information" pop-up panel.

User response: No action required.

FMNDA033

OPTIONAL, PROFILE, BROWSE NOT AUDITED

Explanation: Auditing is optional and the current value is set based on the user ISPF profile. Browse functions are not subject to audit. Auditing options are specified in either the FMN2POPT module, or externally using a security product such as

RACF®. See *File Manager for z/OS® Customization Guide* for more information. This message is displayed on the "Db2® connection Information" pop-up panel.

User response: No action required.

FMNDA034

OPTIONAL, SMF, OFF, BROWSE AUDITED

Explanation: Auditing is optional and audit records are written to SMF. The audit option is initially off, and browse functions are subject to audit. Auditing options are specified in either the FMN2POPT module, or externally using a security product such as RACF®. See *File Manager for z/OS® Customization Guide* for more information. This message is displayed on the "Db2® connection Information" pop-up panel.

User response: No action required.

FMNDA035

OPTIONAL, SMF, OFF, BROWSE NOT AUDITED

Explanation: Auditing is optional and audit records are written to SMF. The audit option is initially off, browse functions are not subject to audit. Auditing options are specified in either the FMN2POPT module, or externally using a security product such as RACF®. See *File Manager for z/OS® Customization Guide* for more information. This message is displayed on the "Db2® connection Information" pop-up panel.

User response: No action required.

FMNDA036

OPTIONAL, SMF, PROFILE, BROWSE AUDITED

Explanation: Auditing is optional and audit records are written to SMF. The current value for the audit option is set based on the user ISPF profile, browse functions are subject to audit. Auditing options are specified in either the FMN2POPT module, or externally using a security product such as RACF®. See *File Manager for z/OS® Customization Guide* for more information. This message is displayed on the "Db2® connection Information" pop-up panel.

User response: No action required.

FMNDA037

OPTIONAL, SMF, PROFILE, BROWSE NOT AUDITED

Explanation: Auditing is optional and audit records are written to SMF. The current value for the audit option is set based on the user ISPF profile, browse functions are not subject to audit. Auditing options are specified in either the FMN2POPT module, or externally using a security product such as RACF®. See *File Manager for z/OS® Customization Guide* for more information. This message is displayed on the "Db2® connection Information" pop-up panel.

User response: No action required.

FMNDA038

DEMAND, SMF, BROWSE AUDITED

Explanation: Demand auditing is in effect, audit records are written to SMF, browse functions are subject to audit. Demand auditing means that an audit report is automatically printed at the end of the current editor session. Auditing options are specified in either the FMN2POPT module, or externally using a security product such as RACF®. See *File Manager for z/OS® Customization Guide* for more information. This message is displayed on the "Db2® connection Information" pop-up panel.

User response: No action required.

FMNDA039

DEMAND, SMF, BROWSE NOT AUDITED

Explanation: Demand auditing is in effect, audit records are written to SMF, browse functions are not subject to audit. Demand auditing means that an audit report is automatically printed at the end of the current editor session. Auditing options are specified in either the FMN2POPT module, or externally using a security product such as RACF®. See *File Manager for z/OS® Customization Guide* for more information. This message is displayed on the "Db2® connection Information" pop-up panel.

User response: No action required.

FMNDA040

Recovered from Db2® abend (short). FM/Db2 has recovered from an abend in Db2®. The FM/Db2 function that was executing when the Db2® abend occurred has been terminated. (long)

Explanation: A Db2® abend occurred during processing for the current function. The File Manager subtask responsible for connection to Db2® has been terminated, and a new subtask established. Any uncommitted changes made by the FM/Db2 function prior to the abend will have been backed out.

User response: Document information about the function being used when the abend occurs. If the problem occurs again notify your System Programmer. If there is no Db2-related problem that might explain the abend, contact IBM® Support.

FMNDA050

Object not found (*ID*) (Short). No Db2® object of the appropriate type matches the combination of object details entered in Db2® system *ID*. Press Help for more information (Long).

Explanation: This message is issued when a Db2® object name has been entered on a function entry panel, but Db2® reports that the object name does not exist. Db2® SSID is the name of the currently connected Db2® sub-system. The function cannot be processed until the reason for the error is determined and corrected.

User response:

Press the the Help Pkey (PF1 by default) twice to show, in order, the long message (see above) and the extended help, which is a panel. The information on the help panel is shown below.

- The specified Db2® object does not exist:
 - Is the spelling correct?
 - Are you connected to the correct Db2® system?
- There was an uppercase/lowercase mismatch. The Translate Db2® object name option is OFF, if the name that was entered contains lower case characters, it may not be recognized. To change the Translate Db2® object name option select option 0.0.2.
- If no OWNER was specified, FM/Db2 used *authid* to qualify the name.

- A synonym name was specified, but the owner of the synonym is not *authid*. A synonym name is only recognized when the current SQLID and the synonym owner match.
- The object name specified is too long to be displayed on the function entry panel. If you used EXPAND to enter a long name in a field, you must use EXPAND again to clear all parts of the name. Clearing the field on the function entry panel only sets the visible part of the field to spaces.

Read the information on the panel and consider the various causes of the error in turn until the cause is determined.

FMNDA051

Invalid location (Short). Location *LOC* is not defined in SYSIBM.LOCATIONS at the local server (Long).

Explanation: This message is issued when a Db2® location value has been entered on a function entry panel, but Db2® reports that the location cannot be found. *Location* is the name of the location value that could not be located. The function cannot be processed until the reason for the error is determined and corrected.

User response: You can enter * in the location field and press Enter to show a list of locations defined at the local server. This feature may not be available if the product installer has chosen to disable it. If you cannot determine the reason why the entered location value is invalid contact your Db2® administrator for assistance.

FMNDA052

Object not found (Short). No Db2® object at location *LOC* matches the combination of object details entered at Db2® system *ID*. Press Help for more information. Object not found (short).

Explanation: This message is issued when a Db2® object name has been entered on a function entry panel, but Db2® reports that the object name does not exist. *Db2 SSID* is the name of the currently connected Db2® sub-system. *Location* is the value entered in the LOCATION entry field. The function cannot be processed until the reason for the error is determined and corrected.

User response: Press the Help PFkey (PF1 by default) twice to show, in order, the long message (see above) and the extended help, which is a panel. The information on the help panel is shown below: Possible reasons why Db2® could not find this object include:

- The specified Db2® object does not exist:
 - Is the spelling correct?
 - Have you specified the correct location?
- There was an uppercase/lowercase mismatch. The Translate Db2® object name option is OFF, if the name that was entered contains lower case characters, it may not be recognized. To change the Translate Db2® object name option select option 0.0.2.
- If no OWNER was specified, FM/Db2 used *authid* to qualify the name.
- A synonym name was specified, but the owner of the synonym is not specified. A synonym name is only recognized when the current SQLID and the synonym owner match.
- The object name specified is too long to be displayed on the function entry panel. If you used EXPAND to enter a long name in a field, you must use EXPAND again to clear all parts of the name. Clearing the field on the function entry panel only sets the visible part of the field to spaces.

Read the information on the panel and consider the various causes of the error in turn until the cause is determined.

FMNDA053

Check name (spaces) (Short). The Db2® object name cannot be found. There are two or more consecutive spaces in the object name, this might indicate unwanted text in the non-visible parts of a scrollable field. Place the cursor on the object name field and press the Expand PF key to verify the contents. (long).

Explanation: A value entered in a name field has two or more consecutive spaces, for example: ABC FG. The name field is an ISPF scrollable field, allowing up to 128 characters to be entered, however not all characters are displayed. It is possible that unwanted information has been entered in the part of the field that is not displayed. Because FM/Db2 validates the DB2® name based on the entire contents of the field, "Object not found" errors will occur.

Explanation: This message is issued when a Db2® object name has been entered on a function entry panel, but Db2® reports that the object name does not exist. The Db2® object name contains two or more consecutive spaces, which may be valid, but more likely indicates the cause of the error.

User response: Place the cursor on the object name field and press the PFKey assigned to EXPAND (PF4 by default) to show the complete field contents. If the EXPAND key is not available you can type the EXPAND command on the command line, position the cursor on the object name field and press ENTER to show the complete field contents. Remove any spurious data and retry the operation.

FMNDA054

Check owner (spaces) (Short). The Db2® object name cannot be found. There are two or more consecutive spaces in the object owner, this might indicate unwanted text in the non-visible parts of a scrollable field. Place the cursor on the object owner field and press the Expand PF key to verify the contents.

Explanation: A value entered in an owner field has two or more consecutive spaces, for example: ABC FG. The owner field is an ISPF scrollable field, allowing up to 128 characters to be entered, however not all characters are displayed. It is possible that unwanted information has been entered in the part of the field that is not displayed. Because FM/Db2 validates the DB2® owner based on the entire contents of the field, "Object not found" errors will occur.

User response: Place the cursor on the object owner field and press the PFKey assigned to EXPAND (PF4 by default) to show the complete field contents. If the EXPAND key is not available you can type the EXPAND command on the command line, position the cursor on the object owner field and press ENTER to show the complete field contents. Remove any spurious data and retry the operation.

FMNDA055

No Db2® TABLE matches the value entered. It is possible a Db2® object (eg view) that matches the name entered exists - however the selected Db2® utility supports Db2® tables ONLY. (long).

Explanation: This message is issued by the Db2® utilities function when an object not found condition is encountered. Some Db2® utilities require a table as input, and will not process a view, synonym or other objects.

User response: Use the FM/Db2 object list utility to display information about the Db2® object. Determine whether the object exists, and determine the type of the object (table, view etc). Consult the Db2® utilities manual for the appropriate version of Db2® to determine which object types may be used.

FMNDA100

Alloc. error -unit (short). The attempt to allocate a temporary data set for the SQL statement failed. UNIT unit is invalid. Check the temporary data set allocation option values. (long).

Explanation: File Manager attempted to allocate a temporary data set, in which to store SQL or some other information. The allocation attempt failed, the most likely explanation is that the UNIT parameter specified on the "Set Temporary Data Set Allocation Options" panel is invalid. This system option panel is accessed using 0.0.8 from the FM/Db2 main menu panel.

User response: Check the value specified for the UNIT parameter on the "Set Temporary Data Set Allocation Options" panel. Remove any value and retry the operation. If this resolves the problem, contact your system's programmer for advice on valid/invalid UNIT values.

FMNDA997

**** Limit of Rows Retrieved ****

Explanation: This message appears at the bottom of a File Manager/Db2 editor session, when a row count value (example 100) was specified on the editor function entry panel, and FM/Db2 read that many rows into the editor session without reaching the end of the Db2® object.

User response: No action required. Informational message.

FMNDA998

Internal Logic Error (*module name*) - *message*

Explanation: This is an internal error message, indicating a problem with the processing of the Db2® attachment.

User response: Contact IBM® Support.

FMNDB000

JESCT not available (short). JESCT control block currently not available for Db2® subsystem selection. (long).

Explanation: This is an internal error. FM/Db2 attempted to access the JESCT however the pointer was zero.

User response: Contact IBM® Support.

FMNDB001

No Db2® subsystems (short). No Db2® Subsystems have been defined on this system. File Manager Db2 component can not run on this system. (long).

Explanation: FM/Db2 could not find any Db2® systems defined on the current z/OS® system.

User response: If there are Db2® systems defined on the current z/OS® system, contact IBM® Support.

FMNDB002

SSID *Db2 SSID* not matched (short). No Db2® Subsystems matching *Db2 SSID* are defined on this system. (long).

Explanation: This message may be issued during Db2® subsystem selection when a name with a wildcard (example DSN*) is entered in the Db2® SSID field on the FM/Db2 main menu. No matching Db2® systems were found.

User response: No action required. Informational message. Clear the Db2® SSID entirely to show all Db2® systems.

FMNDB003

Db2 SSID not defined to z/OS® (short) . Db2® Subsystem/Group *Db2 SSID* is not defined to the local z/OS® system. (long).

Explanation: Db2® system *Db2 SSID* is not defined on the local z/OS® system. This message may be issued in response to an attempt to change the currently connected Db2® system using a command like SSID XXXX.

User response: Check that *Db2 SSID* is correctly specified. Correct the name and try again.

FMNDB004

SSID *Db2 SSID* not active (short). Db2® subsystem/group *Db2 SSID* is not currently active. (long).

Explanation: The Db2® system or group *Db2 SSID* is defined on the local z/OS® system but is inactive (stopped).

User response: FM/Db2 cannot connect to inactive Db2® systems. Determine the reason why the Db2® system is inactive. When the Db2® system is started, attempt the connection again.

FMNDB005

Already connected (short). FM/Db2 is currently connected to Db2® system *Db2 SSID*. (long).

Explanation: FM/Db2 is already connected to Db2® system *Db2 SSID*. This message may be issued in response to an attempt to change the currently connected Db2® system using a command like SSID XXXX.

User response: None if *Db2 SSID* was correctly specified. Otherwise, check the Db2® SSID, make appropriate corrections, and try again.

FMNDB006

Cannot connect to Db2® *Db2 SSID*, RRSF function RC &RC. Reason *reason code*.

Explanation: A call to the Db2® RRSF attachment failed. *Db2 SSID* is the currently connected Db2® system; *function* is the failing RRSF function and *reason* is the failing reason code.

User response: This error indicates an installation error. Confirm that the RRSF attachment is required. You will typically find that the CAF attachment meets all your requirements. The Db2® attachment used by FM/Db2 is specified in the FMN2POPT module. See *File Manager for z/OS® Customization Guide* for a detailed explanation. Ensure that the appropriate Db2® interface module (DSNRLI) is accessible to FM/Db2. If these actions fail to resolve the problem, contact IBM® Support.

FMNDB007

A Db2® Subsystem has not been specified.

Explanation: A Db2® system has not been specified. FM/Db2 must connect to a Db2® system before it can perform useful work.

User response: Use the "Db2® SSID" field on the FM/Db2 main menu to specify the name of a Db2® system.

FMNDB008

Subsystem *Db2 SSID* does not identify a uniquely active Db2® subsystem

Explanation: A Db2® SSID value was specified, but it does not uniquely identify a Db2® system. An example is DSN*.

User response: Specify an unambiguous value.

FMNDB009

Db2® subsystem *Db2 SSID* is not currently active on this system.

Explanation: The specified Db2® SSID value *Db2 SSID* is inactive.

User response: Take action to start the Db2® system. When the Db2® system is active, retry the operation.

FMNDB010

Row *Row value 1* of *Row value 2*

Explanation: This message is displayed on various selection lists, including the Db2® subsystem selection panel. *Row value 1* is the first row shown on the display and there are a total of *Row value 2* rows available for display.

User response: No action required. Informational message.

FMNDB011

Invalid selection (short). Enter "S" or "/" to select the required Db2® subsystem. (long).

Explanation: A character other than "S" or "/" was entered against an entry on the Db2® subsystem selection panel. The only valid characters for selecting an entry are "S" or "/".

User response: Use either "S" or "/" to select the required entry.

FMNDB012

SSID *Db2 SSID* not active (short). Selected Db2® subsystem *Db2 SSID* is not currently active on this system. (long).

Explanation: An attempt was made to select Db2® system *Db2 SSID* from the Db2® subsystem selection panel. This Db2® system is not currently active.

User response: Determine why the Db2® system is inactive and take action to start it. When the Db2® system is active, retry the operation.

FMNDB013

Selection terminated (short) Db2® subsystem selection was terminated with the EXIT *PF* key command. File Manager Db2® is not currently connected to any Db2® subsystem. (long)

Explanation: The user pressed the EXIT *PF* key on the Db2® subsystem selection menu without making any selection. The FM/Db2 main menu is re-displayed. FM/Db2 is not connected to any Db2® system.

User response: No action required. Informational message. It is necessary to connect to a Db2® system before performing any FM/Db2 functions.

FMNDB014

Display refreshed (short). List of Db2® Subsystems has been refreshed using current information. (long).

Explanation: The user issued the REFRESH primary command on the Db2® subsystem selection list panel. The list of Db2® systems displayed is refreshed.

User response: No action required. Informational message.

FMNDB015

SSID *Db2 SSID* displayed (short). Db2® Subsystems matching *Db2 SSID* are displayed. (long).

Explanation: The user issued a *SHOW Db2 SSID* command on the Db2® subsystem selection list panel. The list of Db2® systems that match the SSID specification are displayed. The SSID value specified may include wild cards, example DSN*.

User response: No action required. Informational message.

FMNDB016

Command not active (short). The command to change the Db2® subsystem is not available from this panel. (long).

Explanation: A command to change the currently connected Db2® SSID was issued on a panel where the command is not available.

User response: The currently connected Db2® SSID can only be changed when no FM/Db2 function is active. Return to a function-entry, or menu panel, and reissue the command.

FMNDB017

SSID name required (short). Enter the Db2® subsystem name that FM/Db2 should connect to. (long).

Explanation: A command to change the currently connected Db2® system was issued without an operand.

User response: The command to change the currently connected Db2® system requires an operand, the Db2® SSID of the Db2® system to which connection is desired. Reissue the command with the required Db2® system SSID as the operand.

FMNDB018

Invalid remote server (short). Remote server *Db2 server name* is not a Db2® UDB for z/OS® system. Connection to remote servers that are not Db2® UDB for z/OS® servers is not supported. (long).

Explanation: A Db2® server name was entered in the location field on a FM/Db2 function entry panel. While the Db2® server name is defined as a remote Db2® server at the local Db2® system, this server is not a Db2® UDB for z/OS® system. FM/Db2 only supports remote connections to Db2® UDB for z/OS® servers.

User response: Connection to this remote Db2® server is not supported. Specify another name.

FMNDB019

Version *Db2 version* invalid (short). The remote Db2® version/release is *Db2 version*. Connection is supported for Db2® Version 9 and later systems only. (long).

Explanation: A Db2® server name was entered in the location field on a FM/Db2 function entry panel. The version of the remote Db2® system is *Db2 version*. Connection to this version of Db2® is not supported.

User response: Connection to this remote Db2® server is not supported. Specify another name.

FMNDB020

Operating System is unsupported. Can not run File Manager Db2 component.

Explanation: This is an internal error. During MVS™ token initialization an unsupported version of z/OS® was detected. It is not possible to run FM/Db2 against this version of z/OS®, or its predecessors.

User response: Ensure that the host operating system is at a level specified in the Program Directory. If you believe that the host operating system is at a supported level, contact IBM® Support.

FMNDB021

Error in *function* Callable Service Routine, Return code *return code*.

Explanation: This is an internal error. A call to *function* failed with return code *return code*.

User response: Contact IBM® Support.

FMNDB022

Db2® Subsystem not set (short). Error invoking File Manager Db2 component. Db2® Subsystem has not been set. (long).

Explanation: An attempt was made to run FM/Db2, without correctly specifying a Db2® SSID name, or without first connecting to a Db2® system.

User response: If the message occurs in batch, check that the Db2® SSID value is correctly specified in the JCL. If this fails to resolve the problem, start FM/Db2 online and regenerate the batch JCL. If the batch job still fails contact IBM® Support. If the message occurs online, return to the FM/Db2 main menu and enter the name of a valid Db2® SSID in the Db2® SSID field, press Enter to connect.

FMNDB023

Cannot connect to Db2® *Db2 SSID*, CAF *function* RC *return code*, Reason *reason code*.

Explanation: FM/Db2 attempted to call the Db2® CAF interface with function *function*. The call failed with return code *return code* and reason code *reason code*.

User response: This message usually indicates an installation or set up problem. The most likely causes are:

1. Not binding the FM/Db2 plan (FMN2PLAN) by default.
2. Specifying an incorrect Db2® plan name in the FMN2POPT module.

See *File Manager for z/OS® Customization Guide* for more information.

FMNDB024

Unable to load Db2® Interface module *module name*. Abend Code *abend code-reason code*. Check STEPLIB/LINKLIST for Db2® load libraries.

Explanation: FM/Db2 attempted to load the Db2® interface module *module name*. The load failed with abend code *abend code* and reason *reason code*.

User response: This is probably a customization or setup problem. If the Abend is 806 (module not found):

1. Check that the Db2® load library has been correctly specified in the FMN2SSDM macro for the Db2® system in question.
2. If the FMN2POPT module does not include the Db2® load library names for the Db2® system, check any applicable STEPLIB/JOBLIB and LINKLIST for the Db2® load library. The Db2® load library must reside in a library that is accessible using the standard search order for the LOAD macro.

For other abends refer to point (1) as a starting point. If this fails to resolve the problem, contact IBM® Support.

FMNDB025

Not currently connected to a Db2® subsystem.

Explanation: FM/Db2 is not currently connected to any Db2® subsystem.

User response: No action required. Informational message. It will be necessary to connect to a Db2® system prior to performing any FM/Db2 functions.

FMNDB026

Subsystem: *Db2 SSID*, Db2® release: *Db2 VRM indicator*.

Explanation: FM/Db2 is connected to Db2® system *Db2 SSID*. The version of this Db2® system is *Db2 VRM indicator*.

User response: No action required. Informational message. issued in a File Manager/Db2 batch job.

FMNDB027

FM/Db2 plans: *Plan name 1*, *Plan name 2*

Explanation: The FM/Db2 plan names are *Plan name 1* and *Plan name 2*.

User response: No action required. Informational message. issued in a File Manager/Db2 batch job.

FMNDB028

Description: *user specified description*.

Explanation: This message *user specified description* appears in the "About Db2®" popup panel. The *user specified description* is the value specified in the FMN2SSDM macro, DESC parameter for the appropriate Db2® system.

User response: No action required. Informational message.

FMNDB029

Db2 SSID executing Db2® level *Db2 level 1*. Minimum supported level is *Db2 level 2*.

Explanation: This message is issued when an attempt is made to connect to a Db2® system at an unsupported version/maintenance level. The level of Db2® system *Db2 SSID* is *Db2 level 1*. The minimum supported level is *Db2 level 2*.

User response: Connection to the Db2® system is not supported. See *File Manager for z/OS® Customization Guide* and *File Manager for z/OS® User's Guide and Reference* for information on supported Db2® versions, for the version of FM/Db2 in use.

FMNDB030

Db2I unavailable (short). Unable to start Db2I. Check STEPLIB/LINKLIST for Db2® libraries. (long).

Explanation: A ISPF PQUERY service for panel DSNEPRI was issued, the request failed.

User response: This error indicates an installation or setup problem. Ensure that the Db2® libraries are available to the FM/Db2 user. The recommended way to do this is to code the Db2® libraries in the FMN2SSDM macro entry for each Db2® system that will be accessed by FM/Db2. See *File Manager for z/OS® Customization Guide* for more information.

FMNDB031

SQL ID not authorized (short). You are not authorized to use the SQL user ID *Db2 authid* on Db2® Subsystem *Db2 SSID*. (long).

Explanation: An attempt was made to change the current SQLID on Db2® system *Db2 SSID* to *Db2 authid*. The attempt failed. The usual reason for this is that the FM/Db2 user is not authorized to use *Db2 authid*.

User response: Consult with either the Db2® or Security Administrator as to the reason why access to *Db2 authid* is not available.

FMNDB032

You are not authorized to use the SQL user ID *Db2 authid*.

Explanation: An attempt was made to change the current SQLID to *Db2 authid*. The attempt failed. The usual reason for this is that the FM/Db2 user is not authorized to use *Db2 authid*.

User response: Consult with either the Db2® or Security Administrator as to the reason why access to *Db2 authid* is not available.

FMNDB033

Auditing: *Audit status* :

Explanation: This message is used to display the audit status for the currently connected Db2® system, and appears on the "About Db2®" pop-up panel.

User response: No action required. Informational message.

FMNDB034

No Db2® subsystem with name *Db2 SSID*. CAF function RC return code, Reason reason code.

Explanation: A call to the CAF interface, function *function* for Db2® system *Db2 SSID* failed with RC return code and reason reason code. The reason is that the nominated Db2® system does not exist.

User response: Check the Db2® system name and try again.

FMNDB035

Db2® group/subsystem *Db2 SSID* is not active, CAF function RC return code, Reason reason code.

Explanation: A call to the CAF interface, function *function* for Db2® system *Db2 SSID* failed with RC reason code and reason reason code. The reason is that the nominated Db2® system is not active.

User response: Start the Db2® system. Retry the operation.

FMNDB036

Not authorized to connect to *Db2 SSID*, CAF function *function* RC *return code*, Reason *reason code*.

Explanation: A call to the CAF interface, function *function* for Db2® system *Db2 SSID* failed with RC *return code* and reason *reason code*. The likely reason is that the FM/Db2 user is not authorized to connect to the nominated Db2® system.

User response: Consult with either the Db2® or Security Administrator as to the reason why the FM/Db2 user is not authorized to connect to the Db2® system *Db2 SSID*.

FMNDB037

FM/Db2 not installed on *Db2 SSID*, CAF function *function* RC *return code*, Reason *reason code*.

Explanation: A call to the CAF interface, function *function* for Db2® system *Db2 SSID* failed with RC *return code* and reason *reason code*. The reason is that FM/Db2 has not been installed on Db2® system *Db2 SSID*.

User response: Verify that FM/Db2 is installed on Db2® system *Db2 SSID*. Retry the operation.

FMNDB038

Unable to load options module *module name*. Probable installation error.

Explanation: FM/Db2 attempted to load module *module name*. The attempt failed. The cause is an installation error; the File Manager load library is not available to the FM/Db2 user.

User response: Check the allocation of the FM/Db2 load library using, for example, 'TSO ISRDDN&' (under ISPF). Ensure that *module name* is located in a load library accessible to the FM/Db2 user.

FMNDB039

FMN2POPI module invalid (short). The internal structure of FMN2POPT is invalid. Probable installation error. (long).

Explanation: FM/Db2 loaded the FMN2POPT module, the contents are corrupt and unusable.

User response: The FMN2POPT module was assembled using an older version of FM/Db2. Reassemble the FMN2POPT module, paying attention to the SYSLIB statements in the JCL, to ensure the correct versions of the FM/Db2 macros are used. Retry the operation.

FMNDB040

SSID *Db2 SSID* not available (short). Installation settings prevent the selection of Db2® subsystem/group *Db2 SSID*. (long).

Explanation: An attempt was made to connect to Db2® system *Db2 SSID*. This Db2® system is marked "Unavailable" in the FMN2POPT installation module. The Db2® system cannot be used.

User response: Select another Db2® system.

FMNDB041

Incompatible connection already active, CAF *function*, RC *return code*, Reason *reason code*.

Explanation: FM/Db2 attempted to call the CAF interface, function *function*. An error occurred, RC *return code* and Reason *reason code*. The cause is an incompatibility (release level mismatch) between the Db2® and call attachment code.

User response: This is an installation error. Check the specification of the Db2® libraries in the FMN2POPT, FMN2SSDM macro for the appropriate Db2® system, with attention to the Version/maintenance level of these libraries compared with the Version/maintenance level of the Db2® system.

FMNDB042

Db2 SSID Release Minimum Release (short). *Db2 SSID* executing Db2® level *Release*. The minimum supported level of Db2® for this release of File Manager is *Minimum Release*. FM/Db2 may operate successfully with Db2® Version 8, however no support will be provided for any Version 8 specific problems that may be encountered.

Explanation: FM/Db2 connected to *Db2 SSID* which is at version and release *Release*. The minimum supported Db2® version/release for this version of FM/Db2 is *Minimum Release*, which is greater than *Release*.

User response: No action required. Informational message. FM/Db2 should operate without issues. However should a problem be encountered that is specific to Db2® version 8, no support will be available.

FMNDB043

Db2 SSID Release Maximum Release (short). *Db2 SSID* executing Db2® level *Release*. This version and release of File Manager does not currently support connection to Db2® *Maximum Release* (or later) subsystems.

Explanation: An attempt was made to connect to *Db2 SSID* which is at version and release *Release*. The maximum supported Db2® version/release for this version of FM/Db2 is *Maximum Release*, which is less than *Release*. The connection is not established and the Db2® system cannot be accessed. All versions of software are designed to work with a limited set (of version and release levels) of other software.

User response: Contact IBM® Support for information about more recent versions of FM/Db2 which may support the Db2® version/release of *Db2 SSID*.

FMNDB044

Communications error (short). FM/Db2 encountered an SQL error *SQL error code* attempting to access the Db2® system at *Db2 location name*. This indicates that the remote Db2® system is not available, or that there was a security related problem. (long).

Explanation: FM/Db2 attempted to connect to remote Db2® server *Db2 location name*. The connection failed with SQLCODE *SQL error code*.

User response: Look up *SQL error code* in the Db2® messages and codes manual and take the action indicated. This error indicates a set up problem. One possibility is incorrect DRDA® definitions for Db2® location name at the local Db2® server.

FMNDB045

Not defined.

Explanation: A location nickname was not defined in the FMN2POPT module.

User response: Check the FMN2SSDM definitions in the FMN2POPT module and add the location nickname to the appropriate entry.

FMNDB046

Defined but no location specified.

Explanation: A location nickname was specified, but no location, to which the nickname refers, was specified.

User response: Check the FMN2SSDM macro for the currently connected Db2® system. Ensure that both a location and location nickname are specified.

FMNDB047

Authorization error (short). FM/Db2 encountered an SQL error (-725) attempting to access the Db2® system at *Remote location name*. This can occur when the user has changed the SQLID at the local Db2® system, but the user does not have authority to use this SQLID at the remote Db2® system. (long).

Explanation: Refer to the long message.

User response: Ensure that the user has access to the remote Db2® system *Remote location name* using the currently set Db2® SQLID.

FMNDB048

FMN2DATA load failed (short). Unable to load FMN2DATA module. Probable installation error. (long).

Explanation: FM/Db2 attempted to load data module FMN2DATA. The attempt failed. FM/Db2 cannot operate without this module.

User response: This is a customization or set up problem. Check that FMN2DATA is present in the load libraries accessible to the FM/Db2 user. This module is normally located in the SFMNM0D1 library.

FMNDB049

FMN2DENU load failed (short). Unable to load FMN2DENU module. Probable installation error. (long).

Explanation: FM/Db2 attempted to load data module FMN2DENU. The attempt failed. FM/Db2 cannot operate without this module.

User response: This is a customization or setup problem. Check that FMN2DENU is present in the load libraries accessible to the FM/Db2 user. This module is normally located in the SFMNM0D1 library.

FMNDB050

ATTACH of FM/Db2 subtask program failed with return code *return code*.

Explanation: FM/Db2 attempted to attach the subtask responsible for Db2® access. The attempt failed with RC *return code*. FM/Db2 cannot operate without the subtask for consistency.

User response: This is an internal error. Retry the operation. If the problem persists check for installation related problems and contact IBM® Support.

FMNDB051

Communications error (SQLCODE=SQL *error code*) accessing *Db2 SSID*.

Explanation: FM/Db2 attempted to access *Db2 SSID* and received a communications error *SQL error code*.

User response: Look up SQL error code in the Db2® messages and codes manual and take the action indicated.

FMNDB052

Db2® server *server name* is not a Db2® UDB for z/OS® server, code=*return code*.

Explanation: FM/Db2 (in batch) connected to Db2® server *server name*. The connect information indicates that the Db2® server is not a Db2® UDB for z/OS® server. Connection is only supported to Db2® UDB for z/OS® servers.

User response: Specify the name of a Db2® UDB for z/OS® server only.

FMNDB053

SET DECFLOAT ROUNDING MODE failed with return code *return code*.

Explanation: FM/Db2 attempted to set the DECFLOAT ROUNDING MODE, the attempt failed with return code *return code*.

User response: Check that the Db2® system is operational. If the problem persists contact IBM® Support.

FMNDB054

SSID Db2® SSID not defined (short). There is no definition (FMN2SSDM macro entry) for Db2® subsystem or group *Db2 SSID* in the FM/Db2 installation module (FMN2POPT). Contact the person who installed FM/Db2. (long).

Explanation: The FMN2POPT installation module is used to specify the Db2® systems that FM/Db2 can connect to. The *File Manager for z/OS® Customization Guide* recommends defining an FMN2SSDM macro entry for every Db2® system that FM/Db2 will connect to. The FMN2POPI macro includes a CONNECT option, the default setting is DEFINED. When CONNECT=DEFINED is in effect, FM/Db2 will only attempt connection to Db2® systems that have an FMN2SSDM entry in the FMN2POPT. An attempt to connect to a Db2® system with no FMN2SSDM entry results in this error.

User response: There are two usual approaches for resolving this error:

1. Add an FMN2SSDM macro entry for every Db2® system that FM/Db2 will access to the FMN2POPT, as recommended in the *File Manager for z/OS® Customization Guide*.
 2. Specify CONNECT=ANY in the FMN2POPI macro in the FMN2POPT. While this will allow FM/Db2 to attempt connection to ANY Db2® system, it does not necessarily remove the need to define an FMN2SSDM macro entry for every Db2® system that FM/Db2 will connect to. See the *File Manager for z/OS® Customization Guide* for detailed setup information.
-

FMNDB055

Selection canceled (short). Db2® subsystem selection was canceled. Connection to the previously connected Db2® system has been re-established.

Explanation: The user exited the Db2® subsystem selection panel without selecting a Db2® subsystem or group

User response: No action required. This is an informational message.

FMNDB056

Selection canceled (short). Db2® subsystem selection was canceled. File Manager Db2® is not currently connected to any Db2® subsystem.

Explanation: The user exited the Db2® subsystem selection panel without selecting a Db2® subsystem or group. FM/Db2 is not currently connected to any Db2® subsystem or group.

User response: No action required. This is an informational message. It will be necessary to connect to a Db2® system prior to performing any FM/Db2 functions.

FMNDB057

Db2® limits the output returned from a Db2® command. This limit has been reached and the output has been truncated.

Explanation: A Db2® command that produced large amounts of output was entered. Db2® has limited the amount of output produced, resulting in truncation.

User response: No action required. This is an informational message. Refine the Db2® command to be more specific.

FMNDB058

You cannot change the SQLID until FM/Db2 is connected to a Db2® subsystem or group.

Explanation: FM/Db2 was not connected to any Db2® system, and the user typed a new value in the SQLID field on the FM/Db2 main menu. It is not possible to change the current SQLID without first being connected to some Db2® system.

User response: Change the Db2® SQLID back to the default value, typically the user TSO logon ID. Now enter a valid Db2® SSID in the Db2® SSID field and press Enter to establish connection to the Db2® system. When the connection is successful, attempt to change the Db2® SQLID.

FMNDB059

** not defined in installation module.

Explanation: This message appears in the Db2® subsystem selection display against any Db2® system that has no FMN2SSDM macro entry in the FMN2POPT.

User response: No action required. This is an informational message. Refer to *File Manager for z/OS® Customization Guide* for detailed information about how to code entries in the FMN2POPT module.

FMNDB060

Unable to load Db2® Interface module *name*. Abend Code *abend code-reason code*. Check STEPLIB/LINKLIST for Db2® load libraries.

Explanation: A File Manager/Db2 batch job attempted to load the Db2® interface module *name*. The LOAD abended with Abend code *abend code*, reason *reason code*.

User response: Check the STEPLIB or JOBLIB statement in the batch job. Ensure that the appropriate Db2® load library is included. If the batch job was generated using FM/Db2 online, the Db2® libraries are automatically included, as specified in the FMN2SSDM macro entry in the FMN2POPT for the appropriate Db2® system. This will not occur if there is no FMN2SSDM macro entry for the Db2® system, or if the Db2® libraries are not included in the FMN2SSDM macro.

FMNDB061

Catalog table *table name* is missing.

Explanation: A File Manager/Db2 batch job attempted to access Db2® catalog table *table name*. The access failed with SQLCODE-204 (object not found).

User response: If views of the Db2® catalog are in use (CATOWNER=xxxx in the FMN2POPI macro, FMN2POPT module, xxxx is not SYSIBM) then ensure that the appropriate view *xxxx.table name* has been created.

FMNDB062

No select access to catalog table *table name*.

Explanation: A File Manager/Db2 batch job attempted to access Db2® catalog table *table name*. The access failed with SQLCODE-551 (insufficient authority).

User response: Ensure that the Db2® authid associated with the batch job has SELECT access to table *table name*.

FMNDB063

Cannot access *column* in catalog table *table name*.

Explanation: A File Manager/Db2 batch job attempted to access column *column* in Db2® catalog table *table name*. The access failed with SQLCODE-206 error. The column *column* is not defined in table *table name*.

User response: If views of the Db2® catalog are in use (CATOWNER=xxxx in the FMN2POPI macro, FMN2POPT module, xxxx is not SYSIBM) then ensure that the appropriate view *xxxx.table name* has been created. Further, ensure that column *column* is included in view *xxxx.table name*.

FMNDB064

Db2® Abend Code *abend code-reason code* accessing *name*. Notify your systems programmer.

Explanation: A Db2® Abend occurred while running a File Manager/Db2 batch job. The Db2® Abend code is *abend code*, the reason code is *reason code* and the Db2® module that was accessed is *name*. The batch job ends and any uncommitted operations are backed out.

User response: Look up the Db2® Abend code and reason code in the DB2 for z/OS Messages and Codes. In most cases this type of error indicates an error with the batch job (for example, the wrong Db2® libraries being specified). Check the specification of the Db2® libraries in the FMN2SSDM macro entry for the appropriate Db2® system (FMN2POPT module). See the *File Manager for z/OS® Customization Guide* online function, use FM/Db2 to regenerate the batch JCL and retry the operation.

FMNDB065

GEN command failed (short). The FM/Db2 GEN command failed - RC=*return code*. Please see your Systems Support staff for assistance. (long).

Explanation: The SQL Reverse Engineering function (GEN command) failed with reason *return code*.

User response: Possible failures include space related abends (x37) for the data sets used by the GEN code. If this is the case there will be an associated abend issued. Respond to the Abend by deleting and recreating the data set with more space, and retry the operation.

FMNDB066

No SSID parameter was passed to FMN2INEX. The last connected Db2® subsystem, if any, is used. Check that the connected Db2® subsystem is, in fact, what was intended.

Explanation: The REXX EXEC FMN2INEX can be used to invoke FM/Db2 by an external call. The REXX EXEC requires various parameters, including the Db2® SSID of the Db2® system that FM/Db2 should connect to. This was not provided.

User response: Check the method used to invoke the FMN2INEX exec and ensure that a Db2® SSID is provided.

FMNDB067

Invalid option code (short). The option code passed to FMN2INEX is either invalid or not supported. The option code has been discarded. (long).

Explanation: The REXX exec FMN2INEX can be used to invoke FM/Db2 by an external call. The exec requires various parameters, including a function code that indicates which FM/Db2 function to run. The function code provided was invalid.

User response: The function codes that may be passed to *File Manager for z/OS® Customization Guide*. Ensure that a supported function code is specified.

FMNDB068

Command not active (short). The command to change the Db2® subsystem is not available when FM/Db2 is invoked remotely. (long).

Explanation: FM/Db2 was invoked from an external application. In this situation it is not possible to change the currently connected Db2® SSID.

User response: No action required. Informational message.

FMNDB069

Command not available (short). Db2® commands cannot be issued when FM/Db2 has been started remotely. (long).

Explanation: FM/Db2 was invoked from an external application. In this situation it is not possible to issue Db2® commands.

User response: No action required. Informational message.

FMNDB070

Possible causes - Missing/invalid FMN2POPT module, eg invalid plan name.

Explanation: A File Manager/Db2 batch job encountered an error attempting to use the CAF attachment.

User response: The usual causes of this error are:

1. FM/Db2 is not installed on the target Db2® system.
2. The FMN2POPT module in use specifies an invalid plan name, perhaps the specified plan does not exist, or the plan exists but is invalid.

FMNDB071

Current SQLID (short). The current SQLID is the value specified. (long).

Explanation: The SQLID command was issued to change the current SQLID. However the specified SQLID is already the current SQLID.

User response: No action required. Informational message.

FMNDB072

SQLID value required (short). The SQLID command requires a value. Enter the new SQLID after the SQLID keyword, eg "SQLID FRANK". (long).

Explanation: The SQLID command was issued without an operand.

User response: Specify, for example, the desired SQLID after the SQLID command:

```
SQLID FRED
```

FMNDB073

SQLID cmd not available (short). The SQLID command is not available from this panel. (long).

Explanation: The SQLID command was issued from a panel where the command is not supported.

User response: Return to a higher level panel , for example a function entry panel, or menu panel, and reissue the command.

FMNDB074

UNICODE conversion error codepage *CCSID 1* to codepage *CCSID 2*.

Explanation: In a File Manager/Db2 editor session of a Unicode encoded object, the conversion between CCSID *CCSID 1* and CCSID *CCSID 2* failed.

User response: One reason for this error is that the z/OS® Unicode translation service for the specified CCSID pair has not been set up. Contact your System Programmer. If this does not solve the problem, contact IBM® Support.

FMNDB075

SQLID = *SQLID* (short). The current SQLID has been changed to *SQLID*. (long).

Explanation: A command to change the current SQLID was issued. The command succeeded, the current SQLID is now *SQLID*.

User response: No action required. Informational message.

FMNDB076

*** Rollback occurred. Transactions since start of session or last commit have been backed out. ***

Explanation: A Db2® rollback was issued. This message appears in audit log reports.

User response: No action required. Informational message.

FMNDB077

A Db2® commit has been issued.

Explanation: A Db2® commit was issued. This message appears in audit log reports.

User response: No action required. Informational message.

FMNDB078

UNICODE conversion error. UNICODE conversion error from codepage *CCSID 1* to codepage *CCSID 2*. Return code *return code*, reason code *reason code* from CUNLCNV routine.

Explanation: In a File Manager/Db2 editor session of a Unicode-encoded object, the conversion between CCSID *CCSID 1* and CCSID *CCSID 2* failed. The CUNLCNV system service, used to perform the conversion, issued return code *return code* and reason code *reason code*.

User response: One reason for this error is that the z/OS® Unicode translation service for the specified CCSID pair has not been set up. Contact your System Programmer. If this does not resolve the problem, contact IBM® Support.

FMNDB079

Change SSID first (short). An attempt to navigate to a File Manager/Db2 function was made while simultaneously changing the Db2® SSID. This is not supported. First change the Db2® SSID and then navigate to the required function. (long).

Explanation: Processing on the FM/Db2 main menu panel includes the capability to change the current SQLID by typing a new value in the SQLID field, followed by the user pressing enter to validate the change. The ISPF short cut prefix ('=') can be used to navigate to some other FM/Db2 function. However, the use of this short cut bypasses the normal panel processing, and is therefore not supported.

User response: The use of '=' is not supported within *File Manager for z/OS® Customization Guide* for Db2® data. In situations where a change in SQLID is required to execute some FM/Db2 function, first change the SQLID, then navigate to the required function.

FMNDB091

Invalid selection (short). Enter 'S' or '/' to select the required object type. (long).

Explanation: An invalid character was entered against an entry in an object selection list. The only characters that may be used to select the entry are 'S' and '/'.

User response: Use one of the characters indicated to select the object.

FMNDB092

Invalid selection (short). Enter 'S' or '/' to select the required line command. (long).

Explanation: An invalid character was entered against an entry in an object selection list. The only characters that may be used to select the entry are 'S' and '/'.

User response: Use one of the characters indicated to select the object.

FMNDB093

Invalid selection (short). Valid selections are 'S', '/', 'A', 'D', 'U', 'UO' and 'UW'. (long).

Explanation: This command is issued by the Basic SQL Prototyping function. An invalid command was entered in the 'S' (Selection) field. The only valid characters that may be used are as shown in the long message.

User response: Use one of the character or characters shown in the long message to select the column.

FMNDB094

OBJIN|OBJOUT Db2® object not found.

Explanation: This message is issued by FM/Db2 functions that are executed in batch, when a Db2® object name does not exist. OBJIN appears when an input Db2® object name does not exist, for example print, copy and export. OBJOUT appears when an output Db2® object name does not exist, for example copy, import and data create.

User response: Correct the Db2® object name, re-submit the batch job.

FMNDB095

OBJIN|OBJOUT Db2® object name error. The name specified returned multiple Db2® objects.

Explanation: This message is issued by FM/Db2 functions that are executed in batch, when the specified Db2® object name returns multiple Db2® objects. OBJIN appears when the location appears in an input Db2® object name, for example print, copy and export. OBJOUT appears when the location appears in an output Db2® object name, for example copy, import and data create.

User response: Correct the Db2® object name to specify a less generic Db2® object name, re-submit the batch job.

FMNDB096

OBJIN|OBJOUT Db2® location not found.

Explanation: This message is issued by FM/Db2 functions that are executed in batch, when a Db2® location, specified as part of a Db2® object name, does not exist. OBJIN appears when the location appears in an input Db2® object name, for example print, copy and export. OBJOUT appears when the location appears in an output Db2® object name, for example copy, import and data create.

User response: Determine the failing Db2® location value. Ensure that this Db2® location is accessible from the Db2® system specified in the PARM statement, re-submit the batch job.

FMNDB098

Db2 SSID; executing Db2® level *release*. Maximum supported level is *Maximum release*.

Explanation: FM/Db2 connected to *Db2 SSID*, which is at Db2® version or release *release*. The maximum supported Db2® version or release for the current version of FM/Db2 is *Maximum release*, which is less than *release*. The connection to this Db2® system is not supported.

User response: Contact IBM® Support for information about which versions of FM/Db2 support Db2® systems at version or release *release*.

FMNDB099

Invalid Db2® SSID (short). The Db2® SSID is too long. Specify a 1-4 character value. (long).

Explanation: A command to change the currently connected Db2® system was issued, however the value entered for the desired Db2® system is too long. Valid Db2® SSIDs are 1-4 characters in length.

User response: Check the Db2® SSID that was specified; make corrections. Retry the operation.

FMNDB100

SQLCODE *SQLCODE*. *Statement type* (short). SQLCODE *SQLCODE* was encountered while issuing a *Statement type* statement.

Explanation: An error was encountered during execution of a *Statement type* SQL statement. The failing SQLCODE is *SQLCODE*.

User response: Look up the failing SQLCODE in the DB2 for z/OS Messages and Codes manual. If the message was issued when processing a user-specified SQL statement, make adjustments to the statement and retry the operation.

FMNDB101

SQL error message

Explanation: A File Manager/Db2 batch function encountered an error during execution of an SQL statement. The formatted SQL error messages is shown in *SQL error message*.

User response: Look up the failing SQLCODE in the Db2® Messages and Codes manual. If the message was issued when processing a user-specified SQL statement, make adjustments to the statement and retry the operation.

FMNDB107

Remote server not found (short). FM/Db2 encountered an SQL error *SQLCODE* attempting to access the Db2® system at *Db2 remote server*. This might indicate that the remote Db2® system is not available or does not exist. Check the definitions in SYSIBM.LOCATIONS. (long).

Explanation: FM/Db2 attempted to connect to a remote Db2® server name, This may have been entered in the location field of various FM/Db2 function entry panels. The connection attempt failed with SQLCODE *SQLCODE*. The connection is not established and no operations at the remote Db2® server are possible until the reason for the connection failure is resolved.

User response: Look up *SQLCODE* in the DB2 for z/OS Messages and Codes manual and follow the recommended course of action. This error can occur in the following situations (non-exhaustive list):

1. DRDA® definition problems.
 2. The remote Db2® system does not exist, is not active, is not available.
 3. Communication problems.
-

FMNDB108

Different Db2® release (short). The release level of the local Db2® system is different to the release level of the Db2® system which you have just accessed. The choice of Db2® object types has been refreshed to show those object types supported on the remote or local system. Press ENTER again to get the requested list. (long).

Explanation: This message is issued by the FM/Db2 Object list utility when the user changes the value in the location field on the function entry panel and presses ENTER. FM/Db2 attempts to connect to the new location value (or to reconnect to the local server, if the new value is blank). When the Db2® version or release for the previously connected Db2® system is different to the newly connected Db2® system, it is possible that the list of Db2® object types requires changes. The object list request is processed in two steps:

1. Updating the list of objects and showing this message.
2. Displaying the list of objects for the selected object type.

User response: Ensure that the requested object type is still valid at the new Db2® system. Press **Enter** again to see the information for the requested object types.

FMNDB109

No matching locations (short). The location name specification does not match any locations defined to the local Db2® server. (long).

Explanation: A Db2® server name, including wild cards, was entered in the Location field on the FM/Db2 Object List utility function entry panel. There are no Db2® server names that match the wild card specification.

User response: Check the location specification and retry the operation. Use * in the location field to list all possible locations.

FMNDB110

Internal error (ABEND) *Abend code*. Function terminated.

Explanation: FM/Db2 detected a serious internal error and issued an internal ABEND to prevent further processing. The internal abend code is *Abend Code*

User response: This is an internal error. The list of File Manager internal abend codes is not documented for external use. Record details of the circumstances that lead to the Abend, including the *Abend code*, and contact support.

FMNDB118

Function active (short). The command to change the Db2® subsystem is not available while a File Manager/Db2 function is in progress.

Explanation: A command to change the currently connected Db2® SSID (for example SSID XXXX) was issued on a panel where the command is not available. The reason for this is that a File Manager/Db2 function is active.

User response: Exit the current FM/Db2 function by returning to a function entry panel, or menu panel. Reissue the command to change the Db2® system.

FMNDB119

Db2 authid not authorized (short). You are not authorized to use the *Db2 authid* on Db2® Subsystem *Db2 SSID*. (long).

Explanation: An attempt was made to change the current SQLID, using the SQLID command. The user is not authorized to use Db2® authid *Db2 authid*. The attempt to change the current SQLID fails, the existing value for SQLID is retained.

User response: The rules governing the use of Db2® authids can be complex, depending on whether an external security server is used to control Db2® authorizations and whether a Db2® authorization exit is in use. In most cases a user needs SYSADM authority or similar to use other SQLIDs. Contact either your Db2® System Administrator, or the site Security Administrator for assistance.

FMNDB120

Inactivity time-out (Short). The editor session ended because of inactivity. Any uncommitted changes have been rolled back. Contact your System's Administrator for more information.

Explanation: There is a site-imposed limit on how long an FM/Db2 editor session can be inactive before it is canceled. This limit has been exceeded. The current editor session has been canceled, any uncommitted changed have been rolled back.

User response: None.

FMNDB145

Recursive alias (short). The object name entered is an alias that refers to an alias defined at the current server, which is not permitted. Specify an alias name that refers to an object, that is, not an alias. (long).

Explanation: A Db2® object name was entered in the Owner or Name fields on a File Manager/Db2 function entry panel. The values entered refer to an ALIAS defined at the local Db2® server, however this ALIAS refers to another ALIAS. Recursive ALIASes are not supported.

User response: An ALIAS that refers to a Db2® object (Table/View/Synonym) is supported. Resolve the ALIAS to the point where the name entered refers to an actual object and specify that value. Alternatively, specify the target object name directly.

FMNDB147

Data sampling requires that FM/Db2 use a Db2 scrollable cursor, however, the use of Db2 scrollable cursors was disabled by the product installer. The operation cannot be performed. (long)

Explanation: An attempt was made to use data sampling, however the use of Db2 scrollable cursors has been disabled by the product installer. Data sampling requires the use of Db2 scrollable cursors so the requested operation cannot be performed.

User response: None.

FMNDB149

Count of unknown

Explanation: This message is issued by the FM/Db2 editor, when operating in Large mode. *Count* shows the row number of the first row currently displayed (in TABL display mode), or the currently displayed row (in SNGL display mode). Large editor mode is explained at length in [FM/Db2 editor sessions on page 120](#). Large editor mode is selected when the user enters 0 (also *, ALL) in the "Row count" field of a File Manager/Db2 function that uses the editor to display the result table.

User response: No action required. Informational message. In Large editor mode the number of rows in the result table is not available until the user scrolls to the end of the Db2® object. After the user scrolls to the end of the Db2® object, 'unknown' is replaced with the number of rows in the Db2® object/result table.

FMNDB150

Table locking disabled (short). Table locking was requested but failed, as can occur with eg catalog tables. (long).

Explanation: This message is issued by the FM/Db2 editor when the data is first displayed. The user specified a table locking option (not recommended) on the 7th Editor Options panel. When FM/Db2 attempted to lock the table, the operation failed.

User response: No action required. Informational message. This message can be issued when a Db2® catalog table is selected for edit.

FMNDB153

Commit issued (short). All pending changes to the database have been successfully committed. (long).

Explanation: This message is issued by the FM/Db2 editor (only for edit) when an explicit Db2® COMMIT has been issued. The Db2® COMMIT finalizes any pending changes made in the current editor session.

User response: No action required. Informational message.

FMNDB154

Commit issued (Errors) (short). Successful changes committed, unsuccessful changes remain pending. (long).

Explanation: This message is issued by the FM/Db2 editor (only for edit) when an explicit Db2® COMMIT has been issued. The Db2® COMMIT finalizes any pending changes made in the current editor session. The FM/Db2 editor processes changes data in an editor session on a row-by-row basis. It is therefore possible for some, but not all, changes to have been committed.

User response: No action required. Informational message. Use the 'e' prefix command to identify rows that are in error. If in doubt as to which changes have been made, exit the current editor session and restart.

FMNDB155

Key information on (short). Key and index information will be displayed in single format (long).

Explanation: The user entered the INDEXINF primary command in a File Manager/Db2 editor session, and the prior state of the toggle was off. When the data is displayed in SNGL mode, an additional column appears on the left of the display, showing the columns that are part of keys (indexes) defined against the table.

User response: No action required. Informational message.

FMNDB156

Key information off (short). Key and index information will not be displayed in single format (long).

Explanation: The user entered the INDEXINF primary command in a File Manager/Db2 editor session, and the prior state of the toggle was on. See also message [FMNDB155 on page 1031](#).

User response: No action required. Informational message.

FMNDB157

Rollback issued (short). A Db2® rollback has been issued. Any uncommitted changes are lost. (long).

Explanation: This message is issued by the FM/Db2 editor when the user presses the PF key assigned to CANCEL, or types CANCEL, within the editor session. The current FM/Db2 editor session ends and an explicit Db2® ROLLBACK is issued. Any changes made after the last Db2® COMMIT are lost.

User response: No action required. Informational message.

FMNDB158

Auxiliary Table (short). Edit or browse of an auxiliary table is not possible. (long).

Explanation: An attempt was made to edit an auxiliary table. This action is not supported.

User response: No action required. Informational message. Only base Db2® objects can be edited.

FMNDB159

count rows fetched.

Explanation: This message is issued by the FM/Db2 editor when the data is first displayed. It shows the number of rows that have been fetched from Db2® and loaded into the current editor session. It indicates that the user specified a non zero "row count" value, that the specified number of rows has been loaded into the editor, and that the end of the Db2® object or result table was not reached.

User response: No action required. Informational message. Not all the rows in the Db2® table have been loaded into the FM/Db2 editor. Consequently, any edit operations apply only to those rows loaded.

FMNDB160

Insufficient storage (short). There was insufficient virtual storage to edit/browse this object. Use the Rows to Retrieve option or specify a row selection criteria to limit the amount of data retrieved from Db2®. (long).

Explanation: This message is issued by the FM/Db2 editor when there is insufficient memory available to load all the rows of a Db2® object or result table into memory. The editor operation cannot proceed.

User response: Review [Restricting the data that FM/Db2 loads from Db2 on page 134](#), covering memory usage by the FM/Db2 editor. There are various options for resolving this issue, including (non-exhaustive list):

1. Increase the TSO Region Size.
 2. Use the FM/Db2 editor in "Large" mode, to minimize memory usage.
 3. Specify a lower "row count" value.
 4. Use record selection criteria, WHERE clause, to reduce the number of rows that might be loaded.
-

FMNDB161

Warning: USA time format (short). The Db2® object being edited contains at least 1 column with the TIME data type and the system options are set to display these columns in USA format (for example, HH:MM AM|PM). You may not be able to delete or update rows in this Db2® object because of the loss of information associated with the use of this format. See the Systems Options tutorial for more information. (long).

Explanation: This message is issued by the FM/Db2 editor when processing a Db2® object, or result, table that has at least one column with the TIME data type. In addition, the FM/Db2 system options are set to display TIME columns in USA format. This format truncates the seconds part of any TIME value, making it impossible to distinguish between, for example, 09:13:52 and 09:13:00. For this reason it may be impossible to update or change data for this table.

User response: If edit operations are required for this table, consider changing the FM/Db2 system options to display TIME columns in either ISO or JIS formats, both of which show the full seconds value. For more information about the TIME display formats supported by Db2®, see the DB2 for z/OS SQL Reference.

FMNDB163

Copy Pending (short). Updates are not allowed to tablespace *table space name* in *database name* because the tablespace is marked as COPY PENDING. In order to edit the table you should cancel the current edit session, then take action to remove the copy pending status. One way to do this is to run the Db2® COPY utility. See the Db2® Administration Guide for a full explanation. (long).

Explanation: This message is issued by the FM/Db2 editor when an attempt is made to edit a Db2® object that is marked as COPY PENDING. The Db2® object being edited is stored in table space *table space name* in *database name*. It is not possible to change Db2® tables while they are in COPY PENDING status. COPY PENDING status can be set for a Db2® object after, for example, an initial data load, using the Db2® utilities, when certain utility options are specified.

User response: The recommended way to remove the COPY PENDING status is to run the Db2® COPY utility against the Db2® object. Consult your Db2® System Administrator for the best way to proceed.

FMNDB164

Syntax error (short). The WHERE clause contains a syntax error. (long).

Explanation: This message is issued by the template editor, or Column Selection, or Edit panel, when a syntax error is detected in the user-specified WHERE clause.

User response: Examine the WHERE clause for any possible errors. You can copy the complete SQL to either the clipboard, or a temporary data set, and then use an SQL processor such as FM/Db2 options 4.3, 4.4, or SPUFI to execute the statement. Any SQL errors for the statement will also be reported.

FMNDB165

Invalid column name (short). The WHERE clause contains an invalid column name, *column name*. (long).

Explanation: This message is issued by the template editor, or Column Selection/Edit panel, when the WHERE clause specifies an invalid column name. The reason is that the column name does not exist in the Db2® object or result table being processed.

User response: Check the WHERE clause and locate any occurrences of *column name*. Ensure that this column name is one of the columns in the Db2® object, or result table. Retry the operation.

FMNDB166

Open quoted string (short). The WHERE clause contains an open quoted string. (long).

Explanation: This message is issued by the template editor, or Column Selection/Edit panel, when the WHERE clause contains an open quoted string. Examples of open quoted strings are:

1. WHERE EMPNO = '
2. WHERE EMPNO ="

User response: Check the WHERE clause, and count the number of apostrophes and double quotation marks. An odd number for either indicates a problem. Make corrections and retry the operation. The rules for quoted strings can be found in the DB2 for z/OS SQL Reference.

FMNDB167

SQLCODE *SQLCODE* (short). Execution of the SQL statement will result in SQLCODE *SQLCODE*. (long).

Explanation: This message is issued by the template editor, or Column Selection and Edit panel, during validation of a user specified WHERE clause. The validation process used by FM/Db2 is to prepare a SELECT statement against the Db2® object being processed after appending any user specified WHERE clause. The prepare can fail for many reasons, for example syntax errors and incorrect column names. The prepare step may also fail for other reasons, in which case the failing SQLCODE is returned to the user for action.

User response: Look up the SQLCODE in the DB2 for z/OS Messages and Codes manual and respond as directed.

FMNDB170

Dependent rows (short). This related edit session shows only those rows that would be affected by the change to parent table *Parent table name*. The foreign key columns are marked with a K in the scale line, and are shown on the left of the display in table display format. In general, the foreign key value must be changed, or the row deleted, for the operation on the parent table to proceed.

Explanation: This message is displayed when the data for a new related edit session is first displayed, and the new table is a dependent table.

User response: The reason for editing a dependent table is to resolve foreign key values that are preventing the deletion of the corresponding primary key in the parent table. In some situations the dependent edit session will show all rows, not just those with the foreign key values that match the primary key value in the parent table.

FMNDB171

Parent table (short). In this related edit session the primary key columns are marked with a P in the scale line and are shown on the left of the display (table display format). You can use the IP prefix command to insert a new row with the primary key set to the foreign key value entered in the edit session of dependent table *dependent table*. (long).

Explanation: This message is displayed when the data for a new related edit session is first displayed, and the new table is a parent table.

User response: The reason for editing the parent table is to add a new primary key, so that a row in a dependent table with a new foreign key, that matches the primary key, can be added.

FMNDB173

All rows (short). This related edit session shows all rows of the table. Parent table *parent table name* is subject to a self referencing constraint such that deleting or changing a primary or parent key value may result in the recursive deletion of other rows in the parent table. FM/Db2 cannot determine which rows in table *dependent table name* will be affected by such an operation. (long).

Explanation: This message is displayed when the data for a new related edit session is first displayed, and the new table is a dependent table.

User response: The reason for editing a dependent table is to resolve foreign key values that are preventing the deletion of the corresponding primary key in the parent table.

FMNDB174

Commit issued (short). A Db2® commit has been issued. (long).

Explanation: This message is issued at the end of a File Manager/Db2 editor session. It indicates that a Db2® COMMIT has been issued to finalize any pending changes to the Db2® object being processed.

User response: No action required. Informational message.

FMNDB175

Invalid value (short). Valid values are TABL and SNGL. There are no unformatted edit modes in FM/Db2. (long).

Explanation: The user typed an invalid value in the Format field in a File Manager/Db2 editor session.

User response: Check the value that was entered. There are two display modes when using the FM/Db2 editor:

1. TABL (Can be abbreviated to T, TA, TAB). In this mode each horizontal line on the screen shows one row of data from the Db2® object or result table being processed.
 2. SNGL (Can be abbreviated to S, SN, SNG). In this mode the data for a single row of the Db2® object or result table being processed is displayed. The data for each column is shown, with the column name on the left and the data for that column on the right.
-

FMNDB176

Object/Alias not found (short). The specified object or alias was not found in the catalog, or the target of an alias does not exist.

Explanation: The user entered the name of a Db2® object in the "Owner" and "Name" fields on a File Manager/Db2 function entry panel. FM/Db2 attempted to resolve the name and the attempt failed. The reason this message is issued is described in the following example: Alias *ALIAS* is defined, this refers to *OBJECT*. However, *OBJECT* does not exist. The user enters *ALIAS* in the "Owner" and "Name" fields on a File Manager/Db2 function entry panel. FM/Db2 resolves the *ALIAS* name to *OBJECT*. However, the latter does not exist, resulting in this error message.

User response: Determine why the Db2® Object Name does not exist.

FMNDB177

Warning: USA time format (short). The Db2® object being exported contains at least 1 column with the TIME data type and the system options are set to externalize these columns in USA format (HH:MM AM/PM). The exported data will not contain seconds information because of the loss of information associated with the use of this format. See the Systems Options tutorial for more information. (long).

Explanation: This message is issued by either the FM/Db2 export, or FM/Db2 UNLOAD utilities when:

1. The Db2® object being processing has a TIME data type column.
2. The "External Format for TIME Data Type Columns" system option is set to "Db2® DSNHDECP setting".
3. The DSNHDECP setting for TIME columns is 'USA'.

User response: This is an informational message. As noted in the long message text, in this situation the exported data for the TIME columns will lose any seconds value. If this is intended or desired, then no action is required. When no loss of information is required, consider changing the "External Format for TIME Data Type Columns" value to either 'ISO' or 'JIS', both of which include the seconds information.

FMNDB178

Warning: USA time format (short). The Db2® object being copied contains at least 1 column with the TIME datatype and the system options are set to externalize these columns in USA format (HH:MM AMPM). The data copied to the target table will

not contain second's information because of the loss of information associated with the use of this format. See the Systems Options tutorial for more information. (long).

Explanation: This message is issued by the FM/Db2 copy utility when:

1. The Db2® object being processing has a TIME data type column.
2. The "External Format for TIME Data Type Columns" system option is set to "Db2® DSNHDECP setting".
3. The DSNHDECP setting for TIME columns is 'USA'.

User response: This is an informational message. As noted in the long message text, in this situation the copied data for the TIME columns will lose any seconds value. If this is intended or desired then no action is required. When no loss of information is required, consider changing the "External Format for TIME Data Type Columns" value to either 'ISO' or 'JIS', both of which include the seconds information.

FMNDB179

Cancel recommended (short). Db2® has rolled back the current unit of work (SQLCODE -911) because of a deadlock with another task. ALL UNCOMMITTED CHANGES made during the current edit session have been lost. Consequently, the data displayed in the current edit session may not reflect the current state of the Db2® table. It is recommended that you cancel the current edit session and restart with a fresh copy of the data. (long).

Explanation: This message is issued by the FM/Db2 editor when it receives an SQLCODE-911 error attempting to change data for a row that was modified by the user. Db2® detected a deadlock with another task and resolved the situation by rolling back the changes for the FM/Db2 user. This means that any changes made since the last Db2® COMMIT point have been lost. In this situation there is no guarantee that the data displayed in the FM/Db2 editor still reflects the data stored in Db2®. It is best to cancel the current editor session and restart.

User response: Cancel the current edit session and restart. Make a change to a single row and attempt to save the change. If the SQLCODE-911 reoccurs, contact your Db2® System Administrator for assistance in determining why a deadlock is occurring.

FMNDB180

Related edit failed (short). Initialization of the related edit session failed. The reason is that the product has not been installed correctly. If LIBDEFs are used to allocate the File Manager Db2 component libraries, the related edit session exec, FMN2RESS, should be installed in the same library as the exec used to allocate the libraries for, and start, the first File Manager Db2 component session. Refer to the File Manager Customization Guide for further information. (long).

Explanation: The initialization process for the related edit session failed. Each related edit session is effectively a new invocation of FM/Db2. Once started the user can use ISPF commands to switch between the different logical sessions. During the invocation process a REXX EXEC, FMN2RESS, is called. However, this REXX EXEC may not be accessible when LIBDEFs are used to define the FM/Db2 libraries.

User response: Contact the person who installed FM/Db2.

FMNDB181

Browse substituted (short). The object being edited is a read-only view. In Db2® parlance a read-only view is any view that has at least one column marked as not updateable in the catalog. For this view every column is marked as not updateable. Consequently no edit operations of any kind are possible, and browse has been substituted for edit. (long).

Explanation: This message is issued by the FM/Db2 editor when processing a view that cannot be updated. While the user selected the edit (as opposed to view/browse) to process the object, no edit operations are possible. To avoid any possible confusion the edit session has been converted to browse.

User response: No action required. Informational message.

FMNDB182

Table locking failed (short). Table locking was requested but failed. The object being edited is a view, and views cannot be explicitly locked. (long).

Explanation: This message is issued by the FM/Db2 editor when the data for a view is first displayed. The user has set a table locking option in the editor options. This is not recommended. Only tables can be explicitly locked, therefore the attempt to lock the view failed.

User response: No action required. Informational message. Table locking should be avoided because of the potential for deadlocks.

FMNDB183

Read-only view (short). The object being edited is a read-only view. In Db2® parlance a read-only view is any view that has at least one column marked as not updateable in the catalog. For this view at least one column is marked as updateable. Those columns that are not updateable are protected. Some edit operations may fail. (long).

Explanation: The object being processed by the FM/Db2 editor is a read-only view, although it does have one or more columns marked as updateable.

User response: This is an informational message. It is possible to successfully edit some read-only views, even though some columns of the view cannot be updated. However, attempting to edit a read-only view is not advisable. Edit the underlying tables directly.

FMNDB184

Non-updateable columns (short). The table being edited contains at least one column marked as not updateable in the Db2® catalog. This can occur when editing Db2® catalog tables. The not updateable columns are protected. Some edit operations may fail. (long).

Explanation: The object being edited contains one or more columns marked as not updateable in the Db2® catalog SYSIBM.SYSCOLUMNS.UPDATES = 'Y'. These columns will appear in the editor session as protected fields. One reason for this message is when edit is used to display the data from a Db2® catalog table.

User response: This is an informational message. You will not be able to change the data for those columns marked as not updateable. It may also not be possible to delete or insert rows.

FMNDB185

Recursive alias (short). The object name entered is an alias that refers to an alias at a remote location, which is not permitted. Specify the alias name at the remote server directly. (long).

Explanation: The user entered an alias name in the "Owner" and "Name" fields on a File Manager/Db2 function entry panel. FM/Db2 resolved the alias name to another alias name defined at a remote location. This is not supported. After resolution, any alias name entered must refer to an actual Db2® object defined either locally, or remotely.

User response: Enter the target Db2® object name directly, or ensure that any alias used refers directly to a Db2® object.

FMNDB186

Not available (View) (short). The RE command is not available when editing a Db2® view. Edit the Db2® table directly to access related table edit processing. (long).

Explanation: The user entered the RE (Related edit) command in a File Manager/Db2 editor session. The object being edited is a view; related edit functionality is only available for tables. The operation cannot be performed.

User response: If related edit processing is required, ensure that all objects referred to are tables.

FMNDB187

Command not available (short). Commands such as INSERT, REPEAT and COPY are not available in this edit session. The data for the Db2® object is stored in UNICODE format, but there is no conversion routine for graphic data type columns. (long).

Explanation: This message is issued by the FM/Db2 editor when processing a Db2® object with graphic data type columns that is encoded in Unicode. In this situation it is possible for data corruption to occur when processing data for these columns and initializing the field contents. To avoid this situation, the INSERT, REPEAT, and COPY commands are disabled.

User response: No action required. Informational message.

FMNDB188

The Db2® object being edited is stored in a UNICODE-encoded table space, and the object contains MBCS (mixed byte character set) data (GRAPHIC data type columns). The current application encoding scheme is not a known MBCS CCSID. Changing the GRAPHIC data type columns is not supported. (long).

Explanation: This message is issued by the FM/Db2 editor when processing a Db2® object with graphic data type columns that is encoded in Unicode. In this situation it is possible for data corruption when processing data for these columns. To avoid this possibility, changes to graphic data type columns are not supported.

User response: No action required. Informational message.

FMNDB189

Incompatible options (short). Read-only access can only be selected with concurrency options that do not specify that locks will be kept, that is all options except 4 "Read stability keep locks" and 6 "Repeatable read keep locks". (long).

Explanation: There is a conflict between options selected on the 7th Editor options panel. The "read-only" option implies that no Db2® locks are required when processing the SQL SELECT statement. However, the Concurrency options "Read stability keep locks" and "Repeatable read keep locks" imply that Db2® should take and keep locks while processing the SQL SELECT statement.

User response: In all but exceptional cases the Concurrency option should be set to "Uncommitted read" or "No with clause". If a concurrency option that requires locks is required, do not specify the "Read-only access" option.

FMNDB190

Statement overflow (short). The SQL statement needed to update the table is too long. (long).

Explanation: An internal statement buffer overflow was detected while building an SQL statement to update a table. The operation cannot be performed. This condition should not occur during processing of typical Db2® objects. It might occur

when processing Db2® objects with very many column names (the maximum is 750), and with many "long" column names. The maximum length for a column name is 30 characters.

User response: Collect information including the DDL used to create the Db2® object being processed. Contact IBM® Support.

FMNDB191

Changes discarded (short). The invalid change to the Initial Display option has been discarded. (long).

Explanation: The user made an invalid change to the "Initial display format" editor option, and then pressed the PF key assigned to END, or typed END. The invalid value is discarded and the editor options panel is redisplayed.

User response: No action required. Informational message. After making changes to the options, press ENTER to validate the changes before attempting to exit the panel.

FMNDB192

Changes discarded (short). The invalid change to the Concurrency option has been discarded. Enter one of the listed values for the Concurrency option. (long).

Explanation: The user made an invalid change to the "Concurrency" editor option, and then pressed the PF key assigned to END, or typed END. The invalid value is discarded and the editor options panel is redisplayed.

User response: No action required. Informational message. After making changes to the options, press ENTER to validate the changes before attempting to exit the panel.

FMNDB193

Changes discarded (short). The invalid change to the Enter key usage option has been discarded. Enter one of the listed values for the Enter key usage option. (long).

Explanation: The user made an invalid change to the "Enter key usage" editor option, and then pressed the PF key assigned to END, or typed END. The invalid value is discarded and the editor options panel is redisplayed.

User response: No action required. Informational message. After making changes to the options, press ENTER to validate the changes before attempting to exit the panel.

FMNDB194

Use unique characters (short). The character used to indicate the "String delimiter (display)" must be different to the character used to indicate the "String delimiter (input)". Select a different character. (long).

Explanation: The user specified the same character for the "Input" and "Display" string delimiters on the 5th Editor options panel. While most characters can be used, the characters that are used must be distinct.

User response: Ensure that the characters specified for the "Input" and "Display" indicators and delimiters are unique.

FMNDB195

Use unique characters (short). The character used to indicate the "Null column display indicator" must be different to the character used to indicate the "Null column input indicator" Select a different character. (long).

Explanation: The user specified the same character for the "Input" and "Display" Null column indicators on the 5th Editor options panel. While most characters can be used, the characters that are used must be distinct.

User response: Ensure that the characters specified for the "Input" and "Display" indicators and delimiters are unique.

FMNDB196

Use unique characters (short). The character used to indicate the "Null column input indicator" must be different to the character used to indicate the "String delimiter (input)". Select a different character. (long).

Explanation: The user specified the same character for the "Input" Null column indicator and "Input" String delimiter. While most characters can be used, the characters that are used must be distinct.

User response: Ensure that the characters specified for the "Input" and "Display" indicators and delimiters are unique.

FMNDB197

Use unique characters (short). The character used to indicate the "Null column display indicator" must be different to the character used to indicate the "String delimiter (input)". Select a different character (long).

Explanation: The user specified the same character for the "Display" Null column indicator and "Input" String delimiter. While most characters can be used, the characters that are used must be distinct.

User response: Ensure that the characters specified for the "Input" and "Display" indicators and delimiters are unique.

FMNDB198

Use unique characters (short). The character used to indicate the "Null column input indicator" must be different to the character used to indicate the "String delimiter (display)". Select a different character (long).

Explanation: The user specified the same character for the "Input" Null column indicator and "Display" String delimiter. While most characters can be used, the characters that are used must be distinct.

User response: Ensure that the characters specified for the "Input" and "Display" indicators and delimiters are unique.

FMNDB199

Use unique characters (short). The character used to indicate the "Null column display indicator" must be different to the character used to indicate the "String delimiter (display)". Select a different character. (long).

Explanation: The user specified the same character for the "Display" Null column indicator and "Display" String delimiter. While most characters can be used, the characters that are used must be distinct.

User response: Ensure that the characters specified for the "Input" and "Display" indicators and delimiters are unique.

FMNDB206

Not on remote object (short). The requested function can not be performed on an object at a remote location. (long).

Explanation: This message is issued by the FM/Db2 Object List utility in various circumstances when a requested command cannot be performed. The reason the command cannot be performed is that the object is at a remote location. Certain SQL commands, for example GRANT and REVOKE, may only be issued when connected to the local Db2® server.

User response: Connect to the remote Db2® server directly and reissue the command.

FMNDB208

Not on catalog object (short). The requested function can not be performed on a Db2® catalog object. (long).

Explanation: The LISTCAT line command was issued against a Db2® catalog object. For example, a table or index space. This command cannot be issued against Db2® catalog objects.

User response: No action required. Informational message.

FMNDB210

Invalid value (short). The valid values are 16, for an 8 byte number with 16 digit coefficient, or 34 for a 16 byte number with 34 digit coefficient. (long).

Explanation: This message is issued by the FM/Db2 Object functions. For a column defined with the DECFLOAT data type, a value other than 16 or 34 was entered in the 'PR' column.

User response: Enter either 16 for an 8-byte number, or 34 for a 16-byte number.

FMNDB215

Unsupported data type (short). This File Manager Db2® function does not support columns of the specified data type. Supported data types are *List of data types*. (long).

Explanation: This message is issued by the FM/Db2 Object functions. When defining the data type for a column, an invalid, or unsupported, data type value was entered.

User response: Check that the data type entered is spelled correctly. The list of supported data types is shown in the long version of the message. Press the PF key assigned to HELP, PF1 by default, to access. Check that the data type is supported by the version of Db2® in use. For example, the DECFLOAT data type is not supported at Db2® version 8.

FMNDB216

Length error (short). The specified length, precision, or scale is not valid for the data type of the column. (long).

Explanation: This message is issued by the FM/Db2 Object functions. The value entered for a length, precision or scale is invalid.

User response: Check the value entered. Consult the DB2 for z/OS SQL Referencemanual for detailed information on the permissible values for data type lengths, and the scale and precision values that may be specified.

FMNDB217

Scale > precision (short). The scale of a decimal must be less than or equal to the precision of the number. (long).

Explanation: This message is issued by the FM/Db2 Object functions. The combination of scale and precision values entered is invalid.

User response: For Decimal numbers the precision can be 1 to 31, inclusive. The scale for a number can be 0 to p, where p is the precision of the number.

FMNDB220

Non updateable field (short). A field reference in a change command refers to a column that is not updateable. (long).

Explanation: In the FM/Db2 editor, a change command was issued that included a field reference, or references. The target column for the change is not updateable, meaning that the proposed change is not possible.

User response: Ensure that the field reference identifies a column that can be changed. Non updateable columns are shown as protected fields in the editor display.

FMNDB223

Start too large (short). The start position (*start position*) is larger than the number of rows (*number of rows*) in the result table.

Explanation: This message is issued by the FM/Db2 editor. The user entered a value *start position* in the "Start position" field on the Db2® Edit panel. When FM/Db2 attempted to skip to the nominated start position, it reached the end of the result table. The number of rows in the result table is *number of rows*.

User response: Informational message. Reduce the start position value to at least *number of rows* and retry the operation.

FMNDB224

Start out of range (short). The first sample row is at row *row number*, which is larger than the number of rows, *number of rows*, in the result table. Reduce the start position and/or initial skip count values.

Explanation: This message is issued by the FM/Db2 editor when clustered sampling is selected in the editor options. When FM/Db2 attempted to skip to the nominated start position, determined by the value in the "start position field", and the value in the "Initial skip count fields", it reached the end of table. The number of rows in the result table is *number of rows* (n).

User response: Informational message. Reduce either or both of the "start positions" and "Initial skip count" (i) values, so that $s+i+1 \leq n$.

FMNDB240

Invalid collection (short). The collection must be different from the COPY collection. (long).

Explanation: When binding a copy of a package, the collection and COPY collection values must be different.

User response: Specify different values.

FMNDB242

DASD data set required (short). This command can only be used on a row where DSNAME refers to a DASD data set. (long).

Explanation: The 'B' (Browse) command was issued against an image copy entry displayed by the FM/Db2 Object List Utility. The browse command can only be entered against entries associated with an image copy data set stored on DASD (disk). The command cannot be processed.

User response: Issue the command against an image copy data set with a non blank device type. The device type must not be a tape type.

FMNDB245

No plan (short). The command is only valid when application plan is non-blank. (long).

Explanation: The DBRM command was entered against an entry in a PLAN table. The command is only valid when the entry is associated with an application plan; that is the APPLNAME column for the row is non blank. The command cannot be processed.

User response: Ensure that the APPLNAME column value is non blank.

FMNDB246

No collection (short). The command is only valid when collection is non-blank. (long).

Explanation: The PACKage command was entered against an entry in a PLAN table. The command is only valid when the entry is associated with a package; that is the COLLID column for the row is non blank. The command cannot be processed.

User response: Ensure that the COLLID column value is non blank.

FMNDB247

No DBRM (short). The command is only valid when DBRM is non-blank. (long).

Explanation: The PACKage command was entered against an entry in a PLAN table. The command is only valid when the entry is associated with a DBRM; that is the PROGNAME column for the row is non blank. The command cannot be processed.

User response: Ensure that the PROGNAME column value is non blank.

FMNDB250

Invalid SQL identifier (short). The value entered is not a valid SQL ordinary identifier. (long).

Explanation: This message is issued in various places in the FM/Db2 Object List Utility. A value was entered for a field where an ordinary SQL Identifier is required. An example is a Db2® authid used as an "Owner" or SQLID.

User response: An SQL ordinary identifier cannot include characters other than A-Z, 0-9, _ ,and the national characters, and must not begin with a digit. See the Db2® SQL Reference manual for a precise definition. Refer to the Appendix "Limits in Db2® for z/OS®", for a complete list of valid values for various types of Db2® items.

FMNDB270

Invalid buffer pool (short). Valid buffer pool names are: *List*. (long).

Explanation: A value entered for a buffer pool is invalid. *List* shows the valid values that can be entered.

User response: Compare the value entered against the values in *List*. Change the value entered to match one of the values in *List*. Retry the operation.

FMNDB271

Db2® version invalid (short). Table constraints are only available when connected to a Db2® Version 8 or later system. Current Db2® version is *Db2 VRM indicator*. (long).

Explanation: The "CON" command (Show table constraints) was issued against a list of tables in the FM/Db2 Object List utility. This command is not valid when connected to a Db2® version 7, or earlier system. The currently connected Db2® system is at *Db2 VRM indicator*, which is less than '0800'. The command cannot be executed.

User response: No action required. Informational message.

FMNDB272

Not valid for object (short). "*line command*" is not a valid command for this type of object. (long).

Explanation: This message is issued in various contexts by the FM/Db2 Object List utility. An example is issuing the VS (Show view SQL) against a entry in a list of Db2® tables/views/aliases, when the entry is not a view.

User response: Ensure that the command entered is appropriate for the type of object shown in the row.

FMNDB273

Not valid for function (short). "*Line command*" is only valid for external user-defined functions. (long).

Explanation: This message is issued in various contexts by the FM/Db2 Object List utility when processing a list of functions. The row against which the line command was entered is of the wrong function type. The command is not applicable to that type of function.

User response: The type of function is shown in the "Type of Routine" column. Enter the command against a row showing a function of the appropriate type.

FMNDB274

No upgrade done (short). The PLAN_TABLE was already at the correct level. (long).

Explanation: A command was issued to upgrade a PLAN_TABLE, however the table was already at the correct level. No action was taken.

User response: No action required. Informational message.

FMNDB275

Not valid for column (short). "*Line command*" is not a valid command for this type of column. *List of types*. (long).

Explanation: This message is issued in various contexts by the FM/Db2 Object List utility when processing a list of columns. The row against which the line command was entered is of the wrong type. For example, the command applies only to columns defined with a user-defined (DISTINCT) data type. The command cannot be executed.

User response: No action required. Informational message. *List of types* contains information about the types of columns that the command can be issued against.

FMNDB276

Not valid for column (short). *Line command* is not a valid command for 'identity column' type sequence objects. (long).

Explanation: The 'COM' (COMMENT) line command was issued against a row in a list of sequences displayed by the FM/Db2 Object List Utility. A comment cannot be specified for sequences that represent internal sequence objects used by Db2®. The command cannot be executed.

User response: No action required. Informational message.

FMNDB289

Data set required (short) This command can only be used on a row where DSNAME refers to a data set. (long).

Explanation: The user issued the 'LC' (LISTCAT) command against an entry in a list on the Recovery Information panel in the FM/Db2 object list utility that did not have an associated data set. The Recovery Information panel shows all the rows in the SYSIBM.SYSCOPY catalog table. Only rows that represent full and incremental image copies are suitable targets for the LISTCAT command.

User response: No action required. Informational message. Ensure that the selected row represents either a full or incremental copy. The command may still fail if, for example, the data set has been deleted.

FMNDB292

Invalid criteria (short). The criteria specified in the Additional Selection Criteria fields produced an invalid SQL SELECT statement WHERE clause. Db2® returned an SQL code of -199 to the SQL statement "SQL STATEMENT". (long).

Explanation: This message is issued by the FM/Db2 object list utility when the user has entered values in the "Additional selection criteria" section of the panel. This section of the panel can be used to add a simple predicate to the SQL being generated. For example, when listing tables, show only tables that have an EDITPROC. This can be achieved by setting Column=EDPROC; Operator= ≠ Value = ". The expression entered resulted in SQLCODE-199, and cannot be processed.

User response: Look up SQLCODE-199 in the DB2 Administration Tool for z/OS User's Guide and Reference, modify the predicate, and retry the operation.

FMNDB295

Invalid location (short). The location name is invalid or is not defined to the Db2® subsystem. (long).

Explanation: The user entered a value in a Location field on a File Manager/Db2 function entry panel. The attempt to connect to this remote server failed with SQLCODE-950.

User response: Look up SQLCODE-950 in the Db2® SQL Messages and Codes manual. The most likely explanation is that the value entered does not appear in column SYSIBM.LOCATIONS.LOCATIONS at the local Db2® server. If the value is incorrect then amend it and retry the operation. If the value is correct contact the person responsible for maintaining DRDA® definitions for your Db2® systems.

FMNDB296

No plan table (short). Plan table *owner*.PLAN_TABLE does not exist. (long).

Explanation: This message is issued by the Explain Utilities functions when the user issues the 'L' (List plan table rows) command, but the plan table *owner*.PLAN_TABLE does not exist. The operation cannot be performed.

User response: The PLAN_TABLE is a user-defined table. The explain utilities allow an "owner" value to be specified. Check that this value is not preventing access to the user's PLAN_TABLE. All PLAN_TABLE entries can be listed using the FM/Db2 Object List utility. If the PLAN_TABLE does not exist, use the 'C' command to create it.

FMNDB298

Incomplete quoted string (short). You entered an incomplete quoted string. Db2® returned an SQL code of -010 to the SQL statement *SQL Statement*. (long).

Explanation: This message is issued when a generated SQL statement contains a syntax error, specifically an open quoted string. The SQL statement cannot be executed.

User response: Examine the SQL statement to determine the source of the open quoted string. Modify the values entered to avoid the problem, retry the operation.

FMNDB299

Not COPY FULL (short). The RT command is only valid against an image copy entry. (long).

Explanation: The user issued the 'RT' (Recover TOCOPY) command against an entry in a list on the Recovery Information panel in the FM/Db2 object list utility that did not have an associated data set. The Recovery Information panel shows all the rows in the SYSIBM.SYSCOPY catalog table. Only rows that represent full and incremental image copies are suitable targets for the RT command.

User response: Ensure that the row selected represents either a full or incremental image copy.

FMNDB300

No previous template has been used with this Db2® object. (long).

Explanation: This message is issued by a File Manager/Db2 function entry panel when the user specifies "Previous" for the Template usage option. However, no template has been previously saved for the current Db2® object.

User response: You can generate and save a template for the current Db2® object using the "Generate/Replace" template usage option. Once a template has been successfully saved, use the "Previous" option to access the template, without needing to enter a template data set name or member.

FMNDB301

Invalid FM/Db2 template (short). The specified template does not represent a FM/Db2 template. Specify a valid FM/Db2 template. (long).

Explanation: This message is issued by a File Manager/Db2 function entry panel when the user specifies a template data set name for a Db2® object, and that the specified template should be used. However, the specified template is not a valid FM/Db2 template. There are different types of File Manager templates, depending on the source of the template. A base template cannot be used to describe a Db2® object.

User response: You can generate and save a template for the current Db2® object using the "Generate/Replace" template usage option. Once a template has been successfully saved, you can access it and possibly modify it using the "Edit template" option on the appropriate FM/Db2 function entry panel.

FMNDB302

FM/Db2 template loaded (short). File Manager Db2 component template has been successfully loaded. (long).

Explanation: This message is issued by a File Manager/Db2 function entry panel when the user specifies a template data set name for a Db2® object, and that the specified template should be used when processing the Db2® object. The specified template was successfully loaded, compared against the Db2® object and found to contain a valid description of the Db2® object.

User response: No action required. Information message.

FMNDB303

Template not loaded (short). Loading of FM/Db2 template canceled by user. Row selection criteria for the template must be revised before proceeding. (long).

Explanation: This message is issued by a File Manager/Db2 function entry panel when the user specifies a template data set name for a Db2® object, and that the specified template should be used when processing the Db2® object. When FM/Db2 compared the template specified by the user with the template generated by FM/Db2, using the information in the Db2® catalog, differences were found. The "Template not matched" panel is typically shown before this message; the user pressed PF3 on the "Template not matched" panel. In most cases this error means that the template in the user-specified data set refers to a different Db2® object to that specified on the function entry panel. See also message FMNDB304.

User response: Resolve the reason for the difference between the data set template and the Db2® object, and retry the operation. Note that FM/Db2 always generates a template for any Db2® object and compares this with any user-specified template; with the former template considered to be correct. There are many reasons why the two templates may be inconsistent (for example, Different Db2® objects; Object dropped changed and recreated).

FMNDB304

Template mismatch (short). The selected template does not match the Db2® object. Press ENTER to replace selected template, or PF3/END to select another template or processing option. (long).

Explanation: This message is issued by a File Manager/Db2 function entry panel when the user specifies a template data set name for a Db2® object, and when the user specifies the template should be used when processing the Db2® object. When FM/Db2 compared the template specified by the user with the template generated by FM/Db2, using the information in the Db2® catalog, differences were found. The "Template not matched" panel is typically shown at the same time as this message.

User response: There are two choices: 1. Press PF3 to cancel the current function. You may then attempt to resolve why the specified template data set does not match the Db2® object and retry the operation. 2. Press ENTER to replace the template in the data set with a correct version for the Db2® object. Any customization stored in the data set template will be lost. Note that FM/Db2 always generates a template for any Db2® object and compares this with any user-specified template; with the former template considered to be correct. There are many reasons why the two templates may be inconsistent (for example, Different Db2® objects; Object dropped changed and recreated).

FMNDB305

Template not updated (short). Loading of File Manager Db2 component template canceled by user as the specified template does not match the Db2® object. Specify another template or processing option. (long).

Explanation: This message is issued by a File Manager/Db2 function entry panel when the user specifies a template data set name for a Db2® object, and that the specified template should be used when processing the Db2® object. When FM/Db2 compared the template specified by the user with the template generated by FM/Db2, using the information in the Db2® catalog, differences were found. The user canceled the template merge process.

User response: No action required. Informational message.

FMNDB310

No statement table (short). Plan table *Owner.DSN_STATEMNT_TABLE* does not exist. (long).

Explanation: This message is issued when an attempt is made to access *Owner.DSN_STATEMNT_TABLE*. The user-defined table does not exist, the operation cannot be performed.

User response: Create the table using the FM/Db2 Explain Utilities function. After populating the table using the EXPLAIN command, retry the operation.

FMNDB311

No function table (short). Plan table *Owner.DSN_FUNCTION_TABLE* does not exist. (long).

Explanation: This message is issued when an attempt is made to access *Owner.DSN_FUNCTION_TABLE*. The user-defined table does not exist, the operation cannot be performed.

User response: Create the table using the FM/Db2 Explain Utilities function. After populating the table using the EXPLAIN command, retry the operation.

FMNDB330

Invalid row number (short). Either a row number has not been specified, or a specified value is invalid (long).

Explanation: The user entered a command to process a LOB or XML column. The row number specified as part of the command is invalid. You can use cursor positioning to specify the row in which the column of interest is located - in which case a row number is not required. If cursor positioning is not used a row number is required. This message can be issued when an invalid value (not a number) is specified for the row number.

User response: Check the syntax for the command and re-issue it.

FMNDB331

Row *Row* not found (short). The specified row number *Row* does not exist in the Db2® object, or result table. (long).

Explanation: The user entered a command to process a LOB or XML column. The row number specified as part of the command is invalid because it does not exist in the current editor session. The command cannot be processed.

User response: Check the row number value and ensure that it is between 1 and the maximum number of rows in the current editor session.

FMNDB332

Not on XML/LOB column (short). The cursor is not positioned on an XML/LOB column. (long).

Explanation: The user entered a command to process a LOB or XML column. The cursor was positioned within the data area of the display and FM/Db2 attempted to use cursor positioning to identify the column and row of interest. The column where the cursor is located is not a LOB or XML column. The command cannot be processed.

User response: Check the cursor position and ensure that it is located on a column of the appropriate type for the command.

FMNDB333

J command invalid (short). The J command is only valid in a File Manager/Db2 editor session of a LOB. (long).

Explanation: The user entered the J prefix command in a File Manager edit or view session. This command is only available in a File Manager/Db2 component editor session when processing a LOB, that is in a view or edit session initiated using the LOBVIEW or LOBEDIT command. The command cannot be processed.

User response: None - informational message.

FMNDB334

SP command invalid (short). The SP command is only valid in a File Manager/Db2 editor session of a LOB. (long).

Explanation: The user entered the SP prefix command in a File Manager edit or view session. This command is only available in a File Manager/Db2 component editor session when processing a LOB, that is in a view or edit session initiated using the LOBVIEW or LOBEDIT command. The command cannot be processed.

User response: None - informational message.

FMNDB335

Large table mode is not available when the object being processed contains LOB or XML columns. Specify a row count greater than zero to process this Db2® object. (long).

Explanation:

This message is issued on the FM/Db2 editor function entry panel when:

1. The user enters the name of a Db2® object that contains a LOB or XML column.
2. The row count value is set to 0 (also * or ALL).

This combination is not supported. Large editor mode is not available when the Db2® object contains LOB or XML columns.

User response: Change the row count to specify a positive integer value.

FMNDB336

Non-updateable field (short). LOB (BLOB, CLOB, DBCLOB) and XML fields cannot be altered using the CHANGE command. Use LOBEDIT or XMLEDIT to display, and possibly change, the contents of LOB/XML columns.

Explanation: A change command was entered with a target column that is a LOB (CLOB, BLOB or DBCLOB) or XML column. This is not supported

User response: Use the LOBEDIT or XMLEDIT commands to edit the LOB/XML data.

FMNDB337

LOB/XML Columns (short). The result table for the SELECT statement contains either LOB or XML columns. Display of the result table is not supported. Use Browse, View or Edit of the Db2® object containing the LOB/XML columns to display, and possibly change, LOB and XML data. (long)

Explanation: The user entered a SELECT statement using FM/Db2 options 4.1-4.4. The result table for the SELECT statement includes either LOB or XML columns. Display of the result table is not supported, the operation cannot be performed.

User response: To display and possibly change LOB or XML data, use the FM/Db2 editor functions (Browse, View or Edit) and specify the Db2® object name that contains the LOB or XML columns.

FMNDB338

XML Columns (short). Edit of objects with XML columns is only supported when the target Db2® system is at Db2® V10 NFM. The function cannot be performed.(long)

Explanation: The user attempted to process a Db2® object containing XML columns using the FM/Db2 editor. The target Db2® system is not at Db2® V10 new function mode (or later). Display of the Db2® object is not supported, the operation cannot be performed.

User response: To display and possibly change XML data, the target Db2® system must be at Db2® V10 new function mode, or later.

FMNDB339

Length error *Len* (short). The maximum length of the LOB *Len* has been exceeded. Either reduce the amount of data or cancel out of the LOB editor session. (long).

Explanation: This message is issued when an attempting to save changes made in a File Manager/Db2 LOB editor session. The total length of the LOB data exceeds the maximum size for the LOB column. The changes made in the LOB editor session cannot be saved.

User response: Either reduce the size of the LOB data, or issue the CANCEL command to abandon any changes made. You can use the TE command in the originating editor session to see the maximum length for the LOB. You can use the LOBLEN command in the originating editor session to show the current length for a LOB column.

FMNDB340

Not a LOB column (short). The field reference does not identify a LOB column. (long).

Explanation: The user issued a command to process a LOB column (LOBLEN, LOBBRWS, LOBVIEW or LOBEDIT). The field reference provided does not identify a LOB column. The command cannot be processed.

User response: Check the field reference entered as part of the command and ensure that it identifies a LOB column. Re-issue the command.

FMNDB341

Not a LOB column (short). The column at the cursor position is not a LOB column. (long).

Explanation: The user issued a command to process a LOB column (LOBLEN, LOBBRWS, LOBVIEW or LOBEDIT), using cursor positioning to identify the row and LOB column of interest. The column identified is not a LOB column. The command cannot be processed.

User response: Ensure that the cursor is located within the bounds for a LOB column. Re-issue the command.

FMNDB342

LOB Length = *Length* (short). The length of the LOB data (Row number = *Row number*, REF# = *Field Ref*) is *Length*. (long).

Explanation: The user issued the LOBLEN command. The length of the column identified is *Length*. *Row number* is the row number for the row that includes the identified column. *Field Ref* is the field reference value entered in the LOBLEN command.

User response: None - informational message.

FMNDB343

No LOB columns (short). The Db2® object does not contain any LOB columns. (long).

Explanation: The user issued a command to process a LOB column (LOBLEN, LOBBRWS, LOBVIEW or LOBEDIT), however the Db2® object being processed does not include any LOB columns. The command cannot be processed.

User response: None - informational message.

FMNDB344

LOBVIEW not available (short). LOBVIEW is not available. You may only view a LOB column from a view or edit session (not browse) of the parent table. (long).

Explanation: The user issued the LOBVIEW command from a File Manager/Db2 browse session. The only LOB-related commands that are available in a File Manager/Db2 browse session are LOBLEN and LOBBRWS. The command cannot be processed.

User response: Use the LOBBRWS command instead. If LOBVIEW is required exit the editor session and re-invoke the editor using either the view or edit function.

FMNDB345

LOBEDIT not available (short). LOBEDIT is not available. You may only edit a LOB column from an edit session (not browse or view) of the parent table. (long).

Explanation: The user issued the LOBEDIT command from either a File Manager/Db2 browse, or a FM/Db2 view session. The only LOB-related commands that are available in a File Manager/Db2 browse session are LOBLEN and LOBBRWS. The only LOB-related commands that are available in File Manager/Db2 view session are LOBLEN, LOBBRWS and LOBVIEW. The command cannot be processed.

User response: Use one of the available commands as documented in the explanation. If LOBEDIT is required exit the editor session and re-invoke the editor using either the edit function.

FMNDB346

Empty LOB (short). The LOB has no data. (long).

Explanation: This message is issued when the data for a LOB column is initially displayed by the FM/Db2 LOB editor. There is no data in the LOB column.

User response: None - informational message.

FMNDB347

Command not supported (short). XML fields cannot be browsed, viewed, or edited under CICS. (long)

Explanation: A command to process an XML column (XMLBRWS, XMLVIEW or XMLEDIT) was issued. These commands are not available when using the FM/CICS interface.

User response: None.

FMNDB348

No matching columns (short). The Db2® object contains LOB columns, however there are no selected LOB columns. You can use the TEdit command to change the selection status for a column. (long).

Explanation: The user issued a command to process a LOB column (LOBLEN, LOBBRWS, LOBVIEW or LOBEDIT), however the template for the object has been modified so that all LOB columns are not displayed. The command cannot be processed.

User response: Issue the Tedit command to display the Column Selection/Edit panel (Template editor). Change the Selection status of the LOB column of interest and save the resulting changes. Re-issue the command.

FMNDB349

BLOB edit not supported (short). Edit of a binary large object column is not supported. (long).

Explanation: The LOBEDIT command was issued against a BLOB column. Edit of BLOB data is not supported. The command cannot be processed.

User response: None - informational message.

FMNDB350

Not an XML column (short). The field reference does not identify an XML column. (long).

Explanation: The user issued a command to process an XML column (XMLEN, XMLBRWS, XMLVIEW or XMLEDIT). The field reference provided does not identify an XML column. The command cannot be processed.

User response: Check the field reference entered as part of the command and ensure that it identifies an XML column. Re-issue the command.

FMNDB351

Not an XML column (short). The column at the cursor position is not an XML column. (long).

Explanation: The user issued a command to process an XML column (XMLEN, XMLBRWS, XMLVIEW or XMLEDIT), using cursor positioning to identify the row and XML column of interest. The column identified is not an XML column. The command cannot be processed.

User response: Ensure that the cursor is located within the bounds for an XML column. Re-issue the command.

FMNDB352

XML Length = *Length* (short). The length of the XML data (Row number = *Row number*, REF# = *Field Ref*) is *Length*. (long).

Explanation: The user issued the XMLEN command. The length of the column identified is *Length*. *Row number* is the row number for the row that includes the identified column. *Field Ref* is the field reference value entered in the XMLEN command.

User response: None - informational message.

FMNDB353

No XML columns (short). The Db2® object does not contain any XML columns. (long).

Explanation: The user issued a command to process an XML column (XMLEN, XMLBRWS, XMLVIEW or XMLEDIT), however the Db2® object being processed does not include any XML columns. The command cannot be processed.

User response: None - informational message.

FMNDB354

XMLVIEW not available (short). XMLVIEW is not available. You may only view an XML column from a view or edit session (not browse) of the parent table. (long).

Explanation: The user issued the XMLVIEW command from a File Manager/Db2 browse session. The only XML-related commands that are available in File Manager/Db2 browse session are XMLLEN and XMLBRWS. The command cannot be processed.

User response: Use the XMLBRWS command instead. If XMLVIEW is required exit the editor session and re-invoke the editor using either the view or edit function.

FMNDB355

XMLEDIT not available (short). XMLEDIT is not available. You may only edit an XML column from an edit session (not browse or view) of the parent table. (long).

Explanation: The user issued the XMLEDIT command from either a File Manager/Db2 browse, or a FM/Db2 view session. The only XML-related commands that are available in a File Manager/Db2 browse session are XMLLEN and XMLBRWS. The only LOB-related commands that are available in a File Manager/Db2 view session are XMLLEN, XMLBRWS and XMLVIEW. The command cannot be processed.

User response: Use one of the available commands as documented in the explanation. If XMLEDIT is required exit the editor session and re-invoke the editor using either the edit function.

FMNDB356

Invalid target column (Short). FMAP cannot be used with BLOB, CLOB, DBCLOB, or XML columns. (Long).

Explanation: The FMAP command was issued against a LOB (CLOB, BLOB, or DBCLOB) or XML column. This is not supported.

User response: None.

FMNDB358

No matching columns (short). The Db2® object contains XML columns, however there are no selected XML columns. You can use the TEdit command to change the selection status for a column. (long).

Explanation: The user issued a command to process an XML column (XMLLEN, XMLBRWS, XMLVIEW or XMLEDIT), however the template for the object has been modified so that all XML columns are not displayed. The command cannot be processed.

User response: Issue the Tedit command to display the Column Selection/Edit panel (Template editor). Change the Selection status of the XML column of interest and save the resulting changes. Re-issue the command.

FMNDB359

Error line *Line* (short). The Db2® XML parser reported an error on or near line *Line*. (long).

Explanation: This message is issued in response to an attempt to save changes made in an XML editor session. There is a syntax error in the XML document that will prevent the updated document being saved in the Db2® object. *Line* indicates the line number where the syntax error is located. The XML document cannot be saved until the syntax error is correcte.

User response: Locate the specified line number, correct the syntax error and attempt to exit the XML edit session again. If it is not possible to resolve the error issue the CANCEL command to abandon any changes made.

FMNDB360

Invalid target column (short). FMAP cannot be used when the column cannot be updated, for example, columns defined with the GENERATED attribute

Explanation: The FMAP editor primary command was issued against a column with the GENERATED attribute. This is not supported.

User response: None.

FMNDB362

Null XML column (short). The XML column has the NULL value (long).

Explanation: The XMLEDIT command was issued against an XML column. The XML column has the Db2® null value.

User response: None.

FMNDB363

Unable to process (short). The object being edited does not include all columns of any unique indexes defined on the base table. FM/Db2 is unable to uniquely identify rows in the result table using SQL - this is required for XMLedit functionality (long).

Explanation: An XML edit operation was issued against an XML column. The object being processed is a Db2® view. The columns in the view do not include all columns of any unique indexes defined on the view's base table. In this situation FM/Db2 cannot uniquely identify rows in the result table, which is required for the XML editor's functionality. The command cannot be processed.

User response: Retry the operation using the base table to which the view refers.

FMNDB364

Unable to process (short). An attempt to obtain the RID value for the row failed. The RID value is required for XMLedit functionality (long).

Explanation: An XML edit operation was issued against an XML column. The object being processed is a Db2® view. FM/Db2 attempted to extract the RID value for the row containing the XML document to be processed. This operation failed. The command cannot be processed.

User response: Retry the operation using the base table to which the view refers.

FMNDB367

LOB column(s) (short). Import/Copy of tables containing LOB (BLOB, CLOB or DBCLOB) columns is not supported (long).

Explanation: An attempt was made to import or copy data containing LOB (BLOB, CLOB or DBCLOB) columns. This is not supported.

User response: None.

FMNDB368

XML column(s) (short). Import/Copy of tables containing XML columns is not supported (long).

Explanation: An attempt was made to import or copy data to a table containing XML columns. This is not supported.

User response: None.

FMNDB370

Warning: Saving changes to the SQL statement invalidates any expression previously entered using the "Row Selection Criteria" panel. (Long).

Explanation: The SQL command was issued in the template editor after a condition has been specified using the "Row Selection Criteria" panel. Expressions issued using the SQL command and the "Row Selection Criteria" panel are mutually exclusive, saving an expression entered using the SQL command causes an expressions entered using the "Row Selection Criteria" panel to be discarded.

User response: Informational message. In general, the SQL panel is intended for expressions that cannot be entered using the "Row Selection Criteria" panel, or for users who are comfortable entering native SQL.

FMNDB371

Not allowed. (Short). You cannot de-select columns when creating data using the FM/Db2 data create function. When a row is inserted, every column of the object is affected. (Long).

Explanation: An attempt was made to de-select columns in the template for a Db2 object specified in the FM/Db2 data create utility. This is not supported.

User response: Ensure that every column of the template is selected.

FMNDB372

De-selected columns (Short). You may not de-select columns when creating data using the FM/Db2 data create function. When a row is inserted, every column of the object is affected. (Long).

Explanation: An attempt was made to use a template with de-selected columns with a Db2 object specified in the FM/Db2 data create utility. This is not supported.

User response: Ensure that every column of the template is selected.

FMNDB373

Command not available (Short). Commands such as INSERT, REPEAT, COPY, and GET are not available when the editor is operating in large mode. (Long).

Explanation: A command was issued in an FM/Db2 editor sessions, operating in Large edit mode, that would have added a row to the editor session. Examples: INSERT, COPY, REPEAT, and GET. This is not supported.

User response: When editing in Large Table mode, you cannot insert new rows.

FMNDB400

Incomplete clause (short). The syntax clause just exited is not yet complete. (long).

Explanation: This message is issued by the FM/Db2 Advanced SELECT Prototyping function, when the user exits the syntax diagram for a code fragment without making any choice.

User response: No action required. Informational message.

FMNDB401

Command command ignored (short). You entered the *Command* command but the cursor was not on a syntax element. (long).

Explanation: This message is issued by the FM/Db2 Advanced SELECT Prototyping function when the user presses a PFKey assigned to a command (for example INSRPT, assigned to PF5 by default), however the cursor was not located on an applicable syntax element. The command cannot be performed.

User response: No action required. Informational message.

FMNDB402

Command command ignored (short). You entered the *Command* command with the cursor on a syntax element but the element is not in a repeat group. (long).

Explanation: This message is issued by the FM/Db2 Advanced SELECT Prototyping function when the user presses a PFKey assigned to a command (for example INSRPT, assigned to PF5 by default), however the cursor was not located on an applicable syntax element. Some commands are only applicable to repeatable syntax elements. The command cannot be performed.

User response: No action required. Informational message.

FMNDB403

No data entered (short). No data was entered for the data entry syntax element. (long).

Explanation: This message is issued by the FM/Db2 Advanced SELECT Prototyping function when the user exits a data entry syntax element without entering a value. An example is the "table" option of the "table reference clause". A Db2® table name, such as DSN8x10.EMP is required.

User response: No action required. Informational message. If this element is a required part of the SQL syntax you will need to enter a valid value to be able to complete the SQL SELECT statement.

FMNDB404

Statement empty (short). You entered a scroll command but there is no generated statement data. (long).

Explanation: This message is issued by the FM/Db2 Advanced SELECT Prototyping function when the user enters a scroll command (or presses a PFKey assigned to a scroll command), however there is not data to scroll.

User response: No action required. Informational message.

FMNDB405

End of data (short). The last line of the generated statement is already displayed. (long).

Explanation: This message is issued by the FM/Db2 Advanced SELECT Prototyping function when the user enters a scroll down command (or presses a PFKey assigned to scroll down), however there the last line of the generated statement is already visible. No further scrolling is possible.

User response: No action required. Informational message.

FMNDB406

Top of data (short). The first line of the generated statement is already displayed. (long).

Explanation: This message is issued by the FM/Db2 Advanced SELECT Prototyping function when the user enters a scroll up command (or presses a PFKey assigned to scroll up), however there the first line of the generated statement is already visible. No further scrolling is possible.

User response: No action required. Informational message.

FMNDB407

Autoscrollled (short). The generated statement has changed, and the statement generation area has been scrolled to bring the end of the data into view. (long).

Explanation: This message is issued by the FM/Db2 Advanced SELECT Prototyping function. The SELECT statement being generated changed as a result of user input. The display of the generated statement was automatically scrolled to show the last part of the statement.

User response: No action required. Informational message.

FMNDB408

Statement too long (short). The length of the generated statement exceeds the maximum length allowed for the target system: execution failure expected. (long).

Explanation: This message is issued by the FM/Db2 Advanced SELECT Prototyping function. The length of the generated SQL statement exceeds 32765 bytes, which is the limit for the function. Execution of the statement is expected to fail and should not be attempted. Note that while Db2® supports SQL statements up to 2M-1 the limit of 32K-2 is imposed by File Manager under ISPF.

User response: Cancel the current operation and restart.

FMNDB409

Repeat separator invalid (short). A repeat separator cannot be entered because no elements of the repeat item have been selected. (long).

Explanation: This message is issued by the FM/Db2 Advanced SELECT Prototyping function, when the user attempted to add a repeat separator (for example AND, OR), however no repeatable items have been selected.

User response: Select at least one repeatable item before attempting to insert a repeat separator.

FMNDB410

Nothing to execute (short). The EXECUTE command cannot be executed because no statement has been generated for execution. (long).

Explanation: This message is issued by the FM/Db2 Advanced SELECT Prototyping function. The user entered the EXECUTE command; or pressed the PFKey assigned to EXECUTE, however no SELECT statement has been generated.

User response: Use the prototyping facilities to generate a SELECT statement prior to attempting execution.

FMNDB411

Repeat separator invalid (short). There is no repeat separator associated with the last repeated element. (long).

Explanation: This message is issued by the FM/Db2 Advanced SELECT Prototyping function. An attempt was made to insert a repeat separator, however there is no repeat separator for the last repeated element.

User response: No action required. Informational message. If in doubt consult the syntax diagram for SELECT in the Db2® SQL Reference manual.

FMNDB412

Nothing to execute (short). The EXECUTE command cannot be executed because no statement has been entered for execution. (long).

Explanation: This message is issued by the FM/Db2 Enter, Execute and Explain SQL function. The user entered the EXECUTE command; however the SQL Statement input area is blank.

User response: No action required. Informational message.

FMNDB413

Invalid statement type (short). An invalid statement or a statement that is not dynamically executable was found in the statement entry area. (long).

Explanation: This message is issued by the FM/Db2 Enter, Execute and Explain SQL function, when the user has entered an SQL statement that cannot be dynamically prepared/executed. An example is 'CONNECT TO server', which can only be coded in an application program. This statement cannot be dynamically prepared and executed. The operation cannot be performed.

User response: Consult the Db2® SQL Reference manual for information about those statements that can/cannot be dynamically prepared/executed.

FMNDB414

Statement type statement executed (SQL cost *Cost*)

Explanation: This message is issued by FM/Db2 functions after the successful execution of some SQL statement. *Statement type* is SELECT, INSERT, and so on. *Cost* is the timer on value returned by Db2® when the SQL statement was prepared, giving a relative estimate of cost of executing the statement.

User response: No action required. Informational message.

FMNDB415

count statements executed (SQL cost *Cost*).

Explanation: This message is issued by the FM/Db2 Enter, Execute, and Explain SQL function after successful execution of multiple SQL statements. *Count* is the number of SQL statements that were executed. The statements may be of different types. *Cost* is the total of the timer on values returned by Db2® when each SQL statement was prepared.

User response: No action required. Informational message.

FMNDB419

Execution error (short). SQL execution failed. The cursor is placed on the start of the failing statement, or for a syntax error, on the token in error.

Explanation: This message is issued by the FM/Db2 Enter, Execute and Explain SQL function when execution of some SQL statement fails. Depending on the type of error, the cursor is placed at the start of the failing SQL statement, or on the token within the SQL statement considered to be in error.

User response: For syntax errors, the cursor location is at the failing token as determined by the Db2® syntax parser. The actual error may be earlier in the statement. Example: SELECT FROM DSN8810.EMP gives SQLCODE-104 and the cursor is located on the period in "DSN8810.EMP". The actual error is the omission of '*' after the SELECT keyword. Consult the Db2® SQL Reference manual for the statement type for the syntax diagram for that statement.

FMNDB420

Data truncated (short). Data found beyond column 72 in the SQL edit session has been discarded. (long).

Explanation: This message is issued by the FM/Db2 Enter, Execute, and Explain SQL function after the user exits from an ISPF editor session displayed in response to the SQL command. Within the ISPF editor, session changes may be made to the SQL statement. However, the statement must be entered in columns 1-72, inclusive. Any data entered in columns 73-80 is truncated (discarded).

User response: Examine the SQL statement to determine where the truncation occurred and make corrections.

FMNDB421

SQL too long (short). The SQL data returned from the SQL edit session was too large for the execution buffer. Some lines have been discarded. (long).

Explanation: This message is issued by the FM/Db2 Enter, Execute and Explain SQL function after the user exits from an ISPF editor session displayed in response to the SQL command. Not all of the SQL statement entered in the ISPF editor session could be copied to the display area for the FM/Db2 Enter, Execute, and Explain SQL function. The statement is too long.

User response: You may be able to circumvent this problem by using less lines to code the SQL statement in the ISPF editor session. For example, by removing some of the white space in the statement.

FMNDB422

Nothing to edit (short). There is no SQL statement for the SQL command to edit. (long).

Explanation: This message is issued by the FM/Db2 Advanced SELECT Prototyping function. The user entered the SQL command; however there was no SQL to display in an ISPF editor session. The SQL command cannot be processed.

User response: Enter some part of the SQL SELECT statement before entering the SQL command.

FMNDB423

Select an option (short). Either edit or execute must be selected. (long).

Explanation: This message is issued by the FM/Db2 Edit/Execute SQL (Data Set) function. Neither the "Edit data set", nor the "Execute SQL from data set" options have been selected.

User response: You must select one, or both of the "Edit data set" and "Execute SQL from data set" options to use this function.

FMNDB424

Statement type statement Action.

Explanation: This message is issued by the FM/Db2 Enter, Execute, and Explain SQL function when an SQL statement other than a SELECT, DELETE, or UPDATE is processed. *Statement type* is the type of statement (Example SET) and *Action* indicates the type of operation. For example, "executed".

User response: No action required. Informational message.

FMNDB425

count statements Action

Explanation: This message is issued by the FM/Db2 Enter, Execute, and Explain SQL function when multiple SQL statements are processed. *count* is the type of statement and *Action* indicates the type of operation. For example, "executed".

User response: No action required. Informational message.

FMNDB426

SQL execution failed (*count* statement(s) executed successfully).

Explanation: This message is issued by the FM/Db2 Enter, Execute, and Explain SQL function, after multiple SQL statements were processed. The execution of at least one SQL statement failed, however *count* statements were processed successfully.

User response: Examine the list of SQL statements processed to determine whether the failure to execute a statement (or statements) is appropriate.

FMNDB427

No columns selected (short). The EXECUTE command cannot be executed because no columns have been selected from which to retrieve data. (long).

Explanation: This message is issued by the FM/Db2 Basic SELECT Prototyping function. The user attempted to execute the SQL SELECT statement. However, the SELECT statement is incomplete and cannot be executed. There are no columns specified in the SELECT clause.

User response: You need to specify at least one column in the SELECT statement, for the statement to be executable. Select a column by typing 'S' next to the entry for the column, or use 'ALL' to select all columns.

FMNDB429

Value required (short). A value must be entered to build a where clause predicate. (long).

Explanation: This message is issued by the FM/Db2 Basic SELECT Prototyping function. The user entered a value in the 'Op' (Operator) column for a column, but no value was entered in the corresponding 'Value' column. A value is required to construct a valid WHERE clause, which has the form: COLUMN *operator value*.

User response: Enter a value appropriate for the column being included in the WHERE clause.

FMNDB431

Invalid operator (short). Enter a valid logical operator: AND, OR, NOT, NOR. NOT represents AND NOT and NOR represents OR NOT. (long).

Explanation: This message is issued by the FM/Db2 Basic SELECT Prototyping function. The user entered an invalid value in the 'LOp' (Logical Operator) column for a column. The LOp column is used to specify a logical operator. This is used between any WHERE clause predicates specified for the SQL statement being prototyped.

User response: Enter one of the values shown in the long version of the message; the default value is 'AND', selected automatically when no value is specified.

FMNDB432

Invalid operator (short). Enter a valid expression operator: =, ≠, <, >, ≤, ≥, >IN, NI, LI, NL. LI represents the SQL LIKE operator, NL represents NOT LIKE, and NI represents NOT IN. (long).

Explanation: This message is issued by the FM/Db2 Basic SELECT Prototyping function. The user entered an invalid value in the 'Op' (Operator) column for a column. The Op column is used to specify a comparison operator. This is used in the WHERE clause predicate being added to the SQL statement being prototyped.

User response: Enter one of the values shown in the long version of the message; the default value is '=', selected automatically when no value is specified.

FMNDB433

Invalid margins (short). The left margin must be less than or equal to the right margin, and both values must be greater than zero. (long).

Explanation:

This message is issued by the FM/Db2 Edit/Execute SQL (Data Set) function. The user entered values in the "First column" and "Last column" fields that are invalid. Suggested values are:

- (First column) and 72 (Last column), corresponding to the margins when editing a fixed-block data set with logical record length of 80 and an ISPF profile setting of 'NUMBER ON STD'.
- (First column) and 80 (Last column), corresponding to the margins when editing a fixed-block data set with logical record length of 80 and an ISPF profile setting of 'NUMBER OFF'.

User response:

Consider the recommended values outlined in the explanation. Any values entered should meet the following requirement: 0 < first ≤ last ≤ logical record length, where:

- First is the value entered in the "First column" field.
 - Last is the value entered in the "Last column" field.
 - Logical record length is the LRECL for the data set being edited. You can use ISPF option 3.2 to determine the LRECL for a data set. To enhance the usability of the data set, the value for last should be significantly larger than the value for first.
-

FMNDB434

Nothing to explain (short). The EXPLAIN command cannot be executed because no statement has been entered for explanation. (long).

Explanation: This message is issued by the FM/Db2 Enter, Execute, and Explain SQL function. The user entered the EXPLAIN command. However, there was no SQL statement in the "SQL Statement" area of the panel. The EXPLAIN command requires an SQL statement to process.

User response: Enter an SQL statement in the "SQL Statement" area of the panel and reissue the EXPLAIN command.

FMNDB435

Invalid statement type (short). An invalid statement or a statement that is not explainable was found in the statement entry area. (long).

Explanation: This message is issued by the FM/Db2 Enter, Execute, and Explain SQL function. The user entered the EXPLAIN command. However, the SQL statement entered is not "explainable".

User response: Not every SQL statement is "explainable". See the Db2® SQL Reference manual description of the EXPLAIN statement, for a detailed explanation of which SQL statements are explainable. SELECT, MERGE, INSERT, and some types of UPDATE and DELETE statements are considered "explainable".

FMNDB436

Statement executed, no rows deleted.

Explanation: This message is issued by the FM/Db2 Enter, Execute, and Explain SQL function. The user entered a DELETE SQL statement, and the statement was executed. However, Db2® reported that no rows were deleted.

User response: No action required. Informational message.

FMNDB437

Statement executed, no rows updated.

Explanation: This message is issued by the FM/Db2 Enter, Execute, and Explain SQL function. The user entered an UPDATE SQL statement, and the statement was executed. However, Db2® reported that no rows were updated.

User response: No action required. Informational message.

FMNDB438

SQL execution halted (short). Execution of the SQL statement was halted because the user pressed CANCEL on the predictive governor. (long).

Explanation: This message is issued by the FM/Db2 Enter, Execute, and Explain SQL function. The execution of an SQL statement was halted because it exceeds values set by the SQL predictive governor. In this situation a warning pop-up panel is displayed, and the user elected to CANCEL execution of the statement.

User response: No action required. Informational message.

FMNDB439

CONNECT stmt. Invalid (short). A CONNECT statement cannot be executed. This statement can only be specified within an application program. (long).

Explanation: This message is issued by the FM/Db2 Edit/Execute SQL (Data Set) function. The input data set contains a CONNECT SQL statement. This statement cannot be dynamically prepared and executed. It can only be embedded in an application program. The statement cannot be executed.

User response: Remove the CONNECT statement and retry the operation.

FMNDB440

VIEW (clustered sampling)

Explanation: This message is displayed by the FM/Db2 Editor, when using clustered sampling.

User response: No action required. Informational message.

FMNDB441

TABLE (clustered sampling)

Explanation: This message is displayed by the FM/Db2 Editor, when using clustered sampling.

User response: No action required. Informational message.

FMNDB442

VIEW (random sampling)

Explanation: This message is displayed by the FM/Db2 Editor, when using random sampling.

User response: No action required. Informational message.

FMNDB443

TABLE (random sampling)

Explanation: This message is displayed by the FM/Db2 Editor, when using random sampling.

User response: No action required. Informational message.

FMNDB444

LOB

Explanation: This message is displayed by the FM/Db2 Editor, when processing LOB data.

User response: No action required. Informational message.

FMNDB445

XML

Explanation: This message is displayed by the FM/Db2 Editor, when processing XML data.

User response: No action required. Informational message.

FMNDB450

Copy not allowed (short). The index has not been defined with COPY YES, so it cannot be selected for copying. (long).

Explanation: This message is issued by the FM "Db2 Utilities" function. The user selected an index created with the 'COPY NO' option for copy. This is not allowed.

User response: You can only copy a Db2® index when it was originally created with the 'COPY YES' option. See the Db2® Utilities Guide and Reference for more information.

FMNDB451

Chng limits not allowed (short). Change limits cannot be specified because the table space has not been defined with TRACKMOD YES. (long).

Explanation: This message is issued by the FM "Db2 Utilities" function. The user entered change limit values for a table space defined with 'TRACKMOD NO'. This is not allowed.

User response: You can only specify change limit values for the Db2® COPY utility when the table space was defined with 'TRACKMOD YES'. See the Db2® Utilities Guide and Reference for more information.

FMNDB453

Cannot recover object (short). Either the Db2® object specified does not exist in the Db2® catalog, or no SYSCOPY entries exist for the Db2® object. (long).

Explanation: This message is issued by the FM "Db2 Utilities" function. The user is attempting to recover either a table space, or index. When FM/Db2 retrieved a list of entries from SYSIBM.SYSCOPY, no rows were returned. This might occur when wildcard values for database name and table and index space name were specified on the function entry panel. There are no matching table and index spaces. Another possibility is that there are matching table and index spaces, but no suitable image copies are available for these objects, so the RECOVER utility cannot execute.

User response: No action required. Informational message.

FMNDB454

Invalid change limit (short). The change limit must be an integer value between 0 and 100. (long).

Explanation: This message is issued by the FM "Db2 Utilities" function. Change limit values for the COPY utility are expressed as percentage values (0-100 inclusive). The value entered is out of range.

User response: Specify a value in the range 0-100 inclusive. See the Db2® Utilities Guide and Reference for more information.

FMNDB455

Function canceled (short). Load utility processing was canceled by user. (long).

Explanation: This message is issued by the FM "Db2 Utilities" function. The CANCEL PFKey or CANCEL command was used when processing for a LOAD utility job, using a File Manager template, was incomplete.

User response: No action required. Informational message.

FMNDB456

Function completed (short). Load utility processing has completed. (long).

Explanation: This message is issued by the FM "Db2 Utilities" function. Processing for a Db2® LOAD utility completed normally.

User response: No action required. Informational message.

FMNDB457

Choose at least one item (short). For the given processing option, you must choose at least one item. (long).

Explanation: This message is issued by the FM/Db2 "OPTIONS Options" panel. The user selected a processing option of 4 "Options to be included", but did not select any of the available options. At least one option must be selected.

User response: Select one or more of options: 'PREVIEW', 'LISTDEFDD', 'TEMPLATEDD', and 'EVENT'.

FMNDB458

Null indicator mismatch (short). The source Db2® column *Column name* is not nullable and yet the corresponding target data set field is associated with a nullable field. (long).

Explanation: This message is issued by the FM/Db2 Unload utility. During mapping between the columns of the source object and fields of the output template, a mismatch for column *Column name*, and the corresponding field, has been detected. *Column name* is defined as NOT NULL. However, the target field has an associated null field indicator.

User response: This usually indicates a mapping problem. The target field for a column defined as "NOT NULL" should not have a null field indicator. Check the target template copybook or template definition and make changes. Retry the operation.

FMNDB459

Enter required field (short). The field where the cursor is positioned is mandatory. (long).

Explanation: This message is issued by the FM/Db2 "OPTIONS Options" panel. The user selected a processing option of 3 ('KEY'), but did specify a key value.

User response: Specify a key value in the field indicated by the cursor position.

FMNDB460

Function canceled (short). Unload table utility processing was canceled by user. (long).

Explanation: This message is issued by the FM/Db2 Unload utility, when the user presses the PFKey assigned to CANCEL (or types the CANCEL command), prior to completion of the function.

User response: No action required. Informational message.

FMNDB461

Function completed (short). Unload utility processing has completed. (long).

Explanation: This message is issued by the FM/Db2 Unload utility, when the function completes normal processing.

User response: No action required. Informational message.

FMNDB462

Settings failure (short). The TEMPLATE, LISTDEF, or OPTIONS settings for the current subsystem may be incorrect. (long).

Explanation: This message is issued during FM/Db2 options initialization. An error was encountered when storing values in an ISPF table in the user ISPF profile.

User response: Logoff completely, logon again, and retry the operation. If the problem persists, try deleting all FMN2* members from the user ISPF profile data set. If this fails to resolve the problem contact IBM® Support.

FMNDB463

Setting failure (short). When you return from another subsystem, the changes that you made to LISTDEF, TEMPLATE, or OPTIONS settings may not be restored. (long).

Explanation: This message is issued during FM/Db2 options initialization. An error was encountered when storing values in an ISPF table in the user's ISPF profile.

User response: Logoff completely, logon again, and retry the operation. If the problem persists, try deleting all FMN2* members from the user ISPF profile data set. If this fails to resolve the problem contact IBM® Support.

FMNDB464

Null indicator mismatch (short). A null indicator byte maps to field name *field name* (column *number*), but the name does not contain 'NULL'. (long).

Explanation: This message is issued by the FM/Db2 Unload utility. A problem has been detected when mapping columns of the Db2® object to corresponding fields in the File Manager (base) template for the unloaded data.

User response: Refer to the online tutorial topic "Null indicator byte processing", accessed as follows: 3.9.7.1.7 (Utilities > Utilities > Unload Utility > Unload (table) > Null indicator byte processing. Briefly, when using a File Manager Base component template to describe the format for the UNLOAD data set, it is possible to use a field with length > 1 byte for a Db2® null indicator. However, the field name must include the string 'NULL' to be automatically mapped.

FMNDB465

Null indicator mismatch (short). A null indicator byte maps to the byte before the first field. (long).

Explanation: This message is issued by the FM/Db2 Unload utility. This is a "should not occur" error.

User response: Check the template for the target (unload) data set is appropriate for the Db2® object being unloaded. Consider using a File Manager/Db2 template generated from the source object to map the unloaded data. If both of these techniques fail to resolve the problem, contact IBM® Support.

FMNDB467

Null indicator mismatch (short). The null indicator byte *column name* maps to field *field name* (column *number*) which is mapped already to another table column. (long).

Explanation: This message is issued by the FM/Db2 Unload utility. A problem has been detected when processing the mapping for a Db2® null indicator for column *column name*.

User response: Refer to the online tutorial topic "Null indicator byte processing accessed as follows: 3.9.7.1.7 (Utilities > Utilities > Unload Utility > Unload (table) > Null indicator byte processing. Briefly, a field in the template for the unload data set can only be mapped to a single column, or Db2® null indicator.

FMNDB468

Utility service failed (short). FM/Db2 initiated an unload table utility operation from export. However, the unload table utility failed to initialize properly. (long).

Explanation: This message is issued when there is a problem generating a JCL deck using ISPF file tailoring. This is a "should not occur" error under normal circumstances.

User response: Contact the person responsible for installing and maintaining FM/Db2. Possible causes of this error include setup-related issues such as the SFMNSLIB library not being available to the FM/Db2 user.

FMNDB469

Settings failed (short). The TEMPLATE, LISTDEF, or OPTIONS settings (for subsystem *Db2 SSID*.) cannot be loaded or the associated settings could not be found. (long).

Explanation: This message is issued during FM/Db2 options processing. Once cause of this error is a missing options module (FMN2POPT), or no definitions for the current Db2® subsystem.

User response: Contact the person who is responsible for installing/maintaining FM/Db2. Defining FMN2SSDM macro entries for every Db2® system accessed by FM/Db2 is a required installation and customization step. Contact IBM® Support if analysis shows no obvious problem in the FMN2POPT module.

FMNDB470

Init install settings (short). The installation-defined settings for this subsystem are used to set options TEMPLATE, LISTDEF, and OPTIONS. (long).

Explanation: This message is issued during FM/Db2 Options processing. When processing TEMPLATE, LISTDEF, or OPTIONS, no options had previously been saved in the user's ISPF profile. The option values have been initialized based on any values set in the FMN2POPT (installation) module.

User response: No action required. Informational message.

FMNDB471

Init FM/Db2 settings (short). The installation defined setting for this subsystem is: CONNECT = ANY. The FM/Db2 defaults are used for options TEMPLATE, LISTDEF, and OPTIONS. (long).

Explanation: This message is issued during FM/Db2 Options processing. When processing the connection to a Db2® subsystem, the combination of CONNECT=ANY (FMN2POPI macro parameter) and no FMN2SSDM macro entry for the Db2® subsystem was detected. In this situation there can be no installation settings for TEMPLATE, LISTDEF, and OPTIONS options (since there is no FMN2SSDM macro entry where these settings are defined). The FM/Db2 defaults are used to initialize the option values.

User response: No action required. Informational message. The File Manager Customization Guide lists as a required step that an FMN2SSDM macro entry should be defined for every Db2® system that FM/Db2 may connect to.

FMNDB472

Init FM Db2 settings (short). FM Db2 default settings for options TEMPLATE, LISTDEF, and OPTIONS are used. Your installation defined settings uses an old version of the FMN2SSDM macro. (long).

Explanation: This is a "should not occur" error. The FMN2POPT module in use is out-of-date and should be reassembled with the latest macro versions.

User response: Contact the person responsible for installing or maintaining FM/Db2. Reassemble the FMN2POPT module using the directions in the *File Manager Customization Guide*. Carefully check the SYSLIB DD statement to ensure that the current version of SFMNSAM1 libraries is in use, and check the SYSLMOD DD statement to ensure that the output module is located in the appropriate library.

FMNDB473

Must provide name (short). A LISTDEF name must be provided when specification LISTDEF is selected. (long).

Explanation: The user selected the 'LISTDEF' specification on the FM/Db2 "Db2® Utilities" function entry panel. However, no value was entered in the "LISTDEF name" field. The use of a LISTDEF specification requires a non-blank LISTDEF name.

User response: Enter a valid LISTDEF name, and retry the operation; or change the specification to "Object name".

FMNDB474

```
/* NULLABLE COLUMN MAPPING
```

Explanation: This is a message insert used by the FM/Db2 Unload utility when preparing JCL.

User response: No action required. This message may be issued when documenting the mapping of nullable Db2® columns in the Db2® object to corresponding fields in the template for the unloaded data.

FMNDB477

```
/* F (FOOTNOTE) -
```

Explanation: This is a message insert used by the FM/Db2 Unload utility when preparing JCL.

User response: No action required. This message may be issued when documenting the mapping of nullable Db2® columns in the Db2® object to corresponding fields in the template for the unloaded data.

FMNDB478

```
/* * = FIELD CORRESPONDING TO NULL INDICATOR BYTE IS LARGER
```

Explanation: This is a message insert used by the FM/Db2 Unload utility when preparing JCL.

User response: No action required. This message may be issued when documenting the mapping of nullable Db2® columns in the Db2® object to corresponding fields in the template for the unloaded data.

FMNDB479

/* THAN ONE BYTE. INDICATOR MAPS TO LAST BYTE.

Explanation: This is a message insert used by the FM/Db2 Unload utility when preparing JCL.

User response: No action required. This message may be issued when documenting the mapping of nullable Db2® columns in the Db2® object to corresponding fields in the template for the unloaded data.

FMNDB480

WHERE clause too long (short). The WHERE clause is longer than 32767 bytes, and cannot be processed. Specify a shorter WHERE clause. (long).

Explanation: This message may be issued when exiting the ISPF edit session used to specify a WHERE clause in the FM/Db2 template editor (Column Selection/Edit panel). The WHERE clause exceeds the maximum allowable length of 32767 bytes, and cannot be processed.

User response: Specify a shorter WHERE clause. Remove any redundant "white space" in the clause and retry the operation.

FMNDB481

Invalid reference (short). The correlation reference *Reference* is invalid. Valid values are #1 - *Maximum reference* inclusive. (long).

Explanation: This message is issued by the FM/Db2 Basic SELECT Prototyping function. When using an explicit table correlation reference (example #n, n=1, 2 ..) the n must not be greater than the number of Db2® objects entered when the function was first started. "n" must also be a numeric value, example #F is invalid.

User response: Correct the table correlation reference, and retry the operation.

FMNDB482

Invalid column name (short). *Column name* is not a column of the referenced table. (long).

Explanation: This message is issued by the FM/Db2 Basic SELECT Prototyping function. A qualified column name was entered in the "Value" column, presumably to indicate a join between two columns. The table correlation reference is valid but the column name is not.

User response: Check the value entered for spelling or other errors. Check that the column name is a column of the table indicated by the table correlation reference.

FMNDB483

Ambiguous reference (short). This column name appears in more than one of the selected tables. Use a correlation reference, eg #1.COLNAME to identify the required. (long).

Explanation: This message is issued by the FM/Db2 Basic SELECT Prototyping function. A value entered in the "Value" column matches more than one column name in the Db2® objects selected for prototyping. A table correlation reference needs to be used to remove any ambiguity.

User response: Precede the column name with a table correlation reference, example #n., where "n" is a positive integer.

FMNDB484

Ambiguous input (short). The value specified is a column name, but can also be interpreted as a constant. To specify a constant enclose the value in quotation marks. To specify a column use a correlation reference, eg #1.COLNAME. (long).

Explanation: This message is issued by the FM/Db2 Basic SELECT Prototyping function. A value entered in the "Value" column matches a column name in a Db2® object selected for prototyping. There are two interpretations for the value entered:

1. A comparison between the column and a string constant.
2. A join between the column and the column name entered.

User response: Depending on context, either enclose the value in quotation marks (to indicate the first interpretation shown above) or precede to the column name with a table correlation reference (example #n.) to indicate the second interpretation above.

FMNDB487

NOPAD specified (Short). The DB2 UNLOAD NOPAD option is specified. FM/Db2 cannot generate a template that describes the data that will be unloaded. (Long).

Explanation: This message is issued by the FM/Db2 DB2 UNLOAD utility when the DB2 NOPAD option is selected. The NOPAD option can result in UNLOAD data with varying lengths, the format for these records cannot be described using a File Manager template.

User response: Informational message. If a template is required for the INLOAD data, do not select the DB2 NOPAD option.

FMNDB489

Member not found (Short). The DBRM member cannot be found in the data set recorded in the Db2 catalog. This can happen when members are deleted from a DBRM library after the bind was executed.

Explanation: An attempt was made to browse the contents of a DBRM member using the FM/Db2 object list utility. The member specified in the Db2 catalog table could not be found.

User response: Informational message. This situation can occur if the member containing the DBRM is deleted after the BIND command was issued.

FMNDB490

Parameters have been reset to defaults.

Explanation: This message is issued in response to the RESET command entered on a File Manager/Db2 options panel. The values on the panel have been reset to the default values.

User response: No action required. Informational message.

FMNDB491

RESET command failed.

Explanation: This message is issued in response to the RESET command, entered on a File Manager/Db2 options panel. The RESET operation failed, this is a "should not occur" error.

User response: Exit FM/Db2 completely. Start FM/Db2 again, and retry the operation. If the problem recurs, check for ISPF-related problems such as a full user ISPF profile data set. If there are no obvious external problems, contact IBM® Support.

FMNDB500

Copying...

Explanation: This message is issued by the FM/Db2 copy utility to indicate that copy operations are in progress.

User response: No action required. Informational message.

FMNDB501

number of rows rows

Explanation: This message is issued by the FM/Db2 copy utility to give an indication of progress for the current copy operation. *number of rows* is the number of rows that have been processed.

User response: No action required. Informational message.

FMNDB502

number of rows(s) copied (short). Number of rows row(s) copied from Db2® object source Db2 object to target Db2 object

Explanation: This message is issued by the FM/Db2 copy utility, at the completion of the copy operation, to report the number of rows copied from *source Db2 object* to *target Db2 object*. This message indicates that there were no duplicate key or referential integrity errors encountered.

User response: No action required. Informational message.

FMNDB503

number of rows row(s) copied. insert string

Explanation: This message is issued by the FM/Db2 copy utility, at the completion of the copy operation, to report the number of rows copied. *insert string* contains additional information, typically messages FMNDB504, FMNDB505, or FMNDB507.

User response: No action required. Informational message.

FMNDB504

count duplicate row(s) ignored.

Explanation: This message is issued by the FM/Db2 copy utility, at the completion of the copy operation, to report the number of duplicate row errors that were ignored. This message may be issued as part of message FMNDB503.

User response: No action required. Informational message.

FMNDB505

count RI/Constraint errors.

Explanation: This message is issued by the FM/Db2 copy utility, at the completion of the copy operation, to report the number of referential integrity, or constraint errors that were encountered. This message may be issued as part of message FMNDB503.

User response: No action required. Informational message.

FMNDB507

count duplicate row(s) updated.

Explanation: This message is issued by the FM/Db2 copy utility, at the completion of the copy operation, to report the number of duplicate rows that were updated. This message may be issued as part of message FMNDB503.

User response: No action required. Informational message.

FMNDB510

Function canceled (short). Copy function was canceled by user. (long).

Explanation: The user terminated the FM/Db2 copy function by issuing the CANCEL command, typically by pressing the PF12 PFKey (assigned to CANCEL by default).

User response: No action required.

FMNDB511

Rollback completed (short) Copy of *source Db2 object* to *target Db2 object* was rolled back due to errors.

Explanation: This message is issued by the FM/Db2 copy utility when the current copy operation was terminated because of errors. A Db2® ROLLBACK is issued automatically in this situation, and all copy operations are backed out.

User response: Determine why the copy operation was terminated, resolve the error condition, and retry the operation.

FMNDB512

Copy canceled (short) Output object *target Db2 object* cannot be same as input object *source Db2 object*.

Explanation: The same Db2® object name was specified on the "from" and "to" panels of the FM/Db2 copy utility. Copy from an object to itself is not supported. The Copy operation was canceled.

User response: Specify different source or target Db2® objects, and retry the operation.

FMNDB519

Audit failure (short) Auditing to SMF failed - function terminated. BPX1SMF RC=*return code* (Dec) REASON CODE=*reason code* (Dec)

Explanation: FM/Db2 is set-up to write audit records to SMF for the current function. A failure occurred while attempting to write an audit record to SMF. The BPX1SMF call resulted in return code *return code* and reason code *reason code*, both expressed in decimal. The current FM/Db2 function is terminated.

User response:

This error usually indicates a set-up problem. Possible reason for an auditing failure to SMF are:

1. The userid does have READ access to the SAF FACILITY class profile BPX.SMF.
2. The FMN2POPT module does not have a valid number specified for the SMFNO parameter.

Consult the systems programmer for assistance in resolving the cause of the error.

FMNDB520

SQL statement too long (short) The SQL statement is > 32K-2 in length. The maximum length for an SQL statement for Db2® versions 6 or 7 is 32765 characters. The statement cannot be executed. (long)

Explanation: FM/Db2 detected an SQL statement greater than the 32K-2 limit, which is applicable to Db2® versions prior to Db2® version 8. The SQL statement cannot be executed.

User response: Simplify the SQL statement, and retry the operation.

FMNDB521

SQL statement too long (short) The SQL statement is > 2M in length. The maximum length for an SQL statement for Db2® versions 8 or later is 2097152 characters. The statement cannot be executed.

Explanation: FM/Db2 detected an SQL statement greater than the 2M (2097152) limit, which is applicable to Db2® versions 8, and later. The SQL statement cannot be executed.

User response: Simplify the SQL statement, and retry the operation.

FMNDB600

Global Settings

Explanation: This message appears on some FM/Db2 options panels to indicate that the global options are being processed. FM/Db2 offers two levels of option settings for most functions. These are:

1. Global options, selected using option 0 from the FM/Db2 main menu. These options are saved in the ISPF profile data set for the user in the ISPF PROFILE pool, and persist between each FM/Db2 session.
2. Local options, selected from the function entry panel ("Edit options"). These options persist until the user exits the current FM/Db2 function, and overrides any Global options that may be in effect. See the *File Manager User's Guide for Db2® Data* for a full explanation.

User response: No action required. Informational message.

FMNDB601

Changes discarded (short) Invalid changes to the default high level qualifier have been discarded. (long)

Explanation: An invalid value for the "default high level qualifier" field was specified, followed by an attempt to leave the panel. The invalid value has been discarded.

User response: Examine the value for "default high level qualifier" and re-enter the desired value. Press Enter to validate the value, prior to leaving the panel.

FMNDB602

Changes discarded (short) Invalid changes to the display width values have been discarded. (long).

Explanation: An invalid value for one of the "Display width for varying columns" fields was entered on the "Object List Options (2 of 2)" panel, followed by an attempt to leave the panel. The invalid value (or values) has been discarded.

User response: Use the field level help for each field (place the cursor on the field, press the HELP key, PF1 by default) to determine the valid values for each field. After entering a new value, press ENTER to validate the values, prior to leaving the panel.

FMNDB757

SQLCODE=SQLCODE, row count row(s) affected.

Explanation: This is a message insert used in the FM/Db2 audit report utility. *SQLCODE* is the SQLCODE associated with an SQL statement, which might have affected 1 or more rows. *row count* shows the number of rows, as reported by Db2®, that were affected by the SQL statement. For SQL statements that affect Db2® objects subject to referential integrity constraints, the row count value does not show rows affected in objects other than the primary object affected by the SQL statement./

User response: No action required.

FMNDB765

Privilege statements: count

Explanation: This is a message insert used in the FM/Db2 audit report utility. *count* shows the number of SQL statements issued by the FM/Db2 function that might affect Db2® privileges, typically GRANT and REVOKE.

User response: No action required.

FMNDB800

count rows exported (short) countrow(s) exported from Db2® object source Db2 object to file file name. (long).

Explanation: This message is issued at the end of a File Manager/Db2 export function. The number of rows exported, *count* the Db2® object from which the rows were exported, *source Db2 object* and the output file name that contains the exported data, *file name* are shown.

User response: No action required.

FMNDB801

Export canceled (short) Export function was canceled by the user, or error encountered while processing the copybook. (long).

Explanation: This message is issued by the FM/Db2 export utility. The current FM/Db2 export function is canceled and the FM/Db2 export function entry panel is redisplayed.

User response: If the user pressed the END or CANCEL PFkeys on the export "To" panel, none. If the user pressed ENTER on the export "To" panel, examine any copybook or template specified for the export data set for errors.

FMNDB802

Exporting...

Explanation: This message is issued by the FM/Db2 export utility to indicate that export operations are in progress.**User response:** No action required. Informational message.

FMNDB803

count rows imported (short) *count* rows imported, from file *input file name* to Db2® object *target Db2 object*. *duplicate count* duplicate rows not imported. *error count* rows in error not imported. *selection count* rows dropped via record selection. *REXX drop count* rows dropped by REXX proc. (long).

Explanation:

This message is issued at the end the FM/Db2 import utility, and shows summary statistics for the import operation.

- *count* is the number of rows imported.
- *duplicate count* is the number of duplicate row errors that were encountered. The record that caused the duplicate row error has not been imported.
- *error count* is the number of records that generated errors other than a duplicate row error. The record that caused the error has not been imported.
- *selection count* is the number of records (rows) that were dropped as a result of record selection.
- *REXX drop count* is the number of records (rows) that were dropped because of user-specified processing in the REXX procedure. The same information is presented on the "Import Report" panel. This message is issued when the Update option for duplicate key errors is not selected on the import options panel.

User response: No action required.

FMNDB804

Import canceled (short) Import function was canceled by the user. (long).

Explanation: The user canceled the import operation, by pressing the END or CANCEL PFkey.**User response:** No action required. Informational message.

FMNDB805

Importing...

Explanation: This message is issued by the FM/Db2 import utility to indicate that import operations are in progress.**User response:** No action required. Informational message.

FMNDB806

Rollback completed (short) Import of *import file name* to *target Db2 object* was rolled back due to errors. *count* rows rolled back. *duplicate count* duplicate rows not imported. *updated count* duplicate rows updated. *not updated count* duplicate rows not updated. *error count* rows in error not imported. *drop count* rows dropped by record selection. *REXX drop count* rows dropped by REXX procedure. Note, that PF12/CANCEL on SQL error panel will skip each row in error.

Explanation: This is a message insert, used in the FM/Db2 audit report utility.

User response: No action required.

FMNDB807

row count rows created (short) *row count*rows created, in Db2® object *output Db2 object name*. *duplicate count* duplicate rows not created. *error count* in error not created.

Explanation: This message is issued by the FM/Db2 data create utility. *row count* is the number of rows that were inserted (created) in the output Db2® object *output Db2 object name*.

- *duplicate count* is the number of rows that could not be inserted because of duplicate key (SQLCODE-803) errors.
- *error count* is the number of rows that could not be inserted because of errors other than duplicate key errors.

User response: No action required. Informational message. If there are multiple duplicate key errors, you can edit the template for those columns that form part of the unique index keys to specify a pattern to be used when creating values for that column.

FMNDB808

Create canceled (short) Create function was canceled by the user.

Explanation: The user canceled the FM/Db2 data create function, typically by pressing the PF key assigned to CANCEL.

User response: No action required. Informational message.

FMNDB809

Creating...

Explanation: This message is issued by the FM/Db2 data create utility to indicate that data create operations are in progress.

User response: No action required. Informational message.

FMNDB810

No rows created (short) Create of *row count* rows was rolled back due to error. Note that PF12/CANCEL on SQL error panel will skip each row in error.

Explanation: The current FM/Db2 data create function has been terminated because of errors. No rows have been created in the output Db2® object because a Db2® ROLLBACK statement was issued, and this backed out all uncommitted changes. Prior to the error condition that caused the function to be terminated, *row count* rows had been inserted into the output Db2® object.

User response: If the function was executed online, the failing operation will have produced an SQL error, displayed to the user in the SQL error pop-up panel. Look up the SQLCODE shown and respond as indicated.

FMNDB811

row count duplicate rows not imported.

Explanation: The FM/Db2 import utility, executing in batch mode, did not import *row count* rows because of duplicate key (SQLCODE-803) errors.

User response: This is one of several messages that may be issued by the FM/Db2 import utility when run in batch mode. If duplicate key errors were not expected, examine the input data to determine why the errors occurred.

FMNDB812

row count row(s) in error not imported.

Explanation: The FM/Db2 import utility, executing in batch mode, did not import *row count* rows because of unspecified SQL errors.

User response: This is one of several messages that may be issued by the FM/Db2 import utility when run in batch mode. The presence of this message usually indicates a problem with the input data, which should be examined to determine why the errors occurred.

FMNDB813

row count row(s) dropped via record selection.

Explanation: The FM/Db2 import utility, executing in batch mode, did not import *row count* rows because the corresponding input record was dropped as part of the record selection process.

User response: This is one of several messages that may be issued by the FM/Db2 import utility when run in batch mode. When record selection criteria, or a REXX exec, is specified for the input template, this message indicates that one or more records did not meet the record selection criteria, or were dropped as part of the REXX procedure processing. If no REXX procedure was specified this message may indicate a mismatch between the input data and its associated template.

FMNDB814

row count row(s) dropped via REXX proc.

Explanation: The FM/Db2 import utility, executing in batch mode, did not import *row count* rows because the corresponding input record was dropped as part of the associated REXX procedure processing.

User response: This is one of several messages that may be issued by the FM/Db2 import utility when run in batch mode. The user response depends on context. It may be reasonable for records to be dropped. If, however, records should not be dropped as part of the REXX procedure processing, examine the input data to determine why the records were dropped.

FMNDB815

row count duplicate row(s) not created.

Explanation: The FM/Db2 data create utility, executing in batch mode, did not create *row count* rows because Db2® raised a duplicate key error (SQLCODE-803) when FM/Db2 attempted to insert the newly created row in the target Db2® object.

User response: This is one of several messages that may be issued by the FM/Db2 data create utility when run in batch mode. The user response depends on context. Db2® will always reject rows that violate uniqueness constraints. When many duplicate row errors are received consider adjusting the input parameters to avoid duplicate values for any index columns.

FMNDB816

row count row(s) in error not created.

Explanation: The FM/Db2 data create utility, executing in batch mode, did not create *row count* rows because Db2® raised an error (other than SQLCODE-803) when FM/Db2 attempted to insert the newly created row in the target Db2® object.

User response: This is one of several messages that may be issued by the FM/Db2 data create utility when run in batch mode. This message usually indicates an error. Db2® may reject the insert of a row for many reasons. Note, that the SQL error issued by Db2® is NOT SQLCODE-803. Duplicate row errors are reported separately. Examples of error SQLCODEs that might result in this message include: -530, -531, and -532 (referential integrity errors).

FMNDB817

row count existing rows(s) updated.

Explanation: The FM/Db2 import utility, executing in batch mode, updated *row count* rows. Only columns that are not part of any unique index key are updated.

User response: This is one of several messages that may be issued by the FM/Db2 import utility, when run in batch mode. The user response depends on context. In most cases, the update of existing rows is best. If, however, the import operation is not expected to cause duplicate key errors (SQLCODE-803), compare the input records and Db2® object, to discover why there are duplicates.

FMNDB818

row count existing rows(s) not updated.

Explanation: The FM/Db2 import utility, executing in batch mode, attempted to update existing rows after the insert operation for the record failed with SQLCODE-803 (duplicate key error). The update operation failed.

User response: This is one of several messages that may be issued by the FM/Db2 import utility, when run in batch mode. This message usually indicates an error. Db2® may reject the update of a row for many reasons. Examples of error SQLCODEs that might result in this message include -530, -531, and -532 (referential integrity errors).

FMNDB819

row count import/updt(d) (short) *row count* rows imported, from file *input data set name* to Db2® object *target Db2 object name*. *duplicate row count* duplicate rows updated. *duplicate error count* duplicate rows not updated. *error row count* rows in error not imported. *dropped record count* rows dropped by record selection. *Rexx drop count* rows) dropped by REXX procedure.

Explanation: This message is issued by the FM/Db2 import utility, when executed online. It summarises the statistics for the import operation just completed. This message is issued when the "update existing rows" option is selected, and when no rows were inserted, or updated. *row count* is the number of rows imported or updated. In this case, 0.

- *duplicate row count* is the number of records that generated SQLCODE-803 (duplicate key) errors.
- *duplicate error count* is the number of records for which the update of an existing row failed.
- *error row count* is the number of records that generated errors other than SQLCODE-803 for the INSERT operation.
- *dropped record count* is the number of records that were not considered (dropped) as a result of record selection.
- *Rexx drop count* is the number of records that were dropped via the user-specified REXX procedure.

User response: This message is issued when no rows were inserted, and no rows were updated. The user response depends on context. If insert or updates were expected, examine the input data to determine why no records were processed.

FMNDB820

Import complete. *Row count* row(s) imported.

Explanation: This message is issued by the FM/Db2 import utility at the completion of the import process. Row count rows were successfully imported.

User response: Informational message.

FMNDB821

Rollback complete. *Row count* row(s) rolled back.

Explanation: This message is issued by the FM/Db2 import utility at the completion of the import process. One or more rows were not successfully imported. The import for Row count rows was rolled back.

User response: Informational message.

FMNDB822

Row count rows imported (Short). *Row count* rows imported, from file *input data set name* to Db2 object *output object name*. *duplicate row count* duplicate rows updated. *Duplicate error count* duplicate rows not updated. *error row count* rows in error not imported. *dropped record count* rows dropped by record selection. *Rexx drop count* rows dropped by REXX procedure (Long).

Explanation: Upon completion of the FM/Db2 import (DBI), this message is displayed showing the statistics when rows were inserted into the Db2 object.

User response: Informational message.

FMNDB823

update row count rows updated (Short). *update row count* duplicate rows imported from file *input data set name* and updated in object *output object name*. *duplicate error count* duplicate rows not updated. *row count* rows imported. *error row count* rows in error not imported. *dropped record count* rows dropped by record selection. *Rexx drop count* rows dropped by REXX procedure (Long).

Explanation: Upon completion of the FM/Db2 import (DBI), this message is displayed showing the statistics when rows were updated in the Db2 object.

User response: Informational message.

FMNDB824

Rows imported/updated (Short). *row count* rows imported from file *input data set name* to Db2 object *output object name*. *duplicate row count* duplicate rows updated. *duplicate error count* duplicate rows not updated. *error row count* rows in error not imported. *dropped record count* rows dropped by record selection. *Rexx drop count* rows dropped by REXX procedure (Long).

Explanation: Upon completion of the FM/Db2 import (DBI), this message is displayed showing the statistics when rows were inserted or updated in the Db2 object.

User response: Informational message.

FMNDB825

duplicate row count duplicate row errors.

Explanation: Row count of duplicate rows in error.

User response: Informational message.

FMNDB826

All columns selected (short) No columns were selected in the template for *Db2 object name*. Processing cannot proceed without at least one selected column. FM/Db2 has automatically selected all columns for processing.

Explanation: This message is issued by either the FM/Db2 export, or FM/Db2 UNLOAD utilities. The template editor was used to deselect all columns, followed by an attempt to execute the function with the modified template. Since a File Manager/Db2 function requires at least one selected column to proceed, all columns are automatically selected and this message is issued.

User response: No action required. Informational message. By default, all columns of a Db2® object are selected for processing. While it is valid to deselect some of the columns in the Db2® object, it is invalid to deselect all columns, since this results in a "no-operation" condition.

FMNDB827

Import to view failed (short) The import operation has been canceled. Import to a view is only supported if the view is defined directly on a table. Repeat the operation using the actual table that the view refers to.

Explanation: The FM/Db2 import utility was used to import data into a Db2® view. The Db2® view refers to more than one Db2® table, or refers to one or more views. Import to this type of view is not supported. The import operation is canceled.

User response: In general, import to a Db2® view defined as "SELECT * FROM *Db2 table name*" is supported. Import to views that refer to multiple Db2® tables, or views, is not supported. Where possible, use the FM/Db2 import utility with a table name, rather than a dependent view.

FMNDB828

Remapping required (short) No columns in the target table are mapped to any fields in the input template. This can occur if the column names in the target object are different to the field names in the input template. Edit the template for the target object to set the mapping between columns/fields in the target/input templates.

Explanation: The FM/Db2 import utility was used with an input template that has field names that do not match any of the columns in the target Db2® object. The automatic field mapping process used by FM/Db2, cannot reliably determine which fields in the input template correspond with columns in the target Db2® object. Manual mapping of each field in the input template to a column in the target Db2® object is required.

User response: This message may be issued in the situation where the wrong input file template is specified for a File Manager/Db2 import function. Advanced usage of the FM/Db2 import utility allows individual mapping of each column in the target Db2® object to a corresponding field of the input template. The column and field names need not match, nor the relative positions of the columns in the Db2® object and fields in the input record. If this is the intended usage, use the template editor ("edit template mapping") to set the relationship between columns and fields, and retry the operation.

FMNDB829

Invalid value (short) The valid values are ALL or a number in the range 0-2147483647. (long).

Explanation: An invalid value was entered in the "Max duplicates" field of the "Copy Options" panel. The valid values are "ALL" or an integer in the range 0-2147483647, inclusive.

User response: Correct the invalid value.

FMNDB831

Browse substituted (short) The Db2® result table is not updateable, specifically because not all columns of the first table named in the from clause are present, nor are all columns of any unique index(es) defined on this table. Browse has been substituted for edit. (long).

Explanation: A SELECT statement was entered using one of the FM/Db2 functions that allow free-form SQL statements to be processed. When FM/Db2 uses the editor to display the result table from SELECT statement, edit operations may not be possible for free-form SQL statements. This message occurs when the conditions listed in the message are not met. For tables with unique indexes defined, FM/Db2 can use the values in the columns that comprise the unique index to uniquely identify any row of the table. However, this requires that every column in the unique index key is represented in the result table. If reliable edit is not possible, FM/Db2 converts the edit session to browse to avoid any possibility of data corruption.

User response: No action required. Informational message. If edit operations of the result table are required, the preferred method is to edit the Db2® object directly.

FMNDB832

Update not possible (short) FM/Db2 cannot update the data in the row(s) marked with =INERR. This error may occur attempting to edit the result table from an arbitrary select statement entered using option 4.2, 4.3 or 4.4. You should cancel the current edit session and then edit the underlying Db2® object directly.

Explanation: An attempt was made to update data in the row of a result table for an SQL statement entered using FM/Db2 options 4.2, 4.3, or 4.4. The update failed because Db2® rejected the update. There are various reasons why this error may occur, including editing the result table for a join. The update operation cannot be performed.

User response: If edit operations of the result table are required, the preferred method is to edit the Db2® object directly.

FMNDB833

Delete not possible (short) FM/Db2 cannot delete the data in the row(s) marked with =INERR. This error may occur attempting to edit the result table from an arbitrary select statement entered using option 4.2, 4.3 or 4.4. You should cancel the current edit session and then edit the underlying Db2® object directly.

Explanation: An attempt was made to delete a row of a result table for an SQL statement entered using FM/Db2 options 4.2, 4.3, or 4.4. The update failed because Db2® rejected the delete. There are various reasons why this error may occur, including editing the result table for a join. The update operation cannot be performed.

User response: If edit operations of the result table are required, the preferred method is to edit the Db2® object directly.

FMNDB835

Parameter marker invalid (short) The SELECT statement contains one or more "?". Db2® interprets these as parameter markers, resulting in an SQL error. Replace the "?" with constants and rerun the statement.

Explanation: A SELECT statement was entered using FM/Db2 options 4.3, or 4.4, and possibly other options. The SELECT statement includes Db2® parameter markers (?). While the use of Db2® parameter markers is valid when using, for example, an application programming language, the use of Db2® parameter markers in SELECT statements processed by FM/Db2 is invalid.

User response: Locate the Db2® parameter markers in the SELECT statement. Replace each occurrence with a constant of the appropriate type. Rerun the statement.

FMNDB836

Browse substituted (short) This version of FM/Db2 does not support new Db2® data types introduced with Db2® version 9. Browse has been substituted for edit. (long).

Explanation: FM/Db2 detected a data type in the Db2® object being edited that is not currently supported. To avoid the possibility of data corruption, FM/Db2 has substituted browse for edit.

User response: Determine which column has the unsupported data type. Contact IBM® Support for information about later versions of FM/Db2 which support the new data type.

FMNDB837

XML column(s) (short) This version of FM/Db2 does not support the XML data type introduced with Db2® version 9. The function cannot be performed.

Explanation: FM/Db2 detected one or more XML columns in the object being processed by the current FM/Db2 function (editor, copy, import, export, and print). XML columns are not supported. The function cannot be performed, and processing is terminated.

User response: Specify a Db2® object that does not include XML columns.

FMNDB838

Duplicate count reached (short) The specified duplicate count was reached. The import has been canceled. (long).

Explanation: A File Manager/Db2 import was specified with a non-zero "Max duplicate" count. During the processing of the input data, the number of duplicate row errors reached the specified "Max duplicate" value. The import operation if canceled.

User response: The "Max duplicate" count value is specified on the Import Options panel, selected using the "edit options" field on the Import function entry panel. The response depends on the context of when duplicate row errors are expected. Rerun the import after increasing the "Max duplicate" value. When duplicate row errors are not expected, examine the input data to determine why duplicate row errors are occurring.

FMNDB839

Unable to process (short) The Db2® object contains one or more LOB columns. There is insufficient memory available for FM/Db2 to process data from this object, because of the large size of the LOB column(s). Refer to the Edit Tutorial, General information, Restrictions for additional information on how to avoid this problem.

Explanation: FM/Db2 does not support the processing of Db2® objects with LOB columns. The function cannot be performed and processing is terminated.

User response: Specify a Db2® object that does not include LOB columns.

FMNDB840

Format not for template (short) The Data Format is not compatible with that used to create the template. Template is *template type*.

Explanation: This message is issued by the FM/Db2 import utility when there is a mismatch between the template describing the input data, and the data format option for the import data set. The import cannot be processed, and the import is canceled. The type of template specified is *template type*, which will be one of the following: Db2® Unload; Db2® DSNTIAUL; User defined; Base; FM/Db2 SQLDA; Other. (long).

User response: The data format for the input data set is specified on the Import options panel, selected using the "edit options" field on the Import function entry panel. The value specified must match the actual data format of the input data. It must also match the type of template specified in the template, or copybook, specified on the import function entry panel. Verify that the specified template correctly describes the input data. Determine the data format of the input data, use that information to set the appropriate data format value on the Import options panel, and retry the import operation.

FMNDB849

Incompatible options (short) The data format must be 2 (Db2® unload format) when execution option 3 (Batch, using Db2® UNLOAD) is selected. (long).

Explanation: The FM/Db2 export function can be used to generate a Db2® utility job that will run the Db2® UNLOAD utility for a Db2® table. When this option is selected, the format of the output data is determined by Db2®. Therefore, the data format must be set to '2' (Db2® unload format). The data format for the output data set is specified on the first export options panel, selected using the "edit options" field on the Export function entry panel

User response: Adjust the data format option as indicated, and retry the operation. Note, that it is also possible to use the FM/Db2 export function to export data in "Db2® unload format", without running a Db2® batch job. If this is what is intended, set the execution option on the first export options panel to either '1' (online) or '2' (batch), and retry the operation.

FMNDB850

Must be sequential file (short) The Db2® UNLOAD utility does not support unload of data to a partitioned data set. (long).

Explanation: The FM/Db2 export utility was executed with an execution option of '3' (Batch, using Db2® unload). The output data set specified on the export 'To' panel, is a partitioned data set includes a member name. While the FM/Db2 export utility can export data in Db2® unload format to a member of a partitioned data set, this is not supported by the Db2® UNLOAD utility.

User response: Specify a sequential file (Data set organization of PS), rather than a partitioned data set (Data set organization of PO), for the output data set. Retry the operation.

FMNDB851

Must be sequential file (short) The Db2® UNLOAD utility requires that the unload data set be a sequential file (DSORG=PS).

Explanation: The FM/Db2 export utility was executed with an execution option of '3' (Batch, using Db2® unload). The output data set specified on the export 'To' panel, is not a sequential data set. While the FM/Db2 export utility can export data in Db2® unload format to non-sequential data sets, the only data set type supported by the Db2® UNLOAD utility is sequential.

User response: Check the type for the output data set specified for the Db2® unload operation on the FM/Db2 export 'To' panel. Ensure that a sequential file (Data set organization of PS) is specified. Retry the operation.

FMNDB852

Not required (short) A query number value is only required with the EXPLAIN primary command. (long).

Explanation: An SQL statement and query number value were entered on the "Enter, Execute and Explain SQL" panel (FM/Db2 option 4.3). A query number is only required when the EXPLAIN primary command is issued.

User response: Remove the query number and retry the operation. If the intention was to EXPLAIN the SQL statement, type 'EXPLAIN' on the command line, and press Enter.

FMNDB853

Delete failed (short) The deletion of all rows from the Db2® object failed - the import function has been canceled. (long).

Explanation: The "Delete existing rows" option was specified for a File Manager/Db2 import. When FM/Db2 attempted to delete all rows from the target Db2® object, Db2® rejected the operation. The import cannot proceed and the import is canceled. No data has been imported.

User response: There are many reasons why Db2® might reject a 'DELETE * FROM *object name*' statement, including referential integrity errors, locking problems, and unavailable resources. Retry the operation. If the problem persists, issue the 'DELETE * FROM *object name*' directly using FM/Db2 options 4.3, 4.4, or Db2® SPUFI. If the operation fails, use the SQLCODE to determine the cause of the failure.

FMNDB855

row count rows+hdr exported (short) *Row count*row(s) and column header row exported from Db2® object *object name* to file *data set name*. (long).

Explanation: This message is issued by the FM/Db2 export function and is specific for an export with CSV format and the "Include column headers" option selected. FM/Db2 exported *row count* rows from Db2® object *object name* to data set *data set name*. The first row exported is a header row, containing the names of the Db2® columns in place of the data for those columns.

User response: No action required. Informational message.

FMNDB856

Invalid character ' or " (short) The Delimited Variables (CSV) separator cannot contain either a single quote (') or double quote ("). Choose another value. (long).

Explanation: The user entered a value in the "Separator character" field on the second FM/Db2 Export options panel. This field is used to enter a one or two character value for the separator character in "delimited variables (CSV)" export format. The value entered contains either a single or double quote, which is not supported.

User response: The delimited variables (CSV, comma separated variables) format is loosely defined. In situations where the default separator character (comma) is inappropriate, FM/Db2 allows the specification of a one, or two, character alternative value. The separator value cannot include either a single quotation mark or double quotation mark, because this causes syntactical ambiguity when the exported data also includes single or double quotation marks, either within the data, or inserted to encapsulate the data. Select another value.

FMNDB858

Must be numeric, >0 (short) The value entered must be an integer in the range 1-2147483647. (long).

Explanation: A value entered in the "start position" field on the editor function entry panel, or the "create count" field on the data create function entry panel, is invalid. A numeric value is required, which must be a positive integer in the range 1-2147483647, inclusive.

User response: Correct the value, retry the operation.

FMNDB859

Must be numeric, >=0 (short) The value entered must be an integer in the range 0-2147483647. You can specify 0, * or ALL to indicate all rows. (long).

Explanation: The value entered in a field on a File Manager/Db2 function entry panel is invalid. A numeric value is required, which must be a non-negative integer in the range 0-2147483647, inclusive. This message is issued for various "row count" input fields. A value of * and ALL can also be entered as synonyms for 0. These values indicate that there is no limit to the number of rows or records to be processed.

User response: Correct the value, retry the operation.

FMNDB890

Db2® subsystem *Db2 SSID* not defined to z/OS®?.

Explanation: This message is issued by a File Manager/Db2 batch job, when connection to Db2® system *Db2 SSID* failed. One reason for this message being issued is that *D2 SSID* does not exist (has not been defined to the local z/OS® system). This might occur in sites running multiple LPARs with shared DASD, where Db2® systems are available on some, but not other, z/OS® systems.

User response: Check that the Db2® SSID specified as a parameter is defined to the z/OS® system where the batch job was executed. If this is not the problem, look up Db2® error code '00F30006' in the Db2® Codes manual and proceed as directed for that error.

FMNDB900

Own authorization ID (short) An authorization ID cannot grant a privilege to itself. (long).

Explanation: This message is issued by the FM/Db2 privileges function, in the situation where "An authorization ID or a role attempted to execute a GRANT statement in which that ID itself appears as one of the entries in the list of 'grantee' authorization IDs or role names".

User response: Respond as for SQLCODE-554. The usual remedy is to remove the user current Db2® authid/role from the list of target Db2® authids/roles.

FMNDB903

Identifier too long (short) The identifier is too long. See the SQL Reference for information about the maximum lengths for identifiers. Db2® returned an SQL code of -107 for SQL statement *SQL statement*. (long).

Explanation: This message is issued when an SQL statement contains an identifier that is too long. When connected to Db2® V8 systems or later, this error is unlikely, given the large maximum lengths for most Db2® identifiers, compared to the corresponding Db2® V7 values.

User response: Respond as for SQLCODE-107

FMNDB904

Not authorized (short) Your authorization ID does not have the authority to change the privileges for this object. Db2® returned an SQL code of -551 for SQL statement *SL statement*(long)

Explanation: This message is issued by the FM/Db2 Object Privileges utility. The Db2® authorization IDs for the current user do not have the authority to change (GRANT or REVOKE) for the object.

User response: Respond as for SQLCODE-551. See your Db2® System Administrator.

FMNDB905

Object not found (short) The specified Db2® object does not exist. Db2® returned an SQL code of -204 for the SQL statement *SL statement* (long)

Explanation: This message is issued by the FM/Db2 Object Privileges utility. The Db2® object for which the privileges are to be changed could not be found (SQLCODE-204).

User response: Respond as for SQLCODE-204. Check the Db2® object name.

FMNDB907

Cannot be revoked (short) You cannot revoke the specified privilege because the revokee does not possess the privilege or because the specified Db2® authid did not grant the privilege. Db2® returned an SQL code of -556 for SQL statement *SL Statement*. (long).

Explanation: This message is issued by the FM/Db2 Object Privileges utility. The privilege cannot be revoked.

User response: Respond as for SQLCODE-556. Refer to the SQL Codes manual, for the appropriate version of Db2®, for a detailed list of possible causes of this error.

FMNDB909

Not authorized (short) Your authorization ID does not have the privilege to issue a REVOKE statement with the BY clause. Db2® returned an SQL code of -552 for SQL statement *SL statement*. (long)

Explanation: This message is issued by the FM/Db2 Object Privileges utility. The privilege cannot be revoked.

User response: Respond as for SQLCODE-552.

FMNDB910

Privilege conflict (short) One or more privileges conflict with one or more other privileges. (long).

Explanation: This message is issued by the FM/Db2 Object Privileges utility. An example that causes this error is selecting the 'ALL' option for a privilege, as well as one or more of the individual privileges that are included when 'ALL' is specified.

User response: Correct the specification of the privileges to be processed. In general selecting the 'ALL' option means that you should deselect all of the privileges that are included when 'ALL' is specified.

FMNDB911

Not required (short) This field should be blank for the specified option. (long).

Explanation: On the "Alter Table - VALIDPROC" panel, the "type of VALIDPROC" is set to 1, and a value is also specified for "program name". A value for "program name" is only required when the "type of VALID-PROC" is set to 2.

User response: Check the "type of VALIDPROC" specification. If NULL is the intended specification, remove the value from the "program name" field, and retry the operation. If the intention is to add a program name, change the "type of VALIDPROC" specification to 2, and retry the operation.

FMNDB913

Invalid option (short) The selected option is not one of the listed values or the object type is not supported on the remote Db2® system you specified. This error can occur when you try to list certain Db2® objects on a remote Db2® system that is at an earlier release of Db2® than the system to which you are connected.

Explanation: This message is issued by the FM/Db2 Object Privileges utility. The value entered in the "object type" field is invalid. The request cannot be processed.

User response: The valid options for the "Object type" field are listed on the panel. Specify one of the values listed (1-15 inclusive).

FMNDB914

Different Db2® release (short) The release level of the remote Db2® system is different than the release level of the Db2® system to which you are connected. The choice of Db2® object types has been refreshed to show those object types supported on the remote system. Press ENTER again to get the requested list. (long).

Explanation: This message is issued by the FM/Db2 Object List and Object Privileges utilities when the user enters a remote location value. FM/Db2 connects to the specified location and compares the Db2® version of the remote location against the version of the currently connected Db2® system. When the values are different this message is issued.

User response: No action required. Informational message. Press enter to refresh the list of available object types.

FMNDB915

Empty table (short) The Db2® object contains no rows, or no rows match the specified row selection criteria. (long).

Explanation: This message is issued by the FM/Db2 editor when the result table for an object or select statement contains no rows.

User response: No action required. Informational message.

FMNDB916

Excluded rows shadow is off. There are no unexcluded rows to display. (long).

Explanation: In a File Manager/Db2 editor session, the shadow-line for excluded-rows has been turned off, and there are no rows to display. Note, that when the excluded-row shadow-line has been turned off, the string 'SHAD' appears immediately to the left of "Format", at the top right of the display, in TABL mode. For those familiar with ISPF shadow lines, the FM/Db2 editor allows the display of the shadow-line indicator to be suppressed, using a command like "SHADOW X OFF". This is not supported in the ISPF editor. Excluded lines are always indicated with a shadow-line. When excluded-row shadow-lines are turned off and when all of the rows in the current editor session are shadow-lines, the editor display appears as though there are no rows in the table (no shadow-line indicator). This message is displayed to alert the user to the fact that there are rows in the result table, even though there are no lines displayed.

User response: No action required. Informational message. You can turn on the shadow-line indicator with "SHADOW X ON".

FMNDB917

No rows to display.

Explanation: In a File Manager/Db2 editor session, the shadow-line for excluded-rows is turned on, and there are no rows to display. See also the message description for FMNDB916. This message is typically issued when edit operations have deleted all rows from the current editor session.

User response: No action required. Informational message.

FMNDB918

Excluded rows shadow is off. Either no unexcluded rows to display, or no rows match the filter specification. (long).

Explanation: In a File Manager/Db2 object list/privileges display, the shadow-line for excluded-rows has been turned off, and there are no rows to display. Note, that when the excluded-row shadow line has been turned off the string 'SHAD' appears immediately to the left of "Format", at the top right of the display, in TABL mode. The FM/Db2 object list/privileges utilities use the FM/Db2 editor to display lists of objects and privileges. When a filter value is specified for any column, the editor display is adjusted to show only those rows that match the filter value for that column. Any nonmatching rows are converted to excluded-rows, and these rows do NOT produce a shadow-line. This occurs regardless of the current setting for the excluded-row shadow-line. For those familiar with ISPF shadow-lines, the FM/Db2 editor allows the display of the shadow-line indicator to be suppressed, using a command like "SHADOW X OFF". This is not supported in the ISPF editor. Excluded-lines are always indicated with a shadow-line. When all of the rows in the current display are shadow-lines, the editor display appears as though there are no rows object list/privilege display (no shadow-line indicator). This message is displayed to alert the user to the fact that there are rows in the object list/privilege display, even though there are no lines displayed. This message is displayed when either:

- A filter value entered for a column results in no matches, or;
- When all rows are excluded.

User response: No action required. Informational message.

FMNDB919

No rows to display, or no rows match the filter specification. (long).

Explanation: In a File Manager/Db2 object/privileges display, the shadow-line for excluded-rows is turned on, and there are no rows to display. The FM/Db2 object list/privileges utilities use the FM/Db2 editor to display lists of objects and privileges. See also the message description for [FMNDB918 on page 1088](#). This message is displayed when a filter value entered for a column results in no matches.

User response: No action required. Informational message.

FMNDB921

No rows match key (short) There are no rows in the parent table that match the foreign key value. This can occur when a foreign key column(s) has the NULL value. (long).

Explanation: A related edit session of a parent table has no rows that match a foreign key in a dependent table.

User response: No action required. As noted in the long message text, this condition can occur when a foreign key value in the dependent table is NULL.

FMNDB922

No rows match key (short) There are no rows in the dependent table that match the primary/parent key value. (long).

Explanation: A related edit session of a dependent table has no rows with a foreign key that match the primary or parent key value in the parent table.

User response: No action required. A parent/primary key value may exist for which there are no corresponding rows (in terms of foreign key value) in the dependent table.

FMNDB923

Already granted warning (short) At least one of the authid(s) or role(s) already possesses the privilege(s) from the grantor.

Explanation: This message is issued by the FM/Db2 Object privileges utility when a GRANT statement returns an SQLCODE +562. This is a warning condition indicating that the GRANT has already been executed for one or more privilege/authid/role combination. The execution of the SQL statement is successful. Any privileges previously held by the target Db2® authids/roles from the grantor are retained (not changed). Any new privileges specified have been successfully GRANTED.

User response: No action required. When there are multiple Db2® authids or roles as target for the GRANT, or multiple privileges being GRANTED, it is not possible to determine which privileges were previously available.

FMNDB924

Grant option warning (short) The WITH GRANT OPTION was ignored for one or more of the privilege(s). (long).

Explanation: A GRANT statement generated by the FM/Db2 privileges utility was executed. The statement included the "WITH GRANT OPTION" clause. Db2® returned SQLCODE+558. This is a warning condition indicating that the "WITH GRANT OPTION" clause is redundant. The GRANT statement was successfully executed. An example of an operation that results in this warning condition is attempting to grant the SYSADM privilege to a Db2® authid, with "WITH GRANT OPTION". The FM/Db2 privileges Grant panels allow either 'Y', or 'G', to be specified against the various Db2® privileges; 'Y' corresponds to "GRANT" while 'G' corresponds to "GRANT" and "WITH GRANT OPTION".

User response: No action required.

FMNDB925

Not authorized (short) Your authorization ID does not have the authority to *GRANT|REVOKE* the *privilege type* system privilege. Db2® returned an SQL code of -552 for SQL statement *SL statement*.

Explanation: The FM/Db2 privileges utility attempted to execute SQL statement *SL statement*. Execution failed with Db2® returning SQLCODE -552, which indicates that the user does not have the authority to execute the statement.

User response: This is an error condition. Consult with your Db2® security administrator to obtain the necessary Db2® authority to execute the statement.

FMNDB926

Own authorization ID (short) An authorization ID cannot revoke a privilege from itself. (long).

Explanation: The FM/Db2 privileges utility was used to issue a REVOKE statement. Execution of the statement failed with Db2® returning SQLCODE-555. This error is issued when the REVOKE statement would have the effect of removing a privilege from a Db2® authid or role that is possessed by the same Db2® authid or role. This is not supported.

User response: Examine the grantees and remove the Db2® authid or role that corresponds to the current Db2® authid or role of the user.

FMNDB927

Invalid name (short) The name is invalid. A database/table space/plan name must be an SQL ordinary identifier - no lower case characters. See the SQL Reference manual for a definition. Db2® returned an SQL code of -113 for SQL statement *SQL statement*.

Explanation: A database/table space/plan name entered using the FM/Db2 object privileges utility is invalid. An SQL ordinary identifier is required. See the SQL Reference for a definition. An ordinary identifier is an uppercase letter, followed by zero or more characters, each of which is an uppercase letter, a digit, or the underscore character.

User response: Correct the name and retry the operation.

FMNDB928

Insufficient authority (short). You cannot revoke this privilege. The current SQLID (*D2 authid*) does not have SYSADM or SYSCTRL authority. You can only revoke a privilege when the current SQLID (*Db2 authid*) originally granted the privilege. (long).

Explanation: The FM/Db2 privileges utility was used to attempt to issue a REVOKE statement. The user current Db2® authid *D2 authid*, is different to the Db2® authid originally used to grant the privilege. While it is possible to revoke a privilege originally granted by another Db2® authid, this requires SYSADM or SYSCTRL authority, which the current *Db2 authid* does not have. The statement cannot be executed.

User response: In general, without either SYSADM or SYSCTRL authority, you will be unable to revoke Db2® privileges granted by another Db2® authid. Consult with your Db2® Security Administrator to obtain the necessary Db2® authority to execute the statement.

FMNDB939

LOB limit exceeded (short). A Db2® internal limit for the size of a LOB has been exceeded. Look up the SQLCODE-904 issued previously and respond as appropriate.

Explanation: Db2® reported an SQLCODE-904 error when an attempt was made to add data to a LOB. This error is specific to the XML editor. The current editor session is terminated and the current unit of work is rolled back. Any changes made since the last explicit SAVE are lost.

User response: An SQL error pop-up panel is displayed before this message is issued. Look up the reason code in the message and respond as appropriate. You might need to increase the Db2® installation value LOBVALA, specified in DSNTIJUZ.

FMNDB940

Invalid PIECESIZE (short). PIECESIZE in *Kilobytes/Megabytes/Gigabytes* must be a multiple of 2 between *mn value* and *mx value*. (long).

Explanation: An invalid value was entered for "piecesize" on the "Create Index: Type" panel (Db2® Object Functions). *mn value* and *mx value* show the minimum and maximum values that can be used for the specified space-multiplier, which will be either kilobytes, megabytes, or gigabytes.

User response: Select an integer value between the two values shown that is a power of 2. For kilobytes, valid values are: 256, 512, 1024, .. 67,108,864. For Megabytes valid values are: 1, 2, 4 .. 65,536. For Gigabytes, valid values are: 1, 2, 4 .. 64.

FMNDB941

Invalid combination (short) A VCAT name cannot be specified with a storage group name, primary, or secondary space requirements, or the ERASE option.

Explanation: An invalid combination of values was entered when attempting to create a table space, or index, using the Db2® Object Functions. When creating either a table space, or index, a VCAT name can be specified, indicating that space allocation is under user control. Otherwise, the VCAT name must be blank, and a storage group name can be specified, indicating that space allocation is controlled by Db2®. In the latter case, primary and secondary space values may also be entered.

User response: Decide whether a VCAT name or storage group name is appropriate. In the former case do not specify any of: storage group name, primary or secondary space allocation values. In the latter case do not specify a VCAT name value.

FMNDB942

Storage group required (short) Primary and secondary space requirements, and the ERASE option can only be specified if a storage group name is also specified. (long)

Explanation: An invalid combination of values was entered when attempting to create an index using the Db2® Object Functions. Either:

1. One or more non-blank values have been specified for "Primary space" or "Secondary space" on the "Create Index:Allocation" panel. However the "Storage group name" value is blank. You must enter a "storage group name" if you intend to specify space allocation values.
2. One or more non-blank values have been specified for "Primary space", "Secondary space", or "Erase data" on the "Create Index: Partitions" panel. However, the "Storage group name" value is blank. You must enter a "storage group name" if you intend to specify space allocation or an "Erase data" value."

User response: Enter a valid storage group name. Alternatively do not specify "Primary space" "Secondary space" or "Erase data" values.

FMNDB943

Invalid selection (short) Select or deselect columns using the character "S". Order columns explicitly in the *key/index* using numerics.

Explanation: An invalid character was entered in either the Create Table, or Create Index functions, of the Db2® Objects utility.

User response: You can select a column by typing an 'S' in the appropriate field. All other letters are invalid. If a column has previously been selected, you deselect it by typing 'S' in the appropriate field. Once a column has been selected, you can enter any numeric (1, 2, 3, and so on) to specify the order of the columns in the index, or key. On the "Create Table: Unique Constraints" panel you can also select a column by typing any numeric in the appropriate field, and deselect a column by removing the number in the appropriate field.

FMNDB944

Already used (short). Order number *number* was already set for column *column name* on row *row number* of the display.

Explanation: An invalid number was entered in either the "Create Table" or "Create Index" functions of the Db2® Objects utility. When defining an index, or key with multiple columns, the order of the columns in the index, or key, is specified using numbers. Thus, for an index comprising three columns (COL4, COL7 and COL10), you would enter the numbers 1, 2 and 3 (in some combination) against those three columns.

User response: The number for the column has already been used for another column. Determine which columns should be in the index or key, then assign a unique number to each column. The column with the lowest used number will be the first column in the index or key, followed by the column with next-lowest-used number, and so on.

FMNDB945

Maximum partitions (short). The insert (I) or repeat (R) command cannot be executed because the maximum number of partitions allowed by Db2® has already been defined. (long).

Explanation: The user issued the 'I' or 'R' command against the 254th row on the "Create Index: Partitions" panel of the Db2® Objects utility. The maximum number of partitions that can be defined is 254 (Db2® version 7), so extra partitions cannot be added.

User response: No action required.

FMNDB946

Invalid value (short). Enter one of the listed values: *list of valid values*. (long).

Explanation: An invalid value was entered for a field in the Db2® Objects function. *list of valid values* contains the acceptable values for the field in error.

User response: Specify a value shown in *list of valid values*.

FMNDB947

Set columns/partitions (short). You must use option 2 to select the columns comprising the index and option 5 to define the partitions before assigning partition values. (long).

Explanation: The user selected option 6 on the "Create Index" panel of the Db2® Objects function. Either the columns that should comprise the index, or the partitions for the index, have not been defined. Both tasks must be completed before partition values may be assigned.

User response: Select option 2 to confirm that the columns that should comprise the index have been identified; then select option 5 to define the partitions for the new index.

FMNDB948

IT:Define &\$ITEM:TE &\$ITEM---17 T:You must use option &\$OPTN to define the &\$ITEM for the &\$OBJ :TE T:before using this option.:TE

Explanation: T

User response: I

FMNDB949

Table not found (short). The table to be indexed was not found in the Db2® catalog. (long).

Explanation: The user entered a table name on the "Create Index" panel of the Db2® Objects function. That table name does not exist on the current server.

User response: Check the table name for spelling mistakes. You can use the FM/Db2 Object List utility to show all table names defined at the current Db2® server if required. Correct the table name and retry the operation.

FMNDB950

Set partition values (short) Partitions have been defined for this index using option 5. You must set partition values using option 6 before you can define the index.

Explanation: This message is issued by the "Create Index" dialog (Db2® Object Functions). For a partitioned index, the number of partitions is set using option 5 (Partitions). Once the partitions are defined, you also need to set the maximum values for each partition using option 6 (Partition values). The index cannot be created until the partition values have been specified.

User response: If a partitioned index is required, select option 6 (Partition values), and specified appropriate values. If a non-partitioned index is required, select option 5 (Partitions), and delete all but one partition entry.

FMNDB951

Update partition values (short) The column selections or partition definitions have changed since the partition values were set. You must reset the partition values using option 6 before you can define the index.

Explanation: This message is issued by the "Create Index" dialog (Db2® Object Functions). Partition values have been set for all partitions and columns previously specified. However, a subsequent change has invalidated the partition values. There are two possibilities:

1. The columns specified for the new index have changed (columns added or deleted).
2. The partitions specified using option 5 (Partitions) have changed. The index cannot be created until the partition values have be specified.

User response: If a partitioned index is required, select option 6 (Partition values) and specified appropriate values. If a non-partitioned index is required, select option 5 (Partitions) and delete all but one partition entry.

FMNDB952

Conflicting selection (short) *value 1* > is not valid because *value 2*.

Explanation: This message is issued in many places within the Db2® Object Function dialog. The SQL syntax used to create the object has restrictions on the use of both *value 1* and *value 2*. In most cases you can resolve the error by specifying either *value 1* or *value 2*, but not both. The Object cannot be created until the conflicting selections are resolved.

User response: Determine which of the two selections is appropriate and remove the unwanted selection. Retry the operation. If the appropriate choice cannot be determined, refer to the SQL Reference manual for the appropriate version of Db2®.

FMNDB953

Errors retained (short) Invalid data has been saved because the CANCEL command was entered in response to an input verification message. The *statement type* statement may be invalid if executed: return to the previous panel and correct the error, or return to the *panel name* panel and start from the beginning.

Explanation: This message is issued in many places within the Db2® Object Function dialog. An invalid value was entered on an option panel for the current CREATE or DROP function, followed by the user pressing CANCEL (PF12 by default) to return to the option selection panel for the current CREATE or DROP function. The invalid value is unresolved and may cause problems if an attempt is made to executed the current CREATE or DROP function.

User response: In most cases the problem can be resolved by reselecting the previous option panel (where CANCEL was entered), and correcting the invalid values entered there. If this does not resolve the problem, return to the Db2® Object Functions panel and restart the operation.

FMNDB954

No suitable rows (short). The current table definition does not contain columns specified as not null. Use option 2 to define not null columns before defining :primary/unique keys. (long).

Explanation: This message is issued by the "Create Table" dialog (Db2® Object Functions). The user selected the "unique constraints" option after previously defining columns for the new table using option 1 (Columns). A column can only be included in a unique constraint key if it is defined as NOT NULL, and none of the columns currently defined for the new table meet this requirement.

User response: Select option 2 (Nulls/Default values) and set the Null status for each column as appropriate. You will need to specify either NN (NOT NULL) or ND (NOT NULL WITH DEFAULT) for at least one column to be able to specify a unique constraint for the new table.

FMNDB955

No suitable rows (short). The current table definition does not contain any non-ROWID, non-LOB columns specified as not null, nor any identity columns. Use option 2 to define not null columns, or option 8 to define identity columns before defining primary/unique keys. (long).

Explanation: This message is issued by the "Create Table" dialog (Db2® Object Functions). The user selected the "unique constraints" option after previously defining columns for the new table using option 1 (Columns). A column can only be included in a unique constraint key if it is defined as NOT NULL, and none of the columns currently defined for the new table meet this requirement. This message is issued when there are columns defined as ROWID, or CLOB/DBCLOB, BLOB.

User response: Select option 2 (Nulls/Default values), and set the Null status for each column as appropriate. You will need to specify either NN (NOT NULL) or ND (NOT NULL WITH DEFAULT) for at least one column to be able to specify a unique constraint for the new table. You can also define numeric columns as INDENTITY columns using option 8 (Generate values). An IDENTITY column can be included in a unique constraint.

FMNDB956

Too many selections (short). You have already selected *Max column count* columns for this key, which is the maximum allowed by Db2®. (long).

Explanation: This message is issued by the "Create Table" dialog (Db2® Object Functions), usually when defining columns to be included in the primary key, or other unique constraint defined for the table. *Max column count* is 64 for Db2® for z/OS® versions 8 - 10 inclusive.

User response: Reduce the number of columns in the primary key or unique constraint.

FMNDB957

Table/view not found (short). The model table/view was not found in the Db2® catalog. (long).

Explanation: This message is issued by the "Create Table" dialog (Db2® Object Functions), when a model table name is entered, but the Db2® object does not exist.

User response: Correct the Db2® object name, retry the operation. You can use the Object List utility (Option 3.4) to show all the Db2® objects (tables/views/aliases) defined at the local server.

FMNDB958

Too many constraints (short) Too many unique constraints have been found in model tables. Only the first three unique constraints found in the Db2® catalog have been loaded.

Explanation: This message is issued by the "Create Table" dialog (Db2® Object Functions), when a model table name is entered and a load of the information for the model table is requested. The "Create table" dialog supports a maximum of three unique constraints for any table being defined. This message might be issued for the load of a single Db2® object, with 4 or more unique constraints defined, or when multiple loads are requested.

User response: This is an informational message. In the unlikely event that 4 or more unique constraints need to be defined for the table being created, consider defining the table with 3 initial constraints, and using ALTER TABLE to add any additional constraints.

FMNDB959

Invalid option (short). Only column information can be loaded when the add option is selected and columns have already been defined or loaded. (long).

Explanation: This message is issued by the "Create Table" dialog (Db2® Object Functions), when a model table name is entered. The user loaded information for one model table, then attempted to add load additional information for another. For the second and subsequent loads, only the "Basic table information" and "Column information" options can be selected.

User response: You can only load "Primary key information", "Unique key information", "Referential constraints" and "Check constraint" information for the first model table specified. Deselect the option for all of the above and retry the operation. Alternatively set the Refresh or Add option to Refresh and repeat the operation. This will replace any existing information with that for the current model table.

FMNDB960

Too many constraints (short) Too many table foreign keys have been defined for this table. The number of table foreign keys is limited to the number of ISPF tables named FMN2CTnn that can be created.

Explanation: This message is issued by the "Create Table" dialog (Db2® Object Functions). An attempt was made to create more than 100 foreign keys for the current table. While there is no Db2® limit on the number of foreign keys, the "Create Table" dialog is limited to a maximum of 100 foreign keys.

User response: Review the number of foreign keys that have been specified, reduce the number to 100 or less.

FMNDB961

Order required (short) A referenced column name has been entered for this column, but no order. An order is required if the column is to be included in the foreign key.

Explanation: This message is issued on the "Create Table: Table Referential Constraint" panel. When creating a table referential constraint that includes more than one column (the usual usage is for a multiple-column foreign key definition), an order specification is required for every column that is part of the foreign key being defined.

User response: Specify an order for every column that is to be part of the foreign key.

FMNDB962

Ref. column required (short). If any of the foreign key columns reference a specific column in the parent table, then all of the foreign key columns must do so. (long).

Explanation: This message is issued on the "Create Table: Table Referential Constraint" panel. When creating a table referential constraint that includes more than one column (the usual usage is for a multiple-column foreign key definition), an order specification for a column was entered without a corresponding entry in the Parent Key column field.

User response: Specify a column name in the Parent Key column field, for every column that is to be part of the foreign key.

FMNDB963

No columns selected (short). No columns have been selected to define the foreign key for this constraint. (long).

Explanation: This message is issued when creating referential constraints for a table (Create Table dialog of Db2® Object functions). The user created a new constraint name and specified the parent table for the relationship. However no foreign key columns have been defined.

User response: Use the 's' command to select the new constraint entry. When the "Create Table: Table Referential Constraint" panel is displayed, select the columns that comprise the foreign key, and enter the names of the corresponding columns in the parent table.

FMNDB964

Some data not loaded (short). The Db2® catalog did not contain any information for the model table or view for at least one of the model load options specified. For example, check constraints were requested but the referenced model table has no check constraints. (long).

Explanation: This message is issued by the "Create Table" dialog (Db2® Object Functions), when a model table name is entered, and a load of existing Db2® object information is requested.

User response: No action required. Informational message.

FMNDB965

No suitable rows (short) The current table definition does not contain any short string columns specified as not null. Use option 2 to define not null columns before defining Procedure Exits.

Explanation: This message is issued by the "Create Table" dialog (Db2® Object Functions). The user selected option 7 (Procedure exits). However, there are no suitable columns defined on which a procedure exit can be defined. A procedure exit cannot be defined unless a suitable column is defined.

User response: Option 7 (Procedure exits) allows a FIELDPROC specification for suitable columns of the table. In general, only character (CHARACTER/GRAPHIC) columns of length <=255, defined as NOT NULL, or NOT NULL WITH DEFAULT, are suitable. Define a suitable column using options 1 (Columns) and 2 (Nulls/Default values) and then reselect option 7.

FMNDB966

External name required (short). Specify an external name for the *object type* using option *number* before using this option. This is required because the specified name exceeds eight characters. (long).

Explanation: This message is issued by the "Create Function" and "Create Stored Procedure" dialogs of the Db2® Object Functions. The length of the name for the function, or stored procedure, exceeds 8 characters. In this situation an external name for the function must also be specified. *object type* is either "function" or "stored procedure", depending on the Object function. *number* is 4 when creating a function, and 3 when creating a stored procedure.

User response: Select the specified option, and enter an external name for the function or stored procedure. Consult the Db2® for z/OS® SQL Reference for the appropriate version of Db2® for details of acceptable formats for the external name value.

FMNDB967

String too long (short). The string constant specified as a default value is too long for the associated string column. (long).

Explanation: This message is issued by the "Create Table" dialog (Db2® Object Functions) when specifying a default value for a character data type column. The default value is too long. For example, specifying a default value of 'ABCDE' (length 5) for a CHAR(3) (length 3) column.

User response: Compare the length of the default value string, and the maximum length for the column, as defined in the length field for the data type. Adjust either value as appropriate.

FMNDB968

Invalid data (short). The decimal number specified as a default value is invalid or out of range for the associated decimal number column. (long).

Explanation: This message is issued by the "Create Table" dialog (Db2® Object Functions) when specifying a default value for a DECIMAL data type column. The specified default value is invalid in the context of the precision and scale specified for the column.

User response: Compare the definition for the DECIMAL column with the implied precision, and scale from the default value. Adjust either the data type (precision and scale) in the column, or the default value.

FMNDB969

Invalid *DATE|TIME|TIMESTAMP* (short) The format of the *DATE|TIME|TIMESTAMP* field or the data it contains is invalid.

Explanation: This message is issued by the "Create Table" dialog (Db2® Object Functions) when specifying a default value for a DATE, TIME, or TIMESTAMP data type column. The specified default value is invalid.

User response: Examine the default value entered and the data type for the column. The two possible causes of this error are:

1. An invalid format. Example: '12/10/2001' is not a valid format for a TIME column.
2. An invalid value. Example: '32/11/2001' is an invalid date, since 32 is not a valid day (or month).

Consult the Db2® for z/OS® SQL Reference for the appropriate version of Db2® for a detailed description of valid DATE/TIME and TIMESTAMP constants, including supported formats.

FMNDB970

Date/time not validated (short). The default values for one or more date or time fields were not validated because the Db2® subsystem date/time format is LOCAL or unknown.

Explanation: This message is issued by the "Create Table" dialog (Db2® Object Functions) when specifying a default value for a DATE or TIME column. The Db2® default for either the DATE or TIME format is either LOCAL, or unknown. In either case, the panel logic cannot validate the specified default value.

User response: No action required. Informational message. If any default value entered is invalid, an SQL error will occur when the attempt is made to create the Db2® object.

FMNDB971

Date/time not validated (short) The specified default date or time value was not validated because the Db2® subsystem date/time format is LOCAL or unknown. (long).

Explanation: This message is issued by the "Create Table" dialog (Db2® Object Functions) when specifying a default value for a DATE, TIME, or TIMESTAMP column. This message is issued on pop-up panel "Create Table: Default Value". The Db2® default for either the DATE or TIME format is either LOCAL, or unknown. In either case, the panel logic cannot validate the specified default value.

User response: No action required. Informational message. If any default value entered is invalid an SQL error will occur when the attempt is made to create the Db2® object.

FMNDB972

Invalid data (short). The floating point number specified as a default value is invalid or outside the range supported by Db2®. (long).

Explanation: This message is issued by the "Create Table" dialog (Db2® Object Functions) when specifying a default value for a binary floating point column (REAL, FLOAT, DOUBLE). The specified default value is outside the range supported by Db2®.

User response: The limits for floating point constants are documented in "Limits in Db2® for z/OS®", in the Db2® for z/OS® SQL Reference manual, for the appropriate version of Db2®. Compare the specified default value against the documented values, and adjust as appropriate.

FMNDB973

GENERATED ALWAYS added (short). The GENERATED ALWAYS clause has been added to the definition of the column with a data type of ROWID. To change the GENERATED clause select option 8. (long).

Explanation: This message is issued by the "Create Table" dialog (Db2® Object Functions), when adding a column definition for a ROWID column.

User response: No action required. Informational message. In most cases it should not be necessary to modify the GENERATED clause for a ROWID column. Option 8 (Generated Values) allows the GENERATED clause to be modified.

FMNDB974

Invalid database name (short). You cannot specify the name of an implicitly created database when creating a table. Implicitly created database names have the form DSNxxxxx, where xxxxx is any 5 numeric digits. (long)

Explanation: This message is issued by the "Create Table" dialog (Db2® Object Functions) when attempting to create a table. The database name specified is invalid because it has the form 'DSNxxxxx', where xxxxx is 00000-99999 inclusive. Names of this form are reserved for use by Db2®, as implicitly created database names. The table cannot be created.

User response: Specify a different Db2® database name, or remove the database name completely if an implicitly required database is acceptable.

FMNDB980

Invalid value (A/D) (short). The valid values for the A/D field are A, for ascending; D, for descending, or blank. (long).

Explanation: This message is issued on the "Column Selection/Edit" panel, when a value other than 'A' or 'D' is entered in the "A/D" column.

User response: The "A/D" column in the "Column Selection/Edit" panel is used to specify the sort order for columns included in the ORDER BY clause. The valid values are 'A' for ascending (the default) or 'D' for descending. Specify one of these values, or leave the field blank for the default behaviour.

FMNDB981

Enter sort order (short). A sort order is required when a sort column is specified (A or D in the A/D field). Enter a number in the range 1..999. (long).

Explanation: The 'Order' column in the "Column Selection/Edit" panel is used to specify the sort sequence for columns included in the ORDER BY clause. The user specified either 'A' or 'D' in the "A/D" column, but no value in the 'Order' column.

User response: Enter a number in the 'Order' column for every column that also has a non-blank value in the "A/D" column.

FMNDB990

Mutually exclusive value (short). Specify a JOBNAME value, or an ADDRESS value, but not both. (long).

Explanation: This message is issued by the "Create Trusted Context" dialog (Db2® Object Functions). A value was entered for both the JOBNAME and ADDRESS fields, however only one value is acceptable.

User response: Specify either a JOBNAME value; or an ADDRESS value, but not both. The syntax for the CREATE TRUSTED CONTEXT SQL statement can be found in the Db2® for z/OS® SQL Reference manual for the appropriate version of Db2®.

FMNDB991

Value required (short). Either a JOBNAME value or an ADDRESS value is required. (long).

Explanation: This message is issued by the "Create Trusted Context" dialog (Db2® Object Functions). No value was entered in either the JOBNAME or ADDRESS fields; a value is required for one.

User response: Specify either a JOBNAME value; or an ADDRESS value, but not both. The syntax for the CREATE TRUSTED CONTEXT SQL statement can be found in the Db2® for z/OS® SQL Reference manual for the appropriate version of Db2®.

FMNDB992

Value not required (short). Do not specify a "Default Role Name" value when the "No Default Role" option is selected. (long).

Explanation: This message is issued by the "Create Trusted Context" dialog (Db2® Object Functions). The user selected the "No default role" option, and also entered a value in the "Default role name" field. The two selections are mutually exclusive.

User response: If a default role name is to be specified, deselect the "No default role" option. If there is to be no default role name, remove the "Default role name".

FMNDB993

Value not required (short). Do not specify a "Security Label Name" value when the "No Default Security Label" option is selected. (long).

Explanation: This message is issued by the "Create Trusted Context" dialog (Db2® Object Functions). The user selected the "No default security label" option, and also entered a value in the "Security label name" field. The two selections are mutually exclusive.

User response: If a default security label name is to be specified, deselect the "No default security label" option. If there is to be no default security label, remove the "Security label name".

FMNDB994

Value not required (short). Do not select the "Without authentication" option when the "PUBLIC" option" is selected. (long).

Explanation: This message is issued by the "Create Trusted Context" dialog (Db2® Object Functions). The user did not select the "PUBLIC" use option, and selected the "Without authentication" option. The second selection requires that the first option also be selected.

User response: The valid choices for the two options ("PUBLIC" and "Without authentication") are: 1) Both options not selected. 2) Both options selected. 3) Only the first option selected.

FMNDC014

Rows rows exported (short). Rows row(s) exported from SELECT statement (user-specified) to *file data set name*. (long).

Explanation: This is a message insert used by the FM/Db2 Export function. It shows the number of rows rows exported by the export function. The target data set is *data set name*. This message is specific to the export of data from a user-specified SELECT statement initially entered using FM/Db2 options 4.1-4.4.

User response: No action required. Informational message.

FMNDC015

Rows rows+hdr expd (short). Rows row(s) and column header row exported from SELECT statement (user-specified) to *file data set name*. (long).

Explanation: This is a message insert used by the FM/Db2 Export function. It shows the number of rows rows exported by the export function. The target data set is *data set name*. This message is specific to the export of data in CSV format, with column header data, from a user-specified SELECT statement initially entered using FM/Db2 options 4.1-4.4.

User response: No action required. Informational message.

FMNDC019

Not in large mode (short). The export command with the ALL|X|EX|INX parameter is not available in large editor mode (row count = 0). (long).

Explanation: The editor EXPORT command with the ALL|X|EX|INX parameter specified was issued from a File Manager/Db2 editor session, in large mode (row count = 0, also ALL, *). This is not supported and the command cannot be processed.

User response: Use normal editor mode and re-try the operation.

FMNDC020

count row(s) exported from Db2® object *source Db2 object* to file *file name*. The open returned SQLCODE *sqlcode*. *trunc_count* rows had fetch SQLCODE +445 (truncation) warnings. *warn_count* other rows had fetch warnings (SQLCODE>0, but not +445).

Explanation: This message is issued at the end of a File Manager/Db2 export function, when at least one positive SQLCODE was received retrieving data from Db2®. The number of rows exported, *count*; the Db2® object from which the rows were exported, *source Db2 object*; the output file name that contains the exported data, *file name*; the SQLCODE for the OPEN cursor, *sqlcode*; the number of rows fetched that had SQLCODE+445 warnings, *trunc_count* and the number of rows fetched that gave positive SQLCODEs (but not +445), *warn_count* are shown. SQLCODE+445 is a warning condition issued when data truncation occurs.

User response: For SQLCODE+445 warnings, examine the exported data to see if the data truncation has resulted in any unexpected consequences. Take action as appropriate. For other warning SQLCODEs: If the export operation was run on-line, repeat the operation using the batch execution option. Run the resulting job and examine the messages produced. Look up the SQLCODEs reported in the Db2® for z/OS® SQL Codes manual, for the appropriate version of Db2®. Take action as appropriate.

FMNDC021

Row count row(s) and column header row exported from Db2® object *object name* to file *data set name*. The open returned SQLCODE *sqlcode*. *trunc_count* rows had fetch SQLCODE +445 (truncation) warnings. *warn_count* other rows had fetch warnings (SQLCODE>0, but not +445).

Explanation: This message is issued by the FM/Db2 export function, when at least one positive SQLCODE was received retrieving data from Db2® and is specific for an export with CSV format and the "Include column headers" option selected. The number of rows exported, *count*; the Db2® object from which the rows were exported, *source Db2 object*; the output file name that contains the exported data, *file name*; the SQLCODE for the OPEN cursor, *sqlcode*; the number of rows fetched that had SQLCODE+445 warnings, *trunc_count* and the number of rows fetched that gave positive SQLCODEs (but not +445), *warn_count* are shown. SQLCODE+445 is a warning condition issued when data truncation occurs.

User response: For SQLCODE+445 warnings, examine the exported data to see if the data truncation has resulted in any unexpected consequences. Take action as appropriate. For other warning SQLCODEs: If the export operation was run on-line, repeat the operation using the batch execution option. Run the resulting job and examine the messages produced. Look up the SQLCODEs reported in the Db2® for z/OS® SQL Codes manual, for the appropriate version of Db2®. Take action as appropriate.

FMNDC022

Rows row(s) exported from SELECT statement (user-specified) to file *data set name*. The open returned SQLCODE *sqlcode*. *trunc_count* rows had fetch SQLCODE +445 (truncation) warnings. *warn_count* other rows had fetch warnings (SQLCODE>0, but not +445).

Explanation: This message is issued by the FM/Db2 Export function when at least one positive SQLCODE was received retrieving data from Db2®. It shows the number of rows *rows* exported by the export function; the target data set is *data set name*; the SQLCODE for the OPEN cursor is *sqlcode*; the number of rows fetched that had SQLCODE+445 warnings is *trunc_count* and the number of rows fetched that gave positive SQLCODEs (but not +445) is *warn_count*. SQLCODE+445 is a warning condition issued when data truncation occurs. This message is specific to the export of data from a user-specified SELECT statement initially entered using FM/Db2 options 4.1-4.4.

User response: For SQLCODE+445 warnings, examine the exported data to see if the data truncation has resulted in any unexpected consequences. Take action as appropriate. For other warning SQLCODEs: If the export operation was run on-line, repeat the operation using the batch execution option. Run the resulting job and examine the messages produced. Look up the SQLCODEs reported in the Db2® for z/OS® SQL Codes manual, for the appropriate version of Db2®. Take action as appropriate.

FMNDC023

Rows row(s) and column header row exported from SELECT statement (user-specified) to file *data set name*. The open returned SQLCODE *sqlcode*. *trunc_count* rows had fetch SQLCODE +445 (truncation) warnings. *warn_count* other rows had fetch warnings (SQLCODE>0, but not +445).

Explanation: This message is issued by the FM/Db2 Export function when at least one positive SQLCODE was received retrieving data from Db2®. It shows the number of rows *rows* exported by the export function; the target data set is *data set name*; the SQLCODE for the OPEN cursor is *sqlcode*; the number of rows fetched that had SQLCODE+445 warnings is *trunc_count* and the number of rows fetched that gave positive SQLCODEs (but not +445) is *warn_count*. SQLCODE+445 is a warning condition issued when data truncation occurs. This message is specific to the export of data in CSV format, with column header data, from a user-specified SELECT statement initially entered using FM/Db2 options 4.1-4.4.

User response: For SQLCODE+445 warnings, examine the exported data to see if the data truncation has resulted in any unexpected consequences. Take action as appropriate. For other warning SQLCODEs: If the export operation was run on-line, repeat the operation using the batch execution option. Run the resulting job and examine the messages produced. Look up the SQLCODEs reported in the Db2® for z/OS® SQL Codes manual, for the appropriate version of Db2®. Take action as appropriate.

FMNDC026

Open cursor SQLCODE=*sqlcode*.

Explanation: This message is issued by the FM/Db2 export function, when executed in batch mode, when a positive SQLCODE is received from Db2® when the cursor is opened.

User response: Look up the SQLCODE reported in the Db2® for z/OS® SQL Codes manual, for the appropriate version of Db2®. Take action as appropriate.

FMNDC027

Fetch SQLCODE=*sqlcode* for row *row* (data truncation).

Explanation: This message is issued by the FM/Db2 export function, when executed in batch mode, whenever an SQLCODE +445 is received when fetching a row of data from Db2®. SQLCODE+445 indicates that data truncation occurred.

User response: Examine the exported data to see if the data truncation has resulted in any unexpected consequences. Take action as appropriate.

FMNDC028

Fetch SQLCODE=*sqlcode* for row *row* (warning).

Explanation: This message is issued by the FM/Db2 export function, when executed in batch mode, whenever a positive SQLCODE other than +445 is received when fetching a row of data from Db2®.

User response: Look up the SQLCODE reported in the Db2® for z/OS® SQL Codes manual, for the appropriate version of Db2®. Take action as appropriate.

FMNDC030

Processing Db2® object name for DELETE.

Explanation: This informational message is issued at the start of a BATSQSQL function. FM/Db2 is processing object name, for delete processing.

User response: No action is required.

FMNDC031

Inserting rows into Db2® object name.

Explanation: This informational message is issued at the start of a BATSQSQL function. FM/Db2 is processing object name, for insert processing.

User response: No action is required.

FMNDC032

Processing Db2® object name for UPDATE.

Explanation: This informational message is issued at the start of a BATSQSQL function. FM/Db2 is processing object name, for update processing.

User response: No action is required.

FMNDC033

Row count rows deleted.

Explanation: This informational message is issued at the end of a BATSQSQL function. FM/Db2 successfully deleted row count rows from the object.

User response: No action is required.

FMNDC034

Row count rows inserted.

Explanation: This informational message is issued at the end of a BATSQSQL function. FM/Db2 successfully inserted row count rows into the target object.

User response: No action is required.

FMNDC035

Row count rows updated.

Explanation: This informational message is issued at the end of a BATSQSQL function. FM/Db2 successfully updated row count rows from the object.

User response: No action is required.

FMNDC036

Batch DELETE canceled because of excessive errors (*errcnt,maxerr*).

Explanation: This informational message is issued during TYPE=DELETE BATSQ processing. FM/Db2 stopped deleting rows because the user-specified error limit *maxerr* (MAXERRORS keyword) was reached. The actual number of errors was *errcnt*. A summary of the errors that are encountered follows (messages FMNDC039 and FMNDC060). Note that when an error is encountered processing a rowset, the error count is incremented by the number of rows in the rowset. This can result in the actual number of errors reported exceeding the value specified for MAXERRORS.

User response: Examine the error summary and respond.

FMNDC037

Batch INSERT canceled because of excessive errors (*errcnt,maxerr*).

Explanation: This informational message is issued during TYPE=INSERT BATSQ processing. FM/Db2 stopped inserting rows because the user-specified error limit *maxerr* (MAXERRORS keyword) was reached. The actual number of errors was *errcnt*. A summary of the errors that are encountered follows (messages FMNDC039 and FMNDC060).

User response: Examine the error summary and respond.

FMNDC038

Batch UPDATE canceled because of excessive errors (*errcnt,maxerr*).

Explanation: This informational message is issued at the end of a BATSQ function. FM/Db2 stopped updating rows because the user-specified error limit (MAXERRORS keyword) was reached. A summary of the errors that are encountered follows (message FMNDC039). Note that when an error is encountered processing a rowset, the error count is incremented by the number of rows in the rowset. This can result in the actual number of errors reported exceeding the value specified for MAXERRORS.

User response: Examine the error summary and respond.

FMNDC039

Error count rows gave SQLCODE sqlcode.

Explanation: This informational message is issued at the end of a BATSQ function. During the function, the delete/insert or update operation resulted in error count SQLCODE sqlcode errors. If there were different SQLCODEs received (for example SQLCODE-803, SQLCODE-545) there is one occurrence of this message for each different SQLCODE.

User response: Examine the error summary and respond.

FMNDC040

Row count pending deletes rolled back.

Explanation: This informational message is issued at the end of a BATSQ function. FM/Db2 stopped deleting rows because the user-specified error limit (MAXERRORS keyword) was reached. Row count rows were deleted after the last commit point. The changes to these rows were backed out as a result of the Db2@ rollback.

User response: No action is required.

FMNDC041

Row count pending inserts rolled back.

Explanation: This informational message is issued at the end of a BATSQl function. FM/Db2 stopped inserting rows because the user-specified error limit (MAXERRORS keyword) was reached. Row count rows were inserted after the last commit point. The changes to these rows were backed out as a result of the Db2® rollback.

User response: No action is required.

FMNDC042

Row count pending updates rolled back.

Explanation: This informational message is issued at the end of a BATSQl function. FM/Db2 stopped updating rows because the user-specified error limit (MAXERRORS keyword) was reached. Row count rows were updated after the last commit point. The changes to these rows were backed out as a result of the Db2® rollback.

User response: No action is required.

FMNDC043

Row count commit(s) issued prior to completion.

Explanation: This informational message is issued at the end of a BATSQl function. The AUTOCOMMIT keyword specified a nonzero value. FM/Db2 issued one or more commits as rows were processed. Row count does not include the final commit or rollback issued when the function ends.

User response: No action is required.

FMNDC044

Required SET clause missing.

Explanation: This error message is issued during processing of a BATSQl function. An update operation was requested, but no SET clause was found.

User response: Ensure that a SET clause is specified, rerun the function.

FMNDC045

SET clause must begin with 'SET'

Explanation: This error message is issued during processing of a BATSQl function. An update operation was requested, however the SET clause does not commence with 'SET'.

User response: The SET clause must be a valid SET clause for an update statement, see the Db2® SQL Reference manual for a full description. Ensure that the SET clause begins with 'SET', rerun the function.

FMNDC046

SET clause incomplete, it must contain an assignment for >= 1 column(s).

Explanation: This error message is issued during processing of a BATSQl function. An update operation was requested, however the SET clause does not include an assignment for at least 1 column.

User response: The SET clause must include an assignment for at least one column, for example: "SET COL1=value". See the Db2® SQL Reference manual for a full description. Correct the SET clause, rerun the function.

FMNDC047

WHERE clause must begin with 'WHERE'.

Explanation: This error message is issued during processing of a BATSQl function. An update or delete operation was requested, however the WHERE clause does not commence with 'WHERE'.

User response: The WHERE clause must be a valid WHERE clause for an update or delete statement, see the Db2® SQL Reference manual for a full description. Ensure that the WHERE clause begins with 'WHERE', rerun the function.

FMNDC048

Isolation UR incompatible with delete or update, CS substituted.

Explanation: This informational message is issued at the start of a BATSQl function. The control statements include ISOLATION=UR for either a delete or update function. Uncommitted read is not supported when a positioned delete or update statement is issued. This method is the method that is used by the BATSQl function for deleting or updating rows. The isolation value was to CS (Cursor stability).

User response: Review the value that is specified for the ISOLATION keyword. Consider changing the value to 'NONE' or 'CS'.

FMNDC049

DELETEALL=YES must be specified for a delete without a WHERE clause.

Explanation: This error message is issued during processing of a delete BATSQl function. For a delete function, the omission of a where clause results in the attempted deletion of all rows of the table. As a safety feature, DELETEALL=YES must also be included in the control statements.

User response: Review the intended action of the BATSQl function. If the intention is to delete every row in the table, add the DELETEALL=YES statement and rerun the function.

FMNDC050

Insert column list must be enclosed in (). Eg (Col1, Col2).

Explanation: This error message is issued during processing of an insert BATSQl function. An invalid insert column clause was detected.

User response: The insert column clause must include a list of comma-separated column names. The entire list requires enclosing parentheses. See the Db2® SQL Reference manual for a full description. Correct the insert column clause, rerun the function.

FMNDC051

Insert column list incomplete, it must contain >=1 column(s).

Explanation: This error message is issued during processing of an insert BATSQl function. An invalid insert column clause was detected.

User response: The insert column clause must contain at least one column name. Further, that column name must be a column of the target table. See the Db2® SQL Reference manual for a full description. Correct the insert column clause, rerun the function.

FMNDC052

Single row processing active.

Explanation: This informational message is issued at the start of a BATSQSQL function. Single-row processing is active, that is, FM/Db2 fetches rows one-at-a-time from the source table.

User response: No action is required.

FMNDC053

Rowset processing (*nnn* rows) active.

Explanation: This informational message is issued at the start of a BATSQSQL function. Rowset processing is active, that is, FM/Db2 fetches *nnn* rows at a time.

User response: No action is required.

FMNDC054

Required SELECT clause is missing or incomplete.

Explanation: This is an error message issued during processing of the BATSQSQL function. The specified SELECT clause has either not been specified, or is incomplete.

User response: Correct the coding of the SELECT clause. The SELECT clause should start with 'SELECT' and identify a result table. The shortest valid SELECT clause is 'SELECT * FROM <name>', where <name> is an unqualified Db2® object name. Retry the BATSQSQL function.

FMNDC055

SELECT clause must begin with 'SELECT'.

Explanation: This is an error message issued during processing of the BATSQSQL function. The specified SELECT clause does not start with 'SELECT'.

User response: Correct the coding of the SELECT clause. Retry the BATSQSQL function.

FMNDC056

SELECT clause is invalid, SQLCODE=SQLCODE.

Explanation: This is an error message issued during processing of the BATSQSQL function. The specified SELECT clause is invalid, Db2® returned SQLCODE=SQLCODE in response to an attempt to prepare the statement.

User response: Look up the SQLCODE in the Db2® Codes manual for the appropriate version of Db2® and use the information provided to correct the SELECT statement. Retry the BATSQSQL function.

FMNDC057

Column COLNAME is not a column of OBJNAME.

Explanation: This is an error message issued during processing of the BATSQL function. The specified column name COLNAME does not exist in Db2® object OBJNAME.

User response: Determine the reason why the specified column name is not a column of the named Db2® object. A non-exhaustive list of causes is:

1. Spelling errors
2. Upper/lower case issues
3. References to an incorrect Db2® object name
4. Referring to a Db2® object name on a different Db2® sub-system to the intended system.

Correct the input statements and retry the BATSQL function.

FMNDC058

The requested function is not supported: XML columns.

Explanation: This is an error message issued during processing of an INSERT BATSQL function. XML columns were detected in either the target Db2® object, or in the source SELECT statement. The BATSQL function with TYPE=INSERT does not support XML columns. The function cannot be performed.

User response: None, the requested operation cannot be performed.

FMNDC059

Switching to single-row processing because of multi-row errors.

Explanation: This is an error message issued during processing of a DELETE or UPDATE BATSQL function. Rowset processing is active, however an SQL error was encountered when attempting a delete/update of a rowset. All rows in the current rowset are unchanged, FM/Db2 marks all rows in the rowset as 'in error'. FM/Db2 moves to the next rowset and attempts to process each row in that rowset individually.

User response: Examine the output object to determine why an SQL error occurred. Take appropriate action.

FMNDC060

1 rowset gave SQLCODE *sqlcode*.

Explanation: This message is issued during processing of a DELETE or UPDATE BATSQL function when rowset processing is active. An SQL error occurred when attempting a rowset delete or update, the failing SQLCODE is *sqlcode*. All rows in the current rowset are unchanged, FM/Db2 marks all rows in the rowset as 'in error'.

User response: Examine the output object to determine why an SQL error occurred. Take appropriate action.

FMNDC062

Invalid SET clause.

Explanation: This message is issued during processing of an UPDATE BATSQL function. The SET clause is invalid. This message is specific to the following form of a SET clause:

```
SET (Col1 , ...) = (Val1, ...)
```

See the SQL Reference for the appropriate version of Db2® for a full description of the SET clause syntax. This error is usually the result of:

- A missing parenthesis around either the column, or value list.
- A missing '=' between the column and value lists.
- The column list has no columns.
- The value list has no values.

User response: Examine the SET clause, correct the syntax error(s), retry the function.

FMNDC170

Changes discarded (short). The invalid change to the data format option has been discarded. Enter one of the following values: 1, 2, 3, 4. (long).

Explanation: The user made an invalid change to the "Data format" value on the Import options panel, and then pressed the PFKey assigned to END (or typed END). The invalid value is discarded and the import options panel is redisplayed.

User response: No action required. Informational message. After making changes to the options, press ENTER to validate the changes before attempting to exit the panel.

FMNDC171

Changes discarded (short). The invalid change to the duplicate key processing option has been discarded. Enter one of the following values: 1, 2. (long).

Explanation: The user made an invalid change to the "Duplicate key processing" value on the Import options panel, and then pressed the PFKey assigned to END (or typed END). The invalid value is discarded and the import options panel is redisplayed.

User response: No action required. Informational message. After making changes to the options, press ENTER to validate the changes before attempting to exit the panel.

FMNDC172

Changes discarded (short). The invalid change to the maximum duplicates option has been discarded. Enter one of the following values: *, ALL, or a number in the range 0-2147483647 inclusive. (long).

Explanation: The user made an invalid change to the "Max duplicates" value on the Import options panel, and then pressed the PFKey assigned to END (or typed END). The invalid value is discarded and the import options panel is redisplayed.

User response: No action required. Informational message. After making changes to the options, press ENTER to validate the changes before attempting to exit the panel.

FMNDC174

Changes discarded (short). The invalid change to the auto-commit count option has been discarded. Enter a number in the range 0-2147483647 inclusive. (long).

Explanation: The user made an invalid change to the "Auto commit count" value on the Import options panel, and then pressed the PFKey assigned to END (or typed END). The invalid value is discarded and the import options panel is redisplayed.

User response: No action required. Informational message. After making changes to the options, press ENTER to validate the changes before attempting to exit the panel.

FMNDC180

Enter a value (short). A value is required. Enter a frequency between 0 and 1 exclusive. As an example 0.1 will sample approximately 10% of rows. (long).

Explanation: The user selected "random sampling" on the FM/Db2 Editor options panel, but did not enter a value for "sampling frequency". A sampling frequency is required when using random sampling.

User response: Enter a decimal value between 0.0 and 1.0. As an example, enter 0.1 will result in approximately 10% of the rows in the object being sampled. These rows will appear in the FM/Db2 editor session. Higher values will result in more rows being sampled; lower values will result in less rows being sampled.

FMNDC181

Invalid value (short). Valid frequencies are 0.000000001 - 0.999999999 inclusive. Enter a value within these limits. (long).

Explanation: The user selected "random sampling" on the FM/Db2 Editor options panel, but did not enter a valid value for "sampling frequency". A valid sampling frequency is a decimal number between 0.0 and 1.0; with 9 digits of precision after the decimal point.

User response: Enter a decimal value between 0.0 and 1.0. As an example, enter 0.1 will result in approximately 10% of the rows in the object being sampled. These rows will appear in the FM/Db2 editor session. Higher values will result in more rows being sampled; lower values will result in less rows being sampled.

FMNDC182

Enter a number (short). Enter a number (seed) to start the generation of pseudo-random numbers, or 0 to use a seed derived from the system clock. Valid values are 0-2147483647 inclusive. (long).

Explanation: The user selected "random sampling" on the FM/Db2 Editor options panel, but did not enter a valid value for "sampling seed". The seed value is used to initiate the pseudo-random number generator.

User response: Enter an integer between 0-2147483647 inclusive. A value of 0 sets the seed to a value based on the current value of the system clock on the computer, accurate to the microsecond, and is therefore a random value for most purposes. Any other value will result in repeatable behaviour, in terms of the rows sampled, for a given Db2® object and the same sampling frequency.

FMNDC183

Changes discarded (short). The invalid change to the Initial skip count has been discarded. The Initial skip count value must be in the range 0-999999999. (long).

Explanation: The user made an invalid change to the "Initial skip count" value on an Editor options panel, and then pressed the PFKey assigned to END (or typed END). The invalid value is discarded and the editor options panel is redisplayed.

User response: No action required. Informational message. After making changes to the options, press ENTER to validate the changes before attempting to exit the panel.

FMNDC184

Changes discarded (short). The invalid change to the Include count has been discarded. The Include count value must be in the range 1-999999999. (long).

Explanation: The user made an invalid change to the "Include count" value on an Editor options panel, and then pressed the PFKey assigned to END (or typed END). The invalid value is discarded and the editor options panel is redisplayed.

User response: No action required. Informational message. After making changes to the options, press ENTER to validate the changes before attempting to exit the panel.

FMNDC185

Changes discarded (short). The invalid change to the Skip count has been discarded. The Skip count value must be in the range 0-999999999. (long).

Explanation: The user made an invalid change to the "Skip count" value on an Editor options panel, and then pressed the PFKey assigned to END (or typed END). The invalid value is discarded and the editor options panel is redisplayed.

User response: No action required. Informational message. After making changes to the options, press ENTER to validate the changes before attempting to exit the panel.

FMNDC186

Changes discarded (short). The invalid change to the Sampling limit has been discarded. The Sampling limit value must be in the range 0-999999999. (long).

Explanation: The user made an invalid change to the "Sampling limit" value on an Editor options panel, and then pressed the PFKey assigned to END (or typed END). The invalid value is discarded and the editor options panel is redisplayed.

User response: No action required. Informational message. After making changes to the options, press ENTER to validate the changes before attempting to exit the panel.

FMNDC187

Changes discarded (short). The invalid change to the Sampling frequency has been discarded. The Sampling frequency value must be in the range 0.000000001 - 0.999999999. (long).

Explanation: The user made an invalid change to the "Sampling frequency" value on an Editor options panel, and then pressed the PFKey assigned to END (or typed END). The invalid value is discarded and the editor options panel is redisplayed.

User response: No action required. Informational message. After making changes to the options, press ENTER to validate the changes before attempting to exit the panel.

FMNDC188

Changes discarded (short). The invalid change to the Sampling seed has been discarded. The Sampling seed value must be in the range 0-2147483647. (long).

Explanation: The user made an invalid change to the "Sampling seed" value on an Editor options panel, and then pressed the PFKey assigned to END (or typed END). The invalid value is discarded and the editor options panel is redisplayed.

User response: No action required. Informational message. After making changes to the options, press ENTER to validate the changes before attempting to exit the panel.

FMNDC189

Changes discarded (short). The invalid change to the Change count before auto commit has been discarded. The Change count before auto commit value must be in the range 0-2147483647. (long).

Explanation: The user made an invalid change to the "Change count before auto commit" value on an Editor options panel, and then pressed the PFKey assigned to END (or typed END). The invalid value is discarded and the editor options panel is redisplayed.

User response: No action required. Informational message. After making changes to the options, press ENTER to validate the changes before attempting to exit the panel.

FMNDC190

Changes discarded (short). The invalid change to the Prefix Length option has been discarded. (long).

Explanation: The user made an invalid change to the "Prefix length" value on an Editor options panel, and then pressed the PFKey assigned to END (or typed END). The invalid value is discarded and the editor options panel is redisplayed.

User response: No action required. Informational message. After making changes to the options, press ENTER to validate the changes before attempting to exit the panel.

FMNDC191

Changes discarded (short). The invalid change to the input/display characters has been discarded. The input/display delimiter characters must be non-blank and unique. (long).

Explanation: The user made an invalid change to the String delimiter and/or Null column indicator input/display characters on an Editor options panel, and then pressed the PFKey assigned to END (or typed END). The invalid value is discarded and the editor options panel is redisplayed.

User response: No action required. Informational message. After making changes to the options, press ENTER to validate the changes before attempting to exit the panel.

FMNDC192

Changes discarded (short). The invalid change to the Edit locking option has been discarded. Enter one of the listed values for the Edit locking option. (long).

Explanation: The user made an invalid change to the "Edit locking" value on an Editor options panel, and then pressed the PFKey assigned to END (or typed END). The invalid value is discarded and the editor options panel is redisplayed.

User response: No action required. Informational message. After making changes to the options, press ENTER to validate the changes before attempting to exit the panel.

FMNDC193

Changes discarded (short). The invalid change to the "Optimization for" value has been discarded. Enter a number in the range 0-999999 inclusive. Use 0 if no optimization clause is required. (long).

Explanation: The user made an invalid change to the "Optimization for" value on an Editor options panel, and then pressed the PFKey assigned to END (or typed END). The invalid value is discarded and the editor options panel is redisplayed.

User response: No action required. Informational message. After making changes to the options, press ENTER to validate the changes before attempting to exit the panel.

FMNDC194

Changes discarded (short). The invalid change to the Keep locks option has been discarded. Enter one of the listed values for the Keep locks option. (long).

Explanation: The user made an invalid change to the "Keep locks" value on an Editor options panel, and then pressed the PFKey assigned to END (or typed END). The invalid value is discarded and the editor options panel is redisplayed.

User response: No action required. Informational message. After making changes to the options, press ENTER to validate the changes before attempting to exit the panel.

FMNDC195

Changes discarded (short). The invalid change to the Scrollable cursor type option has been discarded. Enter one of the listed values for the Scrollable cursor type option. (long).

Explanation: The user made an invalid change to the "Scrollable cursor type" value on an Editor options panel, and then pressed the PFKey assigned to END (or typed END). The invalid value is discarded and the editor option's panel is redisplayed.

User response: No action required. Informational message. After making changes to the options, press ENTER to validate the changes before attempting to exit the panel.

FMNDC196

Changes discarded (short). The invalid change to the Data sampling type option has been discarded. Enter one of the listed values for the Data sampling type option. (long).

Explanation: The user made an invalid change to the "Data sampling type" value on an Editor options panel, and then pressed the PFKey assigned to END (or typed END). The invalid value is discarded and the editor options panel is redisplayed.

User response: No action required. Informational message. After making changes to the options, press ENTER to validate the changes before attempting to exit the panel.

FMNDC197

Enter a positive number (short). A positive number is required for this option when clustered sampling is selected. Enter a number in the range 1-999999999 inclusive. (long).

Explanation: The user selected "clustered sampling" on a File Manager/Db2 Editor options panel, but entered an invalid value for one of the "Include count" field. A positive integer value in the indicated range is required.

User response: Enter a positive integer value in the range 1-999999999 inclusive.

FMNDC198

Invalid value or number (short). A number is required for this option. Valid values are *range* inclusive. (long).

Explanation: The user selected "cluster sampling", or "random sampling" on a File Manager/Db2 Editor options panel, but entered an invalid value in one of the other sampling fields. Valid values for the indicated field are shown in the message *range*.

User response: Enter a value in the range shown in the long message. To access the long message, press the PFKey assigned to HELP (typically PF1), or type HELP on the command line, followed by ENTER.

FMNDC199

Enter a number (short). A number is required for the optimization clause. Valid values are 0-999999 inclusive. Use 0 if no optimization clause is required. (long).

Explanation: The user cleared the "Optimize for" value on a File Manager/Db2 Editor options panel (and pressed ENTER). A value is required for this field.

User response: Enter a value in the range 0-999999 inclusive. Specifying 0 results in no "OPTIMIZE FOR nn ROWS" clause being added to the SELECT statement used to fetch the data for the current editor session. In some situations specifying a small value (eg 1) may change the access path used by Db2® when retrieving the data, thereby improving the response time. See the Db2® SQL Reference manual for a more complete explanation.

FMNDC200

Invalid label range (short). The label range entered is invalid. Press help for more information. (long)

Explanation: The user entered the EXPORT editor primary command, with labels. The labels specified are invalid. The export command cannot be performed.

User response: Check the labels specified carefully. One common cause of this error is specifying a label that does not exist. You can press the PFKey assigned to HELP (PF1 by default) to display additional help for this error.

FMNDC201

NX|X|EX invalid (short). The NX|X|EX parameters cannot be specified when in SNGL mode. Press help for more information. (long).

Explanation: The user entered the EXPORT editor primary command, in SNGL mode, with the NX, X or EX option. The excluded or not-excluded row options are not applicable in SNGL mode. The export command cannot be performed.

User response: Change the display mode to TABL and re-issue the command. Alternatively, remove the excluded or not-excluded option and re-issue the command. You can press the PFKey assigned to HELP (PF1 by default) to display additional help for this error.

FMNDC202

Not in zoom mode (short). The export primary command is invalid in Zoom mode. (long).

Explanation: The user entered the EXPORT editor primary command, in ZOOM mode, which is not supported. The export command cannot be performed.

User response: Return to either TABL or SNGL display modes and re-issue the command. You can press the PFKey assigned to HELP (PF1 by default) to display additional help for this error.

FMNDC203

No labels (short). Labels cannot be specified when in SNGL mode. Press help for more information. (long).

Explanation: The user entered the EXPORT editor primary command, in SNGL mode, with a label range. Labels may only be specified for the EXPORT command in TABL display mode. The export command cannot be performed.

User response: Return to TABL display mode and re-issue the command. You can press the PFKey assigned to HELP (PF1 by default) to display additional help for this error.

FMNDC204

ALL|NX|EX missing (short). Labels cannot be specified unless ALL|NX|EX is also specified. Press help for more information. (long).

Explanation: The user entered the EXPORT editor primary command, with a label range, but without either the ALL or NX|EX parameters. When you specify a label range one of the ALL, NX|EX options is required. The export command cannot be performed.

User response: Press the PFKey assigned to HELP (PF1 by default) and review the following topics: "Syntax diagram". ALL|NX|EX parameter Modify the command to meet the requirements of the syntax diagram, and the intended usage of the EXPORT command, re-issue the command.

FMNDC206

Export failed (short). The export operation failed. (long).

Explanation: The user issued the EXPORT editor primary command in a File Manager/Db2 editor session. The command failed.

User response: Check the output data set for allocation/space and related errors.

FMNDC207

LRECL mismatch (short). The (RECFM=F) export data set has LRECL=LRECL 1. The required LRECL is LRECL 2. Specify a different export data set. (long).

Explanation: The user attempted an export operation and specified an LRECL=F data set that is incompatible with the exported data. The export operation cannot be performed.

User response: Use an export data set with LRECL=LRECL 2.

FMNDC208

Inconsistent selection (short). The template usage option should only be set to None when the export data format is set to CSV. Select another template usage option. (long).

Explanation: This message is issued by the FM/Db2 export function, on the 'To' panel. The user entered '5' (CSV) for the "Template usage" option. However, the export data format option set on the first export options panel is not CSV. The export cannot proceed.

User response: The choice for export data format, on the first export options panel, places restrictions on the template usage option that can be specified on the export 'To' panel. The following list shows which 'template usage' options can be specified for each export data format:

Export data format	Template usage option
FM/Db2 (SQLDA) format	All except 5 (CSV)
Db2 UNLOAD format	All except 5 (CSV)
DSNTIAUL format	All except 5 (CSV)
User defined	All except 5 (CSV)
Delimited variables (CSV)	5 (CSV) only.

FMNDC209

LRECL mismatch (short). The (RECFM=V) export data set has LRECL=*LRECL 1*. The required LRECL is at least *LRECL 2*. Specify a different export data set.

Explanation: The user attempted an export operation and specified an LRECL=F data set that is incompatible with the exported data. The export operation cannot be performed.

User response: Use an export data set with LRECL = *LRECL 2*.

FMNDC220

NX|X|EX invalid (short). The NX|X|EX parameters cannot be specified when in browse mode. Press help for more information. (long).

Explanation: The user entered the EXPORT editor primary command in a browse session, the EXPORT command included a reference to excluded, or not-excluded rows. This is not supported in a File Manager/Db2 browse session.

User response: Modify the EXPORT command to remove any reference to excluded, or not-excluded rows, retry the operation. If the intended usage requires the use of excluded or not-excluded rows as part of the EXPORT command, repeat the process using a File Manager/Db2 view session.

FMNDC221

No labels (short). Labels cannot be specified when in browse mode. Press help for more information. (long).

Explanation: The user entered the EXPORT editor primary command in a browse session, the EXPORT command included label references. There is no prefix area in a File Manager/Db2 browse session, so labels cannot be entered, nor can they be referred to.

User response: Modify the EXPORT command to remove any reference to labels, retry the operation.

FMNDC230

Warning - fixed RECFM (short). The output data set has a fixed record format, which is not recommended when using CSV format. Specify a data set with RECFM=VB or RECFM=V. (long).

Explanation: This message is issued by the FM/Db2 Export utility, when CSV format is selected. The attributes of the output data set are inconsistent with CSV format, which produces variable length output records.

User response: In general RECFM=F and RECFM=FB should not be used with CSV format. You can specify the name of a new data set on the export 'To' panel and FM/Db2 will calculate the correct LRECL for you.

FMNDC500

Executed OK (short). The *ALTER|COMMENT|CREATE|DROP|GRANT|LABEL|REVOKE* statement executed successfully. Db2® returned an SQLCODE of *SQLCODE*. (long).

Explanation: This message is issued by the FM/Db2 Object List and Object Privileges utilities. An SQL statement was executed successfully.

User response: No action required. Informational message.

FMNDC510

No rows returned (short). No rows were fetched, SQL code = +100. (long).

Explanation: This message is issued by the FM/Db2 Object List, Object Privileges and Explain utilities functions. A SELECT statement was executed, but returned no rows (SQLCODE+100).

User response: No action required. Informational message.

FMNDC520

No allocation data (short). The PQTY/SQTY values in SYSIBM.SYSTABLEPART indicate that RUNSTATS has not been run. The primary and/or secondary space allocation data for the table space is unavailable. (long).

Explanation: This message is issued by the Alter table space and Alter index panels, accessed from the FM/Db2 Object list utility. FM/Db2 accessed the Db2® catalog to determine the current space allocation values for the table space or index, however this information is not available because the RUNSTATS utility has not been executed. You can resolve this problem by executing the RUNSTATS utility against the appropriate table space or index, and then repeating the ALTER operation.

User response: No action required. Informational message.

FMNDC521

No allocation data (short). The PQTY/SQTY values in SYSIBM.SYSINDEXPART indicate that RUNSTATS has not been run. The primary and secondary space allocation data for the index space is unavailable. (long).

Explanation: This message is issued by the Alter index panel, accessed from the FM/Db2 Object list utility. FM/Db2 accessed the Db2® catalog to determine the current space allocation values for the index. However, this information is not available because the RUNSTATS utility has not been executed. You can resolve this problem by executing the RUNSTATS utility against the appropriate index, and then repeating the ALTER operation.

User response: No action required. Informational message.

FMNDC580

Must be blank (short). Specify one value or the other, but not both. (long).

Explanation: This message is issued by the FM/Db2 Privileges function. The user selected both options when the two options are mutually exclusive.

User response: Select one option, or the other, but not both. Consult the SQL Reference manual for the relevant syntax diagram for the command.

FMNDC581

Cannot drop directly (short). An auxiliary table cannot be dropped directly. To drop an auxiliary table drop the table that uses the auxiliary table. (long).

Explanation: This message is issued by the FM/Db2 "Db2® Object functions" utility. The user specified the combination of 'D' (Drop) and an object type of 12 (Auxiliary table). This combination is not supported.

User response: You cannot directly drop an auxiliary table. Auxiliary tables should be dropped by a DROP of the table of which the auxiliary table is a part. See the Db2® SQL Reference for a full explanation of the use of auxiliary tables.

FMNDC583

Reserved (short). Sequence number 1 is reserved for the SEL field. Specify a larger value. (long).

Explanation: This message is issued by the "Column Selection/Edit" panel, when displayed from the FM/Db2 Object List, Object Privileges and Explain functions (Collectively ISQ functions). The object displays for ISQ functions use a modified version of the FM/Db2 editor to display the data, and allow the same template editor functions as a normal FM/Db2 editor session; with some restrictions. While you can specify a sequence number in the 'Seq' field, a value of 1 is reserved for the 'Sel' field, which appears on most ISQ panels.

User response: Specify the required ordering starting at '2', instead of '1'.

FMNDC584

Must be blank (short). Specify the ALL parameter, or one or more values, but not both. (long).

Explanation: This message is issued on various Revoke Privilege panels displayed by the FM/Db2 Privileges function. When REVOKING a privilege with SYSADM authority you may REVOKE the privilege from ALL users, or list 1-3 individual Db2® authids. These options are mutually exclusive, you cannot select ALL and also enter an individual Db2® authid.

User response: Select ALL if the privilege is to be REVOKEd from all Db2® authids. Alternatively enter one or more individual Db2® authids.

FMNDC585

Must be selected (short). The PUBLIC selection field must be selected when the AT ALL LOCATIONS selection field is selected. (long).

Explanation: This message is issued by the Grant table and Grant column privileges' panels. The user selected the 'AT ALL LOCATIONS' field, but not the 'PUBLIC' field. Selecting the former requires that the latter also be selected

User response: Select both the 'PUBLIC' and 'AT ALL LOCATIONS' fields.

FMNDC586

Not with ROLE (short). The ROLE and PUBLIC options cannot both be selected. PUBLIC is a special Db2® authid, not a valid role name. (long).

Explanation: This message is issued by the Db2® Privileges utility when the user selects both the 'ROLE' and 'PUBLIC' fields. The utility does not support the simultaneous use of both the PUBLIC and ROLE options.

User response: To GRANT/REVOKE the privileges to PUBLIC, clear the ROLE field and process the request. Similarly, to GRANT/REVOKE the privileges to a ROLE, clear the PUBLIC field and process the request.

FMNDC587

Not with ROLE (short). The ROLE and ALL options cannot both be selected. ALL can only be specified with Db2® authids. (long).

Explanation: This message is issued by the Db2® Privileges utility when the user selects both the 'ROLE' and 'ALL' fields. The utility does not support the simultaneous use of both the PUBLIC and ALL options.

User response: To REVOKE the privileges from ALL Db2® authids that possess the privilege, clear the ROLE field and process the request. Similarly, to REVOKE the privileges from a ROLE, clear the ALL field and process the request.

FMNDC588

Not AT ALL LOCATIONS (short). The *Privilege type* privilege cannot be granted to PUBLIC AT ALL LOCATIONS. (long).

Explanation: This message is issued by the Db2® Privileges utility, when granting table or column privileges. The "AT ALL LOCATIONS" may not be used.

User response: Deselect the "AT ALL LOCATIONS" option and process the request.

FMNDC651

Invalid data type (short) ROWID, CLOB, BLOB and DBCLOB columns cannot be specified in a global temporary table definition. (long).

Explanation: This message is issued by the FM/Db2 Object functions utility, when attempting to create a global temporary table (GTT). One or more of the columns defined for the GTT has a prohibited data type (ROWID, CLOB, BLOB or DBCLOB). The GTT cannot be created.

User response: Correct the definition for any columns defined as ROWID, CLOB, BLOB or DBCLOB, retry the operation.

FMNDD000

Command list error (short). An error was encountered processing the list of valid commands for panel *panel_name*.

Explanation: This message is issued by the FM/Db2 Interactive SQL (ISQ) processor (used by the following options: 3.4; 3.5; 4.5). The line commands that may be entered against a list of objects are defined using a customization string. An error occurred during the processing of this string for panel *panel_name*.

User response: This is an internal error. Contact IBM® Support.

FMNDD001

Customization error (short). An error was encountered processing the template customization string for panel *panel_name*. (long).

Explanation: This message is issued by the FM/Db2 Interactive SQL (ISQ) processor (used by the following options: 3.4; 3.5; 4.5). Object lists are displayed using the FM/Db2 editor, the template for the object list is modified prior to display. The template customization is defined using a customization string. An error occurred during the processing of this string for panel *panel_name*.

User response: This is an internal error. Contact IBM® Support.

FMNDD002

No line commands (short). There are no line commands for this panel. (long).

Explanation: This message is issued by the FM/Db2 Interactive SQL (ISQ) processor (used by the following options: 3.4; 3.5; 4.5). In most cases you may enter one or more line commands against each row shown in the object list. In some few cases no line commands are available, in which case this message is issued.

User response: No action required. Informational message.

FMNDD003

VDEFINE error, RC=*Return code* short). A serious ISPF error has been encountered. VDEFINE RC=*Return code*. (long)

Explanation: FM/Db2 attempted to use the ISPF VDEFINE service, the call failed with RC = *Return code*. In most cases the current function will terminate.

User response: The causes of this error are:

- Problems with the ISPF environment that have caused the ISPF service call to fail. Contact your Systems Programmer for assistance.
- An internal error. Contact IBM® Support.

Points for the Systems Programmer to consider include:

- ISPF libraries allocated incorrectly or incompletely.
 - Full ISPF profile data sets.
 - Out of memory, or short on memory, conditions. Are other ISPF applications running? Are multiple ISPF logical sessions active?
-

FMNDD004

ISPF error, RC=*Return code* (short). A serious ISPF error has been encountered in FMN2IPSU. ISPF SELECT SERVICE RC=*Return code* (long).

Explanation: This message is issued by the FM/Db2 Interactive SQL (ISQ) processor used by the following options: 3.4; 3.5; 4.5). A serious error was encountered in response to an ISPF SELECT service call (return code = *Return code*) In most cases the function will terminate.

User response: The usual causes of this error are:

- Problems with the ISPF environment that have caused the ISPF service call to fail. Contact your Systems Programmer for assistance.
- An internal error. Contact IBM® Support.

Points for the System Programmer to consider include:

- ISPF libraries allocated incorrectly or incompletely.
 - Full ISPF profile data sets.
 - Out of memory, or short on memory, conditions. Are other ISPF applications running? Are multiple ISPF logical sessions active?
-

FMNDD005

:ISPF error, RC=*Return code* short). A serious ISPF error has been encountered in FMN2IPSU. ISPF CONTROL SERVICE RC=*Return code* long).

Explanation: This message is issued by the FM/Db2 Interactive SQL (ISQ) processor (used by the following options: 3.4; 3.5; 4.5). A serious error was encountered in response to an ISPF CONTROL service call (return code = *Return code*). In most cases the function will terminate.

User response: The usual causes of this error are:

- Problems with the ISPF environment that have caused the ISPF service call to fail. Contact your Systems Programmer for assistance.
- An internal error. Contact IBM® Support.

Points for the Systems Programmer to consider include:

- ISPF libraries allocated incorrectly or incompletely.
- Full ISPF profile data sets.
- Out of memory, or short on memory, conditions. Are other ISPF applications running? Are multiple ISPF logical sessions active?

FMNDD006

VDELETE error, RC=*Return code* (short). A serious ISPF error has been encountered. VDELETE RC=*Return code*(long).

Explanation: This message is issued by the FM/Db2 Interactive SQL (ISQ) processor (used by the following options: 3.4; 3.5; 4.5). A serious error was encountered in response to an ISPF DELETE service call (return code = *Return code*). In most cases the function will terminate.

User response: The usual causes of this error are:

- Problems with the ISPF environment that have caused the ISPF service call to fail. Contact your Systems Programmer for assistance.
- An internal error. Contact IBM® Support.

Points for the Systems Programmer to consider include:

- ISPF libraries allocated incorrectly or incompletely.
- Full ISPF profile data sets.
- Out of memory, or short on memory, conditions. Are other ISPF applications running? Are multiple ISPF logical sessions active?

FMNDD007

No dynamic area (short). A serious error has been encountered. Panel *Panel name* does not contain a dynamic area and therefore cannot be used to display ISQ editor output. (long).

Explanation: This message is issued by the FM/Db2 Interactive SQL (ISQ) processor (used by the following options: 3.4; 3.5; 4.5). A serious error was encountered attempting to display an ISPF panel.

User response: This is an internal error. Contact IBM® Support.

FMNDD008

Command not available (short). The SQL command is not supported under CICS®. (long).

Explanation: This message is issued when FM/Db2 is running under CICS®, and the user issues the SQL command. The SQL command is not available when running under CICS®.

User response: No action required. Informational message.

FMNDD009

VREP error, RC=RC (short). A serious ISPF error has been encountered. VREPLACE RC=RC. (long).

Explanation: This message is issued by the Basic SQL prototyper. It indicates that a serious ISPF error was encountered.

User response:

The usual causes of this error are:

- Problems with the ISPF environment that have caused the ISPF service call to fail. Contact your Systems Programmer for assistance.
- An internal error. Contact IBM® Support.

Points for the Systems Programmer to consider include:

- ISPF libraries allocated incorrectly or incompletely.
 - Full ISPF profile data sets.
 - Out of memory, or short on memory, conditions. Are other ISPF applications running? Are multiple ISPF logical sessions active?
-

FMNDD010

Invalid command *Command* (short). "*Command*" is not a valid File Manager Db2® command. *List of valid commands*. (long).

Explanation: This message is issued by the FM/Db2 Interactive SQL (ISQ) processor (used by the following options: 3.4; 3.5; 4.5). A command (for example XXXX) was issued on the TSO command line. However, this command is not recognized by the ISQ processor and cannot be run.

User response: No action required. Informational message.

FMNDD011

Too many parms (short). "*Command*"> is followed by one or more parameters. It is only valid without parameters. *PARMS=Parameters*. (long).

Explanation: This message is issued by the FM/Db2 Interactive SQL (ISQ) processor (used by the following options: 3.4; 3.5; 4.5). A command *Command*, with parameters, was entered on the TSO command line. *Command* does not require parameters.

User response: Remove the extraneous parameters, re-issue the command.

FMNDD012

No SQL to display (short). There is no SQL statement to display. (long).

Explanation: The user entered the SQL command; however there is no current SQL statement to display.

User response: No action required. Informational message.

FMNDD018

Object not found (short). No Db2® object at location *Location* matches the combination of object details entered at Db2® system *SSID*. Press Help for more information. (long).

Explanation: The user entered a Db2® object name, including location, owner, and name. This object does not exist. You can press PF1 to see additional help for this error.

User response: Press PF1 to see a more detailed explanation of the error. The usual reasons for this error include:

- The nominated object does not exist. Is it spelled correctly?
 - When the object name includes lower case letters you must ensure that automatic translation of object names is turned off. See the FM/Db2 systems options.
 - When the automatic translation of object names is turned off, you must ensure that the object name entered matches the case of the actual object name. For example, DSN81010.EMP matches DSN81010.EMP, but dsn81010.EMP does not.
-

FMNDD020

Invalid selection (short). The value entered is invalid. Type '?' in the field to display a list of valid values. (long).

Explanation: This message is issued by the FM/Db2 Interactive SQL (ISQ) processor (used by the following options: 3.4; 3.5; 4.5). The user entered a line command against a row. However, the line command is not valid for that type of object.

User response: Check for obvious mistakes such as typos. Type '?' in the field and press Enter to show the list of valid commands for the object.

FMNDD022

No SQL to display (short). There is no SQL statement to display. (long).

Explanation: The user entered the SQL command; however there is no current SQL statement to display.

User response: No action required. Informational message.

FMNDD028

Requires Db2® V9 (short). This command can only be issued when connected to a Db2® version 9 (or later) system. (long).

Explanation: This message is issued by the FM/Db2 Interactive SQL (ISQ) processor (used by the following options: 3.4; 3.5; 4.5). When connected to a Db2® version 8 system, the user entered a line command against a row; however the line command is only valid when connected to a Db2® version 9 (or later) system. The command cannot be processed.

User response: No action required. Informational message.

FMNDD029

Must be <= max value (short). The min value entered must be less than or equal to, the max value entered. (long).

Explanation: The user entered a value in a "minimum" field on the FM/Db2 Object List Options (2 of 2) panel. The value entered is greater than the corresponding maximum value, which is invalid.

User response: Check the minimum and maximum values for the appropriate column type. The minimum value sets the minimum display width for that column type; the maximum value set the maximum display width for that column type. The minimum display width cannot exceed the maximum.

FMNDD501

SQLCOST = Cst>.

Explanation: This message is issued when a SQL statement is about to be executed, and indicates the comparative cost *Cost* of executing the current statement. The cost values are those returned by Db2® when the SQL statement to be executed is prepared. See the SQL Reference manual for the appropriate version of Db2® for a more detailed explanation.

User response: No action required. Informational message.

FMNDD502

Invalid at remote server (short). "*Line ommand*" is only a valid command when entered against an object at the local server. For example, when the location field is blank. (long).

Explanation: The user entered a line command against an object displayed by the FM/Db2 Interactive SQL (ISQ) Processor (Options 3.4, 3.5 and 4.5 use the ISQ processor). Some line commands are only valid when FM/Db2 is connected to the local Db2® server, an example is privilege related commands such as GRANT and REVOKE. The command cannot be executed.

User response: Connect directly to the remote server and reissue the command.

FMNDD503

Data refreshed

Explanation: This message is issued by the FM/Db2 Interactive SQL (ISQ) processor (used by the following options: 3.4; 3.5; 4.5). The data for the currently displayed object list has been refreshed. This can occur when, for example, a line command issued against an entry on the current panel was used to change the entry. One example of this is deleting the object.

User response: No action required. Informational message.

FMNDD504

Invalid command (short). "*Line command*" is not a valid command. Valid commands are D(n), I(n), R(n), and S. (long).

Explanation: This message is issued by the FM/Db2 Object functions utility. When a list of, for example, columns is displayed, the user can issue various commands to modify the entries in the list. The command *line command* entered is invalid.

User response: No action required. Informational message.

FMNDD505

Invalid command (short). "*Line command*" is not a valid command. Valid commands are D(n), I(n, and R(n). (long).

Explanation: This message is issued by the FM/Db2 Object functions utility. When a list of, for example, columns is displayed, the user can issue various commands to modify the entries in the list. The command *line command* entered is invalid.

User response: No action required. Informational message.

FMNDD506

Invalid selection (short). Use S to select the column. (long).

Explanation: This message is issued by the FM/Db2 Object functions utility. An invalid character was entered against an entry in a list of columns.

User response: Use 'S' to select the column.

FMNDD507

Waiting for Db2® prepare ...

Explanation: This message is issued by FM/Db2 functions that use the FM/Db2 editor to display the result table for a SELECT statement. The FM/Db2 editor is operating in "Large" mode, meaning that a Db2® scrollable cursor is in use. The two operating modes for the FM/Db2 editor are described in detail under [Specifying the editor session mode: "normal mode" or "large mode" on page 121](#). Briefly, when a scrollable cursor is used, there can be a delay while Db2® prepares and opens the SQL statement used to access the data. See also message FMNDD508.

User response: No action required. Informational message.

FMNDD508

Waiting for Db2® open ...

Explanation: This message is issued by those FM/Db2 functions that use the FM/Db2 editor to display the result table for a SELECT statement. The FM/Db2 editor is operating in "Large" mode, meaning that a Db2® scrollable cursor is in use. The two operating modes for the FM/Db2 editor are described under [Specifying the editor session mode: "normal mode" or "large mode" on page 121](#). Briefly, when a scrollable cursor is used, there can be a delay while Db2® prepares and opens the SQL statement used to access the data. See also message FMNDD507.

User response: No action required. Informational message.

FMNDD510

Press enter to display the SQL for the view. You can modify/execute the SQL by selecting the "Execute SQL from data set" option.

Explanation: This message is issued when the user enters the VS (show SQL used to create a view) command against a view in an object list display. The Edit/Execute SQL (Data Set) function is used to display the resulting SQL. When the user presses END or CANCEL from the SQL display, the object list is redisplayed.

User response: Press Enter to see the SQL used to create the view.

FMNDD511

Enter the name of a database and table space defined with at least 8K pages. The Db2® Version 8 DSN_FUNCTION_TABLE requires a larger page size than previous Db2® versions.

Explanation: This message is issued when the user attempts to create a function table (DSN_FUNCTION_TABLE) on the Explain Utilities panel. This table requires a table space with a page size of 8K or greater, therefore both a database and table space name are required (The default database/table space will have a page size of 4K, which is inadequate).

User response: Enter the name of a database and table space that have a page size of at least 8K. You may need to contact your Db2® Database/System's Administrator for authority/information on how to do this.

FMNDD541

No RI relationships (short). The related edit (REDIT) command was issued. There are no referential integrity relationships defined on the table. (long).

Explanation: The user entered the REDIT editor primary command. When the object being edited is part of an referential integrity relationship this command displays the other Db2® objects in the relationship. No RI relationships exist that include the object being edited.

User response: No action required. Informational message.

FMNDE495

No Db2® TABLE matches the value entered. It is possible a Db2® object (eg view) that matches the name entered exists - however the selected Db2® utility supports Db2® tables ONLY.

Explanation: This message is issued when a Db2® object name - other than a table - is entered when preparing a Db2® LOAD or UNLOAD utility job. The Db2® LOAD and UNLOAD utilities support only table objects - not views, aliases, synonyms and so on.

User response: Ensure that the Db2® object name specified is a Db2® table.

FMNDJ999

File Manager Db2 component problem - message *Message number* not found in table.

Explanation: This message is issued when an attempt is made to issue message *Message number*, but the message number could not be found. It is a "catch all" message.

User response: If this message occurs during normal processing the likely cause is a logic error. Contact IBM® Support for assistance.

Support resources

Use these resources to find product details, fixes, and support.

Search knowledge bases

- Download a Program Directory:
 - [Program Directory for Application Delivery Foundation for z/OS Common Components](#)
 - [Program Directory for IBM File Manager for z/OS](#)
 - [Program Directory for IBM Fault Analyzer for z/OS](#)
- Get up-to-date details about installing, customizing, and using these products:
 - [Application Delivery Foundation for z/OS Common Components Customization Guide and User Guide](#)
 - [Fault Analyzer User's Guide and Reference](#)
 - [File Manager Customization Guide](#)
 - [File Manager User's Guide and Reference](#)
 - [File Manager User's Guide and Reference for DB2](#)
 - [File Manager User's Guide and Reference for CICS](#)
 - [File Manager User's Guide and Reference for IMS](#)

Get the latest PTFs

- [ADFz Common Components](#)
- [Fault Analyzer for z/OS](#)
- [File Manager for z/OS](#)
- [z/OS Debugger](#)
- [IBM Developer for z/OS Enterprise Edition](#)
- [Application Performance Analyzer for z/OS](#)

Collect diagnostic data

Before you contact Support, be ready to answer these questions:

- What software versions are you running?
- Do you have logs, traces, and messages related to the problem?
- Can you re-create the problem? If so, how do you re-create the problem?
- Did you make hardware, operating system, or networking software changes?
- Do you have a workaround for the problem?

Contact Support

Open a case, chat with Support, or connect to resources and communities through <https://www.ibm.com/mysupport>.

Notices

IBM File Manager for z/OS License Materials - Property of IBM Corp. and HCL Technologies Ltd. © Copyright IBM Corporation 2000, 2016. © Copyright HCL Technologies Limited 2017, 2024

This information was developed for products and services offered in the U.S.A.

IBM® may not offer the products, services, or features discussed in this document in other countries. Consult your local IBM representative for information on the products and services currently available in your area. Any reference to an IBM product, program, or service is not intended to state or imply that only that IBM product, program, or service may be used. Any functionally equivalent product, program, or service that does not infringe any IBM intellectual property right may be used instead. However, it is the user's responsibility to evaluate and verify the operation of any non-IBM product, program, or service.

IBM may have patents or pending patent applications covering subject matter described in this document. The furnishing of this document does not give you any license to these patents. You can send license inquiries, in writing, to:

*IBM Director of Licensing
IBM Corporation
North Castle Drive, MD-NC119
Armonk, NY 10504-1785
US*

For license inquiries regarding double-byte (DBCS) information, contact the IBM Intellectual Property Department in your country or send inquiries, in writing, to:

*Intellectual Property Licensing
Legal and Intellectual Property Law
IBM Japan Ltd.
19-21, Nihonbashi-Hakozakicho, Chuo-ku
Tokyo 103-8510, Japan*

INTERNATIONAL BUSINESS MACHINES CORPORATION PROVIDES THIS PUBLICATION "AS IS" WITHOUT WARRANTY OF ANY KIND, EITHER EXPRESS OR IMPLIED, INCLUDING, BUT NOT LIMITED TO, THE IMPLIED WARRANTIES OF NON-INFRINGEMENT, MERCHANTABILITY OR FITNESS FOR A PARTICULAR PURPOSE. Some jurisdictions do not allow disclaimer of express or implied warranties in certain transactions, therefore, this statement may not apply to you.

This information could include technical inaccuracies or typographical errors. Changes are periodically made to the information herein; these changes will be incorporated in new editions of the publication. IBM may make improvements and/or changes in the product(s) and/or the program(s) described in this document at any time without notice.

Any references in this information to non-IBM websites are provided for convenience only and do not in any manner serve as an endorsement of those websites. The materials at those websites are not part of the materials for this IBM product and use of those websites is at your own risk.

IBM may use or distribute any of the information you provide in any way it believes appropriate without incurring any obligation to you.

Licensees of this program who want to have information about it for the purpose of enabling: (i) the exchange of information between independently created programs and other programs (including this one) and (ii) the mutual use of the information which has been exchanged, should contact:

IBM Director of Licensing
IBM Corporation
North Castle Drive, MD-NC119
Armonk, NY 10504-1785
US

Such information may be available, subject to appropriate terms and conditions, including in some cases, payment of a fee.

The licensed program described in this information and all licensed material available for it are provided by IBM under terms of the IBM Customer Agreement, IBM International Program License Agreement, or any equivalent agreement between us.

The performance data discussed herein is presented as derived under specific operating conditions. Actual results may vary.

Information concerning non-IBM products was obtained from the suppliers of those products, their published announcements or other publicly available sources. IBM has not tested those products and cannot confirm the accuracy of performance, compatibility or any other claims related to non-IBM products. Questions on the capabilities of non-IBM products should be addressed to the suppliers of those products.

Statements regarding future direction or intent of IBM File Manager for z/OS are subject to change or withdrawal without notice, and represent goals and objectives only.

This information contains examples of data and reports used in daily business operations. To illustrate them as completely as possible, the examples include the names of individuals, companies, brands, and products. All of these names are fictitious and any similarity to the names and addresses used by an actual business enterprise is entirely coincidental.

COPYRIGHT LICENSE:

This information contains sample application programs in source language, which illustrates programming techniques on various operating platforms. You may copy, modify, and distribute these sample programs in any form without payment to IBM, for the purposes of developing, using, marketing or distributing application programs conforming to the application programming interface for the operating platform for which the sample programs are written. These examples have not been thoroughly tested under all conditions. IBM, therefore, cannot guarantee or imply reliability, serviceability, or function of these programs. The sample programs are provided "AS IS", without warranty of any kind. IBM shall not be liable for any damages arising out of your use of the sample programs.

Each copy or any portion of these sample programs or any derivative work must include a copyright notice as follows:

© (your company name) (year).

Portions of this code are derived from IBM Corp. and/or

HCL Ltd. sample programs.

© Copyright IBM Corp. 2000, 2016. © Copyright HCL Ltd. 2017, 2024.

Programming interface information

This documentation describes intended Programming Interfaces that allow the customer to write programs to obtain the services of File Manager.

Trademarks

IBM®, the IBM® logo, and ibm.com® are trademarks or registered trademarks of International Business Machines Corp., registered in many jurisdictions worldwide. Other product and service names might be trademarks of IBM® or other companies. A current list of IBM® trademarks is available on the web at "Copyright and trademark information" at www.ibm.com/legal/copytrade.shtml.

Terms and conditions for product documentation

Permissions for the use of these publications are granted subject to the following terms and conditions.

Applicability

These terms and conditions are in addition to any terms of use for the IBM® website.

Personal use

You may reproduce these publications for your personal, noncommercial use provided that all proprietary notices are preserved. You may not distribute, display or make derivative work of these publications, or any portion thereof, without the express consent of IBM®.

Commercial use

You may reproduce, distribute and display these publications solely within your enterprise provided that all proprietary notices are preserved. You may not make derivative works of these publications, or reproduce, distribute or display these publications or any portion thereof outside your enterprise, without the express consent of IBM®.

Rights

Except as expressly granted in this permission, no other permissions, licenses or rights are granted, either express or implied, to the publications or any information, data, software or other intellectual property contained therein.

IBM® reserves the right to withdraw the permissions granted herein whenever, in its discretion, the use of the publications is detrimental to its interest or, as determined by IBM®, the above instructions are not being properly followed.

You may not download, export or re-export this information except in full compliance with all applicable laws and regulations, including all United States export laws and regulations.

IBM® MAKES NO GUARANTEE ABOUT THE CONTENT OF THESE PUBLICATIONS. THE PUBLICATIONS ARE PROVIDED "AS-IS" AND WITHOUT WARRANTY OF ANY KIND, EITHER EXPRESSED OR IMPLIED, INCLUDING BUT NOT LIMITED TO IMPLIED WARRANTIES OF MERCHANTABILITY, NON-INFRINGEMENT, AND FITNESS FOR A PARTICULAR PURPOSE.

IBM Online Privacy Statement

IBM Software products, including software as a service solutions, ("Software Offerings") may use cookies or other technologies to collect product usage information, to help improve the end user experience, to tailor interactions with the end user, or for other purposes. In many cases no personally identifiable information is collected by the Software Offerings. Some of our Software Offerings can help enable you to collect personally identifiable information. If this Software Offering uses cookies to collect personally identifiable information, specific information about this offering's use of cookies is set forth below.

This Software Offering does not use cookies or other technologies to collect personally identifiable information.

If the configurations deployed for this Software Offering provide you as customer the ability to collect personally identifiable information from end users via cookies and other technologies, you should seek your own legal advice about any laws applicable to such data collection, including any requirements for notice and consent.

For more information about the use of various technologies, including cookies, for these purposes, see IBM's Privacy Policy at <http://www.ibm.com/privacy> and IBM's Online Privacy Statement at <http://www.ibm.com/privacy/details> in the section entitled "Cookies, Web Beacons and Other Technologies," and the "IBM Software Products and Software-as-a-Service Privacy Statement" at <http://www.ibm.com/software/info/product-privacy>.

Programming interface information

The User's Guide and Reference documents intended Programming Interfaces that allow the customer to write programs to obtain the services of File Manager.

Index

Special Characters

- *SEE* underscore (_)
- ? command to list valid prefix commands 162
- (1,*), print option 794
- (n,m), print option 794
- @
 - SEE* national characters
- *
 - SEE* asterisk (*)
- \= row selection criteria operator 770
- \> row selection criteria operator 770
- & row selection criteria connector 769
- #
 - SEE* national characters
- %
 - SEE* percentage (%)
- < row selection criteria operator 770
- <= row selection criteria operator 770
- = row selection criteria operator 770
- > row selection criteria operator 770
- >= row selection criteria operator 770
- <- row selection criteria operator 770
- = row selection criteria operator 770
- > row selection criteria operator 770
- BT row selection criteria operator 771
- IN row selection criteria operator 771
- LK row selection criteria operator 771
- NL row selection criteria operator 771
- | row selection criteria connector 769
- / (synonym for FIND command) 897
- \$
 - SEE* national characters

Numerics

- 132, print option 793
- 80, print option 793

A

- A line command
 - databases 594
 - functions 685
 - indexes 699
 - row selection criteria 768
 - stored procedures 814
 - table edit 826, 837
 - table spaces 836
 - tables, views and aliases 844
- ABOUT primary command 870
- action bar
 - on
 - FM/Db2
 - panels
 - 37
 - pull-down menu, description 436
- ADD line command
 - tables, views and aliases 844
- Additional LISTDEF Statements panel, description 440
- Additional TEMPLATE Statements panel, description 441
- Advanced SELECT Prototyping panel, description 442
- ALL primary command 870
- allow
 - substitution chars, Db2 LOAD utility option 711
 - updates to primary key option 641

- alphanumeric columns (Object List Utility) 303
- ALS line command
 - tables, views and aliases 845
- AND row selection criteria connector 769
- APF-authorized 28
- Application Packages panel, description 460
- Application Plan Details panel, description as a details panel 619
- Application Plan Privilege Details panel, description as a privilege details panel 736
- Application Plan Privileges panel, description as a privileges panel 736
- Application Plans panel, description 463
- Arbitrary SQL Select Statements 819
- arithmetic operators, REXX 258
- asterisk (*)
 - filtering object lists 303
 - using in
 - FM/Db2
 - entry fields
 - 49
- AT line command
 - columns 492
 - tables, views and aliases 845
- attention interrupt key 54
- attributes
 - changing for a column 114
 - for a numeric column, changing 103
 - for an alphanumeric column, changing 102
- Audit trail (option 3.10), description 328
- audit trail report
 - description 329
 - summary statistics 330
- Auto detect, compiler language selection option 494
- auto-commit count, editor option 651

B

- B line command
 - DBRMs 592
 - row selection criteria 768
 - table edit 827, 837
 - tables, views and aliases 845
- BACKWARD primary command 36, 36, 871
- Basic SELECT Prototyping panel, description 465
- batch functions
 - BATSQL (Batch SQL) 955
 - D2G (Data Generate) 994
 - D2TP (Template create/update) 996
 - DBC (Copy) 963
 - DBI (Import) 970
 - DBP (Print) 976
 - DBX (Export) 979
- batch mode
 - JCL syntax 424
 - running
 - File Manager/Db2
 - 424
- batch mode Db2
 - using edit models 425
- batch processing
 - Audit trail (option 3.10) 245, 328
 - Create (option 3.8) 590
 - Export (option 3.7) 281
 - Import (option 3.6) 251
 - Object List (option 3.4) 318, 319
 - prerequisite knowledge xiv

- Print (option 3.1) 324
- Utilities (option 3.9) 345, 350
- Batch Submission Job Statement Information processing option 784
- BATSQL (Batch SQL),
 - FM/Db2
- batch function
- 955
- BI line command
 - application plans 464
- BIGINT data type, description 432
- BINARY data type, description 432
- Bind Application Plan panel, description 470
- Bind Package panel, description 471
- BLOB (large object) 434
- boolean operators, REXX 259
- BOTTOM primary command 36, 872
- Browse
 - non-updateable columns 186
 - read-only views 186
- BROWSE primary command 872
- BT line command
 - tables, views and aliases 845
- BTW 771
- build indexes in parallel, Db2 LOAD utility option 711
- built-in functions, REXX 260

C

- C line command
 - row selection criteria 768
 - table edit 827, 837
 - tables, views and aliases 845
- CA-Panvalet
 - specifying a data set 50
 - using copybooks with non-Db2 data 77
- CANCEL primary command 873
- canceling long-running Db2 queries 54
- CAPS primary command 185, 874
- CASE primary command 185, 875
- CC line command 768
- CDI line command
 - tables, views and aliases 845
- CH line command
 - tables, views and aliases 845
- CHANGE
 - external function 266
 - primary command 875
- Change Extended (CX) command 179
- changing
 - attributes
 - alphanumeric column 102
 - column 114
 - numeric column 103
 - long strings 179
 - numeric columns 181
 - output width 103, 103
 - scramble data set name 108
 - scramble range values 108
 - scramble type 105
 - scramble value columns 107
 - scramble value option 106
 - strings of different length 179
 - suppression of leading zeros 104
- CHAR data type, description 432
- CHARPOS primary command 881
- check constraints, create table option 229
- Children of Table panel, description 471

choosing your Db2 subsystem 30, 35
 CHR line command
 tables, views and aliases 845
 CK line command
 tables, views and aliases 845
 CLOB (large object) 434
 clustered data sampling 167
 clustered sampling option 632
 COBOL
 compiler
 language selection option 494
 options 786
 return code, maximum allowable 786
 specifications 63
 compiler, displaying details 29
 data description entries 76
 replacing options, COBOL processing option 786
 COL
 line command
 indexes 699
 tables, views and aliases 845
 primary command 880
 Collection Privileges panel, description as a privileges panel 736
 Collections panel, description 471
 column
 alphanumeric, changing attributes 102
 create attributes, information stored in templates 74
 fixed attributes, information stored in templates 74
 headings
 changing 102
 information stored in templates 74
 mapping
 contiguous columns 115
 rules (data type conversion) 115
 names, specifying for LOCATE primary command 140
 numbers
 displaying 164
 specifying for LOCATE primary command 140
 numeric, changing attributes 103
 selecting for attribute change 101
 selecting for specifying scrambling options 105
 selection criteria, information stored in templates 73
 sequence, information stored in templates 73
 use attributes, information stored in templates 74
 Column Attributes panel (alphanumeric), description 473
 Column Attributes panel (DATE), description 477
 Column Attributes panel (numeric), description 478
 Column Attributes panel (TIME), description 482
 Column Attributes panel (TIMESTAMP), description 483
 Column Details panel, description as a details panel 619
 Column Distribution panel, description 485
 column list 144
 Column Part Statistics panel, description 485
 Column Privilege Details panel, description as a privilege details panel 736
 Column Privileges panel, description as a privileges panel 736
 column range 144
 Column Selection/Edit panel, description 485
 Column Selection/Edit primary panel 82, 83, 96
 columns
 create table option 226
 holding for scrolling 97
 scrolling to specified name 138
 selecting for display 96
 Columns in Index panel, description 492
 Columns in Table panel, description 493
 Columns panel, description 491
 COM line command
 columns 492
 distinct types 620
 functions 685
 stored procedures 814
 tables, views and aliases 845
 triggers 854
 command line, description 38
 commands
 continuation 424
 reading syntax diagrams xv
 commands, Db2, entering from FM/Db2
 session 196
 comment
 panels
 description 493
 list of 493
 Comment Column panel, description as a comment panel 493
 Comment Distinct Type panel, description as a comment panel 493
 Comment Procedure panel, description as a comment panel 493
 Comment Specific Function panel, description as a comment panel 493
 Comment Table panel, description as a comment panel 493
 Comment Trigger panel, description as a comment panel 493
 commit when save issued option 650
 comparison operators, REXX 255
 compiler language selection 63
 Compiler Language Selection panel, description 493
 compiler, COBOL, displaying details 29
 concurrency
 and locking options 652
 connectors, row selection criteria, list of 769
 Constraint Columns for panel, description 495
 CONTAINS external function 267
 continuation character 424
 control statement, continuation 424
 convert
 row to uppercase 831, 841
 spaces to null option 647
 uppercase characters in a row to lowercase 829, 839
 converting data to uppercase 185
 copy
 line (row selection criteria) 768
 row 827, 837
 Copy (option 3.3)
 description 241
 setting options for the current session 245
 Copy Options panel, description 495
 Copy Utility ("From") panel, description 498
 Copy Utility ("To") panel, description 506
 COPY Utility (Index Spaces) panel, description 502
 COPY Utility (Index Spaces) with LISTDEF panel, description 504
 COPY Utility (Table Spaces) panel, description 509
 COPY Utility (Table Spaces) with LISTDEF panel, description 511
 Copy utility options 66
 COPY, generating Db2 utility 346
 copybook
 coding 290, 296
 creating from FM/Db2 template 118
 Library Management System Exit 50 stored in CA-Panvalet library 50
 copying
 scrambling data 286
 copying data
 FM/Db2 utilities to use 241
 from a VSAM or QSAM file 246
 from an SQL statement 283
 from one Db2 object to another 241, 288
 from the current FM/Db2 editor session 283
 scenarios 287
 to a VSAM or QSAM file 274
 CR line command
 synonyms 816
 tables, views and aliases 845
 Create (option 3.8), description 239, 485
 Create Alias 230
 Create Alias panel, description 512
 create audit trail option 602, 627
 Create Auxiliary Table 237
 Create Auxiliary Table panel, description 513
 Create Database 218
 Create Database panel, description 514
 Create Distinct Type 233
 Create Distinct Type panel, description 516
 Create function
 description 234
 option list 1/2 235
 option list 2/2 235
 parameter types 234
 parameters 234
 returned data type 235
 Create Function panel, description 521
 Create Function: Option List (1/2) panel, description 518
 Create Function: Option List (2/2) panel, description 519

- Create Function: Parameter Types panel, description 522
- Create Function: Parameters panel, description 524
- Create Function: Returned Data Type panel, description 525
- Create Index 231
 - allocation 232
 - index 232
 - index column selection 232
 - index type 232
 - partitions 233
- Create Index panel, description 527
- Create Index: Allocation panel, description 530
- Create Index: Column Selection panel, description 531
- Create Index: Options panel, description 532
- Create Index: Partition Values panel, description 535
- Create Index: Partitions panel, description 534
- Create Index: Type panel, description 537
- Create Procedure 235
 - option list 236
 - option list 1/2 236
 - parameter types 236
 - parameters 236
- Create Procedure panel, description 538
- Create Procedure: Option List (1/2) panel, description 539
- Create Procedure: Option List (2/2) panel, description 541
- Create Procedure: Parameter Types panel, description 542
- Create Procedure: Parameters panel, description 543
- Create Synonym 233
- Create Synonym panel, description 545
- create table
 - description 221
 - table creation options
 - check constraints 229
 - columns 226
 - description 225
 - generate values 230
 - nulls and default values 226
 - options 227
 - procedure exits 230
 - referential constraints 227
 - unique constraints 227
 - using a model 222
 - without using a model 225
- Create Table panel, description 546
- create table space
 - data
 - sharing 220
 - storage 220
 - locking 220
 - partitions 221
 - table space
 - allocation 220
 - type 219
- Create Table Space panel, description 549
- Create Table Space: Allocation panel, description 551
- Create Table Space: Data Sharing Options panel, description 552
- Create Table Space: Data Storage Options panel, description 553
- Create Table Space: Define Partitions panel, description 555

- Create Table Space: Locking Options panel, description 557
- Create Table Space: Type panel, description 558
- Create Table: Column Check Constraints panel, description 559
- Create Table: Column Referential Constraints panel, description 561
- Create Table: Columns panel, description 562
- Create Table: Generate Values panel, description 565
- Create Table: Model Load panel, description 566
- Create Table: Nulls and Default Values panel, description 568
- Create Table: Options panel, description 571
- Create Table: Procedure Exits panel, description 573
- Create Table: Table Check Constraints panel, description 574
- Create Table: Table Referential Constraint panel, description 576
- Create Table: Table Referential Constraints panel, description 577
- Create Table: Unique Constraints panel, description 579
- Create trigger
 - description 236
 - details 237
 - search conditions 237
 - SQL statement 237
- Create Trigger panel, description 580
- Create Trigger: Details panel, description 582
- Create Trigger: Search Condition panel, description 584
- Create Trigger: SQL statement panel, description 584
- Create View 230
- Create View panel, description 585
- creating
 - copybook from
 - FM/Db2
 - template
 - 118
 - data for a column 115
- CRS line command
 - databases 594
- CRT line command
 - table spaces 836
- CRX line command
 - tables, views and aliases 845
- CS line command
 - tables, views and aliases 845
- cursor stability option 654
- CX (Change Extended) command 179

D

- D
 - edit prefix command 827, 837
 - line command
 - EXPLAIN plan table 725
 - indexes 699
 - row selection criteria 768
 - table spaces 836
 - tables, views and aliases 845
 - table space partition prefix command 555
 - D line command
 - storage groups 811
 - D2G (Data Generate), FM/Db2
 - batch function

- 994
- D2TP (Template create/update), FM/Db2
 - batch function
- 996
- data
 - copying 241
 - displaying data in hexadecimal format 162
 - format, output from Export (option 3.7) 279
 - large objects (LOBs) 434
 - sampling 167
 - sorting in editor session 161
 - types, VARCHAR 174
- Data Create Utility panel, description 587
- Data description support
 - HLASM
 - DS/DC 79
 - DSECT 79
 - PL/I
 - not supported 79
 - REFER 79
 - VARYING 79
 - VARYINGZ 79
- data format, export options 665
- data set
 - name, specifying on panel 50
- Data set DISP, print option 793
- Data set name, print option 794
- Data set, print option 793
- data sharing environment 608
- data type
 - displaying 164
 - rules, conversion 115
- data types, description
 - BIGINT 432
 - BINARY 432
 - CHAR 432
 - DATE 433
 - DECFLOAT 432
 - DECIMAL 432
 - DOUBLE 432
 - FLOAT 432
 - GRAPHIC 432
 - INTEGER 432
 - NUMERIC 432
 - REAL 432
 - ROWID 433
 - SMALLINT 432
 - TIME 433
 - VARBINARY 432
 - VARCHAR 432
 - VARGRAPHIC 432
- data, displayed
 - changing view 149
 - limiting
 - excluding rows 159
 - row labels 147
- database
 - for a Db2 object, specifying 48
- Database Details panel, description as a details panel 618
- Database Privilege Details panel, description as a privilege details panel 736
- Database Privileges panel, description as a privileges panel 736
- Database Request Modules
 - panel, description 591
- Database Structure panel, description 592
- Databases panel, description 593
- DATE data type, description 433
- Db2

- commands, entering from
 - FM/Db2
 - session
 - 196
 - data
 - sharing environment 608
 - types supported 432
 - Interactive, interface to 430
 - object name, specifying on panel 45
 - objects
 - creating and dropping 203
 - working with lists of 297
 - privileges, managing 332
 - releases supported by
 - FM/Db2
 - 25
 - subsystem
 - changing using Db2 SSID field 30
 - changing using SSID command 32
 - selecting 30
 - Subsystem Selection menu 33
 - table, printing contents 321
 - utilities
 - COPY 346
 - generating 339
 - LOAD 349
 - REBUILD 357
 - RECOVER 360
 - REORG 363
 - RUNSTATS 368
 - UNLOAD 289, 372
- Db2 Browse panel, description 595
- Db2 Edit panel, description 598
- Db2 Location Selection panel, description 603
- Db2 Object Functions panel, description 604
- Db2 Save Error Action panel, description 606
- Db2 SSID field, changing Db2 subsystem 30
- Db2 Subsystem Selection panel, description 607
- Db2 tables
 - populating 239
- Db2 Template Description panel, description 608
- Db2 Utilities panel, description 610
- Db2 View panel, description 613
- Db2I Primary Option Menu panel, description 618
- DB2SYS command
 - see SSID command, changing Db2 subsystem
- DBC (Copy),
 - FM/Db2
- batch function
 - 963
- DBCLOB (large object) 434
- DBCS
 - data, Db2 LOAD utility option 711
 - displaying or editing 68
 - Settings: Load utility options (option 0.5) 711, 711
- DBCS processing option 787
- DBI (Import),
 - FM/Db2
- batch function
 - 970
- DBP (Print),
 - FM/Db2
- batch function
 - 976
- DBRM Details panel, description as a details panel 619

- DBX (Export),
 - FM/Db2
- batch function
 - 979
- DD line command
 - row selection criteria 768
 - table edit 827, 837
- DECFLOAT data type, description 432
- DECIMAL data type, description 432
- decimal data, export options 671
- DELCOL primary command 882
- delete
 - existing rows, option 497
 - line (row selection criteria) 768
 - row 827, 837
 - row (partition information) 555
- DELETE primary command 882
- DEP line command
 - packages 462
 - sequences 783
- DESCRIBE primary command 884
- description, adding to a template 82
- DESELECT primary command 884
- details panels
 - description 618
 - list of 618
- DI line command
 - columns 492
- display
 - excluded row 827, 838
 - format
 - examples 149
 - single (SNGL) 152
 - table (TABL) 150
 - using Zoom function key 157
- Display Format for DATE/TIME Columns
 - processing option 820
- display prefix area option 636
- Display Row panel, description 619
- display, print output, when browsing or editing 149
- displaying
 - privileges 334
- Distinct Type Details panel, description as a details panel 619
- Distinct Type Privileges panel, description as a privileges panel 736
- Distinct Type Usage Privilege Details panel, description as a privilege details panel 736
- Distinct Types panel, description 619
- DK line command
 - for EXPLAIN plan table 725
 - for EXPLAIN statement table 808
- do not set COPY pending flag, Db2 LOAD utility option 711
- DOUBLE data type, description 432
- DOUBLE PRECISION data type, description 432
- DOWN primary command 36, 885
- DP line command
 - for EXPLAIN plan table 726
 - for EXPLAIN statement table 808
- DQ line command
 - for EXPLAIN plan table 726
 - for EXPLAIN statement table 808
- DR line command
 - databases 594
 - distinct types 621
 - functions 686
 - indexes 699
 - sequences 783
 - stored procedures 814

- synonyms 816
- table spaces 836
- tables, views and aliases 845
- triggers 854
- drop
 - function 238
 - panels
 - description 621
 - list of 621
- Drop Alias panel, description as a drop panel 621
- Drop Confirmation panel, description 622
- Drop Database panel, description as a drop panel 621
- Drop Distinct Type panel, description as a drop panel 621
- Drop Function panel, description as a drop panel 621
- Drop Index panel, description as a drop panel 621
- Drop Stored Procedure panel, description as a drop panel 621
- Drop Synonym panel, description as a drop panel 621
- Drop Table panel, description as a drop panel 621
- Drop Table Space panel, description as a drop panel 622
- Drop Trigger panel, description as a drop panel 622
- Drop View panel, description as a drop panel 622
- DROP, RETURN return value 273
- DS line command
 - databases 594
 - table spaces 836
- DS/DC 79
- DSECT 79
- DT line command
 - columns 492
 - schemas 780
- duplicate key processing, option 497

E

- E line command
 - table edit 827, 838
 - tables, views and aliases 845
- Edit (option 2)
 - converting data to uppercase 185
 - displaying data in hexadecimal format 162
 - errors, handling 197
 - limiting data displayed
 - excluding rows 159
 - scrolling 157
 - sorting data 161
 - VARCHAR, options for processing 174
 - varying-length columns, options for processing 174
 - zooming 155
- edit models
 - example 426
- edit models Db2
 - inserting in JCL 425
- Edit options 65
- edit prefix commands, list of 826, 837
- EDIT primary command 886
- edit related table 830, 840
- Edit/Execute SQL (Data Set) panel, description 623
- EDITCOL primary command 887
- editing

- templates 81
- editor
 - finding
 - string 142
 - locating
 - row 138
 - locating a labeled row 138
- editor CAPS Setting 626
- Editor Options (1 of 8) panel, description 625
- Editor Options (2 of 8) panel, description 630
- Editor Options (3 of 8) panel, description 634
- Editor Options (4 of 8) panel, description 641
- Editor Options (5 of 8) panel, description 645
- Editor Options (6 of 8) panel, description 649
- Editor Options (7 of 8) panel, description 652
- Editor Options (8 of 8) panel, description 656
- editor session
 - data, displayed, changing view 149
 - finding
 - numeric column 148
 - large numeric fields 165
 - large table options 167
 - limiting data displayed
 - row labels 147
 - locating
 - column 139
 - specifying type 121
 - SQL optimization options 166
 - start position, specifying 123
 - Unicode data 175
- Encapsulation of SQL Identifiers in Double Quotes processing option 817
- end of string delimiter
 - display option 647
 - input option 647
- END primary command 888
- ending a session
 - FM/Db2
 - editor
 - 130
- enforce constraints, Db2 LOAD utility
 - option 711
- engineering, reverse 317
- Enter and Execute Db2 Commands panel, description 659
- Enter key and commit processing options 629
- Enter, Execute and Explain SQL Statements panel, description 660
- EQ row selection criteria operator 770
- errors
 - in an Edit session, handling 197
 - SQL statements 419
- EXCLUDE primary command
 - description 888
- exclude row from display 831, 841
- excluded rows
 - sorting in editor session 161
 - using RESET to redisplay 932
- excluding rows 159
- EXECUTE primary command 893
- execution, export options 666
- Exit 29
- EXIT statement 262
- EXPAND primary command 893
- EXPLAIN
 - interpretation panel, description 662
 - plan table primary commands
 - D 725
 - DK 725
 - DP 726
 - DQ 726

- FR 726
- I 726
- IH 726
- K 726
- M 726
- P 726
- SR 726
- T 726
- UH 726
- X 726
- primary command 894
- statement table primary commands
 - DK 808
 - DP 808
 - DQ 808
 - I 809
 - K 809
 - M 809
 - P 809
- Explain Utilities panel, description 662
- export
 - options
 - batch data set creation 666
 - data format 665
 - decimal data 671
 - execution 666
 - floating point data 672
 - graphic data 672
 - indicator 669
 - integer data 672
 - placement 668
 - type 669
 - usage 668
 - Options (1 of 3) panel, description 665
 - Options (2 of 3) panel, description 667
 - Options (3 of 3) panel, description 671
- Export "To" panel, description 676
- Export (option 3.7)
 - data formats 279
 - description 274
 - notes on using 282
 - running in batch 289
 - scenarios 287
 - setting options for the current session 277
- export data set, export options 666
- EXPORT primary command
 - description 894
- Export utility options 67
- Export Utility panel, description 673
- exporting
 - scrambling data 286
- expressions, REXX 253
- external functions provided by FM/Db2
 - CHANGE 266
 - CONTAINS 267
 - FLD 268
 - NCONTAIN 269
 - PRINT 269
 - PRTCOUNT 270
 - RECSIN 270
 - RECSOUT 270
 - TALLY 271
 - TM 272
 - WRITE 272

F

- F line command
 - schemas 780
 - table edit 827, 838
- Field Selection/Edit panel, description 679

- field-level help 58
- FILE primary command 897
- filter line, object lists 303
- Find Extended (FX) command 143
- FIND primary command
 - description 897
 - Object List utility 308
- finding
 - long strings 143
 - numeric column 148
 - string 142, 308
- first page, scrolling to 36
- FIRST parameter, using in LOCATE command 142
- FK line command
 - tables, views and aliases 845
- flavors, of
- File Manager
 - xiii
- FLD
 - external function 268
 - parameter, using in LOCATE command 140
- FLOAT data type, description 432
- floating point data, export options 672
- FM/Db2
 - Db2 releases supported by 25
 - entry fields
 - patterns, using 49
 - wildcards, using 49
 - exiting 29
 - external functions
 - CHANGE 266
 - CONTAINS 267
 - FLD 268
 - NCONTAIN 269
 - PRINT 269
 - PRTCOUNT 270
 - RECSIN 270
 - RECSOUT 270
 - TALLY 271
 - TM 272
 - WRITE 272
 - flavors xiii
 - functions
 - BATSQL (Batch SQL) 955
 - D2G (Data Generate) 994
 - D2TP (Template create/update) 996
 - DBC (Copy) 963
 - DBI (Import) 970
 - DBP (Print) 976
 - DBX (Export) 979
 - description 954
 - functions, overview 22
 - launching 27
 - Object List Options (1 of 2) panel, description 714
 - Object List Options (2 of 2) panel, description 717
 - panels
 - action bar 37
 - command line 38
 - database, specifying 48
 - Db2 object object names, specifying 45
 - function keys 38
 - location, specifying 46
 - name of a Db2 object, specifying 48
 - owner, specifying 47
 - panel body 38
 - panel title 37
 - record count 37
 - selecting options 44

- SQLID, specifying 50
- table space, specifying 48
- working with 37
- REXX procedures, interfacing with, description 263, 274
- Systems Options (1 of 4) panel, description 817
- Systems Options (2 of 4) panel, description 819
- Systems Options (3 of 4) panel, description 821
- Systems Options (4 of 4) panel, description 823
- template, creating copybook from 118
- FM/Db2
 - editor
 - ending a session 130
 - setting options for the current FM/Db2 session 123
 - specifying a Db2 object 133
 - specifying the type of session 121
 - starting a session 120
 - starting another session 132
 - validating, saving changes 124
- Release News panel, description 683
- FM/Db2
 - session, starting another 132
- FMAP primary command 903
- FMN
 - DB2 424
- foreign key
 - editor options 642
 - multiple 643
 - Objects (option 3.2) 228, 228, 562, 568, 578
 - scale line, displaying 636
 - system options 821
- Foreign Keys for Table panel, description 683
- FORMAT primary command 904
- format, examples 149
- FORWARD primary command 36, 36, 904
- FR line command (for EXPLAIN plan table) 726
- fragments, syntax diagrams xv
- FRE line command
 - application plans 464
 - packages 462
- Free Application Plan panel, description 683
- Free Package panel, description 683
- FREE primary command 906
- FS
 - line command 827, 838
 - primary command 907
- FT primary command 907
- Function Details panel, description as a details panel 619
- function keys
 - default settings 38
 - Zoom 157
- Function Privilege Details panel, description as a privilege details panel 736
- Function Privileges panel, description as a privileges panel 736
- functions
 - batch 955
 - built-in, REXX 260

- external, provided by
 - FM/Db2
 - CHANGE 266
 - CONTAINS 267
 - FLD 268
 - NCONTAIN 269
 - PRINT 269
 - PRTCOUNT 270
 - RECSIN 270
 - RECSOUT 270
 - TALLY 271
 - TM 272
 - WRITE 272
- Functions panel, description 684
- functions,
 - FM/Db2
 - BATSQL (Batch SQL) 955
 - D2G (Data Generate) 994
 - D2TP (Template create/update) 996
 - DBC (Copy) 963
 - DBI (Import) 970
 - DBP (Print) 976
 - DBX (Export) 979
 - description 954
 - FX (Find Extended) command 143
- G**
 - G line command
 - application plans 464
 - collections 472
 - columns 492
 - databases 594
 - distinct types 621
 - functions 686
 - packages 462
 - sequences 783
 - storage group usage privileges 812
 - stored procedures 814
 - table edit 827, 838
 - table spaces 836
 - tables, views and aliases 845
 - GE row selection criteria operator 770
 - GEN line command
 - databases 594
 - distinct types 621
 - functions 686
 - indexes 699
 - reverse engineering 317
 - schemas 780
 - stored procedures 814
 - table spaces 836
 - tables, views and aliases 845
 - Generate SQL From Db2 Catalog panel, description 686
 - get row from clipboard 827, 838
 - Grant Application Plan Privileges panel, description as a grant privileges panel 689
 - Grant Buffer Pool Privileges panel, description as a grant privileges panel 689
 - Grant Collection Privileges panel, description as a grant privileges panel 689
 - Grant Column Privileges panel, description as a grant privileges panel 689
 - Grant Database Privileges panel, description as a grant privileges panel 689
 - Grant Distinct Type Privileges panel, description as a grant privileges panel 689
 - Grant Function Privileges panel, description as a grant privileges panel 689
 - Grant Package Privileges panel, description as a grant privileges panel 689

- grant privileges panels
 - description 689
 - list of 689
- Grant Schema Privileges panel, description as a grant privileges panel 689
- Grant Sequence Privileges panel, description as a grant privileges panel 689
- Grant Storage Group Privileges panel, description as a grant privileges panel 689
- Grant Stored Procedure Privileges panel, description as a grant privileges panel 689
- Grant System Privileges panel, description as a grant privileges panel 689
- Grant Table Privileges panel, description as a grant privileges panel 689
- Grant Table Space Use Privileges panel, description as a grant privileges panel 689
- granting privileges 335
- graphic data, export options 672
- GRAPHIC type, description 432
- GT 770

H

- H line command
 - columns 492
- help
 - accessing 55
 - fields 58
 - menu 439
 - tutorial 55
- HEX primary command 908
- hexadecimal, displaying data 162
- HIDE primary command 909
- HINT primary command 910
- HLASM
 - compiler
 - specifications 64
 - data description entries 76
 - data description support
 - DS/DC 79
 - DSECT 79
- HLASM Processing Options 787
- HLASM, compiler language selection option 494
- HOLD primary command 910
- holding columns for scrolling 97

I

- I line command
 - application plans 464
 - columns 492
 - databases 594
 - DBRMs 592
 - distinct types 621
 - for EXPLAIN plan table 726
 - for EXPLAIN statement table 809
 - functions 686
 - indexes 699
 - packages 462
 - plan table rows panel 727
 - storage group usage privileges 812
 - stored procedures 814
 - synonyms 816
 - table edit 827, 838
 - table space partition prefix command 555
 - table spaces 836
 - tables, views and aliases 845
 - triggers 854
- ICS line command
 - databases 594
 - indexes 699
 - table spaces 836

- ignore RI/constraint errors, option 497
- IH line command (for EXPLAIN plan table) 726
- Import (option 3.6) 246, 274
 - description 246
 - REXX procedure, using 252
 - scenarios 287
- Import Options panel, description 690
- importing
 - scrambling data 286
- IN row selection criteria operator 771
- include count option 633
- index
 - information, editor options 643
- Index Details panel, description as a details panel 619
- Index Parts panel, description 697
- Indexes and Columns for panel, description 699
- Indexes panel, description 697
- INDEXINF primary command 911
- indicator, export options 669
- information
 - stored in a template 73
- initial display option 626
- initial skip count option 633
- insensitive cursor option 631
- insert
 - primary key 828, 839
 - row 827, 838
 - row (partition information) 555
- INSRPT primary command 912
- INTEGER data type
 - description 432
- integer data, export options 672
- interpreting errors in an Edit session 197
- IP edit prefix command 828, 839
- ISPF
 - familiarization with xiv
 - settings 65
- ISPF Settings panel, description 700

J

- JCL
 - running
 - File Manager/Db2
 - batch mode 424
- Job card specifications 63

K

- K line command
 - EXPLAIN plan table 726
 - EXPLAIN statement table 809
 - plan table rows panel 728
- Key, index and export options 628
- keys, attention interrupt 54
- keywords, syntax diagrams xv

L

- L line command
 - table edit 829, 839
- LAB line command
 - columns 492
 - tables, views and aliases 845
- label
 - editor-assigned 148
 - row 832, 842
- labeled rows
 - locating 138
- language selection, compiler language selection option 494
- large
 - numeric fields 165

- objects (LOBs) 434
 - table options 167
- large mode editor session, specifying 121
- last page, scrolling to 36
- LAST parameter, using in LOCATE command 142
- launching
 - FM/Db2
 - 27
- LC line command
 - table edit 829, 839
- LCC line command, table edit 829, 839
- LE row selection criteria operator 770
- leading zeros, showing 104
- left justify numerics, editor option 639
- LEFT primary command 912
- LHEX primary command 914
- license inquiry mcxxviii
- limiting data 144
- limiting data in editor sessions
 - excluding rows 159
 - row labels 147
- line (row selection criteria)
 - copy 768
 - delete 768
 - move 769
 - repeat 769
- line command
 - area (Object List Utility) 308
 - query (Object List Utility) 314
- Lines per page, print option 794
- LISTCAT
 - Output Display panel, description 702
- LISTDEF Options panel, description 702
- LISTDEF statement, generating in Db2 utility job 342
- listdef utility
 - options 67
- LK row selection criteria operator 771
- LOAD
 - from panel, description 704
 - generating Db2 utility 349
 - options 67
 - setting options for the current session 355
- LOAD Utility - Using Templates panel, description 708
- LOAD Utility Options panel, description 710
- LOAD Utility panel using Db2 templates panel, description 707
- LOAD Utility panel, description 706
- LOB
 - description 434
- LOBBRWS primary command 915
- LOBEDIT primary command 916
- LOBLEN primary command 917
- LOBVIEW primary command 918
- LOCATE primary command
 - description 918
 - in editor sessions 138, 138
 - Object List utility 307
- locating
 - column 139, 307
 - label (assigned to a row) 139
 - labeled row 138
 - row 138, 307
- location of a Db2 object, specifying 46
- locking
 - copy option 496
- log changes, Db2 LOAD utility option 711
- logical operators, REXX 259
- long strings

- changing 179
 - finding 143
- long-running Db2 queries, canceling 54
- LPT line command
 - application plans 464
 - packages 462
- LT 770
- LZ primary command
 - SEE LZERO primary command
- LZERO primary command 923

M

- edit prefix command 829, 840
- line command
 - application plans 464
 - EXPLAIN plan table 726
 - EXPLAIN statement table 809
 - row selection criteria 769
- Manage Db2 Privileges panel
 - description 712
 - using 333
- mapping
 - automatically by
 - FM/Db2
 - 110
 - contiguous columns 115
 - data using templates 109
 - specifying 110
 - templates, where you can use 109
- maximum discards, Db2 LOAD utility option 711
- maximum return code, compiling a COBOL copybook 786
- maximum return code, compiling a PL/I copybook 792
- member name
 - PDS, specifying on panel 50
 - specifying on panel 50
- mixed DBCS data, Db2 LOAD utility option 711
- MM line command
 - row selection criteria 769
 - table edit 829, 840
- MOD, print option 793
- mode of editor session, specifying 121
- model table, using for Create Table utility 222
- move
 - line (row selection criteria) 769
 - row 829, 840

N

- name of a Db2 object, specifying 48
- national characters xiv
- Native unicode processing, option 498, 666
- NBT row selection criteria operator 771
- NCONTAIN external function 269
- NE row selection criteria operator 770
- NEW primary command 923
- NEWS primary command 923
- NEXT
 - parameter, using in LOCATE command 141
 - primary command 923
- NEXTRPT primary command 924
- NIN row selection criteria operator 771
- NL row selection criteria operator 771
- NLK row selection criteria operator 771
- NNL row selection criteria operator 771
- no with clause option 654
- NOALIGN processing option 787
- non-Db2 data, using templates with 75
- non-excluded rows, sorting in editor session 161

- non-updateable columns, edit 186
- normal mode editor session, specifying 121
- NR row selection criteria operator 771
- null column input indicator
 - exporting in data 296
 - option 648
- nullable columns, exporting data containing 296
- nulls and default values, create table option 226
- number of index keys, Db2 LOAD utility option 711
- numeric
 - column, finding 148
 - columns (Object List Utility) 303
 - fields, large 165
- NUMERIC data type, description 432
- numerics, left justify
 - table display format 639

O

- O line command
 - schemas 780
- O prefix command 829
- object
 - name, specifying on panel 45
- Object List (option 3.4) 297
 - description 297
 - filter line 303
 - finding string 308
 - GEN line command 317
 - limiting data displayed 302
 - line command
 - area 308
 - query 314
 - locating a row or column 307
 - operator line 303
 - primary commands
 - FIND 308
 - LOCATE 307
 - SORT 316
 - reverse engineering 317
 - ROW line command 315
 - sort
 - multiple columns 317
 - one column 317
 - valid commands 314
 - working with object list panels 301
- Object List Line Commands panel, description 714
- Object List Options 66
- Object List Utility panel, description 719
- Objects (option 3.2), description 203
- OLD, print option 793
- On prefix command 829
- only commit when no save errors option 650
- OO prefix command 830
- operator line, object lists 303
- operators, row selection criteria, list of 770
- optimization options, SQL 166
- Optimization, large table and data sampling options 628, 629
- option panels 60
- option utility
 - options 68
- options
 - create table 225
 - create table option 227
 - export, setting 277
 - FM/Db2
 - editor, setting

- 123
- menu 436
 - selecting on
- FM/Db2
- panels
- 44
- OPTIONS Options panel, description 721
- OR row selection criteria connector 769
- ORDER primary command 924
- Output class, print option 794
- output data set allocation, option 65
- output destination, print option 792
- Output destination, print option 792
- output width, changing 103, 103
- overlapping rows 829
- overview
 - FM/Db2
 - functions
 - 22
 - templates 22, 72
- owner of a Db2 object, specifying 47

P

- P line command
 - application plans 464
 - collections 472
 - columns 492
 - databases 594
 - distinct types 621
 - EXPLAIN plan table 726
 - EXPLAIN statement table 809
 - functions 686
 - packages 462
 - schemas 780
 - storage groups 811
 - stored procedures 814
 - table
 - edit 830, 840
 - spaces 836
 - tables, views and aliases 845
- PA line command
 - tables, views and aliases 845
- Package Dependencies panel, description 724
- Package Details panel, description as a details panel 619
- Package List panel, description 724
- Package Privilege Details panel, description as a privilege details panel 736
- Package Privileges panel, description as a privileges panel 736
- Page skip, print option 793
- pages, scrolling to
 - first 36
 - last 36
- panel
 - body 38
 - record count 37
 - title 37
- panels
 - Column Selection/Edit 82, 82, 83, 96, 96
 - Export Options (1 of 3) panel, description 665
 - Export Options (2 of 3) panel, description 668
 - Export Options (3 of 3) panel, description 671
 - FM/Db2
 - Object List Options (1 of 2) panel, description
 - 714
 - FM/Db2
- Object List Options (2 of 2) panel, description
 - 718
 - FM/Db2
 - System Options (1 of 4) panel, description 817
 - FM/Db2
 - System Options (2 of 4) panel, description 819
 - FM/Db2
 - System Options (3 of 4) panel, description 821
 - FM/Db2
 - System Options (4 of 4) panel, description 823
 - ISPF Settings panel 799
 - privileges, managing 332
 - selecting options 44
 - working with 37
- PAR line command
 - tables, views and aliases 845
- Parents of Table panel, description 724
- PARAM line command
 - functions 686
 - stored procedures 814
- Partition Values Option 233
- Partitioned Table Statistics panel, description 724
- patterns, using in
 - FM/Db2
- entry fields
 - 49
- PB primary command
 - description 925
 - using 326
- percentage (%)
 - filtering object lists 303
 - using in
 - FM/Db2
 - entry fields
 - 49
- performance
 - general tips 954
- PK line command
 - tables, views and aliases 845
- PKG line command
 - application plans 464
 - collections 472
 - functions 686
 - indexes 699
 - stored procedures 814
 - tables, views and aliases 845
 - triggers 854
- PKL line command
 - application plans 464
 - collections 472
 - packages 462
- PL line command
 - collections 472
 - DBRMs 592
 - indexes 699
 - packages 462
 - tables, views and aliases 846
- PL/I
 - compiler
 - language selection option 494
 - options 791
 - return code, maximum allowable 792
 - specifications 64
 - data description support
 - REFER 79

- VARYING 79
- VARYINGZ 79
- Data description support not supported 79
- DECLARE statements 76
- placement, export options 668
- Plan Dependencies panel, description 724
- Plan Enabled/Disabled Connections panel, description 725
- PLAN primary command 926
- Plan Table Rows panel, description 725
- populating a Db2 table with data 239
- positioning prefix area 162
- PR line command
 - tables, views and aliases 846
- predicate
 - specifying 386
- prefix
 - area
 - listing valid commands 162
 - using commands in 182
 - commands
 - list of 826, 837
 - listing valid 162
 - row selection criteria, list of 768
 - using 182
 - prefix area
 - setting position 162
 - prefix area option 636
 - prefix commands
 - O 829
 - On 829
 - OO 830
 - prefix length option 636
 - PREFIX primary command 162, 183, 926
 - preformat unused pages, Db2 LOAD utility option 710
 - prerequisite information, for FM/Db2
 - xv
 - Preserve copybook library option 494
 - PREV parameter, using in LOCATE command 141
 - PREVIOUS primary command 927
 - PREVRPT primary command 928
 - primary commands
 - ABOUT 870
 - ALL (SQL prototyping) 870
 - BACKWARD 36, 36, 871
 - BOTTOM 36, 872
 - BROWSE 872
 - CANCEL 873
 - CAPS 874
 - CAPS (editing) 185
 - CASE 875
 - CASE (editing) 185
 - CHANGE 875
 - CHARPOS 881
 - COL 880
 - DELCOL 882
 - DELETE 882
 - DESCRIBE 884
 - DESELECT 884
 - DOWN 36, 885
 - EDIT 886
 - EDITCOL 887
 - END 888
 - EXCLUDE 888
 - EXECUTE 893
 - EXPAND 893
 - EXPLAIN 894

- EXPLAIN plan table
 - D 725
 - DK 725
 - DP 726
 - DQ 726
 - FR 726
 - I 726
 - IH 726
 - K 726
 - M 726
 - P 726
 - SR 726
 - T 726
 - UH 726
 - X 726
- EXPLAIN statement table
 - DK 808
 - DP 808
 - DQ 808
 - I 809
 - K 809
 - M 809
 - P 809
- EXPORT 894
- FILE 897
- FIND 897
- FMAP 903
- FORMAT 904
- FORWARD 36, 36, 904
- FREE 906
- FS 907
- FT 907
- HEX 908
- HIDE 909
- HINT 910
- HOLD 910
- INDEXINF 911
- INSRPT 912
- LEFT 912
- LHEX 914
- LOBBRWS 915
- LOBEDIT 916
- LOBLEN 917
- LOBVIEW 918
- LOCATE 138, 918
- NEW 923
- NEWS 923
- NEXT 923
- NEXTRPT 924
- object list
 - sort multiple column 317
 - sort one column 317
- Object List
 - SORT 316
- ORDER 924
- PB 925
- PLAN 926
- PREFIX 926
- PREVIOUS 927
- PREVRPT 928
- PRINT 928
- PROTOCOL 929
- PURGE 929
- QUIT
 - see CANCEL primary command
- RCHANGE 930
- RD 930
- REDIT 931
- REFRESH 932
- REFS 932
- RESET 932

- RESET (in Edit sessions) 183
- RFIND 933
- RIGHT 934
- RP 935
- RUNTEMP 936
- SAVE 937
- SAVEAS 937
- SHADOW 937
- SHOW 34, 938, 939
- SHOWCOB 940
- SORT 941
- SORT (Object List) 316
- SQL 942
- SQLID 943
- SSID 32
- TEDIT 149, 943
- TOP 36, 944
- TP 944
- TYPE 944
- UNDO 945
- UP 36
- VER 947
- VIEW 947
- WIDTH 948
- XMLBRWS 949
- XMLEDIT 950
- XMLEN 951
- XMLVIEW 952
- ZOOM 155, 952
- primary key
 - insert 828, 839
- Primary Key for Table panel, description 728
- Primary Option Menu
 - Create (option 3.8) 239
 - panel description 728
 - Set Processing Options (option 0) 60
 - Settings (option 0) 795, 799
 - SQL prototyping, execution and analysis (option 4) 382
 - Start Db2 Interactive (option 5) 430, 430
 - Utilities (option 3.9) 339
- PRINT
 - external function 269
 - primary command 928
 - Print (option 3.1) 321, 324
 - Print Audit Trail panel, description 729
 - Print Browse (option 3.11)
 - description 326
 - primary commands
 - FIND 897
 - LOCATE 918
 - PRINT 928
 - PURGE 929
 - Print settings 62
 - Print utility options 66
 - Print Utility Options panel, description 731
 - Print Utility panel, description 733
- printing
 - audit trail report 328
 - contents of a Db2 table 321
 - looking at the output 326
 - rows from a Db2 table 324
 - template 75
- privilege, for object, revoking
 - list of panels 736
- privileges
 - description 736
 - display panels, format 736
 - displaying 334
 - functions 332
 - grant panels, format 690

- granting 335
- panels, list of 736
- revoke panels, format 767
- revoking 337
- using the Manage Db2 Privileges panel 333
- Privileges (option 3.5) 332
 - description 332
- Procedure Details panel, description as a details panel 619
- procedure exits, create table option 230
- Process menu 436
- processing options
 - batch
 - Batch Submission Job Statement Information 784
 - COBOL
 - additional SYSLIB data sets 785
 - compiler specifications 63
 - replacing options 786
 - compiler
 - auto detect 494
 - COBOL 494, 786
 - HLASM 494
 - language selection 63, 494
 - PL/I 494, 791
 - copy
 - Copy Options panel 245
 - Delete existing rows 497
 - duplicate key processing 497
 - ignore RI/constraint errors 497
 - locking 496
 - Native unicode processing 498
 - use uncommitted read 496
 - data set allocation
 - output 65
 - temporary 64
 - Edit options 65
 - edit, create audit trail 602, 627
 - editor
 - allow updates to primary key 641
 - Auto-commit count 651
 - clustered sampling 632
 - commit when save issued 650
 - concurrency and locking 652
 - Concurrency and locking options 629
 - convert spaces to nulls 647
 - cursor stability 654
 - display prefix area 636
 - editor CAPS Setting 626
 - end of string delimiter (display) 647
 - end of string delimiter (input) 647
 - Enter key and commit processing options 629
 - include count 633
 - initial display 626
 - initial skip count 633
 - insensitive cursor type 631
 - Key, index and export options 628
 - no with clause 654
 - null column input indicator 648
 - Only commit when no save errors 650
 - Optimization, large table and data sampling options 628
 - prefix area 636
 - prefix length 636
 - random sampling 632, 633
 - read stability 655
 - read stability keep locks 655
 - remove trailing spaces 647
 - repeatable read 655
 - repeatable read keep locks 655
 - row count 596, 600, 615
 - sampling frequency 633
 - sampling seed 633
 - sampling type 631
 - scrollable cursor type 631
 - sensitive cursor type 631
 - Show end of string 646
 - show excluded shadow lines 639
 - Show export options 644
 - show foreign key 642
 - show index indicators 643
 - show prefix area on the right 637
 - show primary key 641
 - show SQLCODE 637
 - single display format options 637
 - skip count 633
 - table display format 635
 - Table/Single format, prefix area and shadow options 628
 - Use row count value 630
 - Use/Keep exclusive locks 655
 - Use/Keep share locks 655
 - Use/Keep update locks 655
 - Varying length and nullable column options 628
 - export
 - Native unicode processing 666
 - Export utility options 67
 - FM/Db2
 - system
 - Arbitrary SQL Select Statements 819
 - Display Format for DATE/TIME Columns 820
 - Encapsulation of SQL Identifiers in Double Quotes 817
 - FM/Db2
 - Object List Options (1 of 2) panel 714
 - FM/Db2
 - Object List Options (2 of 2) panel 718
 - FM/Db2
 - System Options (1 of 4) panel 817
 - FM/Db2
 - System Options (2 of 4) panel 819
 - FM/Db2
 - System Options (3 of 4) panel 821
 - FM/Db2
 - System Options (4 of 4) panel 823
 - Retrieve foreign key information when building templates 821
 - Translate Db2 object names 817
 - Translate input SQL statements 817
 - Use uncommitted read when accessing the Db2 catalog 820
 - FM/Db2
 - system options
 - 63
 - global, setting for
 - FM/Db2 795
 - HLASM
 - DBCS 787
 - NOALIGN 787
 - ISPF settings 65, 799
 - Job card specifications 63
 - listdef utility options 67
 - load
 - allow substitution chars 711
 - build indexes in parallel 711
 - DBCS data 711
 - do not set COPY pending flag 711
 - Enforce constraints 711
 - log changes 711
 - maximum discards 711
 - mixed DBCS data 711
 - number of index keys 711
 - preformat unused pages 710
 - replace existing data 711
 - resume (append new data) 711
 - reuse existing data 711
 - SBCS data 711
 - use IEEE floating point 711
 - Object List Options 66
 - option utility options 68
 - PL/I
 - additional SYSLIB data sets 791
 - compiler specifications 64, 64
 - print
 - (1,*) 794
 - (n,m) 794
 - 132 793
 - 80 793
 - Data set 793
 - Data set DISP 793
 - Data set name 794
 - Lines per page 794
 - MOD 793
 - OLD 793
 - Output class 794
 - output destination 792
 - Output destination 792
 - Page skip 793
 - Record length 793
 - Record limits 794
 - REXX 793
 - SYSPRINT 792
 - Terminal 792
 - Translate non-printable chars 794
 - Uppercase message text 794
 - Wide print 794
 - Print Processing Options 66, 66, 67
 - Print settings 62
 - setting default 60
 - system options 62
 - template utility options 68
 - trace options 65
 - unload utility options 68
 - utilities 66
 - View options 65
 - Program Directory mcxxvii
 - PROTOCOL primary command 929
 - prototyping, primary commands
 - ALL 870
 - CANCEL 873
 - DESELECT 884
 - EXECUTE 893
 - INSRPT 912
 - NEXTRPT 924
 - PREVRPT 928
 - RESET 932
 - SQL 942
 - UNDO 945
 - PRTCOUNT external function 270
 - PS line command
 - distinct types 621
 - functions 686
 - stored procedures 814

- triggers 854
- PT line command
 - indexes 699
 - storage groups 811
 - table spaces 836
- PTF level, displaying
- FM/Db2
 - 28
- pull-down menus action bar 37
- PURGE primary command 929

Q

- QUIT primary command
- SEE CANCEL primary command

R

- R
 - edit prefix command 830, 840
 - line command
 - application plans 464
 - collections 472
 - databases 594
 - distinct types 621
 - functions 686
 - packages 462
 - row selection criteria 769
 - schemas 780
 - stored procedures 814
 - table spaces 836
 - tables, views and aliases 846
 - xxx 464
 - table space partition prefix command 555
- R line command
 - storage group usage privileges 813
- random data sampling 169
- random sampling option 632, 633
- RBI line command
 - application plans 464
 - packages 462
- RCHANGE primary command 930
- RD primary command 930
- RDT line command
 - functions 686
- RE edit prefix command 830, 840
- read
 - stability keeplocks option 655
 - stability option 655
- read-only views 186
- REAL data type, description 432
- REBUILD (Indexes for Table Spaces) panel, description 741
- REBUILD (Indexes for Table Spaces) with LISTDEF panel, description 743
- REBUILD (Indexes) with LISTDEF panel, description 747
- REBUILD Utility (Indexes) panel, description 745
- REBUILD, generating Db2 utility 357
- Record length, print option 793
- Record limits, print option 794
- RECOVER Utility (Index Spaces) panel, description 748
- RECOVER Utility (Index Spaces) with LISTDEF panel, description 750
- RECOVER Utility (Table Spaces) panel, description 751
- RECOVER Utility (Table Spaces) with LISTDEF panel, description 753
- RECOVER, generating Db2 utility 360
- Recovery Information panel, description 755
- RECSIN external function 270
- RECSOUT external function 270

- REDIT primary command 931
- REFER 79
- referential constraints
 - create table option 227
- REFRESH primary command 932
- REFS primary command 932
- related
 - information, for
 - FM/Db2
 - xv
 - table, edit 830, 840
 - tables, listing 189
- Related tables panel, description 755
- release, displaying
- FM/Db2
 - 28
- Remote Db2 Location Selection panel, description 759
- remove trailing spaces option 647
- REORG Utility (Indexes) panel, description 760
- REORG Utility (Indexes) with LISTDEF panel, description 761
- REORG Utility (Table Spaces) panel, description 763
- REORG Utility (Table Spaces) with LISTDEF panel, description 765
- REORG, generating Db2 utility 363
- repeat
 - line (row selection criteria) 769
 - row 830, 840
 - row (partition information) 555
- repeatable
 - read keep locks option 655
 - read option 655
- repeatable items, syntax diagrams xv
- repeating a search for a string 143
- replace existing data, Db2 LOAD utility option 711
- RESET primary command
 - description 932
 - in editor sessions 183
- resume (append new data), Db2 LOAD utility option 711
- Retrieve foreign key information when building templates processing option 821
- retrieve row from clipboard 827, 838
- return code, maximum when compiling a COBOL copybook 786
- return code, maximum when compiling a PL/I copybook 792
- RETURN instruction, return values
 - DROP 273
 - STOP 274
 - STOP IMMEDIATE 274
- RETURN statement 262
- reuse existing data, Db2 LOAD utility option 711
- reverse engineering
 - description 317
 - GEN line command 317
 - list of objects 317
 - performance tips 319
- Revoke Application Plan Privileges panel, description as a grant privileges panel 766
- Revoke Buffer Pool Privileges panel, description as a grant privileges panel 766
- Revoke Collection Privileges panel, description as a grant privileges panel 766
- Revoke Column Privileges panel, description as a grant privileges panel 766

- Revoke Database Privileges panel, description as a grant privileges panel 766
- Revoke Distinct Type Privileges panel, description as a grant privileges panel 766
- Revoke Function Privileges panel, description as a grant privileges panel 766
- Revoke Package Privileges panel, description as a grant privileges panel 766
- revoke privileges panels
 - description 766
 - list of 766
- Revoke Schema Privileges panel, description as a grant privileges panel 766
- Revoke Sequence Privileges panel, description as a grant privileges panel 767
- Revoke Storage Group Privileges panel, description as a grant privileges panel 767
- Revoke Stored Procedure Privileges panel, description as a grant privileges panel 767
- Revoke System Privileges panel, description as a grant privileges panel 767
- Revoke Table Privileges panel, description as a grant privileges panel 767
- Revoke Table Space Use Privileges panel, description as a grant privileges panel 767
- revoking
 - privileges 337
- REXX
 - arithmetic operators 258
 - boolean operators 259
 - built-in functions 260
 - comparison operators 255
 - converting Db2 null indicator 296
 - expressions 253
 - functions, built-in 260
 - general information 253
 - logical operators 259
 - procedures, using with Import, description 263, 274
 - using procedure in Import (option 3.6) 252
 - variables
 - INREC 264
 - OUTREC 264
- REXX, print option 793
- RFIND primary command 933
- RG row selection criteria operator 771
- RIGHT primary command 934
- Routine Parameters panel, description 767
- row
 - convert to
 - lowercase 829, 839
 - uppercase 831, 841
 - copy 827, 837
 - count, option 596, 600, 615
 - delete 827, 837
 - delete (partition information) 555
 - display excluded 827, 838
 - exclude from display 831, 841
 - get from clipboard 827, 838
 - insert 827, 838
 - insert (partition information) 555
 - label 832, 842
 - labels 147
 - move 829, 840
 - overlying 829
 - repeat 830, 840
 - repeat (partition information) 555
 - retrieve from clipboard 827, 838
 - save to clipboard 831, 841
- ROW line command
 - application plans 464

- collections 472
- columns 492
- databases 594
- DBRMs 592
- distinct types 621
- functions 686
- indexes 699
- Object List (option 3.4) 315
- packages 462
- schemas 780
- sequences 783
- storage group storage group usage
- privileges 813, 869
- storage groups 811
- stored procedures 814
- synonyms 816
- table spaces 836
- tables, views and aliases 846
- triggers 854
- row selection criteria
 - connectors, list of 769
 - information stored in templates 73
 - operators, list of 770
 - prefix commands, list of 768
- Row Selection Criteria panel, description 767
- ROWID data type, description 433
- rows
 - printing 324
 - scrolling to specified number 138
 - selecting
 - for display 83
 - to view in editor session 136
 - using to limit data displayed 147, 159
- RP primary command 935
- RR
 - edit prefix command 830, 841
 - line command, row selection criteria 769
- rules, column mapping 115
- running
 - File Manager/Db2
 - batch mode 424
 - RUNSTATS Utility (Indexes) panel, description 772
 - RUNSTATS Utility (Indexes) with LISTDEF panel, description 774
 - RUNSTATS Utility (Table Spaces) panel, description 775
 - RUNSTATS Utility (Table Spaces) with LISTDEF panel, description 777
 - RUNSTATS, generating Db2 utility 368
 - RUNTEMP primary command 936

S

- S
 - edit prefix command 831, 841
 - line command
 - application plans 464
 - databases 594
 - packages 462
 - storage groups 811
 - tables, views and aliases 846
 - SAF-rule controlled auditing
 - Create audit trail option
 - Copy Utility (From) panel 501
 - Data Create Utility panel 590
 - Db2 Edit panel 602
 - Db2 View panel 617
 - Edit/Execute SQL (Data Set) panel 625
 - Editor Options (1 of 8) panel 627
 - Enter, Execute and Explain SQL panel 661
 - Export Utility panel 675
 - Import (To) panel 696
 - Print Utility panel 735
 - specifying Db2 object 134
 - description 69
 - sampling data
 - clustered 167
 - random 169
 - sampling frequency option 633
 - sampling seed option 633
 - sampling type option 631
 - SAVE primary command 937
 - save row to clipboard 831, 841
 - SAVEAS primary command 937
 - saving changes, editor session 124
 - SBCS data, Db2 LOAD utility option 711
 - SCH line command
 - distinct types 621
 - functions 686
 - stored procedures 815
 - triggers 854
 - Schema Privilege Details panel, description as a privilege details panel 736
 - Schema Privileges panel, description as a privileges panel 736
 - Schemas panel, description 779
 - scramble
 - options
 - range values, specifying 108
 - scramble type, specifying 105
 - value columns, specifying 107
 - value data set name, specifying 108
 - value list 108
 - value option, specifying 106
 - scrambling data
 - copy, import, export 286
 - scrollable cursor type option 631
 - scrolling 97, 157
 - in panels 36, 36
 - to first page 36
 - to labeled row 138
 - to last page 36
 - to specified column 138
 - to specified row 138
 - search
 - direction, LOCATE primary command 141
 - SEL line command
 - tables, views and aliases 846
 - Select Statement Browse panel, description 782
 - Select Statement Edit panel, description 782
 - selecting
 - column for attribute change 101
 - options on
 - FM/Db2
 - panels
 - 44
 - rows 136
 - selecting a column for specifying scrambling options 105
 - self-referencing constraint 190, 193
 - sensitive cursor option 631
 - sequence of data, changing 98
 - Sequences panel, description 782, 782
 - session, starting another 132
 - Set Batch Job Card Information panel, description 784
 - Set COBOL Processing Options panel, description 785
 - Set PL/I Processing Options panel, description 790

- Set Print Processing Options panel, description 792
- Set Processing Options
 - HLASM Processing Options 787
- Set Processing Options panel, description 795
- Set System Processing Options panel, description 797
- Set Utility Processing Options panel, description 803
- Settings (option 0), description 795
- shadow lines
 - assigning labels to 832, 842
 - hiding or showing 937
- SHADOW primary command 937
- show
 - column number option
 - single display format 637, 638
 - table display format 636
 - data type option 635
 - end of string option 646
 - foreign key option 642
 - index indicators option 643
 - keys, indexes 638
 - primary key option 641
 - scale line option 635
 - table display format 635
- show excluded shadow lines option 639
- Show export options panel option 644
- show prefix area on the right option 637
- SHOW primary command 34, 938, 939
- show SQLCODE option 637
- SHOWCOB primary command
 - description 940
 - using 29
- showing
 - leading zeros 104
- single display format
 - description 152
 - options 637
- skip count option 633
- SMALLINT data type, description 432
- Sn edit prefix command 831, 841
- SNGL display format
 - SEØ single display format
- Sort Fields panel, description 804
- SORT primary command
 - application plans 464
 - collections 472
 - columns 492
 - databases 594
 - DBRMs 592
 - distinct types 621
 - functions 686
 - indexes 699
 - packages 462
 - schemas 780
 - stored procedures 815
 - synonyms 816
 - table spaces 836
 - tables, views, and aliases 846
 - triggers 854
 - view or edit 941
- sorting
 - data 161
 - displayed data (Object List) 316
- SQL
 - errors 419
 - keywords 205
 - line command
 - application plans 464
 - collections 472

- packages 462
- triggers 854
- optimization options 166
- primary command 942
- prototyping, execution and analysis (option 4) 382
- prototyping, execution and analysis (option 4), description 382
- Prototyping, Execution and Analysis panel, description 806
- statements
 - working with 382
- SQL prototyping
 - basic 382
- SQLID
 - primary command 943
 - specifying 50
- SR line command
 - EXPLAIN plan table 726
 - plan table rows panel 728
- SS line command
 - table edit 831, 841
- SSID command, changing Db2 subsystem 32
- Start Db2 Interactive (option 5), description 430
- start position for editor session, specifying 123
- starting
 - FM/Db2
 - editor session
 - 120
 - point, LOCATE primary command 141
 - starting another session
 - FM/Db2
 - editor
 - 132
- statement continuation 424
- Statement Table Rows panel, description 808
- STOP IMMEDIATE, RETURN return value 274
- STOP, RETURN return value 274
- Storage Group Usage Privileges panel, description 812
- Storage Group(s) panel, description 810, 810
- Stored Procedure Privilege Details panel, description as a privilege details panel 736
- Stored Procedure Privileges panel, description as a privileges panel 736
- Stored Procedures panel, description 813
- subsystem, Db2
 - selecting 30
 - Subsystem Selection menu 33
- summary statistics 330
- suppression of leading zeros 104
- SYN line command
 - tables, views and aliases 846
- Synonym Dependencies panel, description 815
- Synonym Details panel, description as a details panel 619
- synonyms
 - panel, description 815
 - using when specifying an object 46, 48, 48, 48, 48
- syntax diagrams, how to read xv
- SYSLIB data sets
 - COBOL processing option 785
 - PL/I processing option 791
- SYSPRINT
 - REXX procedures, TALLY external function 271
- SYSPRINT, print option 792
- system options 62, 63

T

- T line command
 - application plans 464
 - columns 492
 - databases 594
 - distinct types 621
 - EXPLAIN plan table 726
 - indexes 699
 - plan table rows panel 728
 - synonyms 816
 - table spaces 836
 - tables, views and aliases 846
 - triggers 854
- TABL display format
 - SEE table display format
- table
 - display format options 635
- Table Check Constraint Dependencies panel, description 826
- Table Check Constraint Details panel, description 826
- Table Check Constraints panel, description 826
- Table Details panel, description as a details panel 618
- table display format 150
- Table Privileges panel, description as a privileges panel 736
- Table Selection panel, description 833
- table space
 - for a Db2 object, specifying 48
- Table Space Details panel, description as a details panel 618
- Table Space Parts panel, description 834
- Table Space Use Privilege Details panel, description as a privilege details panel 736
- Table Space Use Privileges panel, description as a privileges panel 736
- Table Spaces panel, description 834
- Table/Single format, prefix area and shadow options 628
- Table/View Privilege Details panel, description as a privilege details panel 736
- Table/View/Alias Selection panel, description 842
- tables
 - large, options for 167
- Tables, Views and Aliases panel, description 843
- tabular display format
 - SEE table display format
- TALLY external function 271
- TB line command 462
- TE
 - SEE TEDIT primary command
- TEDIT primary command 81, 149, 943
- template
 - creating copybook from 118
- Template Mapping panel, description 850
- TEMPLATE Options (1 of 2) panel, description 846
- TEMPLATE Options (2 of 2) panel, description 848
- Template Save panel, description 852
- template utility
 - options 68
- templates
 - adding a description 82
 - COBOL data description entries 76
 - definition 22

- editing
 - changing column headings 102
 - changing the sequence of displayed data 98
 - description 81
 - holding columns for scrolling 97
 - HLASM data description entries 76
 - how to use 72
 - information stored in 73
 - mapping
 - automatically by
 - FM/Db2
 - 110
 - data 109
 - rules (data type conversion) 115
 - specifying 110
 - where you can use 109
 - overview 22
 - PL/I DECLARE statements 76
 - printing 75
 - selecting
 - column for attribute change 101
 - columns for display 96
 - rows for display 83
 - using with non-Db2 data 75
 - where you can use 23
 - working with 72
 - temporary data set allocation, option 64
 - Terminal, print option 792
 - TIME data type, description 433
 - TM external function 272
 - TOP primary command 36, 944
 - TP primary command 944
 - TR line command
 - schemas 780
 - trace options
 - settings 65
 - Translate Db2 object names processing option 817
 - Translate input SQL statements processing option 817
 - Translate non-printable chars, print option 794
 - Trigger Details panel, description as a details panel 619
 - Triggers panel, description 853
 - TSO region size
 - minimum supported 26
 - storage considerations 135
 - viewing large tables or views 136
 - tutorial help 55
 - TYPE primary command 944
 - type, export options 669
 - types of Db2 data 432

U

- UC edit prefix command 831, 841
- UCC line command 831, 841
- UH line command (for EXPLAIN plan table) 726
- underscore (_)
 - filtering object lists 303
 - using in
 - FM/Db2
 - entry fields
 - 49
- UNDO primary command 945
- Unicode data 175
- unique constraints, create table option 227
- UNLOAD Options panel, description 854
- unload utility
 - options 68

- UNLOAD Utility (Table Spaces) panel, description 857
- UNLOAD Utility (Table Spaces) with LISTDEF panel, description 858
- UNLOAD Utility (Tables) "From" panel, description 860
- UNLOAD Utility (Tables) "To" panel, description 861
- UNLOAD Utility (Tables) with LISTDEF panel, description 863
- UNLOAD, generating Db2 utility 372
- UP primary command 36
- Uppercase message text, print option 794
- uppercase, converting data to 185
- usage, export options 668
- Use IEEE floating point, Db2 LOAD utility option 711
- Use row count value option 630
- Use uncommitted read
 - copy option 496
- Use uncommitted read when accessing the Db2 catalog processing option 820
- Use/Keep exclusive locks option 655
- Use/Keep share locks option 655
- Use/Keep update locks option 655
- using a template 23
- utilities 66
- Utilities (option 3.9)
 - description 339
 - generating a Db2 utility job 343
 - setting options 341
- Utilities menu 438
- Utility Functions menu
 - Audit trail (option 3.10) 328
 - Copy (option 3.3) 241
 - Export (option 3.7) 274, 282
 - Import (option 3.6) 246, 274
 - Object List (option 3.4) 297
 - Objects (option 3.2) 203
 - Print (option 3.1) 321, 324
 - Print Browse (option 3.11) 326, 929
 - Privileges (option 3.5) 332
- Utility Functions panel, description 864
- UTL line command
 - indexes 699
 - table spaces 836
 - tables, views and aliases 846

V

- V line command
 - application plans 464
 - packages 462
 - tables, views and aliases 846
- valid commands (Object List Utility) 314
- validating changes, editor session 124
- value list, scrambling data 108
- VARBINARY data type, description 432
- VARCHAR
 - data type
 - description 432
 - processing options 174
 - options for processing 174
- VARGRAPHIC data type, description 432
- variables, syntax diagrams xv
- VARYING 79
- Varying length and nullable column options 628
- varying-length columns, options for processing 174
- VARYINGZ 79
- VER

- line command
 - packages 462
 - primary command 28, 947
- View (option 1)
 - displaying data in hexadecimal format 162
 - limiting data displayed
 - excluding rows 159
 - scrolling 157
 - sorting data 161
 - VARCHAR, options for processing 174
 - varying-length columns, options for processing 174
 - zooming 155
- View Details panel, description as a details panel 619
- View options 65
- VIEW primary command 947
- VOL line command
 - storage groups 811
- Volumes panel, description 868
- VS line command
 - tables, views and aliases 846

W

- Wide print, print option 794
- WIDTH primary command 948
- wildcards, using in FM/Db2 entry fields 49
- working with object list panels 301
- WRITE external function 272

X

- X
 - edit prefix command 831, 841
 - line command
 - application plans 464
 - columns 492
 - databases 594
 - EXPLAIN plan table 726
 - packages 462
 - storage groups 811
 - tables, views and aliases 846
 - XC line command
 - tables, views and aliases 846
 - XMLBRWS primary command 949
 - XMLEDIT primary command 950
 - XMLLEN primary command 951
 - XMLVIEW primary command 952
 - XPT primary command
 - storage groups 811
 - XX line command 832, 841

Z

- ZCSR editor-assigned label 148
- ZFST editor-assigned label 148
- ZLST editor-assigned label 148
- Zoom function key 157
- ZOOM primary command 157, 952
- zooming 155