

**IBM File Manager for z/OS®
User's Guide and Reference
Version 14.1.20**

(Revised August 2023)

Note

Before using this document, read the general information under [Notices on page mdcccxliv](#).

Edition Notice

This edition (published August 2023) applies to Version 14 Release 1 Modification Level 20 of IBM® File Manager for z/OS® (program number 5655-Q42) and to all subsequent releases and modifications until otherwise indicated in new editions.

Contents

Edition Notice.....	iii	Editor options (option 0.6).....	82
About this document.....	xvi	VSAM edit sharing options (option 0.7).....	83
Who should use this document.....	xvii	Temporary Data Set Allocations (option 0.8).....	83
How to read syntax diagrams.....	xvii	Output Data Set Allocations (option 0.9).....	83
Summary of changes.....	xxi	Trace options (option 0.10).....	83
Part I. Working with File Manager.....	28	Displaying or editing DBCS characters.....	83
Chapter 1. File Manager overview.....	29	National characters.....	84
File Manager actions.....	29	SAF-rule controlled auditing.....	85
Data sets and records.....	30	SAF rules for auditing.....	85
Templates.....	31	SAF-rule controlled auditing not in effect.....	85
Why use a template?.....	31	SAF-rule controlled auditing in effect, auditing possible.....	86
What can you do with a template?.....	33	Chapter 3. Viewing and changing data sets.....	87
Where can you use templates?.....	34	Starting and ending editor sessions.....	89
Chapter 2. Getting started with File Manager.....	36	Starting an editor session without using templates.....	89
Starting and exiting File Manager.....	36	Starting an editor session with a template.....	91
Starting File Manager.....	36	Viewing and changing packed data.....	95
Checking your File Manager version.....	37	Listing statistics for the current editor session.....	96
Checking which COBOL compiler you're using.....	39	Displaying your current editor options.....	98
Exiting from File Manager.....	39	Ending an editor session.....	98
Invoking File Manager panels from outside File Manager.....	39	Displaying the RBA and record length information.....	99
Using the File Manager interface.....	40	Managing the prefix area.....	101
Navigating in File Manager.....	40	Manipulating your view of the data.....	103
Issuing commands.....	42	Using primary commands in an editor session.....	103
Specifying quoted strings.....	42	Selecting a display format.....	105
Specifying a data set and a member name.....	42	Displaying a column identification line.....	110
Specifying an MQ manager or queue.....	48	Zooming in to see all of a record.....	112
Specifying a CICS® resource.....	48	Displaying the record length.....	114
Accessing CICS® resources.....	50	Scrolling to see data.....	117
Specifying a remote resource.....	56	Scrollable input and display fields for long names.....	122
Accessing remote resources.....	56	Sorting the data.....	123
Manipulating your view of selection lists.....	62	Finding specific data.....	125
Selecting a range of PDS(E) members.....	70	Excluding records from display.....	129
Using hexadecimal values in File Manager.....	73	Using Date/Time fields.....	131
Getting help.....	74	Working with File Manager and shared files.....	132
Displaying field help information.....	74	Overview of shared file features.....	132
Accessing Tutorial Help.....	75	What File Manager considers a shared file.....	133
Viewing error messages.....	77	Record integrity checking.....	133
Setting your default processing options.....	78	Refreshing the contents of a record.....	137
Set print processing options (option 0.1).....	80	Editing techniques.....	141
Setting your System Processing Options (option 0.2).....	80	In-place-in-memory edit.....	142
Set tape processing options (option 0.3).....	82	In-place edit.....	142
Set batch job card information (option 0.4).....	82	In-memory edit.....	142
Language and compiler specifications (option 0.5).....	82		

Auxiliary edit.....	143	Specifying or updating the source definition for a copybook template.....	207
KSDS edit.....	144	Advanced copybook selection.....	208
Editing large files.....	144	Creating a copybook template with the Template Workbench.....	211
Editing load modules.....	145	Setting up a template to be used with segmented data.....	212
Changing data.....	145	Creating a template from a model template.....	213
Changing data in individual records.....	145	Creating dynamic templates.....	214
Change data in multiple records.....	146	Creating corresponding templates from selected copybooks.....	217
Locating labeled records.....	147	Editing a template.....	218
Changing the case of data.....	147	Updating one or more templates.....	224
Finding and replacing strings.....	149	Manipulating the display of fields in records.....	225
Changing invalid numeric fields in your data.....	153	Selecting and deselecting fields.....	226
Limiting the effect of editing changes.....	154	Changing the field display order.....	227
Setting bounds.....	154	Changing field headings.....	228
Setting column ranges.....	155	Changing field attributes.....	229
Limiting the search to specified fields.....	156	Displaying alphanumeric fields in long hexadecimal.....	230
Excluding records.....	158	Defining and changing date and time attributes.....	231
Labelling record ranges.....	159	Managing templates with the Template Workbench.....	233
Editing records within data sets.....	161	Editing a template (E).....	233
Inserting records.....	162	Editing related ID criteria.....	233
Deleting records.....	162	Updating a template from a copybook (U).....	242
Recovering deleted records.....	163	Running a function using a copybook or template (RC or RT).....	243
Moving records.....	164	Mapping fields (MC or MT).....	244
Copying and repeating records.....	164	Generating and editing field mapping (GM, GE and EM).....	245
Overlaying data in existing records.....	165	Mapping contiguous fields.....	245
Copying data to and from a clipboard.....	167	Specifying scrambling options.....	245
Copying data from another data set.....	169	Selecting a field for specifying scrambling options.....	246
Splitting and joining lines.....	170	Specifying scrambling options for date and time fields.....	250
Changing the length of a record.....	171	Mapping fields between templates.....	251
Chapter 4. Creating and editing templates.....	173	Default field mapping.....	251
Template types and structure.....	173	Editing the field mapping.....	254
Information stored in a template.....	173	Field mapping rules.....	259
About copybook templates.....	175	Copybook View and Print Utility.....	260
Segmented data templates.....	177	XML templates.....	261
Mapping SMF data with segmented templates.....	179	Sample XML for BASE template.....	263
About dynamic templates.....	180	Sample XML for IMS™ template.....	263
Data description support.....	180	Sample XML for Db2® template.....	264
Using HLASM copybooks with File Manager.....	184	Using the foreground interface to export XML templates.....	264
Template repository.....	186	Using the foreground interface to import XML templates.....	266
Specifying the repository data set name.....	186	Examples of the batch interface.....	267
Using a mandatory repository.....	187		
Telling File Manager to use the repository template name.....	187		
Template repository edit.....	188		
Template repository utilities.....	193		
Managing templates.....	199		
Setting your template processing options.....	200		

Chapter 5. Working with the Template List.....	271		
How to produce a Template List.....	271		
Keyword invocation from REXX.....	271		
Setting up ISPF commands to invoke the Template List.....	273		
Setting up a REXX exec to invoke the Template List from an ISPF 3.4 data set display.....	274		
Template List Entry panel.....	275		
Template Member List panel.....	276		
Customizing and sorting columns.....	276		
Field descriptions.....	277		
Primary commands.....	277		
Prefix commands.....	278		
Column descriptions.....	280		
Chapter 6. Filtering records with templates.....	284		
Selecting records with templates.....	284		
Selecting records by record type.....	284		
Specifying record identification criteria.....	285		
Specifying record selection criteria.....	287		
Specifying offset values.....	288		
Defining criteria expressions.....	289		
Entering criteria as a freeform expression.....	289		
Entering criteria by field.....	291		
About expression processing.....	295		
Examples of REXX comparison expressions.....	308		
Filtering record display using templates.....	309		
Displaying "suppressed" records.....	309		
Changing display of the record type.....	310		
Displaying "not-selected" records.....	311		
Hiding or showing records in SNGL display format.....	313		
Using the SHOW command in an editor session.....	314		
Viewing segmented data.....	314		
Adjusting your view to allow for header information.....	316		
Chapter 7. Managing data sets.....	320		
Working with data set lists.....	320		
Accessing data set lists.....	321		
Managing personal data set lists.....	322		
Retrieving details from a data set list.....	326		
Allocating program function keys.....	327		
Creating data sets and records.....	328		
Creating data without using a template.....	328		
Creating data sets using a template.....	330		
Allocating a new data set.....	332		
Setting the Data Create Attributes in your template.....	333		
Creating, replacing, and adding data using existing data.....	333		
		Creating a new member or data set using data from an edit session.....	334
		Replacing a member or data set using data from an edit session.....	336
		Adding data to a data set using data from an edit session.....	338
		Using all the data from an edit session to create a new member or data set.....	339
	Copying data sets.....		341
	Copying without a template.....		342
	Renaming members as you copy.....		346
	Copying with a copybook or template.....		347
	Scrambling data.....		350
	Copying records with segmented data templates.....		351
	Generating data in external format - XML representation.....		353
	Copying files or members containing JCL.....		356
	Using a DFSORT or REXX procedure.....		356
	REXX member selection.....		358
	Cloning data sets.....		360
	Define the CLONE command without LIBDEFs.....		360
	Define the CLONE command with LIBDEFs.....		360
	Clone Data Sets panel.....		361
	Clone Member List panel.....		366
	Review Clone List panel.....		367
	Finding and changing data in multiple PDS members.....		368
	Building your member list for processing.....		369
	Refining the list of selected members.....		370
	Specifying where your results are stored.....		372
	Specifying your processing options.....		372
	Specifying multiple arguments for FIND.....		374
	Using the CHANGE command in the Find/Change Utility.....		375
	Specifying context in the output listing.....		376
	Changing data with a REXX procedure.....		377
	Working with files or members containing JCL.....		378
	Comparing data sets.....		381
	Comparing data sets without using a template.....		382
	Comparing data sets using templates.....		384
	Record synchronization.....		389
	Creating key sequencing for use in a multi-segment key.....		392
	Comparison output.....		393
	Formatted comparison of unlike fields.....		399
	Comparing load modules.....		400
	Printing from File Manager.....		402
	Setting your Print Processing Options.....		403

Printing data sets.....	404	RUN.....	457
Using a DFSORT or REXX procedure.....	407	TOF.....	457
REXX member selection.....	408	ZOOM.....	457
Printing DBCS data.....	410	Tape Browse (option 4.1).....	458
Printing a single record.....	411	Tape Data Copy Function (option 4.2).....	458
Printing your Audit Trail Report.....	413	Tape to Tape (option 4.2.1).....	459
Chapter 8. Using File Manager utilities.....	415	Tape to Tape Reblocked (option 4.2.2).....	459
Managing catalog entries.....	415	Tape to Labeled Tape (option 4.2.3).....	459
Available catalog services.....	415	Tape to VSAM (option 4.2.4).....	460
Selecting your service.....	416	Tape to Sequential Data (option 4.2.5).....	461
Working with a list of catalog entries.....	418	VSAM to Tape (option 4.2.6).....	461
Viewing your Catalog Entry Details.....	422	Sequential Data to Tape (option 4.2.7).....	461
Defining a new Catalog Entry.....	426	Exported Stacked Volume Copy (option	
Changing an existing Catalog Entry.....	429	4.2.8).....	462
Deleting a catalog entry.....	430	Copying tape data across a network.....	463
Recalling catalog entries.....	431	Tape Update (option 4.3).....	464
Displaying a Volume Table of Contents (VTOC).....	432	Special considerations.....	465
Using line commands with Work with VTOC.....	436	Tape Record Load (option 4.4).....	466
Browsing AFP Print documents.....	437	Tape Print (option 4.5).....	466
AFP Print Browse primary commands.....	437	Controlling print output.....	467
Browsing your user storage.....	437	Tape Map (option 4.6).....	468
Memory Browse primary commands.....	438	Create Tape Data (option 4.7).....	469
Viewing load module information.....	438	Tape Label Display (option 4.8).....	469
Working with WebSphere® MQ.....	439	Tape to Tape Compare (option 4.9).....	471
Chapter 9. Tape Specific Functions.....	445	Tape Record Scan (option 4.10).....	471
Specifying tape input or output.....	445	Write Tape Mark (option 4.11).....	473
Tape density and mode values.....	449	Initialize Tape (option 4.12).....	473
Tape block size considerations.....	450	Erase Tape (option 4.13).....	474
Specifying the number of tape files to process.....	450	Exported Stacked Volume List (option 4.14).....	475
Processing tapes with data-check errors.....	451	Tape Positioning Functions (option 4.15).....	476
ASCII translation.....	451	Chapter 10. Disk/VSAM Data Functions.....	477
Exported Stacked Volumes (ESVs).....	452	Processing disk records.....	477
Requirements for Exported Stacked Volumes....	452	Specifying disk input and output.....	477
ESV options.....	452	Specifying disk extents.....	477
Using primary commands with Tape Specific		Disk Browse (option 5.1).....	477
Functions.....	453	Disk Browse primary commands.....	477
BID.....	454	Disk Track Edit (option 5.2).....	478
BSF.....	454	Disk Track Edit primary commands.....	479
BSR.....	455	Disk Print (option 5.3).....	485
COPY.....	455	Specifying what you want to print.....	485
FIND.....	455	Controlling print output.....	486
FSF.....	456	Disk Record Scan (option 5.4).....	486
FSR.....	456	Write EOF Record (option 5.5).....	487
LOCATE.....	456	Data Set Extents (option 5.6).....	487
RD.....	457	VSAM Update (option 5.7).....	488
REW.....	457	Data in Virtual (option 5.8).....	489
RFIND.....	457	Chapter 11. OAM Functions.....	490
RP.....	457	Introducing the Object Access Method.....	490

Object Directory List (option 6.1).....	490	Why enhance File Manager processing?.....	517
Object Browse (option 6.2).....	492	Which tasks can be enhanced.....	517
Object Print (option 6.3).....	492	Choosing the right function to enhance.....	517
Controlling print output.....	492	Creating and supplying a procedure.....	519
Object Update (option 6.4).....	493	Procedure statement types.....	520
Object Erase (option 6.5).....	493	Choosing between FASTREXX, REXX, and DFSORT for your procedure.....	521
Object Copy Functions (option 6.6).....	493	Coding DFSORT procedure statements.....	522
Backing up OAM objects.....	494	Coding REXX procedure statements.....	523
Object to VSAM (option 6.6.1).....	494	Coding end of file procedure.....	529
Object to Sequential Data (option 6.6.2).....	494	Combining DFSORT and REXX statements in a procedure.....	529
VSAM to Object (6.6.3).....	494	Supplying a procedure to enhance File Manager processing.....	530
Sequential Data to Object (option 6.6.4).....	494	How enhanced processing works.....	533
Object to Object (option 6.6.5).....	494	How REXX-enhanced processing works.....	533
Backing up a single OAM object.....	494	How DFSORT-enhanced processing works.....	534
Backing up many OAM objects.....	495	Enhanced processing modes.....	534
Restoring OAM objects.....	495	Using templates with enhanced processing.....	536
Restoring an object that was backed up individually.....	495	Working with an entire data set (DSEB only) or per record.....	537
Restoring one or more objects from a multiple- object backup.....	496	Dropping a record from further processing.....	537
Chapter 12. Using UNIX™ System Services and the Hierarchical File System.....	497	Performance tips.....	537
Specifying an HFS file.....	497	REXX and DFSORT Examples.....	538
Using directories.....	498	Printing data.....	538
Selecting files for processing.....	498	Copying data.....	539
Logical record length.....	499	Updating records in a data set.....	539
Processing an HFS file.....	499	Editing a data set.....	540
Viewing and editing HFS files.....	499	Examples of tasks that can be performed easily using FASTREXX.....	540
Creating HFS files.....	500	Record Editing.....	540
Copying HFS files.....	500	Splitting an input file into multiple output files based on record data.....	541
Comparing HFS files.....	501	Either copying or printing a member based on some condition inside the member.....	542
Printing HFS files.....	501	Relative positioning support.....	543
Finding a string in HFS files.....	501	Chapter 15. Redefines criteria.....	545
Chapter 13. Introduction to programming with File Manager functions.....	503	Specifying redefines criteria.....	545
Summary of File Manager functions.....	503	Example 1. CF (by field) prefix command.....	546
Using File Manager functions in REXX procedures or TSO clists.....	506	Example 2. CR (free-format criteria) prefix command.....	548
Invoking File Manager panels from REXX procedures or TSO clists.....	507	Selection rules and example.....	550
Invoking File Manager functions from a REXX procedure or CLIST in /BATCH mode.....	507	Chapter 16. Enhanced ISPF: Reference List, Search, Change, and PDSE Workbench.....	553
Using File Manager functions in batch jobs.....	508	Setting up the enhanced ISPF commands.....	553
JCL syntax for File Manager batch jobs.....	508	Define the search command with LIBDEFs.....	556
Using File Manager edit models.....	510	Define the Enhanced Reference List command with LIBDEFs.....	556
Edit model example: JCL that calls the DSC function.....	511	Define the Enhanced Change command with LIBDEFs.....	557
Destination of File Manager print output.....	514		
Handling errors.....	515		
Chapter 14. Enhancing File Manager processing.....	517		

Define the PDSE Workbench command with LIBDEFs.....	557	Specific method requests for Db2®.....	663
Define the search command without LIBDEFs.....	558	Specific method responses for z/OS® files.....	664
Define the Enhanced Reference List command without LIBDEFs.....	558	Specific method responses for IMS™.....	665
Define the Enhanced Change command without LIBDEFs.....	558	Specific method responses for Db2®.....	666
Define the PDSE Workbench command without LIBDEFs.....	559	Creating z/OS® Connect APIs.....	667
Using Enhanced Reference List, Search, and Change.....	559	Using the Build Toolkit plug-in.....	669
Reference data set.....	560	zconbt command line utility.....	670
EFind command syntax.....	565	Build Toolkit plug-in properties.....	670
EChange command syntax.....	568	Deploying SAR files.....	674
Enhanced Search command panel.....	569	Configuring File Manager SAR files.....	674
Enhanced Search member hit selection list panel.....	573	Modifying templates.....	675
Enhanced Change command panel.....	576	Swagger documentation.....	675
Enhanced Change command member list panel.....	579	Security.....	677
Navigating the Enhanced search and Change report.....	581	Troubleshooting.....	678
Using the F4 function key.....	581	Example scenarios.....	681
Examples: Enhanced Reference List and Search.....	596	Generic method examples.....	681
Examples: Enhanced Change.....	612	Specific method examples.....	696
Indexed search.....	616	Chapter 18. Function and panel reference lists.....	712
Setting up the indexed search ISPF command.....	617	Introduction.....	712
Invoking the XFind command.....	618	FMNREFTB DD - Sharing reference lists.....	712
Creating a new index directory data set.....	619	Save reference command: SAVEREF (SR SREF).....	712
Index definition members.....	620	Syntax.....	712
Index List panel.....	628	Save reference panel.....	712
Index Search panel.....	631	Retrieve reference command. GETREF (GR GREF)....	713
PDSE Workbench.....	637	Syntax.....	713
Invoking PDSE Workbench.....	639	Example.....	713
Using PDSE Workbench.....	639	Maintaining your saved references – Reference list.....	714
Chapter 17. File Manager Service Provider for z/OS® Connect Enterprise Edition.....	647	Part II. File Manager Reference.....	716
Methods for accessing IBM Z data sources.....	647	Chapter 19. Panels and fields.....	717
Single reads versus multiple reads.....	648	Summary of File Manager panels.....	717
Requests and responses.....	648	Access Hierarchical File System panel.....	725
Generic method requests for z/OS® files.....	649	Advanced Member Selection panel.....	726
Generic method requests for IMS™.....	651	AFP Print Browse panel.....	730
Generic method requests for Db2®.....	654	AFP Print Browse output.....	732
Generic method responses for z/OS® files.....	656	AIX® Association Information panel.....	733
Generic method responses for IMS™.....	657	AIX® Entry Detail panel.....	734
Generic method responses for Db2®.....	659	Allocate panel.....	737
Specific method requests for z/OS® files.....	660	Allocate (Two) panel.....	739
Specific method requests for IMS™.....	661	Allocate (Three) panel.....	744
		Append panel.....	745
		Browse panel.....	746
		Browse Entry panel.....	751
		Catalog Services panel.....	756
		Catalog Services Data Set List panel.....	759
		Clipboard Manager panel.....	762
		Compare Utility: "Old" and "New" panels.....	764
		Compare Utility: Load module options panel.....	768

Compare Utility: Options panel.....	773	Load Module Information panel.....	927
Compare Utility: Output Data Sets.....	785	Load Module Information - Selection panel.....	935
Compiler Language Selection panel.....	788	Load Module - Member Selection Criteria panel.....	938
Copy From panel.....	789	Load module utility functions panel.....	940
Copy To panel.....	796	Map To panel.....	941
Copybook and Template Utility functions panel.....	809	Member Selection panel.....	946
Copybook Selection panel.....	810	Memory Browse panel.....	952
Copybook View and Print: Entry panel.....	814	Non-VSAM Allocate panel.....	954
Copybook View and Print: View panel.....	816	Non-VSAM Association Information panel.....	955
Create panel.....	820	Non-VSAM Define panel.....	955
Create Tape Data panel.....	821	Non-VSAM Entry Detail panel.....	957
Data Create Utility panel.....	824	Non-VSAM Extent Information panel.....	958
Data Set Selection panel.....	829	OAM Functions panel.....	959
Date/Time Attributes panel.....	830	Path Entry Detail panel.....	959
Delete Entry panel.....	834	PDSE Workbench Entry panel.....	960
Disk Volume Details panel.....	835	PDSE Workbench Member List panel.....	961
Disk/VSAM Data Functions panel.....	836	Personal Data Set List panel.....	966
Display VTOC panel.....	837	Personal Data Set Lists panel.....	968
Display VTOC Batch Sort Options panel.....	840	Primary Option Menu panel.....	970
Display VTOC Data Set List panel.....	843	Print Audit Trail panel.....	974
Dynamic Template panel.....	845	Print Options panel.....	975
Editor panel.....	853	Print Utility panel.....	977
Edit Entry panel.....	862	Record Identification Criteria panel.....	982
Edit Personal Data Set List panel.....	865	Record Sampling panel.....	988
Edit/View - Copy panel.....	866	Record Selection Criteria panel.....	991
Editor Options panel.....	868	Record Type Mapping panel.....	996
Erase Tape panel.....	874	Record Type Selection panel.....	998
Exported Stacked Volume Copy panel.....	875	Redefines / Range Specifications panel.....	1000
Exported Stacked Volume List panel.....	875	Related ID expression panel.....	1002
Field Attributes panel - alphanumeric fields.....	876	RID Selection panel.....	1007
Field Attributes panel - numeric field.....	883	Remote System Definition panel	1009
Field Mapping panel.....	889	Remote System Definition List panel	1011
Field Selection/Edit panel.....	891	Replace panel.....	1012
Field Selection List panel.....	898	Saveas panel.....	1013
File Selection panel.....	899	Scramble Exit Specification panel.....	1014
Find/Change Utility panel.....	901	Sequential Data to Tape panel.....	1015
FMAP Copybook or Template panel.....	907	Set Batch Job Card Information panel (option 0.4).....	1015
From (or Old) Field Mapping panel.....	908	Set COBOL Processing Options panel (option 0.5.2).....	1016
GDG Entry Detail panel.....	910	Set DBCS Format panel.....	1018
History Selection panel.....	911	Set HLASM Processing Options panel (option 0.5.3).....	1020
IAM KSDS Define panel.....	916	Set Language and Compiler Specifications (option 0.5).....	1021
IAM Entry Details panel.....	917	Set Output Data Set Allocation Options panel.....	1022
Initialize Tape panel.....	920	Set PL/I Processing Options panel (option 0.5.4)...	1024
Key positioning panel.....	921	Set Print Processing Options panel (option 0.1).....	1025
01 Layout Selection List panel.....	922	Set Processing Options panel.....	1029
Library List panel.....	923		
Load Module Compare - entry panel.....	924		

Set System Processing Options panel (option 0.2).....	1031	Write Tape Mark panel.....	1117
Set Tape Processing Options panel (option 0.3).....	1034	Chapter 20. Primary commands.....	1118
Set Temporary Data Set Allocation Options panel.....	1036	ABOUT primary command.....	1118
Set Trace options panel.....	1038	AMSMMSG primary command.....	1118
Tape Browse panel.....	1040	APPEND and APPENDX primary commands.....	1119
Tape Data Copy Functions panel.....	1040	ASSOCS primary command.....	1120
Tape Label Display panel.....	1041	AUTORTRY primary command.....	1121
Tape Map panel.....	1042	AUTOSAVE primary command.....	1121
Tape Positioning Functions panel.....	1043	BOTTOM primary command.....	1122
Tape Print panel.....	1044	BOUNDS primary command.....	1123
Tape Record Load panel.....	1045	CANCEL primary command.....	1124
Tape Record Scan panel.....	1046	CAPS primary command.....	1124
Tape Specific Functions panel.....	1047	CASE primary command.....	1125
Tape to Labeled Tape panel.....	1050	CCSID primary command.....	1126
Tape to Tape panel.....	1050	CE (Change Error) primary command.....	1126
Tape to Tape Compare panel.....	1051	CEDIT primary command.....	1128
Tape to Tape Reblocked panel.....	1052	CHANGE/CX primary command.....	1129
Tape to QSAM panel.....	1053	CHGASAVE primary command.....	1137
Tape to VSAM panel.....	1054	COPY primary command.....	1138
Tape Update panel.....	1055	CUT primary command.....	1140
Template Build Utility panel.....	1056	CREATE, CREATEX primary commands.....	1141
Template Export Utility panel.....	1058	DEDIT primary command.....	1142
Template Import Utility panel.....	1062	DELETE (members) primary command.....	1143
Template List Entry panel.....	1063	DELETE (records) primary command.....	1144
Template Member List panel.....	1064	DESCRIBE primary command.....	1145
Template Update Utility panel.....	1066	DOWN primary command.....	1146
Template Save pop-up panel.....	1070	DX primary command.....	1147
Template Workbench panel.....	1072	EDIT primary command.....	1147
Utility Functions menu panel.....	1077	END primary command.....	1148
Utility Functions menu panel from ISPF 3.4.....	1079	EXCLUDE/XX primary command.....	1148
Value List Edit panel.....	1081	EXIT primary command.....	1153
View panel.....	1083	EXPAND primary command.....	1154
View Entry panel.....	1092	EXTENT primary command.....	1154
Volume Summary/Selection panel.....	1097	FE (Find Error) primary command.....	1154
VSAM Association Information panel.....	1098	FKEY primary command.....	1156
VSAM Define panel.....	1099	FILE primary command.....	1157
VSAM Edit Sharing Options panel.....	1101	FIND/FX primary command.....	1157
VSAM Entry Detail panel.....	1102	FINDNOT primary command.....	1168
VSAM Entry Rename panel.....	1106	FMAP primary command.....	1169
VSAM Statistics and Extent Detail panel.....	1106	FORMAT primary command.....	1170
VSAM to Tape panel.....	1107	FREE primary command.....	1171
WebSphere® MQ Functions panel.....	1108	HEX primary command.....	1172
WebSphere® MQ Managers panel.....	1109	HIDE primary command.....	1173
WebSphere® MQ Managers Information panel.....	1110	HISTORY primary command.....	1174
WebSphere® MQ Queue Editor Entry panel.....	1112	HOLD primary command.....	1175
WebSphere® MQ Queue Information panel.....	1114	INFO primary command.....	1176
WebSphere® MQ Queue List panel.....	1116	JOIN primary command.....	1176

JUST primary command.....	1177	SORT primary command.....	1224
KEY primary command.....	1177	SPLT primary command.....	1227
LEFT primary command.....	1178	SPLTJOIN primary command.....	1228
LHEX primary command.....	1180	STR primary command.....	1228
LIBLIST primary command.....	1181	STATS primary command.....	1229
LIST primary command.....	1181	SV primary command.....	1229
LISTVIEW primary command.....	1181	TAILOR primary command.....	1230
LOCATE primary command.....	1182	TEDIT primary command.....	1231
LZERO primary command.....	1190	TOP primary command.....	1232
NEXT primary command.....	1191	LPRINT primary command.....	1232
NEXTREC primary command.....	1192	TVIEW primary command.....	1233
NRETRIEV primary command.....	1193	TYPE primary command.....	1233
OFFSET primary command.....	1193	UP primary command.....	1234
ORDER primary command.....	1195	UPDATE primary command.....	1235
PACK primary command.....	1195	VCONTEXT primary command.....	1235
PASTE primary command.....	1196	VER primary command.....	1236
PIC primary command.....	1197	VIEW primary command.....	1237
PREFIX primary command.....	1197	VOLUME primary command.....	1237
PREVIOUS primary command.....	1198	WIDTH primary command.....	1237
PREVREC primary command.....	1199	XD primary command.....	1239
PROFILE primary command.....	1200	ZOOM primary command.....	1239
QUIT primary command.....	1200	Chapter 21. Functions.....	1241
RBALEN primary command.....	1200	How to use this reference chapter.....	1241
RCHANGE primary command.....	1201	How to read the syntax diagrams.....	1241
RD primary command.....	1201	General tips about performance when you use File Manager functions.....	1243
RDF primary command.....	1203	File Manager functions.....	1245
RECLLEN primary command.....	1204	AUD (Print audit trail report).....	1245
RECOVER primary command.....	1204	BSF (Backward Space File).....	1248
RECSTATS primary command.....	1205	BSR (Backward Space Record).....	1249
REFRESH primary command.....	1205	BT (Create Tape File).....	1250
REFS primary command.....	1206	BTB (Batch Template Build).....	1253
REPLACE, REPLACEX primary commands.....	1207	BTU (Batch Template Update).....	1263
RESET primary command.....	1208	CLM (Compare Load Module).....	1274
RF primary command.....	1210	DEFV (Define VSAM Statements).....	1285
RFIND primary command.....	1211	DP (Disk Print).....	1286
RIGHT primary command.....	1212	DRS (Disk Record Scan).....	1289
RP primary command.....	1214	DSB (Data Set Browse).....	1293
RUNTEMP primary command.....	1215	DSC (Data Set Copy).....	1302
SAVE primary command.....	1215	DSE (Data Set Edit).....	1342
SAVEAS primary command (templates).....	1216	DSEB (Data Set Edit Batch) -- batch only.....	1351
SAVEAS, SAVEASX primary commands (data).....	1216	DSFA (Altering a data set).....	1369
SELECT primary command.....	1218	DSFC (Allocate a data set).....	1371
SHADOW primary command.....	1220	DSFD (Delete a data set).....	1371
SHOW (FLD) primary command.....	1221	DSFR (Rename a data set).....	1371
SHOW (REC) primary command.....	1222	DSG (Data Set Generate).....	1372
SHOWCOB primary command.....	1223	DSI (Data Set Information).....	1386
SLOC primary command.....	1224	DSM (Data Set Compare).....	1388

DSP (Data Set Print).....	1438	VT (VSAM to Tape).....	1616
DSU (Data Set Update) – batch only.....	1462	VX (VSAM to REXX Variable) – REXX only.....	1619
DSV (Data Set View).....	1480	WTM (Write Tape Mark).....	1621
DSX (Data Set Extents).....	1490	XT (REXX Variable to Tape) – REXX only.....	1621
DVT (Display VTOC).....	1491	XV (REXX Variable to VSAM) – REXX only.....	1623
EOJ (End of Job).....	1498	External REXX functions.....	1624
ERT (Erase Tape).....	1498	Absolute and relative positioning in external REXX functions.....	1627
EVC (Exported Stacked Volume Copy).....	1499	Specifying relative positions.....	1630
EVL (Exported Stacked Volume List).....	1501	Using FASTREXX variables.....	1631
FCH (Find/Change).....	1503	Tally register for external REXX functions.....	1632
FMT (Set DBCS Format).....	1517	BOT (DSEB only).....	1635
FSF (Forward Space File).....	1519	CHANGE.....	1635
FSR (Forward Space Record).....	1520	CHG_OUT.....	1637
INT (Initialize Tape).....	1521	CHG_VAR.....	1640
NOSORT (Disable the use of DFSORT).....	1523	CONTAINS.....	1644
ODL (Object Directory List).....	1523	CMP_DATE.....	1645
OE (Object Erase).....	1526	CMP_TIME.....	1648
OO (Object to Object).....	1526	DOWN (DSEB only).....	1652
OP (Object Print).....	1528	FINDNEXT, FINDPREV (DSEB only).....	1652
OS (Object to Sequential Data).....	1530	FLD.....	1653
OV (Object to VSAM).....	1533	FLD_CO.....	1655
PBK (Print Copybook).....	1536	FLD_OUT.....	1657
PWB (PDSE Workbench).....	1544	FLD_TM.....	1659
REW (Tape Rewind).....	1545	FLD_TYPE.....	1661
RUN (Tape Rewind-Unload).....	1546	FLDI.....	1663
SCS (Catalog Services).....	1547	FLDO.....	1666
SET (Set Processing Options).....	1550	L_LENGTH.....	1666
SETCICS (Update the status of CICS® files) – batch only.....	1561	MOD_DATE.....	1667
SETRC (Set the job step return code).....	1564	NCONTAIN.....	1672
SO (Sequential Data to Object).....	1565	O_LENGTH.....	1673
ST (Sequential Data to Tape).....	1568	OFLD_CO.....	1673
TLB (Tape Label Display).....	1571	OVLY_OUT.....	1675
TLT (Tape to Labeled Tape).....	1573	OVLY_VAR.....	1678
TMP (Tape Map).....	1575	PRINT.....	1681
TP (Tape Print).....	1577	PRTCOUNT.....	1683
TPEXP (Export template to XML).....	1579	PRT_IN.....	1683
TPIMP (Import template from XML).....	1584	PRT_OUT.....	1684
TRS (Tape Record Scan).....	1589	PRT_VAR.....	1685
TS (Tape to Sequential Data).....	1592	RECCUR (DSEB only).....	1686
TT (Tape to Tape).....	1596	RECSIN.....	1686
TTC (Tape to Tape Compare).....	1598	RECSOUT.....	1687
TTR (Tape to Tape Reblocked).....	1599	RSTR_OUT.....	1688
TV (Tape to VSAM).....	1602	SAVE_OUT.....	1688
TX (Tape to REXX Variable) – REXX only.....	1605	SEGCNT.....	1689
VER (Display Service Level).....	1607	SEGLEN.....	1689
VLM (View Load Module).....	1607	SEGOFF.....	1690
VO (VSAM to Object).....	1614	SEGNO.....	1691

SET_FLD.....	1691
SET_OLEN.....	1692
SETC.....	1693
SETN.....	1694
SETRC.....	1695
STATS.....	1696
TALLY.....	1697
TESTC.....	1699
TESTN.....	1702
TFLD.....	1703
TID.....	1706
TM.....	1706
TOP (DSEB only).....	1707
UP (DSEB only).....	1707
UPDATE (DSEB only).....	1708
VAL_FLD.....	1708
VAR_OUT.....	1708
VAR_TM.....	1710
WRITE.....	1712
RETURN return values.....	1714
DROP.....	1714
DROP MEMBER.....	1715
PROCESS MEMBER.....	1715
STOP.....	1715
STOP IMMEDIATE.....	1716
Appendix A. Messages.....	1717
File Manager messages.....	1717
Appendix B. XML definitions for a template.....	1823
Options for "act".....	1839
Support resources.....	mdccccli
Accessibility features for File Manager	mdccccli
Notices.....	mdccccli
Programming interface information.....	mdccccli
Glossary.....	mdccccli
Index.....	1857

User's Guide and Reference

This publication describes how to use the File Manager Base component to work with QSAM data sets, VSAM data sets, IAM data sets, PDS members, WebSphere MQ queues, or HFS files.

About this document

This document provides guidance and reference information for users of IBM® File Manager for z/OS® working with QSAM data sets, VSAM data sets, IAM data sets, PDS members, WebSphere MQ queues, or HFS files. (Throughout this document, the z/OS® UNIX™ file systems, HFS and zFS, are referred to as "HFS".)

File Manager for z/OS® contains four “*flavors*” of File Manager, for working in different environments or with different data formats:

- File Manager Base function, for working with QSAM data sets, VSAM data sets, IAM data sets, PDS members, WebSphere MQ queues, CICS® resources, or HFS files. You can access these data sources through the File Manager for z/OS® ISPF interface. You can also access these data sources through the File Manager for z/OS® Plug-in for Eclipse.
- IBM File Manager for z/OS Db2® component (FM/Db2)
- IBM® File Manager for z/OS® IMS™ component (FM/IMS)
- IBM® File Manager for z/OS® CICS® component (FM/CICS)

This document describes the File Manager Base component. In the rest of this document, the term “*File Manager*” refers only to the File Manager Base component, not to the Db2®, IMS™, or CICS® components.

This document is divided into three parts:

Part 1. Working with File Manager

Introduces key concepts, provides step-by-step instructions on how to perform tasks using the ISPF panel interface, and describes how to use File Manager functions in batch jobs, REXX procedures, or TSO CLISTS. The information is presented in a task-based format, with panel, field, command, and function definitions provided when they are relevant to the current task. For a complete description of a particular panel, field, command, or function, refer to the appropriate chapter in **Part 2. File Manager Reference**.

Part 1 can be used both as a learning tool for new users and as a way to quickly find specific task instructions.

Part 2. File Manager Reference

1. Panel and field reference: Lists all of the File Manager panels, provides a definition for each field in the panel and, where applicable, lists the value ranges that are valid for each field.
2. Command reference: Describes the syntax, usage, and equivalent function for each primary command.
3. Function reference: Describes the syntax, usage, and available parameters for each File Manager function.

Both new and experienced users of File Manager can use Part 2 to quickly look up such things as the syntax of a command or function, or the acceptable values for a field in a panel.

Part 3. Appendixes

The appendixes include the File Manager Base component messages and the template XML reference.

Prerequisite and related information

File Manager documentation also supports the following tasks:

Planning for, installing, customizing, and maintaining File Manager

Refer first to the *File Manager for z/OS Customization Guide* which may then refer you to the File Manager Program Directory for more information.

Using other File Manager components

For information about the Db2®, IMS™, and CICS® components, refer to these documents:

- *File Manager for z/OS User's Guide and Reference for DB2 Data*
- *File Manager User's Guide and Reference for IMS Data*
- *File Manager User's Guide and Reference for CICS*

When using any File Manager component under ISPF, you can also refer to the online help.

Who should use this document

This document is for three kinds of File Manager users:

- Application programmers who need to test and debug programs
- Service support personnel who need to analyze and fix problems
- System administrators and system operators who need to do routine tasks such as moving large amounts of data

This document assumes that you are familiar with using ISPF.

To use File Manager functions in batch jobs, you must already be familiar with JCL.

To use File Manager functions in REXX procedures, you must already be familiar with the REXX programming language.

How to read syntax diagrams

The syntactical structure of commands described in this document is shown by means of syntax diagrams.

[Figure 1: Sample syntax diagram on page xviii](#) shows a sample syntax diagram that includes the various notations used to indicate such things as whether:

- An item is a keyword or a variable.
- An item is required or optional.
- A choice is available.
- A default applies if you do not specify a value.
- You can repeat an item.

Figure 1. Sample syntax diagram

Figure 1. Syntax

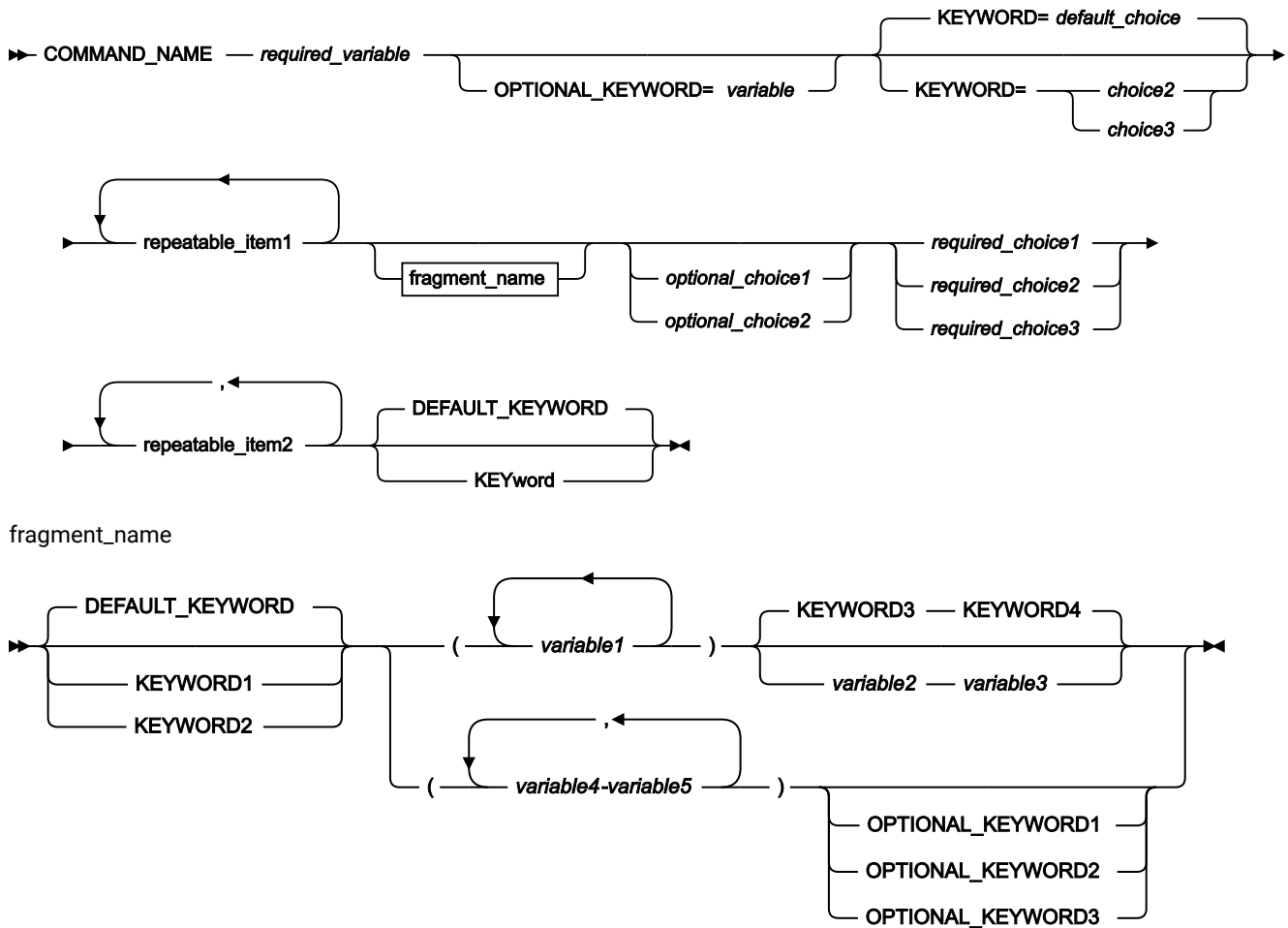

Here are some tips for reading and understanding syntax diagrams:

Order of reading

Read the syntax diagrams from left to right, from top to bottom, following the path of the line.

The ▶▶— symbol indicates the beginning of a statement.

The —▶ symbol indicates that a statement is continued on the next line.

The ▶— symbol indicates that a statement is continued from the previous line.

The —▶▶ symbol indicates the end of a statement.

Keywords

Keywords appear in uppercase letters.

▶▶ **COMMAND_NAME** ▶▶

Sometimes you only need to type the first few letters of a keyword, The required part of the keyword appears in uppercase letters.

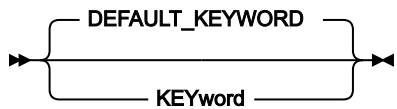

In this example, you could type "KEY", "KEYW", "KEYWO", "KEYWOR" or "KEYWORD".

The abbreviated or whole keyword you enter must be spelled exactly as shown.

Variables

Variables appear in lowercase letters. They represent user-supplied names or values.

▶▶ *required_variable* ◀◀

Required items

Required items appear on the horizontal line (the main path).

▶▶ **COMMAND_NAME** — *required_variable* ◀◀

Optional items

Optional items appear below the main path.



Choice of items

If you can choose from two or more items, they appear vertically, in a stack.

If you *must* choose one of the items, one item of the stack appears on the main path.

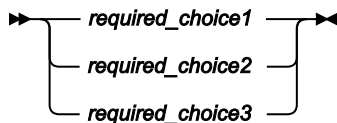

If choosing one of the items is optional, the entire stack appears below the main path.

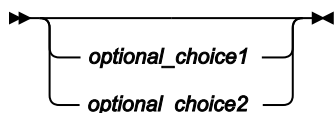

If a default value applies when you do not choose any of the items, the default value appears above the main path.

Summary of changes

August 2023, V14R1M20 (refresh)

This edition of the document provides information applicable to File Manager Version 14 Release 1 Modification Level 20. It is a refresh of the previous version and contains some additional enhancements as well as minor changes and clarifications to the information in the previous version. Here are the major changes to this document from the previous release.

- A new option, option 13, has been added to the Enhanced Search KEY menu panel to allocate, change or invoke catalog services against a data set name that the cursor is positioned on. See [Using F4 from any edit or view session when positioned on a string or word on page 583](#) for more information about this new option.
- Indexed search changes:
 - The restriction of a maximum of 22 data sets when duplicated members are not being processed has been removed.
 - Automatic word detection has been introduced as the simpler and recommended method for determining words. See [Automatic word detection on page 623](#) for more details.
 See [Indexed search on page 616](#) for details on the indexed search capability.
- A new option, ASIS, has been added to suppress automatic encapsulation and, automatic encapsulation has been limited to when a delimiter is encountered or when the first character is a quote. See [Copy To panel on page 796](#) and [DSC \(Data Set Copy\) on page 1302](#) for more details about automatic encapsulation.

June 2023, V14R1M20

This edition of the document provides information applicable to File Manager Version 14 Release 1 Modification Level 20. It contains minor changes and clarifications to the information in the previous version. Here are the major changes to this document from the previous release.

- The File Manager Data Set Copy (DSC) function and the Copy From and Copy To panels now support importing CSV files. See [DSC \(Data Set Copy\) on page 1302](#), [Copy From panel on page 789](#), and [Copy To panel on page 796](#) for more information.
- The indexed search provides a way to perform a fast search across one or more partitioned data sets. The results are displayed in the index search report containing the list of matching words, the number of lines where the word occurs, the number of data sets containing occurrences of the word, and the number of members. See the section on the indexed search in the *File Manager for z/OS® User's Guide and Reference* for more information about how to set up and use the indexed search facility.

February 2023, V14R1M19

This edition of the document provides information applicable to File Manager Version 14 Release 1 Modification Level 19. It contains minor changes and clarifications to the information in the previous version.

November 2022, V14R1M18

This edition of the document provides information applicable to File Manager Version 14 Release 1 Modification Level 18. It contains minor changes and clarifications to the information in the previous version.

June 2022, V14R1M17

This edition of the document provides information applicable to File Manager Version 14 Release 1 Modification Level 17. It contains minor changes and clarifications to the information in the previous version.

February 2022, V14R1M16

This edition of the document provides information applicable to File Manager Version 14 Release 1 Modification Level 16. Here are the major changes to this document from the previous edition for Version 14 Release 1.

- **Enhanced Find.** Two new options when performing partitioned data set searches:

List

Produces an intermediate matching member list with sortable columns. Columns can now be sorted in change date order so that you can easily determine the most recent member matching the search criteria. This provides more flexibility than the current summary command from the enhanced search report.

First

Limits the search to the first occurrence of a member if more than one partitioned data set is being processed. For example, this can be applied in a Software Configuration and Library Manager (SCLM) environment where you might have the same member in more than one library and you are interested in only the first occurrence or the latest version of that member.

For more detailed information about these new options, see [EFind command syntax on page 565](#) and [Enhanced Search command panel on page 569](#).

- **Enhanced Change and FCH function.** A new option, MEMORY, has been introduced to address the restrictions associated with update in place. Record lengths can now be changed and compressed data sets are supported. For more detailed information about this new option, see the topics that describe the Enhanced Change command panel, the Find/Change Utility panel and the FCH (Find/Change) function.
- **New function to produce VSAM define statements.** A new batch function, DEFV, has been added to produce IDCAMS define statements for one or more data sets. For more information, see the topic describing the DEFV function.

October 2021, V14R1M15

This edition of the document provides information applicable to File Manager Version 14 Release 1 Modification Level 15. Here are the major changes to this document from the previous edition for Version 14 Release 1.

- Display a list of templates, of all types, and perform actions on them. The Template List provides the following features:
 - Visibility of member generations for PDSE version 2 data sets.
 - A lock mechanism to prevent unintentional template edit changes.
 - The ability to change the default value for formatting leading zeros with numeric fields.
 - The ability to compare templates in their exported XML format.

For more detailed information about the Template List, see [Working with the Template List on page 271](#).

March 2021, V14R1M13

This edition of the document provides information applicable to File Manager Version 14 Release 1 Modification Level 13. Here are the major changes to this document from the previous edition for Version 14 Release 1.

- Random and repeatable scrambling can now be optimized with a new option. The option can be customized at installation time (default behavior for scrambling). The default behavior can be overridden by specifying the option when copying and scrambling data. The option can be set to one of the following values: `OFF`, `ON`, or `MAX`. See [SET \(Set Processing Options\) on page 1550](#) and [Copy To panel on page 796](#).
- Load Module Attributes are now included on the information, print, and XML reports. See [Load Module Information panel on page 927](#).

October 2020, V14R1M12

This edition of the document provides information applicable to File Manager Version 14 Release 1 Modification Level 12. Here are the major changes to this document from the previous edition for Version 14 Release 1.

- Prefix commands JCL, SELECT, and SUBMIT are now supported in PDSE Workbench. See [Prefix commands on page 643](#).
- A new SETCICS function enables opening and closing CICS® files and working with CICS® resources in batch or keyword mode. See [SETCICS \(Update the status of CICS files\) – batch only on page 1561](#).
- When doing a keyed data set compare you can now first sort the files in the order determined by the key values. See [DSM \(Data Set Compare\) on page 1388](#) and [Compare Utility: Options panel on page 773](#).
- Output from a data set compare can now be combined and directed to a single DD. See [DSM \(Data Set Compare\) on page 1388](#).
- Fields can now be held when scrolling in SNGL display format. See [Holding fields on the display when scrolling on page 227](#).
- Template enhancements:
 - New "A" (Always) option means the template can always be edited before an edit, view, or browse session.

New "R" (Re-edit) option provides the ability to save a temporary or dynamic template after it was applied to the data, or re-invoke the edit or view session using RUNTEMP.

See [Editing a template on page 218](#), [Browse Entry panel on page 751](#), and [View Entry panel on page 1092](#).

- For templates created during a FM/IMS extract the DBD name can now be edited in the File Manager Base component. This allows one template to be reused for multiple DBD names. See [XML templates on page 261](#).
- PDSE Workbench has been updated to support PDS and PDSE data sets on a remote system.

These changes, and smaller corrections and additions, are indicated by a “/” change bar in the left margin of the page.

June 2020, V14R1M11

This edition of the document provides information applicable to File Manager Version 14 Release 1 Modification Level 11. It contains minor changes and clarifications to the information in the previous version.

March 2020, V14R1M10

This edition of the document provides information applicable to File Manager Version 14 Release 1 Modification Level 10. Here are the major changes to this document from the previous edition for Version 14 Release 1.

- The VLM (View Load Module) and CLM (Compare Load Module) functions have been updated to:
 - Filter CSECTs selected for processing.
 - Display and compare compiler options added with the latest Enterprise COBOL and Enterprise PL/1 compilers.
 - Display and compare COBOL program language features used in the COBOL code for CSECTs created by Enterprise COBOL compilers.
 See [VLM \(View Load Module\) on page 1607](#) and [CLM \(Compare Load Module\) on page 1274](#).
- Member name filter values can be specified to limit the partitioned data set members to be displayed in a list or selected for processing. This is implemented through an enhancement to the Advanced Member Selection panel and a new XMEMBERS option in the BTB, BTU, CLM, DSC, DSEB, DSM, DSP, DSU, FCH, TPEXP, and TPIMP functions. See [File Manager functions on page 1245](#) and [Advanced Member Selection panel on page 726](#).
- File Manager now supports editing of MQ remote queues and aliases to remote queues. See [Working with WebSphere MQ on page 439](#).
- The Find/Change Utility panel, File Selection panel, and all UNIX System Services member lists have been updated to display created and changed dates in YYYY/MM/DD format. See [Find/Change Utility panel on page 901](#) and [File Selection panel on page 899](#).

SC27-9042-08: December 2019, V14R1M9

This edition of the document provides information applicable to File Manager Version 14 Release 1 Modification Level 9. Here are the major changes to this document from the previous edition for Version 14 Release 1, SC27-9042-07.

- Support for version 2 PDSE member generations and new PDSE Workbench.
 - A new PDSE workbench has been developed to handle management of members and generations.
 - The enhanced search Drill parameter now supports a limit and applies to version 2 PDSE generations as well as HFS and zFS directories.

- The enhanced search function key (or edit macro) menu has a new option to invoke PDSE Workbench. This allows for cursor-sensitive invocation from JCL View or Edit sessions.
- Data set COPY utility now supports copying of member generations.
- CLONE facility now supports the copying of member generations.
- A new history capability for all member lists within File Manager.

See [PDSE Workbench on page 637](#).

- File Manager print output can now be directed to FMNPRINT, and individual sections of the output can now be directed instead to alternate ddnames. See [Invoking File Manager functions from a REXX procedure or CLIST in / BATCH mode on page 507](#) and [JCL syntax for File Manager batch jobs on page 508](#).
- New DSINFO File Manager option on the SET function provides additional information in batch reports about input and output data sets for the DSP, DSM, DSC, and FCH commands. See [SET \(Set Processing Options\) on page 1550](#).
- The data set COPY utility has been enhanced to support CSV as an output format. See [DSC \(Data Set Copy\) on page 1302](#).
- File Manager MQ users are no longer required to have CONTROL access to the MQADMIN class resource *mqmanager.CONTEXT.mqqueue*. If users do not have this access the MQ CONTEXT is not copied when records are updated.

SC27-9042-07: September 2019, V14R1M8

This edition of the document provides information applicable to File Manager Version 14 Release 1 Modification Level 8. Here are the major changes to this document from the previous edition for Version 14 Release 1, SC27-9042-06.

- Template repository support for mandatory templates and dynamic data scrambling. Refer to the topics under [Template repository on page 186](#).
- New BDY option on the SET function and Compiler Language Selection panel specifies whether to suppress boundary field errors. See [SET \(Set Processing Options\) on page 1550](#) and [Compiler Language Selection panel on page 788](#).
- New options on the DSC function enable SMS attributes to be specified for the output data set (DSNOUT). See [DSC \(Data Set Copy\) on page 1302](#).

SC27-9042-06: June 2019, V14R1M7

This edition of the document provides information applicable to File Manager Version 14 Release 1 Modification Level 7. Here are the major changes to this document from the previous edition for Version 14 Release 1, SC27-9042-05.

- Edit models are provided to help create batch JCL that accesses File Manager functions and REXX external functions. Refer to [Using File Manager edit models on page 510](#).

SC27-9042-05: March 2019, V14R1M6

This edition of the document provides information applicable to File Manager Version 14 Release 1 Modification Level 6. Here are the major changes to this document from the previous edition for Version 14 Release 1, SC27-9042-04.

- File Manager Service Provider for IBM® z/OS® Connect Enterprise Edition now enables client applications to access IMS™ and Db2® data sources using z/OS® Connect. Refer to [File Manager Service Provider for z/OS Connect Enterprise Edition on page 647](#), in particular the IMS™ and Db2® topics in the following sections:
 - [Requests and responses on page 648](#).
 - [Build Toolkit plug-in properties on page 670](#).
 - [Generic method examples on page 681](#).
 - [Specific method examples on page 696](#).
- Added support for 8-character TSO user IDs and TSO prefixes, which was introduced with z/OS® v2.3. See [Advanced Member Selection panel on page 726](#).

SC27-9042-04: September 2018, V14R1M4

This edition of the document provides information applicable to File Manager Version 14 Release 1 Modification Level 4. Here are the major changes to this document from the previous edition for Version 14 Release 1, SC27-9042-03.

- New Clone facility. See [Cloning data sets on page 360](#).
- New template repository facility. See [Template repository on page 186](#).
- New option specifies the method by which JCL data is processed when running FCH or DSC with JCL=YES. See [Working with files or members containing JCL on page 378](#) and [SET \(Set Processing Options\) on page 1550](#).

SC27-9042-03: June 2018, V14R1M3

This edition of the document provides information applicable to File Manager Version 14 Release 1 Modification Level 3. Here are the major changes to this document from the previous edition for Version 14 Release 1, SC27-9042-02.

- Enhancements to FM Service Provider for z/OS Connect REST API feature. See [File Manager Service Provider for z/OS Connect Enterprise Edition on page 647](#).
- New Enhanced Change facility. See [Using Enhanced Reference List, Search, and Change on page 559](#).
- New REDEFINES criteria feature. See [Redefines criteria on page 545](#).
- New messages FMNBA151-153, FMNBA157-159, FMNBE004.

SC27-9042-02: March 2018, V14R1M2

This edition of the document provides information applicable to File Manager Version 14 Release 1 Modification Level 2. Here are the major changes to this document from the previous edition for Version 14 Release 1, SC27-9042-01.

- File Manager service provider enables customers to create client applications to access IBM® Z data sources using z/OS® Connect. See [File Manager Service Provider for z/OS Connect Enterprise Edition on page 647](#).
- New keyword KEYDUPOK on DSM batch function. See [DSM \(Data Set Compare\) on page 1388](#).

SC27-9042-01: December 2017, V14R1M1

This edition of the document provides information applicable to File Manager Version 14 Release 1 Modification Level 1. It contains minor changes from the previous edition for Version 14 Release 1, SC27-9042-00.

SC27-9042-00: September 2017, V14R1M0

This edition of the document provides information applicable to File Manager Version 14 Release 1 Modification Level 0. Here are the major changes to this document from the previous edition for Version 13 Release 1, SC19-4119-08.

- Support for PDSE Version 2 allocation. See [Allocate \(Two\) panel on page 739](#).

Part I. Working with File Manager

Chapter 1. File Manager overview

File Manager Base component provides comprehensive, user-friendly tools for working with Websphere MQ data, HFS files and QSAM, VSAM and IAM data sets. These tools include the familiar view, edit, copy and print utilities found in ISPF, enhanced to meet the needs of application developers.

This chapter provides an overview of the types of actions you can perform with File Manager, a list of the types of data sets upon which you can perform these actions and some concept information about templates, one of the main tools used to view and edit data sets in File Manager.

File Manager actions

You can use File Manager to display, edit, update, create, copy, compare, print and erase data. You can manipulate this data as logical units, accessed by the data set name; or as physical units, accessed at each physical disk or tape location. Adding to this capability is an interactive interface that allows you to view data in both TABLE and SINGLE RECORD formats.

When working with data sets, you can:

- View, change, sort, copy and print data as unformatted or formatted with copybook or dynamic templates
- Perform sophisticated data set comparisons
- Find and change data strings in a single data set or in multiple data sets
- Create new HFS files or QSAM, VSAM or IAM data sets and data set records
- Create REXX procedures for advanced record processing
- Use selected DFSORT™ control statements to control the Data Set Copy and Data Set Print functions
- Create batch jobs, REXX procedures or CLISTs to automate tasks

For many of these tasks, you can use File Manager *templates*. A template provides a logical view of a data set, based upon field definitions in a copybook, or else created dynamically. If you use a template, you can:

- Format data according to record structures defined in the copybooks, or dynamically define your own record structure
- Select the fields and records that you want to work with, adjust how fields are displayed, select fields for copying, and set the contents of fields for created data
- Code record identification and selection criteria within File Manager panels, or use the File Manager REXX interface to code complex criteria
- Copy data between fields of different data type and length; and
- Work with files containing multiple record structures

File Manager also provides utilities that allow you to manipulate data in other ways:

- With the Tape Utility you can:
 - Copy tape files, optionally changing the block size and record format
 - Copy a logical volume from an Exported Stacked Volume to a physical tape volume
 - Update tape records on-screen, while copying the records from one tape to another
 - Compare two tapes byte-by-byte

- Bypass tape blocks with data-check errors
- Summarize the contents of a tape
- With the Disk Utility, you can look at and edit a file, based on the contents of the data at each physical disk location. There is support for character and hexadecimal format. Because the access is done at the level of the physical track, all file types are supported, including BDAM. With the disk utilities, you can:
 - List data sets on a disk
 - Edit data on a specific track
 - Identify the disk extents of a data set
 - Search for data within a disk extent
- You can use the Object Access Method (OAM) Utility to list, view, print, update, erase, copy, back up and restore OAM objects.
- The IDCAMS front end (Catalog Services) allows you to control the OS/390® IDCAMS utility from user-friendly File Manager panels.

Data sets and records

File Manager provides production and development logical file manipulation for HFS files, sequential (PS and PDS(E)) and VSAM (including IAM) data sets.

You can view and edit or otherwise process these types of data:

- Sequential (PS) and partitioned (PDS or PDSE) data sets: A member of a partitioned data set or a sequential data set, or like or unlike concatenations thereof (when used as input), with any of these data set attributes:
 - PS data set type
 - Basic
 - Library
 - Extended
 - Large
 - Compressed
 - Record format
 - Fixed, variable, or undefined
 - Blocked or unblocked
 - Spanned
 - ISPF packed format data
 - Record length
 - For fixed-length data: 1–32760, 10–65535 (for tape using LBI)
 - For variable-length data: 1–32752, 14–65531 (for tape using LBI)
 - For spanned variable-length data: 1–16MB
- VSAM data sets:
 - ESDS, including spanned format
 - KSDS, including spanned format
 - RRDS (fixed-length or variable-length)

- PATH (PATHs related to a non-unique alternate index are restricted to browse only)
- AIX®
- HFS files: A file contained in the z/OS® UNIX™ File System, including z/FS and HFS:
 - Record format
 - Text (delimited by CR,LF or NL)
 - Binary
 - Record length
 - Text mode files are variable length: 1-32752
 - Binary mode files are fixed length: 1-32760
- Websphere MQ messages on a queue. Where allowed, an MQ queue can be specified in a data set name.
- CICS® files, TS, or TD queues:
 - When used in conjunction with FM/CICS. See File Manager for z/OS User's Guide and Reference for CICS.
 - In a non-CICS File Manager environment, by specifying the CICS® resource type, CICS® applid, and CICS® resource name as the data set name.



Note: Throughout this publication, where the term *data set* is used, it generally refers to any of the above resource types, rather than referring specifically to traditional z/OS® data sets, unless otherwise mentioned.

File Manager can use copybooks that are stored in a PDS, a PDSE, a CA-Panvalet library, or a library accessed using the Library Management System Exit.

Templates

A File Manager template is a file that provides a particular interpretation of a data set. The template defines a logical view that you can use to view and manipulate the data in records as discrete fields. With a template, you can select and format records and fields when editing, viewing, copying, printing and creating data sets. Templates can be based upon a COBOL, HLASM, OR PL/I *copybook* or can be created *dynamically*. You can apply different templates to the same data, to achieve different purposes. For example, you might create a number of templates with different selection criteria in place, and then apply the template that defines the subset of records that you need for a particular purpose. Also, you can apply the same template to different data sets, provided that they have similar record and field structures.

The File Manager Base function, Db2®, and IMS™ components all use templates. However, these templates are not interchangeable. You cannot, for example, use a File Manager Base component template in the File Manager Db2® component. Dynamic templates are only available within the File Manager Base component.

Why use a template?

Typically, data sets containing application data have a well-defined structure, where each record in the data set consists of several fields. Each field contains a discrete item of data, such as a person's name, a product code or a currency amount (depending on the application). This data can be of various types: some fields contain character data, others contain numeric data (perhaps encoded in binary format to conserve storage space).

To work efficiently with these data sets, you need tools that recognize record structure, allowing you to selectively process individual fields.

For example, if you use a text editor (such as the ISPF editor) to display an application data set, then each record appears as a string of characters, with no indication that the records consist of individual fields. Fields containing numeric data encoded in binary or packed decimal format are represented by their (typically “non-displayable”) character values, rather than their numeric values.

Even if you know the column boundaries of each field, editing an application data set in a text editor can be difficult and tedious:

- If you want to find and replace data in a specific field, then you have to be careful not to change the field length; otherwise, you could move the boundaries of subsequent fields, and corrupt the record structure.
- If you want to find and replace data in numeric fields where the data has been encoded in binary or packed decimal format, then you have to specify the find and replace values in that format (typically, as hexadecimal values), rather than as numeric values.
- If the file you are editing contains several record types (each with its own structure), and you only want to find and replace data in one record type, then you have to exclude other record types from editing.

To illustrate, here are some records containing a mixture of alphanumeric and numeric fields displayed in the ISPF editor:

```

EDIT      USERID.FMDATA(DATA2) - 00.02          Columns 00001 00072
000013 01Grant Smith          í
000014 01Andrew Apple        5  Ì&
000015 01Graham Prestcott    ð  ç
    
```

The Grant Smith record contains the numeric value “94”, stored in a binary numeric field. To change this from 94 to 48, without using a template, you would need to:

1. Display the hexadecimal values of the record data.
2. Determine the column positions occupied by the field.
3. Convert the numeric value 48 into its hexadecimal equivalent (X'30').
4. Overtyping the old hexadecimal value of the numeric field (X'5E') with the new value, or use a CHANGE command with the old and new hexadecimal values.

Here is the same record displayed in the File Manager editor using a template:

```

REC-TYPE NAME          EMPLOYEE-NO    AGE    SALARY  MONTH(1)  MONTH(2)
#2      #3              #4      #5      #6        #7        #7
AN 1:2  AN 3:20        BI 23:2 BI 25:2 PD 27:4  BI 31:4  BI 35:4
<>     <-----1----->  <----> <----> <-----> <-----> <----->
01      Grant Smith    7712    94     75000    6         15
    
```

To change the value of the AGE binary numeric field from 94 to 48, you can simply overtype 94 with 48, or enter the following command (where #5 is the “field reference” for the AGE field):

```

CHANGE 94 48 #5
    
```

Another situation in which you might want to use a template is when you are copying data. When you use a copy utility that does not recognize record structure, you are often limited to copying an entire data set, or a number of records. If you want to copy only records with particular field values, or only particular fields, then you must write a custom program.

When using templates with File Manager, you can specify criteria to select only the records you want to copy, and to select the fields you want from the list of fields in the record.

What can you do with a template?

Using a template, you can:

- **Format records**

You can display, print and compare fields taking into account their data types. For example, binary numeric fields are displayed as their true numeric values, not as the character representation of their binary value.

When editing, you can overwrite or use CHANGE commands to replace these formatted numeric field values with different numeric values; File Manager adjusts the underlying binary value in the data set.

You can select which fields are displayed (when in an editor session) or printed. In an editor session, you can limit the scope of commands (such as FIND and CHANGE) to particular fields.

You can change the order in which fields are displayed (when in an editor session) or printed.

For numeric fields, you can display or suppress leading zeros (so that, for example, 00057 is displayed and printed as 57); the default is to suppress leading zeros.

- **Reformat records**

When copying data, you can “map” which fields in the input data set you want copied to the output data set. You can insert or delete fields, and copy data between fields of different data types or lengths.

- **Identify record types and select records within those types**

You can select records using two levels of criteria:

- Record identification criteria

Identify the unique characteristics of a record type, enabling File Manager to distinguish it from other types of record in the same data set. You can then select which record types in a data set you want to use.

Before you can specify record identification criteria, you need to examine your data, and determine what field values uniquely identify a record as belonging to a particular type.

- Record selection criteria

After a record has been identified as belonging to a particular type, you can specify record selection criteria to narrow down which records of that type you want to use.

- **Create data**

When creating a new data set, or adding a new field when copying a data set, you can specify field “create attributes” (patterns that File Manager uses to initialize field values).

Where can you use templates?

The following table lists the tasks, panels and functions that support the use of templates:

Task	Panel	Function
View data	View (option 1)	–
Edit data	Edit (option 2)	DSEB (batch only) ¹
Compare data	Compare data (option 3.11)	DSM
Copy data	Copy Utility (option 3.3)	DSC
Create data	Data Create Utility (option 3.1)	DSG
Print data	Print Utility (option 3.2)	DSP
Update data	–	DSU (batch only) ¹



Note:

1. For the DSEB and DSU functions, the template is not used during editing or updating; it is only used during enhanced batch processing, when you call the File Manager REXX external function PRINT with SNGL or TABL format.

The difference between using DSU to *update* data compared to using DSEB to *edit* data is:

1. For the DSEB and DSU functions, the template is not used during editing or updating; it is only used during enhanced batch processing, when you call the File Manager REXX external function PRINT with SNGL or TABL format.

The difference between using DSU to *update* data compared to using DSEB to *edit* data is:

- DSU operates on a “per record” basis. That is, each record in a data set is treated separately, in sequence.
- DSEB allows you to move between the records in a data set as you choose, similar to the way you can scroll around a data set in an edit panel.

For details on using the DSEB and DSU functions, see [Enhancing File Manager processing on page 517](#).

Task	Panel	Function
	<ul style="list-style-type: none">◦ DSU operates on a “per record” basis. That is, each record in a data set is treated separately, in sequence.◦ DSEB allows you to move between the records in a data set as you choose, similar to the way you can scroll around a data set in an edit panel.	

For details on using the DSEB and DSU functions, see [Enhancing File Manager processing on page 517](#).

With any of these panels or functions, you can supply an existing template (created dynamically or from a copybook), supply a copybook, or create a new dynamic template. If you supply a copybook, then File Manager compiles it into a template before use.

Chapter 2. Getting started with File Manager

These topics provide an overview of the user interface and general methods for working within File Manager panels.

The major tasks described include starting File Manager, working with data sets, members, selection lists, and resources, issuing commands, and getting help.

Starting and exiting File Manager

File Manager is an ISPF-developed application and is usually run from within an ISPF session. Exiting from File Manager returns you to your ISPF session. File Manager panels can also be invoked from outside of the File Manager application.

A subset of File Manager functions is available in non-ISPF mode (batch processing). See [Functions on page 1241](#).

Starting File Manager

For information about running File Manager in non-ISPF mode (batch processing), see [Functions on page 1241](#).

How you start File Manager in ISPF depends on how it has been installed on your system. Typically, File Manager is installed as an option on your z/OS® Primary Option Menu:

Figure 3. z/OS® Primary Option Menu panel showing File Manager option

```
Menu Utilities Compilers Options Status Help
-----
z/OS Primary Option Menu
0 Settings      Terminal and user parameters
1 View         View data
2 Edit         Create or change source data
3 Utilities     Perform utility functions
4 Foreground   Interactive language processing
5 Batch        Submit job for language processing
6 Command      Enter TSO or Workstation commands
7 Dialog Test  Perform dialog testing
9 IBM Products IBM program development products
10 SCLM        SW Configuration Library Manager
11 Workplace   ISPF Object/Action Workplace
S SDSF        Spool Display and Search Facility
F File Manager File Manager for z/OS

Enter X to Terminate using log/list defaults
Option ==>> F_____
```

To start File Manager:

1. Select the File Manager option from the z/OS® Primary Option Menu.



Note: If File Manager is not an option on your menu, ask your system administrator to explain the startup process used at your site.

When you start File Manager, the File Manager Primary Option Menu is shown, with the current version information displayed in a pop-up message box.

Figure 4. File Manager Primary Option Menu panel with version information

```

Process  Options  Help
-----
File Manager                Primary Option Menu

0  Settings      Set processing options      User ID . : USERID
1  View          View data                   System ID : FMD2
2  Edit          Edit data                   Appl ID . : FMN
3  Utilities     Perform utility functions   Version . : 14.1.20
4  Tapes        Tape specific functions     Terminal. : 3278
5  Disk/VSAM    Disk track and VSAM CI functions
6  OAM          Work with OAM objects       Screen. . : 1
7  Templates    Create, edit, or update templates
8  HFS          Access Hierarchical File System
X  Exit         Terminate File Manager      Date. . . : 2022/11/11
                                      Time. . . : 11:02

IBM* File Manager for z/OS Version 14 Release 1 Modification 20
Licensed Materials - Property of IBM* and HCL**
5655-Q42
(C) Copyright IBM Corp. 1986, 2017 - All Rights Reserved.
(C) Copyright HCL Technologies Ltd. 2019, 2023 - All Rights Reserved.
* Trademark of International Business Machines
** Trademark of HCL Technologies Limited

Command ==>
F1=Help      F2=Split      F3=Exit      F4=CRetrieve  F7=Backward  F8=Forward
F9=Swap      F10=Actions   F12=Cancel

```

2. Press Enter to close the version window.

Related topics

[Primary Option Menu panel on page 970](#)

Checking your File Manager version

To display the full version information for File Manager, enter VER on the Command line of any panel. The current File Manager version number and the PTF number for each File Manager component is displayed in a window.

As File Manager is an ISPF application and ISPF applications are typically not capable of running in an authorized state, File Manager will not (unless specific ISPF customization has occurred) be authorized under ISPF. However, File Manager may run in an authorized state when used in a batch job.

Figure 5. File Manager Primary Option Menu panel with example PTF information

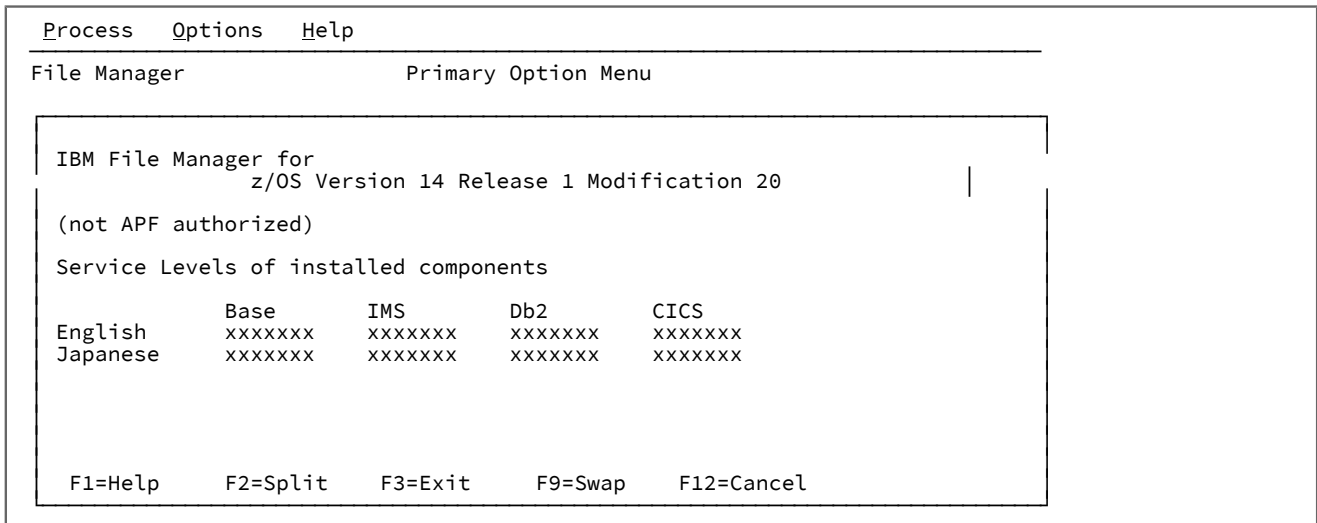

An alternative way to display version information is to select **Help > 6. About** from the Action Bar on any panel. The current File Manager version number and the PTF number of the File Manager Base component is displayed. The window also shows the copyright information and any notes that are shipped with the product.

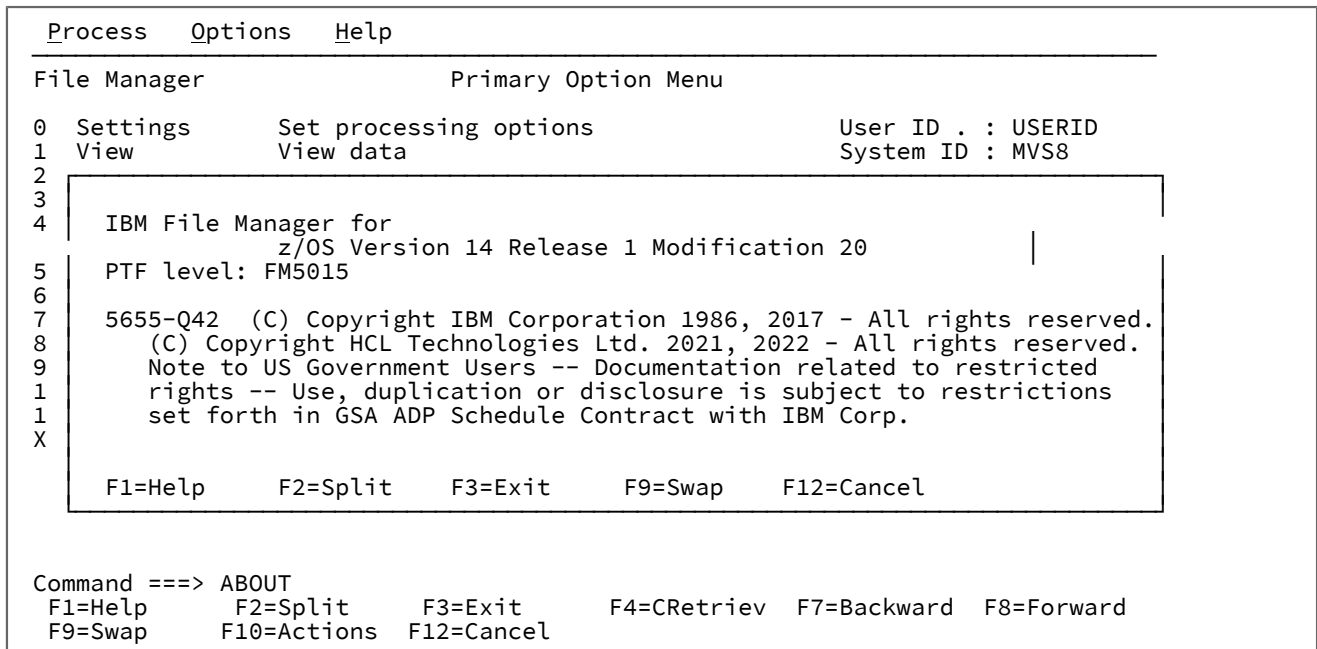

Related topics

- [VER primary command on page 1236](#)
- [ABOUT primary command on page 1118](#)
- [VER \(Display Service Level\) on page 1607](#)

Checking which COBOL compiler you're using

File Manager uses the currently loaded COBOL compiler to create a template from a COBOL copybook.

To display details about the current COBOL compiler, enter SHOWCOB on the Command line of any panel. File Manager displays details about the current COBOL compiler in a window.

Related topics

[SHOWCOB primary command on page 1223](#)

Exiting from File Manager

You can exit from File Manager from the Primary Option Menu panel in any of the following ways:

- Press the Exit function key (F3).
- Enter `x` (or `EXIT` or `END`) on the Command line.
- Select **Process> Exit from File Manager** from the Action Bar.

To exit the application from any panel within File Manager:

- Enter `=x` on the Command line.

Related topics

[END primary command on page 1148](#)

[EXIT primary command on page 1153](#)

Invoking File Manager panels from outside File Manager

File Manager panels can also be invoked directly from any REXX procedure, TSO clist or ISPF Command line. To do this, enter the function name for the required File Manager panel (as listed in the “Equivalent function” column in [Summary of File Manager panels on page 717](#)). This method of invoking File Manager causes ISPF to display a panel for the specific function allowing you to enter the values required for function processing.

Figure 6. Syntax

```
►► FILEMGR — function_name —————►
                    |
                    | 1 data_set_name
                    |
```

Notes:

- ¹ The *data_set_name* parameter is only allowed for the DSV function, to invoke View (option 1), and the DSE function, to invoke Edit (option 2).

For example, from any ISPF Command line, you can enter the following command to display the File Manager Print Utility (option 3.2) panel:

```
FILEMGR DSP
```

If you specify a valid data set name after DSV (Data Set View) or DSE (Data Set Edit), File Manager:

- Bypasses the entry panel (where you would normally specify the data set name and other options, such as the name of a stored template you might wish to use when displaying the data set).
- Goes directly to viewing or editing the specified data set.

Related topics

[Using File Manager functions in batch jobs on page 508](#)

[Summary of File Manager panels on page 717](#)

[Functions on page 1241](#)

[DSB \(Data Set Browse\) on page 1293](#)

[DSE \(Data Set Edit\) on page 1342](#)

Using the File Manager interface

The File Manager interface is based upon the ISPF model.

Tasks are performed by processing a function, together with its applicable parameters. Panels provide a user-friendly way of selecting a function and supplying the parameter information.

Most functions can be processed in your choice of "foreground" or "batch" mode. In foreground mode, the selected function is processed immediately and any results are returned to you on screen or directed to print outputs, as dictated by your default settings. In batch mode, JCL is generated from the panel information, and then presented to you for editing. You can modify this code and submit it to a processing queue.

Navigating in File Manager

You navigate around File Manager panels in the same way as any other panels under ISPF. That is, you launch processing panels from menu panels, by entering the appropriate menu option number on the Command line. File Manager uses a Primary Options Menu panel to provide access to processing panels that are related to a particular function or group of functions. In some cases, an option on the Primary Options menu leads to another menu panel, from which you can select the required processing panel.

When you know the menu structure well, you can quickly jump to the required panel by entering the full pathway through the menu options. For example, entering 4.2.8 would take you directly to the Exported Stacked Volume Copy panel.

You can also jump to any File Manager panel from any other panel, without having to navigate the menu structure, by using an equals sign (=) to prefix the option number. The equals sign instructs File Manager to start the menu navigation from the Primary Options menu and not from your current location. For example, if you were positioned on the Set Processing Options Menu panel, entering 2 on the Command line would display the Set System Processing Options panel (option 2 on the current menu), while entering =2 would display the Edit Entry panel (option 2 on the Primary Options Menu panel).

To access a panel, choose one of the following methods:

- Type the menu option number on the Command line and press Enter. Repeat for each nested menu until the required processing panel is displayed.
- Type an equals sign followed by the complete menu path to the required panel, separating each menu level with a period, then press Enter.

Many File Manager panels have more information than can be seen in a single screen, particularly when you are running in 80x24 display. When this happens, a message is displayed in the top right corner of the panel.

Figure 7. Example panel showing "More" message

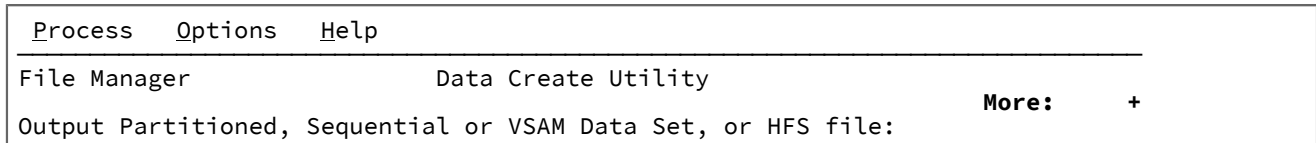

To scroll down the panel, choose one of these methods:

- Press the Forward function key (F8) (this scrolls down by your default scroll amount, usually one screen at a time)
- Enter FORWARD or DOWN on the Command line (these commands scroll down by your default scroll amount, usually one screen at a time)
- Enter BOTTOM on the Command line (this takes you to the bottom of the panel)

To scroll back to the top of the panel, choose one of these methods:

- Press the Backward function key (F7) (this scrolls up by your default scroll amount, usually one screen at a time)
- Enter BACKWARD or UP on the Command line (these commands scroll up by your default scroll amount, usually one screen at a time)
- Enter TOP on the Command line (this takes you to the beginning of the panel)

To exit from any panel, choose one of the following:

- Press the Exit function key (F3).
- Type `x` on the Command line and press Enter.
- Type `END` on the on the Command line and press Enter.

Related topics

[Primary Option Menu panel on page 970](#)

[Scrolling to see data on page 117](#)

[UP primary command on page 1234](#)

[DOWN primary command on page 1146](#)

[TOP primary command on page 1232](#)

[BOTTOM primary command on page 1122](#)

Issuing commands

Within the File Manager panels, you can use "primary" or "prefix" commands to instruct File Manager to perform an action.

You enter primary commands on the Command line of File Manager panels. On many of these panels, the most commonly used primary commands have been assigned to function keys, also known as Programmable Function keys or PF keys.

Some primary commands are exclusive to a particular panel, although most are available on several panels. Where a command is available on more than one panel, its behavior might differ depending upon the context in which it is used.

You enter prefix commands in a special prefix field in most panels, and in the prefix area within the editor panel. Prefix commands are generally exclusive to a panel and details of their operation are provided within each panel description.

Related topics

[Primary commands on page 1118](#)

[Panels and fields on page 717](#)

Specifying quoted strings

Throughout the File Manager interface, you might encounter places where you need to specify a *quoted string*, for example, fully qualified data set names, criteria expressions and so on. In these situations, you can use either the double quotation symbol ("), also called simply a quotation mark, or the single quotation symbol ('), also called an apostrophe. However, you must use matching symbols to open and close the quoted string. For example:

```
"fmndata.test1" and 'fmndata.test1'
```

are both legitimate ways to specify a data set.

The simplest way to include an apostrophe or quotation symbol as a character in your string, is to use the opposite character as the string delimiters. For example:

```
"it's"  
OR  
'he said, "hello"'
```

When your string contains a mix of apostrophes and quotation marks, use two consecutive quotation marks (""") to represent a " character within a string delimited by quotation marks, or two consecutive apostrophes (') to represent a ' character within a string delimited by single quotation marks. For example, to find the string, "he said, "Take it it's yours.", you would type:

```
FIND 'he said, "Take it it''s yours."'
```



Note: This document uses the words *quotation marks*, or *quotes* to mean either " or '.

Specifying a data set and a member name

Many File Manager panels require you to specify the data set that you wish to use for the current process. When the data set is a PDS or a CA-Panvalet or other external library, you must also specify the member name. These panels are collectively referred to as Entry panels, for example, the View Entry panel.

All Entry panels contain the following fields:

Figure 8. Data set/path name specification fields

```

:
Input Partitioned, Sequential or VSAM Data Set, or HFS file:
  Data set/path name . . . . . -----+
  Member . . . . . ----- Blank or pattern for member list
  Volume serial . . . . . ----- If not cataloged
:

```

To specify your data set on any Entry panel:

1. In the Data set/path name field, enter a path name, a fully-qualified data set name, or a name pattern. The name may include a member name or name pattern in parenthesis. If the member is specified here, the associated Member field must be empty.

For details about rules for specifying a path name, see [Specifying an HFS file on page 497](#).

In the case of a copybook, this can be the name of a CA-Panvalet library or external library accessed using the Library Management System Exit.

If you do not enclose the data set/path name in quotation marks, then the default High Level Qualifier (HLQ) is used. Typically, the default is the TSO PREFIX for your user ID.

If you enter a pattern, when the Entry panel is processed, File Manager displays a list of the data sets that match the pattern.

Patterns can contain a percent sign (%) to represent a single character, and an asterisk (*) to represent any number of characters within one qualifier. Two asterisks (**) represent any number of characters within any number of qualifiers.

For performance reasons, you should qualify the data set/path name as much as you can.

2. If you specified the name of a partitioned data set (PDS) or a CA-Panvalet or other external library in the **Data set/path name** field (without including a member name or name pattern in parenthesis), then perform either of these actions:
 - Enter a name or name pattern in the **Member** field.

A member name pattern can consist of any characters that are valid in a member name and the following two special pattern characters:

asterisk (*)

Represents any number of characters. As many asterisks as required can appear anywhere in a member name. For example, if you enter *d*, a list of all members in the data set whose name contains "d" is displayed.

percent sign (%)

A place-holding character representing a single character. As many percent symbols as necessary may appear anywhere in a member name. For example, if you enter `****`, a list of all members in the data set/path whose name is four characters in length is displayed.

If you perform either of these actions

- Do not include a member name or name pattern in parenthesis in the **Data set/path name** field, and leave the **Member** field blank or you specify a pattern in the **Member** field,
- Include a member name pattern in parenthesis in the **Data set/path name** field and leave the **Member** field blank,

File Manager displays a member name list when the Entry panel is processed and the data set has been specified or selected.

- If the entry panel you are using includes the option, **Advanced member selection**, and you want to select a range of PDS(E) members based on one or more criteria, select that option to display the Advanced Member Selection panel.

For details about selecting a range of PDS(E) members, see [Selecting a range of PDS\(E\) members on page 70](#).

3. For data sets which have not been cataloged, enter the serial number of the volume which contains the data set in the **Volume serial** field.
4. Complete the remaining panel-specific fields, and then press Enter to process the panel function.

If both the data set/path name and the member name have been fully specified, the panel action proceeds to its next stage.

If you entered a pattern for the data set/path name or member name, the Data Set Selection panel is displayed, followed by the Member Selection panel, as needed. When you have made your selections from these panels, the Entry panel action proceeds to its next stage.

5. When the Data Set Selection panel is displayed, select your data set by entering an `s` in the **Sel** field adjacent to the required data set. You can only select one name from this list.
6. When the Member Selection panel is displayed, select your members by typing an `s` in the **Sel** field next to each member or with the SELECT primary command, and then pressing Enter.

You can select as many names as required from this list. When the panel is processed, the first member on the list is used in the relevant function. When the function is completed, the next member on the list is used. For example, if you are selecting several members to be edited, the first member is displayed in the Edit Session panel. When you exit this panel, the next member is displayed, and so on, until all selected members have been processed.

**Note:**



- a. To reset values entered in the prefix area that have not yet been processed, use the RESET primary command.
- b. To re-read the directory and display the current member list, use the REFRESH primary command.

7. When you are selecting members, you might find it useful to sort the list of displayed members. To do this, perform either of these actions
- Use the SORT primary command to sort the member list by up to two of the displayed columns. The field names are the column headings. For example, `SORT SIZE CREATED` sorts the list of members first by size and then by the date created.
 - Place the cursor on the column header of the column you want to sort and press Enter.



Note: When you sort members, the sequence (ascending or descending) for a given column is predetermined and consistent with ISPF.

Examples of data set name patterns

The examples below assume that the following data sets exist under the USERID high-level qualifier:

```
USERID.FMN.DATA
USERID.FMN.TEMPLATES
USERID.COBOL.COPY
USERID.COBOL.SOURCE
USERID.PLI.COPY
USERID.PLI.SOURCE
USERID.MISC.DATA.BACKUP
USERID.WORK
```

Example 1

Entering the following pattern (with a single asterisk):

```
'USERID.*'
```

displays the only item with exactly one level of qualifier after USERID:

```
USERID.WORK
```

Example 2

Entering the following pattern (with two asterisks):

```
'USERID.**'
```

displays the complete list of data sets with the USERID high-level qualifier.

Example 3

Entering the following pattern:

```
'USERID.*.%%%%'
```

displays the following list (containing those data sets with exactly three qualifiers, whose third-level qualifier contains exactly four characters):

```
USERID.FMN.DATA  
USERID.COBOBOL.COPY  
USERID.PLI.COPY
```

Examples of specifying a member name or pattern

The examples below assume that the following members exist within the data set name, FMNUSER.DATA:

```
DATA1  
FMNCDATA  
FMNCTAM  
FMNCTEM  
FMNCTMP  
NEWDATA  
NEWSTUFF  
TEMPA  
TEMPB
```

Example 1

Entering the following details on an Entry panel:

```
:  
  Data set name . . . . . FMNUSER.DATA  
  Member . . . . . _____  
:
```

displays the entire member name list:

```
DATA1  
FMNCDATA  
FMNCTAM  
FMNCTEM  
FMNCTMP  
NEWDATA  
NEWSTUFF  
TEMPA  
TEMPB
```

Example 2

Entering the following details on an Entry panel:

```
:  
  Data set name . . . . . FMNUSER.DATA  
  Member . . . . . FMNCT*  
:
```

displays the member name list:

```
FMNCTAM  
FMNCTEM  
FMNCTMP
```

Example 3

Entering the following details on an Entry panel:

```

:
Data set name . . . . . FMNUSER.DATA(NEWDATA)
Member . . . . .
:

```

displays details for the member NEWDATA in data set FMNUSER.DATA.

Example 4

Entering the following details on an Entry panel:

```

:
Data set name . . . . . FMNUSER.DATA(TEM*)
Member . . . . .
:

```

displays the member name list:

```

TEMPA
TEMPB

```

Example 5

Entering the following details on an Entry panel:

```

:
Data set name . . . . . FMNUSER.DATA(*)
Member . . . . .
:

```

displays the entire member name list:

```

DATA1
FMNCDATA
FMNCTAM
FMNCTEM
FMNCTMP
NEWDATA
NEWSTUFF
TEMPA
TEMPB

```

Related topics

- [Selecting a range of PDS\(E\) members on page 70](#)
- [Browse Entry panel on page 751](#)
- [Edit Entry panel on page 862](#)
- [Data Create Utility panel on page 824](#)
- [Print Utility panel on page 977](#)
- [Copy From panel on page 789](#)
- [Copy To panel on page 796](#)
- [Find/Change Utility panel on page 901](#)
- [AFP Print Browse panel on page 730](#)
- [Load Module Information panel on page 927](#)
- [Compare Utility: "Old" and "New" panels on page 764](#)

- [Template Workbench panel on page 1072](#)
- [Data Set Selection panel on page 829](#)
- [Member Selection panel on page 946](#)
- [SORT primary command on page 1224](#)
- [RESET primary command on page 1208](#)
- [REFRESH primary command on page 1205](#)
- [Selecting a range of PDS\(E\) members on page 70](#)

Specifying an MQ manager or queue

Many File Manager panels allow you to specify the name of an MQ manager or queue that you wish to use for the current process.

Where allowed, you specify the name of the MQ manager or queue in the data set name field in the form:

```
MQ:managerid:queuename
```

Where:

managerid

The ID of the MQ manager (the 4-character subsystem ID).

queuename

The name of a queue managed by that manager.

If you enter a pattern, when the Entry panel is processed, File Manager displays a selection list allowing you to select a manager or a queue.

Patterns can contain a percent sign (%) to represent a single character, and an asterisk (*) to represent any number of characters within one qualifier. Two asterisks (**) represent any number of characters within any number of qualifiers.

Related topics

- [Browse Entry panel on page 751](#)
- [Compare Utility: "Old" and "New" panels on page 764](#)
- [Copy From panel on page 789](#)
- [Copy To panel on page 796](#)
- [Create panel on page 820](#)
- [Edit Entry panel on page 862](#)
- [Find/Change Utility panel on page 901](#)
- [Print Utility panel on page 977](#)
- [View Entry panel on page 1092](#)

Specifying a CICS® resource

Many File Manager panels and batch functions allow you to specify the name of a CICS® resource that you wish to use for the current process.

To specify a CICS® resource from the File Manager Base component or Eclipse plug-in (not from FM/CICS), use the notation shown here.

The same notation applies to both panel and keyword fields. You can only specify generic values on panels.

```
rt: applid: rname
```

Where:

rt

Resource type. Valid values are:

FI

For a CICS® file.

TD

For a Transient Data Queue.

TS

For a Temporary Storage Queue.

applid

The VTAM® applid of the CICS® system. You can specify a generic name to display a list of CICS® systems if an FMNCICS DD describing CICS® applids has been allocated to the ISPF session. See the *File Manager Customization Guide* for details.¹

rname

The name of the resource. You can specify a generic name to select from a list.

Patterns (only usable on panels) can contain a percent sign (%) to represent a single character, and an asterisk (*) to represent any number of characters within one qualifier. Two asterisks (**) represent any number of characters within any number of qualifiers.

For a list of functions that allow you to access CICS® resources from ISPF using the File Manager editor or browser, see [Table 1: Functions allowing access to CICS resources on page 50](#).

Related topics

- [Accessing CICS resources on page 50](#)
- [Browse Entry panel on page 751](#)
- [Compare Utility: "Old" and "New" panels on page 764](#)
- [Copy From panel on page 789](#)
- [Copy To panel on page 796](#)
- [Create panel on page 820](#)

1. To specify a CICS® resource from File Manager when running under FM/CICS, omit the *applid* parameter from the resource name:

```
rt: rname
```

[Edit Entry panel on page 862](#)

[Find/Change Utility panel on page 901](#)

[Print Utility panel on page 977](#)

[View Entry panel on page 1092](#)

Accessing CICS® resources

You can access CICS® resources from the File Manager Base component. [Table 1: Functions allowing access to CICS resources on page 50](#) shows the functions that allow you to specify a CICS® resource.

Table 1. Functions allowing access to CICS® resources

Option	Description	Function
	Browse	DSB
1	View ²	DSV
2	Edit ²	DSE
3.1	Create	DSG
3.2	Print	DSP
3.3	Copy	DSC
3.6	Find/Change	FCH
3.11	Compare	DSM
10	FM/CICS functions ³	
	Data Set Edit Batch	DSEB
	Data Set Update	DSU

Examples of accessing CICS® resources

Shown here are two examples of accessing CICS® resources.

Example 1: Searching and editing a CICS® Temporary Storage Queue

To search and edit a CICS® Temporary Storage Queue, follow these steps:

2. Plus commands: APPEND, COPY, CREATE, REPLACE, SAVEAS.
3. See *File Manager for z/OS User's Guide and Reference for IMS Data*.

1. From the Primary Option Menu panel, select option 2 (Edit) to display the Edit Entry panel.
2. In the **Data set/path name** field, type "TS:" as shown in [Figure 9: Specifying CICS temporary storage queues on page 51](#).

The "TS:" indicates to File Manager that you want to edit one or more *Temporary Storage Queues* from a CICS® application.



Note: To edit CICS® *Transient Data Queues*, type "TD:"; to edit CICS® *files*, type "FI:".)

Figure 9. Specifying CICS® temporary storage queues

Process	Options	Help
File Manager		
Edit Entry Panel		
Input Partitioned, Sequential or VSAM Data Set, or HFS file:		
Data set/path name	IS:	_____ +
Member	_____	Blank or pattern for member list
Volume serial	_____	If not cataloged
Start position	_____	_____ +
Record limit	_____	Record Sampling _____
Inplace edit	_____	(Prevent inserts and deletes)
Copybook or Template:		
Data set name	_____	_____
Member	_____	Blank or pattern for member list
Processing Options:		
Copybook/template	Start position type	Enter "/" to select option
3 1. Above	1. Key	— Edit template Type (1,2,S)
2. Previous	2. RBA	— Include only selected records
3. None	3. Record number	— Binary mode, reclen _____
4. Create dynamic	4. Formatted key	— Create audit trail
		— Use I/O exit
Command ==>		
F1=Help	F2=Split	F3=Exit
F9=Swap	F10=Actions	F12=Cancel
	F4=Expand	F7=Backward
		F8=Forward

3. Press Enter.

When you specify the type of CICS® resource ("TS:", "TD:", or "FI:") on an entry panel, but without any further qualification, File Manager next displays the CICS® Applid Selection List panel which lists the available CICS® applications as shown in [Figure 10: List of CICS applications on page 51](#).

Figure 10. List of CICS® applications

Process	Options	Help
File Manager		
CICS Applid Selection list		Row 00001 of 00023
Applid	Status	Description
*	*	*
— CICSDEV1	Active	Development system 1
— CICSDEV2	Active	Development system 2
— CICSTST1	Inactive	Testing system 1
— CICSTST2	Inactive	Testing system 2
— CICSTST3	Inactive	Testing system 3
— CICSTST4	Active	Testing system 4
— CICSPRD1	Inactive	Production system 1
:		
Command ==>		
F1=Help	F2=Split	F3=Exit
F8=Forward	F9=Swap	F10=Left
	F4=CRetriev	F5=RFind
	F11=Right	F12=Cancel
		Scroll PAGE
		F7=Backward

- Select the CICS® application you want by typing "s" in the entry field next to the relevant applid (in this case, applid CICSTST1) as shown in [Figure 11: Selecting a CICS application on page 52](#).

Figure 11. Selecting a CICS® application

Process	Options	Help
File Manager	CICS Applid Selection list	
		Row 00001 of 00023
Applid	Status	Description
* * *		
— CICSTST1	Inactive	Testing system 1
— CICSTST2	Inactive	Testing system 2
— CICSTST3	Inactive	Testing system 3
— CICSTST4	Inactive	Testing system 4
— CICSPRD1	Inactive	Production system 1
:		
Command ==>		Scroll PAGE
F1=Help	F2=Split	F3=Exit
F8=Forward	F9=Swap	F10=Left
	F4=CRetriev	F5=RFind
	F11=Right	F12=Cancel
		F7=Backward

- Press Enter.

File Manager then displays a list of Temporary Storage Queues (because you specified "TS:" on the Edit Entry Panel) for the selected CICS® application as shown in [Figure 12: List of CICS temporary storage queues on page 52](#).

Figure 12. List of CICS® temporary storage queues

Process	Options	Help
File Manager	CICS Temporary Storage Selection List	
		Row 00001 of 00005
Queue	Loc	Items
Size	Max	Min
Tran	Last	SYS
Po ±		
* * *		
— lowercase	AUX	20
— KSDSXX	AUX	20
— KSDS10	AUX	10
— TDTD" TDTD TD	AUX	100
— TDTST10	AUX	10
**** End of data	****	
:		
Command ==>		Scroll PAGE
F1=Help	F2=Split	F3=Exit
F8=Forward	F9=Swap	F10=Left
	F4=CRetriev	F5=RFind
	F11=Right	F12=Cancel
		F7=Backward

- Select the Temporary Storage Queue you want by typing "s" in the entry field next to the relevant queue (in this case, KSDS10) as shown in [Figure 13: Selecting a CICS temporary storage queue on page 53](#).

Figure 13. Selecting a CICS® temporary storage queue

Process	Options	Help							
File Manager		CICS Temporary Storage Selection List						Row 00001 of 00005	
Queue	Loc	Items	Size	Max	Min	Tran	Last	SYS	Po ±
* _ lowercase	AUX	20	6400	320	320	FM	97210	*	*
_ KSDSXX	AUX	20	2560	128	128	FM	98913		
<u>S</u> KSDS10	AUX	10	1280	128	128	FM	14654		
_ TDTD"!TDTD TD	AUX	100	32000	320	320	FM	97194		
_ TDTEST10	AUX	10	3200	320	320	FM	97423		
**** End of data ****									
:									
Command ==>							Scroll PAGE		
F1=Help	F2=Split	F3=Exit	F4=CRetriev	F5=RFind	F7=Backward				
F8=Forward	F9=Swap	F10=Left	F11=Right	F12=Cancel					

7. Press Enter.

File Manager then displays the data in the selected Temporary Storage Queue as shown in [Figure 14: Data in CICS temporary storage queue on page 53](#).

Figure 14. Data in CICS® temporary storage queue

Process	Options	Help							
Edit		TS:CICSTST1:KSDS10				Record AT TOP		Top of 10	
Col 1	Insert	Length 80				Format		CHAR	
-----10-----	-----2-----	-----3-----	-----4-----	-----5-----	-----6-----	-----7--			
***** **** Top of data ****									
0000011	aaaaaaaaaaaaaaaa				6324West aindy		Wa	
0000022	aaaaaaaaaaaaaaaa				6324West aindy		Wa	
0000033	74 Redcliffe St				6324West aindy		Wa	
0000044	74 Redcliffe St				6324West aindy		Wa	
0000055	74 Redcliffe St				6324West aindy		Wa	
0000066	74 Redcliffe St				6324West aindy		Wa	
0000077	74 Redcliffe St				6324West aindy		Wa	
0000088	74 Redcliffe St				6324West aindy		Wa	
0000099	74 Redcliffe St				6324West aindy		Wa	
00001010	74 Redcliffe St				6324West aindy		Wa	
***** **** End of data ****									
:									

Example 2: Searching and modifying a CICS® file

To search and modify a CICS® file, follow these steps:

1. From the Primary Option Menu panel, select option 2 (Edit) to display the Edit Entry panel.
2. In the **Data set/path name** field, type "**FI:CICSTST1**" as shown in [Figure 15: Specifying CICS files from a CICS application on page 54](#).

The "**FI:**" indicates to File Manager that you want to edit one or more CICS® *files*, and the "**CICSTST1**" indicates that you want to edit the files from the CICS® application, CICSTST1.

Figure 15. Specifying CICS® files from a CICS® application

```

Process  Options  Help
-----
File Manager          Edit Entry Panel

Input Partitioned, Sequential or VSAM Data Set, or HFS file:
Data set/path name FI:CICSTST1 +
Member . . . . . _____ Blank or pattern for member list
Volume serial . . . . . _____ If not cataloged
Start position . . . . . _____ +
Record limit . . . . . _____ Record Sampling _____
Inplace edit . . . . . _____ (Prevent inserts and deletes)

Copybook or Template:
Data set name . . . . . _____
Member . . . . . _____ Blank or pattern for member list

Processing Options:
Copybook/template Start position type Enter "/" to select option
3 1. Above          - 1. Key          - Edit template  Type (1,2,S)
  2. Previous       - 2. RBA         - Include only selected records
  3. None           - 3. Record number - Binary mode, reclen _____
  4. Create dynamic 4. Formatted key - Create audit trail
                                     - Use I/O exit

Command ==>
F1=Help      F2=Split    F3=Exit     F4=Expand   F7=Backward F8=Forward
F9=Swap      F10=Actions F12=Cancel
    
```

3. Press Enter.

When you specify the type of CICS® resource ("TD:", "TS:", or "FI:") *and* the CICS® application on an entry panel, but without specifying the name of the CICS® resource, File Manager next displays a selection list of the Transient Data Queues, Temporary Storage Queues, or files for the specified CICS® application. In this case, File Manager displays a list of CICS® files for the specified CICS® application (CICSTST1) as shown in [Figure 16: Selection list of CICS files on page 54](#).

Figure 16. Selection list of CICS® files

```

Process  Options  Help
-----
File Manager          CICS File Selection List          Row 00001 of 00020
File  Data Set Name          Type  O E R U A B D SY ±
*  *  *  *  *  *  *  *  *  *  *  *  *  *  *  *  *  *  *  *  *  *  *
- DFHCSD  CICS.FILE.DFHCSD          KSDS  O E R U A B D
- DFHDBFK          VSAM  C E R U A B D
- DFHLRQ  CICS.FILE.DFHLRQ          KSDS  O E R U A B D
- ESDS10  CICS.FILE.ESDS           KSDS  O E R U   B _
- EZACACHE EZACACHE                 TABL  C U R U A B D
- EZACONFG CICS.FILE.EZACONFG       KSDS  C D R   _ B _
- FMDATA  CICS.FILE.FMDATA         KSDS  C E R   _ _ _
- PMRRDS1 CICS.FILE.PMRRDS1       KSDS  C E R   _ _ _
- RRDS10  CICS.FILE.RRDS10        KSDS  O E R U   B _

:

**** End of data ****

Command ==>
F1=Help      F2=Split    F3=Exit     F4=CRetrie v F5=RFind    F7=Backward
F8=Forward   F9=Swap     F10=Left    F11=Right    F12=Cancel
    
```

4. You can now proceed to work with any of the CICS® resources listed.

For more information about working with CICS® resources in File Manager, see File Manager for z/OS User's Guide and Reference for CICS.

Running File Manager batch functions with a CICS® resource

When you run a File Manager batch function with a CICS® resource, you must specify the resource type, VTAM® applid of the CICS® system, and the name of the CICS® resource. You cannot specify generic values. See [Specifying a CICS resource on page 48](#).

[Table 1: Functions allowing access to CICS resources on page 50](#) shows you the File Manager batch functions you can use with CICS® resources.

When you run File Manager batch functions with a CICS® resource, be aware that:

- If you are specifying a batch keyword for a CICS® TS queue that contains special or lowercase characters, or a CICS® TD queue that contains lowercase characters, you must enclose the name of the resource in quotation marks like this:

```
c'rt:applid: name'
```

Any single quotation mark in the resource name must be repeated. For example, to specify the TS queue name 'quoted name', enter:

```
DSNIN=c'TS:MYCICS:''quoted name'''
```

- For DSG and DSC functions:
 - The DISP=MOD parameter *appends* to the TD (transient data) and TS (temporary storage) queues. Records are always appended for CICS® files.
 - The DISP=OLD parameter *replaces* the TD (transient data) and TS (temporary storage) queues. This is ignored for CICS® files where the data is always appended

Shown here are some examples of running File Manager batch functions with a CICS® resource.

Example 1: Data set Generate: Creating a TS queue using a template

```
$$FILEM DSG DSNOUT=TS:PRODCICS:MYTSQ
$$FILEM RECSIZE=2000,
$$FILEM DISP=OLD,
$$FILEM TCOUT=MY.TEMPLATE.DSN(MYTP),
$$FILEM NLRECS=100
```

Example 2: Data Set Copy: Copying a flat file to a CICS® intrapartition TD queue

```
$$FILEM DSC DSNIN=MYHLQ.QUEUE.DATA,
$$FILEM DSNOUT=TD:PRODCICS:MYIQ
```

Example 3: Data Set Print: Printing a CICS® file using a template

```
$$FILEM DSP FORMAT=TABL,
$$FILEM TCIN=MY.TEMPLATE.DSN(MYTP),
$$FILEM DSNIN=FI:PRODCICS:MYKSDS
```

Example 4: Find/Change: Making changes to a CICS® file

```
$$FILEM FCH ,
$$FILEM DSNIN=FI:PRODCICS:MYKSDS
CAPS ON
```

```
C 'ABC' 'DEF' 12 14
/+
```

Example 5: Data Set Edit Batch: Navigating a CICS® file backwards and changing a name

```
$$FILEM DSEB DSNIN=FI:PRODCICS:MYKSDS,PROC=*
BOT()
DO UNTIL(UP(1) = 'TOF')
  IF FLDI(3,'=','JOHN') THEN DO
    OVLY_OUT('BILL',3)
    UPDATE()
  LEAVE
END
END
/+
```

Example 6: Data Set Copy: Copying a flat file into a temporary storage queue

```
$$FILEM DSC DSNIN=myhlq.flatfile,
$$FILEM DSNOUT=TS:TESTCICS:MYTSQ
```

Example 7: Data Set Compare: Comparing two files on different CICS® systems

```
$$FILEM DSCMP TYPE=RECORD,
$$FILEM SYNCH=ONETOONE,
$$FILEM LIST=DELTA,
$$FILEM WIDE=YES,HIGHLIGHT=YES,
$$FILEM DSNOLD=FI:PRODCICS:MYKSDS,
$$FILEM DSNNEW=FI:TESTCICS:MYKSDS
```

Specifying a remote resource

For functions in the File Manager ISPF interface that support remote resources you can prefix the resource name as follows:

```
RM: remote_id: resource_name
```

Where:

remote_id

Is the 1-8 character remote connection definition. A generic pattern is supported but you must specify a non-blank resource name.

resource name

Any data set, path or CICS® resource name can be specified.



Note: Quotes are invalid when specifying a remote data set name. You must specify the fully qualified name. Generic names are supported but avoid using ** and * as that may result in long catalog searches on the remote system.

Accessing remote resources

Functions supporting remote resources

You can access resources residing on a remote system from the File Manager Base component.

Table 2: Functions allowing access to remote resources on page 57 shows the functions that allow you to specify a remote resource for both the primary data set and/or the template data set.

Table 2. Functions allowing access to remote resources

Option	Description	Function
	Browse	DSB
1	View	DSV
2	Edit	DSE
3.2	Print	DSP
3.3	Copy	DSC

Example 1. Viewing a data set on a remote system

Example

In this example the definition for the TEST system has not been defined and the data set FMN.FMDATA can be found on the testing LPAR.

Figure 17. Viewing a data set on a remote system

```

Process  Options  Help
-----
File Manager          View Entry Panel

Input Partitioned, Sequential or VSAM Data Set, or HFS file:
  Data set/path name RM:TEST:FMN.FMDATA +
  Member . . . . . _____ (Blank or pattern for member list)
  Volume serial . . _____ (If not cataloged)
  Start position . . _____ +
  Record limit . . . _____ Record sampling

Copybook or Template:
  Data set name . . _____
  Member . . . . . _____ (Blank or pattern for member list)

Processing Options:
Copybook/template  Start position type  Enter "/" to select option
 3  1. Above         - 1. Key                -- Edit template   Type (1,2,S)
   2. Previous      - 2. RBA                -- Include only selected records
   3. None          - 3. Record number     -- Binary mode, reclen 80
   4. Create dynamic 4. Formatted key

Command ==>
F1=Help    F2=Split    F3=Exit    F4=Expand    F7=Backward  F8=Forward
F9=Swap    F10=Left   F11=Right  F12=Cancel

```

Press Enter.

```

Process  Options  Help
-----
File Manager          Remote System Definition
Name . . . TEST
Description _____
Port . . . 0
Address . . _____ +
User . . . _____
Password .
New Password .

| No connections defined |
Command ==>
F1=Help   F2=Split   F3=Exit   F4=Expand   F7=Backward F8=Forward
F9=Swap   F10=Left   F11=Right F12=Cancel
    
```

You will have to define a new connection. See [Remote System Definition panel on page 1009](#) for a description of the fields.

```

Process  Options  Help
-----
File Manager          Remote System Definition
Name . . . TEST
Description Test LPAR
Port . . . 2820
Address . . pthfmd1 _____ +
User . . . MYUSER
Password .
New Password .

| No connections defined |
Command ==>
F1=Help   F2=Split   F3=Exit   F4=Expand   F7=Backward F8=Forward
F9=Swap   F10=Left   F11=Right F12=Cancel
    
```

Fill out the values and press Enter to define the new connection.

```

Process  Options  Help
-----
View          RM:TEST:FMN.FMDATA          Connection successful

          Col 1          Insert Length 80          Record AT TOP          Format CHAR
          -+-----+-----+-----+-----+-----+-----+-----+-----+
*****  ****  Top of data  ****
0000001  01Andrew freddy          .5....&.....
0000002  01Andrew Audit          .5....&.....
0000003  01Andrew NOaudit          .5....&.....
0000004  01Graham Prestcott          .....
0000005  01Bill Somers          .....
0000006  01Ted Dexter          .....-.....
0000007  01David Nelson          .u.....
0000008  01David Nelson          .u.....
0000009  01David Nelson          .u.....
0000010  01David Nelson          .....
0000011  01David Nelson          .u.....
0000012  01David Nelson          .....
0000013  01Jon Alexidess          .....
0000014  01David Nelson          .u.....
0000015  01Melissa Bank15          ...-.....

Command ==>
F1=Help      F2=Zoom      F3=Exit      F4=CRetriev  F5=RFind     F6=RChange
F7=Up        F8=Down      F9=Swap      F10=Left     F11=Right    F12=Cancel
Scroll CSR

```

Example 2. Copy a remote load library to the local system

Example

In this example you will copy FMN.LOAD from the remote system to our development system.

```

Process  Options  Help
-----
File Manager          Copy Utility

From Partitioned, Sequential or VSAM Data Set, or HFS file:
Data set/path name   . . RM:TEST:FMN.LOA*          +
Member . . . . . *          (Blank or pattern for member list)
Volume serial . . . . .          (If not cataloged)
Start key . . . . .          key or slot
Skip count . . . . . Include          Repeat skip
Copy count . . . . . ALL          number of records to be copied

From Copybook or Template:
Data set name . . . . .
Member . . . . .          (Blank or pattern for member list)

Processing Options:
Copybook/template   Enter "/" to select option
  1. Above          _ Batch execution          _ Advanced member selection
  2. None           _ Use proc *              _ / Skip member name list
  3. Create dynamic _ Ignore length mismatch  _ REXX member selection: D
_ Edit template     _ JCL Source format        _ Directory integrity
_ Type (1,2,S)     _ MQ Include descriptor    _ Report PDS record counts

Command ==>
F1=Help      F2=Zoom      F3=Exit      F4=CRetriev  F5=RFind     F6=RChange
F7=Up        F8=Down      F9=Swap      F10=Left     F11=Right    F12=Cancel
Scroll CSR

```

Press Enter.

```

Process  Options  Help
-----
File Manager          Copy From Data Set Selection          Row 00001 of 00002

Data Set Selection for RM:TEST:FMN.LOA*
  Data Set Name              Type  Volume  Created
  FMN.LOA*                   *      *      *
S FMN.LOAD                   NVSAM D$FM07 2002.308
  FMN.LOADCIC                 PDSE  D$FM17 2012.222
**** End of data ****

Command ==>
F1=Help      F2=Split    F3=Exit     F4=CRetriev F5=RFind    Scroll CSR
F8=Forward   F9=Swap     F10=Left    F11=Right   F12=Cancel  F7=Backward

```

Select a data set and press Enter to select data set from remote test system.

```

Process  Options  Help
-----
Copy from RM:TEST:FMN.LOAD(*)

To Partitioned, Sequential or VSAM Data Set, or HFS file:
  Data set/path name . . 'FMN.LOCAL.LOAD' +
  Member name (or mask) . _____ (Blank or pattern for member list)
  Volume serial . . . . . _____ (If not cataloged)

Processing Options:
  Disposition              Execution "/" options          ISPF Packing
  1 1. Old or Reuse        / Replace members             4 1. Asis
  2 2. Mod                 _ Binary mode, reclen _____ 2. Pack
  Stats Option
  1 1. Off                 3. Unpack
  2 2. Force               4. None
                          5. Skip

Command ==>
F1=Help      F2=Split    F3=Exit     F4=CRetriev F5=RFind    Scroll CSR
F8=Forward   F9=Swap     F10=Left    F11=Right   F12=Cancel  F7=Backward

```

You are copying to a local load library that doesn't exist. Press Enter.

Process	Options	Help
Allocate FMN.LOCAL.LOAD		
New Data Set Organization:		
Select option	Instructions	
<u>6</u> 1. KSDS	The above data set does not exist.	
2. ESDS	To define or allocate a new data set select a data set organization and press ENTER or press PF3/EXIT or PF12/CANCEL to return without allocation.	
3. RRDS		
4. VRRDS		
5. LDS		
6. Non VSAM		
7. IAM KSDS	For a new data set, enter a data set name below to copy existing allocation attributes.	
8. IAM ESDS		
Existing Data Set:		
Like data set	RM:TEST:FMN.LOAD	
Volume serial	_____	
Command ==>		
F1=Help	F2=Split	F3=Exit
F8=Forward	F9=Swap	F10=Left
F4=CRetriev	F5=RFind	F7=Backward
F11=Right	F12=Cancel	

Press Enter to inherit the characteristics of the remote data set.

Process	Options	Help
Allocate FMN.LOCAL.LOAD		More: +
Specify a model data set, volume, SMS class names, or leave blank for defaults:		
Like data set . . .	RM:TEST:FMN.LOAD	
Volume serial . . .	_____ (Blank for system default volume)	
Device type . . .	_____ (Generic unit or device address)	
Data class . . .	_____ (Leave blank for default)	
Storage class . . .	_____ (Leave blank for default)	
Management class	_____ (Leave blank for default)	
Space Requirements:		
Space unit . . .	BLKS	BLKS, TRKS, CYLS, KB, or MB
Primary units . .	549	quantity of above units
Secondary units .	1178	quantity of above units
Directory blocks	26	leave blank for SMS default
Record format . .	U	if new format: U,F,V, or D, with B,S,A,M
Record length . .	0	
Block size . . .	6144	physical output block size
Data set type . .	PDS	LIBRARY, PDS, BASIC, EXTR, EXTP or LARGE
Command ==>		
F1=Help	F2=Split	F3=Exit
F8=Forward	F9=Swap	F10=Left
F4=CRetriev	F5=RFind	F7=Backward
F11=Right	F12=Cancel	

Press Enter to define the local load library and perform the copy.

```

Process  Options  Help
-----
File Manager                Copy Utility                More:  +
From Partitioned, Sequential or VSAM Data Set, or HFS file:
Data set/path name . . . RM:TEST:FMN.LOAD                +
Member . . . . . *_____ (Blank or pattern for member list)
Volume serial . . . . . _____ (If not cataloged)
Start key . . . . . _____ key or slot
Skip count . . . . . 0_____ Include _____ Repeat skip _____
Copy count . . . . . ALL_____ number of records to be copied
From Copybook or Template:
Data set name . . . . .
Member . . . . . _____ (Blank or pattern for member list)
Processing Options:
Copybook/template      Enter "/" to select option
 2 1. Above            _ Batch execution          Advanced member selection
   2. None             _ Use proc *                / Skip member name list
   3. Create dynamic  _ Ignore length mismatch  _ REXX member selection: D
_ E
_ T 24 member(s) copied; 0 replaced; 0 not copied; 0 in error  ty
F1=Hel                  counts
F9=Swap                 orward
F10=Actions  F12=Cancel

```

Manipulating your view of selection lists

When you are working with selection lists, you can manipulate your view of the information available to focus on the items of interest to you.

To return to the original view of the selection list, enter the RESET primary command.

To rebuild the information required to display the selection list, enter the REFRESH primary command.

The tasks described in this section are:

- [Using primary commands with selection lists on page 62](#)
- [Scrolling to see data on page 63](#)
- [Sorting the data on page 66](#)
- [Finding specific data on page 67](#)
- [Changing the display width of columns on page 67](#)
- [Filtering your selection list on page 68](#)
- [Changing where \(and if\) columns are displayed on page 69](#)
- [Displaying data in hexadecimal on page 69](#)

Related topics

- [REFRESH primary command on page 1205](#)
- [RESET primary command on page 1208](#)

Using primary commands with selection lists

When you are viewing selection lists, you can enter primary commands on the Command line of the panel to perform these functions:

Action

Command

Scroll the data

[BOTTOM primary command on page 1122](#)

[DOWN primary command on page 1146](#)

[LEFT primary command on page 1178](#)

[RIGHT primary command on page 1212](#)

[TOP primary command on page 1232](#)

[UP primary command on page 1234](#)

Scroll to a particular item in the list

[LOCATE primary command on page 1182](#)

Find a particular item in the list

[FIND/FX primary command on page 1157](#)

[RFIND primary command on page 1211](#)

Tailor the displayed data

[RESET primary command on page 1208](#)

[REFRESH primary command on page 1205](#)

[TAILOR primary command on page 1230](#)

Display data in hexadecimal format

[HEX primary command on page 1172](#)

Related topics

[Primary commands on page 1118](#)

Scrolling to see data

To scroll through your data, use the following function keys:

Use this function key

To do this...

Scroll backward (up)

Up function key (F7)

Scroll forward (down)

Down function key (F8)

Scroll right

Right function key (F11)

Scroll left

Left function key (F10)

You can also scroll using the primary commands UP, DOWN, LEFT, RIGHT, TOP, and BOTTOM.

Examples

LEFT 8

Scrolls 8 columns to the left.

LEFT

Scrolls left the number of columns indicated by the **Scroll** field.

LEFT CSR

If the cursor is positioned on a record, scrolls left to the cursor position; otherwise scrolls left one page.

UP 15

Scrolls up 15 lines.

UP

Scrolls up the number of lines indicated by the **Scroll** field.

UP DATA

Scrolls up one line less than a page of data.

Related topics

[UP primary command on page 1234](#)

[DOWN primary command on page 1146](#)

[LEFT primary command on page 1178](#)

[RIGHT primary command on page 1212](#)

[TOP primary command on page 1232](#)

[BOTTOM primary command on page 1122](#)

Controlling how far you scroll

To control how far you scroll when you press one of the scrolling function keys, enter a scroll amount in the **Scroll** field:

Scroll amount

Scrolls...

PAGE

One screen at a time

HALF

Half a screen at a time

DATA

One line or column less than a screen at a time

CSR

To the cursor position (if the cursor is not positioned on a record when the scroll is performed, then the scroll amount defaults to PAGE)

MAX

To the end of the data in the direction indicated by the scrolling function key.

nnnn

A number of columns (when scrolling left or right) or a number of records or lines (when scrolling up or down) at a time

You can temporarily override the amount in the **Scroll** field by typing a scroll amount on the Command line, then pressing a scroll function key. For example, if you enter `8` on the Command line, then press the Right function key (F11), File Manager scrolls right 8 columns.

Scrolling to the first or last line or column

To scroll to the first or last line or first or last column in the selection list, type `MAX` (or `M`) on the Command line, then press one of the scroll function keys. For example, typing `M` then pressing the Right function key (F11) scrolls right to the last column.

You can also scroll to the first or last line by entering `TOP` or `BOTTOM` on the Command line.

Related topics

[TOP primary command on page 1232](#)

[BOTTOM primary command on page 1122](#)

Holding fields on the display when scrolling

You can hold fields so that they are always displayed regardless of how far you scroll.

You can specify a field to be held in either of these ways:

- Set the field attributes for a *single* field:
 1. Scroll (if necessary) so that the field is displayed.
 2. Position the cursor within the field heading and press Enter to display a Field Details panel.
 3. Set the **Hold** value to `Y`.
 4. Press the Exit function key (F3) to return to the selection list.
- Set the field attributes for *one or more* fields:
 1. Enter the TAILOR primary command to display a list of fields together with their field attributes.
 2. Set the **Hold** value to `Y` for each field you want to hold.
 3. Press the Exit function key (F3) to return to the selection list.

Related topics

[TAILOR primary command on page 1230](#)

Sorting the data

You can change the order of the lines in a selection list by specifying the columns to be used in determining the sort order. For each column, you can specify a sort order of:

Ascending (A)

The contents of the column are sorted in ascending order. A down arrow (↓) is shown in the rightmost position of the column heading.

Descending (D)

The contents of the column are sorted in descending order. An up arrow (↑) is shown in the rightmost position of the column heading.

None (N)

The column is not used in determining the order of the lines.



Note: For any selection list, there is a default "held" column for which the sort order is, again by default, ascending (A).

You can specify a column to be used in determining the sort order in any of these ways:

- Setting the column attributes for a *single* column:
 1. Scroll (if necessary) so that the column is displayed.
 2. Perform any of these actions:
 - a. Position the cursor within the column filter and press Enter to display a Column Settings panel.
 - b. Set the **Sort** value to **A**, **D**, or **N** according to how you want the column sorted.
 - c. Press the Exit function key (F3) to return to the selection list.

or

 - a. Position the cursor within the column heading and press Enter. The column sort order is changed to the default. The default sort order for the column can be found in the Column Settings panel.

or

 - a. Tab *past* the column heading (to the rightmost position of the column heading area) and press Enter.
 - b. Each time you tab to this position and press Enter, the sort order rotates through ascending (↓), descending (↑), and none (no arrow displayed).
- Setting the column attributes for *one or more* columns:

Perform either of these actions:

1. Enter the TAILOR primary command to display a list of columns together with their column attributes.
2. Set the **Sort** value to **A**, **D**, or **N** according to how you want the column sorted.
3. Press the Exit function key (F3) to return to the selection list.

or

1. Use the SORT command.



Note: When you change the sort order for a column, the sort order for all other columns is set to none.

Related topics

[TAILOR primary command on page 1230](#)

Finding specific data

To find one or more occurrences of a character string in a selection list, you can use the FIND primary command, which you can abbreviate as F or /.

For example, to search for the next occurrence of the string “Apple” in any mix of uppercase and lowercase, enter this command on the Command line:

```
F APPLE
```

To find the next occurrence of the same string, use the RFIND command, or enter the FIND command with no argument. A message is displayed if the string cannot be found.

You can control the starting point, direction, and extent of the search with one of these optional parameters before or after the search string: NEXT, PREV, FIRST, LAST, ALL.

For example, to search for the last occurrence of the string “Orange”, enter either of these commands on the Command line:

```
F ORANGE LAST
F LAST ORANGE
```

Related topics

[FIND/FX primary command on page 1157](#)

Changing the display width of columns

You can change the display width of columns in a selection list

You can specify the display width of a columns in either of these ways:

- Set the column attributes for a *single* column:
 1. Scroll (if necessary) so that the column is displayed.
 2. Position the cursor within the column heading and press Enter to display a Column Details panel.

3. Set the **Width** value to the number of characters you want to use to display the column.
 4. Press the Exit function key (F3) to return to the selection list.
- Set the column attributes for *one or more* columns:
 1. Enter the TAILOR primary command to display a list of columns together with their column attributes.
 2. Set the **Width** value to the number of characters you want to use to display each column
 3. Press the Exit function key (F3) to return to the selection list.

Related topics

[TAILOR primary command on page 1230](#)

Filtering your selection list

You can restrict the data displayed in a selection list by specifying filters for any of the column data.

Points to consider when you specify a filter:

- Filtering is performed using a generic trailing match. That is, if the start of the data in the column being filtered matches the filter string, it is considered a match.

For example, a filter of `PEA` matches PEA and PEAR, but not APPEAR.

- Matching of data to filters is not case-sensitive.

For example, a filter of `PEA` matches PEA, PEAR, Pea and pear.

- You can specify any of these operators as the first character of the filter:

>

Greater than.

<

Less than.

=

Equal to.

!

Not equal to.

You can specify a filter in any of these ways:

- Set the column attributes for a *single* column:

You can either:

- Overtyping the heading of the column you want to filter with a string.
- Use the Column Details panel:

1. Scroll (if necessary) so that the column is displayed.
 2. Position the cursor within the column heading and press Enter to display a Column Details panel.
 3. Type the filter in the **Filter** field.
 4. Press the Exit function key (F3) to return to the selection list.
- Set the column attributes for *one or more* columns:
 1. Enter the TAILOR primary command to display a list of columns together with their column attributes.
 2. Type the filter in the **Filter** field for each column you want to filter.
 3. Press the Exit function key (F3) to return to the selection list.

Related topics

[TAILOR primary command on page 1230](#)

Changing where (and if) columns are displayed

You can change the order that data columns are displayed in a selection list. You can also suppress columns from being displayed.

To change the order in which data columns in a selection list are displayed:

1. Enter the TAILOR primary command to display a list of columns together with their column attributes.
2. Set the **Order** value for each column according to the order (left to right) that you want the columns displayed. The values you specify must be unique to ensure that the columns are re-ordered as intended.
3. Press the Exit function key (F3) to return to the selection list.

To suppress a data column from being displayed in a selection list are displayed:

1. Enter the TAILOR primary command to display a list of columns together with their column attributes.
2. For any column that you want to suppress from being displayed in the selection list, set the **Order** value to 0 (zero).
Note that columns whose **Order** value is set to 0, are displayed after the other (ordered) columns.
3. Press the Exit function key (F3) to return to the selection list.

Related topics

[TAILOR primary command on page 1230](#)

Displaying data in hexadecimal

To display the data in a selection list in hexadecimal format, use the HEX primary command.

Related topics

[HEX primary command on page 1172](#)

Selecting a range of PDS(E) members

The following File Manager entry panels include the option, **Advanced member selection**:

- [Print Utility panel on page 977](#)
- [Find/Change Utility panel on page 901](#)
- [Copy From panel on page 789](#)
- [Template Build Utility panel on page 1056](#)
- [Load Module Compare - entry panel on page 924](#)
- [Load Module Information panel on page 927](#)
- [Compare Utility: "Old" and "New" panels on page 764](#)

The **Advanced member selection** option lets you select a range of PDS(E) members based on one or more of the following criteria:

- Similar names
- The user ID by which they were last updated
- The date they were created
- The date they were last modified

To select a range of PDS(E) members in this way, select the **Advanced member selection** option on the relevant entry panel and press Enter.

File Manager displays the Advanced Member Selection panel:

Member name

To select a range of PDS(E) members based on their name, perform either of these actions

- Specify the required member name (or a mask) in the **Member name** field.
- To select a range of members with similar names, enter the *"from"* and *"to"* values in the **from** and **to** member name fields respectively.

If you omit the **from** member name value, all members from the beginning of the data set to the member name **to** value are included. File Manager pads the field with blanks to 8 characters.

If you omit the **to** member name value, all members from the member name **from** value to the end of the data set are included. File Manager pads the field with blanks to 8 characters. If you enter an asterisk as the last character in the member name **to** field, File Manager pads the field with high values to 8 characters.

For example, the following Member name range selects all members with a name beginning with D, E, or F:

```
or range from: D_____
              to: F*_____
```

User ID

To select a range of PDS(E) members based on the user ID by which they were last updated, perform either of these actions

- Specify the required user ID (or a mask) in the **Updated by** field.
- To select a range of user IDs, enter the *“from”* and *“to”* values in the **from** and **to** user ID fields respectively.

If you omit the **from** user ID value, all members from the beginning of the data set to the user ID **to** value are included. File Manager pads the field with blanks to 7 characters

If you omit the **to** user ID value, all members from the user ID **from** value to the end of the data set are included. File Manager pads the field with blanks to 7 characters. If you enter an asterisk as the last character in the user ID **to** field, File Manager pads the field with high values to 7 characters.

For example, the following user ID range selects all members with a user ID (by which they were last updated) in the alphabetic range *“GEOFF”* to *“GEORGE”*:

```
from: GEOFF__
to: GEORGE__
```

Date created

To select a range of PDS(E) members based on the date they were created, perform either of these actions

- Specify the required creation date in YYYY/MM/DD format (or a mask) in the **Date created** field. You can specify an asterisk (*) as the last character to indicate a range of dates, or a percent sign (%) in place of a single character to indicate a selection of dates.
- To select a range of creation dates:
 - Enter the *“from”* value (in YYYY/MM/DD format) in the **from** creation date field. If you omit the **from** creation date, or you specify an asterisk as the last character, the unspecified portions of the date default as follows:

DD

= 01

MM

= 01

YYYY

= 0000

No other wildcarding is allowed.

- Enter the *“to”* value (in YYYY/MM/DD format) in the **to** creation date field. If you omit the **to** creation date, or you specify an asterisk as the last character, the unspecified portions of the date default as follows:

DD

= 31

MM

= 12

YYYY

= 9999

No other wildcarding is allowed.

For example, the following creation date range selects all members created between 2004/07/05 and 2004/12/31:

```
from: 2004/07/05  
to: 2004*
```

Date modified

To select a range of PDS(E) members based on the date they were last modified, perform either of these actions

- Specify the required modification date in YYYY/MM/DD format (or a mask) in the **Date modified** field. You can specify an asterisk (*) as the last character to indicate a range of dates, or a percent sign (%) in place of a single character to indicate a selection of dates.
- To select a range of modification dates:
 - Enter the "from" value (in YYYY/MM/DD format) in the **from** modification date field. If you omit the **from** modification date, or you specify an asterisk as the last character, the unspecified portions of the date default as follows:

DD

= 01

MM

= 01

YYYY

= 0000

No other wildcarding is allowed.

- Enter the "to" value (in YYYY/MM/DD format) in the **to** modification date field. If you omit the **to** modification date, or you specify an asterisk as the last character, the unspecified portions of the date default as follows:

DD

= 31

MM

= 12

YYYY

= 9999

No other wildcarding is allowed.

For example, the following modification date range selects all members that were last updated between 2003/11/01 and 2003/12/31:

```
from: 2003/11*
to: 2003
```

Related topics

- [Advanced Member Selection panel on page 726](#)
- [Printing from File Manager on page 402](#)
- [Finding and changing data in multiple PDS members on page 368](#)
- [Copying data sets on page 341](#)
- [Print Utility panel on page 977](#)
- [Find/Change Utility panel on page 901](#)
- [Copy From panel on page 789](#)
- [Template Build Utility panel on page 1056](#)
- [SELECT primary command on page 1218](#)
- [Member Selection panel on page 946](#)

Using hexadecimal values in File Manager

In many File Manager panels, you can view and enter decimal values as text characters or as hexadecimal values. To help you quickly convert decimal values to hexadecimal or hexadecimal values to decimal values, File Manager provides a simple converter tool, in the form of two primary commands.

To convert a decimal value to its equivalent hexadecimal value:

1. On the Command line of any panel, enter `DX` followed by the decimal value.

File Manager displays the results in a message at the bottom of your screen.

For example, if you enter the following on a File Manager Command line:

```
DX 10
```

then File Manager displays this message box:

```
Dec 10 = hex 0000000A
```

To convert a hexadecimal value to its equivalent decimal value:

1. On the Command line of any panel, enter `XD` followed by the hexadecimal value.

File Manager displays the results in a message at the bottom of your screen.

For example, if you enter the following on a File Manager Command line:

```
XD 10
```

then File Manager displays this message box:

```
Hex 00000010 = dec 16
```

Related topics

[DX primary command on page 1147](#)

[XD primary command on page 1239](#)

[Selecting a display format on page 105](#)

Getting help

File Manager offers two levels of help information: context-sensitive field information and Tutorial Help. The field help information provides a description of your current field, lists the valid values or range of values that can be entered, and gives the default field value where applicable. Tutorial Help is a context-sensitive help system that provides detailed explanations of the File Manager panels and the processes in which they are used. In addition, all error messages have an associated full text explanation, which can help you to determine the cause of a problem.

Displaying field help information

To display the field help information:

1. Place your cursor on the field entry line.
2. Press the Help function key (F1). The field help information is displayed in a pop-up window.

If further information is needed, press the Extended Help function key (F5), to access the Tutorial Help page for the current panel.

Pressing Help while the field information window is displayed takes you to the Help Tutorial page within the Tutorial Help system (that is, the page that describes how to use Tutorial Help).

3. When you have finished reading the message or the relevant Tutorial Help page, press the Exit function key (F3) to return to your starting panel.

For example, [Figure 18: Field help information for the RECLIMIT field on page 75](#) shows the message seen when F1 is pressed from the RECLIMIT field in the Set Print Processing Options panel.

Figure 18. Field help information for the RECLIMIT field

Process	Options	Help
File Mana		Set Record Limit
Set proce		Range: 1-end of record
Enter RES		Default: (1,*), unless changed in your File Manager installation.
Print Opt		Bytes to be listed from each record. The first parameter specifies the start column, the second the last column. An asterisk * indicates the end of the record.
PRINTO		
PRINTD		
PRINTL		
PAGESI		
PRTRRA		
HEADER		
PAGESK		
DUMP .		
DATAHD		
RECLIMIT	(1,*)	(n,m) n=begin column, m=end column
Command ==>		
F1=Help	F2=Split	F3=Exit
F8=Forward	F9=Swap	F10=Actions
		F12=Cancel
		F4=CRetriev
		F6=Reset
		F7=Backward

Accessing Tutorial Help

The Tutorial Help system is both context-sensitive and structurally organized. You can get directly to the information you need, using the context-sensitive access method or you can enter the Help system at a specific location and navigate to any topic information within the structure.

To access a context-sensitive Tutorial Help page:

1. Place your cursor on the Command Line or anywhere in the panel that is outside of a field entry line.
2. Press F1. The Tutorial Help page associated with the current panel is displayed.

When you access the Tutorial Help in this way, the first page that is displayed may be a main topic page, with a menu listing the associated sub-topics, or it may be a sub-topic page, depending upon the context from which you started.

3. Navigate through the Tutorial Help pages, to find the information you require (see below for a list of navigation commands).
4. When you have finished, press F3 (Exit) to return to your starting panel.

The Tutorial Help system is organized with a Table of Contents structure that is based upon the File Manager Primary Options menu. Each entry within the Table of Contents leads to a main topic with a number of associated sub-topics. In addition, there is an index that lists selected topics from the Tutorial Help, alphabetically by subject.

To choose your starting point in Tutorial Help:

1. Select the Help pull-down menu from any panel Action Bar.
2. Enter the option number for the Tutorial Help entry point that you require. These are:

1. Help for help

Displays the Help panel for the Tutorial Help system.

2. Extended help

Displays the Tutorial Help panel associated with the current File Manager panel (equivalent to pressing F1 from the File Manager panel). When on the Primary Options menu, this is the Tutorial Help Table of Contents panel.

3. Keys help

Displays a panel that provides help for the Function Keys that are active on the current File Manager panel.

4. Help index

Displays the Help Index.

5. Tutorial

Displays the Tutorial Help Table of Contents panel.

6. About

Displays the File Manager version and release information in a pop-up window.

7. News about File Manager

Displays a panel providing general information about the current File Manager version/release.

To navigate Tutorial Help, enter one of the following commands in the Command line on any Tutorial page:

BACK or B

To back up to the previously viewed page.

SKIP or S

To skip the current topic and go on to the next topic.

UP or U

To display a higher level list of topics.

TOC or T

To display the Table of Contents.

INDEX or I

To display the Tutorial Index. Once the Index has been displayed, use the RIGHT (F11) and LEFT (F10) keys to scroll through the list, then position your cursor on a subject and press ENTER (Ctrl) to display the topic.

Alternatively, you may use the following keys whenever you are in the tutorial:

ENTER (Ctrl)

To display the next sequential page within a topic.

HELP (F1)

To display the Help Tutorial page within the Tutorial Help system (that is, the page that describes how to use Tutorial Help).

END (F3)

To terminate the tutorial.

UP (F7)

To display a higher level list of topics (instead of typing UP).

DOWN (F8)

To skip to the next topic (instead of typing SKIP).

RIGHT (F11)

To display the next sequential page within a topic (instead of pressing ENTER).

LEFT (F10)

To display the previous sequential page within a topic (instead of typing BACK).



Note: The listed keys are the default key mappings. As you can customize key mappings, they may be different on your system.

Viewing error messages

If an error occurs when File Manager attempts to process a panel, a short text message displays in the upper right corner of the screen. While this message is displayed, pressing F1 displays the expanded text of the error message in either a box at the bottom of the screen, or underneath the command line, dependant upon your setting of the ISPF option "Long message in pop-up". The following example is shown with that ISPF option set on.

Figure 19. View Entry panel showing expanded message

```

Process  Options  Help
-----
File Manager                View Entry Panel                Enter required field

Input Partitioned, Sequential or VSAM Data Set, or HFS file:
  Data set/path name _____ +
  Member . . . . . _____ Blank or pattern for member list
  Volume serial . . _____ If not cataloged
  Start position . . _____ +
  Record limit . . . _____ Record Sampling _

Copybook or Template:
  Data set name . . 'FMN.V14R1M20.SFMNSAM1'
  Member . . . . . FMNCCPY Blank or pattern for member list

Processing Options:
Copybook/template  Start position type  Enter "/" to select option
1 1. Above         - 1. Key             - Edit template _ Type (1,2,S)
  2. Previous       - 2. RBA             - Include only selected records
  3. None           - 3. Record number  - Binary mode, reclen _____
  4. Create dynamic - 4. Formatted key



The field where the cursor is positioned is mandatory for this function



Command ==> -----
F1=Help      F2=Split    F3=Exit     F4=CRetriev F7=Backward F8=Forward
F9=Swap      F10=Actions F12=Cancel

```

Related topics

[Messages on page 1717](#)

Setting your default processing options

Many of the processing operations performed by File Manager utilize default values that can be set from within the File Manager application. By adjusting these values, you can customize File Manager so that its behavior is best suited to your needs. Your settings for these options are stored in your ISPF profile, and are invoked when you log in, regardless of which workstation you use.

You can update these default values by accessing the relevant processing option panel.

To access a processing option panel, use any one of the following methods:

- From the File Manager Primary Options Menu:
 1. Select Option 0 (Settings). The Set Processing Options Menu panel is displayed.
 2. Select the required processing options type from the menu.

Figure 20. Set Processing Options menu

```

Process  Options  Help
-----
File Manager          Set Processing Options

1 Print      Print settings
2 System     System settings
3 Tape       Tape processing options
4 Batch      Job card specifications
5 Compiler   Language and compiler specifications
6 EDIT       Editor options
7 Sharing    VSAM Edit sharing options
8 Temporary  Temporary Data Set Allocations
9 Output     Output Data Set Allocations
10 Trace     Trace options

Command ==>> -----
F1=Help      F2=Split    F3=Exit     F4=CRetriev F7=Backward F8=Forward
F9=Swap      F10=Action  F12=Cancel

```

- From any File Manager panel, use the **Options** pull-down menu to select the required processing options type:

Figure 21. Options pull-down menu

```

Process  Options  Help
-----
File Man  ___ 1. Print settings
          2. System settings
          3. Tape processing options
          4. Job card specifications
          5. Compiler language selection
          6. COBOL compiler specifications
          7. HLASM compiler specifications
          8. PL/I compiler specifications
          9. Editor options
          10. VSAM Edit sharing options
          11. Temporary Data Set Allocations
          12. Output Data Set Allocations
          13. Trace options
          14. ISPF settings

1 Print
2 Syste
3 Tape
4 Batch
5 Comp
6 EDIT
7 Shari
8 Tempo
9 Outpu
10 Trace

Command ==>> -----
F1=Help    F2=Split    F3=Exit     F4=CRetriev F7=Backward F8=Forward
F9=Swap    F10=Action  F12=Cancel

```

- On the Command/Options line of any File Manager panel, enter an equals sign (=), followed by the option number for the required processing type. For example, to display the Set Tape Processing Options panel, enter =0.3.

When you select an option processing type, File Manager displays a panel listing those options and their current values. The following notes apply to all of these option panels:

- To change the value of an option, overwrite its current value.
- To save the options you have changed and exit the panel, press the Exit function key (F3).

Changes are saved in your ISPF user profile for future File Manager sessions. They remain in effect until you change the option again.

- To exit a panel without saving changes, press the Cancel function key (F12).
- To reset all options on the panel to their installation defaults, enter `RESET` on the Command line.
- The options on these panels only affect the behavior of File Manager panels. To set options when programming with File Manager functions, use the equivalent function keywords. You can set most options using the SET function (see [SET \(Set Processing Options\) on page 1550](#)). For Compiler Language Selection, COBOL, PL/I or HLASM options (for compiling copybooks into templates), use the keywords on the same function where you specify the copybook (the DSEB, DSC, DSG, DSM, DSP, or DSU functions).

The use of most of these processing options is discussed in the section that the option affects. For example, the use of Set Print Processing Options panel is described in the **Printing from File Manager** section of the **Managing data sets** chapter. Only those processing options that affect more than one area of File Manager functionality are described in this section.

Related topics

[Set Processing Options panel on page 1029](#)

Set print processing options (option 0.1)

The print processing options control the print output that the File Manager functions produce.

Related topics

[Setting your Print Processing Options on page 403](#)

[Set Print Processing Options panel \(option 0.1\) on page 1025](#)

Setting your System Processing Options (option 0.2)

The System Processing Options control such things as data presentation and conversion values, and whether or not user-written I/O exits are allowed when processing various utility functions.

In the Data presentation and conversion section:

- The PAD option defines both the padding and truncation of fields within records when performing actions such as copying or creating data sets.
- The NOTRUNC option specifies that, if the PAD option has been selected, no truncation is performed when copying or writing records to a variable length data set.

The CYLHD option defines how File Manager interprets cylinder-head and track-number values in disk functions. ABSOLUTE means the actual physical addresses. RELATIVE means relative to the start of the data set.

The EOD option sets the end-of-data delimiter for tape input.

The CCSID option specifies the CCSID to be used when translating fields which have a associated CCSID when File Manager is run in batch.

The User I/O Exit Specification section contains two fields that, together, control whether or not you are able to use custom user I/O exits in tasks such as viewing, editing, printing, copying or comparing data sets. User I/O exits are custom-written programs that handle files that require pre- or post-processing not offered directly by File Manager. This may include handling data compression or encryption, or other non-standard activities performed on the data set records. There are no restrictions on the programming language that you can use to write an exit, however, the exit must be provided to File Manager in the STEPLIB/ISPLLIB concatenation or their extensions (LINKLIST, LPA, and so on).

To allow the use of user I/O exits, several things must occur:

1. When File Manager is installed, the person doing the initial customization (the FMN Administrator) must have chosen to allow user I/O exits on a site-wide basis.

If the FMN Administrator chose not to allow user I/O exits, the **Exit enabled** field is set to **NO Disabled by installation options**. You cannot change this from within the File Manager panel and you cannot use I/O exits in online or batch processing.

If the FMN Administrator chose to allow user I/O exits, you can then set the **Exit enabled** field to YES. Choosing YES means that when performing the following tasks (via a panel or function), you have the option to use or not use a user I/O exit:

- Viewing data sets (View panel only)
- Editing data sets (Edit panel, DSEB and DSU functions)
- Finding and changing data (Find/Change panel, FCH function)
- Copying data sets (Copy From and Copy To panels, DSC function)
- Creating data (Data Create panel, DSG function)
- Comparing data sets (Old and New panels, DSM function)
- Printing data sets (Print Utility panel, DSP function)

Choosing NO means that you are not able to select an exit in any of the File Manager panels. However, you are still able to specify a user I/O exit in batch processing.

2. Either you or someone in your organization must have developed your own custom exit to be used. Sample programs and control block templates have been provided for HLASM (High Level Assembler), COBOL, and PL/I but these need to be tailored to your site needs.

If the FMN Administrator has allowed user I/O exits, he or she may have provided a default exit for you to use. If they have done so, the name is displayed in the **Default exit** field.

You can override this system default with your own default exit, by changing the name in this field. In each applicable panel or function, you can then choose to accept or override the current default.

3. When you want to use a user I/O exit, regardless of whether you are using the system default, your own default or specifying a unique exit at the individual panel or function level, the name of the exit must be the name of a PDS(E) member of a data set that is included in the current STEPLIB/ISPLLIB concatenation for File Manager.

Related topics

[Set System Processing Options panel \(option 0.2\) on page 1031](#)

Set tape processing options (option 0.3)

The tape processing options control such things as the type of labels to be created and the type of data translation to be used when manipulating data on a tape.

See [Set Tape Processing Options panel \(option 0.3\) on page 1034](#) for panel details.

Set batch job card information (option 0.4)

On the Batch Job Card Information panel, you can specify batch job card information to be used for generating batch job submission JCL. The Batch Job Card Information panel provides a number of blank lines (**Batch Submission Job Statement Information**) where you can enter this information.

File Manager assumes any non-blank lines define a JCL job card and copies the information from these lines into generated JCL. If all the lines are blank, the JCL generation process generates a basic job card using information from system variables.

To change processing options in batch or to reset options to the installation default, use the SET function.

Related topics

[Set Batch Job Card Information panel \(option 0.4\) on page 1015](#)

Language and compiler specifications (option 0.5)

The language and compiler specifications allow you to specify the compiler that File Manager uses to build templates, and also to set options for that compiler.

Related topics

[Setting your template processing options on page 200](#)

[Compiler Language Selection panel on page 788](#)

[Set COBOL Processing Options panel \(option 0.5.2\) on page 1016](#)

[Set PL/I Processing Options panel \(option 0.5.4\) on page 1024](#)

[Set HLASM Processing Options panel \(option 0.5.3\) on page 1020](#)

[Set Language and Compiler Specifications \(option 0.5\) on page 1021](#)

Editor options (option 0.6)

The editor options control various options used to format the display or print of data when viewing, editing, or printing.

In an editor session, use the PROFILE primary command to display the current settings.



Note: If you are viewing, editing, or printing data, the **Options** pull-down menu choice to change these options is not available. The options may only be changed before starting your View, Edit, or Print session. To change the behavior for the current View, Edit, or Print session, use an equivalent primary command (where available).

Related topics

[Editor Options panel on page 868](#)

[Displaying your current editor options on page 98](#)

[PROFILE primary command on page 1200](#)

VSAM edit sharing options (option 0.7)

The VSAM edit sharing options control the behaviour when a file is being shared by other users.

See [VSAM Edit Sharing Options panel on page 1101](#) for panel details.

Temporary Data Set Allocations (option 0.8)

The Temporary Data Set Allocations options control the allocation defaults for temporary and auxiliary data sets.

See [Set Temporary Data Set Allocation Options panel on page 1036](#) for panel details.

Output Data Set Allocations (option 0.9)

The Output Data Set Allocations options control the allocations defaults for output data sets.

See [Set Output Data Set Allocation Options panel on page 1022](#) for panel details.

Trace options (option 0.10)

The trace options control the Trace output produced by File Manager when it is run in debug mode.

See [Set Trace options panel on page 1038](#) for panel details.

Displaying or editing DBCS characters

If you want to display or edit DBCS characters in File Manager and you have a DBCS capable terminal, you must ensure that your ISPF settings specify a terminal type that supports these characters.

To specify the Terminal Type in ISPF:

1. Exit from File Manager and return to the z/OS® Primary Option Menu panel.

Although you can change the ISPF Terminal Type setting while File Manager is running, the change is not reflected until the next time that File Manager is invoked.

2. Select option `0. Settings`. The ISPF Settings panel is displayed.

Figure 22. ISPF Settings panel

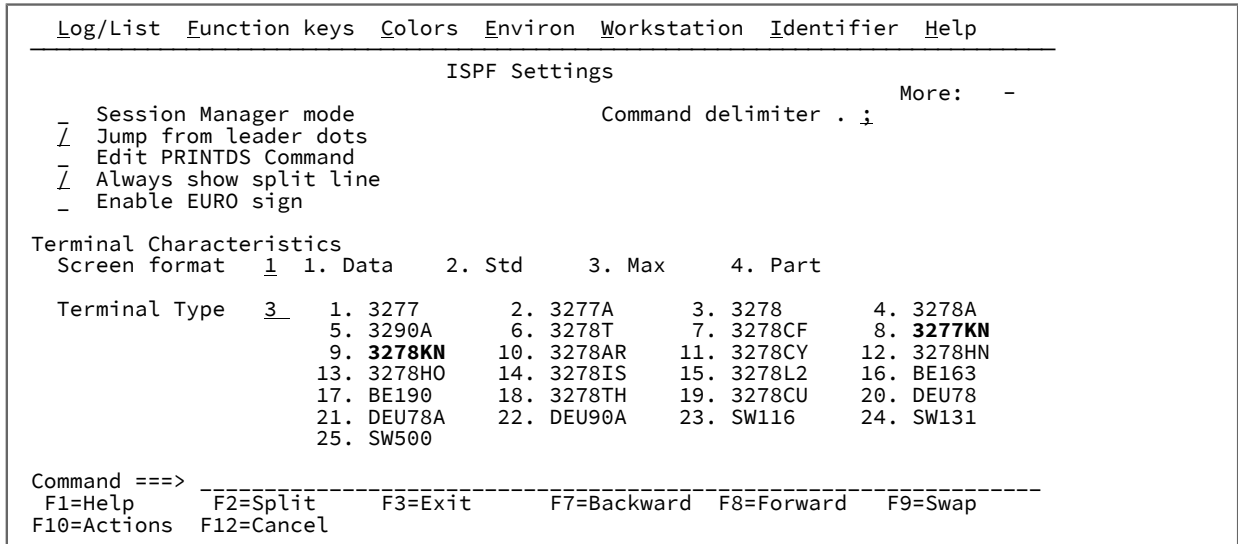

3. Select either 3277KN or 3278KN from the list of Terminal Types.



Tip: You may need to scroll down this panel to find the list of Terminal Types.

4. Press Exit (F3) to save your selection and return to the z/OS® Primary Option Menu panel.
5. Restart File Manager.

National characters

File Manager uses the national characters shown in [Table 3: National characters on page 84](#).

Table 3. National characters

Character	Hexadecimal value	Displayed as, in code pages 37 and 500
Dollar sign	X'5B'	\$
Pound sign	X'7B'	#
At sign	X'7C'	@



Note:

1. The dollar sign (\$) and the pound sign (#) have special syntactical meaning in File Manager syntax.
2. In countries using code pages other than 37 and 500:

Table 3. National characters

(continued)

Character	Hexadecimal value	Displayed as, in code pages 37 and 500
		<ul style="list-style-type: none"> ◦ The above characters as represented on terminal keyboards might generate a different hexadecimal representation, and this might cause an error or unwanted results. For example, in some countries the \$ character might generate a X'4A'. ◦ The above hexadecimal values might display as different characters to those shown.

When you enter File Manager commands in batch or online, use the keyboard characters that correspond to the hexadecimal values shown in [Table 3: National characters on page 84](#).

SAF-rule controlled auditing

The way in which auditing is performed during a File Manager session may be determined by SAF rules, depending on the auditing requirements of your installation.

SAF rules for auditing

When auditing is determined by SAF rules:

- Auditing can be specified to either your audit log data set, to SMF, or to both destinations.
- All File Manager functions which access data sets and MQ data may be subject to audit.
- It determines if the **Create audit trail** option is displayed on the Edit Entry panel and the WebSphere® MQ Queue Editor Entry panel.

For the File Manager functions which SAF-rule controlled auditing may be applied to, the SAF rules can be specified at a resource or function level allowing auditing at the FUNCTION, UPDATE, or ALL level. Auditing at the ALL level indicates that record reads and updates are recorded, UPDATE indicates only inserted, deleted, or changed records are recorded, while FUNCTION records only the event.

SAF-rule controlled auditing not in effect

When SAF-rule controlled auditing is not in effect (that is, auditing is controlled by the settings in the FMN0POPT macro), the **Create audit trail** option is displayed on the Edit Entry panel and the WebSphere® MQ Queue Editor Entry panel. If the **Create audit trail** option is selected, or the AUDITLOG option DEMAND or YES has been specified in the FMN0POPT macro, auditing of inserted, deleted, or changed records are logged.

SAF-rule controlled auditing in effect, auditing possible

When SAF-rule controlled auditing is in effect, and auditing is to occur, the actual decision on whether or not to create an audit log depends on the SAF rules in place.

If you have control-level audit access, the **Create audit trail** option is displayed on the Edit Entry Panel and the WebSphere® MQ Queue Editor Entry panel. If you select this option, and no other SAF rule is in place for this function and resource, auditing of inserted, deleted, or changed records is logged. If there is an existing SAF rule for this function and resource, the level of audit specified in the SAF rule applies.

Chapter 3. Viewing and changing data sets

To view data stored in a supported data set, use the View Utility or the Edit Utility.

The following instructions are given within the context of the FMN editor. In most cases, you can perform these actions in either Edit or View, in which case the term "editor" is used. Similarly, the term "editor session" can indicate either a View editor session or an Edit editor session.

Many of the tasks described in these topics require the use of templates. For more information, see [Creating and editing templates on page 173](#).

View Utility

The View Utility (option 1) allows you to view and temporarily change the data, but without the ability to save any changes to the data set being viewed. Changes may be saved to a different data set.

When you initiate the File Manager editor with the View Utility, this is referred to as being in a "View editor session" (or just "View").

The view function, similar to ISPF view, provides an editor session that works essentially the same as the Edit Utility, but without the need for exclusive access to the data set. It presents you with an interface that is capable of holding your temporary changes to data. This may be useful, for example, for assessing a change but without any risk of altering live data.



Note: If you have changed the data in a View editor session, even though you are not able to save the changes back to the same data set you are viewing, you *can* save the changed data to *another* data set (either existing or new, however MQ queues are not supported by these commands) by issuing one of these primary commands:

APPEND

Appends specified records in the current editor session to another (existing) data set.

CREATE

Creates another (new) member or data set from specified records in the current editor session.

REPLACE

Replaces another (existing) member or data set with specified records in the current editor session.

SAVEAS

Saves the currently exposed data in the current editor session to another (new) member or data set, and switches to an edit of the nominated member or data set.

Related topics

[Creating, replacing, and adding data using existing data on page 333](#)

The first time you make a change to the data in a View editor session, File Manager displays a warning as shown in [Figure 23: Warning pop-up displayed after first change in View editor session on page 88](#).

Figure 23. Warning pop-up displayed after first change in View editor session

```

Process  Options  Help
-----
View          FMNUSER.TEST.DATA(EMP)
Record AT TOP      Top of 40
Format TABL      Format TABL
#2      #3      EMPLOYEE-NO      AGE      SALARY      MONTH(1)
AN 1:2  AN 3:20      BI 23:2  BI 25:2  PD 27:4      BI 31:4
<>      <-----1----->      <---->  <---->  <----->  <-----1>
***** ***** Top of data *****
000001 01      Garry Northfield      7712      56      75111      6
:
000006 01      Ron Turtle      5006      35      100000      28
000007 01      David Nelson      2257      47      100000      44

Save is not possible in a View session. Use Edit if you want to be able to
save changes.

Command ==>
F1=Help      F2=Zoom      F3=Exit      F4=CRetrie v      F5=RFind      F6=RChange
F7=Up        F8=Down      F9=Swap      F10=Left      F11=Right     F12=Cancel
    
```

When you exit from a View editor session by pressing the Exit function key (F3), if you have made a change to the data in the editor session, File Manager displays a warning as shown in [Figure 24: Warning displayed when exiting from a View editor session with changed data on page 88](#).

Figure 24. Warning displayed when exiting from a View editor session with changed data

```

Process  Options  Help
-----
V          View Warning
-----
          You are currently in Data View mode:
          Press Enter to confirm exit from View. No changes will be
          saved.
*          Enter the END or EXIT command to return to View, where you
0          can use the CREATE or REPLACE commands to save your
0          changes.
0          Command ==>
0          F1=Help      F2=Split      F3=Exit      F7=Backward
0          F8=Forward     F9=Swap      F12=Cancel
0
000007 01      David Nelson      2257      47      100000      44
000008 01      Jim Alexander     1332      63      125000      47
:
000012 01      Liz Hurring       3789      40      66000      44
Command ==>
F1=Help      F2=Zoom      F3=Exit      F4=CRetrie v      F5=RFind      F6=RChange
F7=Up        F8=Down      F9=Swap      F10=Left      F11=Right     F12=Cancel
    
```

Edit Utility

The Edit Utility (option 2) allows you to view and change your data (by inserting, deleting and otherwise modifying records), and save any changes you make.

When you initiate the File Manager editor with the Edit Utility, this is referred to as being in an "Edit editor session" (or just "Edit").

Starting and ending editor sessions

The File Manager editor allows you to edit your data as logical records, in an unformatted or formatted state. Records that are structured into fields are particularly suitable for editing in a formatted state using a template. Data that is relatively unstructured, such as a text file, copybook definition or REXX procedure, can be edited in its unformatted state.

If your data has been written using the ISPF PACK option, you can choose to unPACK the data for easy editing or edit the data in its PACKed format. You can also choose to write previously unPACKed data to the ISPF PACK format. Packing only applies to physical sequential data sets or to members of a PDS(E).

Starting an editor session without using templates

To display your data in an unformatted state:

1. From the File Manager Primary Options Menu panel, select one of these:

1 View

Displays the View Entry panel.



Note: This option does not allow you to save any changes you make to the data.

2 Edit

Displays the Edit Entry panel.

2. Specify your HFS file or data set name or name pattern, member name or pattern and/or volume serial.
3. If required, specify a **Starting position** for the data, then select a **Start position type** from the Processing Options.

When your data set is a KSDS file, you can specify a key of up to 250 characters, as the starting position. To make it easier to enter a key of this size, you can expand the field by pressing the EXPAND function key (F4) or you can scroll within the field by pressing the LEFT or RIGHT function keys (F10/F11).

When using a record number as the start position, you can specify a negative number to start from the given number of records before the end of the data set. The initial display is positioned at the specified record. Records prior to your starting position are not visible.



Note: See also the use of the KEY primary command in step 9 on page 90.

4. If required, specify a record limit. The count of displayed records commences from the Starting position (which defaults to the top of the data set).

You can specify a record limit as the word *"MEMORY"* so that File Manager loads only as many records as will fit comfortably into storage.

5. If required, select the **Record Sampling** field. Selecting this field will cause the Record Sampling panel to display after the Entry panel has been processed.

You can use record sampling to specify a pattern for reading records from the data set. In your pattern, you can specify a starting position, read a number of records, skip a number of records, and then repeat the pattern until an end point is reached. The end point might be a specified number of physical records, a specified number of records selected by a template, the end of the input file, or the maximum number of records that can safely fit within the available virtual storage (whichever is reached first).

When record sampling is in effect:

- The values (if any) in the **Start position** and **Record limit** fields are carried through into the Record Sampling panel.
- The skipped records are not presented or accessible within the session.
- The session will run in In-place mode and will only contain as many records as will fit into the available virtual storage.

6. In Edit, if you only want to update records in the data set (without inserting or deleting records), then select the **Inplace edit** option.

Note that you cannot insert or delete records when:

- **Record Sampling** is selected,
- A **Record limit** of "MEMORY" is specified,
- The data set is a VSAM file defined as NOREUSE, or
- A template is specified which indicates segmented records
- The data set is a QSAM LRECL=X that is too large to be contained in memory

7. Type **3** (None) in the **Copybook/template usage** field.



Note: When this field is set to None, entries in the **Copybook or Template Data set name** and **Member** fields are ignored.

8. In Edit, if required, select the **Create audit trail** option.



Note: To print an audit report, use Print audit trail report (see [Edit Entry panel on page 862](#)).

9. Press Enter to process the panel.

If you have provided the complete name of your data set and data set member, the Edit (or View) panel displays your data.

If you used a pattern to specify your data set or member, the Data Set Selection or Member Selection panel is displayed. Select the required data set or members from the list by typing an **3** in the Prefix field, then pressing Enter. The Edit (or View) panel displays your data.

If your data set is a KSDS file, you can specify a position to jump to by issuing the KEY primary command.

Related topics

- [Specifying a data set and a member name on page 42](#)
- [Scrollable input and display fields for long names on page 122](#)
- [View Entry panel on page 1092](#)
- [View panel on page 1083](#)
- [Record Sampling panel on page 988](#)
- [KEY primary command on page 1177](#)

Example of displaying data without a template

Follow the steps in this example, to display a data set member that contains a copybook definition (suitable for viewing without a template).

1. From the File Manager Primary Option Menu panel, select **1 View**.
2. In the **Data set name** field, type 'FMN.V14R1M20.SFMNSAM1'.
3. In the **Member** field, type FMNCCPY.
4. Type 3 (None) in the **Copybook/template usage** field.
5. Press Enter to process the panel. Your results should look similar to below:

Figure 25. Viewing without a template

```

  Process  Options  Help
  -----
View      FMN.V14R1M20.SFMNSAM1(FMNCCPY)      Top of 34
          Col 1      Insert Length 80      Record AT TOP      Format CHAR
          -----1-----2-----3-----4-----5-----6-----7-----
*****   ****   Top of data   ****
000001   ***   +-----+
000002   *   IBM File Manager for z/OS Version 14
000003   *   Licensed Materials - Property of IBM
000004   *
000005   *   5655-Q42 IBM File Manager for z/OS
000006   *
000007   *   (c) Copyright IBM Corp. 1986, 2017.
000008   *   All Rights Reserved.
000009   *   (c) Copyright HCL Technologies Ltd. 2017, 2022
000010   *   All Rights Reserved.
000011   *
000012   *   US Government Users Restricted Rights - Use,
000013   *   duplication or disclosure restricted by GSA ADP Corp.
000014   *   Schedule Contract with IBM Corp.
000015   *
000017   *   Sample COBOL copybook to demonstrate the File Manager
000018   *   field level processing.
000019   *   The associated template is FMNCTMPL and the sample
Command ==>
          F1=Help      F2=Zoom      F3=Exit      F4=CRetrieve  F5=RFind      F6=RChange
          F7=Up        F8=Down      F9=Swap      F10=Left      F11=Right     F12=Cancel
  
```

6. Press F8 to scroll down and view the copybook contents.
7. Press F3 to exit and return to the Edit (or View) Entry panel.

Starting an editor session with a template

To display your data with a template:



Note: This process assumes that you have an existing template that you can use to format your data. For details on creating new templates or editing an existing template before use, see [Creating and editing templates on page 173](#).

1. Follow steps 1 to 6 in [Starting an editor session without using templates on page 89](#).
2. If required, select the **Include only selected records** option. This option is only effective when using a template and you are using either:
 - Record sampling, or
 - A record limit of *"MEMORY"*



Note: If you have selected the **Include only selected records** option, the editor session operates in an in-storage way.

3. In the **Copybook or Template** section of the panel, specify the data set in which your copybook template or dynamic template is stored, or use a wildcard character to select from a list.



Note: The Use I/O exit option only affects the data set that you are choosing to view. It cannot be used to process the template or copybook that you are using to format the data.

4. In the same section, specify the Member name or leave the Member name field blank to choose from the list of Members in a partitioned data set.
5. In the **Copybook/template usage** field, type **1** to select the Above option.

Alternatively, if you have previously used a template with the input data set, you can select option **2. Previous**. The Previous option instructs File Manager to ignore the contents of the **Copybook or Template** fields, and instead use the template that you have most recently associated with the input data set.

If you want to edit the template before using it, select the **Edit template** field.

6. Press Enter to process the panel.

If you have provided the complete name of your input data set and data set member and your template data set and data set member, the Edit (or View) panel displays your data.

If you used a pattern to specify your data sets or members, the Data Set Selection or Member Selection panels are displayed in the following order:

- Data Set Selection panel
- Template Data Set Selection panel
- Template Member Selection panel
- Member Selection panel

Select the required data sets or members from the lists by typing an **s** in the Prefix field, then pressing Enter. The Edit (or View) panel displays your data.

Related topics

[Creating and editing templates on page 173](#)

[View Entry panel on page 1092](#)

[View panel on page 1083](#)

[Specifying a data set and a member name on page 42](#)

Example of displaying data with a template

The first task in this tutorial is to view data that has been structured into fields, without using a template. This demonstrates some of the display issues that can occur when unformatted data is viewed. In the next task, you view the same data, with a template.

1. From the File Manager Primary Option Menu, select option **1. View**.
2. In the **Data set name** field for the input data set, type 'FMN.V14R1M20.SFMNSAM1'.
3. In the **Member** field for the input data set, type FMNCDATA.
4. In the **Copybook/template usage** field, select option **3. None**.
5. Press Enter.

[Figure 26: Viewing structured data without a template on page 93](#) shows what this data looks like without a template.

Figure 26. Viewing structured data without a template

```

Process  Options  Help
-----
View          FMN.V14R1M20.SFMNSAM1(FMNCDATA)          Top of 40
Col 1         Insert Length 80          Record AT TOP          Format CHAR
-----+-----+-----+-----+-----+-----+-----+-----
***** **** Top of data ****
000001 01Grant Smith          .....
000002 01Andrew Apple          .5...&.....
000003 01Graham Prestcott      .....
000004 01Bill Somers           .....
000005 01Ted Dexter            .....-.....
000006 01Roddy Armstrong       .....
000007 01Cliff Roberts         .R.....
000008 01James Browne          .).....
000009 01Silvia Carrot         .... / .....
000010 01Dan Peters            .".....
000011 01John Laws             ;.....
000012 01Liz Childs            ?.....
000013 01Bill McCork           .N.....
000014 01Keith Sampson        .....
000015 01John Neptune         .....
Command ==>
F1=Help   F2=Zoom   F3=Exit   F4=CRetriev  F5=RFind   F6=RChange
F7=Up     F8=Down   F9=Swap   F10=Left    F11=Right  F12=Cancel
          Scroll CSR

```

The first twenty records in this member contain non-displayable characters represented by periods and other characters. Without a template, these records cannot be easily viewed or edited.

6. When you have finished examining the data, press the Exit function key (F3) to return to the Edit (or View) Entry panel.

Now let's view the same data using a template generated from the COBOL copybook supplied in FMN.SFMNSAM1(FMNCPPY).

7. In the **Data set name** field for the Copybook or Template, type 'FMN.V14R1M20.SFMNSAM1'.
8. In the **Member** field for the Copybook or Template, type FMNCCPY.
9. In the **Copybook/template usage** field, select option 1. Above.
10. Press Enter.

For this example, we want to display the data in tabular format. If the **Format** field (at the top right of the panel) does not contain `TABL`, then overwrite the first letter of its current value with `T` and then press Enter.

The sample data is now shown in TABL display format, arranged in columns.

Figure 27. Viewing data using a template (TABL display format)

Process	Options	Help
View	FMN.V14R1M20.SFMNSAM1 (FMNCDATA)	
	Record	AT TOP
	EMPLOYEE-NO	AGE
	TOP of 40	Format
	TABL	
REC-TYPE	REC-ID	NAME
#2	#3 R #	#4
AN 1:2	AN 1:2	AN 3:20
BI 23:2	BI 25:2	PD 27:4
<>	<>	<-----1----->
<---->	<---->	<---->
*****	****	Top of data ****
000001	01	Grant Smith
000002	01	Andrew Apple
000003	01	Graham Prestcott
000004	01	Bill Somers
000005	01	Ted Dexter
000006	01	Roddy Armstrong
000007	01	Cliff Roberts
000008	01	James Browne
000009	01	Silvia Carrot
000010	01	Dan Peters
000011	01	John Laws
000012	01	Liz Childs
Command ==>		Scroll CSR
F1=Help	F2=Zoom	F3=Exit
F7=Up	F8=Down	F9=Swap
	F4=CRetriev	F5=RFind
	F10=Left	F11=Right
		F6=RChange
		F12=Cancel

File Manager has used the first record type defined in the copybook to display the data and the first set of records (REC-TYPE = 01) are now readable. Any fields defined in the second record type (REC-TYPE = 02) that match fields defined in the first type are also displayed.

Removing or changing the template

To stop using a template, and remove the logical view of the data, enter `TVIEW OFF` on the Command line.

To edit a template, and change the logical view of the data, enter `TEDIT` on the Command line.

To select or create a template for the data, enter `TVIEW` on the Command line.



Note: There are restrictions on removing or changing templates. When using record sampling, or when a segmented template has been used, File Manager cannot perform the changes in reformatting required. In these cases, it is necessary to exit and re-enter the editor session to perform such a change.

Related topics

[Creating and editing templates on page 173](#)

[TEDIT primary command on page 1231](#)

[TVIEW primary command on page 1233](#)

Viewing and changing packed data

When you want to view PDS or PDSE data set members that have been stored in ISPF PACK format, you can tell File Manager to unpack the data before displaying it. Once your data has been unpacked for display, you can view it as normal data. The records are automatically packed again when you save the data set.

Working with packed data in Edit

In Edit, you can convert packed data to an unpacked format and non-packed data to packed format, by issuing the PACK ON or PACK OFF command before you save your data.

To convert data to ISPF PACK format:

1. Open a data set member that is not in ISPF PACK format.
2. Perform any editing changes you want to make.
3. Enter the PACK ON command on the Command line.
4. Enter the SAVE, FILE or EXIT command.



Note: You do not need to have the **Recognize and interpret ISPF packed data** option selected in order to convert data to packed format. However, you need to have the option on, to be able to edit this data after it has been packed.

To unpack data that has been stored in ISPF PACK format:

1. Ensure that the **Recognize and interpret ISPF packed data** option has been selected in the relevant Editor Options panel.
2. Open the packed data set member.
3. Enter the PACK OFF command on the Command line.
4. Enter the SAVE, FILE or EXIT command.



Note: You cannot unpack data unless File Manager is able to recognize and interpret the packed data format.

You can also pack or unpack data set members as you copy a member to another data set or data set member.

Working with packed data in View

In View, if your PDS or PDSE data sets have been written using the ISPF PACK option, you can choose to unpack the data before viewing it, or work with the data in its packed format. This can be particularly useful when your data appears to be in ISPF PACK format, but is in fact not so.

To unpack files automatically on viewing:

1. Do one of the following:
 - a. On the Primary Option Menu panel, select option **0 Settings**.
 - b. On the Set Processing Options panel, select option **6 EDIT**.

OR

- a. On the View Entry panel, select **Options** from the Action Bar.
 - b. Select option 9 from the pull down menu.
2. Select the **Recognize and interpret ISPF packed data** option.

When this option is selected, File Manager checks the data in the data set or member being viewed to determine if it has been written with the ISPF PACK option. If it had, File Manager then unpacks the data to allow it to be viewed in the normal fashion. If the unpacked data set is too large to be contained in memory, File Manager issues a message and then opens the data set in its packed format. If this option is deselected, File Manager does not check the data format and operates on packed data in its packed state.



Note: If you select the **Use I/O exit** option on the View Entry panel, the **Recognize and interpret ISPF packed data** option is ignored. Packed data sets are displayed in packed format.

Related topics

- [PACK primary command on page 1195](#)
- [Viewing and changing packed data on page 95](#)
- [Editor Options panel on page 868](#)
- [Copying data sets on page 341](#)

Listing statistics for the current editor session

To list statistics for the current editor session, use the RECSTATS primary command.

The RECSTATS primary command shows (in a pop-up panel):

- The number of physical records read while loading
- The number of physical records selected
- The number of record elements in the current editor session
- For an Edit session, the number of pending inserts and changes
- The total data bytes
- The average record element length
- The minimum record element length encountered
- The maximum record element length encountered

When a template has been used, the RECSTATS primary command also shows:

- The number of layouts
- The number of record elements selected

- The number of record elements not selected
- The number of record elements not selected due to the record data not meeting selection criteria
- The number of record elements not selected due to the record length being outside any layout length
- A list of layout names and the number of record elements belonging to each layout



Note: Information on record elements not selected is not available if the **Include only selected records** option is selected and this is an in-storage or sampling editor session.

Similarly, for an editor session using a segmented template with selection criteria, information for records and their segments that were not selected is not available.

Figure 28: Example of statistics listed with the RECSTATS command on page 97 shows an example of statistics listed by the RECSTATS command for a editor session when a template has been used.

Figure 28. Example of statistics listed with the RECSTATS command

```

Process  Options  Help
-----
View          FMN.V14R1M20.SFMNSAM1(FMNCDATA)          Rec 0 of 40
                                     Record 0          Col 1          Format CHAR
                                     File Manager Messages
-----

File Manager View (in-storage)
Dataset: FMN.HOGN.KSDS.TEST
Template: FMN.RFM0569.PDSE(HOGAN)
Physical records read while loading: 100
Physical records selected          : 2

Number of record elements      : 50
  inserts pending              : 0
  changes pending              : 0
  deletes pending              : 0
Total data bytes                : 4014
Average record element length: 80
Minimum record element length: 12
Maximum record element length: 298

Template related information
Number of layouts              : 28
Record elements selected       : 50
Record elements not selected   : 0
  due to record element data not meeting selection criteria: 0
  due to record element length outside any layout length : 0
List of layout names and count of record elements per layout
M-KEY-GROUP                    2
M-ACCOUNT-CODING-STRUCTURE     2
M-ORIGINAL-ACT-INFO            2
M-CLOSED-ACT-INFO              0
Command ==>
F1=Help      F2=Split      F3=Exit      F4=CRetriev  F7=Backward
F8=Forward   F9=Swap       F10=Actions  F12=Cancel

```

Related topics

[RECSTATS primary command on page 1205](#)

Displaying your current editor options

To display your current editor options while in an editor session (from the Edit panel or View panel), enter the PROFILE primary command.

Figure 29: Editor options displayed during an editor session on page 98 shows an example of editor options displayed during an editor session.

Figure 29. Editor options displayed during an editor session

```

Process  Options  Help
-----
View          FMUSER.DATA(DATA1)
Record 0      Rec 0 of 40
Format TABL
REC-TYPE NAME          EMPLOYEE-NO    AGE    SALARY    MONTH(1)
#2      #3              #4      #5      #6      #7
AN 1:2  AN 3:20      BI 23:2 BI 25:2 PD 27:4    BI 31:4
<>      <-----1----->      <---+> <---+> <---+---> <---+-----1>
**** Top of data ****
....BOUNDS 1-*.CAPS OFF...CASE OFF...PACK OFF...PREFIX OFF.....
....SHADOW LINES...EXCLUDED ON..NOTSEL ON..SUPPRESSED ON.....
....SHOW(UNGROUP)...NOTSEL OFF...SUPPRESSED OFF.....
....TEMPLATE FMUSER.DATA.....
....JUST OFF...OFFSET 0...PIC OFF...RDF ON...REFS ON.....
....SLOC OFF...STR OFF...TYPE ON.....
01      Grant Smith          7712    35     70000    6
01      Andrew Apple          6645    53     78500    30
01      Graham Prestcott       5583    28     48000    7
01      Bill Somers            4418    33     68000    5
01      Ted Dexter             3327    52     60250    14
01      Roddy Armstrong       5683    34     77000    28
Command ==>
F1=Help    F2=Zoom    F3=Exit    F4=CRetriev F5=RFind    F7=Up
F8=Down    F9=Swap    F10=Left   F11=Right  F12=Cancel
Scroll CSR
    
```

Related topics

[PROFILE primary command on page 1200](#)

Ending an editor session

In View, to end your editor session, press the Exit function key (F3).



Note: If you have selected more than one data set member to be viewed, the next selected member on the list is now displayed.

In Edit, to end your editor session without saving your changes (that is, since the previous SAVE command), enter **CANCEL** (or **CAN**) on the Command line, or press the Cancel function key (F12). If you have made any changes to the data, File Manager displays a message box asking you to confirm that you want to discard the changes.

To end your Edit session and save any changes you have made, enter **END** on the Command line, or press the Exit function key (F3).

Related topics

[END primary command on page 1148](#)

[FILE primary command on page 1157](#)

[CANCEL primary command on page 1124](#)

Saving changes without ending the Edit session

To save changes you have made to the current data set or member, without ending the Edit session, use the SAVE command.

File Manager keeps only changed records in memory, unless using a MEMORY record limit, or using record sampling, or using a segmented template with selection criteria. If you run out of memory, the SAVE command may free some memory, which would let you continue the Edit session.



Note: This command is not supported when editing a large file using an auxiliary data set. In this case, you must end the Edit session to save the changes and then re-edit the data set if you want to make further changes.

Related topics

[SAVE primary command on page 1215](#)

Displaying the RBA and record length information

When you are viewing a VSAM file in a Browse editor session, you can select to display the RBA and record length information.

The display of this information is initially controlled by the **Display RBA and Length when browsing VSAM** option in the relevant Editor Options panel. However, in a Browse session you can use the RBALEN primary command to change whether this information is displayed or not for that editor session.

In a Browse session, to display the RBA and record length when viewing a VSAM file, do one of these:

- Ensure that the **Display RBA and Length when browsing VSAM** option in the relevant Editor Options panel is selected, or
- Issue the command `RBALEN ON`

[Figure 30: VSAM file displayed in Browse session with RBA and record length details displayed on page 100](#) shows part of a VSAM file displayed in a Browse session with the RBA and record length displayed on the leftmost side.

Figure 30. VSAM file displayed in Browse session with RBA and record length details displayed

Process		Options		Help	
Browse		FMN.RFM0201.KSDS.REUSE.SHR1		Rec 0	
Type	KSDS	Key		RBA	Format CHAR
Col 1					
RBA	Len	-<==+===>=-----+-----2-----+-----3-----+-----4-----+-----5-----+-----6			
****	Top of data	****			
0	80	00000001AAA*** updateok & reversed ***AAAAAAAAAAAAAAAAAAAAAAAAAAAA			
80	80	00000002AA			
160	80	00000003AA			
240	80	00000004AA			
320	80	00000005AA			
400	80	00000006AA			
480	80	00000007AA			
560	80	00000008AA			
640	80	00000009AA			
720	80	00000010AAA*** updateok & reversed ***AAAAAAAAAAAAAAAAAAAAAAAAAAAA			
800	80	00000011AA			
880	80	00000012AA			
960	80	00000013AA			
1040	80	00000014AA			
Command ==>		Scroll CSR			
F1=Help	F2=Zoom	F3=Exit	F4=Expand	F5=RFind	F7=Up
F9=Swap	F10=Left	F11=Right	F12=Cancel		F8=Down

To display the VSAM file without the RBA and record length details, perform either of these actions:

- Ensure that the **Display RBA and Length when browsing VSAM** option in the relevant Editor Options panel is not selected,
- Issue the command `RBALEN OFF`

Figure 31: VSAM file displayed in editor session with RBA and record length details not displayed on page 100 shows the same VSAM file displayed in a Browse session with the RBA and record length not shown.

Figure 31. VSAM file displayed in editor session with RBA and record length details not displayed

Process		Options		Help	
Browse		FMN.RFM0201.KSDS.REUSE.SHR1		At top	
Type	KSDS	Key		RBA	Format CHAR
Col 1					
-<==+===>=-----+-----2-----+-----3-----+-----4-----+-----5-----+-----6-----+-----7-----+					
****	Top of data	****			
00000001AAA*** updateok & reversed ***AAAAAAAAAAAAAAAAAAAAAAAAAAAAAAAAAAAA					
00000002AA					
00000003AA					
00000004AA					
00000005AA					
00000006AA					
00000007AA					
00000008AA					
00000009AA					
00000010AAA*** updateok & reversed ***AAAAAAAAAAAAAAAAAAAAAAAAAAAAAAAAAAAA					
00000011AA					
00000012AA					
00000013AA					
00000014AA					
Command ==>		Scroll CSR			
F1=Help	F2=Zoom	F3=Exit	F4=Expand	F5=RFind	F7=Up
F9=Swap	F10=Left	F11=Right	F12=Cancel		F8=Down

Related topics

[RBALEN primary command on page 1200](#)

[Editor Options panel on page 868](#)

Managing the prefix area

The prefix area displays line numbers that represent the record number of each line in the data set being edited.

The prefix area also doubles as the prefix command entry area. You enter prefix commands by overtyping the line number for the appropriate record.

You can use prefix commands to:

- Insert or delete lines
- Repeat (duplicate) lines
- Move lines
- Shift data
- Limit the data being edited

The prefix area also serves to:

- Highlight unidentified segments when you are working with segmented records with related ID criteria.
- Identify records not selected because of invalid length when you are working with variable-length arrays.
- Indicate why a record is not selected in an editor session.

Related topics

[How File Manager handles segmented data with related ID criteria on page 241](#)

[Support for variable-length arrays on page 182](#)

[Seeing why a record is not-selected on page 312](#)

In an editor session, to see which prefix commands are valid for the current environment, enter an "?" in the prefix area (against any listed line). File Manager displays a list of the line commands you can enter, like those shown in [Figure 32: Using the ? prefix command to display a list of valid prefix commands on page 102](#).

Figure 32. Using the ? prefix command to display a list of valid prefix commands

```

Process  Options  Utilities  Help
                File Manager Available Edit Prefix Commands
                More:      +

You can enter the following commands in the prefix area of the data display:

A      identifies the record after which data is to be moved or copied.
B      identifies the record before which data is to be moved or copied.
BND    place a bounds record here to show current editor bounds.
C      copy one record.
Cn     copy n records.
CC     copy block of records. Mark start and end of block.

COLS   Use COLS to display the columns line. For example:

        000300
        cols  ----+-----10----+-----2-----+-----3-----+-----4-----+-----5---   etc.
        000500

Command ==> _____
F1=Help   F2=Split   F3=Exit   F4=CRetriev F7=Backward F8=Forward
F9=Swap   F10=Actions F12=Cancel

```

In an editor session, you can choose whether a prefix area is displayed next to the data or not.

To specify the default position and display state of the prefix area for *all* editor sessions, set these editor options on the relevant Editor Options panel:

- **Display prefix area**
- **Display prefix area on the right**
- **Prefix area width (A,6,7,8,9)**

To specify the default position and display state of the prefix area for the *current* editor session, use the PREFIX primary command. For example:

- To display the prefix area on the right, enter `PREFIX RIGHT`.
- To display the prefix area as an 8-digit field, enter `PREFIX 8`.
- To display the prefix area with a width that automatically adjusts (from 6 to 9 digits wide) in order to display the record number, enter `PREFIX A`.
- To remove the display of the prefix area, enter `PREFIX OFF`.

You can use most prefix commands on either a single line or a block of consecutive lines:

- To perform an operation on a single line, you enter the appropriate prefix command.
- To perform an operation on a block of consecutive lines, either enter the prefix command preceded or followed by the number of lines, or enter the appropriate block prefix command at the start and end lines of the block.

Generally, you need to type over only the first 1 or 2 characters of the line number to enter a prefix command. Sometimes, however, typing a single character can be ambiguous. In the following example, it is unclear whether the intended prefix command is R to repeat line 31700, or R3 to repeat the line three times:

```
031600
R31700
031800
```

In such cases, the editor assumes that you have not typed a number following the prefix command. If you want to repeat the line three times, you can use any of the following methods:

- Type one or more blanks following the R3:

```
R3 700
```

- Type `R3` and press the Erase EOF key to clear the rest of the Line Command field, or press the Erase EOF key and then type `R3`.
- Type one or more blanks after the R but before the number such that the number when entered is different than the characters being overtyped.:

```
R 3700
```

- Type the number before the R, ensuring that the number when entered is different than the characters being overtyped:

```
3R1700
```

To clear any outstanding commands in the prefix area, use the RESET PREFIX command. See [RESET primary command on page 1208](#).

Prefix commands do not affect not-selected or suppressed records that are hidden from display or represented by shadow lines. For example, if you use the MM prefix command to mark a block of records for moving, then not-selected or suppressed records that are hidden from display or represented by shadow lines are not affected by the move, and are left behind at their original position. Prefix commands **do** affect excluded records, even when they are hidden from display (by SHOW EX OFF and SHADOW EX OFF).

Related topics

[PREFIX primary command on page 1197](#)

Manipulating your view of the data

Once your data has been displayed in the editor panel, you can manipulate your view of the data to focus on the records of interest to you.

Using primary commands in an editor session

When you are viewing or editing data, you can enter primary commands on the Command line of the editor panel to perform the following functions:

Action

Command

Scroll the data

[BOTTOM primary command on page 1122](#)
[DOWN primary command on page 1146](#)
[LEFT primary command on page 1178](#)
[NEXT primary command on page 1191](#)
[PREVIOUS primary command on page 1198](#)
[RIGHT primary command on page 1212](#)
[TOP primary command on page 1232](#)
[UP primary command on page 1234](#)

Scroll to a particular record number or text

[LOCATE primary command on page 1182](#)

Find a string

[FIND/FX primary command on page 1157](#)
[RFIND primary command on page 1211](#)

Change a string

[CHANGE/CX primary command on page 1129](#)
[RCHANGE primary command on page 1201](#)

Switch between display formats

[FORMAT primary command on page 1170](#)
[FORMAT primary command on page 1170](#)
[FORMAT primary command on page 1170](#)
[FORMAT primary command on page 1170](#)
[FORMAT primary command on page 1170](#)

Turn off highlighting of found strings

[RESET primary command on page 1208](#)

Find fields in error

[FE \(Find Error\) primary command on page 1154](#)

Change data in error

[CE \(Change Error\) primary command on page 1126](#)

Print a record

[RD primary command on page 1201](#)
[RP primary command on page 1214](#)

Obtain record and selection statistics

[RECSTATS primary command on page 1205](#)

Hide or show shadow lines[SHADOW primary command on page 1220](#)**Group or ungroup record sets**[SHOW \(REC\) primary command on page 1222](#)**Zoom in to see all of one record**[ZOOM primary command on page 1239](#)**View suppressed records**[VIEW primary command on page 1237](#)**Display data in hexadecimal format**[HEX primary command on page 1172](#)**Show or hide the Field Reference and Redefines columns when in SNGL display**[REFS primary command on page 1206](#)**Show or hide the Field Type and Length columns when in SNGL display**[TYPE primary command on page 1233](#)**Remove or change the logical view**[TEDIT primary command on page 1231](#)[TVIEW primary command on page 1233](#)**Adjust the order of lines**[SORT primary command on page 1224](#)**Display the RBA and record length information**[RBALEN primary command on page 1200](#)**Related topics**[Primary commands on page 1118](#)

Selecting a display format

A display format is a way of arranging your data within the data area of the editor panel, to suit your viewing or editing needs. Display formats can be applied to data that has or has not been given a logical format via a template. Data that has not been formatted with a template can be shown in CHAR, HEX or LHEX display format. Data that has been formatted with a template, can be shown in these formats, as well as in SNGL or TABL display format.

Setting the initial display format

To specify how the editor panel appears at the start of an editor session, set the **Initial Display** option on the relevant Editor Options panel to the required display format.

JUST

Left justifies the numeric fields

PIC

Displays or hides the Picture column

RDF

Displays or hides the Redefines information (within the Field column) and the redefined fields.
This command also affects the display of the redefined fields in TABL display.

REFS

Displays or hides the Field References column

SLOC

Displays or hides the Start column

STR

Displays or hides the structure information in the Field column

TYP

Displays or hides the Type and Length columns

CCSID

Displays or hides the CCSID column.

These are toggle commands that change the display from on to off or off to on, depending on the current status of the panel. The commands only affect the current editor session, they do not change the default settings.

To change the default settings for editor panel:

1. Ensure that you are not currently in an editor session.
2. Choose **Options> Editor options** from the Primary Options menu.
3. Select or clear the following record formatting options for SNGL display or print in the relevant Editor

Options panel:

- Field reference number
- Field type and length values
- Picture clause
- Start location
- Structure
- Left justify numeric fields
- Redefined fields



Note: These options cannot be changed when you are in an editor session.

TABL

Tabular format (only available when using a template). Arranges fields in columns. This format is suitable for viewing information that has been structured into fields and records and you need to review multiple records.

```

REC-TYPE NAME EMPLOYEE-NO AGE SALARY MONTH(1)
#2 #3 #4 #5 #6 #7
AN 1:2 AN 3:20 BI 23:2 BI 25:2 PD 27:4 BI 31:4
<> <---+---1---+---> <---+--> <---+--> <---+---> <---+--->
01 Grant Smith 7712 35 75000 6
01 Andrew Apple 6645 53 78500 30
:

```

In TABL display format, only one record type in the data set is displayed at any time. The column headings at the top of the screen reflect the fields in the current record type. There are three lines in the headings:

```

field_heading
#n [R #n]
type start_column:length
<- ... ->

```

where:

field_heading

Defaults to the field name defined in the copybook. You can change this by editing the template. For details, see [Creating and editing templates on page 173](#).

#n [R #n]

The field reference. You use this to refer to the field in File Manager. For example, to limit the FIND primary command to searching only certain fields, you specify the field references for those fields.

If the field redefines another field, then this is shown by the "R" notation, followed by the field it redefines. For example, #5 [R #4] shows that this is field 5, which redefines field 4.

type

The field data type.

start_column

The field start column.

length

The field length.

<- ... ->

Ruler, indicating the size of the field.

Records of other types are "suppressed" from display: they are either hidden or represented by shadow lines.

In CHAR, HEX and LHEX formats, and for alphanumeric fields in SNGL or TABL formats, characters that cannot be displayed (“non-displayable” characters) are represented as periods.

- You can display hexadecimal values under your formatted field data by entering `HEX ON` on the Command line. For example, if you are viewing data in TABL display format and your display looks something like this:

```
Order# # Items Date   Time   Seller Buyer   (1)  (1)
#6      #7 #9    #13    #18   #19   #31  #32
A00001      1 900227 010101 1144   20    25  9999
A00004      1 900310 100530 1144   10    15  0099
```

then issuing the command `HEX ON` causes the hexadecimal representation to be displayed:

```
Order# # Items Date   Time   Seller Buyer   (1)  (1)
#6      #7 #9    #13    #18   #19   #31  #32
A00001      1 900227 010101 1144   20    25  9999
CFFFFFF 00001 FFFFFFF FFFFFFF 0014  0000  0001  0020
100001  0000F 900227 010101  014F  002F  0009  007F

A00004      1 900310 100530 1144   10    15  0099
CFFFFFF 00001 FFFFFFF FFFFFFF 0014  0000  0000  0006
100004  0000F 900310 100530  014F  001F  000F  0003
```

- If a numeric field contains data that cannot be correctly interpreted as a numeric value (for example, a packed decimal field contains invalid packed values), then the field is displayed as highlighted asterisks.
- If a numeric field contains a valid numeric value, but the value is too large to fit in the width allocated to the field on the screen (as defined in the picture specification of the original copybook), then the value is truncated. The field is highlighted to indicate that truncation has occurred.

To show the entire field without truncation, you need to edit the template, and specify an output width for the field.

- If a field is a array element, then its field heading is followed by a subscript in parentheses; for example, `ELEMENT(1)`.

Related topics

[FORMAT primary command on page 1170](#)

[HEX primary command on page 1172](#)

[Zooming in to see all of a record on page 112](#)

[REFS primary command on page 1206](#)

[TYPE primary command on page 1233](#)

[Editor options \(option 0.6\) on page 82](#)

[Editor Options panel on page 868](#)

[Filtering record display using templates on page 309](#)

Displaying a column identification line

In an editor session, when you are in CHAR, HEX, or LHEX display format, you can enter the `COLS` prefix command to display a column identification line. The column identification line is identical to the line already shown at the top of the data but can be useful in checking the position of data in a record.

To display the column identification (=COLS>) line:

1. Type COLS in the prefix area of any line.
2. Press Enter.

The column identification line is inserted in the data set or member after the line in which you entered COLS. The column identification line moves with the rest of the data when you scroll through the data set or member.



Note: You can use the COLS prefix command with the BOUNDS prefix command to help check and reposition the bounds settings.

To remove the column identification line from the panel, either type D in the prefix area that contains the =COLS> flag, or type RESET on the command line:

Figure 33: Before the COLS prefix command on page 111 shows the boundary definition line with the COLS command typed in the prefix area of the following record.

Figure 33. Before the COLS prefix command

```

Process  Options  Help
-----  -
Edit          JHELVON.TEST.DATA(EMP)                Top of 40
Col 1      Insert Length 80      Record AT TOP      Format LHEX
- - - - + - - - - 10 - - - + - - - - 2 - - - - + - - - - 3 - - - - + -
***** **** Top of data ****
000001 F0F1C7998195A340E2A4A388859993819584404040401E2000380075111F000000060000
000002 F0F1C195849985A640C1A2A3938540404040404019D400150075000F0000001E0000
000003 F0F1C7998188819440D7A4998489854040404040158800180068000F000000070000
000004 F0F1C289939340E2969785994040404040404011AB001C0068000F000000050000
000005 F0F1E3A89996958540C481938189A240404040400C6200150060000F0000000E0000
BND      <                               >
cols06  F0F1D9968440E3A499958599404040404040138E00230100000F0000001C0000
000007 F0F1C39389A58540D5858193969540404040404008D1002F0100000F0000002C0000
000008 F0F1D1899440C19385A781958485994040404040400534003F0125000F0000002F0000
000009 F0F1E28993A581959640D79985A9404040404040400B4F00320060000F000000010000
000010 F0F1C4969540D7888199968188404040404040131A00370063000F000000260000
000011 F0F1D196889540D385A599899587A3969540404040400D1000280067000F0000000E0000
000012 F0F1D389A940D9A4A288A39695404040404040400ECD00280066000F0000002C0000
000013 F0F1C2968240D483C3969994818392404040404012FD00280076000F0000000A0000
000014 F0F1D28589A38840E2A385A68199A3404040404040084100280070000F0000001A0000
Command ==>                               Scroll CSR
F1=Help   F2=Zoom   F3=Exit   F4=CRetriev  F5=RFind   F6=RChange
F7=Up     F8=Down   F9=Swap   F10=Left    F11=Right  F12=Cancel

```

When you press Enter, File Manager inserts the COLS line, as shown in Figure 34: After the COLS prefix command on page 112.

Figure 34. After the COLS prefix command

```

Process  Options  Help
-----
Edit          JHELVON.TEST.DATA(EMP)                Top of 40
Col 1_____ Insert Length 80_____ Record AT TOP_____ Format LHEX
- - - - - + - - - - 10 - - - - + - - - - 2 - - - - + - - - - 3 - - - - + -
*****      **** Top of data      ****
000001 F0F1C7998195A340E2A4A388859993819584404040401E2000380075111F000000060000
000002 F0F1C195849985A640C1A2A393854040404040404019D400150075000F0000001E0000
000003 F0F1C7998188819440D7A499848985404040404040158800180068000F000000070000
000004 F0F1C289939340E296978599404040404040404011AB001C0068000F000000050000
000005 F0F1E3A89996958540C481938189A24040404040400C6200150060000F0000000E0000
BND      <                               >
=COLS>  - - - - + - - - - 10 - - - - + - - - - 2 - - - - + - - - - 3 - - - - + -
000006 F0F1D9968440E3A4999585994040404040404040138E00230100000F0000001C0000
000007 F0F1C39389A58540D585819396954040404040404008D1002F0100000F0000002C0000
000008 F0F1D1899440C19385A781958485994040404040400534003F0125000F0000002F0000
000009 F0F1E28993A581959640D79985A9404040404040400B4F00320060000F000000010000
000010 F0F1C4969540D788819996818840404040404040131A00370063000F000000260000
000011 F0F1D196889540D385A599899587A3969540404040400D1000280067000F0000000E0000
000012 F0F1D389A940D9A4A288A39695404040404040400ECD00280066000F0000002C0000
000013 F0F1C2968240D483C396999481839240404040404012FD00280076000F0000000A0000
Command ==>
F1=Help      F2=Zoom      F3=Exit      F4=CRetriev  F5=RFind     F6=RChange
F7=Up        F8=Down      F9=Swap      F10=Left     F11=Right    F12=Cancel

```

Zooming in to see all of a record

In CHAR, HEX, or LHEX display format, if you want to show all of the data in a particular record without having to scroll left or right, you can “zoom in” by moving the cursor to the record, then pressing the Zoom function key (F2). File Manager limits the display to just that record, as shown in [Figure 35: Zooming in on one record \(CHAR display format\) on page 112](#).

The zoomed display automatically scrolls to the column that was shown in the **Col** field prior to zooming.

Figure 35. Zooming in on one record (CHAR display format)

```

Process  Options  Help
-----
View          FMN.V14R1M20.SFMNSAM1(FMNCDATA)        Rec 1 of 40
Col 1_____ Format CHAR
Record Length Byte ----+----1----+----2----+----3----+----4----+----5----+----6
40          80      1 02Grant Smith      Developer      22 Montrose St      Thor
              61 nlie                6145

Command ==>
F1=Help      F2=Zoom      F3=Exit      F4=CRetriev  F5=RFind     F6=RChange
F7=Up        F8=Down      F9=Swap      F10=Left     F11=Right    F12=Cancel

```



Note: This example shows data from the second record type in the sample data set, as that record type holds more character information.

To zoom out, press the Zoom function key (F2) again. Zooming toggles between zooming in on one record and zooming out to show multiple records. When you zoom out, the display format returns to its setting prior to zooming in. For example, if you zoom in when the display format is CHAR, then change to SNGL, zooming out returns the display to CHAR format.

In SNGL or TABL display formats, when you zoom in on a record, just that record is displayed in “zoomed” SNGL display format, as shown in [Figure 36: Zooming in on one record \(“zoomed” SNGL display format\) on page 113](#). This format differs from “normal” SNGL display format, in that:

- In this display format, you cannot navigate between records.

In “un-zoomed” SNGL display format, you can navigate between records using the PREVIOUS and NEXT primary commands or Previous function key (F10) and Next function key (F11).

- When you view a record in “zoomed” SNGL display format, File Manager displays all fields, regardless of whether or not they were selected for display in the template.

Figure 36. Zooming in on one record (“zoomed” SNGL display format)

Process	Options	Help				
View FMN.V14R1M20.SFMNSAM1 (FMNCDATA) Rec 1 of 40						
Current type is REC-TYPE02 Zoom Format <u>SNGL</u>						
Top Line is 1 of 11 in Record 21						
Ref	Field	Picture	Typ	Start	Len	Data
1	1	REC-TYPE02	AN	1	80	
2	2	REC-TYPE	AN	1	2	02
3	2	NAME X(20)	AN	3	20	Grant Smith
4	2	JOB-TITLE	AN	23	14	Developer
5	2	ADDR1 X(20)	AN	37	20	22 Montrose St
6	2	ADDR2 X(20)	AN	57	20	Thornlie
7	2	POSTCODE	AN	77	4	6145
**** End of record ****						
Command ==>						Scroll PAGE
F1=Help	F2=Zoom	F3=Exit	F4=CRetrie	F5=RFind	F7=Up	
F8=Down	F9=Swap	F12=Cancel				



Note: SNGL view with the STR command active provides a view of your record structure that is identical to the ZOOM SNGL view and allows you to scroll between the records.

In TABL or normal (“un-zoomed”) SNGL display format, File Manager only shows the fields selected for display in the template. For instance, in the example shown in [Figure 36: Zooming in on one record \(“zoomed” SNGL display](#)

[format](#)) on page 113, if you edit the template to deselect the field JOB-TITLE, in “un-zoomed” SNGL display format the record looks like this:

Figure 37. SNGL format with unselected fields

<u>P</u> rocess	<u>O</u> ptions	<u>H</u> elp
View FMN.V14R1M20.SFMNSAM1(FMNCDATA) Rec 21 of 40		
Current type is REC-TYPE02 Format <u>SNGL</u>		
Ref	Field	Picture Typ Start Len Data
2	REC-TYPE	XX AN 1 2 02
3	NAME	X(20) AN 3 20 Grant Smith
5	ADDR1	X(20) AN 37 20 22 Montrose St
6	ADDR2	X(20) AN 57 20 Thornlie
7	POSTCODE	X(4) AN 77 4 6145
****	End of record	****
Command ==> <u>Scroll PAGE</u>		
F1=Help	F2=Zoom	F3=Exit
F8=Down	F9=Swap	F10=Previous
		F11=Next
		F12=Cancel
		F5=RFind
		F7=Up

In TABL display format, zooming in automatically scrolls to the field that was at the left of the screen when the display format was TABL.

Related topics

- [ZOOM primary command on page 1239](#)
- [STR primary command on page 1228](#)
- [Selecting a display format on page 105](#)
- [View panel on page 1083](#)
- [Editor panel on page 853](#)
- [Changing the length of a record on page 171](#)

Displaying the record length

When you are viewing a file in a multi-line display format (TABL, CHAR, HEX, or LHEX), you can select to display the record length of each record.



Note: In SNGL and zoomed display formats, the record length is *always* displayed.

The display of this information is initially controlled by options in the Editor Options panels (which apply to each new editor session):

Display record length

Turns on the display of record lengths. By default, File Manager displays the record length on the left of the data.

Display record length on the right

Displays the record length on the right of the data (only when the **Display record length** option is selected or if you issue the `RECLLEN ON` command during an editor session).

Record length width (A,3,4,5,6)

Controls the width of the record length display area.

However, when viewing data in an editor session you can use the `RECLLEN` primary command to temporarily change the record length display options for the current editor session:

`RECLLEN ON`

Turn on the display of record lengths. (Record lengths are displayed on the left of the data, unless the **Display record length on the right** editor option is selected.)

`RECLLEN OFF`

Turn off the display of record lengths.

`RECLLEN RIGHT`

Turn on the display of record lengths and display record lengths on the right of the data.

`RECLLEN n`

Set the width of the record length display area to n characters, where n can be 3, 4, 5, or 6.

`RECLLEN A`

Set the width of the record length display area according to the value of the record lengths.

Figure 30: VSAM file displayed in Browse session with RBA and record length details displayed on page 100 shows part of a file displayed in an editor session with no record length information displayed.

Figure 38. Data displayed in an editor session with no record length details shown

Process	Options	Help
View	PROWSE.JCL(FMNCDATA)	
		Record AT TOP Top of 40 Format TABL
REC-TYPE	NAME	EMPLOYEE-NO AGE SALARY MONTH(1)
#2	#3	#4 #5 #6 #7
AN 1:2	AN 3:20	BI 23:2 BI 25:2 PD 27:4 BI 31:4
<>	<-----1----->	<----+> <----+> <----+> <----+-----1>
*****	****	Top of data ****
000001	01	Garry Northfield 7712 96 75111 6
000002	01	Graeme Bevan 6612 21 75000 30
000003	01	Philip Padler 5512 94 68000 7
000004	01	Will Lever 4412 28 68000 5
000005	01	Tiryll Dasher 3312 21 60000 14
000006	01	Ron Turtle 5612 100 100000 28
000007	01	David Nelson 2212 100 100000 44
000008	01	Jon Bloodston 1112 110 125000 47
000009	01	Stephen Poot 2312 50 60000 1
000010	01	Dan Peterah 4412 55 63000 38
000011	01	Jean Flowerpat 3412 40 67000 14
000012	01	Liz Hurring 3412 40 66000 44
Command ==>		Scroll CSR
F1=Help	F2=Zoom	F3=Exit F4=CRetriev F5=RFind F6=RChange
F7=Up	F8=Down	F9=Swap F10=Left F11=Right F12=Cancel

To display the record length information on the left of the data, enter:

```
RECLEN LEFT
```

Alternatively, if the **Display record length on the right** option on the relevant Editor Options panel is *not* selected, you can enter:

```
RECLEN ON
```

Figure 39: Record length details displayed in editor session on left of data on page 116 shows the same data displayed with the record length displayed on the left of the data.

Figure 39. Record length details displayed in editor session on left of data

Process	Options	Help
View	PROWSE.JCL(FMNCDATA)	
		Record AT TOP Top of 40 Format TABL
	REC-TYPE NAME	EMPLOYEE-NO AGE SALARY
	#2 #3	#4 #5 #6
	AN 1:2 AN 3:20	BI 23:2 BI 25:2 PD 27:4
<>	<---+---1---+--->	<---+> <---+> <---+--->
*****	**** Top of data ****	
000001	80 01 Garry Northfield	7712 96 75111
000002	80 01 Graeme Bevan	6612 21 75000
000003	80 01 Philip Padler	5512 94 68000
000004	80 01 Will Lever	4412 28 68000
000005	80 01 Tiryll Dasher	3312 21 60000
000006	80 01 Ron Turtle	5612 100 100000
000007	80 01 David Nelson	2212 100 100000
000008	80 01 Jon Bloodston	1112 110 125000
000009	80 01 Stephen Poot	2312 50 60000
000010	80 01 Dan Peterah	4412 55 63000
000011	80 01 Jean Flowerpat	3412 40 67000
000012	80 01 Liz Hurring	3412 40 66000
Command ==>		Scroll CSR
F1=Help	F2=Zoom	F3=Exit
F7=Up	F8=Down	F9=Swap
	F4=CRetriev	F5=RFind
	F10=Left	F11=Right
		F6=RChange
		F12=Cancel

To display the record length information on the right of the data, enter:

```
RECLEN RIGHT
```

Alternatively, if the **Display record length on the right** option on the relevant Editor Options panel is selected, you can enter:

```
RECLEN ON
```

Figure 40: Record length details displayed in editor session on right of data on page 117 shows the same data displayed with the record length displayed on the right of the data.

Figure 40. Record length details displayed in editor session on right of data

Process		Options		Help		
View	PROWSE.JCL(FMNCDATA)					Top of 40
	REC-TYPE	NAME	EMPLOYEE-NO	AGE	SALARY	Format <u>TABL</u>
	#2	#3	#4	#5	#6	
	AN 1:2	AN 3:20	BI 23:2	BI 25:2	PD 27:4	
	<>	<-----1----->	<----+>	<----+>	<----+>	
***** ***** Top of data *****						
	000001	01 Garry Northfield	7712	96	75111	80
	000002	01 Graeme Bevan	6612	21	75000	80
	000003	01 Philip Padler	5512	94	68000	80
	000004	01 Will Lever	4412	28	68000	80
	000005	01 Tiryll Dasher	3312	21	60000	80
	000006	01 Ron Turtle	5612	100	100000	80
	000007	01 David Nelson	2212	100	100000	80
	000008	01 Jon Bloodston	1112	110	125000	80
	000009	01 Stephen Poot	2312	50	60000	80
	000010	01 Dan Peterah	4412	55	63000	80
	000011	01 Jean Flowerpat	3412	40	67000	80
	000012	01 Liz Hurring	3412	40	66000	80
Command ==>						
	F1=Help	F2=Zoom	F3=Exit	F4=CRetriev	F5=RFind	Scroll <u>CSR</u>
	F7=Up	F8=Down	F9=Swap	F10=Left	F11=Right	F6=RChange F12=Cancel

To set the width of the field length display area for all editor sessions, set the **Record length width** option on the relevant Editor Options panel to A, 3, 4, 5, or 6. Setting this option to "A" causes the width of the record length area to be automatically adjusted as required.

To change the width of the field length display area for the current editor session, issue the RECLLEN command. For example, to change the width of the field length display area to 4, enter:

```
RECLLEN 4
```

Related topics

[RECLLEN primary command on page 1204](#)

[Editor Options panel on page 868](#)

[Changing the length of a record on page 171](#)

Scrolling to see data

To scroll through your data, use the following function keys:

Use this function key

To do this...

Scroll backward (up)

Up function key (F7)

Scroll forward (down)

Down function key (F8)

Next function key (F11)

Go to the next record

Previous function key (F10)

Go to the previous record

Scroll right

Right function key (F11)

Scroll left

Left function key (F10)

You can also scroll using the primary commands UP, DOWN, LEFT, RIGHT, TOP, BOTTOM, NEXT and PREVIOUS. For details, see [Primary commands on page 1118](#).

In SNGL display format, to move forward n records, perform either of these actions:

- Enter NEXT n on the Command line
- Enter n on the Command line and press Next function key (F11)



Note: If you specify a number of records greater than the number of subsequent records, File Manager displays the “**** End of data ****” indicator. You can then press the Previous function key (F10) to view the last selected record.

In SNGL display format, to move back n records, perform either of these actions:

- Enter PREVIOUS n on the Command line
- Enter n on the Command line and press Previous function key (F10)



Note: If you specify the MAX parameter, the first selected record is displayed. If you specify a number of records greater than the number of prior records, File Manager displays the “**** Top of data ****” indicator. You can then press the Next function key (F11) to view the first selected record.

Examples

```
LEFT 8
```

Scrolls 8 columns to the left.

```
LEFT
```

Scrolls left the number of columns indicated by the **Scroll** field.

```
LEFT CSR
```

If the cursor is positioned on a record, scrolls left to the cursor position; otherwise scrolls left one page.

```
UP 15
```

Scrolls up 15 lines.

UP

Scrolls up the number of lines indicated by the **Scroll** field.

UP DATA

Scrolls up one line less than a page of data.

Related topics

- [UP primary command on page 1234](#)
- [DOWN primary command on page 1146](#)
- [LEFT primary command on page 1178](#)
- [RIGHT primary command on page 1212](#)
- [PREVIOUS primary command on page 1198](#)
- [NEXT primary command on page 1191](#)
- [TOP primary command on page 1232](#)
- [BOTTOM primary command on page 1122](#)

Controlling how far you scroll

To control how far you scroll when you press one of the scrolling function keys, enter a scroll amount in the **Scroll** field:

Scroll amount**Scrolls...****PAGE**

One screen at a time

HALF

Half a screen at a time

DATA

One line or column less than a screen at a time

CSR

To the cursor position (if the cursor is not positioned on a record when the scroll is performed, then the scroll amount defaults to PAGE)

MAX

To the end of the data in the direction indicated by the scrolling function key.

nnnn

A number of columns (when scrolling left or right) or a number of records or lines (when scrolling up or down) at a time

**Note:**



1. When you use the Next function key (F11) or Previous function key (F10) to scroll through records, the only indication that a hidden record has been skipped is that the record number (shown in the upper right corner of the screen) skips accordingly. For details, see [Hiding or showing records in SNGL display format on page 313](#).
2. In TABL display format, scrolling left or right moves to the start of the field that is closest to the specified scroll amount. For example, if the **Scroll** field contains CSR, then moving your cursor into a field and pressing the Right function key (F11) scrolls the display right so that the first column of the field is at the left of the screen. If you enter a numeric (*nnnn*) scroll amount, it is treated as an absolute column number (rather than a relative number), and the display scrolls to the start of the field that occupies that column.

You can temporarily override the amount in the **Scroll** field by typing a scroll amount on the Command line, then pressing a scroll function key. For example, if you enter `8` on the Command line, then press the Right function key (F11), File Manager scrolls right 8 columns.

Scrolling to the first or last record or column

To scroll to the first or last record or first or last column in the data set, type `MAX` (or `M`) on the Command line, then press one of the scroll function keys. For example, typing `M` then pressing the Right function key (F11) scrolls right to the last column.

You can also scroll to the first or last record by entering `TOP` or `BOTTOM` on the Command line.

When you perform one of these actions:

- View or edit KSDS or ESDS data sets that do not fit into available memory.
- Use in-place editing for KSDS or ESDS data sets (regardless of the file size).

and you use the `BOTTOM`, `DOWN MAX` or `NEXT MAX` commands (to scroll to the end of the data), File Manager uses the best-performing technique to navigate directly to the last record. Similarly, while viewing a ESDS or KSDS, you may navigate directly to a record by entering a RBA or KEY value. In these situations, as File Manager does not know the relative record number, it displays "Record number unknown" in place of the record number and displays '=====' in the prefix area. (This message does not signify an error condition.) To make File Manager aware of the number of records in the data set, issue the `RECSTATS` primary command.

To reset your display after this has occurred, scroll to the top of the data set.

To avoid this situation, scroll down in increments, for example, `DOWN 9999`, until the end of the data set is reached.

Alternatively, if you know the last record number, use the `LOCATE` command to go to that record. Once File Manager has recognized the record number, you can scroll in any direction, using any of the various scrolling methods, and this display situation does not reoccur.

Holding columns on the display when scrolling

You can hold fields so that they are always displayed regardless of how far you scroll.

In TABL display format, held fields always appear as the leftmost fields on the screen (in the order that you held them when editing the template). Held fields take priority, as far as the left-to-right display is concerned, over other fields.

In SNGL display format, held fields always appear as the topmost fields on the screen (in the order that you held them when editing the template). Held fields take priority, as far as the top-to-bottom display is concerned, over other fields.

Related topics

[Holding fields on the display when scrolling on page 227](#)

Locating a field, column or record number

To scroll to a particular record number, use the LOCATE primary command:

```
LOCATE record_number
```

In all display formats, you can scroll to a particular record number by typing the record number in the **Record** field, then pressing Enter.

In all display formats except SNGL and TABL, you can scroll to a particular column by typing the column number in the **Col** field, then pressing Enter.

In SNGL and TABL display format, you can use the LOCATE primary command to scroll to a particular field, using either the field reference number or the Field Name. For example:

```
LOCATE #5
```

or

```
LOCATE Age
```

When the field is an item in an array, you must specify a subscript in parentheses to identify the occurrence that you want to locate. If your field is part of a multi-dimensional array, you must specify a subscript for each dimension in the array. For example:

```
L #7(5)
```

```
L #9(2,3)
```

In TABL display format, the LOCATE command scrolls your view so that the specified field becomes the leftmost visible field. Once positioned on a field, you can use the Down (F8) or Up (F7) commands (function keys) to scroll through the records and maintain the same relative field view.

In SNGL display format, the LOCATE command scrolls your view so that the specified field becomes the topmost visible field. Once positioned on a field, you can use the Next (F11) or Prev (F10) commands (function keys) to scroll through the records and maintain the same relative field view.

Related topics

[LOCATE primary command on page 1182](#)

Scrollable input and display fields for long names

Some File Manager panels have *scrollable fields* that allow you to input or view longer values than can be displayed at the one time.

There are two types of scrollable fields on File Manager panels:

Input fields

The fields on File Manager panels where you can *enter* information, such as a data set name.

Display fields

The fields on File Manager panels that *display* information as a result of some action you have taken. For example, when you display data on the Browse, Edit, or View panel in a File Manager editor session, the data set name displayed at the top of the panel is a scrollable display field.

The following two sections describe how to work with both types of scrollable field when entering or viewing longer fields.

Working with scrollable input fields

On several panels, File Manager provides scrollable input fields that allow you to enter values longer than length of the displayed entry field.

You can recognise a scrollable field by the presence of one of the following adjacent to the end of the entry field:

+

Plus sign. Indicates the field is scrollable to the right

-

Minus sign. Indicates the field is scrollable to the left

+-

Plus sign and minus sign. Indicates the field is scrollable to the right or left

If the length of the input field displayed on the panel is insufficient for the value you want to enter, you can either:

- Progressively scroll to the right as you enter the value with the Right function key (F11) or by entering the RIGHT primary command (with the cursor positioned within the entry field), or
- Press the Expand function key (F4) if available, or enter the EXPAND primary command, to display a window that allows you to enter the full length of the value.

In the expand pop-up window, you can toggle the view of the data between character and hex by issuing the commands HEX OFF and HEX ON.

Deleting data in scrollable input fields

If you want to delete all the data in a field that is displayed as a scrollable input field, take care to ensure that you do, in fact, delete all the data (and not just the displayed data).

If you use the field delete key combination to delete data, File Manager deletes only the data that is currently displayed. If the field contains more data than is displayed, the undisplayed data is left undeleted.

Before deleting data in a scrollable input field, first display the entire contents of the field by pressing the Expand function key (F4) or entering the EXPAND primary command. You can then use the field delete key combination to delete all data in the field at once.

Working with scrollable display fields

Some File Manager panels show data displayed in scrollable fields. File Manager uses such fields where the length of the field containing the data to be displayed is longer than the field displayed on the panel.

You can recognise a scrollable field (and where more data exists than can be shown at one time on the panel) by the presence of one of the following adjacent to the end of the display field:

+

Plus sign. Indicates the field is scrollable to the right

-

Minus sign. Indicates the field is scrollable to the left

+-

Plus sign and minus sign. Indicates the field is scrollable to the right or left



Note: The "+", "-", and "+-" signs are only shown adjacent to the end of a scrollable display field when the data to be displayed is longer than the length of the display field on the panel.

If the data to be displayed is longer than the length of the display field on the panel, you can view the rest of the data by either:

- Progressively scrolling to the right by pressing the Right function key (F11) or by entering the RIGHT primary command (with the cursor positioned within the display field), or
- Pressing the Expand function key (F4) or entering the EXPAND primary command to display a window that allows you to view the entire contents of the field.

Related topics

[EXPAND primary command on page 1154](#)

Sorting the data

You can sort your data by using the SORT primary command. With this command, you can sort the data in any of the following ways:

- On up to 5 specified column ranges (CHAR, HEX, or LHEX display formats only).
- On up to 5 fields by specifying the field reference numbers (TABL display format only).
- Into the KEY or SLOT NUMBER sequence for the data set (KSDS, VRDS, and RRDS VSAM data sets).



Note: SORT requires that all data set records be memory-resident. If the entire data set can not fit into your region storage, an error is reported and the SORT execution aborted. If necessary, increase the region size to contain the entire data set.

You can specify whether you want the data sorted in ascending (the default) or descending sequence and, in Edit, you can restrict the sorting to excluded records or not-excluded records only.

To sort by a column range:

1. Display your data in CHAR, HEX or LHEX format.
2. Enter the SORT primary command, followed by up to five pairs of column range values. For example:

```
SORT 56 70 3 22
```

sorts a data set into ascending order, using the range 56-70 as the first key and range 3-22 as the second key.

To sort by field references:

1. Display your data in TABL format (requires that you have specified a template).
2. Enter the SORT primary command, followed by up to five field references. For example:

```
SORT #6 D #3 D
```

sorts a data set into descending order, using field #6 as the first key and field #3 as the second key.

To restore a list to the KEY or SLOT NUMBER order (KSDS, VRDS, and RRDS VSAM data sets):

1. Display your KSDS, VRDS, or RRDS VSAM data set in any display format.
2. Sort the data away from the KEY or SLOT NUMBER order by issuing a SORT command, by moving or adding records or by editing the key field (KSDS only). If you have edited your records, issue the SAVE command.
3. Restore your data to its KEY or SLOT NUMBER order by issuing the SORT command followed by the KEY parameter, for example:

```
SORT KEY.
```

sorts a data set into descending order, using field #6 as the first key and field #3 as the second key.

Examples

- If you are *not* using a template:

```
SORT 23 36
```

Sorts all records on columns 23 to 36 in ascending order.

```
SORT 77 80 D NX
```

(Edit only.) Sorts not-excluded records on columns 77 to 80 in descending order (as if excluded records did not exist).

```
SORT 77 80 D 23 36 3 21
```

Sorts all records on columns 77 to 80 (primary sort key) in descending order, then on columns 23 to 36 (secondary sort key) in ascending order, then on columns 3 to 21 (minor sort key) in ascending order.

```
SORT KEY
```

Restores the records in a KSDS, VRDS, or RRDS VSAM data set into their original keyed sequence.

SORT KEY behaves differently for RRDS and KSDS files. For RRDS files the VSAM slot value is used as the sort key while KSDS files use the key field. If new records are added to an RRDS file they are allocated a slot value such that they sort to the end of the file when SORT KEY is performed. New records added to the KSDS are sorted on the new key value and the new records sorted to the appropriate position within the file.

- If you *are* using a template (TABL display format):

```
SORT #7 D #6 #3
```

Sorts all records on the field with field reference number 7 (primary sort key) in descending order, then on the field with field reference number 6 (secondary sort key) in ascending order, then on the field with field reference number 3 (minor sort key) in ascending order,

```
SORT #6 X
```

(Edit only.) Sorts all excluded records on the field with field reference number 6 in ascending order (as if non-excluded records did not exist).

Related topics

[SORT primary command on page 1224](#)

Finding specific data

To find one or more occurrences of a character string in a data set or data set member, you can use the FIND primary command, which you can abbreviate as F or /.

For example, to search for the next occurrence of the string “James” in any mix of uppercase and lowercase, enter the following on the Command line:

```
F JAMES
```

To find the same string as you specified on the previous FIND primary command, specify an asterisk (*) as the search string.

To limit the search for a string to only where it appears as a prefix in the data, specify the PREFIX parameter.

To limit the search for a string to only where it appears as a suffix in the data, specify the SUFFIX parameter.

To limit the search for a string to only where it appears as a "word" in the data, specify the WORD parameter.



Note:

1. To find long strings that do not fit on the Command line, use the FX command.
2. To find and replace strings in multiple data sets or data set members, use the Find/Change Utility.
3. To find and change a string or numeric value, open your data set in an Edit session, then use the CHANGE or CX primary command.
4. By default, in SNGL or TABL display formats, if you enter the CHANGE, FIND, or EXCLUDE command without specifying any field references, File Manager searches all the visible fields based on the template attributes for each field. That is:
 - For a field with alphanumeric field attributes, the command performs a string comparison between the search string and the field being searched.
 - For a field with numeric field attributes, the command interprets the search string as a number, and performs a numeric comparison with the numeric value of the field being searched.
5. If you want to prevent numeric comparisons from occurring, you can explicitly mark the argument as character by using the C'*string*' format. For example, this command finds only instances of alphanumeric fields containing the character "0":

```
FIND c'0' ALL #3,#5
```

Related topics

- [Handling long strings in CHANGE on page 152](#)
- [Finding and changing data in multiple PDS members on page 368](#)
- [Finding and replacing strings on page 149](#)
- [Setting column ranges on page 155](#)
- [FIND/FX primary command on page 1157](#)
- [CHANGE/CX primary command on page 1129](#)

Searching numeric fields

The display format, and whether or not you specify field column numbers (either as a list or a range) affects how the CHANGE, FIND, and EXCLUDE commands search numeric columns:

- When searching data in SNGL or TABL display formats, for a field with numeric field attributes, File Manager by default interprets the search string as a number and performs a numeric comparison with the formatted numeric value of the field being searched.

The numeric value of the search string must equal the formatted numeric value of the field. The lengths (number of digits) of the search string and of the numeric field are not significant. Similarly, the data type of the numeric field is not significant. For example, a search string of 123 matches a packed-decimal field containing 00123 or a floating-

point field containing 1.230E+02. A search string of 123 does not match a packed-decimal field containing 12300 (because the numeric values are different). An unsigned value in the string is considered to be positive.

- In CHAR, HEX, and LHEX display formats, or if you specify a column range, File Manager performs a string comparison between the search string and the character representation of the numeric field. If the search string happens to match the character representations of some of the bytes in a binary or packed decimal numeric field, then the numeric field is considered to be a match for the search string (and, for a FIND command, the entire field is highlighted). Similarly, a search string of 123 matches any “zoned” (or “display”) numeric field whose value contains that sequence of digits (for example, 12300 or 41235).

For example, the following command finds instances of an alphanumeric field (#3) containing the character "0" (such as "1060 HAY ST"), and instances of a numeric field (#5) whose formatted numeric value is zero:

```
FIND 0 ALL #3,#5
```

Handling long strings in FIND

You can use the FIND command to specify a string that is up to 100 characters long. However, when you are dealing with long strings, you might find that you cannot fit the whole FIND command (including other parameters) on the Command line. To overcome this problem, do one of the following to display an Extended Command Entry pop-up panel (see [Figure 41: Extended Command Entry pop-up panel for the FIND command on page 128](#)):

- Enter `FX` (for Find Extended)
- Enter the FIND primary command (or one of its abbreviations, such as F) *with no parameters*.

The Extended Command Entry pop-up panel contains five lines (each 50 characters long) that you use to enter all the FIND command parameters (but not the actual keyword FIND or any of its abbreviations). File Manager treats the five lines on the pop-up panel as contiguous, allowing you to specify a long search string and any other parameters, using up to 250 characters in total.



Note: You can continue a string (or any other parameter) from the last position on one line of the pop-up panel to the first position of the next line. However, this does not mean that you need to completely fill a line before using the next line. For example, you can specify the search string on the first of the five lines and the other parameters on the next line. If you are not specifying a quoted string and you do not use all of a line, File Manager treats the unused part of the line as a single space. When you specify a string with quotation marks, any trailing blanks and any leading blanks in the next line are retained.

[Figure 41: Extended Command Entry pop-up panel for the FIND command on page 128](#) shows the Extended Command Entry pop-up panel for the FIND command. This example searches for all occurrences of the string “dichlorodiphenyltrichloroethane” in field #3 for non-excluded records only.

Figure 41. Extended Command Entry pop-up panel for the FIND command

```

Process  Options  Help
-----
Edit      USERID.FMDATA(NEWDATA1)                               Rec 0 of 40
                                                    Format TABL

----- Extended Command Entry -----
Complete typing the FIND command and press Enter.
0  FIND      ==>  dichlorodiphenyltrichloroethane
0            ==>  all #3 nx
0            ==>
0            ==>
0            ==>
0  F1=Help   F2=Split  F3=Exit   F9=Swap   F12=Cancel
0
000009 000140 ammonium hydroxide solution
000010 000150 dichlorodiphenyltrichloroethane
000011 **** End of data ****

Command ==> fx
F1=Help   F2=Zoom    F3=Exit   F4=CRetriev F5=RFind   F6=RChange
F7=Up     F8=Down    F9=Swap   F10=Left   F11=Right  F12=Cancel

```

Related topics

[Handling long strings in CHANGE on page 152](#)

[Handling long strings in EXCLUDE on page 130](#)

[FIND/FX primary command on page 1157](#)

Finding and correcting errors in your data

To find errors in your data (without correcting them), you can enter the FE (Find Error) primary command. This finds the following types of errors:

- Numeric fields whose contents cannot be formatted as a valid numeric value
- Fields that run over the record length

When you enter the FE command, File Manager positions the cursor at the beginning of the field in error and, if necessary, automatically scrolls the data to bring the field into view.

To move the cursor to the next field in error, either enter the FE command again, or press the RFind function key (F5).

To find *and change* numeric fields flagged as being in error (all asterisks in the field display) to a specific numeric value, use the CE primary command.

Related topics

[FE \(Find Error\) primary command on page 1154](#)

[CE \(Change Error\) primary command on page 1126](#)

[Limiting the effect of editing changes on page 154](#)

[Changing invalid numeric fields in your data on page 153](#)

[View panel on page 1083](#)

[Editor panel on page 853](#)

Excluding records from display

You can hide records from your view, by *excluding* records that have some common factor.

To exclude multiple records based on a common factor:

- Enter EXCLUDE with the relevant parameters on the Command line.

For example, the following command excludes all records with an “h” or “H” in column 3:

```
EXCLUDE ALL H 3
```

You can control whether the excluded records are completely hidden or are represented by shadow lines.

- To hide the shadow line for excluded records, enter `SHADOW X OFF` on the Command line. The shadow lines disappear, and `SHAD` appears at the top left of the screen, indicating that there are records that are hidden because shadow lines have been turned off.

You can also hide the shadow line for excluded records by deselecting the **See shadow lines** option, **Excluded**, on the relevant Editor Options panel.

- To turn on shadow lines for excluded records, enter `SHADOW X ON` on the Command line.

You can also turn on shadow lines for excluded records by selecting the **See shadow lines** option, **Excluded**, on the relevant Editor Options panel.

EXCLUDE commands are cumulative; each successive EXCLUDE command increases the number of records already excluded.

To “unexclude” (redisplay) excluded records:

- Enter `RESET EXCLUDED` on the Command line.

After you have excluded records, you can limit the effects of the FIND, FE, SHADOW and SORT commands to only those records that are excluded or only those that are not-excluded. You do this by including one of the following option parameters with the primary command:

X or EX

Affects only excluded records

NX

Affects only not-excluded records

For example, the following command finds all occurrences of the string “no”, “No”, “NO”, or “nO” in all not-excluded records:

```
FIND NO ALL NX
```

**Note:**

1. If neither parameter is used with the primary command, both excluded and not-excluded records are affected.
2. If an excluded record is affected by a primary command, either by using the EX parameter or by not specifying an EXCLUDE parameter, the record becomes not-excluded.

Related topics

[EXCLUDE/XX primary command on page 1148](#)

[RESET primary command on page 1208](#)

Handling long strings in EXCLUDE

You can use the EXCLUDE command to specify a string that is up to 100 characters long. However, when you are dealing with long strings, you might find that you cannot fit the whole EXCLUDE command (including other parameters) on the Command line. To overcome this problem, do one of the following to display an Extended Command Entry pop-up panel (see [Figure 42: Extended Command Entry pop-up panel for the EXCLUDE command on page 131](#)):

- Enter `xx` (for Exclude Extended)
- Enter the EXCLUDE primary command (or one of its abbreviations, such as X) *with no parameters*.

The Extended Command Entry pop-up panel contains five lines (each 50 characters long) that you use to enter all the EXCLUDE command parameters (but not the actual keyword EXCLUDE or any of its abbreviations). File Manager treats the five lines on the pop-up panel as contiguous, allowing you to specify a long search string and any other parameters, using up to 250 characters in total.



Note: You can continue a string (or any other parameter) from the last position on one line of the pop-up panel to the first position of the next line. However, this does not mean that you need to completely fill a line before using the next line. For example, you can specify the search string on the first of the five lines and the other parameters on the next line. If you are not specifying a quoted string and you do not use all of a line, File Manager treats the unused part of the line as a single space. When you specify a string with quotation marks, any trailing blanks and any leading blanks in the next line are retained.

[Figure 42: Extended Command Entry pop-up panel for the EXCLUDE command on page 131](#) shows the Extended Command Entry pop-up panel for the EXCLUDE command. This example searches for all occurrences of the string “dichlorodiphenyltrichloroethane” in field #3.

Figure 42. Extended Command Entry pop-up panel for the EXCLUDE command

```

Process  Options  Help
-----
Edit      USERID.FMDATA(NEWDATA1)          Rec 0 of 40
                                         Format TABL

----- Extended Command Entry -----
Complete typing the EXCLUDE command and press Enter.
0  EXCLUDE ==> dichlorodiphenyltrichloroethane
0  ==> all #3
0  ==>
0  ==>
0  ==>
0  ==>
0  F1=Help   F2=Split  F3=Exit   F9=Swap   F12=Cancel
0
000009 000140 ammonium hydroxide solution
000010 000150 dichlorodiphenyltrichloroethane
000011 **** End of data ****

Command ==> fx                               Scroll 0001
F1=Help   F2=Zoom   F3=Exit   F4=CRetriev F5=RFind   F6=RChange
F7=Up     F8=Down   F9=Swap   F10=Left   F11=Right  F12=Cancel

```

Related topics

[Handling long strings in CHANGE on page 152](#)

[Handling long strings in FIND on page 127](#)

[EXCLUDE/XX primary command on page 1148](#)

Using Date/Time fields

A Date/Time field holds a date, or a time, or both (the date followed by time). Such fields are called “*date and time*” fields, even though a particular instance might contain only the date or only the time.

Defining a date and time field

Define a date and time field by using the DT prefix command during template edit. See [Defining and changing date and time attributes on page 231](#), and [Date/Time Attributes panel on page 830](#).

Formatting and updating date and time fields

Use the editor to display and change date and time fields as determined by the output format. You can also print the fields according to the output format.

When you insert new lines, the date and time fields initialize to the current date and time value.

Creating data for date and time fields

You can use the base date value as well as the day, month and year adjustment fields to populate date and time fields during a data create function. See [Setting the Data Create Attributes in your template on page 333](#) and [Date/Time Attributes panel on page 830](#).

Incrementing date and time fields

Use the copy function with the same input and output template that has date and time fields defined with a day, month and year (or day, or month, or year) adjustment values to increment or decrement the corresponding value on the output data set. See [Date/Time Attributes panel on page 830](#).

Scrambling date and time fields

Use the copy function with the same input and output template that has date and time fields defined with scrambling start and end values specified to scramble date and time values to a random or repeatable value within a given range for that field. See [Date/Time Attributes panel on page 830](#).

Working with File Manager and shared files

This section describes how to work with VSAM files in a shared environment. This may be as a result of using:

- The File Manager for CICS® feature, or
- The File Manager Base component and accessing a VSAM SHAREOPTIONS 3 or SHAREOPTIONS 4 KSDS file, or another type of VSAM SHAREOPTIONS 3 or SHAREOPTIONS 4 file that could not be allocated exclusively to the user or region accessing it.



Note: The use of VSAM SHAREOPTIONS 3 files for multiple users where the file may be updated is not recommended as VSAM offers no methods for data integrity for SHAREOPTION 3 files. For this reason, results with such files may be considered unpredictable.

Overview of shared file features

File Manager allows you to work with files that are used in a shared environment.

Features include:

- Ensuring that an update you are about to commit to does not overwrite another user's update (Edit only). This is referred to as *record integrity checking*.
- Ability to refresh the contents of an individual record at any time.
- Refreshing a record before displaying it in SNGL display format.
- Saving an individual record, or range of records, while remaining in the current Edit session.
- Performing periodic SAVES of a file after a specified number of changes (Edit only).
- While processing a CHANGE command with the ALL operand, performing periodic SAVES of a file.
- Retrying the CHANGE process for a record that, when being SAVED, has been updated by another user.

Each of the above features is described later in this section.

What File Manager considers a shared file

For most of the commands discussed in this section, record integrity checking is only active when File Manager considers itself to be operating on a file in a *shared environment*.

A shared environment exists when File Manager is operating on:

- A CICS® VSAM file (when you are using the FM/CICS feature), or
- A KSDS VSAM file that is defined with SHAREOPTIONS 3 or 4, or
- A non-KSDS VSAM file that could not be allocated to the region with a DISP of OLD (meaning that exclusive access to the file is not currently available) *and* the VSAM file is defined with SHAREOPTIONS 3 or 4.

Record integrity checking

When File Manager is operating in a shared environment, it enables record integrity checking. This means that, before rewriting the contents of a record to a file, File Manager first checks if the record has been updated (by another user) since the record was retrieved. File Manager performs this check by comparing the contents of the record at the time that it retrieved it with the contents of the current record as it exists on the file.

With a heavily shared file it is possible that, between the time the record was first fetched from the file and the time that you issued a SAVE command (or a save was automatically issued due to the value of the **Autosave frequency** option, see [Saving a file after a given number of updates \(Autosave frequency option\) on page 139](#)), another user updated the same record that you are trying to update.

Saving of records for a file occurs when:

- You issue a SAVE primary command (applies to all records in the file).
- You issue an SV or SVV prefix command (applies to specific records in the file).
- You issue an SV primary command while in SNGL display format (applies to the specific record being viewed).
- The value of the **AUTOSAVE frequency** option triggers a file-wide SAVE.
- The value of the **CHANGE ALL autosave frequency** option triggers a file-wide SAVE during the CHANGE command process.

When File Manager detects that a record has been changed by another user, it is called an *integrity check*.

File Manager recognizes three variations of integrity check:

- You are attempting to update a record but, in the meantime, the record content has been deleted by another user.
- You are attempting to delete a record but, in the meantime, another user has updated it.
- You are attempting to update a record but, in the meantime, the record content has been updated by another user.

In each of the saving scenarios mentioned previously, when an integrity check occurs, File Manager displays one of the integrity check panels shown on the following pages (according to the three variations listed above).



Note: In the case of the saving scenario where the value of the **CHANGE ALL autosave frequency** option (see [CHANGE ALL, automatic saving and retry on page 140](#)) has triggered a file-wide SAVE during the CHANGE command process, File Manager only displays an integrity check panel if the **Auto retry for CHANGE ALL** option (see [CHANGE ALL, automatic saving and retry on page 140](#)) is set to OFF.

Figure 43. Integrity check variation 1: (Update attempted but record updated by another user)

```

File Manager                Record Updated by other user
Command ==>>>                Scroll CSR
                                Format CHAR

Between the time the record was retrieved and the time a save was issued,
another user has updated the record that you are attempting to update. The
records are shown below and changes highlighted.

Enter  SAVE   to save this record anyway.
Enter  CONTINUE Save anyway and don't ask again for other records.
Enter  CANCEL to skip this update.
Enter  ABORT  to skip this update and halt performing other updates.

Col 1
Offset      Pending record contents:                Record contents as on file:
<-----+-----1-----+-----2-----+-----3--> <-----+-----1-----+-----2-----+-----3-->
000000 00000001A This is my change AAAAAA | 00000001AAAAAAA meanwhile, user 2
000034 AAAAAAAAAAAAAAAAAAAAAAAAAAAAAAAAAA | updated this record AAAAAAAAAAAA
000068 AAAAAAAAAAAA | AAAAAAAAAAAA
    
```

Figure 44. Integrity check variation 2: (Update attempted but record deleted by another user)

```

File Manager                Record Deleted by other user
Command ==>>>                Scroll CSR
                                Format CHAR

Between the time the record was retrieved and the time a save was issued,
another user has deleted the record that you are attempting to update. The
record you are updating is shown below.

Enter  SAVE   to save this record anyway.
Enter  CONTINUE Save anyway and don't ask again for other records.
Enter  CANCEL to skip this update.
Enter  ABORT  to skip this update and halt performing other updates.

Col 1
Offset      Pending record contents:                Record deleted
<-----+-----1-----+-----2-----+-----3-->
000000 00000001A Making a change to a rec |
000034 ord that someone else deleted AAAA |
000068 AAAAAAAAAAAA |
    
```

Figure 45. Integrity check variation 3: (Delete attempted but record updated by another user)

```

File Manager          Record Updated by other user
Command ==>>>
                                Scroll CSR
                                Format CHAR

Between the time the record was retrieved and the time a save was issued,
another user has updated the record that you are attempting to delete. The
records are shown below and changes highlighted.

Enter  SAVE   to save this record anyway.
Enter  CONTINUE Save anyway and don't ask again for other records.
Enter  CANCEL to skip this update.
Enter  ABORT  to skip this update and halt performing other updates.

Col 1
Offset
-----+-----1-----+-----2-----+-----3-->
000000 00000001AAAAAAAAAAAAAAAAAAAAAAAAAAAAAA | 00000001AAA Another user happily u
000034 AAAAAAAAAAAAAAAAAAAAAAAAAAAAAAAAAAAAAA | pdates the record AAAAAAAAAAAAAAA
000068 AAAAAAAAAAAAA                               | AAAAAAAAAAAAAA

```

In each integrity check panel, you have four options that are selectable by tabbing to the keyword and pressing Enter. The options are:

SAVE

Ignores the other update and applies your update. Use this option when you are sure that the record should be set the way you have indicated (or deleted).

CONTINUE

Ignores the other update and applies your update. Use this when you are sure that the record should be set the way you have indicated (or deleted). By using CONTINUE, you are instructing File Manager to also automatically SAVE any further records which encounter an integrity check.

Cancel this individual update (PF12 or CANCEL command)

Ignores your update to an individual record element. If you are changing a record, this leaves your changes in your session and marks the record element as having an integrity check.

Abort this and any following updates (ABORT command)

Operates like the Cancel option, but halts the process of the current command so that you can correct or inspect an individual condition. For instance, if integrity checks occur during the End process of an Edit session, and an integrity check panel is displayed, entering ABORT stops the saving process and re-enters the Edit to allow you to inspect records before ending your session again.

Related topics

[SAVE primary command on page 1215](#)

[SV primary command on page 1229](#)

Marking of records that had an integrity check

When an integrity check occurs, such as when you are updating a record but in the meantime another user has updated the same record (the third integrity check variation described in the previous section) then, assuming you CANCELED or ABORTed your change, File Manager marks the record element that caused this situation as having an integrity check.

In multi-line display formats (CHAR, HEX, LHEX, TABL), File Manager places an indicator (=ICHK>) in the prefix area as shown in [Figure 46: Example: display of integrity check in TABL display format on page 136](#).

Figure 46. Example: display of integrity check in TABL display format

```

Process  Options  Help
-----
Edit      FI:FMNKSBI DS:FMN.RFM0201.KSDS  Rec 0
Command ==> _____ Scroll CSR
                                Type KSDS  Format TABL
Refresh on save N
FIRSTPART LASTTWO TEXTFIELDMAIN
#4 #5 #6
ZD 1:6 ZD 7:2 AN 9:42
<---+> <-> <---+---1---+---2---+---3---+---4-> <---+---1
***** **** Top of data ****
=ICHK> 0 1 A updated record AAAAAAAAAA
000002 0 2 AAAAAAAAAAAxAAAAAAAAbAAAAAAAAAAAAAAAAA AAAAAAAAAA
000003 0 3 AAAAAAAAAAAAAAAAAAAcAAAAAAAAAAAAAAAAA AAAAAAAAAA
000004 0 4 AAAAAAAAAAAAAAAAAAAAAAAAAAAAAAAAAA AAAAAAAAAA
000005 0 5 AAAAAAAAAAAAAAAAAAAeAAAAAAAAAAAAAAAAA AAAAAAAAAA
000006 0 6 AAAAAAAAAAAAAAAAAAAfAAAAAAAAAAAAAAAAA AAAAAAAAAA
000007 0 7 AAAAAAAAAAAAAAAAAAAgAAAAAAAAAAAAAAAAA AAAAAAAAAA
000008 0 8 AAAAAAAAAAAAAAAAAAAhAAAAAAAAAAAAAAAAA AAAAAAAAAA
000009 0 9 AAAAAxAAAAAAAAAAAAAAAAiAAAAAAAAAAAAAAAAA AAAAAAAAAA
- - - - - 1 Line(s) not selected
- - - - - REC-TYPE2 - - - - - 89 Line(s) suppressed
000100 1 0 AAA*** updateok & reversed ***AAAAAAAAA AAAAAAAAAA
F1=Help F2=Zoom F3=Exit F4=CRetriev F5=RFind F6=RChange
F7=Up F8=Down F10=Left F11=Right F12=Cancel
    
```

In the SNGL display format, File Manager displays a message line as shown in [Figure 47: Example: display of integrity check in SNGL display format on page 136](#).

Figure 47. Example: display of integrity check in SNGL display format

```

Process  Options  Help
-----
Edit      FI:FMNKSBI DS:FMN.RFM0201.KSDS  Rec 1
Command ==> _____ Scroll CSR
                                Type KSDS  Format SNGL
The record had been updated by another user. Enter R Top Line is 1 of 5
Current 01: REC-TYPE1
Field      Data
FIRSTPART  0
LASTTWO    1
TEXTFIELDMAIN A updated record
TEXTMINOR1  AAAAAAAAAAAAAA
TEXTMINOR2  AAAAAxAAAAAAAA
*** End of record ***

F1=Help F2=Zoom F3=Exit F4=CRetriev F5=RFind F6=RChange
F7=Up F8=Down F10=Previous F11=Next F12=Cancel
    
```

"=MSG>" and "=PROF>" indicators

In order to more effectively describe what has occurred in certain scenarios, File Manager displays an informational message line. If a prefix is being displayed, an indicator ("=MSG>" or, if you have used the PROFILE primary command, "=PROF>") is shown in the prefix area. The line is not displayed in SNGL or ZOOM display format.

File Manager displays an informational message line when:

Figure 49.

```

Process  Options  Help
-----  -
Edit      FI:FMNKS B1 DS:FMN.RFM0201.KSDS  Re      RF done
Command ==> _____ Type KSDS      Scroll CSR
                                     Top Line is 1  Format SNGL

Current 01: REC-TYPE1
Field      Data
FIRSTPART  0
LASTTWO    1
TEXTFIELDMAIN  A updated record
TEXTMINOR1  AAAAAAAAAAAAAAAA
TEXTMINOR2  AAAAAAAAAAAAAAAA
*** End of record ***

F1=Help    F2=Zoom    F3=Exit    F4=CRetriev F5=RFind    F6=RChange
F7=Up      F8=Down    F10=Previous F11=Next    F12=Cancel
    
```

When you are using multi-line display formats (CHAR, HEX, LHEX, TABL), you can refresh the contents of a record with either the RF or RFF primary command, or the RF prefix command.



Note: If you do have any pending changes for a record, when you refresh the record those changes are discarded without further warning. This can be useful however if, for example, you want to undo your changes to a specific record, or refresh its contents when an integrity check has occurred when attempting to save your change.

Related topics

[RF primary command on page 1210](#)

Refresh of a record in SNGL display format

In SNGL display format, the record is refreshed whenever you navigate to it. That means that the record is read just before being displayed so that you are seeing the most recent version of the record (that it is possible for File Manager to display).

For example, if you use the NEXT command (PF11) followed by the PREVIOUS command (PF10), then you will see any updates made by another user to the original record you were viewing. (This is only true if you do not have any pending changes for the record.)

Related topics

[NEXT primary command on page 1191](#)

[PREVIOUS primary command on page 1198](#)

Saving individual records

File Manager provides commands to save individual records. In multi-line display formats (CHAR, HEX, LHEX, TABL), use the SV or SVV primary command or the SV prefix command. In SNGL display format, use the SV primary command to save the contents of the record currently being displayed.

Related topics

[SV primary command on page 1229](#)

Saving a file after a given number of updates (Autosave frequency option)

File Manager can perform periodic file-wide SAVES for shared files. The period or frequency of the SAVE is controlled by the value of the **Autosave frequency** option in the VSAM Edit Sharing Options panel as shown in [Figure 50: VSAM Edit Sharing Options panel on page 139](#).

Figure 50. VSAM Edit Sharing Options panel

Process	Options	Help
File Manager	VSAM Edit Sharing Options	
These options apply only when editing VSAM files that are being shared.		
Autosave frequency	_____	
Options for the CHANGE ALL command		
SAVE before starting	___	Enter ON or OFF.
Change all autosave frequency	_____	
Auto retry for change all	___	Enter ON or OFF.
Command ==>		
F1=Help	F2=Split	F3=Exit
F9=Swap	F10=Actions	F12=Cancel
	F4=CRetriev	F7=Backward
		F8=Forward

You can access the VSAM Edit Sharing Options panel by the Options pull-down menu, or by means of the menu options.

You can also disable or enable the **Autosave frequency** option, or specify a frequency value, by using the AUTOSAVE primary command.

What counts as an update?

For the purposes of the **Autosave frequency** option, the following are counted as *one* update:

Overtyping the contents of a record

Changing the contents of a record by overtyping, regardless of the number of characters changed, is counted as a single change. If you press Enter and then overtype your changed record again, this is counted as a second change.

Using a prefix command that alters record data

A prefix command that alters data, such as ">" (the command for shift right), is counted as a single change. Use of a prefix command is counted as only one change, even if the command is used to alter multiple records.

The CHANGE or RCHANGE primary command

When you issue the CHANGE or RCHANGE primary command without the ALL operand, the command counts as one change for each record it actually changes.

Related topics

[CHANGE/CX primary command on page 1129](#)

[RCHANGE primary command on page 1201](#)

CHANGE ALL, automatic saving and retry

On the VSAM Edit Sharing Options panel, there are three options that relate specifically to the CHANGE command when used with the ALL operand:

- **SAVE before starting**
- **Change all autosave frequency**
- **Auto retry for CHANGE ALL**

In a similar way to the **Autosave frequency** option, these options allow the change process to count the number of changes made and perform a periodic SAVE of the file being changed. In addition, the **Auto retry for CHANGE ALL** option is useful for retrying changes to records which encountered an integrity check at the time of the automatic save during the CHANGE command process.

When you select the **CHANGE ALL autosave frequency** option, it is highly recommended that you specify a frequency and also select the **Auto retry for CHANGE ALL** option in order to gain the most benefit from these two features.

For the **CHANGE ALL autosave frequency** option, changes are counted for each record that is changed.

You can also change the setting of the **CHANGE ALL autosave frequency** option and the **Auto retry for CHANGE ALL** option with the CHGASAVE and AUTORTRY primary commands respectively.

When you use these options, be aware that:

- Other changes (such as overtyped records), made before the start of the CHANGE ALL command, are saved either before the CHANGE command commences processing if the **SAVE before starting** option is ON, or at the time of the first automatic save at the CHANGE ALL autosave frequency if the **SAVE before starting** option is OFF.
- Any changes outstanding at the completion of the CHANGE ALL command are saved, regardless of the current change count.
- All records are refreshed at the completion of the CHANGE ALL command.

Related topics

[CHANGE/CX primary command on page 1129](#)

[CHGASAVE primary command on page 1137](#)

[AUTORTRY primary command on page 1121](#)

Editing techniques

When you attempt to edit a data set, File Manager examines your editing options, data set type and size, and uses one of three main variations of editing technique. Although these techniques should be virtually transparent to you, they are explained here.

The type of edit taking place is visible during the editor session by a denotation in the top left of the editor panel title line:

Edit

Denotes a full edit (that is, including the ability to insert and delete records, and the ability to copy and move records).

See:

- [In-memory edit on page 142](#)
- [KSDS edit on page 144](#)

Aux Edit

Denotes a full edit (that is, including the ability to insert and delete records, and the ability to copy and move records) where File Manager is making use of a secondary file to enable the edit.

See:

- [Auxiliary edit on page 143](#)

Inplace Edit

Denotes that records may only be updated in place, and that the ability to insert or delete records is not available.

See:

- [In-place-in-memory edit on page 142](#)
- [In-place edit on page 142](#)

If you do not need to insert or delete records, you can improve the performance of the Edit session (especially when working with large files) by selecting the **Inplace edit** option. This avoids the associated delays of copying to and from an auxiliary file.



Note: Unless the text in other sections of this chapter explicitly refers to one of these editing techniques, the information in this chapter applies to all editing techniques. Differences between In-memory, Auxiliary, and In-place editing are highlighted where applicable.

The following sections describe the different editing techniques.

In-place-in-memory edit

This type of In-place edit keeps as many of the records of the data set in virtual storage as will comfortably fit (or as many as specified by a record limit). The data set is updated from these records kept in storage when you enter a SAVE, END, or FILE command.

When File Manager uses this editing technique, it displays "Inplace Edit" in the top left of the editor panel title line.

File Manager uses this type of edit under one of these conditions:

- You have selected **Inplace edit** and the data set being edited is small enough to be loaded entirely into memory.
- You have specified a record limit of "MEMORY".
- You have selected **Record Sampling**.

In-place edit

This type of In-place edit only keeps records in storage that are currently displayed or that have been modified. The data records are replaced in the data set from the modified records kept in storage when you enter a SAVE, END, or FILE command.

When File Manager uses this editing technique, it displays "Inplace Edit" in the top left of the editor panel title line.

File Manager uses this type of edit when you have selected **Inplace edit** and the data set being edited is too large to be loaded entirely into memory.

The distinctive thing about both In-place edits, as the name is intended to convey, is that records may only be updated in place. Inserts, deletes, and record length changes are not possible. Note that for VSAM RRDS in In-place mode, the delete and insert commands have a slightly different meaning than normal, in that slots may be marked as empty by the delete command and made active again by the insert command.

Related topics

[Editing large files on page 144](#)

In-memory edit

With this type of edit, File Manager first tests the available TSO region size and, if the region is large enough, reads the entire data set into memory before displaying the first screen of data. This may cause a noticeable delay whilst loading, but subsequent operations are quicker. As with any usage of large amounts of TSO region, a large File Manager editor region can also have a noticeable effect on other address spaces or cause excessive paging.

When File Manager uses this editing technique, it displays "Edit" in the top left of the editor panel title line.

The data set is completely rewritten from the records kept in storage when you enter a SAVE, FILE, or END command.

File Manager uses In-memory edit when:

- You have *not* selected **Inplace edit**, and
- The data set is a QSAM data set (this may be a member of a PDS or PDSE) or a VSAM REUSE data set, and
- You have not specified a starting point or record limit, and
- The entire data set is small enough to fit comfortably within the available TSO region

Auxiliary edit

Auxiliary edit copies the original data set to a secondary data set. Only records currently being displayed or that have been modified (by change, delete, insert) are kept in storage. File Manager recreates the original data set from the secondary data set and the In-memory changes when you enter a FILE or END command. The SAVE command is not supported when editing a data set using this method. You must end the editor session and re-edit the data set.

When File Manager uses this editing technique, it displays "Aux Edit" in the top left of the Edit panel title line.

File Manager uses Auxiliary edit when you have *not* selected **Inplace edit**, or you selected to edit an HFS file, or you selected to edit an SMS-compressed data set, and:

- There is insufficient TSO region for In-memory edit, or
- You have specified a starting position or record limit

The auxiliary data set created by File Manager uses your TSO ID as the prefix High Level Qualifier. Your site may have its own standards and naming conventions for these data sets which result in the assignment of different storage categories (for example, classes, units, or privileges).

Your FMN Administrator can change this default in the customization and installation process. To override this default:

1. From the Primary Options menu, select option 0.8 to display the Set Temporary Data Set Allocation Options panel.
2. Enter a name pattern in the **High Level Qualifier** field. The pattern can be any multi-level qualifier, up to 24 bytes, and can include the following symbols:

&USER

Represents User ID

&PREFIX

Represents TSO prefix

Multi-level qualifiers that include symbols follow the same rules as used in JCL procedures for data set names with symbolic parameters. For example, assuming &USER=XXXX and &PREFIX=YYYY, the following HLQs could be set:

`&USER.1.TEMP.&PREFIX` becomes XXXXI.TEMP.YYYY

`FMN.&USER..ABCO` becomes FMN.XXXX.ABCO

The temporary HLQ serves as a user-created prefix for data sets created by File Manager. These data sets have fixed names which can vary in length. The maximum system limit for a fully-resolved data set name (that is, the HLQ and

the fixed name) is 44 bytes. If the combination of the HLQ and the fixed name resolve to more than 44 bytes, the least important part of the HLQ (the rightmost level) is ignored.

Each level can only be 8 bytes long. If a construction such as &USER.ABCD resolves to more than 8 bytes, the rightmost part of the string is ignored.

3. If your site uses the Storage Management System (SMS), enter values in the **Data class**, **Storage class**, and **Management class** fields.
4. Press F3 to save the settings and exit from the panel.

Related topics

[Editing large files on page 144](#)

[Editor Options panel on page 868](#)



Note: In Auxiliary edit, updates using the block DD line command and the CHANGE ALL primary command are retained in memory and the commands limited to the storage available. If a “*short on storage*” condition occurs while processing these commands, the Storage Shortage Warning panel is displayed.

KSDS edit

A VSAM KSDS file has the ability to insert and delete records without requiring them to be in sequence (as they are sequenced by VSAM in their key order). Hence applications intending to add, change, or remove records (such as File Manager) do not need to keep the entire file contents available (in order to rewrite the entire file) when saving changes. For KSDS files, File Manager only keeps new, changed, or deleted records in storage, as well as those currently being displayed. This is why File Manager can edit a KSDS file of any size without needing to employ the auxiliary edit technique described earlier.

When File Manager uses this editing technique, it displays "Edit" in the top left of the editor panel title line.

Editing large files

Using Auxiliary edit or In-place edit, you can edit large files, regardless of their size, without the need to first break them up into smaller subsets.

If you do *not* select **Inplace edit** on the editor entry panel and perform either of these actions:

- You attempt to edit a QSAM data set or a VSAM ESDS or RRDS data set defined with the REUSE attribute but it is too large to fit into available memory,
- You attempt to edit a QSAM data set or a VSAM ESDS or RRDS data set defined with the REUSE attribute, and you specify a start position or record limit

File Manager uses an auxiliary file in order to fulfill your request and issues progress messages periodically during the pre and post edit copy process.

Editing load modules

You can edit load modules located in a PDS using File Manager. The edit method defaults to in-place so you cannot delete or insert records.

You cannot edit load modules located in a PDSE using File Manager.



Note: Special authority may be required for this function, depending on the installation options. For more information, see the *File Manager for z/OS Customization Guide*.

Changing data

When editing a data set, you can change the data:

- In individual records by overtyping the data within the record or by entering a prefix command in the prefix area next to each row. This method is useful when you need to make ad hoc changes to specific records.
- In multiple records by entering primary commands on the Command line. This method is useful when you need to apply global changes or changes to groups of records that have a common denominator.

The effects of these changes can be limited by using command parameters or by applying limiting methods (see [Limiting the effect of editing changes on page 154](#)).

Changing data in individual records

To change the data in an individual record:

1. Move your cursor to the position where you want to start editing the text.

This can be done with your mouse or arrow keys or by using the LOCATE or FIND commands.

2. Overtyping the existing text with your changes or insert or delete characters.
3. When you change a *numeric* field by overtyping the existing contents, File Manager performs the following steps to determine the new value of the field:
 - a. Scans the contents of the field from left to right.
 - b. Ignores leading blanks
 - c. Uses the numeric digits present in the field up to either the end of the field, or up to the first embedded blank.
 - d. Ignores any characters to the right of an embedded blank.

For example, File Manager treats the following 8-character numeric field as having the value, 30,123:

```
| | | 3 | 0 | 1 | 2 | 3 |
```

but treats the following 8-character numeric field as having the value, 30:

```
| | 3 | 0 | | 1 | 2 | 3 |
```

4. Press Enter (or any function key except Help (F1) or Cancel (F12)).

Your changes are saved in memory but not written to the file, and the changed record becomes highlighted. You can change more than one record at a time before entering the changes. Your accumulated record changes are only written to file when you issue a SAVE, FILE, END or EXIT command.



Note: For a field defined to contain date or time values, you can clear field, type in the equals (=) character, and press ENTER to have File Manager store the current date or time in the field.

Change data in multiple records

When you are *editing* data, you can change data in multiple records, by entering a primary command. Here are the commands, listed in functional groups:

Action

Command

Limit the column range affected by the CHANGE, EXCLUDE and FIND commands.

[BOUNDS primary command on page 1123](#)

Find and replace a character string (or a numeric value in a numeric field)

[CHANGE/CX primary command on page 1129](#)

Change data in error

[CE \(Change Error\) primary command on page 1126](#)

Split or join records

[JOIN primary command on page 1176](#)

[SPLT primary command on page 1227](#)

[SPLTJOIN primary command on page 1228](#)

Save your edited data or cancel without saving

[CANCEL primary command on page 1124](#)

[SAVE primary command on page 1215](#)

[FILE primary command on page 1157](#)

Control the display of the prefix area

[PREFIX primary command on page 1197](#)

Cancel pending prefix commands, remove record labels, display excluded records, and remove highlighting from found strings.

[RESET primary command on page 1208](#)

Exclude certain records from display

[EXCLUDE/XX primary command on page 1148](#)

Delete data, and recover deleted data[DELETE \(records\) primary command on page 1144](#)[Recovering deleted records on page 163](#)**Copy data within the same record**[COPY primary command on page 1138](#)**Limit the columns to be edited**[Setting bounds on page 154](#)**Translate data to uppercase**[Changing the case of data on page 147](#)[Changing the case of data on page 147](#)

Differences between primary commands when editing and viewing

These primary commands, available in both View and Edit, have the following additional features in Edit:

CANCEL, END and QUIT

In View, CANCEL, END and QUIT are synonymous. In Edit, END automatically saves changes before ending the editor session, while CANCEL and QUIT end the editor session without saving changes; if you have made any changes, File Manager displays a message box asking you to confirm that you want to discard those changes.

Locating labeled records

You can use LOCATE to move to a record to which a particular label has been assigned. For example, to move to the record labeled ".HERE", enter the following command:

```
LOCATE .HERE
```

For more information about creating and using labels, see [Labelling record ranges on page 159](#). For more information about using the LOCATE command, see [Finding specific data on page 125](#).

Changing the case of data

You can translate data to uppercase on input, or you can change the case of existing data to upper or lowercase.

The **CAPS initially ON - translate changed data to uppercase (CAPS)** option on the relevant Editor Options panel determines the initial setting of the "convert to uppercase" feature. Select this option if you normally want data entered in input fields converted into uppercase. Do not select this option if you want to enter lowercase or mixed-case data. This option also affects the processing of CHANGE arguments.

The CAPS and CASE primary commands control whether data in the data area is translated to uppercase on input (CAPS, CAPS ON or CASE UPPER), or left alone (CASE, CASE MIXED or CAPS OFF. As already mentioned, the initial setting of the "convert to uppercase" feature at the start of an editor session is determined by whether the **CAPS initially ON - translate changed data to uppercase (CAPS)** option on the Editor Options panel is selected or not.

The CASE UPPER, CAPS or CAPS ON commands are similar to the ISPF editor CAPS command. If you enter any of these commands, or the **CAPS initially ON - translate changed data to uppercase (CAPS)** option is selected (and no CAPS or CASE commands have been used in the current File Manager session):

- If you overwrite any data in a record, then:
 - In CHAR, HEX or LHEX display format, the entire record is translated to uppercase.
 - In SNGL or TABL display format, only the current field is translated to uppercase.
- The CHANGE command treats the new (replacement) string as if it were specified in all uppercase except in these case:
 - The new string is enclosed in quotation marks, prefixed by the letter C (for example, `C'New String'`)
 - The new string is specified as a hexadecimal string (for example, `X'C1C2C3'`)

If either of the above is true, then the new string is not translated to uppercase.

The CAPS OFF, CASE, and CASE MIXED commands have the same effect. If you enter any of these commands, or the **CAPS initially ON - translate changed data to uppercase (CAPS)** option is unselected (and no CAPS or CASE commands have been used in the current editor session):

- Translation to uppercase is turned off.

Any CAPS command overrides any previously entered CASE command, and any CASE command overrides any previously entered CAPS command.



Note: In the ISPF editor with CAPS ON, a line is considered changed if you type *anything* on the line (if you overwrite a space with a space, it is considered to be a change). However, in a File Manager editor session, overtyping a character with the same character is not considered a change.

You can change the case of existing data to uppercase or to lowercase, without having to input new data, by using prefix commands.



CAUTION: These prefix commands (LC, LC*n*, LCC, UC, UC*n*, UCC) affect all characters in a record, not just characters in those fields with an alphanumeric or character data type. This means that numeric data, such as binary data or packed decimal data, can be corrupted by using these commands.

To change existing data to uppercase:

1. Position your cursor in the prefix area of the record that you wish to change.
2. Type the UC or UC*n* prefix command, where *n* represents the number of records to be changed, or type UCC on the first of a block of records to be changed and UCC in the prefix area of the last record in the block.
3. Press Enter. The records are changed to uppercase.

To change existing data to lowercase:

1. Position your cursor in the prefix area of the record that you wish to change.
2. Type the LC or LC n prefix command, where n represents the number of records to be changed, or type LCC on the first of a block of records to be changed and LCC in the prefix area of the last record in the block.
3. Press Enter. The records are changed to lowercase.

Finding and replacing strings

To find and replace one or more occurrences of a character string in a data set or data set member, you can use the CHANGE primary command. In SNGL or TABL display format, you can also use the CHANGE command to find and replace a numeric value in numeric fields.



Note:

1. To find and replace long strings that do not fit on the Command line, use the CX command (see [Handling long strings in CHANGE on page 152](#)).
2. To find and replace strings in multiple data sets or data set members, use the Find/Change Utility (see [Finding and changing data in multiple PDS members on page 368](#)).
3. To find a string or numeric value without changing it, use the FIND primary command. See [FIND/FX primary command on page 1157](#).

To change character strings with the CHANGE command:

1. Display your data in the editor panel (see [Starting and ending editor sessions on page 89](#) for details).
2. If you are using a template and wish to limit the effects of the CHANGE command, apply suitable record identification or record selection criteria to select your records for processing (see [Selecting records with templates on page 284](#)).
3. If you want to prevent particular records from being affected by the CHANGE command, use commands such as BOUNDS or EX to limit the range of the CHANGE command (see [Limiting the effect of editing changes on page 154](#)).
4. On the Command Line, enter the CHANGE command, together with any desired parameters, and the search and replace strings. For example:

```
CHANGE black white
```

See [CHANGE/CX primary command on page 1129](#) for details about the syntax and parameters of the CHANGE command.

The CHANGE command highlights all occurrences of the search string or numeric value in the entire data set.

To turn off the highlighting, enter the RESET FIND command.

If the CHANGE command changes data, then File Manager places the cursor at the start of the changed data; if necessary, automatically scrolling to bring the data into view.

To change the next occurrence of the string, press the RChange function key (F6).

To find the next occurrence of the string and optionally change it, use a combination of the RFind function key (F5) and the RChange function key (F6).

To find the same string as you specified on the previous CHANGE primary command, specify an asterisk (*) as the search string.

To use the same replacement string as you specified on the previous CHANGE primary command, specify an asterisk (*) as the replacement string.

To limit the search for a string to only where it appears as a prefix in the data, specify the PREFIX parameter.

To limit the search for a string to only where it appears as a suffix in the data, specify the SUFFIX parameter.

To limit the search for a string to only where it appears as a "word" in the data, specify the WORD parameter.

To change all occurrences of the string (except those in not-selected or suppressed records), use the ALL parameter with the change command.

The CHANGE command *does not* affect not-selected or suppressed records that are hidden or represented by shadow lines. To include these records in a CHANGE command, you need to show them. For details, see [SHOW \(REC\) primary command on page 1222](#).

The CHANGE command *does* affect records that have been hidden using the EXCLUDE command, unless you have used the NX parameter. If a change affects an excluded record, it becomes not-excluded. For more information on using the EXCLUDE command or EX and NX parameters, see [Excluding records on page 158](#), [CHANGE/CX primary command on page 1129](#) or [EXCLUDE/XX primary command on page 1148](#).

If you have zoomed in on a record, then the CHANGE command affects only that record. See [Zooming in to see all of a record on page 112](#).

The CHANGE command may affect record length:

- When you use the CHANGE command in CHAR, HEX or LHEX display format:
 - For variable-length files where the edit type supports record length changes, if *string2* is longer than *string1* and there are not enough EBCDIC blank characters (X'40') at the end of the record to accommodate the difference in length, File Manager expands the record length as required.
 - For variable-length files where the edit type supports record length changes, if *string2* is shorter than *string1*, then File Manager reduces the record length as required.

Otherwise, for fixed-length files, or where the type of edit prevents record length changes:

- If *string2* is longer than *string1*, then the change only occurs if there are enough EBCDIC blank characters (X'40') at the end of the record to accommodate the difference in length. File Manager maintains the same record length by dropping blanks from the end of the record.
- If *string2* is shorter than *string1*, then File Manager maintains the same record length by padding the end of the record with blanks.
- If you use the CHANGE command in SNGL or TABL display format to change a non-numeric field, the change is the same as the above fixed-length considerations except it applies to a field rather than a record. When record length changes are possible, and the field being affected by the change overlaps the end of the underlying record, File Manager may expand the record as required to complete the change request. This only occurs when the underlying record is shorter than the record structure.

If you use the CHANGE command in SNGL or TABL display format to change a numeric field, then the length of *string1* and *string2* are not significant. For example, if field #2 is a numeric field, then the following CHANGE command is allowed, because *string1* and *string2* are interpreted as numeric values:

```
CHANGE 107 2 #2
```

For more information on changing values in numeric fields, see [Searching numeric fields on page 126](#).

- If the argument is a DBCS string, only data between a shift-out and shift-in is searched for a match. For example, a DBCS blank X'0E40400F' does not find two consecutive blanks in non-DBCS data.

The exception to this rule is in TABL or SNGL format where the field is a graphic field. Unformatted graphic fields are not treated as DBCS.

For details on limiting the columns, fields or records searched by the CHANGE command, see [Limiting the effect of editing changes on page 154](#).

Examples

- If you are *not* using a template:

```
CHANGE CAT DOG
```

When zoomed in, changes the next occurrence of "CAT" to "DOG" in the current record only. Otherwise, changes the next occurrence of "CAT" to "DOG".

```
CHANGE YELLOW ORANGE ALL
```

When zoomed in, changes all occurrences of "YELLOW" to "ORANGE" in the current record only. Otherwise, changes all occurrences of "YELLOW" to "ORANGE" in all records.

- If you *are* using a template, and the data is displayed in SNGL or TABL format:

```
CHANGE BLACK WHITE (#4 #7)
```

In TABL format, changes the next occurrence of "BLACK" to "WHITE", where "BLACK" is completely contained within either of the fields represented by field references 4 and 7. In SNGL format, changes the next occurrence of "BLACK" to "WHITE", where "BLACK" is completely contained within either of the fields represented by field references 4 and 7, in the current record only.

```
CHANGE BLACK WHITE ALL #2,#8
```

In TABL format, changes all occurrences of “BLACK” to “WHITE”, where “BLACK” is completely contained within either of the fields represented by field references 2 and 8, in all records. In SNGL format, changes all occurrences of “BLACK” to “WHITE”, where “BLACK” is completely contained within either of the fields represented by field references 2 and 8, in the current record only.

Handling long strings in CHANGE

You can use the CHANGE command to specify “from” and “to” strings up to 100 characters long. However, when you are dealing with long strings, you might find that you cannot fit the whole CHANGE command (including other parameters) on the Command line. To overcome the problem, do one of the following to display an Extended Command Entry pop-up panel (see [Figure 51: Extended Command Entry pop-up panel for the CHANGE command on page 153](#)):

- Enter `cx` (for Change Extended)
- Enter the CHANGE primary command (or one of its abbreviations, such as C) *with no parameters*.

The Extended Command Entry pop-up panel contains five lines (each 50 characters long) that you use to enter all the CHANGE command parameters (but not the actual keyword CHANGE or any of its abbreviations). File Manager treats the five lines on the pop-up panel as contiguous, allowing you to specify long “from” and “to” strings and any other parameters, using up to 250 characters in total.



Note: You can continue a string (or any other parameter) from the last position on one line of the pop-up panel to the first position of the next line. However, this does not mean that you need to completely fill a line before using the next line. For example, you can specify the “from” string on the first of the five lines, the “to” string on the next line, and the other parameters on the next line. If you are not specifying a quoted string and you do not use all of a line, File Manager treats the unused part of the line as a single space. When you specify a string with quotation marks, any trailing blanks and any leading blanks in the next line are retained.

[Figure 51: Extended Command Entry pop-up panel for the CHANGE command on page 153](#) shows the Extended Command Entry pop-up panel for the CHANGE command. In this example, all occurrences of the string “dichlorodiphenyltrichloroethane” in field #3 are to be changed to the string “trinitrophenylmethylnitramine” for non-excluded records only.

Figure 51. Extended Command Entry pop-up panel for the CHANGE command

```

Process  Options  Help
-----  -
Edit          FMN.V14R1M20.SFMNSAM1(FMNCDATA)          Rec 1 of 40
                                                Format TABL

-----  Extended Command Entry  -----
Complete typing the CHANGE command and press Enter.

0  CHANGE  ==>  dichlorodiphenyltrichloroethane
0  ==>  trinitrophenylmethylnitramine
0  ==>  all #3 nx
0  ==>
0
0
0
0
0  F1=Help  F2=Split  F3=Exit  F9=Swap  F12=Cancel

000009 000140 ammonium hydroxide solution
000010 000150 dichlorodiphenyltrichloroethane
000011 **** End of data ****

Command ==> cx          Scroll 0001
F1=Help  F2=Zoom      F3=Exit  F4=CRetriev  F5=RFind  F6=RChange
F7=Up    F8=Down      F9=Swap  F10=Left   F11=Right F12=Cancel

```

Related topics

[Handling long strings in EXCLUDE on page 130](#)

[Handling long strings in FIND on page 127](#)

[CHANGE/CX primary command on page 1129](#)

Changing invalid numeric fields in your data

To change an invalid numeric field in your data (all asterisks shown in the field display) to a specified numeric value, you can enter the CE (Change Error) primary command.

The find argument for the CE command is assumed to be a numeric field in error.

When a numeric field in error is found, it changes the field to the string specified in the CE command. The specified string must, of course, be a valid numeric value.

To change the next field in error (to the same value), either enter the CE command again, or press the RChange function key (F6).

To just *find* numeric fields flagged as being in error (without changing them), use the FE primary command.

Related topics

[CE \(Change Error\) primary command on page 1126](#)

[FE \(Find Error\) primary command on page 1154](#)

[Limiting the effect of editing changes on page 154](#)

[Editor panel on page 853](#)

Limiting the effect of editing changes

When you use prefix commands to edit data, the changes made are applied to the current record only. When you use primary commands to change data, the changes may be applied to the entire data set. While many of these commands have parameters that allow you to limit the effect of the command, there are several additional methods that you can use to limit the effect of primary commands to only those records that you want to change.

These methods are:

Limiting method	CHANGE	DELETE	EXCLUDE	FIND
Bounds Set left and right column bounds.	✓		✓	✓
Column ranges Override the bounds by specifying column numbers on the command.	✓		✓	✓
Field list¹ Use # <i>n</i> field references to specify the fields to be searched.	✓		✓	✓
Excluding records Use only excluded records, not-excluded records, or both.	✓			✓
Record ranges Use record labels to specify a record range.	✓	✓	✓	✓

Setting bounds

In CHAR, HEX and LHEX display formats, you can limit the columns that are searched by the CHANGE, EXCLUDE and FIND commands by setting left and right bounds. There are two methods of setting these bounds.

Method 1:

1. On the Command line, enter

```
BOUNDS col1 col2
```

(see [BOUNDS primary command on page 1123](#) for information about the parameters of the BOUNDS command).

1. SNGL and TABL display formats only.



Note: This method is very quick but does not give you any visual feedback as to where the boundaries lie.

Method 2:

1. In the prefix area of any record, enter `BND`.

A new row is inserted into the display, showing a left angle bracket (<) and, if previously set, a right angle bracket (>).

```
File Manager Edit USERID.FMDATA(DATA1)
      Col 1          Insert length 7996          Format CHAR
-----+-----1-----+-----2-----+-----3-----+-----4-----+-----5-----+-----6-----+-----7-
000025 02Tyrone Dallas      Developer      92 Smith Street  Belmont
BND    <                                >
000026 02Rod Turnbull      Manager      184 Alexander Dve  Swan View
```

If no bounds have previously been set, the left bracket appears in the first column of your records. If bounds have already been set, the left and right brackets appear in their pre-set columns.

2. Change the bracket positions to suit your needs, by overtyping existing brackets and typing in a left and, optionally, a right bracket.
3. Press Enter or use a function key to scroll through your data. The bounds are updated.



Note: You can display as many bounds lines as you want, which allows you to insert them at convenient locations while you are editing. When the Enter key is pressed, the most recently changed bounds line is processed to reset the boundaries. If you change more than one bounds line before pressing Enter, the lowermost of the changed bounds lines is processed.

Regardless of which method you used to set the bounds, you can reset the bounds to their default by entering the `BOUNDS` command without any parameters (equivalent to `BOUNDS 1 max_record_length`).

To remove a bounds line from the display, enter `D` in the prefix area of the line. To remove all bounds lines from the display, enter `RESET` in the Command line.



Note: Removing the bounds lines from the display does not remove the actual bounds.

Setting column ranges

By default, in `SNGL` or `TABL` display formats, if you enter the `CHANGE`, `FIND`, or `EXCLUDE` command without specifying any field references, File Manager searches all the visible fields based on the template attributes for each field.

You can override this method of searching by specifying a pair of column numbers, indicating the first and last columns to be searched when you enter the primary command.



Note: When you specify a column range, all fields in the record data are searched as if they were character fields. For numeric fields, this can cause unexpected results.

The search string is found if it is completely contained within the specified columns.

The following command finds the next record, excluded or not-excluded, containing the string "Exact" within columns 1 to 20:

```
FIND C'Exact' 1 20
```

(For an explanation of excluded and not-excluded records, see [Excluding records on page 158](#).)

The following command changes all occurrences of the string "no", "NO" or "nO" to "No" in columns 21 to 30 in all not-excluded records:

```
CHANGE NO C'No' ALL 21 30 NX
```

If the second column that you specify is larger than the record size, then the record size is used. If you specify a single column, then the character string must start in the specified column.

Specifying either a single column or a pair of columns overrides the current bounds. If you do not specify any columns then, when in CHAR, HEX or LHEX display formats, the columns to be searched default to the current bounds (see [Setting bounds on page 154](#)).

Related topics

[Finding specific data on page 125](#)

Limiting the search to specified fields

In SNGL or TABL display format, you can optionally limit the effects of primary commands to a specified field, a list of fields, or one or more ranges of fields.

You specify the fields to be searched using *#n* field references. These are displayed above each field in TABL display format, or next to each field in SNGL display format. The search string is found only if it is completely contained within one of the specified fields.

Specifying a list of fields

When you specify a list of fields, you must specify them adjacent to each other. You can optionally enclose the field references (optionally separated by commas) in parentheses.

These are valid lists of fields:

```
#17
(#17)
(#17 #22)
(#17, #22)
#17,#22
#17 #22
#17, #22
```

The search string is found if it is completely contained within one of the specified fields. For example, the following command excludes all records containing the characters “the” (in any mix of uppercase and lowercase) in field #5:

```
EXCLUDE ALL the #5
```

The following command finds the next record containing an uppercase letter A in field #8 or #9:

```
FIND C 'A' #8,#9
```

Fields that are items of a multi-dimensional array share the same field reference number, but are differentiated by the dimension, using a subscript. For example, given the following field references (shown in TABL display format):

```
(1,1)  (1,2)  (1,3)  (2,1)  (2,2)  (3,2)
#9      #9      #9      #9      #9      #9
```

You could specify the following lists of fields:

```
FIND bike #9(1,2)
FIND bike (#9(1,3) #9(2,2))
```

To search *all* items in the array, specify:

```
FIND bike #9
```

Specifying ranges of fields

You specify a range of fields by nominating the first and last field reference of the range, separated by a hyphen, with or without intervening spaces. You can optionally enclose the range in parentheses.

These are valid ranges of fields:

```
#17-#19
#17 - #19
(#17-#19)
(#17 - #19)
```

To specify more than one range of fields:

- Enclose each field range in parentheses (optionally separated by commas), or
- Separate each field range with commas.

These are valid ranges of fields:

```
(#8-#11) (#17-#19) (#24-#25)
(#8-#11), (#17-#19), (#24-#25)
#8-#11, #17-#19, #24-#25
#8-#11 #17-#19 #24-#25
#8-#11, #17-#19, #24-#25
```



Note:



1. When using field ranges, the field reference number can not be subscripted. For example, #3(2) - #5(4) is not valid syntax.
2. Field ranges can overlap. For example, #2-#7, #5-#9. In this case, the result is a consolidated single field range equivalent to #2-#9.

Excluding records

You can limit the records affected by the FIND, CHANGE and DELETE commands, first by excluding some records from display, then by limiting those commands to affecting only the not-excluded records, or only the excluded records.

To exclude individual records on an ad hoc basis, choose one of the following methods:

- Enter `x` in the prefix command area of the record to be excluded.
- Enter `xn` in the prefix command area of the first record of n records to be excluded.
- Enter `xx` in the prefix command area of the first record of a block of records to be excluded, then enter `xx` in the last record to be included in the block.

To exclude multiple records based on a common factor:

- Enter EXCLUDE with the relevant parameters on the Command line (see [EXCLUDE/XX primary command on page 1148](#)).

For example, the following command excludes all records with an “h” or “H” in column 3:

```
EXCLUDE ALL H 3
```

EXCLUDE commands are cumulative; each successive EXCLUDE command increases the number of records already excluded.

To “unexclude” (redisplay) excluded records, choose one of the following methods:

- To unexclude a single excluded record, enter `F` or `L` in the prefix command area of the excluded line.
- To unexclude the first n records in a block of excluded records, enter `Fn` in the prefix command area of the excluded line.
- To unexclude the last n records in a block of excluded records, enter `Ln` in the prefix command area of the excluded line.
- To unexclude all excluded records, enter `RESET EXCLUDED` on the Command line (see [RESET primary command on page 1208](#)).

After you have excluded records, you can limit the effects of the FIND, CHANGE and DELETE commands to only those records that are excluded or only those that are not-excluded. You do this by including one of the following option parameters with the primary command:

X or EX

Search only excluded records

NX

Search only not-excluded records

For example, the following command changes all occurrences of the string “no”, “NO” or “nO” to “No” in all not-excluded records:

```
CHANGE NO C'No' ALL NX
```

**Note:**

1. If neither parameter is used with the primary command, both excluded and not-excluded records are affected.
2. If an excluded record is affected by a primary command, either by using the EX parameter or by not specifying an EXCLUDE parameter, the record becomes not-excluded.

Labelling record ranges

In any display format except SNGL, you can limit the number of records affected by the CHANGE, DELETE, EXCLUDE and FIND commands by specifying a record range. A record range consists of a pair of record *labels* indicating the first and last records to be searched. The string is found if it is contained in a record within the specified range.

To limit editing primary commands using your own labels:

1. Enter a label in the prefix area of one data record.

A record label consists of a period (.) followed by one to four alphabetic characters (no numeric or special characters). Labels starting with “.Z” are reserved for the editor (see [Editor-assigned labels on page 160](#)).

2. Enter a label in the prefix area of a second data record.

The order in which you specify the labels is not important.

3. Enter your primary command and any parameters, followed by two labels in any order.

When you specify a record range, you must separate the two labels by a blank or comma. A single label is invalid. The labels may be any combination of the editor-assigned labels (.ZCSR, .ZFST, .ZLST) and labels you have assigned yourself.

Regardless of the order in which you specify the two labels, the label representing the smaller relative line number is used as the start of the range and the label representing the larger relative line number is used as the end of the range.

Your cursor is positioned on the first instance that occurs within the range.

**Note:**



1. When using FIND or CHANGE, all instances of your search string are highlighted, however, only those instances within the range are affected by the command or by the RFIND (F5) and RCHANGE (F6) commands.
2. Once assigned, a label stays with the record, even if the record is moved.
3. A label is removed when the record containing the label is deleted.
4. Overtyping a label with a prefix command does not remove the label. When the command is complete, the record label reappears.
5. You can move a label to another record by typing the same label on a new record.
6. If the range you specify includes not-selected or suppressed records that are hidden from display or represented by shadow lines, then those records *are not* affected by the CHANGE, DELETE, EXCLUDE or FIND command.
7. If the range you specify includes excluded records and you either use the EX parameter or do not specify an EXCLUDE parameter, the records *are* affected by the primary command. If an excluded record is affected by a primary command, the record becomes not-excluded.

In the following example, the label `.HERE` is assigned to record number 16 and the label `.THRE` is assigned to record number 129:

```

:
00015 This is a data record.
.HERE This is a data record with a label.
00017 This is a data record.
:
00128 This is a data record.
.THRE This is a data record with a label.
00130 This is a data record.
:

```

This range can now be used to limit a command:

```
CHANGE A B .HERE .THRE
```

The following command excludes all records, excluded or not-excluded, containing the string "where" in the range of records from the label `.HERE` to the label `.THRE`:

```
EXCLUDE C'where' ALL ABC .HERE .THRE
```

To remove labels from records, do one of the following:

- For a single label: overwrite the label with spaces (or a new label), then press Enter.
- For all labels: enter the RESET LABEL command.

Editor-assigned labels

Some labels are automatically assigned and maintained by the editor. These special labels begin with the letter "Z". (Your own labels, therefore, must not start with a "Z".) Unlike other labels, these editor-assigned labels do not necessarily stay with the same record, but instead represent logical positions on the display. You can use the following editor-assigned labels:

.ZCSR

To the record on which the cursor is currently positioned.

To use this label:

1. Type the command and labels on the Command line but do not press Enter.
2. Position your cursor anywhere in the record that you want to use as the current position.
3. Press Enter. All records that lie between your cursor position and the other label are included in the range, regardless of the order in the labels occur in the data set or in which you specify the labels.

.ZFST

To the first record (relative record number 1). This can be abbreviated to .ZF.

.ZLST

To the last record. This can be abbreviated to .ZL.

The following command changes the first occurrence of the string `xxx` in the range of records from the current cursor position to the end of data:

```
CHANGE xxx yyy .ZCSR .ZLST
```

The following command finds the next record, excluded or not-excluded, containing the string `xxx` in the range of records from the current cursor position to the end of data:

```
FIND xxx .ZCSR .ZLST
```

Editing records within data sets

As well as editing the data within records, you can use File Manager to edit the records within a data set and segments within records if using a segmented template. The term “*record*”, when used below, may refer to either a record or a segment within a record depending on whether a segmented template is being used.



Note: Many editing actions are performed using prefix commands. Generally, you need to type over only the first 1 or 2 characters of the line number to enter a prefix command. Sometimes, however, typing a single character can be ambiguous. In the following example, it is unclear whether the intended prefix command is R to repeat line 31700, or R3 to repeat the line three times, R31 to repeat the line 31 times or R317 to repeat the line 317 times:

```
031600
R31700
031800
```

In such cases, the editor assumes that you have not typed a number following the prefix command. If you want to repeat the line three times, you can type one or more blanks following the R3.

```
R3 700
```



Inserting records

When the display format is set to CHAR, HEX, LHEX or TABL formats, you can insert new records into the data set. You cannot insert new records when the display format is SNGL.

To insert new records in a data set:

1. Position your cursor in the prefix area of the record above which you want to insert new records.
2. Type the I or In prefix command, where *n* represents the number of records to be inserted.
3. Press Enter. If using a segmented template a popup panel is displayed with a list of layouts for you to select the layout of the new segment. The new record or records are inserted above your cursor position. Each record is initialized as follows:
 - If the display format is CHAR, HEX or LHEX, then the entire record is initialized to blanks.
 - If the display format is TABL, then the record is initialized according to the record structure of the current record type:
 - Numeric fields are initialized to zero.
 - Alphanumeric fields are initialized to blanks.
 - If the record type contains a variable-length array, then the record is initialized with the minimum number of array elements, and the array size field (or fields, for multi-dimensional arrays) is initialized accordingly.
 - Fields defined as containing date values are initialized with the current date.
 - Fields defined as containing time values are initialized with the current time.



Note: The inserted records are not saved to the file until a SAVE, FILE, END or EXIT command is issued.



Note: To insert a new record when using a segmented template use the IR command. If the IR command is entered on the 'Top of Data' line the record is inserted as the first record in the data set. Otherwise the record is inserted at the end of the record containing the segment the command was issued against.

Deleting records

You can delete records when in any display format, by using the DELETE primary command. This allows you to delete all the records in a data set or to delete multiple records based upon the following common factors:

- All excluded or not-excluded records (see [Excluding records on page 158](#)).
- All records that fall within a range specified by labels (see [Labelling record ranges on page 159](#)).
- All excluded or not-excluded records that fall within a labeled range.

To delete records that have a common factor:

1. Establish the common factor for your records, that is, create your labels and/or exclude the required records.
2. Enter the DELETE primary command, together with your choice of parameters, on the Command line.

Examples

The following command deletes all excluded records:

```
DELETE ALL EX
```

The following command deletes the next not-excluded record in the range of records from the label .LABA to the label .LABB:

```
DELETE NX .LABA .LABB
```

In CHAR, HEX, LHEX or TABL display formats, you can also delete records by using the D prefix command. Using the prefix command allows you to delete individually selected records or blocks of records that have no other common factor.

To delete individually selected records:

1. Perform either of these actions:
 - Position your cursor in the prefix area of the first record to be deleted and type the D or Dn prefix command, where n represents the number of records to be deleted.
 - Type DD in the prefix area of the first record of a block of records to be deleted and DD in the prefix area of the last record in the block.
2. Press Enter. The record or record are deleted from the data set.



Note: The deletion of these records is not saved to file until a SAVE, FILE, END or EXIT command is issued. You can recover these deleted records, before ending your editing session, by using the RECOVER primary command.

Recovering deleted records

Records that are deleted during an editor session are stored in a buffer. At any time before closing the editor panel, you can recover these deleted records.

To recover previously deleted records:

1. Enter `RECOVER n` on the Command line, where n represents the number of records to be restored, starting with the last deleted record.

Records are stored in the buffer in the order in which they were removed, so that the command `RECOVER 1` restores the last record to be deleted, `RECOVER 2` restores the last two records to be deleted, and so on. Recovered records are inserted after the first record visible at the top of the data area. If the first visible line is `***** **** Top of data ****`, the records are inserted at the beginning of the data set. Inserted records appear in the order in which they were deleted.

For example, if records 1, 5 and 7 were deleted from the data set in that order, the command `RECOVER 1` would restore record 7, but `RECOVER 3` would restore records 1, 5 and 7 in that order (not as 7, 5, 1).

Recovering a record removes it from the buffer. If you delete the recovered record, before saving the first recovery, you cannot recover it a second time. This can lead to loss of data. To prevent data loss, issue the SAVE command after each RECOVER command.



Note: When using an auxiliary edit, in order to minimize the recovery buffer usage and allow for many records to be deleted, only the ten latest deleted records are kept in the recovery buffer.

Moving records

You can rearrange the display of your records by moving them up or down in the data set. For record types other than KSDS, the new sequence of the records is stored when you save the data set. In a KSDS, moving records while editing changes the displayed position of records, but has no effect on the stored data set. For this reason, the Move prefix commands as described in the following are not available for a KSDS. If you want to change the order of records in a KSDS, you must change the key values.

To move records within a data set:

1. Position your cursor in the prefix area of the first record that you wish to move.
2. Type the M or Mn prefix command, where n represents the number of records to be moved, or type MM on the first of a block of records to be moved and MM in the prefix area of the last record in the block.
3. Press Enter. The prefix command is highlighted and the message "Prefix command pending" is displayed in the upper right corner of your screen.
4. Move your cursor to the prefix area of the record where you would like to place the moved records.
5. Type one of the following prefix commands:

A

This command inserts the moved records *after* the current location.

B

This command inserts the moved records *before* the current location.

6. Press Enter. The records are removed from their previous location and inserted at the new position.



Note: When you move records with the M, Mn , or MM prefix commands, instead of moving the data after or before other records, you can choose to *overlay* the moved records on existing records in the data set you are editing. For details, see [Overlaying data in existing records on page 165](#).

Copying and repeating records

You can create copies of records in two different ways: by copying or by repeating records. Copying allows you to place the copied records anywhere in the data set. Repeating allows you to quickly duplicate a record, immediately after the selected record.

To copy records within the data set:

1. Position your cursor in the prefix area of the first record that you wish to copy.
2. Type the C or Cn prefix command, where n represents the number of records to be copied, or type CC on the first of a block of records to be copied and CC in the prefix area of the last record in the block.
3. Press Enter. The prefix command is highlighted and the message "Prefix command pending" is displayed in the upper right corner of your screen.
4. Move your cursor to the prefix area of the record where you would like to place the copied records
5. Type one of the following prefix commands:

A

This command inserts the copied records *after* the current location.

B

This command inserts the copied records *before* the current location.

6. Press Enter. The copied records are inserted at the new position.



Note: When you copy records with the C, Cn, or CC prefix commands, instead of copying the data after or before other records, you can choose to *overlay* the copied records on existing records in the data set you are editing. For details, see [Overlaying data in existing records on page 165](#).

To repeat records:

1. Position your cursor in the prefix area of the first record that you wish to repeat.
2. Type the R or Rn prefix command, where n represents the number of records to be repeated, or type RR on the first of a block of records to be repeated and RR in the prefix area of the last record in the block.
3. Press Enter. The copied records are inserted immediately below the last record selected for repeating.

Overlaying data in existing records

When data is to be copied or moved by the C (copy) or M (move) prefix commands and overlaid on one or more existing records, the O (overlay) prefix command specifies the destination for the data.

The data that is copied or moved overlays blanks in the destination records. This allows you to rearrange a single-column list of items into multiple column, or tabular, format.

When data is to be moved or copied and then overlaid on a destination:

- Where the destination is a *single record*:
 - The O (overlay) prefix command specifies the destination for the data.

You can type a number after the O prefix command to specify the number of times that the M or C prefix command is to be performed. For example, typing the command `O3` against a record causes the data to be moved or copied and then overlaid on that record and also the next two records.

- Where the destination is a *block of records*:
 - The OO (overlay, multiple-line target) prefix command specifies the first and last record of the destination for the data.

To overlay one or more *single* records:

1. Type either `M` or `C` in the prefix area of the record that is to be moved or copied.
2. Type `O` in the prefix area of the record that the moved or copied record is to overlay.
3. Press Enter. The data being moved or copied overlays the specified record or records.

To overlay one or more *blocks* of records:

1. Type either `MM` or `CC` in the prefix area of the first and last records of a block of records that is to be moved or copied. You can scroll (or use FIND or LOCATE) between typing the first command and the second command, if necessary.
2. Type `OO` in the prefix area of the first and last records that the block of records being moved or copied is to overlay. Again, you can scroll (or use FIND or LOCATE) between typing the first `OO` and the second `OO`, if necessary.
3. Press Enter. The records that contain the two CC or MM commands and all of the records between them overlay the records that contain the two OO commands and all of the records between them.

Only blank characters in the records specified with O or OO are overlaid with characters in the corresponding columns from the source records. Characters that are not blank are not overlaid. The overlap affects only those characters within the current column boundaries.

The number of source and receiving records need not be the same. If there are more receiving records, the source records are repeated until the receiving records are gone. If there are more source records than receiving records, the extra source records are ignored. The overlay operation involves only data records. Special lines such as BNDS and COLS are ignored as either source or receiving lines.

[Figure 52: Before the O \(Overlay\) prefix command on page 167](#) illustrates the O (overlay) prefix command. Suppose you were editing a list in a single left-adjusted column and wanted to place portions of the list side-by-side. First, using the) (column shift right) command, shift a portion of the list the appropriate amount to the right to overlay in a multiple column format. Next, type `MM` in the prefix area to mark the beginning and end of the block of records you want to move, then type `OO` in the prefix area to mark the destination of the records you want to overlay.

Figure 52. Before the O (Overlay) prefix command

```

Process  Options  Help
-----
Edit      JHELVON.TEST.DATA(OLAY)      Top of 16
Col 1    Insert Length 80            Record AT TOP    Format CHAR
-----+-----10-----+-----2-----+-----3-----+-----4-----+-----5-----+-----6-----+-----7-----
*****  **** Top of data  ****
000001  $$$$$$$$$$$$$$$$$$$$$$$$$$$$$$$$$$$$$$$$$$$$$$$$$$$$$$$$$
000002
mm0003  THESE RECORDS TO BE COPIED
000004  THESE RECORDS TO BE COPIED
000005  THESE RECORDS TO BE COPIED
000006  THESE RECORDS TO BE COPIED
mm0007  THESE RECORDS TO BE COPIED
000008
oo0009                THESE RECORDS ARE THE TARGET
000010                THESE RECORDS ARE THE TARGET
000011                THESE RECORDS ARE THE TARGET
000012                THESE RECORDS ARE THE TARGET
000013                THESE RECORDS ARE THE TARGET
oo0014                THESE RECORDS ARE THE TARGET
000015  $$$$$$$$$$$$$$$$$$$$$$$$$$$$$$$$$$$$$$$$$$$$$$$$$$$$$$$$$
Command ==>
F1=Help      F2=Zoom      F3=Exit      F4=CRetriev  F5=RFind     F6=RChange
F7=Up        F8=Down      F9=Swap      F10=Left     F11=Right    F12=Cancel

```

When you press Enter, the editor overlays the records you marked to move on the destination block. See [Figure 53: After the O \(Overlay\) prefix command on page 167](#).

Figure 53. After the O (Overlay) prefix command

```

Process  Options  Help
-----
Edit      JHELVON.TEST.DATA(OLAY)      Top of 16
Col 1    Insert Length 80            Record AT TOP    Format CHAR
-----+-----10-----+-----2-----+-----3-----+-----4-----+-----5-----+-----6-----+-----7-----
*****  **** Top of data  ****
000001  $$$$$$$$$$$$$$$$$$$$$$$$$$$$$$$$$$$$$$$$$$$$$$$$$$$$$$$$$
000002
000003
000004  THESE RECORDS TO BE COPIED    THESE LINES ARE THE TARGET
000005  THESE RECORDS TO BE COPIED    THESE LINES ARE THE TARGET
000006  THESE RECORDS TO BE COPIED    THESE LINES ARE THE TARGET
000007  THESE RECORDS TO BE COPIED    THESE LINES ARE THE TARGET
000008  THESE RECORDS TO BE COPIED    THESE LINES ARE THE TARGET
000009  THESE RECORDS TO BE COPIED    THESE LINES ARE THE TARGET
000010  $$$$$$$$$$$$$$$$$$$$$$$$$$$$$$$$$$$$$$$$$$$$$$$$$$$$$$$$$
000011
*****  **** End of data  ****
Command ==>
F1=Help      F2=Zoom      F3=Exit      F4=CRetriev  F5=RFind     F6=RChange
F7=Up        F8=Down      F9=Swap      F10=Left     F11=Right    F12=Cancel

```

Related topics

[Editor panel on page 853](#)

[View panel on page 1083](#)

Copying data to and from a clipboard

In edit, the CUT and PASTE primary commands allow you to copy data to and copy data from a clipboard respectively.

Copying data to a clipboard (CUT)

Use the CUT primary command to move or copy one or more records from the current edit session into a clipboard for later retrieval by the PASTE command.

To specify the records to be put into the clipboard, use:

- Prefix commands C or CC to copy records.
- Prefix commands M or MM to move (copy, then delete) records.
- A range of line labels to copy records. For example:

```
CUT .ZF .ZL
```

If you do not specify a range, all edit session data is copied to the clipboard.

You can use the X or NX operands to copy only excluded or non-excluded data within the range to the clipboard. The default is both excluded and non-excluded data.

Suppressed and not-selected sets are not copied to the clipboard. To include the data referenced by those sets, first expose the sets by issuing the appropriate SHOW command.

To *replace* the contents of the clipboard, use the REPLACE operand. This is the default.

To *add to* the existing contents of the clipboard, use the APPEND operand.

To copy only excluded or unexcluded records to the clipboard, use the X or NX operand.

If you do not specify a clipboard name on the command, File Manager saves the data to the clipboard, DEFAULT.

When running under ISPF, clipboards created by File Manager can be accessed by ISPF. Similarly, when running File Manager, clipboards created when running under ISPF can be accessed by File Manager.

To view or edit an existing clipboard, issue the command `CUT DISPLAY` to display the Clipboard Manager panel. This panel lists all the current clipboards.

Copying data from a clipboard (PASTE)

Use the PASTE primary command to copy records from a clipboard into the current edit or view session.

If records in the clipboard are longer than the record length of the data set being edited, the records are truncated.

Use the A or B prefix commands, or AFTER or BEFORE with a label, to specify the destination of the records.

If you specified a name of a clipboard with the CUT command, you must use that name on the PASTE command to retrieve the contents of that clipboard.

To empty the clipboard after the PASTE completes, use the DELETE keyword.

To copy the records from the clipboard (instead of moving them), use the KEEP keyword.

Related topics

[CUT primary command on page 1140](#)

[PASTE primary command on page 1196](#)

[Clipboard Manager panel on page 762](#)

Copying data from another data set

The COPY primary command allows you to copy one or more lines of data from a data set or member of a partitioned data set (PDS) into the member or data set you are currently editing or viewing.

Use the A (after) or B (before) line commands, or the AFTER or BEFORE keyword with a label, to specify where the data is to be copied.

If you specify a member name as part of the COPY primary command, and you have properly specified the "after" or "before" destination, the entire member or a range of records in the member are copied in immediately.

Examples:

```
COPY memnam
```

Copies in entire contents of member *memnam*.

```
COPY (memnam) 2 10
```

Copies in lines 2 to 10 of member *memnam*.

You can specify a partially qualified or fully qualified data set name as part of the command. This can be a data set or another partitioned data set.

Examples:

```
COPY seqds
```

Copies in entire contents of sequential data set *seqds*.

```
COPY 'userid.seqds'
```

Copies in entire contents of sequential data set *userid.seqds*.

```
COPY pds(mem)
```

Copies in entire contents of member *mem* within partitioned data set *pds*.

```
COPY pds(mem) 6 10
```

Member list is displayed. Copies in lines 6 to 10 of member *mem* within partitioned data set *pds*.

If you enter the COPY command without specifying a member name or a data set name, after you have specified a destination and pressed Enter, File Manager displays the Edit/View - Copy panel.

Example:

COPY AFTER .HERE

Displays the Edit/View - Copy panel.

The Edit/View - Copy panel allows you to enter the name of a data set or PDS (and member) containing the data you want to copy. If you do not want to copy the entire contents, you can specify the numbers of the first and last records to be copied.

Related topics

[COPY primary command on page 1138](#)

[Edit/View - Copy panel on page 866](#)

Splitting and joining lines

At times, you might want to split a record in two, or join two records together. This is particularly appropriate when editing data sets that contain unstructured text (such as a REXX procedure), as in these data sets, a record represents a line of text.



Note: You cannot split or join a record when in SNGL or TABL display format, or when zoomed in on a record.

To split a record in two:

1. Type the SPLT primary command on the Command line.
2. Position your cursor on the record that you want to split, at the column position that you want to “push” to the next line.
3. Press Enter. A new record is inserted below your current record and the text from your cursor position to the end of the record is moved to the beginning of this record.

For example, when the following record is split at the cursor position (underlined character):

```
***** **** Top of data ****
000001 abcdefghijklmnopqrstuvwxyz_abcdefghijklmnopqrstuvwxyz
000002 abcdefghijklmnopqrstuvwxyzabcdefghijklmnopqrstuvwxyz
```

the result is:

```
***** **** Top of data ****
000001 abcdefghijklmnopqrstuvwxyz_
000002 abcdefghijklmnopqrstuvwxyz
000003 abcdefghijklmnopqrstuvwxyzabcdefghijklmnopqrstuvwxyz
```

When you join two records, the text from the second record is combined with the first record, overlaying the first record starting at the cursor position.

To join two records together:

1. Type the JOIN primary command on the Command line.
2. Position your cursor on the record that you want to combine with the next record, at the column position where you want the second record text to begin.

3. Press Enter. The text from the following record is combined with the current record, overlaying any existing text.

If the text in the second record does not fit into the remaining space in the first record, it spills over into a new record.

For example, when the following records (length=50) are joined at the cursor position (underlined character):

```

-----1-----2-----3-----4-----5
000000 **** Top of data ****
000001 aaaaaaaaaaaaaaaaaaaaaaaaaa_
000002 bbbbbbbbbbbbbbbbbbbbbbbbbb
000003 ccccccccccccccccccccccccccccccccccccccccccccccccccccccc
000004 **** End of data ****

```

the result is:

```

-----1-----2-----3-----4-----5
000000 **** Top of data ****
000001 aaaaaaaaaaaaaaaaaaaaaaaaaabbbbbbbbbbbbbbbbbbbbbbbbbb
000002 ccccccccccccccccccccccccccccccccccccccccccccccccccccccc
000003 **** End of data ****

```

However, if these records were joined at the same position:

```

-----1-----2-----3-----4-----5
000000 **** Top of data ****
000001 aaaaaaaaaaaaaaaaaaaaaaaaaa_aaaaaaaaaaaaaaaaaaaaaaaaaa
000002 bbbbbbbbbbbbbbbbbbbbbbbbbbcccccccccccccccccccccccccccccc
000003 ccccccccccccccccccccccccccccccccccccccccccccccccccccccc
000004 **** End of data ****

```

the result would be:

```

-----1-----2-----3-----4-----5
000000 **** Top of data ****
000001 aaaaaaaaaaaaaaaaaaaaaaaaaabbbbbbbbbbbbbbbbbbbbbbbbbb
000002 bbbbbbbbbbbbbbbbbbbbbbbbbb
000003 ccccccccccccccccccccccccccccccccccccccccccccccccccccccc
000004 **** End of data ****

```

To avoid the danger of unintentionally overlaying data in the first record, you can use the SPLTJOIN command, which can be abbreviated to SJ. This command splits or joins records depending upon the cursor position within a record. If the cursor is after the last non-blank character in a record, the command performs a join. If not, it splits the record.



Note: You may want to assign the SJ command to a function key, using the KEYS command (see the *ISPF User Guide Volume 1* for information on how to assign commands to function keys).

Changing the length of a record

For those files that support variable-length records, you can change the length of the record by displaying the record length in an edit session and then overtyping it with the required value.



Note: You cannot change the length of a record in In-place edit.

You can display the record length by any of these methods:

- Entering the zoom mode from a CHAR, HEX, or LHEX display format.
- Displaying the record in SNGL display format.
- In multi-line formats (TABL, CHAR, HEX, and LHEX), issuing the RECLLEN primary command (`RECLLEN ON`, `RECLLEN LEFT`, or `RECLLEN RIGHT`).
- Ensuring the **Display record length** option on the relevant Editor Options panel is selected.



Note: If you increase the record length, the new bytes added to the record are blanks.

Related topics

[Displaying the record length on page 114](#)

[RECLLEN primary command on page 1204](#)

[Zooming in to see all of a record on page 112](#)

[Editor Options panel on page 868](#)

[In-place edit on page 142](#)

Chapter 4. Creating and editing templates

For many tasks performed with File Manager, you can manipulate your view of a data set by applying a template.

Templates can be predefined for later use or prepared as needed within File Manager panels. You can also use templates when programming File Manager functions in batch jobs, REXX procedures, and TSO CLISTS (described in [Introduction to programming with File Manager functions on page 503](#) and [Enhancing File Manager processing on page 517](#)).

Template types and structure

A File Manager template is a collection of information that you can use to select and format records and fields in an application data set.

The template provides File Manager with a logical view of the data to be used when editing, viewing, copying, printing, and creating data sets. Templates can be based upon the definitions in COBOL copybooks, PL/I INCLUDE members, and HLASM copy members. Additionally, record structure descriptions can be extracted from complete COBOL, PL/I, or HLASM source programs. Alternatively, you can create your own record structure description in a dynamic template.

Information stored in a template

The list below describes the information that a template can contain, and where and how File Manager uses the information.

Record type selection

Determines which record types are selected or unselected.

Unselected record types are excluded when comparing, copying or printing.

When creating a data set, the records in the new data set are of the record type first selected in the template.

Record identification criteria

Determines which records belong to each record type in the template.

Records that do not belong to a record type in the template are indicated as “not selected” when viewing or editing, and are excluded when comparing, copying¹ or printing.

Record selection criteria

Determines which records, having been identified as belonging to a record type, are to be selected.

Records that do not match the record selection criteria are indicated as “not selected” when viewing or editing, and are excluded when comparing, copying¹ or printing.

Records that are not selected may not be included in the editor session, depending on the setting of the **Include only selected records** option. Furthermore, if the template describes segmented data, the record selection criteria affects the selection of the entire physical record. When this occurs, none of the segments belonging to the physical record are provided in an editor session and they are excluded when comparing, copying, or printing.

1. When copying, File Manager uses this information in the “From” template. In a “To” template, this information is ignored. However, when comparing, the selection information in both the “Old” and “New” templates (if specified) is used.

Field selection

Determines which fields are displayed (when viewing or editing) or printed. This information is ignored when comparing, copying or creating data sets.

When copying, if you want to exclude some fields in the input data set from being copied to the output data set, then you need to create a "To" copybook or dynamic template without those fields.

When comparing, if you want to exclude fields from the comparison, you need to create an "Old" and a "New" copybook or dynamic template and then remove the default field mapping for the fields to be excluded.

Field sequence

Overrides the default order in which fields are displayed (when viewing or editing) or printed. By default, fields are displayed or printed in the order in which they were defined in the copybook. This information is ignored when comparing, copying or creating data sets.

When copying, if you want to change the order of fields in the input data set and the output data set, then you need to create a "To" copybook or dynamic template with the fields in the desired order.

Key sequence

Determines the sequence of fields to be included in a multi-segment key, which can be used when performing a file comparison with keyed synchronization.

Field headings

Overrides the default field headings when viewing, editing, comparing or printing. (The default field headings are the field names defined in the copybook.)

Field attributes

The field name, data type, starting column and length, as defined in the dynamic template or in the copybook on which a template is based. These attributes are fixed in a copybook template, as they are determined by the underlying copybooks, but can be edited in a dynamic template.

If you make minor changes to field attributes in a copybook, you can (with some restrictions) update the template generated from it, while keeping all of the other existing information in the template.

Field use attributes

Consist of two attributes:

Output width

Defines the number of columns allocated to the field when viewing, editing or printing. By default, this is the width defined in the copybook by the picture specification.

If a numeric field contains a valid numeric value, but the value is too large to fit in the output width, then, when viewing or editing in SNGL or TABL display format, the value is truncated and highlighted.

Leading zeros (numeric fields only)

Defines whether or not the field value is shown with leading zeros when viewing, editing, comparing or printing.

Field create attributes

Defines the value to which the field is initialized when copying² or creating a data set.

Field mapping

Defines which fields in the “From” template map to fields in the “To” template, when copying² a data set; or which fields in the “Old” template map to fields in the “New” template, when comparing two data sets.

Scrambling options

Determine how the contents of the field are scrambled (if at all) during a copy process.

Date/Time Attributes

Defines the attributes of a field that holds date and time values (or either). These attributes include the definition of the format used to store the date and time value in the field and the format used to display the date and time value. Create and modify attributes can also be specified. These attributes define how the value in the date and time field should be initialized when creating or copying the data set. Scrambling options are also available and define how the contents of the date and time field are scrambled (if at all) during a copy process.

**Note:**

1. When copying, File Manager uses this information in the “From” template. In a “To” template, this information is ignored. However, when comparing, the selection information in both the “Old” and “New” templates (if specified) is used.
2. When copying, File Manager uses this information in the “To” template. In a “From” template, this information is ignored.

Related topics

[Copying data sets on page 341](#)

[Comparing data sets using templates on page 384](#)

[Managing templates with the Template Workbench on page 233](#)

About copybook templates

Copybook templates are templates where the *field definitions* are derived from one or more copybooks. A copybook is a member containing either COBOL data descriptions, PL/I DECLARE statements, or HLASM data definitions. Every copybook template has a *source definition*.

2. When copying, File Manager uses this information in the “To” template. In a “From” template, this information is ignored.

Source definition

The source definition describes the copybook members, their corresponding data sets, and how the field definitions are to be arranged in a template. The simplest form of source definition is a *single* copybook that contains all the record layouts required in their correct form. Single copybook source definitions can be referred to directly and a copybook template is built automatically from them.

Alternatively, you can provide an *advanced copybook source definition* that describes one or more copybook members, inserted level-01 data items, the range of statements to be included, and how REDEFINES or UNION clauses are to be interpreted in terms of record layouts.

A single copybook source definition can be the entire source of a program or only field definitions.

An advanced copybook source definition must refer to fields definitions for the same language. The source must be members of a partitioned data set.

The copybook template combines the layout information provided by the source definition with additional information supplied by the user pertaining to formatting, reformatting, record selection and data creation, to produce a logical view of the data on which these functions can be performed.

In a copybook template, the field definitions (start position, length and type) are not editable. However, copybook templates allow you to define a number of different formats for use with data sets that contain multiple record types. Records can be identified by type within a data set and each type can be associated with a different format. This allows you to view data with different types at the same time, and to view, edit or copy these records simultaneously. Copybook templates also allow criteria editing by field or by a free format REXX selection expression.

To create a new copybook template, you begin with one or more copybooks containing field definitions that describe the record structure of your data. When you specify the copybook (or copybooks) on a panel, File Manager compiles the descriptions into a template that you can save and reuse with any application data set that has the same record structure.

In a COBOL copybook, each level-01 group item describes a record type in the application data set. The elementary items in the group describe fields in the record type. For example, the following copybook describes the record structure of an application data set that contains two record types, ORDERS and ITEM:

```
01 ORDERS.
  05 ORDER-ID      PIC X(5) .
  05 CUSTOMER-ID   PIC X(5) .
  05 ORDER-DATE.
    10 ORDER-YEAR  PIC 9(4) .
    10 ORDER-MONTH PIC 9(2) .
    10 ORDER-DAY   PIC 9(2) .
01 ITEM.
  05 PRODUCT-ID    PIC X(9) .
  05 QUANTITY      PIC 9(4) BINARY .
  05 UNIT-COST     PIC 9(8) BINARY .
```

The ORDERS records contain five fields: ORDER-ID, CUSTOMER-ID, ORDER-YEAR, ORDER-MONTH and ORDER-DAY. The ITEM records contain three fields: PRODUCT-ID, QUANTITY and UNIT-COST.

PL/I copybooks are similar to COBOL copybooks, in that the major structures (level-1 names) describe record types and elementary names describe fields:

```

DECLARE 1 ORDER,
        2 ORDERID      CHAR(9),
        2 CUSTOMERID   CHAR(5),
        2 ORDERDATE,
          3 ORDERYEAR   CHAR(4),
          3 ORDERMONTH  CHAR(2),
          3 ORDERDAY    CHAR(2);
DECLARE 1 ITEM,
        2 PRODUCTID    CHAR(9),
        2 QUANTITY     BIN(15),
        2 UNITCOST     BIN(31);

```

HLASM copybooks are similar to COBOL copybooks, in that the major structures (DSECT names) describe record types and elementary names describe fields:

```

ORDER      DESCCT
ORDERID    DS  CL9
CUSTOMERID DS  CL5
ORDERDATE  DS  0CL8
ORDERYEAR  DS  CL4
ORDERMONTH DS  CL2
ORDERDAY   DS  CL2
ITEM       DESCCT
PRODUCTID  DS  CL9
QUANTITY   DS  H
UNITCOST   DS  F

```

For information about coding copybooks, see the *IBM COBOL Language Reference*, *IBM VisualAge PL/I Language Reference*, or the *HLASM V1R6 Language Reference*.

Related topics

[Specifying or updating the source definition for a copybook template on page 207](#)

[Advanced copybook selection on page 208](#)

[Set Language and Compiler Specifications \(option 0.5\) on page 1021](#)

[Compiler Language Selection panel on page 788](#)

Segmented data templates

File Manager offers template support for segmented records. A segmented record is a record that contains one or more logical segments, each of which is defined and identified by a copybook layout. When you apply a "segmented data template" to these records, each segment is treated as a logical record within the supported functions.

[Figure 54: Segmented records with no template on page 178](#) shows a simple example of segmented records, seen without using a template:

Figure 54. Segmented records with no template

```

-----1-----2-----3-----4-----5-----
**** Top of data ****
01FINAccountant      020654John      Browning  1875
01FINPurchasing Officer 021759Frederick Smith    1893
01FINAccounts Receivable 024163Annette  Fielding  1856
01MKTSales Representative026584Jessica  Simpson  1862
01MKTPromotions Manager 023579Catherine Jones    1812
01MKTMkt Research      021239Alan      Johnson  1814
01ADMChief Executive   020124David    Arrowsmith1801
01ADMSecretary/PA      024781Maryanne Davies    1802
01ADMReceptionist      026329Lizette  Wilson   1800
01ADM Clerical Officer  023571Stephen  Hughes   1806
**** End of data ****

```

Figure 55: Copybook definition for segmented records on page 178 shows the copybook definitions needed to define each record segment:

Figure 55. Copybook definition for segmented records

```

-----1-----2-----3-----4-----5
**** Top of data ****
  01 DEPT.
    03 Rec-Type      PIC XX.
    03 Dept-ID       PIC XXX.
    03 Job-Desc      PIC X(20).
  01 EMPLOYEE.
    03 Rec-Type      PIC XX.
    03 Emp-ID        PIC 9999.
    03 Given-Name    PIC X(10).
    03 Family-Name   PIC X(10).
    03 Extension     PIC 9999.
**** End of data ****

```

Figure 56: TABL view of segmented data with the DEPT Record Type selected. on page 178 shows the DEPT. records in TABL format, after a segmented data template (generated from the copybook) has been applied.

Figure 56. TABL view of segmented data with the DEPT Record Type selected.

```

REC-TYPE DEPT-ID JOB-DESC
#2      #3      #4
AN 1:2  AN 3:3  AN 6:20
<>      <->      <-----1----->
01      FIN      Accountant
- - - - - EMPLOYEE - - - - - 1 Line(s) suppressed
01      FIN      Purchasing Officer
- - - - - EMPLOYEE - - - - - 1 Line(s) suppressed
01      FIN      Accounts Receivable
- - - - - EMPLOYEE - - - - - 1 Line(s) suppressed
01      MKT      Sales Representative
- - - - - EMPLOYEE - - - - - 1 Line(s) suppressed
01      MKT      Promotions Manager
- - - - - EMPLOYEE - - - - - 1 Line(s) suppressed
01      MKT      Market Research
- - - - - EMPLOYEE - - - - - 1 Line(s) suppressed
01      ADM      Chief Executive
- - - - - EMPLOYEE - - - - - 1 Line(s) suppressed
01      ADM      Secretary/PA
- - - - - EMPLOYEE - - - - - 1 Line(s) suppressed
01      ADM      Receptionist
- - - - - EMPLOYEE - - - - - 1 Line(s) suppressed
01      ADM      Clerical Officer
- - - - - EMPLOYEE - - - - - 1 Line(s) suppressed
**** End of data ****

```

The following utilities/functions can support the use of a segmented record template:

View and Edit, DSU and DSEB functions

When a segmented data template is in use, File Manager uses In-place Editing. Segments cannot be inserted, deleted, copied or moved. The contents of segments can be edited but the length cannot be changed.

The BOUNDS primary command and BND prefix command cannot be used. If you really want to do a change across some common portion of all segments (or across certain columns of a certain segment), you can use the column range parameters on the FIND or CHANGE commands.

The Audit Report identifies changed segments.

Copy utility and DSC function

When copying a data set, you can only apply a segmented data template to the input data set. The output data set will contain a separate record for each segment in the input data set.

Compare utility and DSM function

Segmented data templates can be used for either the “Old” or “New” data sets or both. This allows you to compare segmented and non-segmented data. For example, after copying segmented data to separate records in a new data set, you might want to compare the data sets to ensure that no errors occurred in the copying process.

Print utility and DSP function

Segmented data templates are supported in the Print Utility and DSP function.



Note: Segmented data templates cannot be used for ISPF Packed data sets.

Related topics

[Setting up a template to be used with segmented data on page 212](#)

[Viewing segmented data on page 314](#)

[Copying records with segmented data templates on page 351](#)

Mapping SMF data with segmented templates

SMF records typically contain a header section with fields describing the following sections.

Typically three fields are used to tell you the offset, length and number of occurrences of a section. File Manager provides three functions that can be used in related identification criteria to aid in mapping these with a segmented template. The three segmented functions are SEGOFF(), SEGLEN() and SEGCNT().

A sample XML template illustrating the usage of these functions in mapping the SMF type 30 record can be found in your sample library (hlq.SFMNSAM1) in member FMNSMF3X. This sample XML refers to the assembler source member FMNSMF3S also found in your sample library. To use the sample XML template copy it and modify the

`<library>hlq.SFMNSAM1</library>` to reflect the correct library data set for the source member at your site.

About dynamic templates

Dynamic templates are created by users and contain customized field definitions, consisting of the starting column, length and type of fields in the data set and, optionally, a field name to identify the information. These field definitions can be edited at any time. Dynamic templates are particularly useful when working with data sets that do not have an appropriate copybook.

A dynamic template can only contain one record layout. All fields defined are treated as Level 2 elementary items, with File Manager generating the Level 1 group item for the record. The generated Level 1 has a calculated record length, determined by the rightmost byte referenced by the field definitions. Record selection must be specified by field - you cannot specify a free format selection expression for a dynamic template.

Related topics

[Creating dynamic templates on page 214](#)

Data description support

Support for COBOL data description entries

In the COBOL data description entries specified in a copybook, File Manager supports:

- ASSIGN clause
- OCCURS clause (including OCCURS DEPENDING ON)
- PICTURE clause
- REDEFINES clause
- RENAMES clause
- USAGE clause
- VALUE clause

File Manager ignores:

- BLANK WHEN ZERO clause
- DATE FORMAT clause
- EXTERNAL clause
- GLOBAL clause
- JUSTIFIED clause



Note: In general, File Manager treats Numeric Edited fields as alphanumeric. A special code, ZA, is used for unsupported zoned decimals.

File Manager supports all data item level numbers except 88 (condition-names).

The literal value that you specify in a VALUE clause is used in the template to specify the **Start value** (for numeric fields) or **Pattern** (for alphanumeric fields) “create attribute” on the Field Attributes panel for that field.

File Manager uses this attribute to initialize the value of the field when creating data or inserting new fields when copying data.

Support for PL/I data description entries

In the PL/I data description entries specified in a copybook, File Manager supports:

- PL/I data attributes VARYING and VARYINGZ for single and double-byte character strings.
- PL/I bit variables including the VARYING attribute.
- Binary, decimal, floating point and numeric picture data (excluding symbols).
- REFER variables for array extents. Both upper and lower bound array elements may be declared for each dimension. The number of extents for each dimension is always:

```
upper bound - lower bound + 1
```



Note: A zero extent is not allowed for a PL/I dimension. If a bound is not specified PL/I assumes a value of 1.

- REFER variable to declare the length of a string variable, character (AN), varying-length character (VC) or zero-terminated character string (ZC) in bytes.
- File Manager also supports PL/I double-byte character variables (DB), varying-length double-byte character (VD) and zero-terminated double-byte characters (Z2) as byte pairs. File Manager also supports bit strings (BT) and varying bit string (VB) variables.
- REFER variables can be declared as integer, fixed binary, packed decimal, floating point, or character string variables.
- UNION declarations at any level which can have varying-length (REFER string length or REFER array extents).



Note: UNIONS can contain overlays of different data types, which may require template workbench record selection criteria or SHOW control if data is not displayable.

File Manager ignores:

- INIT data values
- REFER start expression, for example, VAR(, expr Refer abc,) or CHAR(expr Refer abc).
- EXTERNAL attributes
- DEFINED structure overlays
- LIKE structure attributes



Note: In general, File Manager treats Numeric Edited fields as alphanumeric. A special code, ZA, is used for unsupported zoned decimals.

Support for variable-length arrays

A variable-length array is defined in a COBOL copybook by an OCCURS DEPENDING ON (ODO) clause, and in a PL/I copybook by a dimension attribute where the lower or upper bounds (or both) are defined by REFER options, or when a PL/I string data type has a REFER variable for the declared length, for example, CHAR(expr REFER name).

The following considerations apply when using a template that contains variable-length arrays:

- A record structure can contain multiple variable-length arrays; however, the fields that define the size of the arrays (the ODO or REFER “objects”) must all appear in the record prior to the first variable-length array item, or, in the case of PL/I REFER length, prior to the first string declared with a REFER length.
- If any of the following are true:
 - (COBOL copybook only.) The object is out of the range specified by the ODO clause.
 - The actual record length does not match the calculated length of a record with the number of array items specified by the object.
 - (PL/I copybook only.) The record length does not match the calculated length of a record based on both string length REFERs and number of dimension extents calculated from the lower and upper bound REFERs for each dimension of an array.

When editing the data set, the prefix area contains the description =LGTH, indicating that the record was not selected because of invalid length. (To show these records, rather than hiding them with other “not selected” records, select the **Length error** option on the Edit/Browse Options (option 0.8) panel.)

- In SNGL or TABL display format:
 - You can change the length of a record by changing the value of an object field. This is an exception to the rule that the length of a record cannot be altered in an Edit session, without using ZOOM.
 - When you change the value of an object field, then the number of items in the array expands or contracts automatically.

New items are inserted at the end of the current array (and before any fields that follow the array); numeric items are initialized to zero and alphanumeric items are initialized to blanks.

Similarly, items are deleted from the end of the array, and any fields subsequent to the end of the array are not affected.

For PL/I, the number of items in an array is determined by subtracting the lower bound of the dimension attribute from the upper bound and then adding one. If any REFER variables (fields) are specified as a lower or upper bound of an array dimension, then changing the value of any REFER object field inserts or deletes array items accordingly. For the TABL Format, if the new number of array items exceeds the current number of TABL columns for the array, File Manager expands the number of columns in the display and adds new

column headings. Similarly, if a PL/I string length REFER is changed, the column width in TABL for each variable using that REFER is changed.

- (COBOL copybook only.) File Manager does not allow you to change the object field to a value outside the range specified by the ODO clause (File Manager supports an ODO lower value of 0.)
- (COBOL copybook only.) Inserting a new record results in a record with the minimum number of array items specified by the ODO definition. For example, given the following ODO clause:

```
ODO-ONE OCCURS 0 TO 10 TIMES DEPENDING ON ODO-CNTRL-ONE.
```

then, when you insert a new record, the ODO-CNTRL-ONE field is initialized to zero, and there are no ODO-ONE array items in the new record.

Given the following ODO clause:

```
ODO-ONE OCCURS 5 TO 7 TIMES DEPENDING ON ODO-CNTRL-ONE.
```

then ODO-CNTRL-ONE is initialized to 5, and there are five ODO-ONE array items in the new record.

- (PL/I copybook only.) Inserting a new record using a template that contains REFER specifications results in one element for each array dimension. Upper and lower bound REFER values are set to one.
- In CHAR, HEX or LHEX display format, changing the value of an object field does **not** change the record length. In these display formats, changing the value of an object field can result in a mismatch between the object field value and the calculated length of the record with that many array items.

If you select **Expose (do not group) records of types: Length error** on the Edit/Browse Options (option 0.8) panel then, in Edit (option 2), such records appear with an =LGTH indicator in their prefix area.

Editing rules for PL/I varying length string types

Fields with the PL/I VARYING attribute (VC, VD, and VB) are separated into two fields for File Manager processing. The first field is the current string length field (named "len" in File Manager Headings), and is followed by a second field that contains the string data to be displayed. Each of the string types has the current string length displayed as a FIXED BIN(15) field.

The separated "len" fields created by File Manager for varying strings do not need creation attributes, as the data content determines the "len" value.

In Edit mode, the data string field maximum display width is divided into unprotected characters, up to and including the current length, and a protected area beyond the current length in a non-display mode. VD strings require two character positions for each double-byte value declared for the string, and two character positions for each current length value that is unprotected. BIT strings require one character position in the Edit panel for each bit value in the string. Character positions beyond the current string length are in protected non-display mode for VD and VB types.

The maximum string length for these string types can be declared as a constant or as varying by specifying a REFER variable name that is present in the structure. If declared with a REFER variable for maximum string length, then each record can have different starting positions and data string display widths for that field and any following fields. REFER variables may also be present in the structure to define the bounds or extents of variables declared as dimensioned arrays.

The Edit processing rules for a VARYING field are:

- The length field of a varying string can be changed to a value in the range 0 to the maximum declared length for the field in that record.
- If the length is decreased, then the data string is truncated to the new length and the remaining display positions are protected from entry.
- If the length is increased, appropriate initialization occurs up to the new current length.
- To change the maximum length of a string variable that uses a REFER value, that REFER value must be changed first and the ENTER key pressed to reset the maximum string length. If the new maximum set by the REFER value is less than the current length of the data string, the data string is truncated and the current length is highlighted as a field in error.

Editing rules for PL/I varying length zero terminated string types

Character or Graphic data types with the PL/I VARYINGZ attribute (FM types ZC and Z2) are shown in the Edit panels with one or two display characters added to the end of the declared length. These screen positions contain X'00' or X'0000' when the current length of the string is equal to the maximum declared length. The extra positions are protected from data entry by File Manager.

The Edit processing rules for a VARYINGZ field are:

- The position of the X'00' or X'0000' terminating characters is automatically moved within the string if the replacement string length is not equal to the replaced string length.
- If the updated string length would exceed the string maximum, an error message is issued.
- If the updated string length is equal to the string maximum the X'00' or X'0000' is moved to the extra display positions.
- If a VARYINGZ field declaration specifies a maximum length REFER variable, the displayed REFER value may be updated to increase or decrease the maximum string length for the VARYINGZ field. If the new maximum length set by the REFER value is less than the current length of the data string, the data string is truncated and the terminating characters are placed in the new extra positions.
- Overtyping of a Graphic VARYINGZ field is not recommended as Graphic strings usually contain undisplayable characters that can't be overtyped in the TABL or SNGL Formats.

Using HLASM copybooks with File Manager

To instruct File Manager to process a HLASM (High Level Assembler) copybook, you must set the language option to HLASM. The **Auto detect** selection applies to COBOL and PL/1 copybooks only. Once you have set the option to HLASM, then every function that supports copybooks can be used with a HLASM copybook. Use the HLASM compiler specifications to provide extra SYSLIB and change ALIGN and DBCS processing options.

Related topics

[Setting your HLASM processing options on page 204](#)

Interpreting HLASM source

To process a HLASM copybook, File Manager invokes the HLASM compiler. It then produces a record layout (or segment layout) for each DSECT it finds with corresponding DS or DC fields. File Manager interprets the DS and DC fields as shown here:

Blank field name

If a DS or DC statement does not have a field name, then it is assigned the name "*".

Multiple operands

If a DS or DC statement has multiple operands, then the field is defined as a group field and a child element is created for each operand with the suffix of "_On" where *n* is the relative number of the operand.

For example:

```
REC_TYPE01 DSECT
FIELD1 DS    F,H,CL1
```

produces:

Ref	Field Name	Picture	Type	Start	End	Length
	**** Top of data ****					
1	1 REC_TYPE01		AN	1	7	7
2	2 FIELD1	F,H,CL1	AN	1	7	7
3	3 FIELD1_01		BI	1	4	4
4	3 FIELD1_02		BI	5	6	2
5	3 FIELD1_03		AN	7	7	1
	**** End of data ****					

Multiple values

If a DS or DC operand has multiple values associated with it, then a group field is defined with child elements for each value with the suffix of "_Vn" where *n* is the relative number of the value.

For example:

```
REC_TYPE01 DSECT
FIELD1 DS    F'1,2,3',H,CL1
```

produces:

Ref	Field Name	Picture	Type	Start	End	Length
	**** Top of data ****					
1	1 REC_TYPE01		AN	1	15	15
2	2 FIELD1	F'1,2,3',H,CL1	AN	1	15	15
3	3 FIELD1_01		AN	1	12	12
4	4 FIELD1_01_V1		BI	1	4	4
5	4 FIELD1_01_V2		BI	5	8	4
6	4 FIELD1_01_V3		BI	9	12	4
7	3 FIELD1_02		BI	13	14	2
8	3 FIELD1_03		AN	15	15	1
	**** End of data ****					

Duplication factor

If a DS or DC operand has a duplication factor greater than 1, then the resultant field is treated as a single dimensioned field that occurs the number of times specified by the duplication factor.

For example:

```
REC_TYPE01 DSECT
FIELD1 DS 5F
```

produces:

Ref	Field Name	Picture	Type	Start	End	Length
	**** Top of data ****					
1 1	REC_TYPE01		AN	1	20	20
2 2	FIELD1(5)	F	BI	1	4	4
	**** End of data ****					

Bit length specification

If a DS or a DC has a bit length specification, it is defined as a bit field irrespective of the field type.

For example:

```
REC_TYPE01 DSECT
FIELD1 DS AL.5
```

produces:

Ref	Field Name	Picture	Type	Start	End	Length
	**** Top of data ****					
1 1	REC_TYPE01		AN	1	1	1
2 2	FIELD1	AL.5	BT	1	1	1
	**** End of data ****					

DSECT or layout length

The level-1 field is always set to the maximum end column for any field.

Redefines/Range specifications

If you are using advanced copybook selection to build a template, the X prefix command enables you to interpret the ORG fieldname in the same manner as a COBOL redefines or PL/I union statement.

Template repository

The template repository is a VSAM KSDS file that is used to associate a data set or resource name with its corresponding template.

This removes the need for the product user to know the template data set name. Each repository entry allows for up to six partitioned template data sets of like attributes that will be concatenated when determining the location of the template.

This section describes how to use, create, load, and maintain a template repository.

Specifying the repository data set name

There are three methods of providing the name of the template repository data set.

The methods are evaluated in the following order and the first specification is used for the rest of the session.

1. Specify the repository name in the respective FMNxPARM PARMLIB member.
2. Allocate a ddname TPREPOS to a TSO/ISPF session or specify it as a DD card to a batch job.

JCL:

```
//DD TPREPOS DISP=SHR,DSN=hlq.TEMPLATE.REPOSTRY
```

TSO command:

```
'ALLOC FI(TPREPOS) DA('hlq.TEMPLATE.REPOSTRY') SHR REUSE'
```

3. Customize the options module FMN4POPT.

For more information on setting up File Manager to use a template repository, see the *File Manager for z/OS Customization Guide*.

Using a mandatory repository

A mandatory repository identifies resources that have templates or views that will be used to anonymize or scramble the data.

If a repository is defined as mandatory for the current user, access to the resources that are defined in the repository as mandatory is limited to the following interfaces:

- The edit and view functions in File Manager Base component and FM/Db2
- The browse and edit functions in FM/IMS

Access to the resources can only be through the template or view that is defined in the repository.

Dynamic scrambling

If the corresponding template or view contains scrambling definitions, then the data will be *scrambled* before it is displayed. Unselected field values will be initialized to zero or blank depending on the field type. For edit or view sessions these fields are protected, and insert, repeat, and delete commands are unavailable. Only formatted views of the data are available. This provides the capability to scramble or hide sensitive information for certain user groups when the data is accessed using File Manager.

The TESTMASK command can be issued on the View or Edit entry panel. This command toggles the scrambling option, which will force the usage of the template and restrict the function to view or browse dialogs.



Note: To enable dynamic scrambling through the TESTMASK command the resource entry must be marked as mandatory.

Telling File Manager to use the repository template name

The repository template definition will be used when `?` is specified in the template data set name field in the ISPF interface or the `TCIN=` keyword in a batch job.

Example

Example 1: View session

In the following figure, ? is specified in the template data set name field to indicate that the repository template will be used when viewing data set FMN.FMDATA.

```

File Manager                               View Entry Panel
Command ==> _____

Input Partitioned, Sequential or VSAM Data Set, or HFS file:
Data set/path name 'FMN.FMDATA' _____ +
Member . . . . . _____ Blank or pattern for member list
Volume serial . . _____ If not cataloged
Start position . . _____ +
Record limit . . . _____ Record sampling _

Copybook or Template:
Data set name . . ? _____
Member . . . . . _____ Blank or pattern for member list
Processing Options:
:
    
```

Example

Example 2: Batch print

In the following figure, TCIN=? indicates that the repository template will be used when printing data set FMN.FMDATA.

```

//FMBAT EXEC PGM=FILEMGR
//SYSPRINT DD SYSOUT=*
//SYSIN DD *
$$FILEM DSP FORMAT=TABL,
$$FILEM DSNIN=FMN.FMDATA,
$$FILEM TCIN=?
    
```

Template repository edit

The **Template Repository Edit** panel is used to create, list, and maintain repository entries.

File Manager option 7.7.1 is the repository edit option.

Figure 57. Template Repository Edit panel

```

Process  Options  Help
-----
File Manager          Template Repository Edit
Command ==> _____ Scroll PAGE

Repository:
Data set name . 'FMN.TEMPLATE.REPOSTRY' _____
Filter . . . . * _____ +
    
```

Creating a repository file

If you enter a data set name that does not exist, the **VSAM Define** panel is displayed. Use this to define a VSAM KSDS data set to store the repository.

The default space allocation allows for 10000 primary and 5000 secondary records. You can adjust these values to reflect the expected number of entries. Do not change the VSAM key length and offset definition or the average and maximum record length (Recsize) values. Other attributes can be customized if necessary.

Press Enter to define the repository data set and proceed to the insert dialog for a new entry.

Listing entries in a repository

You can display all the existing entries in a repository or provide a *generic* name to filter the output as follows:

In a generic name use the percent (%) sign to represent a single character, and an asterisk (*) to represent any number of characters within qualifier. Two asterisks (**) represent any number of characters within any number of qualifiers.

```

  Process  Options  Help
-----
File Manager      Template Repository Resource List      Row 00001 of 00009
Command ==> _____ Scroll PAGE

Repository:
  Data set name . 'FMN.TEMPLATE.REPOSTRY'
  Filter . . . . *fmdata*

```

For example, enter *fmdata* in the **Filter** field to match resources whose name contains FMDATA:

```

  Process  Options  Help
-----
File Manager      Template Repository Resource List      Row 00001 of 00009
Command ==> _____ Scroll PAGE

  Resource Name                                     ±
  *FMDATA*
  <-----10-----2-----3-----4-----5-----6-----7----->
  _ FI:C68D1FM4:FMDATA
  _ FMN.FMDATA
  _ FMN.FMDATA.ESDS
  _ FMN.USERZYX.FMDATA.ASM
  _ FMN.USERZYX.FMDATA.ASM1
  _ FMN.USERZYX.FMDATA.COBOL
  _ FMN.USERZYX.FMDATA.COBOL1
  _ FMN.USERZYX.FMDATA.PLI
  _ FMN.USERZYX.FMDATA.PLI1
  **** End of data ****

```

The following prefix commands are supported.

S or / or E

Edit the repository entry

I

Insert all fields for a new repository entry

R

Insert a new repository entry by repeating all field values and specifying a new resource name.

D

Delete the repository entry

Insert or update repository entries

The **Template Repository Update** panel is used to insert or update repository entries.

This panel is displayed to enter the first repository entry or when you use a line command on the **Template Repository Resource List** panel to edit or insert a new entry. The repository will be updated when you press F3 with a valid resource and associated template. You can rename a resource by overtyping the existing name to a name that doesn't yet exist.

Figure 58. Template Repository Update panel

```

Process  Options  Help
-----
File Manager          Template Repository Update
Command ==>> _____ Scroll PAGE

Resource:
Name . . . HLQ.SFMNSAM1(FMNCDATA) +
Template Member and data sets:
Member . . . FMNCTMPL
Data set 1  HLQ.SFMNSAM1
          2  _____
          3  _____
          4  _____
          5  _____
          6  _____

JSON CCSIDs:
Source . . . ____0
Data . . . ____0
DBCS . . . ____0

Processing Options:
Enter "/" to select option
- JSON generic      - Default data sets  - Ignore compiler options
- View resource     - Edit template      - Copybook
- Mandatory
    
```

Field descriptions

Resource Name

This field is the key that will be used to look up the repository. The value must be the name of a valid data set, path, MQ queue name, or Db2®, IMS™, or CICS® resource name.

Specify Db2® resources in this form:

```
D2 : ssid: location.owner.object
```

Specify IMS resources in this form:

```
I1 : ssid: DBDname
```

For resources other than Db2® and IMS™ generic names are supported, so you can populate the field value from a selection list. For partitioned data sets you must also provide a member name.

Press F10 or F11 to scroll left or right through the field. Press F4 to expand the field.

If the resource name is changed and the new name does not exist, the previous resource name will be renamed. If the new name exists then the panel values will be changed to reflect the existing entry.

Template Member

(Required) If any data sets are specified, the template member must exist in at least one of them. The data sets are concatenated and searched in the order in which they are specified in the fields **Data set 1** through **6**.

If no data sets are specified in **Data set 1** through **6**, the repository default data sets are used to locate the template (see option **Default data sets**). You can enter a generic value to select from a member list of either the data sets specified on the panel or the default data sets.

 **Tip:** Specify a member that is a template, not a copybook. If the member name refers to a copybook, File Manager will attempt to build it, and the associated compiler language and options for the current user will be saved in the repository to enable successful compilation of the copybook when it is later accessed using the repository. If copybooks are stored in the repository, ensure that all associated SYSLIB data sets are accessible by the repository users.

Template data sets 1 - 6

Up to six data set names can be specified per entry. The template member must exist in at least one of the specified data sets. Entering generic names will select from a list. If more than one data set is specified, then they must have like attributes as they will be concatenated in order when loading the template.

JSON CCSIDs

These values are the CCSID values that will be used by File Manager to produce JSON. The JSON contains field names, single-byte field values and double-byte field values that are converted to UTF-8. The CCSIDs below are used as the “*from*” CCSID for the conversion routines. If these values are left as zero they will default to the keyword or system installation values.

Source

CCSID of the field names specified in the template.

Data

CCSID of single-byte field values.

DBCS

CCSID of double-byte field values.

Processing options

Type / to select each option.

JSON generic

Select this option to produce JSON in a generic format instead of the default specific format:

Figure 59. Example 1. Specific JSON format

```
{
  "records": [
    {
      "layouts": [
        {
          "CUST-REC": {
            "CUST-ID": "02200",
            "NAME": "Graham, Anna"
          }
        }
      ]
    }
  ]
}
```

Figure 60. Example 2. Generic JSON format

```
{
  "records": [
    {
      "layouts": [
        {
          "layout": "CUST-REC",
          "fields": [
            {
              "field": "CUST-ID",
              "type": "AN",
              "NAME": "Graham, Anna"
            }
          ]
        }
      ]
    }
  ]
}
```

Default data sets

Select this option to view or change the default template data sets for the repository.

Figure 61. Default Template Data sets panel

Process	Options	Help
File Manager	Default Template Data sets	
Command	===>	
Data set	1	FMN.TEMPLATE
	2	FMN.TEMPLAT2
	3	_____
	4	_____
	5	_____
	6	_____

Up to six data sets of like attributes can be specified. These data sets will be used to locate the template member if no data sets are specified on the **Template Repository Update** panel.

For Db2® and IMS™ resource definitions, default data sets can be defined for each subsystem.

Ignore compiler options

Select this option to ignore any existing compiler options for the current entry. This option is only relevant when updating an existing repository entry that referred to a copybook and a change is being made such that the new member is a template or a copybook that requires different compiler options.

View resource

Select this option to view the resource with the associated template.

Edit template

Select this option to edit the specified template.

Copybook

Select this option if the template member and data sets refer to a source copybook.

Mandatory

Select this option to make this template mandatory for users to whom the repository is defined as mandatory.



Note: You can test the mandatory usage of a template for a resource by a user where the repository is not mandatory. Enter the command TESTMASK on the View or Edit entry panel. This command toggles the scrambling option which will force the usage of the template and restrict the function to view or browse dialogs.

Template repository utilities

Use the template repository import and export utilities to make mass changes to repository entries.

Template repository export utility

The template repository export utility exports repository entries in XML form to an output data set.

This allows for mass changes to the XML data, which can then be imported using the Import Utility. The filter can be used to restrict the number of entries to be exported.

Figure 62. Template Repository Export Utility panel

<u>P</u> rocess	<u>O</u> ptions	<u>H</u> elp
File Manager Template Repository Export Utility		
Command ==>		
Repository:		
Data set name .	'FMN.TEMPLATE.REPOSTRY'	
Filter	-----	+
Export Data set:		
Data set name .	EXPORT.REPOSTRY	
Member	ABC	_ Edit
Processing Options:		
Enter "/" to select option		Enter "/" to select option
_ Batch execution		/ Replace member

Repository Data set name

(Required) A fully qualified or generic data set name that will be used to identify the template repository data set. If a blank name is entered File Manager will determine the repository name from either the allocated ddname TPREPOS or the FMN4POPT options module if it has been customized to contain the template repository data set name.

Filter

This field is used to filter the resource entries that will be exported to the output data set. If you leave it blank all resource and default repository entries will be exported.

Export Data set name

(Required) A fully qualified or generic data set name that will be used to identify where the exported XML data will be stored. If the data set does not exist you will be prompted for allocation details.

Member

If the export data set is partitioned, enter the name of a member in which to store the output. To select the required member from a member name list, leave this field blank or specify a member name pattern.

Edit

Enter / to edit the export data set or member.

Batch execution

Enter / to edit the batch JCL to run the function in batch.

Replace member

Enter / to replace a like-named member in the output partitioned data set.

Template repository import utility

The template repository import utility imports repository entries in XML form from a data set produced by the export utility.

The XML format allows for mass changes to be more conveniently made to repository entries, which can then be imported back to File Manager.

Figure 63. Template Repository Import Utility panel

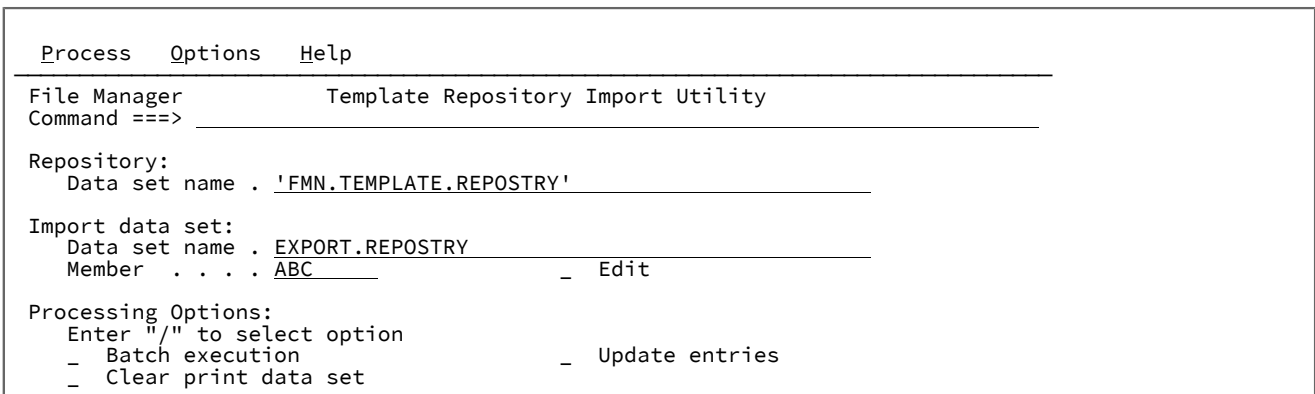

Repository Data set name

(Required) A fully qualified or generic data set name that will be used to identify the template repository data set. If a blank name is entered File Manager will determine the repository name from either the allocated ddname TPREPOS or the FMN4POPT options module if it has been customized to contain the template repository data set name.

Import data set name

(Required) A fully qualified or generic data set name that will be used to identify the data set from where the XML entries will be imported.

Member

If the import data set is partitioned, enter the name of a member that contains the XML data. To select the required member from a member name list, leave this field blank or specify a member name pattern.

Edit

Enter / to edit the import data set or member.

Batch execution

Enter / to edit the batch JCL to run the function in batch.

Update entries

Enter / to update existing entries with the same resource name.

Clear print data set

Enter / to clear previous import report data from the print data set.

Import report

When running File Manager interactively with **Output destination** set to "3. Data set" in the Print Processing Options, you can use the PB command to view the import report.

Figure 64. Example of a Repository Update import report

Repository Update Report	
Resource Name	Status
DEFAULT BASE	Added
FI:C68D1FM4:FMDATA	Added
FMN.FMDATA	Added
FMN.FMDATA.ESDS	Added
FMN.USERZYX.FMDATA.ASM	Not updated
FMN.USERZYX.FMDATA.ASM1	Added
FMN.USERZYX.FMDATA.COBOL	Added
FMN.USERZYX.FMDATA.COBOL1	Added

Report description**Resource Name**

The name attribute value of the entry or DEFAULT BASE for a default entry.

Status**Added**

New entry added.

Updated

An existing entry has been replaced.

Not updated

Update entries was not selected and the entry exists.

Template build error

The associated template could not be loaded. This is normally due to a compilation error or invalid template.

Processing error

An error occurred whilst processing this entry. See associated messages.

Template repository export history utility

The template repository history export utility is used to export history entries in XML form to an output data set that can subsequently be reviewed and optionally changed and imported back into a template repository.

File Manager keeps a history table for each user in the ISPF profile data set. History entries are found in an ISPF table named FMNTMHST, which is normally located in the data set associated with the ddname ISPPROF. The repository history export utility produces a data set selection list where ISPF profile data sets can be selected as input. After one or more profile data sets are selected the XML data set is populated and an edit session is invoked in which entries can be reviewed and modifications can be made. Following the edit session, a prompt to proceed to the import dialog is issued.



Note: Importing a large number of entries should be performed in batch as the import process might take a long time.

Figure 65. Template History Export Utility panel

```

  Process  Options  Help
  -----
File Manager          Template History Export Utility
Command ===> _____

Template History:
  Data set filter  -----

Export Data set:
  Data set name .  _____
  Member . . . .  _____

Processing Options:
  Enter "/" to select option
  / Replace member
  
```

Data set filter

A fully qualified or generic data set name that will be used to list the ISPF profile data sets that contain the FMNTMHST history table. If you leave this field blank it will default to the current ISPF user profile data set.

Use the S command from the list produced to select one or more profile data sets for input to the export process. To add more profile data sets, change the data set filter and repeat the selection.

Export Data set name

(Required) A fully qualified or generic data set name that will be used to identify where the exported XML data will be stored. If the data set does not exist you will be prompted for allocation details.

Member

If the export data set is partitioned, enter the name of a member in which to store the output. To select the required member from a member name list, leave this field blank or specify a member name pattern.

Replace member

Enter / to replace a like-named member in the output partitioned data set.

Example**Example**

Export the history of more than one user and import the entries to a template repository.

```

  Process  Options  Help
  -----
File Manager          Template History Export Utility
Command ===> _____

Template History:
  Data set filter _____

Export Data set:
  Data set name . EXPORT.REPOSTRY
  Member . . . . HISTORY

Processing Options:
  Enter "/" to select option
  / Replace member

```

Enter the name of a data set and member in which to store the output XML. If these don't exist they will be created. Leave the **Data set filter** field blank.

Press Enter to proceed to the **ISPF Profile Data Set Selection** panel.

```

  Process  Options  Help
  -----
File Manager          ISPF Profile Data Set Selection          Row 00001 of 00001
Command ===> _____ Scroll PAGE
Data Set Selection for myuserid.ISPF.ISPPROF
  Data Set Name          Type  Volume Created
  myuserid.ISPF.ISPPROF  *    *          *
  S myuserid.ISPF.ISPPROF PDSE  D$US50  2018.214
**** End of data ****

```

Use the S prefix command and then press Enter to select and highlight the profile data set.

Change the heading filter to another user ID.

```

Process  Options  Help
-----
File Manager      ISPF Profile Data Set Selection      Row 00001 of 00001
Command ==> _____ Scroll PAGE
Data Set Selection for USER2.ISPF.ISPPROF
  Data Set Name      Type  Volume Created
  USER2.ISPF.ISPPROF *      *      *
S USER2.ISPF.ISPPROF PDSE  D$US50 2018.214
**** End of data ****
    
```

Repeat the profile selection step for each additional user ID and then press F3 to finish selection and invoke the export process.



Note: Read access to the user profiles is required to export the history.

```

File  Edit  Edit_Settings  Menu  Utilities  Compilers  Test  Help
-----
ISREDDE2  myuserid.EXPORT.REPOSTRY(HISTORY)re- 01.00      Columns 00001 00072
Command ==> _____ Scroll ==> PAGE
***** ***** Top of Data *****
==MSG> -Warning- The UNDO command is not available until you change
==MSG> your edit profile using the command RECOVERY ON.
==MSG> -CAUTION- Profile is set to STATS ON. Statistics did not exist for
==MSG> this member, but will be generated if data is saved.
000001 <repository>
000002 <entry name="KEEPER.APAR.PI76128.DATA(OLD1)" member="OLD1">
000003 <library>KEEPER.APAR.PI76128.TEMPLATE.XML</library>
000004 </entry>
000005 <entry name="KEEPER.APAR.PI76128.DATA(NEW1)" member="NEW1">
000006 <library>KEEPER.APAR.PI76128.TEMPLATE.XML</library>
000007 </entry>
000008 <entry name="HLQ.SFMNSAM1(FMNCDATA)" member="FMNCTMPL">
000009 <library>HLQ.SFMNSAM1</library>
000010 </entry>
000011 <entry name="FMN.USERXYZ.DATA(MODDATE)" member="MODDATE">
000012 <library>F
000013 </entry>
000014 <entry name
000015 <library>FMN.USERXYZ.TEMPLATE.XML</library>
    
```

Review the XML document in the ISPF edit session. Delete entries that are not required in the repository and modify entry names where appropriate. When you have finished editing entries, press F3 twice to proceed to the Import panel.

In the **Template Repository Import Utility** panel, type / in the **Batch execution** field and then press Enter to submit a batch job to run the import.

Export utility XML format

This topic describes the format of the XML that is produced by the template repository export utility and processed by the import utility.

The following sample show definition blocks for COBOL, PL/I, and HLASM. Specify one language definition only.

```

<repository>

  <!-- Default data sets - entry -->
  <entry base="1">
    <library>default template dsn</library>      <!-- up to 6 repeats -->
  </entry>
  <entry ims="1" subsystem="subsys_name" >
    
```

```

    <library>default IMS template dsn</library> <!-- up to 6 repeats -->
</entry>
<entry db2="1" subsystem="subsys_name" >
    <library>default DB2 template dsn</library> <!-- up to 6 repeats -->
</entry>
<!-- Resource entries -->
<entry    name="data set or resource name"
          member="template member name"
          ccsid="source CCSID value"
          dataccsid="Data CCSID value">
    <library>template data set</library>          <!-- up to 6 repeats -->

<!-- Copybook element is only required for copybook members -->
<copybooks>
    <syslib>syslib</syslib>          <!-- up to 12 repeats -->
    <!-- Language definitions for copy. Specify only one language. -->
    <cobol  dbc="Boolean"
           maxrc="number"
           mixedcase="Boolean"
           dpc="Boolean"
           arith="Boolean">
        <replace>
            <repfrom>from string</repfrom>
            <repto>to string</repto>
        </replace>
        <cbladdop>Additional options</cbladdop>
    </cobol>

    <pli    graph="Boolean"
           maxrc="number"
           bin63="Boolean"
           fixdec="Boolean"
           unalign="Boolean">
        <pliaddop>Additional options</pliaddop>
    </pli>

    <asm    dbc="Boolean"
           noalign="Boolean"
           maxrc="number">
        <asmaddop>Additional options</asmaddop>
    </asm>

</copybooks>
</entry>
</repository>

```

Managing templates

You can create or edit a copybook template or a dynamic template "on the fly", from any of the following panels:

- View Entry
- Edit Entry
- Browse Entry
- Utilities/Data Create
- Utilities/Print

- Utilities/Copy (From and To panels)
- Utilities/Compare (Old and New panels)

You can also create, edit and otherwise manage your templates, independently of any particular task, within the Template Workbench.

Setting your template processing options

File Manager goes through the compilation process whenever you create a template from a copybook, even if you have already successfully created other templates from the same copybook, and whether you are creating a temporary template while viewing data, or creating a permanent template using the Template Workbench.

You can customize the way that File Manager compiles templates by changing your template processing options. You are able to choose whether File Manager detects the programming language that you are using in your copybooks and then automatically selects the appropriate compiler, or whether you want to force File Manager to always use one type of compiler. You can also set the processing options for the COBOL, HLASM, and PL/I compilers.

If you are creating a new template from an existing *template* model (using the CM command on the Template Workbench (option 7) panel), File Manager does not perform a compilation.

When you specify a copybook in a panel, batch job, REXX procedure or other function, File Manager:

1. Checks whether the copybook is a complete source program or contains only field definitions.

If the copybook is not a complete program then File Manager includes the copybook in a shell program.

2. Invokes the compiler to check the syntax of the copybook, and to produce an ADATA file.

You can use the Compiler Language Selection panel to:

- Specify which compiler File Manager is to invoke, or whether File Manager is to automatically detect whether the language is COBOL or PL/I, and invoke the appropriate compiler.
- Override the compiler options stored in the template.

You can specify the acceptable return code level for the compilation in the language processing options panels.

3. If the compilation completes without errors, then File Manager processes the information in the ADATA file to create a template.

If the compilation completes with a return code of greater than the specified maximum:

- If you are using File Manager under ISPF, then a pop-up menu is displayed. From the pop-up menu you can:
 - View the compilation listing using Print Browse (option 3.9).
 - Abort the template creation process.
 - Retry the compilation. Before you select this option, view the compilation listing and correct any errors in the copybook. While you are viewing the compilation listing, you can use the ISPF split screen facility to swap to another ISPF session and use your editor to correct the errors in the copybook.
 - Ignore the errors and proceed with creating the template. This option is only available if File Manager is able to create a template. Some compilation errors, such as warnings, might have no effect on the

creation of the template. If you are unsure, you can view the compilation listing. If the compilation error is too severe, File Manager cannot create a template.

- Try the compiler for the other language.
- If you are using a File Manager function in a batch job, REXX procedure or TSO clist, then File Manager issues the error message “Copybook Compilation Errors Occurred RC=*nn*”. The batch job, REXX procedure or TSO clist continues as if you had not specified a copybook.

Related topics

[Compiler Language Selection panel on page 788](#)

[Selecting your compiler language on page 201](#)

[Overriding Compiler Options on page 206](#)

Selecting your compiler language

To select your compiler language:

- From the Primary Option Menu panel, select **0 Settings**, then **5 Compiler**, and **1 LANG**.
- Specify your choice by entering the option number:

1. COBOL

Use the COBOL compiler, regardless of the language used in your copybook.

2. PL/I

Use the PL/I compiler, regardless of the language used in your copybook.

3. Auto detect

Note: Applies to COBOL and PL/I only. To instruct File Manager to use the HLASM compiler, you must select **4. HLASM**.

Allow File Manager to detect whether the language used in your copybook is COBOL or PL/I and select the appropriate compiler.

If the copybook does not contain any keywords that File Manager can use to determine the language, then File Manager uses the COBOL compiler.

If the compiler creates ADATA and produces a return code of less than or equal to the Maximum Return Code specified in the compiler processing options, then File Manager creates the template without any prompting.

If the compiler creates ADATA but produces a return code greater than the specified maximum, then File Manager displays a pop-up menu where you can choose from various options, including using the other compiler.

If no ADATA was created, then File Manager uses the other compiler without prompting.

If the other compiler creates ADATA but the return code is greater than the specified, then File Manager displays the pop-up menu.

If the other compiler does not create ADATA, then File Manager retries the first compiler, and again displays the pop-up menu.

4. HLASM

Use the HLASM compiler.

Related topics

[Data description support on page 180](#)

[Compiler Language Selection panel on page 788](#)

Setting your COBOL processing options

When your COBOL copybooks fit into any of the following scenarios, you must set your COBOL processing options so that File Manager can process them correctly.

- You have used COPY compiler-directing statements to include other members that do not belong to the same PDSs as the copybooks.
- Your COBOL copybooks contain characters that you want to remove or replace with other characters before compiling the copybooks into templates.
- You have used DBCS characters in your copybooks.



Note: File Manager now supports specifying additional SYSLIBs and REPLACE text in the same copybook.

To set your COBOL processing options:

1. From the Primary Option Menu panel, select **0 Settings**, then **5 Compiler**, and **2 COBOL**.

The COBOL Processing Options panel is displayed.

2. If you have used additional SYSLIBS, enter the names of the data sets in the **Additional SYSLIB data set** fields.

Members included by COPY compiler-directing statements must be found in the SYSLIB concatenation. When you specify a copybook on a File Manager panel to create a new template (or update an existing template), the SYSLIB concatenation consists of the PDS of the copybook, plus up to ten additional PDSs that you can specify on this panel. These PDSs are searched in order (PDS of the copybook, followed by these additional PDSs, 1–10.)



Note: CA-Panvalet libraries cannot be specified as additional SYSLIB sets. Further, if a CA-Panvalet Library is the main copybook library, then no additional SYSLIB data sets may be specified.

- If you want to replace text in your copybooks, enter pseudo text character strings in the COBOL Replacing Options **From string** and **To string** fields.

For example, if your copybooks contain colon characters (:) that you want to remove before compiling, then specify `===:` as a "From" string and `=====` as the matching "To" string.

- If your copybooks contain DBCS characters, select the DBCS compiler option. Otherwise, use NODBCS.
- To set the maximum acceptable return code for a compile, enter a value in the **Maximum Return Code to be accepted from compiler** field.

When using the online panels to generate a template from a copybook, if the compiler returns a warning/error code greater than the specified number, File Manager displays a pop-up menu in which you can make decisions about further processing.

When generating a template during the processing of a batch function, if the compiler returns a warning/error code greater than the specified number, File Manager halts the running of the function.

- To use the COBOL SPECIAL-NAMES paragraph "Decimal-point is comma" when compiling COBOL copybooks, select the option, **Decimal-point is comma**.

When you select this option, the COBOL compiler exchanges the functions of the period and the comma in PICTURE character strings and in numeric literals.

- To use the Arith(extend) COBOL compile option when compiling COBOL copybooks, select the option, **Arith(extend)**.
- To retain the original case of field names as coded in the COBOL copybooks, select the option, **Mixed case field names**. This feature is only available if you are running with the File Manager COBOL compiler or a minimum compiler level of Enterprise COBOL V4R1.

If you do not select this option, field names are stored in uppercase.

- Supply any additional compiler options which will be added via the CBL statement.
- Press the Exit function key (F3) to save the changes you have made and exit the panel.

Related topics

[Set COBOL Processing Options panel \(option 0.5.2\) on page 1016](#)

For details on specifying "From" and "To" strings for the COBOL REPLACE directive, see the *IBM COBOL Language Reference*.

For details on the effect of these compiler options, see the *IBM COBOL Programming Guide for OS/390 & VM*.

Setting your HLASM processing options

When your HLASM copybooks fit into any of the following scenarios, you must set your HLASM processing options so that File Manager can process them correctly.

- You have used DBCS characters in your copybooks.
- You want the DC, DS and DXB instructions to be aligned on the correct boundaries only if the duplication factor is 0.

To set your HLASM processing options:

1. From the Primary Option Menu panel, select **0 Settings**, then **5 Compiler**, and **3 HLASM**.

The HLASM Processing Options panel is displayed.

2. If you have used additional SYSLIBS, enter the names of the data sets in the **Additional SYSLIB data set** fields.

Members included by COPY directives must be found in the SYSLIB concatenation. When you specify a copybook on a File Manager panel to create a new template (or update an existing template), the SYSLIB concatenation consists of the PDS of the copybook, plus up to ten additional PDSs that you can specify on this panel. These PDSs are searched in order (PDS of the copybook, followed by these additional PDSs, 1–10.)



Note: CA-Panvalet libraries cannot be specified as additional SYSLIB sets. Further, if a CA-Panvalet Library is the main copybook library, then no additional SYSLIB data sets may be specified.

3. If your copybook contains DBCS characters, select the **DBCS** processing option.
4. If your HLASM copybook is compiled with NOALIGN, then select the **NOALIGN** processing option.
5. Additional compiler options which will be added via the *PROCESS statement.
6. To set the maximum acceptable return code for a compile, enter a value in the **Maximum Return Code to be accepted from compiler** field.

When using the online panels to generate a template from a copybook, if the compiler returns a warning/error code greater than the specified number, File Manager displays a pop-up menu in which you can make decisions about further processing.

When generating a template during the processing of a batch function, if the compiler returns a warning/error code greater than the specified number, File Manager halts the running of the function.

7. Press the Exit function key (F3) to save the changes you have made and exit the panel.

Related topics

[Using HLASM copybooks with File Manager on page 184](#)

For details on the effect of these compiler options, see the *HLASM V1R6 Programmer's Guide*.

Setting your PL/I processing options

When your PL/I copybooks fit into any of the following scenarios, you must set your PL/I processing options so that File Manager can process them correctly.

- You have used %INCLUDE directives to include other members that do not belong to the same PDSs as the copybooks.
- You have used DBCS characters in your copybooks.
- Your PL/I copybook contains declarations of 63-bit binary data.
- Your PL/I copybook declarations are not unaligned.
- Your PL/I copybook contains declarations of 31-digit decimal data.

To set your PL/I processing options:

1. From the Primary Option Menu panel, select **0 Settings**, then **5 Compiler**, and **4 PL/I**.

The PL/I Processing Options panel is displayed.

2. If you have used additional SYSLIBS, enter the names of the data sets in the **Additional SYSLIB data set** fields.

Members included by INCLUDE directives must be found in the SYSLIB concatenation. When you specify a copybook on a File Manager panel to create a new template (or update an existing template), the SYSLIB concatenation consists of the PDS of the copybook, plus up to ten additional PDSs that you can specify on this panel. These PDSs are searched in order (PDS of the copybook, followed by these additional PDSs, 1–10.)



Note: CA-Panvalet libraries cannot be specified as additional SYSLIB sets. Further, if a CA-Panvalet Library is the main copybook library, then no additional SYSLIB data sets may be specified.

3. If your copybook contains DBCS characters, select the **GRAPHICS** processing option.
4. If your copybook contains signed 64-bit binary data fields, select the **63 bit binary** processing option.
5. If your copybook declarations are not aligned, select the UNALIGNED option.
6. If your copybook contains declarations of 31-digit decimal data, select the 31 digit decimal processing option.
7. Additional compiler options which will be added via the *PROCESS statement.
8. To set the maximum acceptable return code for a compile, enter a value in the **Maximum Return Code to be accepted from compiler** field.

When using the online panels to generate a template from a copybook, if the compiler returns a warning/error code greater than the specified number, File Manager displays a pop-up menu in which you can make decisions about further processing.

When generating a template during the processing of a batch function, if the compiler returns a warning/error code greater than the specified number, File Manager halts the running of the function.

9. Press the Exit function key (F3) to save the changes you have made and exit the panel.

Related topics

[Set PL/I Processing Options panel \(option 0.5.4\) on page 1024](#)

For details on the effect of these compiler options, see the *IBM VisualAge PL/I for OS/390 Programming Guide*.

Overriding Compiler Options

The current compiler options are stored in a template at the time the template is created. This allows subsequent updating of templates to be performed using the original compiler options.

To override the compiler options stored in a template:

1. Select the **Compiler Language Selection** option from the **Options** pull-down menu.

File Manager displays the Compiler Language Selection panel.

2. Select the **Override compiler options for template update** option.

Using this option causes the template update to override the compiler options stored in the template with the currently specified compiler options. It also ensures the generation of the compiler parameters for the Batch JCL generated when the **Batch execution** option is selected.



Note: If the template does not contain compiler options, then the compiler options used are those currently specified for the execution or the relevant defaults.

Related topics

[Template Update Utility panel on page 1066](#)

Determining the search order for your copybooks

The **Preserve copybook library** option allows you to determine the search order File Manager uses when looking for a specified copybook.

To determine the search order for your copybooks:

1. Select the **Compiler Language Selection** option from the **Options** pull-down menu.

File Manager displays the Compiler Language Selection pull-down menu.

2. Select the **Preserve copybook library** option.

Selecting this option causes the template update to attempt to locate the copybook in the data set in which it was originally found.

Not selecting this option, or if the copybook cannot be located, causes the template update to search the library data sets in order for the first occurrence of the copybook.

The option only applies to template update.

You can also access the **Preserve copybook library** option on the Compiler Language Selection panel.

Related topics

[Template Update Utility panel on page 1066](#)

[Compiler Language Selection panel on page 788](#)

Specifying or updating the source definition for a copybook template

The following sections describe how to specify or update the source definition for single and advanced copybook source definitions

Single copybook source definitions

- **Function entry panels:**

Specify the data set name and member name in the **Copybook or Template** section for the copybook you require.



Note: You can enter a generic member name to display a member list.

Select the process option **1. Above** to use the copybook with the function. To edit the copybook template prior to the function, select the **Edit template** option and ensure you do *not* specify S for **Type**.

- **Workbench (Option 7.1):**

Specify the data set name and member name in the **Copybook** section and issue the command you require *without* the **Advanced copybook selection** option selected.



Note: The CM and MT commands refer to a template only. The E command only refers to the copybook if the template data set and member name are blank.

Advanced copybook source definitions

- **Function entry panels:**

Specify the **Copybook or Template** data set name and member name with either an existing template or copybook member and select the **Edit template** option with **Type** set to S. This takes you to the advanced copybook selection panels which allow you to change the source definitions and create a new template or update an existing template.

- **Workbench:**

Select the option **Advanced copybook selection** and use the CC command with a copybook data set name and member name to create a new template, or the U prefix command with a template data set name and member name to update the source definition for an existing template.



Note: You can also use the E command with the copybook data set name and member name, provided the template data set and member names are left blank.



Note: See [Advanced copybook selection on page 208](#) for a description of what you can do when specifying advanced copybook source definitions for templates.

If the **Edit template** option is used from a function entry panel with a copybook source definition, you are prompted to provide a template data set name (and, for partitioned data sets, a member name) to save the template that has just been created. Templates can be stored in sequential, PDS or PDSE data sets only.

Related topics

- [Field Selection/Edit panel on page 891](#)
- [Record Type Selection panel on page 998](#)
- [Template Save pop-up panel on page 1070](#)
- [SAVE primary command on page 1215](#)
- [SAVEAS primary command \(templates\) on page 1216](#)
- [END primary command on page 1148](#)

Advanced copybook selection

This section describes the method for specifying an advanced copybook source definition. To navigate to the panels mentioned, see [Advanced copybook source definitions on page 207](#).

1. The Library List panel is displayed as the initial panel when creating a new template. You can display this panel with the LIBLIST command from the Copybook Selection panel.

You can specify up to 12 data set libraries. The data sets may be PDSs, PDSEs, CA-Panvalet libraries, or other library management system libraries. You can specify multiple PDSs, PDSEs, CA-Panvalet and other library management system libraries but they must be either all PDSs or PDSEs, or all CA-Panvalet, or all the same library management system libraries. You cannot mix library types.

2. Press the Exit function key (F3). The Copybook Selection panel is displayed initially for new templates where the member has not been supplied (after the Library List panel), for new templates where a generic member name was specified on the Copybook section, or when the U prefix command was specified with a template data set name and member name to update the source definition for an existing template.
3. Type an "S" in the **Sel** field for each member that you want to select.

You can browse (B), edit (E), or view (V) each of the members on this list before selecting the ones you want.

**Note:**

- a. All members must contain copybook definitions in the same language.
- b. If you specify a member that consists of an entire program, then you should use the X prefix command to specify a statement range to extract the field definitions you are interested in, otherwise you may get compile errors when mixing with other members.
- c. You can only edit members in a PDS or PDSE data set.
- d. Library members may not be packed by ISPF.

4. When you have selected all of the members you want, press the Exit function key (F3). The selected members are listed in the Copybook Selection panel.

From the Copybook Selection panel, you can display (and modify if necessary) the current library list by entering the LIBLIST primary command.

5. Edit the list of members to suit your requirements. You can copy or move members, insert or delete members and create new 01-level fields for any member. You can also specify redefines or range values for a member.

To add a new member:

- a. Enter the I prefix command to insert a new row.
- b. Type an asterisk or member name pattern in the Member field, then press Enter
- c. Select the new member name or names from the list. The list is not affected by any pattern that you have entered on the Template Workbench, it is a new list of all members in all selected databases, filtered by the pattern entered on the Copybook Selection panel.
- d. Press the Exit function key (F3). The selected members are inserted into your list on the Copybook Selection panel.

To create a new 01-level field for a member:

- a. On the Copybook Selection panel, type a Y in the **01** field adjacent to the member.
- b. In the adjacent **Field Name** field, type a name for your 01-level element. This name must follow the naming conventions for the language of the copybook. If the name is omitted, File Manager generates a random name when the template is compiled.

To extract a subset of the copybook to be compiled into the template:

- a. From the Copybook Selection panel, type an X in the **Cmd** field next to the required copybook member to display the Redefines / Range Specifications pop-up panel.
- b. In the **From statement** field, specify the starting line number for the extract.
- c. In the **To statement** field, specify the ending line number for the extract.
- d. In the **From string** field, specify the string that File Manager is to search the copybook for. The first statement that contains the string begins the extract.
- e. In the **To string** field, specify the string that File Manager is to search the copybook for. The first statement that contains the string ends the extract.

See the panel definition for a complete list of the prefix commands available.

6. To generate multiple record layouts for a source that contains more than one record definition within a single level-01 structure:

- a. From the Copybook Selection panel, type an X in the **Cmd** field next to the required copybook member to display the Redefines / Range Specifications pop-up panel.
- b. In the **Level** field, specify the source level value to identify the COBOL REDEFINES or the PL/I UNION clauses for generating new record layouts. File Manager creates a separate record layout for each REDEFINES or UNION clause at the specified level. After the first matching REDEFINES or UNION clause is found, File Manager creates new layouts for the latter and subsequent REDEFINES or UNION clauses for the same level and start location. Header and trailing data items are included in each record layout.



Note: This field is ignored for HLASM compiles.

- c. In the **Field name** field, specify the target field name of the COBOL REDEFINES, PL/I UNION, or HLASM ORG clause, that identifies the COBOL REDEFINES, PL/I UNION, and HLASM ORG statements that are to be used to direct File Manager to create new layouts.

This is an alternative way of identifying COBOL REDEFINES, PL/I UNION, and HLASM ORG statements that require new layouts to be generated. You can specify both **Level** and **Field name** values; File Manager checks both when generating new layouts.

- d. To adjust the offset value for each layout so that the starting location is the REDEFINES, UNION, or ORGfield start location, enter a "/" in the **Set offset** field.

Use this option when your record layouts do not include the header data items in the structure. You can only select this option in conjunction with the previous fields.

- e. **COBOL level change:** This is a COBOL ONLY option which changes the way the **Level** value is processed. If you set this option, every occurrence of the specified **Level** value is changed to '01" before the compile step, irrespective of whether the data item has a REDEFINES clause.

Use this option with care as it may result in incorrect offsets to data items, or compile errors, due to the structure being changed from its intended programmable form.

7. To compile the specified copybooks from the Copybook Selection panel, and either update an existing template or create a new template, use the UPDATE primary command or the U prefix command.
8. To edit an existing template built from the copybooks specified on the Copybook Selection panel, use the EDIT primary command or the E prefix command. If you have made any changes, File Manager compiles the copybooks and updates the template.
9. When your Copybook Selection list is completed, press the Exit function key (F3).

The compiler attempts to create the template for you.

If the compilation is unsuccessful, the Template Not Built pop-up panel is displayed, offering you the following choices:

1. View the compilation listing.

If you select this option, the compilation listing is displayed so that you can determine the cause of the error. When you have finished viewing the listing, press the Exit function key (F3) to return to the Copybook Selection panel, correct the problem, then try to exit the panel again.

2. Abort processing.

Returns you to the Copybook Selection panel, where you can correct the problem, then try to exit the panel again.

3. Retry (recompile copybook)

Attempts to submit the same details again. If the compilation had failed because a member was temporarily unavailable, this may resolve the problem.

4. Retry (with alternate compiler)

Attempts to submit the same details again but with the alternative compiler. If the compilation had failed because the File Manager default compiler was set to the wrong compiler for this copybook language, this may resolve the problem.



Note: This choice does not apply to HLASM.

If the compilation is successful, you are prompted to save it to the template member specified on the Template Workbench panel. If you had supplied a member name pattern or left the **Template: Member** field blank on that panel, the Template Member Selection panel is displayed. You can select a name from this list and press Enter to overwrite the existing selected member, or you can press the Exit function key (F3) and you are prompted to name a new member.

Related topics

[Template types and structure on page 173](#)

[Template Workbench panel on page 1072](#)

[Library List panel on page 923](#)

[Copybook Selection panel on page 810](#)

[LIBLIST primary command on page 1181](#)

[UPDATE primary command on page 1235](#)

[EDIT primary command on page 1147](#)

[Redefines / Range Specifications panel on page 1000](#)

Creating a copybook template with the Template Workbench

To create a copybook template with the Template Workbench:

1. Open the Template Workbench panel by performing either of these actions
 - Select option **7.1** from the Primary Option Menu.
 - Issue the TVIEW primary command on either the View or the Edit panel. If TVIEW is run from an editor session, the Template Workbench contains two additional options: **RC - Run using copybook** and **RT Run using template**.
2. In the **Data set name** field in the **Copybook** section, type the name of the data set in which your copybook is stored.

Copybooks can be stored in PDS, PDSE or CA-Panvalet libraries. Library members may not be packed by ISPF.
3. If you know it, type the Member name of the copybook into the relevant field or specify blanks or a pattern for the member name to have a member selection list displayed. You can then select the required member from the list.
4. In the **Data set name** field in the **Template** section, type the name of an existing data set, into which you want the new template to be saved.

Templates can be stored in PDS or PDSE data sets but not in a CA-Panvalet library, or a library accessed using the Library Management System Exit.

5. In the **Member** field of the **Templates** section, type the name for your new template.

If you want to copy the copybook to an existing template (which overwrites the existing template), specify an existing member name or specify blanks or a pattern to display the Member Selection panel. You can then select the required member from the list.

6. On the **Command Line**, type the `cc` command and press Enter.

File Manager validates the copybook by compiling it with your default compiler and, if successful, generates and saves the template. A message is displayed in the upper right corner of the panel, to indicate the success or failure of the process.



Note: If you do not provide a template data set name, File Manager creates a temporary template, which you can then edit. Before you close the Template Workbench, you can save the template by specifying a template name and entering the SAVE command. Otherwise the template is discarded.

Related topics

[Template Workbench panel on page 1072](#)

Setting up a template to be used with segmented data

Templates that contain more than one record type can be set to be used with segmented data by entering a `/` in the **Template for segmented data** field.

When you are viewing or editing data using a segmented data template, the following restrictions apply to template editing:

- You cannot update the **Template for segmented data** field in the Record Type Selection panel (accessed with the TEDIT command).
- You cannot change the Record Identification Criteria, Related Identification Criteria, or Selection Criteria set in the Field Selection/Edit panel (accessed with the TEDIT command and then the E command on the Record Type).
- You cannot use the TVIEW command (which would otherwise display the Template Workbench, allowing you to select or create a different template).
- The length of a segment is calculated as the length of the matching structure, unless you provide a length field. Any binary or alphanumeric field less than 4 bytes in length can be set as the length field by editing the field attributes. If a length field is provided, then File Manager uses the binary value provided as the segment length and adjusts the structure length accordingly.

You can choose to specify record type definitions that do not contain any Record Identification Criteria. If File Manager cannot match a segment (using Record Identification Criteria) with any of the other record types, it uses the first record type without any Record Identification Criteria, whose length is less than or equal to the remaining length on the record, as a default segment.

Creating a template from a model template

You can use the Template Workbench to create copies of an existing copybook or dynamic template. The original template serves as a model, providing template information such as record selection criteria that you can then edit in the new copy.

To create a template from an existing (model) template:

1. Open the Template Workbench panel by performing either of these actions
 - Select option **7.1** from the Primary Option Menu.
 - Issue the TVIEW primary command on either the View or the Edit panel. If TVIEW is run from an editor session, the Template Workbench contains two additional options: **RC - Run using copybook** and **RT Run using template**.

2. In the **Data set name** field in the **Model Template** section, type the name of the data set in which your existing template is stored.

Templates can be stored in PDS or PDSE data sets but not in a CA-Panvalet library, or a library accessed using the Library Management System Exit.

3. If you know it, type the Member name of the template into the relevant field or specify blanks or a pattern for the member name to have a member selection list displayed. You can then select the required member from the list.
4. In the **Data set name** field in the **Template** section, type the name of an existing data set, into which you want the new template to be saved.

Templates can be stored in PDS or PDSE data sets but not in a CA-Panvalet library, or a library accessed using the Library Management System Exit.

5. In the **Member** field of the **Templates** section, type the name for your new template.

If you want to copy the template model to another existing template (which overwrites the existing template), specify an existing member name or specify blanks or a pattern to have a member selection list displayed. You can then select the required member from the list.

6. On the **Command Line**, type the `CM` command and press Enter.

File Manager generates and saves the template. A message is displayed in the upper right corner of the panel, to indicate the success or failure of the process.



Note: If you do not provide a template data set name, File Manager creates a temporary template, which you can then edit. Before you close the Template Workbench, you can save the template by specifying a template name and entering the SAVE command. Otherwise the template is discarded.

Related topics

[Template Workbench panel on page 1072](#)

Creating dynamic templates

You create dynamic templates by building field definitions for your data set or by converting an existing copybook template to a new dynamic template.

Creating dynamic templates on the fly

When you create a dynamic template, for each field definition you build, you specify the field definition details and, optionally, selection criteria that File Manager uses to filter records. When you specify selection criteria for a field, you do not necessarily have to supply all the field definition details as File Manager supplies default values.

When you are building the definitions *without* selection criteria, you must supply the starting column, length and type of the data set fields that you wish to operate upon.

When you are building the definitions *with* selection criteria, you must supply the starting column and value for the data set fields that you wish to operate upon. If you do not supply the length of a field, File Manager calculates it from the value you specify. Similarly, if you do not supply the data type or operator for a field, File Manager uses default values.

In either case, you can, optionally, supply your own field name to identify the information.

You can edit these field definitions at any time.



Note: If you define a field with a type of VC (varying character), VG (varying graphic), or VD (varying DBCS), without also defining a 2-byte binary field immediately preceding it, when generating the template, File Manager reduces



the length of the field you have defined by 2 bytes and inserts a 2-byte binary length field with the field name, LEN, immediately before it.

1. In the **Copybook/template usage** field of any relevant panel, select option **4. Create dynamic** and press Enter.

The Dynamic Template panel is displayed.

2. For each field in the data set that you want to display *without* specifying selection criteria:
 - Specify values in the **Start**, **Length**, and **Type** fields.
3. For each field in the data set that you want to display and for which you want to specify selection criteria:
 - Specify a value in the **Start** field.
 - Specify a value in the **Value** field.
 - Optionally, specify a value in the **Length** field. If you leave this field blank, File Manager calculates the length from the value you specify in the **Value** field.
 - Optionally, specify a value in the **Type** field. (See note above for types VC, VG, and VD.) If you leave this field blank, it defaults to "AN" (alphanumeric).
 - Optionally, specify a value in the **Op** (Operator) field. If you leave this field blank, it defaults to "=".
4. If you wish, specify a Field Name for your field definitions.

If this field is left blank, a name is generated in the form @@DT nn where nn is the field number. Existing field names taking the form @@DT nn are regenerated to ensure that nn always reflects the current field number.



Note: If you are running a screen width of 115 or greater, the Field Name field can be displayed at the same time as the Start, Length and Type fields. However, at any width less than this, you need to toggle the display between Field Name and Start, Length and Type. The default is to display Start, Length and Type. To toggle the display, ensure that your cursor is not in a Value field and press the Right function key (F10) or Left function key (F11).

5. Press the Exit function key (F3). The Template Save pop-up panel is displayed.
6. Type the name of an existing data set in the **Data set name** field.

Templates can be stored in PDS or PDSE data sets, but cannot be stored in CA-Panvalet libraries.

7. Type a name for your new template in the **Member** field.
8. Press the Exit function key (F3). The template is saved and the next relevant panel (depending upon your entry point) is displayed.

Related topics

[Manipulating the display of fields in records on page 225](#)

[Dynamic Template panel on page 845](#)

[Template Save pop-up panel on page 1070](#)

Creating dynamic templates from copybook templates

Instead of building field definitions manually, you can create a new dynamic template using the definitions in a copybook template. Once created, you can edit all aspects of the new dynamic template, including the field definitions.

1. Specify your copybook template on the relevant Entry panel and select the Edit Template option.
2. On the Field Selection/Edit panel, enter `2` to display the **Specify Record Selection by field** panel.
3. Type `MD` on the Command line and press Enter.

The Dynamic Template panel is displayed, containing the list of field definitions generated from your copybook template. You can modify any of these values.



Note: As all field definitions on a dynamic template are treated as Level 2 elementary items, you may need to delete any previous group level fields.

4. Choose one of the following actions:
 - Enter the `SAVE` command and then exit or cancel from the panel.

If you save the dynamic template, you are prompted for a data set and a member name in which to store the new dynamic template.

- Press the Cancel function key (F12) to return to using your copybook template, without saving the dynamic template.
- Press the RunTemp function key (F6) to display your data with the temporary dynamic template (only valid if you have an active editor session).



Tip: The `RunTemp` function key (F6) should not be used with the Template Workbench nor any function which has selected batch execution. Currently, this is not enforced and can lead to unpredictable results.

- Exit from the panel and, when prompted by the Template Save panel, choose to save the template, run with a temporary template or cancel your changes.

You can also create a dynamic template from a copybook template while in an editor session. To do this:

1. Enter `CEDIT` on the Command line of the View or Edit panel. The Record Selection Criteria panel is displayed.
2. Type `MD` on the Command line and press Enter.

The Dynamic Template panel is displayed, containing the list of field definitions generated from your copybook template. You can modify any of these values.

3. Exit from the panel (press F3) and, when prompted by the Template Save panel, choose to save the template, run with a temporary template or cancel your changes.

When working from an active editor session, the following applies:

- When you return to the editor panel, the active copybook template is replaced with the temporary or saved dynamic template.
- If you return to the editor panel using a temporary dynamic template and then exit from the panel, you are not prompted to save the template and it is discarded.
- You can re-edit the dynamic template by entering the `DEDIT` command. This would give you an opportunity to save a temporary template.

Related topics

[CEDIT primary command on page 1128](#)

[DEDIT primary command on page 1142](#)

Creating corresponding templates from selected copybooks

You can create multiple templates from a PDS of copybooks by using the Template Build Utility.

The utility builds one template from each selected copybook. The template name is derived from the input member name and any output member mask that you have specified. If you do not supply a template member mask, then the template name is the same as the copybook name. You can run the Template Build Utility in batch or foreground.

To create multiple templates from a PDS of copybooks:

1. Open the Template Build Utility panel by selecting option **7.3** from the Primary Option Menu.
2. In the Copybook **Data set name** field, specify the data set name of the copybook data set. The name you specify must be a PDS or PDSE, except for vendor-managed library systems such as Panvalet, CA/Librarian, and so on.
3. In the Copybook **Member** field, specify the name of a partitioned data set member that contains a copybook.

If you leave the **Member** field blank, or specify a member name pattern, File Manager displays a member name list. You can then select the required member by entering S in the **Sel** field for the appropriate member.

If you select **Advanced member selection**, then this name constitutes the first name on the member range panel.

4. In the Template **Data set name** field, specify the PDS or PDSE that identifies where the templates are to be stored.
5. In the Template **Member mask** field, optionally specify a pattern to rename members in the output partitioned data set based on the member names in the input partitioned data set.



Note: The **Member mask** works in the same way as the mask you can use when copying data sets. For an explanation of how you can specify a member name mask in the form of a member name pattern, see [Renaming members as you copy on page 346](#).

6. To run the Template Build Utility in batch, select the **Batch execution** processing option.

Batch processing produces up to two reports: the Data Set List report (only produced if a concatenated data set is used for input), and the Template Build Report. Examples of each report are shown below.

Figure 66. Data set list report

Data set name	Lib
FMNUSER.COBOL2	1
FMNUSER.COBOL	2

Figure 67. Template Build report

Template Build Report			
Copybook	Lib	Template	Status
DITTST1	1	DITTST1	Replaced
DITTST3	1	DITTST3	Replaced
DITTST7	1	DITTST7	Compile error
XYZTST1	2	XYZTST1	Created

4 members read : Template : 1 Created 2 Replaced 1 Errors



Note: The **Lib** column is only displayed when more than one input data set is found.

7. To replace templates that exist with the same name, select the **Replace existing templates** processing option.
8. To specify a range of members to be selected, rather than a specific or generic member name, select the **Advanced member selection** processing option.
9. To run without showing the member selection list, select the **Skip member list** processing option. This option is ignored if errors are found (such as duplicate member names due to the rename mask).

Related topics

[Copybook and Template Utility functions panel on page 809](#)

[Template Build Utility panel on page 1056](#)

[Member Selection panel on page 946](#)

Editing a template

You can perform template editing:

- From any panel that has the **Edit template** option.
- From the Template workbench.
- By using the appropriate template primary commands from an editor session.

Template commands from within an editor session may be restricted in function, depending on the type of Edit or View being performed.

- By using the E command from the template update utility member list (option 7.4).

There are two ways to perform a template edit:

- You can select the **Create dynamic** option.
- On panels with the **Edit template** and **Type** options, you can set those options.

These options are ignored for dynamic templates. If you specify **Create dynamic** or edit an existing dynamic template, File Manager always displays the Dynamic Template panel.

Figure 68. Editing a template: task flow

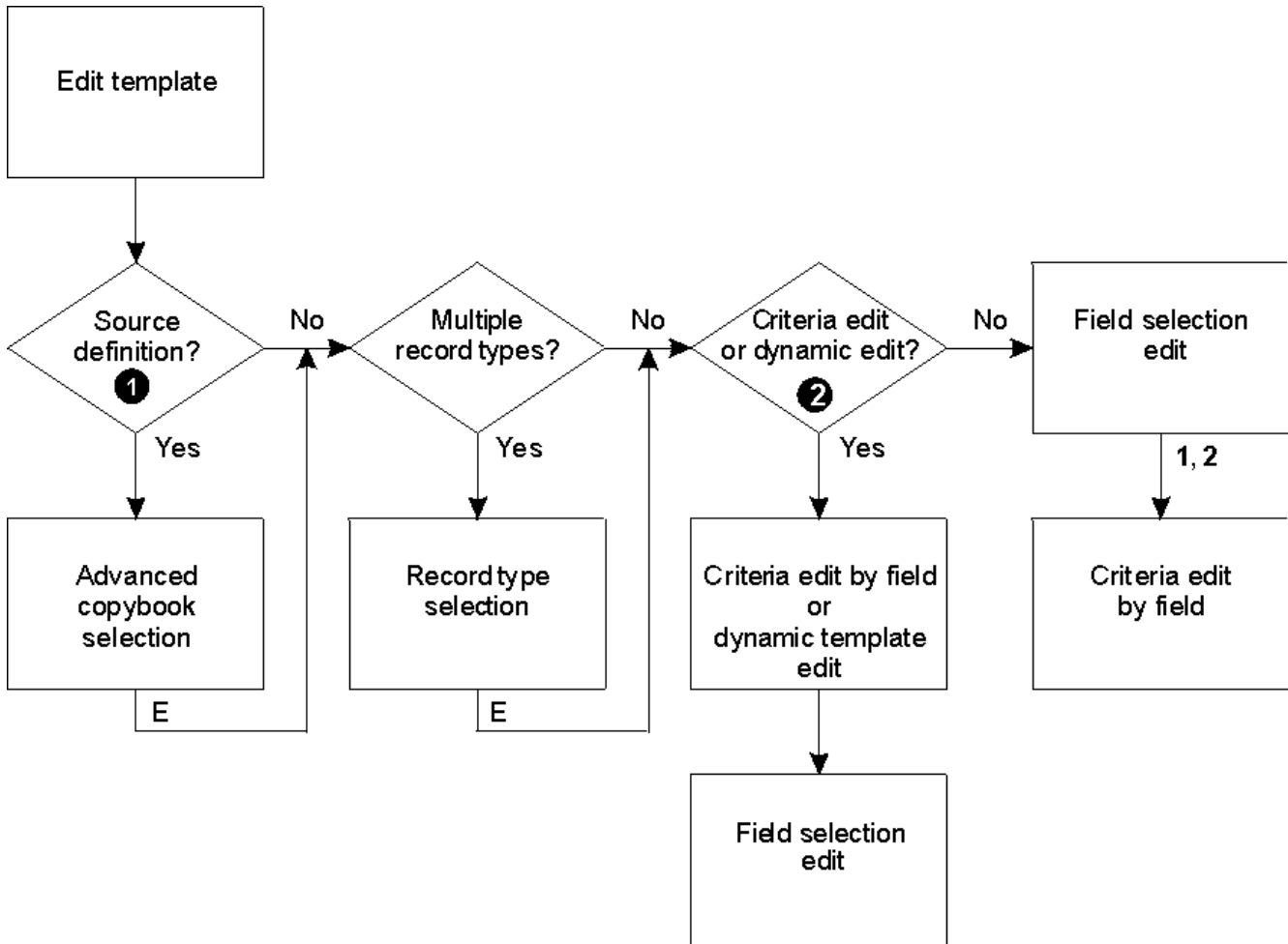

1 Source definition:

- **Type "S"** specified and **Edit template** option selected, or
- CC or U command entered on Template Workbench panel with:
 - **Advanced copybook selection** option selected, or
- E command entered on Template Workbench panel with:
 - Copybook data set name specified, and
 - No template data set name specified, and
 - **Advanced copybook selection** option selected

2 Criteria edit or dynamic edit:

- **Type "1"** or **"2"** specified and **Edit template** option selected, or
- Template is a dynamic template, or
- CE or DE command entered during an editor session

To edit a template from a supported panel:

1. In the **Copybook or Template** section, specify the data set name of a copybook or template.

Templates can be stored in sequential (PS), PDS or PDSE data sets. CA-Panvalet libraries can only be used as input data sets for copybooks.

2. In the same section, specify the Member name or leave the Member name field blank to choose from the list of data set members.
3. Set the **Copybook/template** flag to **Above** or **Create dynamic**.
4. If you did not select **Create dynamic**, select **Edit template** using one of the following options:

/

Edit the specified template. F3 will return to the entry panel and clear this option.

A

Always edit the specified template. When the template edit session is completed, F3 will invoke the current function. F12 will cancel the template edit session and return to the entry panel.

R

Edit the template and use the RUNTEMP command (F6) to invoke the current function. Exiting the function will re-edit the template, allowing you to save the template or re-invoke the edit or view session using RUNTEMP.

Set **Type** to determine the point at which you want to perform template editing:

Blank

Normal record type or field/selection edit for single layout copybooks or templates.

S

To edit the source definition using the advanced copybook selection process.

1

To perform criteria edit by field for identification criteria before the field/selection edit. This provides a fast path when you just want to specify criteria by field.

2

To perform criteria edit by field for selection criteria before the field/selection edit. This provides a fast path when you just want to specify criteria by field.

5. Make the required editing changes and do *one* of the following:

- When you are creating a new template, pressing the Exit function key (F3) displays the Template Save pop-up panel.
- Type SAVE on the Command line and press Enter. You can then choose to make further changes, continue to the next relevant panel or return to your entry panel.
- Type SAVEAS on the Command line and press Enter. Specify the data set (and member name if a PDS) of the new template and press the Exit function key (F3). You can then choose to make further changes, continue to

the next relevant panel or return to your entry panel. The new template is used in place of the original for the current function.

- Press RunTemp function key (F6) to display the next relevant panel using the changes you have made but without saving those changes.
- Press Cancel function key (F12) to return to your entry panel without saving the changes.

To edit an existing copybook template from an editor panel:

1. Type one of the following commands on the Command line and press Enter.

TEdit

Template Edit: If your copybook has only one record type, the Field Selection/Edit panel is displayed. From here, you can enter **1** or **2** to access the Record Identification Criteria or Record Selection Criteria panels.

If your copybook has two or more record types, the Record Type Selection panel is displayed. In the **Command** field adjacent to the record type that you would first like to edit, type an **E** and press Enter. The Field Selection/Edit panel for that record type is displayed.

CEdit (or CEdit SEL or DEdit)

Criteria Edit (Selection): The CE, CE SEL and DE commands are all synonymous in this situation and display the Record Selection Criteria panel, showing the fields in the currently displayed record type. From here, you can enter **1** to access the Field Selection/Edit panel. If your copybook has two or more record types, the Record Type Selection panel displays at this point. In the **Command** field adjacent to the record type that you would first like to edit, type an **E** and press Enter. The Field Selection/Edit panel is displayed.

CE ID

Criteria Edit (Identification): The Record Identification Criteria panel is displayed. From here, you can enter **1** to access the Field Selection/Edit panel. If your copybook has two or more record types, the Record Type Selection panel is displayed at this point. In the **Command** field adjacent to the record type that you would like to edit, type an **E** and press Enter. The Field Selection/Edit panel is displayed.

2. Make the required editing changes and do *one* of the following:

- Press the Exit function key (F3) to save the changes and display the next relevant panel (for example, the View panel). The message "Template saved" appears in the upper right corner of the panel.



Note: Unlike when creating a new template, the Template Save pop-up panel is not displayed at this point. The previous version of the template is automatically replaced by the changes you have made.

- Type SAVE on the Command line and press Enter. You can then choose to make further changes, continue to the next relevant panel or return to your entry panel.
- Type SAVEAS on the Command line and press Enter. Specify the data set (and member name if a PDS) of the new template and press the Exit function key (F3). You can then choose to make further changes, continue to

the next relevant panel or return to your entry panel. The new template is used in place of the original for the current function.

- Press RunTemp function key (F6) to display the next relevant panel using the changes you have made but without saving those changes.
- Press Cancel function key (F12) to return to your entry panel without saving the changes.

To edit an existing dynamic template from an editor panel:

1. Type one of the following commands on the Command line and press Enter.

TE

Template Edit: The Field Selection/Edit panel is displayed. However, you cannot change the Field Name, Start, Length or Type fields from this panel, nor can you change the record selection criteria. To perform these tasks, enter **1** to display the Dynamic Template panel.

DE (or CE, CE SEL or CE ID)

Dynamic Edit: The CE, CE SEL and DE commands are all synonymous in this situation and display the Dynamic Template panel.

2. Make the required editing changes and do *one* of the following:

- Press the Exit function key (F3) to save the changes and display the next relevant panel (for example, the View panel). The message "Template saved" appears in the upper right corner of the panel.



Note: Unlike when creating a new template, the Template Save pop-up panel is not displayed at this point. The previous version of the template is automatically replaced by the changes you have made.

- Type SAVE on the Command line and press Enter. You can then choose to make further changes, continue to the next relevant panel or return to your entry panel.
- Type SAVEAS on the Command line and press Enter. Specify the data set (and member name if a PDS) of the new template and press the Exit function key (F3). You can then choose to make further changes, continue to the next relevant panel or return to your entry panel. The new template is used in place of the original for the current function.
- Press RunTemp function key (F6) to display the next relevant panel using the changes you have made but without saving those changes.
- Press Cancel function key (F12) to return to your entry panel without saving the changes.

Related topics

[Manipulating the display of fields in records on page 225](#)

[Dynamic Template panel on page 845](#)

[Record Type Selection panel on page 998](#)

[Field Selection/Edit panel on page 891](#)

[SAVE primary command on page 1215](#)

[SAVEAS primary command \(templates\) on page 1216](#)

Updating one or more templates

The Template Update Utility allows you to update one or more templates in either foreground or batch.

You can filter template member selection to select only templates that reference a certain copybook or copybooks. You can specify a generic copybook filtering name.

1. Select option **7. Templates** from the Primary Option Menu panel to display the Copybook and Template Utility Functions panel.
2. Select option **4. Update** from the Copybook and Template Utility Functions panel to display the Template Update Utility panel.
3. On the Template Update Utility panel, enter the details to select the templates you want to update:
 - In the Template **Data set name** field, specify a fully-qualified or generic data set name to identify the data set (which must be partitioned).
 - In the Template **Member** field, you can specify the name of a member of a partitioned data set.
 - In the Template **Copybook filter** field, you can specify up to 4 member names or patterns to be used as a filter so that only templates referencing those copybooks, or copybooks that match the member patterns, are selected for processing.
4. In the Output Template **Data set name** field, you can specify a fully-qualified or generic data set name to identify the output data set where the updated templates are to be stored. If you leave this field blank, then the update takes place on the input data set.
5. In the Output Template **Member mask** field, you can specify a rename mask so that the updated templates are stored under an alternative name.
6. Select the processing options:
 - To run the function in batch, select **Batch execution**.
 - To replace like-named members in the output partitioned data set, select **Replace members**.
 - To specify a range of members to be selected, rather than a specific or generic member name, select **Advanced member selection**.
 - To use the library data sets specified on the entry panel select **Use library data sets**.
 - To run without showing the member selection list, select **Skip member list**. This option bypasses the member list panel and processes all the qualifying members. If an error (like a duplicate output name) results from the specified parameters, then the member list panel is displayed with the errors highlighted.
 - To run the function without saving the resulting members, select **Check mode - no update**.
 - If necessary, select the **Preserve copybook library** option to ensure that, if a copybook still exists in the library that it was previously found in and that library is in the list that the update is using, then that version of the copybook is used if:
 - This option is not selected, or
 - The copybook no longer exists in the library it was previously found in, or
 - That library is not in the list the update is using then the utility searches the libraries in the order they are listed and uses the first version of the copybook that it finds.
7. If you have selected the **Use library data sets** option, you can specify up to twelve copybook library names in the Library data sets **Data set name** fields.

The copybook library names referenced in the template are changed to the copybook library names specified in these fields. The new library data sets are used to locate and compile the copybooks during the update process, so you need to ensure that all the copybooks referenced in all the templates selected are available in the libraries you specify to avoid update errors occurring.

8. Press Enter. Unless you have selected the **Skip member list** processing option, File Manager displays a member list of templates like those shown in [Figure 69: Member list of templates on page 225](#).

Figure 69. Member list of templates

<u>P</u> rocess	<u>O</u> ptions	<u>H</u> elp				
File Manager		Template Update Utility			Row 1 of 104	
Input data set 'FMN.RFM0047.TEMPLATE'						
Update data set 'FMN.RFM0047.TEMPLATE'						
Sel	Name	Prompt	Created	Updated	Lang	Ver
—	ABEND		2004/02/11	2004/02/11 09:09:15	COBOL	1
—	BIGCHAR		2004/07/14	2006/06/28 16:12:31	COBOL	1
—	BIGCOPY		2003/12/17	2003/12/17 14:39:16	COBOL	1
—	BIGCOP2		2004/02/11	2004/02/11 10:12:10	COBOL	1
—	BIGKSDS		2001/08/10	2001/08/16 13:54:23	COBOL	1
:						

Press F11 (Right) to scroll right to display the Description column, and F10 (Left) to return to the original display.

9. In the prefix area (**Sel**), type any of the following prefix commands and press Enter to perform the associated action:
 - To browse a template, type the B prefix command. The member is displayed using the ISPF Browse panel (not the File Manager Browse panel).
 - To invoke template editing, type the E prefix command. File Manager invokes template editing.
 - To invoke the template source definition edit and interactive update process for the template, type the U prefix command. File Manager displays the Copybook Selection panel.
 - To select a template for updating, type the S prefix command. File Manager saves the updated template.

Related topics

[Copybook and Template Utility functions panel on page 809](#)

[Template Update Utility panel on page 1066](#)

Manipulating the display of fields in records

File Manager offers a number of ways to manipulate how fields are displayed within records. Using the Field Selection/Edit panel, you can:

- Select fields
- Change the order in which fields are displayed
- Change field headings
- Access the Field Attributes panel to change individual field attributes
- Access the Date/Time Attributes panel to define and change the attributes for a field used to hold date and time values

Selecting and deselecting fields

You can change the display of a record type to show selected fields only, for display and printing purposes. If you select fields, then only those fields are displayed or printed. If you do not select fields, then File Manager displays or prints all fields.

To select or deselect individual fields:

1. Edit your copybook or dynamic template in the Field Selection/Edit panel.
2. In the **Cmd** field adjacent to the field to be selected, type `s` and press Enter.

The **SHE** column displays an "S" and the line becomes highlighted. For example, in [Figure 70: Field Selection/Edit showing selected fields on page 226](#), the REC-TYPE and NAME fields are selected.

Figure 70. Field Selection/Edit showing selected fields

```

:
-----
File Manager                Field Selection/Edit

1 Specify Record Identification by field.
2 Specify Record Selection   by field.

Cmd Seq SHE Ref Rdf Field Name                               Type  Start Length
-----
          1      1 REC-TYPE01                               AN     1     80
--- --- S      2      2 REC-TYPE                           AN     1     2
--- --- S      3      2 NAME                               AN     3    20
          4      2 EMPLOYEE-NO                               BI    23     2
-----
----- Record Identification Criteria -----
:

```

3. To remove the selection status, type the `s` command in the **Cmd** field adjacent to a selected field. If you remove the selection status from all fields in the record type, File Manager reverts to its default behavior, which is to display or print all fields.

You can toggle between selecting and deselecting more than one line at a time by entering one of the following selection commands:

SS

Selects and deselects a block of lines.

Enter SS twice: first in the **Cmd** field at the start of the block you want to select or deselect, and second, at the end of the block. File Manager toggles the selection status of each line in the selected block.

Sn

Selects and deselects *n* lines.

Enter *Sn* in the **Cmd** field of the first line you want to select or deselect. File Manager toggles the selection status of each line, starting from the first line selected for *n* lines.

S*

Selects and deselects a block of lines, starting from the first line selected and then all subsequent lines.

Enter **S*** in the **Cmd** field of the first line you want to select or deselect. File Manager toggles the selection status of each line, starting from the first line selected to the last line.

Related topics

[Field Selection/Edit panel on page 891](#)

[Editing a template on page 218](#)

Changing the field display order

By default, fields are displayed in the order in which they occur in the data set. However, by entering numbers in the **Seq** field (on the Field Selection/Edit panel), you can override this order.

Any fields with sequence numbers are displayed before fields without sequence numbers. Fields with sequence numbers are displayed in the relative order of the sequence numbers. Sequence numbers do not need to start at 1, or be consecutive. The remaining fields (without sequence numbers) are displayed in their default order.

Holding fields on the display when scrolling

You can hold fields so that they are always displayed regardless of how far you scroll.

To hold a field, enter **H** in the **Cmd** field.

When you hold a field, “H” appears in the middle position of the **SHE** column on the Field Selection/Edit panel, and “1” appears in the **Seq** column to show it is the first held field. If you hold a second field, “2” appears in the **Seq** column to show it is the second held field, and so on. The sequence numbers of held fields are independent of any other sequence number you might add.

In TABL display format, held fields always appear as the leftmost fields on the screen (in the order that you held them when editing the template). Held fields take priority, as far as the left-to-right display is concerned, over other fields.

In SNGL display format, held fields always appear as the topmost fields on the screen (in the order that you held them when editing the template). Held fields take priority, as far as the top-to-bottom display is concerned, over other fields.

Toggling the hold status of more than one field at a time

You can toggle between holding or “freeing” more than one field at a time by entering one of the following hold commands in the **Cmd** field of the Field Selection/Edit panel:

HH

Holds or “frees” a block of fields.

Enter **HH** twice: first in the **Cmd** column at the start of the block of fields you want to hold or “free”, and again at the end of the block. File Manager toggles the hold status of each field in the selected block.

Hn

Holds or “frees” *n* fields.

Enter *Hn* in the **Cmd** field of the first field you want to hold or “free”. File Manager toggles the hold status of each field, starting from the first selected field and continuing for *n* fields.

Changing field headings

By default, File Manager uses the field names (from your original copybook or from your dynamic template) as field headings in SNGL and TABL display format. You can override this by specifying your own field headings.

To change the field heading:

1. Enter the **E** (edit) line command in the Cmd field adjacent to the field that you want to rename.
2. Enter the new field heading in the **Heading** field on the Field Attributes panel.
3. Press the Exit function key (F3) to save your change and return to the Field Selection/Edit panel.
4. Repeat for all field headings you want to change.

The field heading may determine the width of the display column. The default output width is the maximum of the number of characters needed to show the field heading (or field name, if no heading is specified), and the number of characters needed to show the value of the field. The following figures demonstrate how changing a field heading can change the display width of the field.

Figure 71. Data set displayed using default field names

```

:
REC-TYPE NAME                EMPLOYEE-NO    AGE    SALARY    MONTH(1)
#2      #3                    #4      #5      #6      #7
AN 1:2  AN 3:20                BI 23:2 BI 25:2 PD 27:4    BI 31:4
<>      <-----1----->    <----> <----> <----> <---->
****  Top of data  ****
01      Grant Smith                7712    35     75000    6
01      Andrew Apple                6645    53     78500    30
:
    
```

Figure 72. Data set displayed using field headings

```

:
Type    NAME                Emp #    AGE    SALARY    Mth(1)    Mth(2)
#2      #3                    #4      #5      #6      #7      #7
AN 1:2  AN 3:20                BI 23:2 BI 25:2 PD 27:4    BI 31:4    BI 35:4
<>      <-----1----->    <----> <----> <----> <----> <---->
****  Top of data  ****
01      Grant Smith                7712    35     75000    6         15
01      Andrew Apple                6645    53     78500    30        22
:
    
```



Note: While the width of the Employee-No field has reduced, the width of the Month column has not changed. This is because the Month field has a Type of BI and Length of 4. The maximum value that can be entered into a field of



this type has 9 digits, therefore, the default output width is 9 characters. To reduce the width of the Month fields, you would need to modify the field attributes.

Changing field attributes

Field formatting attributes, such as the width of a field for TABL formatting or leading zero suppression for numeric fields, can be changed on the Field Attributes panel. You can also specify data create attributes on this panel. The panel comes in two flavors: one for alphanumeric fields and the other for numeric fields.

Selecting a field for attribute change

You select a field from the Field Selection/Edit panel ([Figure 243: Field Selection/Edit panel on page 892](#)). To select a record for attribute change, enter **E** in the **Cmd** field adjacent to the required field. You can enter E against as many fields as you like. For each field you select, File Manager displays a Field Attributes panel.

The attributes you can change are:

- Output width
- Whether to display or suppress leading zeros on numeric fields
- Values to use for creating new records

The attributes are used to determine how to display or print a field.

Changing the attributes for an alphanumeric field

You use the alphanumeric Field Attributes panel to change attributes for an alphanumeric field or set the pattern for created fields.

To change the output width, enter the new width into the **Output width** field.

The output width is the number of character positions used by edit, view, and print panels to show the field in TABL display or print format. The default output width is the maximum of the number of characters needed to show the field heading (or field name, if no heading is specified), and the number of characters needed to show the value of the field, as determined from the field definition.

The minimum width allowed is six characters. The maximum is 30 or the field width + 10 (whichever is the greater).

You can set any field less than 4 bytes long to be the length field during a segmented template edit. You can specify the length as inclusive or exclusive. If a non-blank value is provided, then the segment length is determined from the binary value contained in the field, and for exclusive fields the field length is added to this value.

Changing the attributes for a numeric field

You use the numeric Field Attributes panel to change attributes for a numeric field or set the pattern for created fields.

To change the output width, enter the new width into the **Output width** field. The output width is the number of character positions used by edit, view, and print panels to show the field in TABL display or print format. The default output width is the maximum of the number of characters needed to show the field heading (or field name, if no heading is specified), and the number of characters needed to show the value of the field, as determined from the field definition, including a sign character and decimal point.

The allowable widths are six to 30 characters.

To display leading zeros on numeric fields in SNGL and TABL display format, enter YES in the **Leading zeros** field. The default is NO (suppress leading zeros).

The following figure demonstrates how field headings and output widths affect the column width display.

Figure 73. Data set displayed using field headings and output width adjustment

```

:
Type   NAME                Emp #    AGE    SALARY Mth(1) Mth(2) Mth(3)
#2     #3                    #4      #5     #6     #7     #7     #7
AN 1:2 AN 3:20            BI 23:2 BI 25:2 PD 27:4 BI 31: BI 35: BI 39:
<>    <-----1-----> <----+> <----+> <-----+> <----+> <----+> <----+>
****  Top of data  ****
01    Grant Smith      7712    35     75000    6     15     42
01    Andrew Apple    6645    53     78500    30    22     46
:

```

You can set any field less than 4 bytes long to be the length field during a segmented template edit. You can specify the length as inclusive or exclusive. If a non-blank value is provided, then the segment length is determined from the binary value contained in the field, and for exclusive fields the field length is added to this value.

Displaying alphanumeric fields in long hexadecimal

You can change the display of any alphanumeric field using the X, XX, X*, and Xn prefix commands. When you use the X prefix command, the type for the field toggles between AN and AX.

When you change the type to AX, the fields are displayed or printed in long hexadecimal format (as opposed to character format).

Figure 74. Field Selection/Edit panel showing VEHICLE-TYPE flagged to display in long hexadecimal mode

Process		Options		Help		
File Manager		Field Selection/Edit		Line 1 of 33		
----- Criteria - Enter 1 or 2 to specify expression by field -----						
1	Id :					+
2	Sel:	(#3='Toyota') & (#7>1997)				+
Offset		0				
Cmd	Seq	SHE	Ref	Field Name	Picture	Type Start Length
**** Top of data ****						
---	---		1	1 VEHICLE-REC		AN 1 8475
---	---		2	2 VEHICLE-TYPE	X	AX 1 1
---	---		3	2 VEHICLE-MAKE	X(20)	AN 2 20
---	---		4	2 VEHICLE-MODEL	X(20)	AN 22 20
---	---		5	2 MODEL-CODE	X(6)	AN 42 6
---	---		6	2 VEHICLE-SUB-MODEL	X(20)	AN 48 20
---	---		7	2 YEAR-OF-MANUFACTURE	9(4)	ZD 68 4
---	---		8	2 NUMBER-ADVERTISED	9(4)	ZD 72 4
---	---		9	2 FOR-SALE OCCURS 1 TO 100 TIMES DEPENDING ON NUMBER-ADVERTISED		AN 76 84
---	---		10	3 REGO-NUMBER	X(8)	AN 76 8
Command ==>						
F1=Help	F2=Split	F3=Exit	F4=Expand	F5=RFind	F6=RunTemp	Scroll CSR
F7=Up	F8=Down	F9=Swap	F10=Left	F11=Right	F12=Cancel	

Defining and changing date and time attributes

Attributes relating to a field used to store date and time values can be defined and changed on the Date/Time Attributes panel. This panel allows you to:

- Specify the format in which the date and time value is stored.
- If necessary, define an alternate data type to be used for processing of the date and time value.
- Define the format used to display the date and time value.

You can also specify data create and scrambling options on this panel.

Selecting a field for date and time attribute definition or change

You select a field from the Field Selection/Edit panel (Figure 243: Field Selection/Edit panel on page 892). To select a field for date and time attribute definition or change, enter DT in the Cmd field adjacent to the required field. You can enter DT against as many fields as you like. For each field you select, File Manager displays a Date/Time Attributes panel.

The attributes you can define or change are:

- Internal format used to store the date and time value
- Alternate data type used for date and time processing
- Output format used to display the date and time value
- Values used when creating new records and modifying copied records
- Options for scrambling the date and time values from copied records

The Date/Time Attributes panel

The **Format** field in the **Internal Attributes** section of the panel is used to specify the format in which a date and time value is stored in the field. The format value can be a string containing picture characters supported by the Language Environment® date and time callable services. For example if an 8 byte, external decimal field is used to store a date in the form of a 4 digit year value followed by a 2 digit month value followed by a 2 digit day value you would specify the format string as:

```
YYYYMMDD
```

You can also enter one of the following formats supported by File Manager:

CENTSECS

Time of day in hundredths of seconds.

CBLDATE

COBOL date (the number of days since 31 December 1600)

CYYDDD

Julian date with C as the century indicator (0 = 1900s, 1 = 2000s)

LILDATE

Lilian date (the number of days since 14 October 1582)

LILTIME

Date and time stored as the number of seconds since 00:00:00 14 October 1582.

MICSECS

Time of day in millionths of seconds.

MILLSECS

Time of day in thousandths of seconds.

STCK

Date and time stored as a TOD clock value.

STCKE

Date and time stored as an extended TOD clock value.

The **Type** field in the **Internal Attributes** section of the panel allows you to specify a data type that differs from that defined in the field attributes. This is used when the field data type is not appropriate for the processing of the date and time value. For example if an alphanumeric field is used to store microsecond time values **BI**(binary) can be entered in the **Type** field to ensure File Manager performs valid processing of the time values. The **Format** field in the **Output Attributes** section of the panel allows you to specify the format used to display the date and time values for this field. You enter the format as a string containing picture characters supported by the Language Environment® date and time callable services. For example to display a date value as a string showing a 3 character day-of-week, a 3 character month, 2 digits for the day of the month, and 4 digits for the year you could specify the format string as:

Www Mmm DD, YYYY

When File Manager displays a date and time field in formatted mode, the output width for the field is set to the length of the specified output format.

Managing templates with the Template Workbench

The Template Workbench is a centralized area in which you can work directly with templates, independently from specific data sets. You can use this area to create, edit or update copybook templates. You cannot create dynamic templates in this area, however, you can edit existing dynamic templates.

Editing a template (E)

To edit a template:

1. In the **Data set name** field in the **Template** section, type the name of the data set in which your existing template is stored.

Templates can be stored in PDS or PDSE data sets but not in a CA-Panvalet library, or a library accessed using the Library Management System Exit.

2. If you know it, type the Member name of the template into the relevant field or specify blanks or a pattern for the member name to have a member selection list displayed. You can then select the required member from the list.
3. On the Command line, type the `E` command and press Enter.

File Manager displays the Field Selection/Edit panel. (See [Field Selection/Edit panel on page 891](#) for information about the fields, primary and prefix commands available on that panel.)



Note: If you do not provide a template data set name, but have entered the details of a copybook, File Manager creates a temporary template to edit and use to view data. Before exiting the current panel, you can save the template by specifying a template name and entering the SAVE command. Otherwise the template is discarded.

Editing related ID criteria

When you are working with segmented records with related ID criteria (that is, the ID criteria for a segment layout resides in another segment earlier in the physical record), you can edit the related ID criteria in the template as follows:

1. In the **Data set name** field in the **Template** section of the Template Workbench panel, type the name of the data set in which your existing template for segmented data is stored.

Templates can be stored in PDS or PDSE data sets but not in a CA-Panvalet library, or a library accessed using the Library Management System Exit.

If you know it, type the Member name of the template into the relevant field or specify blanks or a pattern for the member name to have a member selection list displayed. You can then select the required member from the list.

```

:
Template:
  Data set name . 'FMN.RFM0569.PDSE'
  Member . . . . TEMPLB1
:
    
```

2. On the Command line, type the **E** command and press Enter.

File Manager displays the Record Type Selection panel which lists each of the level-01 layouts in the template.

```

  Process  Options  Help
-----
File Manager                Record Type Selection                Line 1 of 9
Processing Option:  Template for segmented data
Cmd SIE Field Name                Prompt  Offset Length
**** Top of data ****
___ S  HEADER-01                    0      20
___ S  HEADER-02                    0      20
___ S  HEADER-03                    0      20
___ S  DETAIL-0101                  0      30
___ S  DETAIL-0102                  0      30
___ S  DETAIL-0103                  0      30
___ S  DETAIL-0201                  0      30
___ S  DETAIL-0202                  0      30
___ S  DETAIL-0203                  0      30
**** End of data ****

Command ==>
F1=Help      F2=Split    F3=Exit     F4=CRetriev F5=RFind    F6=RunTemp
F7=Up        F8=Down    F9=Swap     F12=Cancel
    
```

3. Select (if currently unselected) the **Template for segmented data** option.

4. Type the **E** prefix command in the **Cmd** field against the layout for which you want to specify related ID criteria (but which is held in another segment).

```

  Process  Options  Help
-----
File Manager                Record Type Selection                Line 1 of 9
Processing Option: / Template for segmented data
Cmd SIE Field Name                Prompt  Offset Length
**** Top of data ****
___ S  HEADER-01                    0      20
___ S  HEADER-02                    0      20
___ S  HEADER-03                    0      20
E___ S  DETAIL-0101                  0      30
___ S  DETAIL-0102                  0      30
___ S  DETAIL-0103                  0      30
___ S  DETAIL-0201                  0      30
___ S  DETAIL-0202                  0      30
___ S  DETAIL-0203                  0      30
**** End of data ****
:
    
```

5. Press Enter.

File Manager displays the Field Selection/Edit panel showing the selected layout.

Process		Options		Help		
File Manager		Field Selection/Edit		Line 1 of 6		
---Criteria - Enter 0 - Related ID expression, 1 or 2 - expression by field---						
0	Rid:					+
1	Id :					+
2	Sel:	0				+
Offset		0		Enter "/" to OR with related ID		
Cmd	Seq	SHE	Ref	Field Name	Picture	Type Start Length
				**** Top of data ****		
---	---		1	1 DETAIL-0101		AN 1 30
---	---		2	2 SUBTYPE-FIELD		AN 1 9
---	---		3	3 SUBTYPECONST	X(7)	AN 1 7
---	---		4	3 TYPEREC	X(2)	AN 8 2
---	---		5	2 DETAILTEXT01		AN 10 21
---	---		6	3 DETAIL01-01	X(21)	AN 10 21
				**** End of data ****		
Command ==>				Scroll CSR		
F1=Help	F2=Split	F3=Exit	F4=Expand	F5=RFind	F6=RunTemp	
F7=Up	F8=Down	F9=Swap	F10=Left	F11=Right	F12=Cancel	

**Note:**

- The **0 Rid** line at the top of the panel is blank (unless you have previously specified a related ID expression).
- The ability to OR the identification criteria with related ID by selecting the processing option.

6. To enter or edit a related ID expression, type 0 (zero) on the command line and press Enter.

For the selected layout, File Manager displays the RID Selection panel listing the other level-01 layouts in the template.

Process		Options		Help	
File Manager		RID Selection for DETAIL-0101		Line 1 of 8	
E against layouts to specify related id criteria					
Cmd	SIE	Field Name		Prompt	Offset Length
		**** Top of data ****			
---	SI	HEADER-01			0 20
---	SI	HEADER-02			0 20
---	S	HEADER-03			0 20
---	SI	DETAIL-0102			0 30
---	S	DETAIL-0103			0 30
---	S	DETAIL-0201			0 30
---	S	DETAIL-0202			0 30
---	S	DETAIL-0203			0 30
		**** End of data ****			
Command ==>				Scroll CSR	
F1=Help	F2=Split	F3=Exit	F4=CRetriev	F5=RFind	F6=RunTemp
F7=Up	F8=Down	F9=Swap	F12=Cancel		

7. Type the E prefix command in the **Cmd** field against the layout in which the related ID criteria are held.

```

:
Cmd SIE Field Name Prompt Offset Length
**** Top of data ****
E S HEADER-01 0 20
S HEADER-02 0 20
S HEADER-03 0 20
S DETAIL-0102 0 30
S DETAIL-0103 0 30
S DETAIL-0201 0 30
S DETAIL-0202 0 30
S DETAIL-0203
:

```

8. Press Enter.

File Manager displays the Related ID expression panel showing the selected layout.

Process		Options		Help			
File Manager		Related Id expression for DETAIL-0101		Line 1 of 7			
----- Criteria - Enter 0 to specify related ID expression by field -----							
0 Rid: _____ +							
Offset 0 Enter "/" to OR with related ID							
Cmd	Seq	SHE Ref	Field Name	Picture	Type	Start	Length
			**** Top of data ****				
---	---	1	1 HEADER-01		AN	1	20
---	---	2	2 ALLGROUP		AN	1	20
---	---	3	3 TYPE-FIELD		AN	1	8
---	---	4	4 TYPECONST	X(6)	AN	1	6
---	---	5	4 TYPEREC	X(2)	AN	7	2
---	---	6	3 HEADERTEXT		AN	9	12
---	---	7	4 HEAD01-TEXT	X(12)	AN	9	12
			**** End of data ****				
Command ==>						Scroll CSR	
F1=Help		F2=Split		F3=Exit		F4=Expand	
F7=Up		F8=Down		F9=Swap		F10=Left	
				F5=RFind		F6=RunTemp	
				F11=Right		F12=Cancel	

 **Note:** The ability to OR the related criteria with other related ID by selecting the processing option.

9. On the **0 Rid** line at the top of the Related ID expression panel, specify (or edit) the related ID expression. Alternatively, type 0 (zero) on the command line and press Enter to specify the related ID expression by field.

Typically, the related ID expression specifies the field, and the value it contains, in the layout holding the related ID.

```

Process  Options  Help
-----
File Manager      Related Id expression for DETAIL-0101                Line 1 of 7
-----
----- Criteria - Enter 0 to specify related ID expression by field -----
0 Rid: #5='01'
Offset 0          Enter "/" to OR with related ID
Cmd Seq SHE Ref  Field Name          Picture  Type Start Length
-----
          **** Top of data ****
          1 1 HEADER-01          AN      1    20
          2 2 ALLGROUP          AN      1    20
          3 3 TYPE-FIELD          AN      1     8
          4 4 TYPECONST          X(6)    AN      1     6
          5 4 TYPREC            X(2)    AN      7     2
          6 3 HEADERTXT          AN      9    12
          7 4 HEAD01-TEXT        X(12)   AN      9    12
          **** End of data ****

Command ==>
F1=Help      F2=Split      F3=Exit      F4=Expand    F5=RFind     Scroll CSR
F7=Up        F8=Down       F9=Swap      F10=Left     F11=Right    F6=RunTemp
F12=Cancel

```

10. Press the Exit function key (F3) to return to the RID Selection panel.

11. Press the Exit function key (F3) again to return to the Field Selection/Edit panel.

```

Process  Options  Help
-----
File Manager      Field Selection/Edit                Line 1 of 6
-----
---Criteria - Enter 0 - Related ID expression, 1 or 2 - expression by field---
0 Rid: SEG(HEADER-01):#5: TYPREC  ='01'
1 Id :
2 Sel: 0
Offset 0          Enter "/" to OR with related ID
          **** Top of data ****
          1 1 DETAIL-0101          AN      1    30
          2 2 SUBTYPE-FIELD          AN      1     9
          3 3 SUBTYPECONST          X(7)    AN      1     7
          4 3 TYPREC            X(2)    AN      8     2
          5 2 DETAILTEXT01          AN     10    21
          6 3 DETAIL01-01          X(21)   AN     10    21
          **** End of data ****

Command ==>
F1=Help      F2=Split      F3=Exit      F4=Expand    F5=RFind     Scroll CSR
F7=Up        F8=Down       F9=Swap      F10=Left     F11=Right    F6=RunTemp
F12=Cancel

```

You will now see the related ID expression on the **0 Rid** line at the top of the Field Selection/Edit panel.

12. On the **1 Id** and **2 Sel** lines, specify record identification and or selection criteria by field as required.

```

Process  Options  Help
-----
File Manager      Field Selection/Edit                Line 1 of 6
-----
---Criteria - Enter 0 - Related ID expression, 1 or 2 - expression by field---
0 Rid: SEG(HEADER-01):#5: TYPREC  ='01'
1 Id : #4='01'
2 Sel: 0
Offset 0          Enter "/" to OR with related ID
:

```

13. Using **SEGNO()** and **SEGCNT()** functions to identify your segments

The SEGNO and SEGCNT functions provide a mechanism for checking the current segment number being processed and the number of previous occurrences of a particular segment.

SEGNO()

Returns the current segment number.

SEGCNT('01 field-name')

Returns the number of previous occurrences of the segment with 01 field name specified.

The SEGNO and SEGCNT functions can only be specified in a free-format expression.

Example of their usage:

Consider the following sample data, where the first segment can be used to determine the number of following A, B, C, or D segments:

```

:
      Col 1_____ Insert Length 8160_____ Record AT TOP_____ Format CHAR
      ----+-----10----+-----2----+-----3----+-----4----+-----5----+-----6----+-----7--
***** **** Top of data ****
000001 1234AsegBsegBsegCsegCsegCsegDsegDsegDsegDseg
000002 0202BsegBsegDsegDseg
000003 1232AsegBsegBsegCsegCsegCsegDsegDseg
***** **** End of data ****
:

```

The data above can be mapped with the following template:

```

:
File Manager                Record Type Selection                Line 1 of 2
Processing Option: _ Template for segmented data
Cmd SIE Field Name                Prompt   Offset Length
  _e_ SI  **** Top of data ****
  _e_ SI  SEG-HDR                0       4
  _e_ SI  SEG-A                  0       4
  _e_ SI  SEG-B                  0       4
  _e_ SI  SEG-C                  0       4
  _e_ SI  SEG-D                  0       4
      **** End of data ****
:

```

Examine the criteria for each segment.

Header segment `segno() = 1` ensures its always the first segment on the record.

```

:
File Manager                      Field Selection/Edit                      Line 1 of 5
---Criteria - Enter 0 - Related ID expression, 1 or 2 - expression by field---
0 Rid: _____ +
1 Id : segno()=1 _____ +
2 Sel: _____ +
Offset 0 Enter "/" to OR with related ID
Cmd Seq SHE Ref Field Name Picture Type Start Length
      1 1 SEG-HDR          AN      1      4
      2 2 SEG-NUM-A       9      ZD      1      1
      3 2 SEG-NUM-B       9      ZD      2      1
      4 2 SEG-NUM-C       9      ZD      3      1
      5 2 SEG-NUM-D       9      ZD      4      1
      **** Top of data ****
:

```



Note: The segment header contains the number of each of the following segments that occur.

Segment A: note the related expression where we compare the previous occurrences to the value in the header.

```

:
File Manager                      Field Selection/Edit                      Line 1 of 3
---Criteria - Enter 0 - Related ID expression, 1 or 2 - expression by field---
0 Rid: SEG(SEG-HDR):segcnt('seg-a') < #2: SEG-NUM-A _____ +
1 Id : _____ +
2 Sel: _____ +
Offset 0 Enter "/" to OR with related ID
Cmd Seq SHE Ref Field Name Picture Type Start Length
      1 1 SEG-A          AN      1      4
      2 2 SEG-TYPE       X(1)   AN      1      1
      3 2 SEG-DATA       X(3)   AN      2      3
      **** Top of data ****
:

```

```

:
File Manager                      RID Selection for SEG-A                      Line 1 of 4
E against layouts to specify related id criteria
Cmd SIE Field Name Prompt Offset Length
      **** Top of data ****
e SI SEG-HDR          0      4
  SI SEG-B          0      4
  SI SEG-C          0      4
  SI SEG-D          0      4
      **** End of data ****
:

```

Press Enter.

```

:
File Manager      Related Id expression for SEG-A                      Line 1 of 5
----- Criteria - Enter 0 to specify related ID expression by field -----
0 Rid: segcnt('seg-a') < #2                                          +
Offset 0 Enter "/" to OR with related ID
Cmd Seq SHE Ref  Field Name      Picture  Type Start Length
          **** Top of data ****
          1 1 SEG-HDR              AN       1     4
          2 2 SEG-NUM-A          9        ZD      1     1
          3 2 SEG-NUM-B          9        ZD      2     1
          4 2 SEG-NUM-C          9        ZD      3     1
          5 2 SEG-NUM-D          9        ZD      4     1
          **** End of data ****
:

```



Note: We use SEGCNT and compare it to the value in the header to ensure that the number of SEG-A identified is determined by the header value.

SEG-B, SEG-C, and SEG-D are all defined with a similar expression as follows:

```

:
File Manager      Related Id expression for SEG-B                      Line 1 of 5
----- Criteria - Enter 0 to specify related ID expression by field -----
0 Rid: segcnt('seg-b') < #3                                          +
Offset 0 Enter "/" to OR with related ID
Cmd Seq SHE Ref  Field Name      Picture  Type Start Length
          **** Top of data ****
          1 1 SEG-HDR              AN       1     4
          2 2 SEG-NUM-A          9        ZD      1     1
          3 2 SEG-NUM-B          9        ZD      2     1
          4 2 SEG-NUM-C          9        ZD      3     1
          5 2 SEG-NUM-D          9        ZD      4     1
          **** End of data ****
:

```

```

:
File Manager      Related Id expression for SEG-C                      Line 1 of 5
----- Criteria - Enter 0 to specify related ID expression by field -----
0 Rid: segcnt('seg-c') < #4                                          +
Offset 0 Enter "/" to OR with related ID
Cmd Seq SHE Ref  Field Name      Picture  Type Start Length
          **** Top of data ****
          1 1 SEG-HDR              AN       1     4
          2 2 SEG-NUM-A          9        ZD      1     1
          3 2 SEG-NUM-B          9        ZD      2     1
          4 2 SEG-NUM-C          9        ZD      3     1
          5 2 SEG-NUM-D          9        ZD      4     1
          **** End of data ****
:

```

```

:
File Manager      Related Id expression for SEG-D                      Line 1 of 5
----- Criteria - Enter 0 to specify related ID expression by field -----
0 Rid: segcnt('seg-d') < #5
Offset 0          Enter "/" to OR with related ID
Cmd Seq SHE Ref  Field Name      Picture  Type Start Length
          **** Top of data ****
          1 1 SEG-HDR
          2 2 SEG-NUM-A          9        ZD      1      1
          3 2 SEG-NUM-B          9        ZD      2      1
          4 2 SEG-NUM-C          9        ZD      3      1
          5 2 SEG-NUM-D          9        ZD      4      1
          **** End of data ****
:

```

Viewing the data with a segmented template produces the following where we can see the header segment has been used to determine the number of following segments.

```

:
View              FMN.RFM0757.SEGTEST(SEG2)                          Record AT TOP      Top of 3
          SEG-NUM-A SEG-NUM-B SEG-NUM-C SEG-NUM-D                                     Format TABL
          #2        #3        #4        #5
          ZD 1:1    ZD 2:1    ZD 3:1    ZD 4:1
          <>        <>        <>        <>
***** **** Top of data ****
000001          1          2          3          4
- - - - - -1- - - SEG-A - - - - - - - - - - - - - 1 Line(s) suppressed
- - - - - -1- - - SEG-B - - - - - - - - - - - - - 2 Line(s) suppressed
- - - - - -1- - - SEG-C - - - - - - - - - - - - - 3 Line(s) suppressed
- - - - - -1- - - SEG-D - - - - - - - - - - - - - 4 Line(s) suppressed
000002          0          2          0          2
- - - - - -2- - - SEG-B - - - - - - - - - - - - - 2 Line(s) suppressed
- - - - - -2- - - SEG-D - - - - - - - - - - - - - 2 Line(s) suppressed
000003          1          2          3          2
- - - - - -3- - - SEG-A - - - - - - - - - - - - - 1 Line(s) suppressed
- - - - - -3- - - SEG-B - - - - - - - - - - - - - 2 Line(s) suppressed
- - - - - -3- - - SEG-C - - - - - - - - - - - - - 3 Line(s) suppressed
- - - - - -3- - - SEG-D - - - - - - - - - - - - - 2 Line(s) suppressed
:

```

How File Manager handles segmented data with related ID criteria

Identification criteria

Identification criteria includes the ability to specify one or more references to fields within other segment types that occur earlier in the physical record in relation to the current segment.

Segment types are checked backwards from the current segment location, so the first matching segment type (for the particular related ID reference) preceding the current segment is the one used for comparison. ID criteria and related ID criteria are ANDed together unless ORing is requested by means of the template option.

Selection criteria

Segment selection criteria affects the selection of the entire record. If a segment within a record fails the selection criteria, the entire record is considered to have failed selection and is not presented or available in any form during subsequent processing.

Template layout selection and deselection

Deselection of a segment type in the template does not affect the processing of the selection criteria. For Edit or View, segments that have been deselected in the template (in order to honor the setting) are always grouped in a not-selected shadow line, regardless of the current grouping setting (the SHOW settings). The shadow line may be hidden or visible, depending on the current settings of the SHADOW primary command.

Unidentified segments

Segments that cannot be identified by explicit ID criteria, or by the implicit criteria of length matching (for those segments that do not have ID criteria specified), are also marked as not-selected segments. However, in Edit or View, these continue to obey the current grouping settings. When in Edit or View and in a multi-line format (TABL, CHAR, HEX or LHEX), and these segments are ungrouped, then the prefix area contains "=ID" to denote that these segments could not be identified. In SNGL format (as there is no prefix area), a message is issued.

Identification and selection currency for Edit and View

Identification and selection criteria are only applied to the records and segments at the time of loading the data into memory (assuming selection criteria have been supplied and this is an in-memory Edit or View) for the editor session. They are not re-assessed at any time during the editor session. For Edit, this means that data changes to segments that potentially affect the segment type, or would have disqualified the record or segment for selection, are not acted on in the current Edit session. To reflect this type of change to the data, it may be saved and the edit session re-entered.

Updating a template from a copybook (U)

If you have made minor changes to the copybook on which a template was based, you can update the template to reflect these changes.

Minor changes that the update process supports include:

- Changing field names without changing field data types
- Changing field data types without changing field names
- Changing the order of fields in a record
- Deleting unreferenced fields
- Inserting new fields
- Changing record length
- Changing the number of occurrences of fields in an array (table)

Major changes that might cause the update process to produce unwanted results include:

- Changing field names and field data types
- Changing field names and the order of fields in a record

If the template contains record identification criteria or record selection criteria, then the update process adjusts the field reference numbers in the criteria to reflect any changes in the field order.

However, if the criteria refer to a field that has been deleted in the copybook, then the update process displays the Field Selection/Edit panel, with references to deleted fields changed to “#0”. Edit the criteria, removing or replacing the obsolete field references, then press the Exit function key (F3) to continue with the update process.

If you change the data type of a field to a dissimilar data type (for example, numeric to non-numeric, or vice versa), then the update process discards any field attributes that you might have defined for that field (such as create attributes).

To update an existing template from a copybook:



Note: File Manager ignores the **Copybook: Data set name** field and instead uses the data set names which were used to create or update the template.

Copybooks can be stored in PDS, PDSE or CA-Panvalet libraries.

1. In the **Data set name** field in the **Template** section, type the name of the data set, in which the template you want updated is stored.

Templates can be stored in PDS or PDSE data sets but not in a CA-Panvalet library, or a library accessed using the Library Management System Exit.

2. In the **Member** field of the **Templates** section, type the name of your template or specify blanks or a pattern for the member name.
3. On the *Command Line*, type the `U` command and press Enter.

File Manager takes you to the advanced copybook selection process on the existing source definition for the specified template. When you press the Exit function key (F3), File Manager updates the template. A message is displayed in the upper right corner of the panel, to indicate the success or failure of the process.

You must specify the PDS member name of the copybook you want to use, and the data set name or PDS member name of the template you want to update. The copybook you specify is validated by compiling it with the compiler. For a description of the compilation process, and information about what you can do if errors occur, see [Data description support on page 180](#).

Running a function using a copybook or template (RC or RT)

If you entered the Template Workbench from a View or Edit panel (with the TVIEW command), you can use the Template Workbench to edit the current template or to select or create a new template, and then view the data.

To do so:

1. From the View or Edit panel, type `TView` on the Command Line and press Enter.

The Template Workbench main panel is displayed, with the details of the currently used copybook and/or template in the relevant fields.



Note: Issuing the TV command followed by a F3 (Exit) or F12 (Cancel) is synonymous to a TV OFF command. You must issue the RC or RT command to resume edit with a template from the workbench.

2. You can edit the current template (**E** command), create a new template from the current copybook (**CC** command), create a new template from the current template (**CM** command) or simply specify a different copybook or template.
3. Make your editing choices and then type the **RC** command (to use the copybook) or **RT** command (to use the template).

The View or Edit panel displays the data, using the newly specified copybook or template.



Note: These two commands are not available when you enter the Template Workbench through option 7.1.

When you enter RC, you are in effect using a temporary template created from the copybook you specify. You cannot edit this template before the panel is run, and the template is not saved. If you want to edit or save the template, use the CC command, and then use the RT command.

To use RC you must specify the PDS member name of the copybook you want to use. The copybook you specify is validated by compiling it with the compiler. For a description of this process, and information about what you can do if errors occur, see [Data description support on page 180](#).

If you use the RT command, the template can be either a permanent one previously saved in a PDS member, or a temporary one created for the current panel using the CC command.

Mapping fields (MC or MT)

When you copy data from one data set to another, or compare data in two data sets, you can first provide:

- A template describing the record structure of the input (Copy) or first (Compare) data set
- A template describing the record structure of the output (Copy) or second (Compare) data set

You can then describe the relationship between these record structures (known as field mapping). Field mapping can be created and edited from the Template Workbench, using the MC or MT primary commands, or it can be done “on the fly”, within the Copy or Compare Utilities.

Within the Template Workbench and the Copy Utility, the templates are known as the “From” and “To” templates. Within the Compare Utility, they are known as the “Old” and “New” templates. However, the template definitions and field mapping information are independent of any utility and templates intended for use in the Compare Utility can still be created and edited in the Template Workbench.

You specify field mapping information in the “To” (or “New”) template. For each field in the “To” template, the field mapping defines which field in the “From” (or “Old”) template (if any) are copied to or compared with the field in the “To” template.

Before editing field mapping in a “To” template, you need to specify a “From” template, using either the MC (Map from copybook) or MT (Map from template) command.

To use a copybook to create a new “From” template, specify a copybook on the Template Workbench, then enter the MC command.

To use an existing template as the “From” template, specify an existing template on the Template Workbench, then enter the MT command.

After you enter an MC or MT command, File Manager displays the Map To panel, where you can specify a “To” template, and use the EM or GE commands to begin editing its field mapping (see [Map To panel on page 941](#)).

Related topics

[Mapping fields between templates on page 251](#)

[Copying data sets on page 341](#)

[Comparing data sets on page 381](#)

Generating and editing field mapping (GM, GE and EM)

The GM (Generate corresponding map) command generates default field mapping between the “From” and “To” templates, replacing any existing field mapping in the “To” template. The GM command does not display the field mapping for editing. For details on the default field mapping generated by File Manager, see [Mapping fields between templates on page 251](#).

The EM (Edit mapping) command displays the field mapping for editing. If there is no existing field mapping in the “To” template, then the EM command generates default field mapping (effectively, performing a GM command before displaying the field mapping for editing).

The GE command is similar to EM, except that it always regenerates the default field mapping in the “To” template (replacing any existing field mapping) before displaying the field mapping for editing.

For details on editing the field mapping, see [Mapping fields between templates on page 251](#).

Mapping contiguous fields

If you need to map contiguous fields, you may find it more convenient to use the SS, Sn, or S* prefix commands (see [Field Mapping panel on page 889](#)).

When you select more than one field at a time, File Manager displays the “From” (or “Old”) Field Mapping panel (see [From \(or Old\) Field Mapping panel on page 908](#)) for the next selected field each time you press the Exit function key (F3). When you are viewing the last selected field and press the Exit function key (F3), File Manager returns you to the Field Mapping panel (see [Field Mapping panel on page 889](#)).

Specifying scrambling options

Scrambling data allows you to create test data based on production (or “live”) data, but with the ability to change the values of certain fields.

When you use the Copy Utility (option 3.3) to copy data from one data set to another data set, you specify the fields you want scrambled by marking those fields for scrambling in the output template.

You mark a field for scrambling by setting the scrambling options for that field in the template.

You can specify or change scrambling options on the Field Attributes panel. The panel comes in two flavors: one for alphanumeric fields and the other for numeric fields.

[Selecting a field for specifying scrambling options on page 246](#)

[Scrambling data on page 350](#)

[Field Attributes panel - alphanumeric fields on page 876](#)

[Field Attributes panel - numeric field on page 883](#)

[Value List Edit panel on page 1081](#)

[Scramble Exit Specification panel on page 1014](#)

Selecting a field for specifying scrambling options

You select a field from the Field Selection/Edit panel ([Figure 243: Field Selection/Edit panel on page 892](#)). To select a field for specifying scrambling options, enter **E** in the **Cmd** field adjacent to the required field. You can enter E against as many fields as you like. For each field you select, File Manager displays a Field Attributes panel.

After you have updated the scrambling options for a field (or any of the other field attributes), when you return to the Field Selection/Edit panel you will see an "E" for that field in the E column (under the "SHE" heading) indicating that the attributes for that field have changed.

The scrambling options you can specify are:

- Scramble type
- Value option
- Value input column
- Value output column
- Minimum and maximum values for a numeric range
- Value data set name

The scrambling options determine how the input data is scrambled (if at all) when it is copied to an output data set.

Related topics

[Specifying the scramble type on page 246](#)

[Specifying the value option on page 247](#)

[Specifying value input and out columns on page 248](#)

[Specifying range values on page 249](#)

[Specifying a value data set name on page 249](#)

[Specifying and editing a value list on page 249](#)

Specifying the scramble type

The **Scramble Type** option determines how data is scrambled when it is copied to the output data set.

Set the scramble type to one of these values:

Blank

Data is not scrambled.

1 ("Random")

Data scrambled to produce a random output value on each invocation.

2 ("Repeatable")

Data scrambled to produce the same output value on each invocation.

3 ("Translate")

Data scrambled by using input and output values that are held in the value data set (specified in the **Dsn** field).

This option requires you to select the **Value** option with an input and output column (**In** and **Out**) and value data set name (**Dsn**). All records in the translate data set are loaded into memory for the copy operation. The input and output columns provide the location of the input and output field values as stored in the data set. Their lengths are determined by the respective input and output fields that were mapped for the copy operation. If a matching input field value is found, then the corresponding output field value is obtained from the matching record. If no match is found, then the field is initialized to zero, or the value that is determined by the data create attributes.

4 ("Exit")

Data scrambled by using a scrambling exit (as specified on a separate panel). For details about writing a scrambling exit, see the *File Manager for z/OS Customization Guide*.

5 ("ODPP")

Data scrambled by using the ODPP command that is specified in the adjacent command field. This area is the Optim™ Data Privacy Provider command input area. Refer to the ODPP Syntax Guide for the command syntax.

The ODPP command is a scrollable field. Use the F10 and F11 keys to scroll left and right. Use the F4 key to expand the command into a separate window. This option is only available if File Manager is customized to access ODPP, and the environment is successfully initialized. For more information, see the *File Manager for z/OS Customization Guide*.

Related topics

[Specifying the value option on page 247](#)

[Specifying value input and out columns on page 248](#)

[Specifying range values on page 249](#)

[Specifying a value data set name on page 249](#)

Specifying the value option

The **Value** option and corresponding fields control the output of the scrambling process.

The way in which you select, or specify, this option differs according to whether the associated field is alphanumeric or numeric:

- For alphanumeric fields, do one of these:
 - Deselect the **Value** option by entering a blank.
 - Select the **Value** option by entering a "/".
- For numeric fields, do one of these:
 - Deselect the **Value** option by entering a blank.
 - Select a range by entering "1".
 - Select the **Value** option by entering "2".

Value option selected ("/")

Selecting this option allows you to provide:

- **A translate data set.** This applies when you select **Scramble Type** 3 ("Translate") with input and output columns and a value data set.
- **A lookup data set.** This applies when you select a **Scramble Type** of 1 ("Random") or 2 ("Repeatable") along with a value data set name. The data set is loaded into memory and the output value is randomly or repeatably selected from one of the loaded records. The output column determines the location of the value that is selected for this field.
- **A value list.** This applies when you select a **Scramble Type** of 1 ("Random") or 2 ("Repeatable") *without* a value data set name and allows you to enter the selection values for this field on the panel displayed when you press Enter. One of the values you provide is randomly or repeatably selected during a copy operation. The values you enter are stored in the template. Value lists are described in more detail later.

Value option deselected (blank)

Deselecting this option scrambles the input field to produce a random or repeatable output value. **Scramble Type** must be set to 1 ("Random") or 2 ("Repeatable").

Specifying value input and out columns

The input column field (**In**) defines the start location of the input field value on the value data set and is used when the translate process is run during a copy operation to match the input field with a value on the value data set. The length of the field is set to the length of the input field that is mapped to this field during the copy process.



Note: This value is only required when you select **Scramble Type** 3 ("Translate").

The output column field **Out** defines the start location of the output field value on the value data set and is used in these ways during a copy operation:

- **Translate.** If an input field value is matched on the value data set, then the corresponding output value is used.
- **Random** or **Repeatable.** The input value is used to randomly, or repeatably, select an output value from the value data set.

The length of the field is the field length as displayed on the Field Attributes panel.



Note: This value is required when you select **Scramble Type 3** ("Translate").

If you select **Scramble Type 1** ("Random") or 2 ("Repeatable"), and you have also selected the **Value** option, then the output column defaults to 1 if you have specified a value data set name (**Dsn**).

Specifying range values

When you are specifying scramble options for a numeric field, you can specify a range of values from which the resultant scrambled value is to be selected.

You specify the minimum value of the range in the **Min** field and the maximum value of the range in the **Max** field.

You can only select the range option with random and repeatable scrambling. The output value is randomly or repeatably selected from a number within the specified range.

Specifying a value data set name

The output data set name field **Dsn** field defines the value data set. It can be any cataloged sequential, partitioned or VSAM data set containing data that is used to determine the output field value during a copy process.

If you select **Scramble Type 3** ("Translate"), then the data set must contain the input and output values in the locations provided in the input and output columns.

If you select **Scramble Type 1** ("Random") or 2 ("Repeatable"), then the data set must contain the output value in the locations provided in the output column.



Notes:

1. This field is required when you select **Scramble Type 3** ("Translate"). If you select **Scramble Type 1** ("Random") or 2 ("Repeatable"), and also select the **Value** option, then you can optionally provide a data set name. If you leave this field blank having selected the **Value** option, you are prompted to enter the value list to be stored in the template.
2. The value data set record length must be greater than or equal to the field length.

Specifying and editing a value list

A value list is a list of values which is used in conjunction with the scrambling options to select a value with which a field is populated during a copy operation. When the output field is being populated, one of the values in this list is selected. Scrambling options combine the originating value with the random or repeatable seed to select a value from the list.

For random and repeatable scrambling, you can specify a value list inline by leaving the value data set field (**Dsn**) blank and selecting the **Value** option.

To edit the related value list, select the **Value** option and press Enter. File Manager displays the Value List Edit panel.

The values you provide must be valid for the corresponding field type. Deleting a value list turns off the value list option on the previous panel.

To enter hexadecimal values, use the X'hhhh' format:

```
x'C1C2C3'
```

To provide leading blanks or a blank value, use a quoted string:

```
' SMITH'
```

Blank value lines (no quotation marks) are ignored.

Use the FIND and LOCATE commands to bring a value containing or starting with a given string to the current line.

You can use prefix commands to copy, insert, move, repeat or delete lines.

To save the values, press F3. To ignore changes, press Cancel.

Related topics

[Value List Edit panel on page 1081](#)

Specifying scrambling options for date and time fields

You select a field from the Field Selection/Edit panel ([Figure 243: Field Selection/Edit panel on page 892](#)). To select a field for specifying date or time scrambling options, enter DT in the **Cmd** field adjacent to the required field. You can enter DT against as many fields as you like. For each field you select, File Manager displays a Date/Time Attributes panel.

The scrambling options you can specify are:

- Scramble type (random or repeatable)
- Start and end values for a date and time range

Specifying the scramble type

Select the **Random** option to have File Manager produce a random date or time output value on each invocation of the copy process. If the Random option is not selected and range **Start** and **End** values are specified, File Manager performs repeatable scrambling where the same date and time output value is produced on each invocation of the copy process.

Specifying range values

Range **Start** and **End** values must be specified for File Manager to perform scrambling on the date and time field. The **Start** and **End** values must be entered as date and time values in the output attribute Format defined for the field. These values define the range from which File Manager can generate scrambled date and time values.

Mapping fields between templates

Field mapping can be used when copying or comparing data. When copying, you must specify a “From” and a “To” template (see [Copying data sets on page 341](#)); when comparing, you must specify an “Old” and a “New” template and specify the **Formatted Compare Option** (see [Comparing data sets on page 381](#)). File Manager uses field mapping information stored in the “To” or “New” template to determine which fields are used in the process.

By default, File Manager generates field mapping information by matching the names of fields in the templates (this is case-sensitive). In many cases, the default field mapping is enough to perform the action you require. However, you can also edit the field mapping, allowing you to specify which record types are mapped and which fields within those record types are mapped. You can set up mapping so that, in the extreme case, a field is mapped to a field with a different name, length, and data type.

Default field mapping

While the same templates can be used for either copying or comparing, you need to understand the way that File Manager uses them in each situation.

First, File Manager pairs record types in the templates by looking for matching field names. Then, within each pair of record types, File Manager maps fields with matching names. The following two examples show the default results of this mapping in the copy and compare processes.

Copying with the default field mapping

A field mapping between “From” and “To” templates could be generated as:

Figure 75. Example of default field mapping

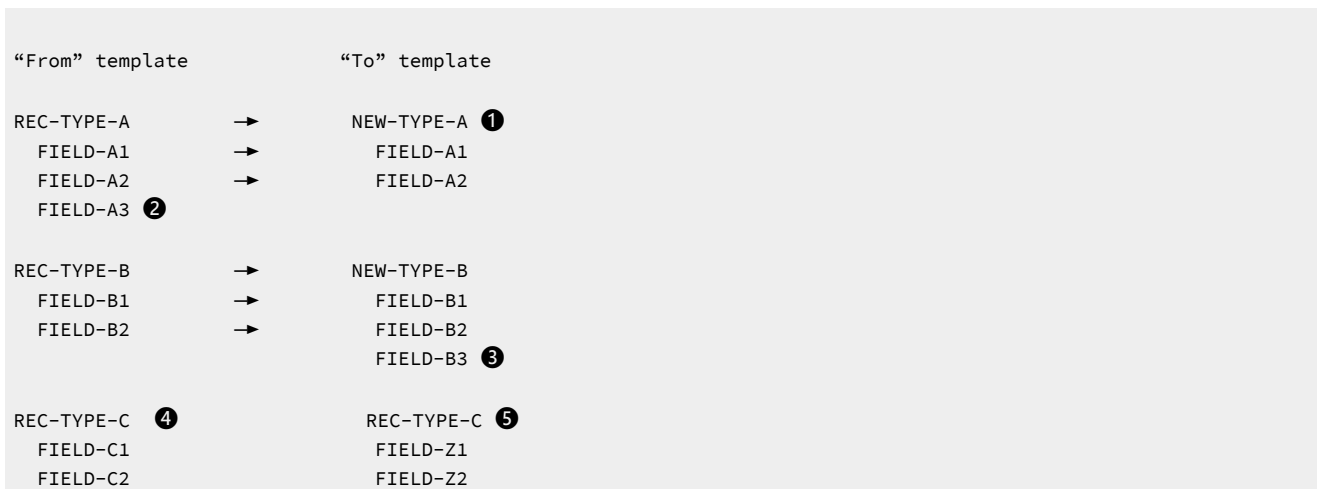

Given an input data set that consists of three records (one of each type defined in the “From” template), like this:

```

| FIELD-A1 | FIELD-A2 | FIELD-A3 | ← REC-TYPE-A
| FIELD-B1 | FIELD-B2 |           | ← REC-TYPE-B
| FIELD-C1 | FIELD-C2 |           | ← REC-TYPE-C

```

then copying the input data set would result in an output data set like this:

```
| FIELD-A1 | FIELD-A2 |                               ← NEW-TYPE-A ②
| FIELD-B1 | FIELD-B2 | FIELD-B3 | ← NEW-TYPE-B ③
| FIELD-C1 | FIELD-C2 |                               ← REC-TYPE-C ④
```



Notes:

①

File Manager pairs record types by matching field names within the record types; the names of the record types (level-01 group items, in the copybooks) are not important.

②

There is no matching FIELD-A3 in the “To” template NEW-TYPE-A, so this field is not copied to the output data set.

③

There is no FIELD-B3 in the “From” template to map to this FIELD-B3 in the “To” template. The field is inserted in the output data set; its value is initialized according to the field create attributes (if they exist) in the “To” template, or to zero (if it is a numeric field) or blanks (if it is an alphanumeric field).

④

There is no record type in the “To” template containing fields named FIELD-C1 or FIELD-C2, so the REC-TYPE-C record type in the “From” template is not paired with any record type in the “To” template (even though the “To” template contains a record type named REC-TYPE-C). The REC-TYPE-C record from the input data set is copied intact to the output data set. To stop this record from being copied, you need to edit the “From” template and deselect the REC-TYPE-C record type.

⑤

The REC-TYPE-C record type definition in the “To” template is unused, and has no effect on the copy.

Comparing with the default field mapping

The following field mapping between “Old” and “New” templates could be generated:

Figure 76. Example of default field mapping

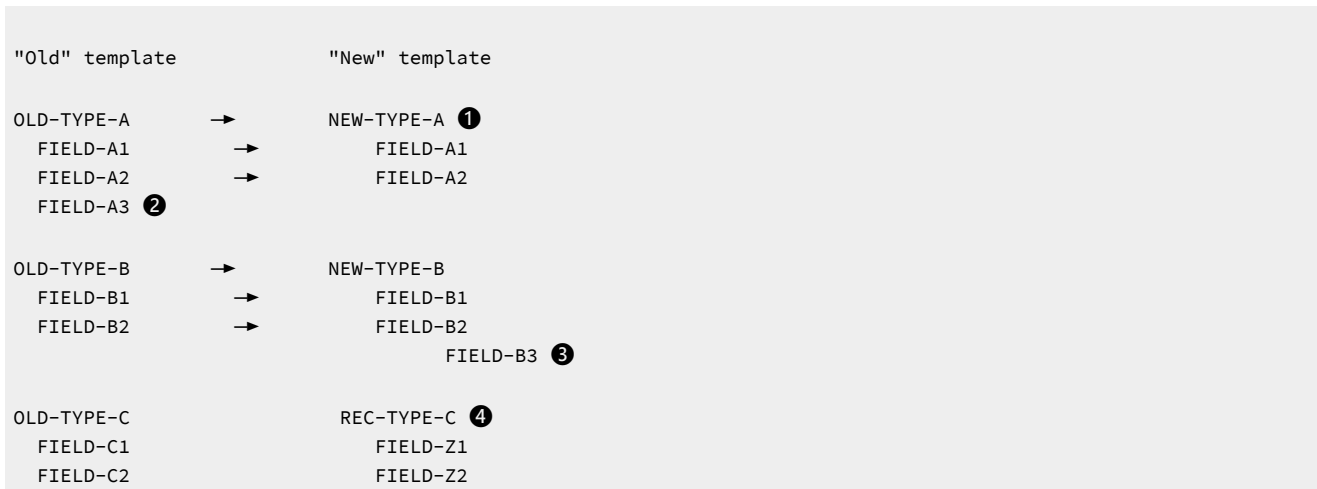

With the above field mapping, an "Old" data set containing one record of each type defined in the "Old" template:

```

| FIELD-A1 | FIELD-A2 | FIELD-A3 | ← OLD-TYPE-A
| FIELD-B1 | FIELD-B2 |           | ← OLD-TYPE-B
| FIELD-C1 | FIELD-C2 |           | ← OLD-TYPE-C

```

and a "New" data set containing one record of each type defined in the "New" template:

```

| FIELD-A1 | FIELD-A2 |           | ← NEW-TYPE-A
| FIELD-B1 | FIELD-B2 | FIELD-B3 | ← NEW-TYPE-B
| FIELD-Z1 | FIELD-Z2 |           | ← REC-TYPE-C

```

would be compared as follows:

- FIELD-A1 in the NEW-TYPE-A record is compared to FIELD-A1 in the OLD-TYPE-A record.
- FIELD-A2 in the NEW-TYPE-A record is compared to FIELD-A2 in the OLD-TYPE-A record.
- FIELD-A3 in the OLD-TYPE-A record is not compared with any field in any record in the "New" data set. ❷
- FIELD-B1 in the NEW-TYPE-B record is compared to FIELD-B1 in the OLD-TYPE-B record.
- FIELD-B2 in the NEW-TYPE-B record is compared to FIELD-B2 in the OLD-TYPE-B record.
- FIELD-B3 in the NEW-TYPE-B record is not compared with any field in any record in the "Old" data set. ❸
- The REC-TYPE-C records are not compared because there is no mapping match between the fields in the OLD-TYPE-C record and any record in the "New" template. ❹



Notes:

❶

File Manager pairs record types by matching field names within the record types; the names of the record types (level-01 group items, in the copybooks) are not important.

**2**

There is no matching FIELD-A3 in the “New” template NEW-TYPE-A, so this field is not mapped and is not used in the comparison.

3

There is no FIELD-B3 in the “Old” template to map to this FIELD-B3 in the “New” template, so this field is not mapped and is not used in the comparison.

4

There are no fields named FIELD-C1 or FIELD-C2 in any record type in the “New” template, so the OLD-TYPE-C record type in the “Old” template is not paired with a record type in the “New” template.

The “New” data in the REC-TYPE-C record is reported using the field descriptions in the NEW-TYPE-A record type. This is because the templates do not contain record identification criteria and NEW-TYPE-A is the first record type in the “New” template with a length matching the length of the REC-TYPE-C record in the “New” data set.

The “Old” data is not reported because there is no mapping match between the fields in the OLD-TYPE-C record and any record in the “New” template. Instead, the message “ *** Old data is not mapped to any data *** ” is reported.

Editing the field mapping

You can edit the field mapping either when performing a copy or a compare, or by using the Template Workbench panel.

To access the field mapping when performing a copy, you must have specified both a “From” and a “To” template and selected the **Edit template mapping** option in the “To” panel (see [Copying with a copybook or template on page 347](#)).

To access the field mapping when performing a compare, you must have specified both an “Old” and a “New” template in the first two panels and selected the **2. Formatted Compare Type** and **Edit template mapping** option in the third panel (see [Comparing data sets on page 381](#)).

To edit the field mapping from the Template Workbench panel:

1. On the Template Workbench (option 7) panel, specify a copybook or template that you plan to use for a “From” or “Old” template.

Although you need to specify this template before you can begin to edit the field mapping, you do not edit the mapping in this template: field mapping information is stored in the template that you specify on the next panel (“To” or “New”).

2. Enter either an MC (Map from copybook) or an MT (Map from template) command.
3. On the Map From panel, specify a copybook (if you want to create a new template) or an existing template that you plan to use for a “To” or “New” template.
4. Enter an EM (Edit mapping) command to edit the field mapping in that template.



Note: Template mapping information is used by both the Compare and Copy Utilities. When using the Template Workbench, the panel labels are those used by the Copy Utility (“From” and “To”).

Regardless of the method used to edit the field mapping, one of the following occurs:

- If the “To” template was generated from a copybook containing only one record type or was created as a dynamic template, the Template Mapping panel is displayed. (For panel details, see [Field Mapping panel on page 889](#).)
- If the “To” template was generated from a copybook containing more than one record type, the Record Type Mapping panel is displayed. (For panel details, see [Record Type Mapping panel on page 996](#)).



Note: The examples in this section assume that you are editing the field mapping from within the Template Workbench.

Figure 77. Record Type Mapping panel

Process	Options	Help
File Manager		Record Type Mapping
TO FMN.SFMNSAM1(FMNCOPY2)		FROM FMN.SFMNSAM1(FMNCOPY)
Cmd	Field name	Len
	**** Top of data ****	
---	NEW-TYPE01	84
---	NEW-TYPE02	100
	**** End of data ****	
		Field name
		REC-TYPE01
		REC-TYPE02
		Len
		84
		100
Command ==>		
F1=Help	F2=Split	F3=Exit
F7=Up	F8=Down	F9=Swap
	F4=CRetrie v	F5=RFind
	F12=Cancel	F6=Describe
		Scroll PAGE

To edit the mapping for a particular record type in the “To” template, type an **s** in the adjacent **Sel** column and press Enter.

File Manager displays the Field Mapping panel, showing the existing mapping between the fields in the “To” template record type and fields in the “From” template.

Setting up a mapping for a field

To set up or change the mapping for a field in the “To” template, enter **S** against the field name. The From Field Mapping panel is displayed, listing the fields in the “From” template that you can map to the “To” field:

Figure 78. The Field Mapping panel

Process		Options		Help					
File Manager		Field Mapping		Line 1 of 7					
To	FMN.SFMNSAM1(FMNCCPY2)								
From	FMN.SFMNSAM1(FMNCCPY)								
Cmd	Lv	To Field Name	Type	Len	Lv	From Field Name	Type	Len	
		**** Top of data ****							
---	1	NEW-TYPE01	AN	84	1	REC-TYPE01	AN	80	
---	2	REC-TYPE	AN	2	2	REC-TYPE	AN	2	
---	2	NAME	AN	20	2	NAME	AN	20	
---	2	SERIAL-NO	BI	4					
---	2	AGE	BI	2	2	AGE	BI	2	
---	2	SALARY	PD	4	2	SALARY	PD	4	
---	2	MONTH	BI	4	2	MONTH	BI	4	
		**** End of data ****							
Command ==>		-----				Scroll PAGE			
F1=Help	F2=Split	F3=Exit	F4=CRetriev	F5=RFind	F6=Describe				
F7=Up	F8=Down	F9=Swap	F12=Cancel						

In the example panel above, note that there is no "From" field against the "To" field SERIAL-NO. This field is "unmapped".

To set up or change the mapping for a field in the "To" template, enter S against the field name. The "From" Field Mapping panel is displayed, listing the fields in the "From" template that you can map to the selected "To" field:

Figure 79. The From Field Mapping panel

Process		Options		Help			
File Manager		From Field Mapping					
To	template/copybook : FMN.SFMNSAM1(FMNCCPY2)						
From	template/copybook : FMN.SFMNSAM1(FMNCCPY)						
To field : #4 SERIAL-NO						
From field :						
Corresponding(Y/N)	. . : N (Auto map for group items).						
Sel	Ref	Lvl	Old Field	Typ	Start	Length	
---	D	--	Delete "Old field"				
---	1	1	REC-TYPE01	AN	1	84	
---	2	2	REC-TYPE	AN	1	2	
---	3	2	NAME	AN	3	20	
---	4	2	EMPLOYEE-NO	BI	23	4	
---	5	2	AGE	BI	27	2	
---	6	2	SALARY	PD	29	4	
---	7	2	MONTH(13)	BI	33	4	
			**** End of data ****				
Command ==>		-----				Scroll PAGE	
F1=Help	F2=Split	F3=Exit	F4=CRetriev	F7=Up	F8=Down		
F9=Swap	F12=Cancel						

This screen is similar to the Primary Field Selection/Edit panel (Figure 243: Field Selection/Edit panel on page 892). You edit fields in the same way, by entering E against the field name. For copying in particular, you may wish to edit a field so that you can set the create attributes for the field. These are described in detail in [Changing the attributes for an alphanumeric field on page 229](#) and [Changing the attributes for an alphanumeric field on page 229](#).

The information at the top of the panel shows you the current mapping. In the panel above, the "To" field is SERIAL-NO. There is currently no "From" field, because there is no "From" field that has the same name.

To specify a “From” field to map to SERIAL-NO, enter S against a “From” field. The information at the top of the panel changes immediately to reflect the new mapping. For example, if you enter S against field #4 (EMPLOYEE-NO), then the information at the top of the panel looks like this:

```

:
File Manager                From Field Mapping
To  template/copybook : FMN.SFMNSAM1(FMNCCPY2)
From template/copybook : FMN.SFMNSAM1(FMNCCPY)
To  field . . . . . : #4 SERIAL-NO
From field . . . . . : #4 EMPLOYEE-NO
Corresponding(Y/N) . . : N          (Auto map for group items).
:

```

Press the Exit function key (F3) to return to the Field Mapping panel. This panel now shows that EMPLOYEE-NO is mapped to SERIAL-NO.

```

:
File Manager                Field Mapping                Line 1 of 7
To      FMN.SFMNSAM1(FMNCCPY2)
From    FMN.SFMNSAM1(FMNCCPY)

Cmd Lv To Field Name      Type Len  | Lv From Field Name      Type Len
**** Top of data ****
  1 NEW-TYPE01            AN   84  |  1 REC-TYPE01            AN   80
  2 REC-TYPE              AN   2   |  2 REC-TYPE              AN   2
  2 NAME                  AN  20   |  2 NAME                  AN  20
  2 SERIAL-NO             BI   4   |  2 EMPLOYEE-NO          BI   2
  2 AGE                   BI   2   |  2 AGE                   BI   2
  2 SALARY                PD   4   |  2 SALARY                PD   4
  2 MONTH                 BI   4   |  2 MONTH                 BI   4
**** End of data ****
:

```

Deleting a field mapping

If the mapping for a field is deleted and the template is used as the “To” template in a copy operation, the value in the output data set is initialized according to the field create attributes in the “To” template, rather than being copied from a field in the input data set. If the template is used as the “New” template in a compare operation, the field is not used in the comparison.

To delete the mapping for a field in a template:

1. Select the field on the Field Mapping panel.
2. On the From Field Mapping panel, enter S next to the `Delete "From field"` line.

Pairing with a different record type

To pair a record type in the “To” template with a different record type in “From” template:

1. Select the level-01 “field name” for the record type on the Field Mapping panel.
2. On the From Field Mapping panel, select the “From” record type that you want to pair with the “To” record type.



Note: This is useful when your “To” template contains only one record type that you wish to map to a second record type in your “From” template.

Mapping group items

In addition to mapping elementary items (as shown in the above example, between the SERIAL-NO and EMPLOYEE-NO fields), you can also map group items (that contain elementary items). If you choose to map a group item in the “From” template without mapping its subsidiary elementary items, then data in the “From” group item is treated as a single alphanumeric field. If you map the “Old” group item to a “To” group item without mapping its subsidiary elementary items, then the data is copied to the output data set (unchanged) or is compared, without regard for any data type differences between the elementary fields in the mapped group items.

If you *do* want to map the elementary items in a “From” group item with the elementary items in a “To” group item then, before selecting the “From” group item on the From Field Mapping panel, type **Y** in the **Corresponding (Y/N)** field. This instructs File Manager to automatically map subsidiary items with the same name in the “From” and “To” group items. (This is just a quick way to set up the mapping for these items; after File Manager has set up these mappings, you can edit them—delete the mapping, or map to a different item—as if you had manually set up the mapping.)

Mapping contiguous fields

If you need to map contiguous fields, you may find it more convenient to use the SS, Sn, or S* prefix commands (see [Field Mapping panel on page 889](#)).

When you select more than one field at a time, File Manager displays the From Field Mapping panel (see [From \(or Old\) Field Mapping panel on page 908](#)) for the next selected field each time you press the Exit function key (F3). When you are viewing the From Field Mapping panel for the last selected field and press the Exit function key (F3), File Manager returns you to the Field Mapping panel (see [Field Mapping panel on page 889](#)).

Creating data for a field

If you have specified a “From” field for a copy operation, then the data is transferred to the “To” field, with appropriate truncating or padding. If you have not specified a “From” field, then File Manager creates data for the field.

The rules that apply to the field are exactly the same as those used when creating a new data set. For more information, see [Managing templates on page 199](#).

Mapping using different templates

The mapping relationship is stored in the “To” or “New” template. The mapping information is the field identifier and the field name. When you reuse a template to copy or compare data, the mapping information is checked. File Manager makes sure that the field in the specified position has the specified name. If this is not the case, File Manager indicates that the mapping has broken down, with an “Invalid mapping in target” message.

This means that you can use a template that is different from the “From” or “Old” template you used to set up the mapping, provided that the structure of the new “From” or “Old” template does not differ from the structure of the original “From” or

“Old” template. That is, no fields that have been used in the mapping are in a different position or have a different name. The new “From” or “Old” template can, however, have different selection conditions.

You can also use a “To” or “New” template as a “From” or “Old” template. However, any mapping information in the template is ignored.

Field mapping rules

File Manager uses the rules shown in [Table 4: Field mapping rules on page 259](#) to determine if a given “from” field can be mapped to a given “to” field. “Yes” indicates that the mapping is valid. “No” indicates that the mapping is invalid.

Table 4. Field mapping rules

“From” field	“To” field		
	Alphanumeric	Numeric	Floating-point
Alphanumeric ³	Yes	Yes ⁴	Yes ⁵
Numeric integer ⁶	Yes	Yes	Yes
Numeric non-integer ⁷	No	Yes	Yes
Floating-point ⁸	No	Yes	Yes

These rules describe how a validly mapped “from” field is moved to a “to” field. When the “to” field is:

Alphanumeric

The data is aligned at the leftmost character position and, if necessary, truncated or padded with spaces at the right. The COBOL JUSTIFIED clause, if specified, is ignored.

If the “from” field is a numeric field, the absolute (unsigned) value is used. If the field is defined as signed and the sign occupies a separate character, that character is not moved, and the sending item is considered to be one less character than the actual size.

3. The category “alphanumeric” includes the COBOL categories: alphabetic, alphanumeric, alphanumeric-edited, numeric-edited, and DBCS. PICTURE clause editing characters are ignored. Group fields are treated as elementary alphanumeric fields.
4. The “from” field must consist only of numeric characters, and is treated as a numeric field.
5. The “from” field must consist only of numeric characters, and is treated as a numeric field.
6. The category “numeric integer” includes the following COBOL data types: binary (comp or comp-4 items), packed decimal (comp-3 items), and zoned decimal (PIC 9(*n*) items). The decimal items cannot have an implied decimal point.
7. The category “numeric non-integer” includes packed and zoned decimal items with an implied decimal point and one or more decimal digits.
8. The category “floating point” includes the COBOL floating point data types (comp-1 or comp-2 items). These are representations of real numbers stored with a mantissa and exponent.

Numeric

The data is aligned on the assumed decimal point and, if necessary, truncated or padded with zeros. If an assumed decimal point is not explicitly specified in the field definition, one is assumed immediately to the right of the field.

For a negative number when the "from" field is signed numeric, the data is moved as if both the "from" field and "to" field were described as signed.

When the "from" field is alphanumeric, the data is moved as if the "from" field were described as a signed numeric.

Internal Floating-Point

A decimal point is assumed immediately to the left of the field. The data is aligned then on the leftmost digit position following the decimal point, with the exponent adjusted accordingly.

External Floating-Point

The data is aligned on the leftmost digit position, and the exponent adjusted accordingly.

Copybook View and Print Utility

Use the Copybook View and Print Utility to view or print field definition information.

This information can be stored in the following objects:

- a copybook
- a template that was based on a copybook (not Db2® templates)
- a dynamic template
- an IMS™ view
- an IMS™ criteria set

You can view the report in foreground (view), print the report to your current print data set, or submit a batch job to print the report. When using foreground execution, you can view and print multiple members by selecting them from a member list. When using batch execution, you can specify a generic member name to print multiple members.

To view or print copybook report:

1. Open the Copybook View and Print Utility panel by selecting option **3.13** or option **7.2** from the Primary Option Menu.
2. Enter the name of the data set that contains your copybook, template, IMS™ view or IMS™ criteria set.
3. Enter the name of the member that you wish to view or print, or enter a blank or a pattern to select from a member list.
4. Set your View/Print Option to either **1** (View) or **2** (Print).
5. To run the function in batch (and, if necessary, edit the JCL), select the **Batch Execution** option.
6. To show all occurrences of array elements, select the **Show array elements** option.
7. To show start and end values as hexadecimal offsets, select the **Show start/end as hex offset** option.
8. To show length values as hexadecimal, select the **Show length in hex** option.

9. To show template criteria, select the **Show template criteria** option.

The information shown when you select the **Show template criteria** option depends on the type of input data set:

Input data set	Information shown
Copybook	The Show template criteria option has no effect. Copybook layout reported, with no explicit indication that criteria are not present, and no indication that an extraneous option was selected.
Template with no identification or selection criteria	Template layout reported, with messages to indicate that criteria are not present.
Template with identification or selection criteria	Template layout and criteria reported

10. Press Enter to process the panel.

If you specified a pattern or a blank for the member name, the Member Selection list is displayed. Enter S in the Sel field for each member that you want to view or print, then press Enter.

If you selected Batch execution, the generated JCL is displayed. You can tailor this JCL and then submit it for processing.



Note: Batch execution ignores the View/Print processing option.

11. If you used foreground execution and chose to view the report, the View panel is displayed. You can browse the contents of this panel, or print the contents to the current print data set by entering 1.

Related topics

[Utility Functions menu panel on page 1077](#)

[Copybook and Template Utility functions panel on page 809](#)

[Copybook View and Print: Entry panel on page 814](#)

XML templates

A File Manager template can be exported to an external XML format using the Template Export utility.

All aspects of a template can be represented in an XML form. The XML can be created manually by specifying the elements and attributes described in [XML definitions for a template on page 1823](#), or by exporting an existing template.

An XML template can be used directly within the product as long as the XML provides all the elements required to create a new template. You can use an XML template anywhere you can specify a copybook or template. A good way to determine the XML required to create a template is to use the Template Export Utility to export a similarly defined template.

Exporting a template to XML format

You can export any type of template from any type of File Manager session. The export utility is available from all template menus for convenience.

To use the foreground utility to export a File Manager template, select one of these options:

- Option 7.6 from the File Manager Primary Options menu.
- Option 7.2 from the FM/Db2 Primary Options menu.
- Option 4.8 from the FM/IMS Primary Options menu.

With the foreground Template Export utility, you can display a member list with all types of templates supported. You can also invoke a template edit against any type of template using the E prefix command from the member list.

The batch utility for exporting a File Manager template is TPEXP.

Importing a template in XML format

An XML template can be imported into the product using the Template Import utility. The import process can either create or update an existing template using the template definition in its XML format.

To use the foreground utility to import a File Manager template, select one of these options:

- Option 7.5 from the File Manager Primary Options menu.
- Option 7.1 from the FM/Db2 Primary Options menu.
- Option 4.7 from the FM/IMS Primary Options menu.

The batch utility for importing a File Manager template is TPIMP.



Db2: To import a Db2® template you must be running the import utility from a File Manager/Db2 session, whether foreground or batch. The Db2® object referred to in the template XML must exist in the current subsystem for the FM/Db2 session.



IMS:



- To import an IMS™ template, view, or criteria set you must be running the import utility from a FM/IMS session, whether foreground or batch.
- The FM/IMS Extract process allows an XML template to be created, mapping the extract fields.

You might have copies of the same IMS™ database information loaded under similar DBD names. This allows multiple IMS™ environments using similar data. Once the FM/IMS extract is completed, you can use the template created by the extract to change the database names and update other data in a formatted view.

Sample XML for BASE template

The following XML defines a template that is created from two copybooks, COPY01 and COPY02. These copybooks can be found in data set FMN.COPY. The example shows how to provide an 01 field and its name (name01="type01") and how to specify redefines and range specifications. It also shows how to provide identification criteria.

```
<template lang="COBOL" type="BASE">
  <copybooks>
    <library>FMN.COPY</library>
    <member name="COPY01" name01="type01">
      <redefine level="3"/>
      <sourcerange fromstmt="2"/>
    </member>
    <member name="COPY02" name01="type02">
      <redefine level="3"/>
      <sourcerange fromstmt="2"/>
    </member>
  </copybooks>
  <layout copybook="COPY01">
    <criteria type="ID">
      <exp><![CDATA[#2 = '01']]></exp>
    </criteria>
  </layout>
  <layout copybook="COPY02">
    <criteria type="ID">
      <exp><![CDATA[#2 = '02']]></exp>
    </criteria>
  </layout>
</template>
```

Sample XML for IMS™ template

```
<template lang="COBOL" type="IMS">
  <dbd>DJ1E</dbd>
  <dbdlib>FMIMS.XTEST.DBDLIB</dbdlib>
  <copybooks>
    <library>FMN.IMS.IVP.COPYLIB.COBOL</library>
    <member name="SHIRE" lib="1" segname="SHIRE">
    </member>
    <member name="SHIRENP" lib="1" segname="SHIRENP">
    </member>
    <member name="LINKSUB" lib="1" segname="LINKSUB">
    </member>
  <cobol maxrc="4">
  </cobol>
```

```

</copybooks>
<layout name="SHIRE" copybook="SHIRE" segment="SHIRE">
  <criteria type="ID">
    <exp><![CDATA[#4 = '1']]></exp>
  </criteria>
</layout>
<layout name="SHIRE-TOWN" copybook="SHIRE" segment="SHIRE">
  <criteria type="ID">
    <exp><![CDATA[#4 = '2']]></exp>
  </criteria>
</layout>
<layout name="SHIRE-CITY" copybook="SHIRE" segment="SHIRE">
  <criteria type="ID">
    <exp><![CDATA[#4 = '3']]></exp>
  </criteria>
</layout>
<layout name="SHIRE-NON-PUBLIC" copybook="SHIRENP" segment="SHIRENP">
</layout>
<layout name="SHIRE-SUBURB" copybook="LINKSUB" segment="LINKSUB">
</layout>
</template>

```

Sample XML for Db2® template

```

<template type="DB2">
  <ssid>DFB2</ssid>
  <db2object>DSN81210.EMP</db2object>
  <db2rel>1215</db2rel>
  <layout>
    <criteria>
      <exp><![CDATA[
        WHERE "FIRSTNME" = 'Bob' AND "MIDINIT" = 'C'
      ]]></exp>
    </criteria>
  </layout>
</template>

```

Using the foreground interface to export XML templates

Here is an example of exporting an XML template using the File Manager Base component option 7.6.

```

Process  Options  Help
-----
File Manager          Template Export Utility
Command ==>> _____

Template:
Data set name . 'FMN.SAMPLE.TEMPLATE'
Member . . . . . (Blank or pattern for member list)
Filter . . . . . _____

Export Data set:
Data set name . 'FMN.XML.EXAMPLE'
Member mask . . _____

Processing Options:
Enter "/" to select option          Enter "/" to select option
- Batch execution                    / Replace members
- Advanced member selection          / Copybook and criteria only
- Skip member list                   / Stats On

```

Only copybook and criteria information is exported. This means that field or column data like hold, selection, create or alternate heading are not included. Just the basic definition and any criteria included in the template.

```

Process  Options  Help
-----
File Manager          Template Member Selection          Row 00001 of 00013
Command ==>> _____          Scroll CSR

Input data set FMN.SAMPLE.TEMPLATE
Export data set FMN.XML.EXAMPLE

Name      Prompt  Type Created      Updated          Lang  Ver  Descr
*         *      *   *           *              *         *   *
s_____ ABEND      BASE 2004/02/11 2011/11/28 12:39:09 COBOL  2  This
s_____ AODAO140   DYN  2011/12/19 2012/09/11 11:32:30 NONE   3
s_____ CONV1    DB2  2012/03/02 2012/09/19 09:16:41 NONE   3
_____ COPY01B   BASE 2012/09/12 2012/09/12 06:23:29 PL/I   3
s_____ DJ1E      IMS  2008/08/15 2012/08/07 16:53:34 COBOL  3
_____ DJ1ECR1    CRIT 2008/01/12 2009/06/29 16:57:12 PL/I   3
s_____ DJ1ECR2    CRIT 2008/01/12 2009/06/29 16:57:12 PL/I   3
_____ DJ1ECR3    CRIT 2008/01/12 2009/06/29 16:57:12 PL/I   3
s_____ DJ1EVW    VIEW 2004/02/12 2012/08/03 17:37:53 COBOL  3
_____ EMPBASE   DB2  2009/03/10 2012/09/10 21:13:15 NONE   3
_____ EMPDB2   DB2  2009/06/29 2012/09/10 21:11:43 NONE   3
_____ TEST0102  BASE 2012/01/11 2012/08/07 06:09:56 COBOL  3
_____ THOGAN   BASE 2004/08/09 2009/05/18 14:25:55 COBOL  2
**** End of data ****

```

From this member list you can use the **E** or **U** prefix command to edit a template. You can use **EX** or **VX** command to edit or view the XML member of the same name in the export data set.

Press Enter after selecting various templates to be exported.

```

Process  Options  Help
-----
File Manager          Template Member Selection          Row 00001 of 00013
Command ==>          Scroll CSR

Input data set FMN.SAMPLE.TEMPLATE
Export data set FMN.XML.EXAMPLE

Name      Prompt  Type Created      Updated          Lang  Ver  Descr
*         *      *      *              *              *      *      *
-----
ABEND     *ExpRepl BASE 2004/02/11 2011/11/28 12:39:09 COBOL 2 This
AODAO140 *ExpRepl DYN 2011/12/19 2012/09/11 11:32:30 NONE 3
CONVT1    *ExpRepl DB2 2012/03/02 2012/09/19 09:16:41 NONE 3
COPY01B   BASE 2012/09/12 2012/09/12 06:23:29 PL/I 3
DJ1E      *ExpRepl IMS 2008/08/15 2012/08/07 16:53:34 COBOL 3
DJ1ECR1   CRIT 2008/01/12 2009/06/29 16:57:12 PL/I 3
DJ1ECR2   *ExpRepl CRIT 2008/01/12 2009/06/29 16:57:12 PL/I 3
DJ1ECR3   CRIT 2008/01/12 2009/06/29 16:57:12 PL/I 3
DJ1EVW    *Exportd VIEW 2004/02/12 2012/08/03 17:37:53 COBOL 3
EMPBASE   DB2 2009/03/10 2012/09/10 21:13:15 NONE 3
EMPDB2    DB2 2009/06/29 2012/09/10 21:11:43 NONE 3
TEST0102  BASE 2012/01/11 2012/08/07 06:09:56 COBOL 3
THOGAN    BASE 2004/08/09 2009/05/18 14:25:55 COBOL 2
**** End of data ****

```

You can use the foreground utility to generate the batch JCL to run the export.

Using the foreground interface to import XML templates

Here is an example of importing using the File Manager Base component option 7.5.

```

Process  Options  Help
-----
File Manager          Template Import Utility
Command ==>

XML Input:
Data set name . 'FMN.XML.EXAMPLE'
Member . . . . (Blank or pattern for member list)

Import Template:
Data set name . 'FMN.IMP.NEW'
Member mask . .

Processing Options:
Enter "/" to select option
- Batch execution          / Replace - No update
- Advanced member selection - Skip member list

```

Press Enter to display the member list.

```

Process  Options  Help
-----
File Manager          XML Template Member Selection          Row 00001 of 00009
Command ==>          Scroll CSR

XML      data set FMN.XML.EXAMPLE
Template data set FMN.IMP.NEW

      Name      Prompt      Type Created      Updated      Lang Ver Descr
      *         *         *         *         *         *         *         *
_____ ABEND          BASE 2013/06/07 2013/06/07 10:29:55 COBOL XML This
s_____ AODAO140       DYN
_____ CONVT1        DB2
_____ COPY01B     BASE 2012/12/01 2012/12/01 00:10:19 COBOL XML
_____ DJ1E          IMS 2013/07/03 2013/07/03 13:50:57 COBOL XML
_____ DJ1ECR2       CRIT 2013/05/09 2013/05/10 13:39:57 COBOL XML
_____ DJ1EVW       VIEW 2013/07/03 2013/07/03 13:51:00 COBOL XML
_____ EMPBASE     DB2 2012/09/19 2012/09/19 08:23:12 NONE XML
s_____ TEST0102     BASE COBOL XML
**** End of data ****

```

Running under the File Manager Base component, it is only possible to import dynamic and File Manager Base component templates.

```

Process  Options  Help
-----
File Manager          XML Template Member Selection          Template saved
Command ==>          Scroll CSR

XML      data set FMN.XML.EXAMPLE
Template data set FMN.IMP.NEW

      Name      Prompt      Type Created      Updated      Lang Ver Descr
      *         *         *         *         *         *         *         *
_____ ABEND          BASE 2013/06/07 2013/06/07 10:29:55 COBOL XML This
_____ AODAO140 *ImpRepl DYN
_____ CONVT1        DB2
_____ COPY01B     BASE 2012/12/01 2012/12/01 00:10:19 COBOL XML
_____ DJ1E          IMS 2013/07/03 2013/07/03 13:50:57 COBOL XML
_____ DJ1ECR2       CRIT 2013/05/09 2013/05/10 13:39:57 COBOL XML
_____ DJ1EVW       VIEW 2013/07/03 2013/07/03 13:51:00 COBOL XML
_____ EMPBASE     DB2 2012/09/19 2012/09/19 08:23:12 NONE XML
_____ TEST0102 *ImpRepl BASE COBOL XML
**** End of data ****

```

You can use the foreground utility to generate the batch JCL to run the import.

Examples of the batch interface

Example 1. Import - all XML members on FMN.XMLINP to FMN.IMPORT.TEMPLATE

```

//FMBAT EXEC PGM=FILEMGR
//STEPLIB DD DISP=SHR,DSN=HLQ.SFMNMOD1
//SYSPRINT DD SYSOUT=*
//SYSIN DD *
$$FILEM TPIMP DSNIN=FMN.XMLINP,
$$FILEM MEMBER=*,
$$FILEM DSNOUT=FMN.IMPORT.TEMPLATE,
$$FILEM REPLACE=YES
/*

```

Example 2. Import - same as example 1 except using default input and output ddnames. Note keywords INPUT, and OUTPUT can be used to point to different DD names.

```
//FMBAT EXEC PGM=FILEMGR
//STEPLIB DD DISP=SHR,DSN=HLQ.SFMNMOD1
//DDIN DD DISP=SHR,DSN=FMN.XMLINP
//DDOUT DD DISP=SHR,DSN=FMN.IMPORT.TEMPLATE
//SYSPRINT DD SYSOUT=*
//SYSIN DD *
$$$FILEM TPIMP MEMBER=*,REPLACE=YES
/*
```

Example 3. Import from XML that is inline in the jobstream into one member

```
//FMBAT EXEC PGM=FILEMGR
//STEPLIB DD DISP=SHR,DSN=HLQ.SFMNMOD1
//SYSPRINT DD SYSOUT=*
//SYSIN DD *
$$$FILEM TPIMP DSNOUT=FMN.TEMPLATE(CBL1),INPUT=*
<template lang="COBOL" type="BASE">
  <copybooks>
    <library>FMN.COBOLEND</library>
    <member name="COPY01"/>
    <member name="COPY02"/>
  </copybooks>
  <layout copybook="COPY01">
    <criteria type="ID">
      <exp><![CDATA[#2 = '01']]></exp>
    </criteria>
  </layout>
  <layout copybook="COPY02">
    <criteria type="ID">
      <exp><![CDATA[#2 = '02']]></exp>
    </criteria>
  </layout>
</template>
/*
```

Example 4. Export all template members in a PDS - Replace output members, ISPF statistics and only produce XML for copybook and criteria.

```
//FMBAT EXEC PGM=FILEMGR
//STEPLIB DD DISP=SHR,DSN=HLQ.SFMNMOD1
//SYSPRINT DD SYSOUT=*
//SYSIN DD *
$$$FILEM TPEXP DSNIN=FMN.IMPORT.TEMPLATE,
$$$FILEM MEMBER=*,
$$$FILEM DSNOUT=FMN.XMLOUT.NEW,
$$$FILEM COPYCRIT=YES,
$$$FILEM STATS=YES,
$$$FILEM REPLACE=YES
/*
```

Example 5. Export same as example 4 except using default DD names for input and output. Keywords INPUT, and OUTPUT could also be used.

```
//FMBAT EXEC PGM=FILEMGR
//STEPLIB DD DISP=SHR,DSN=HLQ.SFMNMOD1
//SYSPRINT DD SYSOUT=*
//DDIN DD DISP=SHR,DSN=FMN.IMPORT.TEMPLATE
//DDOUT DD DISP=SHR,DSN=FMN.XMLOUT.NEW
//SYSIN DD *
$$FILEM TPEXP MEMBER=*,
$$FILEM COPYCRIT=YES,
$$FILEM STATS=YES,
$$FILEM REPLACE=YES
/*
```

Example 6. Export single member to producing XML output on SYSOUT

```
//FMBAT EXEC PGM=FILEMGR
//STEPLIB DD DISP=SHR,DSN=HLQ.SFMNMOD1
//SYSPRINT DD SYSOUT=*
//XMLDD DD SYSOUT=*
//SYSIN DD *
$$FILEM TPEXP DSNIN=FMN.TEMPLATE,MEMBER=COPY0102,COPYCRIT=YES,
$$FILEM OUTPUT=XMLDD
/*
```

Example 7. Run a compare job using XML dynamic templates specified in the JCL to perform column compares. This compares columns 1 to 5 input file with columns 8 to 12 of the output file, and columns 6 to 10 of the input file with columns 13 to 17 of the output file.

```
//FMBAT EXEC PGM=FILEMGR
//SYSPRINT DD SYSOUT=*
//DDOLD DD DISP=SHR,DSN=FMN.DATA(COMP1OLD)
//DDNEW DD DISP=SHR,DSN=FMN.DATA(COMP1NEW)
//TDOLD DD DATA
<template type="DYNAMIC">
<layout>
<symbol name="comp1" start="1" length="5" type="AN"/>
<symbol name="comp2" start="6" length="5" type="AN"/>
</layout>
</template>
/*
//TDNEW DD DATA
<template type="DYNAMIC">
<layout>
<symbol name="comp1" start="8" length="5" type="AN"/>
<symbol name="comp2" start="13" length="5" type="AN"/>
</layout>
</template>
/*
//SYSIN DD *
$$FILEM DSM TYPE=FORMATTED,LIST=DELTA
/*
```

Example 8. Print sample file using XML dynamic template - multiple layouts and ID criteria.

```
//FMBAT EXEC PGM=FILEMGR
//SYSPRINT DD SYSOUT=*
//DDIN DD DISP=SHR,DSN=hlq.SFMNSAM1(FMNCDATA)
//TDDIN DD DATA
<template type="DYNAMIC">
```

```

<layout name="rec-type01">
  <symbol name="type" start="1" length="2" type="AN"/>
  <symbol name="name" start="3" length="20" type="AN"/>
  <symbol name="empno" start="23" length="2" type="BI"/>
  <symbol name="age" start="25" length="2" type="BI"/>
  <symbol name="salary" start="27" length="4" type="PD"/>
  <criteria type="ID">
    <exp><![CDATA[#type = '01']]></exp>
  </criteria>
</layout>
<layout name="rec-type02">
  <symbol name="type" start="1" length="2" type="AN"/>
  <symbol name="name" start="3" length="20" type="AN"/>
  <symbol name="title" start="23" length="14" type="AN"/>
  <symbol name="addr1" start="37" length="20" type="AN"/>
  <symbol name="addr2" start="57" length="20" type="AN"/>
  <symbol name="postcode" start="77" length="4" type="AN"/>
  <criteria type="ID">
    <exp><![CDATA[#type = '02']]></exp>
  </criteria>
</layout>
</template>
/*
//SYSIN DD *
$$$FILEM DSP FORMAT=SNGL
/*

```

Example 9. Run a Db2® import job that either creates or updates a Db2® template specifying new headings for fields. Note we have the XML inline - the input could come from a member.

```

//FMNDB2 EXEC PGM=FMNDB2,PARM=('SSID=ssss,SQID=userid')
//SYSPRINT DD SYSOUT=*
//SYSTEM DD SYSOUT=*
$$$FILEM TPIMP DSNOUT=hlq.TEMPLATE(EMPHD),
$$$FILEM REPLACE=YES,
$$$FILEM INPUT=*
<template type="DB2">
  <db2object>DSN8810.EMP</db2object>
  <layout>
    <symbol name="empno">
      <heading>Employee</heading>
    </symbol>
    <symbol name="FIRSTNAME">
      <heading>First Name</heading>
    </symbol>
    <symbol name="MIDINIT">
      <heading>Middle</heading>
    </symbol>
    <symbol name="LASTNAME">
      <heading>Last Name</heading>
    </symbol>
    <symbol name="BIRTHDATE">
      <heading>Birth Date</heading>
    </symbol>
  </layout>
</template>

```

Chapter 5. Working with the Template List

Display a list of templates and perform actions on them.

All template types can be managed from a list that includes the following features:

- Visibility of member generations for PDSE version 2 data sets.
- A lock mechanism to prevent unintentional template edit changes.
- The ability to change the default value for formatting leading zeros with numeric fields.
- The ability to compare templates in their exported XML format.

How to produce a Template List

The Template List can be produced using any of the following methods:

- Option **7.8** from the File Manager main menu.
- Invoking a REXX exec. See "Keyword invocation from REXX. See also [Setting up a REXX exec to invoke the Template List from an ISPF 3.4 data set display on page 274](#).
- Invoking an ISPF command defined in the ISPF Command Table. See [Setting up ISPF commands to invoke the Template List on page 273](#).
- If editing a member (for example, JCL or reference list member) and the cursor is placed on the name of a partitioned data set containing templates, then pressing the enhanced search function key produces a menu where the Template pull-down option 6 can be used to list the templates for that data set. (See Using the File Manager pull-down options from your F4 function key).



Note: Set a function key to FMNELIBD **FMPWT** (using LIBDEFs) or FMNSRCHK **FMPWT** (not using LIBDEFs) to invoke the Template List bypassing the menu.

Keyword invocation from REXX

Purpose

Displays a list of templates that includes all template types. The Template List can be invoked directly from a REXX exec.

Usage notes

When invoked from an ISPF Command line without any parameters, or from the File Manager Utilities menu, the Template list panel is displayed. If you specify any parameters, the Template Member List panel is displayed.

Options

None.

Related functions

None.

Figure 80. Syntax

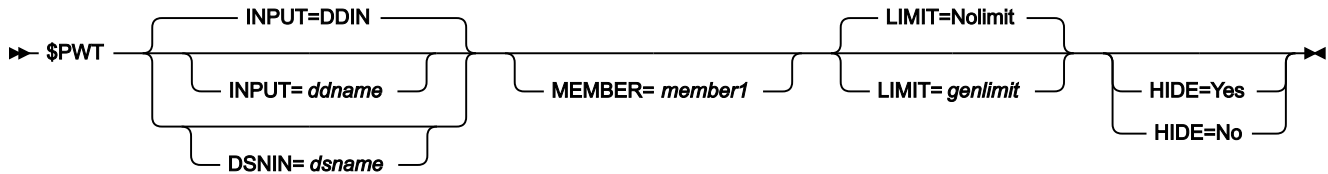

Parameters

INPUT=*ddname*

Defines a reference to a DD or TSO ALLOC statement for the input data set to be displayed in PDSE Workbench. The default is DDIN. The allocated ddname must be a single PDS or PDSE. Concatenated data sets are not supported.

DSNIN=*dsname*

Defines the name of the cataloged input PDS or PDSE. The name can include a member name or member name pattern in parentheses. If the member name is specified here, the MEMBER parameter must not be specified.

MEMBER=*member1*

The name of a single member or a pattern representing one or more members of the PDS or PDSE to display in the member list. A pattern is a partial member name that uses either an * (asterisk) or % (percent sign) as place holders:

- A * symbol represents a string of characters.
- A % symbol represents only a single character.

LIMIT=*genlimit*|Nolimit

Specifies the maximum number of generations to be displayed in the member list for each member. Range: 0 - 2000000000.

LIMIT=0 displays member alias information but does not display any member generations. LIMIT=Nolimit displays all member generations that match the member name or member name pattern. Current members (generation 0) are always displayed.

genlimit is ignored for data sets that do not support member generations.

HIDE=Yes|No

Yes

Displays the Template Member List panel with the input fields hidden to maximize the size of the member list.

No

Displays the full Template Member List panel with all input fields displayed.

When the HIDE keyword is not specified, the previous setting is used, which defaults to HIDE=NO for first-time users. Once the Template Member List panel is displayed, use the HIDE command to toggle the display of the input fields.

Example keyword invocation from REXX

```
/* REXX invoke Template List */
ARG DSNIN
if DSNIN = '' then do
  say 'DATA SET NAME REQUIRED '
  exit 8
end
address TSO
'ALLOC FI(FMNPRINT) DUMMY REUSE'
address ISPEXEC
'SELECT CMD(FMMAIN $PWT DSNIN='||DSNIN||',
          ',LIMIT=NOLIMIT',
          ') NEWAPPL(FMN) MODE(FSCR) PASSLIB'
address TSO
'FREE FI(FMNPRINT)'
```

Setting up ISPF commands to invoke the Template List

Install File Manager as described in the *File Manager Customization Guide*, specifically, the TSO logon must be modified so the File Manager data sets are available to the ISPF session. In addition to the FM command described in Defining File Manager in an ISPF command table in the *File Manager Customization Guide*, add the following commands of your choosing to be used to invoke the Template List.

Define the Template List command without LIBDEFs

Using ISPF option 3.9 specify a command as illustrated below:

```
File  Menu  Utilities  Help
----- Command Table Utility -----
Extended Command Entry
Command ===>

Make changes to the command and select Update to update the entry or
Cancel to ignore the changes.

Verb . . . PWT
Trunc . . . 2
Action . . SELECT CMD(FILEMGR PWT &ZPARM) NEWAPPL(FMN)

Description FM Template List

Enter / to select option
/ Allow mixed-case in Action field
```

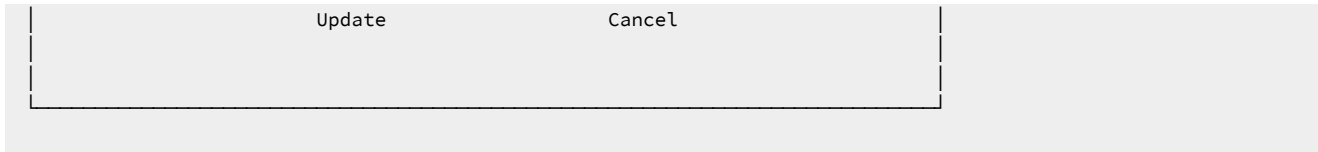

Define the Template List command with LIBDEFs

Using ISPF option 3.9 specify a command as illustrated below:

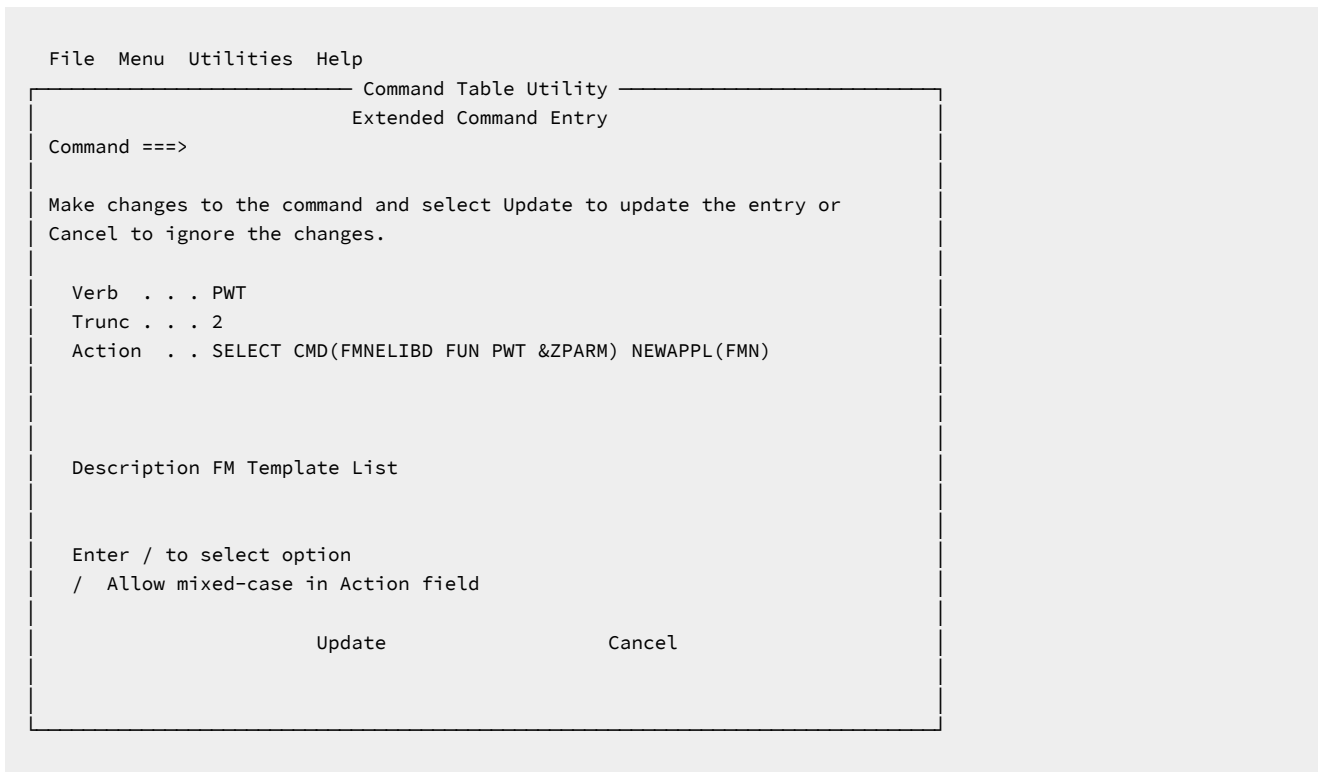

Setting up a REXX exec to invoke the Template List from an ISPF 3.4 data set display

Define one of the following execs in a member of your choosing in a data set that is available in SYSEXEC or SYSPROC concatenations for the TSO ISPF session. (Can also be in an ALTLIB).

Define the Template List exec without LIBDEFs

```

/* REXX invoke Template List */
ARG DSN
address ISPEXEC
"SELECT CMD(FILEMGR PWT "DSN") MODE(FSCR)"
exit
  
```

Define the Template List with LIBDEFs

```

/* REXX INVOKE Template List */
ARG DSN
address ISPEXEC
"SELECT CMD(%FMNELIBD FUN PWT "DSN") MODE(FSCR)"
  
```

exit

Template List Entry panel

The Template List entry panel is displayed when the primary menu option **7.8** is selected or the ISPF site command is issued without a data set name.

Panel and field definitions

Figure 81. Template List entry panel

<u>P</u> rocess	<u>O</u> ptions	<u>H</u> elp
File Manager	Template List Entry Panel	
Command ==>	_____	
Data set name .	PH33060.TEMPLATE.PDSEV2	
Member *	_____	Generation limit _____

Data set name

Specify a fully qualified or generic data set name of either a PDS or PDSE.

- Specify a generic data set name to select a data set from the selection list for processing by the PDSE Workbench.
- Leave the data set name blank to select from the history of up to 50 of the previous data sets used by the PDSE Workbench.

Member name

Specify a member name or member name pattern to display in the member list. Leave blank to display all members.

Generation limit

Defines the maximum number of generations to be displayed for each member. Specify a value in the range 0 to 2000000000 or leave the field blank to indicate no limit. This field is ignored for data sets that do not support member generations.

Parent panels

- [Copybook and Template Utility functions panel on page 809](#)

Template Member List panel

Figure 82. Template Member List panel

Process	Options	Help							
File Manager	Template Member List	Row 00001 of 00108							
Command ==>		Scroll CSR							
Data set name .	TEMPLATE.PDSEV2	Generation limit							
Member *									
Compare option 1	1. ISPF 2. SuperC 3. File Manager								
Name	Prompt	Rel	Gen	Type	Created	Updated	Lock	LZ	_
*	*			*	*	*	*	*	
ARRAY		0	0	BASE	2018/01/08	2020/01/09 10:24:23			
ASCII		0	0	DYN	2013/09/18	2013/09/18 09:18:32			
AZNOSEG		0	0	BASE	2005/03/19	2017/07/28 14:26:01			
AZOFF		0	0	BASE	2005/03/19	2014/11/14 09:10:20			
A61D		0	0	IMS	2018/06/05	2020/01/08 14:48:38			
BNPP		0	0	BASE	2013/08/07	2013/08/07 10:12:13			
BNPPRX		0	0	BASE	2013/08/07	2013/09/11 14:32:22			
CCSID930		0	0	DYN	2018/08/01	2018/08/01 13:59:39			
CISH#3		0	0	IMS	2005/07/18	2016/11/30 14:03:11			
CM1T072		0	0	DYN	2015/10/26	2015/10/26 15:49:12			
COBOLNAT		0	0	BASE	2018/06/08	2018/06/08 11:57:02			
COPYSYSL		0	0	BASE	2014/01/30	2014/02/27 11:03:14			

The Template Member List panel is displayed when a valid partitioned data set is provided via the entry panel or the alternate methods of Template List invocation.

Customizing and sorting columns

The Template Member List panel displays a selection list of customizable columns. You can:

- Select and order columns.
- Change column widths.
- Change the sort order for column values.
- Provide filters for each column.
- Scroll right (F11) and left (F10) if the screen width does not accommodate all the columns.

You can customize all columns using the TAILOR primary command. You can customize displayed columns by positioning the cursor on the filter value and pressing Enter.

You can change the sort order of the column values using the following methods:

- Position the cursor on the header for the field and press Enter. This sorts the list using the default sort order for that field.
- If the sort order indicator is displayed in the rightmost position of the header for the field, position the cursor on the sort order indicator and press Enter. This sorts the list using the next sort order sequence for that field (either Ascending, Descending, None).
- Issue the SORT command.
- Issue the TAILOR command and change the SORT sequence for any number of fields.

Field descriptions

For details of the columns displayed in the member list, see [Column descriptions on page 280](#).

Data set name

Specify a fully qualified or generic data set name of either a PDS or PDSE.

- Specify a generic data set name to select a data set from the selection list for processing by the PDSE Workbench.
- Leave the data set name blank to select from the history of up to 50 of the previous data sets used by the PDSE Workbench.

Member name

Specify a member name or member name pattern to display in the member list. Leave blank to display all members.

Generation limit

Defines the maximum number of generations to be displayed for each member. Specify a value in the range 0 to 2000000000 or leave the field blank to indicate no limit. This field is ignored for data sets that do not support member generations.

Compare option

The compare is done on exported (XML) versions of the templates in temporary data sets. Enter one of the following values to select the compare utility to be used with a compare prefix command (CC, CN, CP, or CS):

1. ISPF Edit compare, using the ISPF VIEW service. This is the default option.
2. SuperC compare.
3. File Manager Compare function (DSM).

Primary commands

The Template List supports the following primary commands for working with member lists.

- [BOTTOM primary command on page 1122](#)
- [DELETE \(members\) primary command on page 1143](#)
- [DOWN primary command on page 1146](#)
- [FIND/RFIND primary command on page 1161](#)
- [HEX primary command on page 1172](#)
- [HIDE primary command on page 1173](#)
- [LEFT primary command on page 1178](#)
- [LOCATE primary command on page 1184](#)
- [REFRESH primary command on page 1205](#)
- [RESET primary command on page 1210](#)
- [RFIND primary command on page 1211](#)

- [RIGHT primary command on page 1212](#)
- [SORT primary command on page 1226](#)
- [TAILOR primary command on page 1230](#)
- [TOP primary command on page 1232](#)
- [UP primary command on page 1234](#)

Prefix commands

The Template List supports the following prefix commands for working with member lists.

Browse

Browse the member, current member, or member generation using the ISPF Browse service.

Copy

For PDS, PDSE, and current members:

- Copy the member and any related aliases.

For member generations:

- Copy the member generation and save as a current member.



Note: COPY is not supported for member generation load modules, or program objects.

CC

Compare the selected member generation to the current member.



Note: The CC command is only available for PDSEs that are defined to support member generations.

CN

Compare the selected current member or member generation to the next generation of the same member in the member list.



Note: The CN command is only available for PDSEs that are defined to support member generations.

CP

Compare the selected member generation to the previous generation or the current generation of the same member in the member list.



Note: The CP command is only available for PDSEs that are defined to support member generations.

CS

Compare the selected member, current member, or member generation to another member, current member or member generation of the same data set. A Compare Selection List panel is displayed to allow the member or member generation to be selected.

Delete

For current members, perform one of the following actions:

- Delete the current member, related aliases, and all member generations.
- Delete the current member and any related aliases, then recover the most recent generation to become the current member.

For member generations:

- Delete the member generation.



Note: Deleting a member generation does not alter the absolute generation number of other member generations. Absolute generation numbers are never reused, even if a current member and all of its generations are deleted.

For all other data sets:

- Delete the member and any related aliases.

Edit

Edit the template using the template editor.



Note: If changes are made to a generation member the SAVEAS prompt is issued.

L

Toggle the lock value for the template.



Note: A locked template cannot be overwritten during a template edit – so a SAVEAS prompt is issued if changes are made during the edit session.

Move

For PDS, PDSE, and current members:

- Move the member and any related aliases.

For member generations:

- Move the member generation and save it as the current member.



Note: MOVE is not supported for member generation load modules, or program objects.

Print

Print the template using the Template View and Print utility.

Rename

For current members:

- Rename the current member and all member generations.

For member generations:

- Rename is not supported.

For all other data sets:

- Rename the member.

RG

Recover the selected member generation so that it becomes the current member. The previous current member becomes relative generation -1.

S

Select the member to invoke:

- ISPF Edit for current members.
- ISPF View for generation members.

View

View the template using the Template View and Print utility.

Z

Toggle the global leading zero default for the template.

Column descriptions

For details of the fields displayed in the member list, see [Field descriptions on page 277](#).

(prefix area)

You can enter commands in the prefix area before each row in the member list. For details of the supported commands, see [Prefix commands on page 278](#).

Name

The name of the member.

Where generation information is displayed:

- Current members (generation 0) are highlighted in white.
- Member generations are blue.
- Orphaned member generations (without a generation 0) are red.

Where alias information is displayed:

- Primary members are highlighted in white.
- Aliases are blue.

Prompt

A dynamic area that displays the last action that occurred for the listed member.

Rel

This is the relative generation number of the member generation. The relative generation is either 0 or a negative number. The current member always has a relative generation = 0, with the most recent generation created having a relative generation of -1, then -2, and so on. The maximum number of generations is defined by the MAXGENS parameter when the PDSE version 2 data set is created.

Gen

This is the absolute generation number of the member generation. The absolute generation is either 0 or a positive number. The current member always has an absolute generation = 0. The absolute generation number is 1 for the first generation and incremented by 1 for each new generation.



Note: **GEN** and **REL** columns only appear when viewing a PDSE version 2 data set with a non-zero generation limit.

Type

One of the following values is displayed:

- **BASE:** File Manager Base component template created from copybooks
- **DYN:** Dynamic template
- **IMS:** IMS template
- **VIEW:** IMS view
- **CRIT:** IMS criteria set

- **IMSX**: IMS extract template
- **DB2**: Db2 template

Created

The date the template was created in YYYY/MM/DD format.

Updated

The date and time the template was updated in YYYY/MM/DD HH:mm:SS format.

Lock

This column contains the value **Lock** if the template is locked.



Note: Use the **L** prefix command to toggle this value.

LZ

This contains the value **Y** if the default formatting for numeric fields is set to show leading zeros.



Note: Use the **Z** prefix command to toggle this value.

LANG

The original language of the copybooks from which the fields in the template were derived. The value is blank, **COBOL**, **PL/I**, or **HLASM**.

VER

The template version.

Description

The first line of the description that can be entered using the template edit **DESCRIBE** command.

SSID

The Db2 subsystem where the object used to build the template originated. (Db2 templates only.)

Owner

The owner of the associated Db2 object.

Object Name

The associated Db2 object name described by this template.

DBD

This column contains a value for IMS templates, views and criteria sets. It identifies where the DBD that was used to create the template segment list comes from. When it comes from a DBD library, the DBD library member is displayed. When it comes from an IMS catalog, the name of the subsystem that uses the IMS catalog followed by the database name is displayed.

Template

This column contains a value for IMS views and criteria sets. It shows the template data set member that was used to create the view or criteria set.

Chapter 6. Filtering records with templates

Once you have created your templates, you can use them to select records within data sets, and then display, copy, print or otherwise manipulate the selected records.

The major tasks and concepts described in this chapter are:

1. [Selecting records with templates on page 284](#)
2. [Defining criteria expressions on page 289](#)
3. [Filtering record display using templates on page 309](#)

Selecting records with templates

When working with a data set in a panel or function, you can use a template to select the specific records that you want to use. You can specify two levels of criteria to select the records you want to process.

Record identification criteria

This identifies the unique characteristics of a record type, enabling File Manager to distinguish it from other types of record in the same data set. By default, if you do not specify these criteria, File Manager uses record length to identify a record type.

If the length of a record matches more than one record definition in the template, and no further record identification criteria are specified, File Manager uses the first matching record type in the template to display all records.

Record selection criteria

After a record has been identified as belonging to a particular type, you can narrow down which records of that type you want to process by specifying record selection criteria.

You specify record identification criteria and record selection criteria using comparison expressions. When you specify criteria, you should be aware of the potential for incurring processing overheads as a result of invoking REXX to resolve the criteria expressions.

Related topics

- [Selecting records by record type on page 284](#)
- [Specifying record identification criteria on page 285](#)
- [Specifying record selection criteria on page 287](#)

Selecting records by record type

When working with a data set that contains records of more than one record type, you need to use a copybook or copybook template that describes each type. Dynamic templates cannot be used as they cannot specify more than one record type. Provided that the copybook or copybook template contains more than one type description, each time that you opt to edit the template, the Record Type Selection panel displays a list of record types.

Related topics

[Field Selection/Edit panel on page 891](#)

[Record Type Selection panel on page 998](#)

Related concepts

[Improving performance using internal expression processing on page 295](#)

To select records for viewing or editing using record type:

1. On your entry panel, specify a copybook or copybook template that contains more than one record type and edit the template.

This can be done in a number of ways. For example, from the View Entry, Edit Entry or various Utilities panels, you can select the Edit Template option; on the View or Edit panels, you can enter the `TE` command; or on the Template Workbench panel, you can enter the `E` command.

The Record Type Selection panel is displayed.

2. On the Record Type Selection panel, type an `S` in the **Cmd** field adjacent to the type you want, and press Enter.

This toggles the record type between "selected" and "unselected". The command only affects the selection of records where File Manager can identify the record as belonging to a particular type. To do this, you may need to add record identification criteria.

Specifying record identification criteria

Where your copybook or template contains multiple records types, each type is initially distinguished by the record length. Provided that each type has a unique record length, you can select and display the various types. However, if two or more of the record types have the same length, you need to supply some record identification criteria. This usually takes the form of a field that contains a value unique to each record of the same type.

For example, in the following copybook definition, the Orders and Item records are of different lengths. As such, they can be selected and displayed without additional identification criteria.

```
01 ORDERS.
  05 ORDER-ID      PIC X(5) .
  05 CUSTOMER-ID   PIC X(5) .
  05 ORDER-DATE.
    10 ORDER-YEAR  PIC 9(4) .
    10 ORDER-MONTH PIC 9(2) .
    10 ORDER-DAY   PIC 9(2) .
01 ITEM.
  05 PRODUCT-ID    PIC X(9) .
  05 QUANTITY      PIC 9(4) BINARY .
  05 UNIT-COST     PIC 9(8) BINARY .
```

However, if the records are of identical length, such as in the sample copybook shown below, File Manager is unable to distinguish between these records unless some record identification criteria is used. By examining the data, we can

determine that in all REC-TYPE01 records, the REC-TYPE field contains the value '01', and in all REC-TYPE02 records, the REC-TYPE field value is '02'. In this case, both record types include a REC-TYPE field, however, each record type does not need to use the same field in its identification.

```

01 REC-TYPE01.
  05 REC-TYPE          PIC XX.
  05 NAME              PIC X(20).
  05 EMPLOYEE-NO      PIC 9(4) BINARY.
  05 AGE               PIC 9(4) BINARY.
  05 SALARY            PIC 9(7) PACKED-DECIMAL.
  05 MONTH             PIC 9(8) BINARY OCCURS 12 TIMES.
  05 FILLER            PIC XX.
01 REC-TYPE02.
  05 REC-TYPE          PIC XX.
  05 NAME              PIC X(20).
  05 JOB-TITLE         PIC X(14).
  05 ADDR1             PIC X(20).
  05 ADDR2             PIC X(20).
  05 POSTCODE          PIC X(4).

```

If any record types in your data have the same record length, it is strongly recommended that you specify record identification criteria to allow File Manager to distinguish between them. Otherwise, the results can be unpredictable.

Even if the length of each record type is unique, it is still recommended that you specify record identification criteria for every record type, to help isolate records that match the length of a valid record type but contain data that is invalid for that type.

To specify record identification criteria:

1. On your entry panel, specify a copybook or copybook template that contains more than one record type and edit the template.

This can be done in a number of ways. For example, from the View Entry, Edit Entry or various Utilities panels, you can select the Edit Template option; on the View or Edit panels, you can enter the `TE` command; or on the Template Workbench panel, you can enter the `E` command.

The Record Type Selection panel is displayed.

2. In the **Cmd** field adjacent to the type you want to edit, type the `E` prefix command and press Enter.

The Field Selection/Edit panel is displayed.

3. Do one of the following:
 - Enter a freeform expression in the **Record Identification Criteria** field.
 - Type `1` on the Command Line and press Enter, then specify your record identification criteria by field.

The Record Identification Criteria panel is displayed. This panel is identical to the Dynamic Template panel, except that:

- the **Field Name**, **Start**, **Length** and **Type** fields are not editable;
- in an 80 x 24 display, the Field Name field is displayed by default (instead of the **Start**, **Length** and **Type** fields);

When you exit, the expression created is returned to the **Record Identification Criteria** field on the previous panel.



Note: Freeform criteria expressions and “criteria by field” expressions are mutually exclusive.

Once your records can be identified by type (either by the record length or by record identification criteria), File Manager automatically *suppresses* the display of all but one record type, depending upon the setting of the editor option `Expose (do not group) records of types: Suppressed`. By default, the first record type identified is displayed.

Related topics

[Defining criteria expressions on page 289](#)

[Displaying "suppressed" records on page 309](#)

Related concepts

[About expression processing on page 295](#)

Specifying record selection criteria

After specifying the record identification criteria for each record type, you can specify selection criteria to limit which records from that type you want to work with.

To specify record selection criteria:

1. From your entry panel, edit the template.

This can be done in a number of ways. For example, from the View Entry, Edit Entry or various Utilities panels, you can select the Edit Template option; on the View or Edit panels, you can enter the `TE` command; or on the Template Workbench panel, you can enter the `E` command.

If the template contains only one record type, the Field Selection/Edit panel is displayed immediately.

If the template contains more than one record type, the Record Type Selection panel is displayed. In the **Cmd** field adjacent to the type you want to edit, type the `E` prefix command and press Enter. The Field Selection/Edit panel is displayed.

2. Perform either of these actions

- Enter a freeform expression in the **Record Selection Criteria** field.
- Type `2` on the Command Line and press Enter, then specify your record selection criteria by field.

The Edit Record Selection Criteria panel is displayed. This panel is identical to the Dynamic Template panel, except that:

- the **Field Name**, **Start**, **Length** and **Type** fields are not editable;
- in an 80 x 24 display, the Field Name field is displayed by default (instead of the **Start**, **Length** and **Type** fields).

When you exit, the expression is returned to the **Record Selection Criteria** field on the previous panel.



Note: Freeform criteria expressions and "criteria by field" expressions are mutually exclusive.

Related topics

[Defining criteria expressions on page 289](#)

[Displaying "not-selected" records on page 311](#)

Related concepts

[About expression processing on page 295](#)

Specifying offset values

When you are editing a template, you can enter an offset value in the Field Selection/Edit panel to change the starting position of the currently displayed record type. If the template contains more than one Level 01 field, you can use the OFFSET primary command in the Record Type Selection panel to change one or more Level 01 fields. (For an explanation of how the offset values work, see [Adjusting your view to allow for header information on page 316.](#))

To change the offset in a single record type:

1. From your entry panel, edit the template.

This can be done in a number of ways. For example, from the View Entry, Edit Entry or various Utilities panels, you can select the Edit Template option; on the View or Edit panels, you can enter the `TE` command; or on the Template Workbench panel, you can enter the `E` command.

2. If there are multiple record types in your template, enter `E` in the prefix command line, adjacent to the record type you want to edit.
3. In the Field Selection/Edit panel, enter a positive or negative number, between -32760 and 32760, in the Offset field.

The offset value is added to the record length of the Level 01 field and to the starting position of all fields within the record type.

To change the offset in multiple record types:

1. From your entry panel, edit the template.

This can be done in a number of ways. For example, from the View Entry, Edit Entry or various Utilities panels, you can select the Edit Template option; on the View or Edit panels, you can enter the `TE` command; or on the Template Workbench panel, you can enter the `E` command.

2. If there are multiple record types in your template, the Record Type Selection panel is displayed.
3. On the Command line, enter the OFFSET primary command and the offset value. For more information on the behavior of the OFFSET primary command in this panel, see [Record Type Selection panel on page 998](#).

By default, the offset value is applied to all record types with a current offset value of zero. To apply the offset value to all record types in the template, regardless of the current offset value, use the ALL keyword with the primary command. To apply the offset value to a specific record type, specify the field name with the primary command.

The offset value is added to the record length of the Level 01 field and to the starting position of all fields within the specified record type or types.

Defining criteria expressions

This section describes the ways in which you can enter criteria expressions to select records; outlines how the expressions are evaluated and processed within File Manager and provides a list of operators and functions that can be used in criteria expressions.

To specify record identification or record selection criteria, you can enter a freeform expression into a relevant field or you can build the expression “by field”. These methods are mutually exclusive. If you create a freeform expression and then create an expression by field, your freeform expression is overwritten. Once you have specified an expression by field, you cannot enter a free form expression until you delete the “by field” expression from the relevant panel.

Related topics

[Entering criteria as a freeform expression on page 289](#)

[Entering criteria by field on page 291](#)

Related concepts

[About expression processing on page 295](#)

Entering criteria as a freeform expression

To enter a freeform expression:

1. Display the Field Selection/Edit panel for your template.
2. In either the **Record Identification Criteria** or **Record Selection Criteria** fields, enter the freeform expression.
3. Press Enter.

File Manager evaluates the expression to see if it can be processed internally or needs to be passed to REXX. If REXX is required, the message "REXX required" is displayed in the upper right corner. You can choose to either modify the expression so that REXX is not required, or use the expression with REXX processing instead of internal processing.

4. Press Exit (F3) to save your criteria and return to your starting panel.

A freeform expression must take the form of:

```
#ref comp-op value
```

#ref

Field that returns a value from the current record to be used in the expression. Fields are identified using the # symbol, followed by the field Reference number, for example #5.

You can also use the value returned by performing a calculation with a number of fields, for example (#5 + #6). To do this, you must embed the calculation within parentheses and use valid arithmetic operators, together with at least one field reference.

Another alternative is to use a REXX function that lists at least one field as an argument, for example MAX(#5,#6,#7).

comp-op

Comparison Operator. A symbol that expresses the way in which the value derived from the field or field calculation is to be compared with *value*, for example the ">" symbol represents "is greater than". File Manager supports all of the REXX comparison operators.

value

Any expression that returns a single value to be used in the criteria expression. This can take the form of a string, a numeric value, a field, a calculation that returns a value or a REXX function.

Logical operators, such as AND (&) and OR (!) can be used to create multiple criteria expressions. Parentheses can be used to control the order of evaluation in calculations and criteria expressions.



Note: At least one field reference must be made in the criteria expression. It is common practice to put this reference on the left side of the equation, although it works equally well on the right side. That is, while #5 > 100 is the more usual way of expressing this criteria, writing it as 100 <= #5 does not cause an error (note the reversal of the comparison operator). If no field reference is included, the criteria are evaluated as either true or false on their own merit and, when true, all records are returned or, when false, all records become "not-selected".

Related concepts

[About expression processing on page 295](#)

[Improving performance using internal expression processing on page 295](#)

[Overview of REXX expressions on page 297](#)

[Comparison operators on page 301](#)

[Arithmetic operators on page 303](#)

[Logical \(boolean\) operators on page 305](#)

[Useful functions on page 306](#)

Entering criteria by field

"Criteria by field" expressions can be entered on any of these panels:

- Dynamic Template
- Record Identification Criteria
- Record Selection Criteria
- Related ID expression panel

For the purpose of entering criteria "by field", these panels operate in an identical manner.

To enter a single criteria expression by field:

1. Display the appropriate panel for your needs.
2. Type an operator in the **Op** field and a value in the **Value** field.
3. Press Enter.

File Manager evaluates the expression to see if it can be processed internally or needs to be passed to REXX. If REXX is required, the message "REXX required" is displayed in the upper right corner when you press Enter on the relevant panel. You can choose to either modify the expression so that REXX is not required, or use the expression with REXX processing instead of internal processing.



Note: When exiting from the Record Identification Criteria or Record Selection Criteria panels, your "by field" expression replaces any existing freeform expressions in the relevant field of the Field Selection/Edit panel.

To enter multiple criteria expressions by field:

1. Display the appropriate panel for your needs.
2. Type an operator and value for the each criteria in the appropriate fields.
3. Where you want to use the same field for a number of different criteria, use the available prefix commands to copy and rearrange field definitions within the panel.
4. Use the AND and OR connectors to join the various expressions.
5. Use the (and) parenthesis fields to group your expressions.
6. Press Enter.

File Manager evaluates the expression to see if it can be processed internally or needs to be passed to REXX.

For example, using the sample data, you may want to display all the Programmers or Developers in your list. To do this, you would need the Job Title field to appear twice in the panel, each with an operator and value, and you would use the OR connector to join them.

```

:
Cmd Con ( Field Name      Op Value
*** **** Top of data ****
---- ---- - REC-TYPE02
---- AND - REC-TYPE
---- AND - NAME
---- AND - JOB-TITLE      =-- Programmer
---- OR - JOB-TITLE      =-- Developer
---- AND - ADDR1
:

```

- [Dynamic Template panel on page 845](#)
- [Record Identification Criteria panel on page 982](#)
- [Record Selection Criteria panel on page 991](#)
- [Related ID expression panel on page 1002](#)

Entering criteria expressions for an array element

You can enter criteria expressions by field for an array element (a data element with an OCCURS clause in COBOL).

You can refer to a subscripted data item on the "by field" display, and optionally enter a subscript, operator, and one or more values. The expression generated uses the TFLD external REXX function.

Alternatively, you can code a free-form expression that refers to any or all the elements of an array by using the TFLD external REXX function.

Figure 83: Record layout containing an array element on page 292 shows a record layout containing an array element (MONTH-DETAILS).

Figure 83. Record layout containing an array element

```

  Process  Options  Help
-----
File Manager                Field Selection/Edit                Line 1 of 11
-----
Criteria - Enter 1 or 2 to specify expression by field -----
1 Id : _____ +
2 Sel: _____ +
Offset      0
Cmd Seq SHE Ref Field Name      Picture  Type Start Length
-----
          **** Top of data ****
          1 1 RFM0411
          2 2 REC-TYPE            X        AN    1     1
          3 2 FILLER              X(5)     AN    2     5
          4 2 CONTRACTOR          X(40)    AN    7    40
          5 2 SERIAL-NO           999999   ZD    47     6
          6 2 MONTH-DETAILS OCCURS 12 TIMES
          7 3 PAY                  S9(8)    ZD    53     8
          8 3 JOB-LOCATION          X(20)    AN    61    20
          9 3 CONTRACT-NO         999999   ZD    81     6
          10 3 FIRST-NAME         X(20)    AN    87    20
          11 3 SURNAME            X(20)    AN   107   20
Command ==>
F1=Help      F2=Split    F3=Exit     F4=Expand   F5=RFind    F6=RunTemp
F7=Up        F8=Down     F9=Swap     F10=Left    F11=Right   F12=Cancel

```

Enter "1" to display the Record Identification Criteria panel shown in [Figure 84: Record Identification Criteria panel on page 293](#):

Figure 84. Record Identification Criteria panel

Process	Options	Help
File Manager	Record Identification Criteria	Line 1 of 11
Cmd	Con (Field Name	Op Value)
<->	<-----1-----2-----3----->	<-> <+-----1-----2-----+ -
***	**** Top of data ****	
---	RFM0411	---
---	AND REC-TYPE	---
---	AND FILLER	---
---	AND CONTRACTOR	---
---	AND SERIAL-NO	---
---	AND MONTH-DETAILS()	---
---	AND PAY()	---
---	AND JOB-LOCATION()	---
---	AND CONTRACT-NO()	---
---	AND FIRST-NAME()	---
---	AND SURNAME()	---
***	**** End of data ****	
Command ==>		
F1=Help	F2=Split	F3=Exit
F7=Up	F8=Down	F9=Swap
F4=Expand	F5=RFind	F6=RunTemp
F10=Left	F11=Right	F12=Cancel
		Scroll CSR

The fields suffixed "()" are dimensioned fields.

Figure 85: Subscripted values specified for dimensioned fields on page 293 shows criteria expressions specified for some of the dimensioned fields within MONTH-DETAILS:

Figure 85. Subscripted values specified for dimensioned fields

Process	Options	Help
File Manager	Record Identification Criteria	Line 1 of 11
Cmd	Con (Field Name	Op Value)
<->	<-----1-----2-----3----->	<-> <+-----1-----2-----+ -
***	**** Top of data ****	
---	RFM0411	---
---	AND REC-TYPE	---
---	AND FILLER	---
---	AND CONTRACTOR	---
---	AND SERIAL-NO	---
---	AND MONTH-DETAILS()	---
---	AND PAY()	> (ALL) 5000
---	AND JOB-LOCATION()	= (1) 'Kimberly'
---	AND CONTRACT-NO()	---
---	AND FIRST-NAME()	---
---	AND SURNAME()	CO 'SMITH', 'JONES'
***	**** End of data ****	
Command ==>		
F1=Help	F2=Split	F3=Exit
F7=Up	F8=Down	F9=Swap
F4=Expand	F5=RFind	F6=RunTemp
F10=Left	F11=Right	F12=Cancel
		Scroll CSR

In Figure 85: Subscripted values specified for dimensioned fields on page 293:

- The default subscript is (ANY) indicating that at least one element must satisfy the condition.
- (ALL) indicates that all elements must satisfy the condition.
- (1) indicates the first element must satisfy the condition.

After entering the criteria as shown in [Figure 85: Subscripted values specified for dimensioned fields on page 293](#), pressing F3 causes File Manager to generate the expression:

```
TFLD('#7(ALL)', '>', 5000) & #8(1) = 'Kimberly' & TFLD('#11', 'CO', 'SMITH', 'JONES')
```

as shown in [Figure 86: TFLD expression generated for fields in an array on page 294](#).



Note: The TFLD function is generated (instead of the FLD_CO function) when the CO, or -CO operators are specified.

Figure 86. TFLD expression generated for fields in an array

Process	Options	Help
File Manager	Field Selection/Edit	Line 1 of 11
----- Criteria - Enter 1 or 2 to specify expression by field -----		
1 Id :	TFLD('#7(ALL)', '>', 5000) & #8(1) = 'Kimberly' & TFLD('#11', 'CO', 'SMI	+
2 Sel:		+
Offset	0	
Cmd Seq	SHE Ref Field Name	Picture Type Start Length
	**** Top of data ****	
___ ___	1 1 RFM0411	AN 1 940
___ ___	2 2 REC-TYPE	X AN 1 1
___ ___	3 2 FILLER	X(5) AN 2 5
___ ___	4 2 CONTRACTOR	X(40) AN 7 40
___ ___	5 2 SERIAL-NO	999999 ZD 47 6
___ ___	6 2 MONTH-DETAILS OCCURS 12 TIMES	AN 53 74
___ ___	7 3 PAY	S9(8) ZD 53 8
___ ___	8 3 JOB-LOCATION	X(20) AN 61 20
___ ___	9 3 CONTRACT-NO	999999 ZD 81 6
___ ___	10 3 FIRST-NAME	X(20) AN 87 20
___ ___	11 3 SURNAME	X(20) AN 107 20
Command ==>		Scroll CSR
F1=Help	F2=Split	F3=Exit
F7=Up	F8=Down	F9=Swap
	F4=Expand	F5=RFind
	F10=Left	F6=RunTemp
		F11=Right
		F12=Cancel

Related topics

- [TFLD on page 1703](#)
- [Record Identification Criteria panel on page 982](#)

Related topics

- [Dynamic Template panel on page 845](#)

Related concepts

- [About expression processing on page 295](#)
- [Improving performance using internal expression processing on page 295](#)
- [Overview of REXX expressions on page 297](#)
- [Comparison operators on page 301](#)
- [Arithmetic operators on page 303](#)
- [Logical \(boolean\) operators on page 305](#)
- [Useful functions on page 306](#)

Entering criteria for date and time fields

For a date and time field you can enter in the **Value** field a date and time string. The string must be specified in the output format defined for the field and must be prefixed by the character **d** to indicate a date string or **t** to indicate a time string. The following is an example of a date value:

```
d'Jan 01, 2014'
```

where the output format is:

```
Mmm DD, YYYY
```

The following is an example of a time value:

```
t'15:30:00.000'
```

where the output format is:

```
HH:MI:SS.999
```

When a date value is specified the expression generated uses the CMP_DATE external REXX function. When a time value is specified the expression generated uses the CMP_TIME external REXX function.

About expression processing

When an expression is entered (freeform or “by field”), File Manager evaluates the expression to see if it can be processed internally or if it must be passed to REXX.

REXX stands for the REstructured eXtended eXecutor language. REXX is a general purpose programming language, similar to PL/I. It includes extensive parsing capabilities for character manipulation, extensive mathematical capabilities, and numerous built-in functions that perform various processing, searching, and comparison functions.

REXX programs are usually run by a language processor (interpreter). That is, the program is run statement-by-statement, without first being translated to another form (compiled). Because of the interpretive nature of REXX, File Manager is able to exploit the power of REXX when processing record identification and record selection criteria.

Although REXX is a powerful and versatile language, coding selection criteria using REXX is straightforward. You do not need to know how to write REXX programs. All you need to know is how to write REXX comparison expressions. File Manager takes care of turning your selection criteria into a REXX program.

Much of the information in this section has been extracted from the *z/OS TSO/E REXX Reference* and *z/OS TSO/E REXX User's Guide*. For more detailed information about REXX, refer to those manuals.

Improving performance using internal expression processing

For simple criteria, File Manager can process the expression internally without needing to invoke REXX. This can result in faster processing of record identification and record selection criteria. If an expression is not eligible for internal processing, File Manager displays the message “REXX required” when you press Enter on the relevant panel. In this case, you can choose

to either modify the expression so that REXX is not required, or use the expression with REXX processing instead of internal processing.

For an expression to be eligible for internal processing, it must consist only of:

- **Literal strings:** These include ordinary quoted strings as well as binary and hexadecimal strings. For a more detailed description of literal strings, see [Overview of REXX expressions on page 297](#).
- **Numerics:** Unlike REXX, the internal expression processor distinguishes between character and numeric types. To ensure internal processing uses the correct numeric value, enter numeric data as unquoted strings.

For example, the internal expression processor treats the string `5` as a number and compares it equal to any other numeric with a value of five. However, it treats the string `'5'` as character data and compares it equal to a string containing `X'F5'` (with optional leading and trailing blanks for non-strict comparison). REXX treats both strings the same and handles them as character data, but allows them to behave as numbers in appropriate contexts.

Non-floating point numerics are limited to 31 decimal digits, and floating point numerics are limited to the range of numbers that can be stored as a double-precision floating point number. See [Handling floating point numbers on page 300](#) for a more complete discussion of how the internal processor and REXX differ in the way they handle floating point numbers.

- **Comparison operators:** The internal expression processor supports all the REXX comparison operators.

The internal processor performs numeric comparisons when both operands are numeric or contain numeric data (formatted references to numeric fields, or FLD references specifying a numeric formatting type); bit comparisons when both operands are bit fields; otherwise, the internal processor performs character comparisons.

Where both operands have the same value, numeric comparisons match regardless of the length and type of the data. Bit comparisons match only when both bit fields are the same. Leading zero-bits are ignored in the longer field if the fields are not the same length. Character comparisons match only if the two strings are identical, except that leading and trailing blanks are ignored by the non-strict operators. The internal expression processor compares character strings byte by byte according to the standard EBCDIC collating sequence and, where a shorter string matches a longer string up to the end of its length, the longer string is deemed to be greater.

- **Logical operators:** The only logical operators that the internal processor allows are the AND (&), OR (!), exclusive OR (&&) and NOT (~ or \) operators.
- **Arithmetic prefix operators:** You can use the plus (+) and minus (-) operators before decimal numerics (to indicate sign), and before and within floating point numerics as defined by the REXX syntax.
- **File Manager field references:** The internal expression processor supports both formatted and unformatted references when evaluating identification or selection criteria. Field references are not supported in FASTREXX procedures.
- **Function invocations:** The following functions can be included in an expression that is to be processed internally:
 - `CMP_DATE`
 - `CMP_TIME`
 - `FLD`
 - `FLD_CO`

- FLD_TM
- FLD_TYPE
- FLDI
- FLDO
- I_LENGTH
- O_LENGTH
- PRTCOUNT
- RECSIN
- RECSOUT
- SEGCNT
- SEGNO
- TESTC
- TESTN
- TFLD

- **Parentheses**

These rules also apply when creating conditions in an IF-THEN-ELSE statement within a FASTREXX procedure.

Related concepts

[Comparison operators on page 301](#)

[Symbols on page 299](#)

[Using internal \(FASTREXX\) processing on page 524](#)

[FLD on page 1653](#)

[FLD_CO on page 1655](#)

[FLD_TM on page 1659](#)

[FLD_TYPE on page 1661](#)

[I_LENGTH on page 1666](#)

[O_LENGTH on page 1673](#)

[PRTCOUNT on page 1683](#)

[RECSIN on page 1686](#)

[RECSOUT on page 1687](#)

[TFLD on page 1703](#)

Overview of REXX expressions

REXX expressions consist of one or more *terms* interspersed with zero or more *operators* that denote operations to be carried out on terms. Expressions are evaluated left to right, modified by parentheses and by operator precedence in the usual algebraic manner. When parentheses are encountered (other than those that identify function calls), the entire sub-expression between the parentheses is evaluated immediately when the term is required. Expressions are wholly evaluated, unless an error occurs during evaluation. The REXX language uses a free format. This means you can insert extra spaces between terms without causing an error.

The terms you can use in a selection criteria expression are described below.

Literal strings

A literal string is a sequence including any characters and delimited by the quotation single mark (') or the double quotation mark ("). Use two consecutive double quotation marks (") to represent a " character within a string delimited by double quotation marks. Use two consecutive quotation marks (') to represent a ' character within a string delimited by quotation marks. A literal string is a constant and its contents are never modified when it is processed.

These are valid strings:

```
'Fred'
"Don't Panic!"
'You shouldn't' /* Same as "You shouldn't" */
```

A string followed immediately by a `_` is considered to be the name of a function. If followed immediately by the symbol `x` or `X`, it is considered to be a hexadecimal string. If followed immediately by the symbol `b` or `B`, it is considered to be a binary string.

A hexadecimal string is a literal string, expressed using a hexadecimal notation of its encoding. It is any sequence of zero or more hexadecimal digits (0-9, a-f, A-F), grouped in pairs. A single leading 0 is assumed, if necessary, at the front of the string to make an even number of hexadecimal digits. The groups of digits are optionally separated by one or more blanks, and the whole sequence is delimited by single or double quotation marks, and immediately followed by the symbol `X` or `x`. (Neither `x` nor `X` can be part of a longer symbol. A hexadecimal string is a literal string formed by packing the hexadecimal digits given. Packing the hexadecimal digits removes blanks and converts each pair of hexadecimal digits into its equivalent character, for example:

`'C1'x` is the same as the character `"A"`.

Hexadecimal strings let you include characters in a program even if you cannot directly enter the characters themselves. These are valid hexadecimal strings:

```
'ABCD'x
"1d ec f8"X
"1 d8"x
```

A binary string is a literal string, expressed using a binary representation of its encoding. It is any sequence of zero or more binary digits (0 or 1) in groups of 8 (bytes) or 4 (nibbles). The first group may have fewer than four digits; in this case, up to three 0 digits are assumed to the left of the first digit, making a total of four digits. The groups of digits are optionally separated by one or more blanks, and the whole sequence is delimited by matching single or double quotation marks and immediately followed by the symbol `b` or `B`.

A binary string is a literal string formed by packing the binary digits given. If the number of binary digits is not a multiple of eight, leading zeros are added on the left to make a multiple of eight before packing. Binary strings allow you to specify characters explicitly, bit by bit.

These are valid binary strings:

```
'11110000'b /* == 'f0'x */
"101 1101"b /* == '5d'x */
```

```
'1'b          /* == '00000001'b and '01'x */
'10000 10101010'b /* == '0001 0000 1010 1010'b */
'b           /* == '' */
```

Symbols

Character strings, without quotation marks, which are translated to uppercase. Any symbol that begins with a # is treated as a reference to a field in the record being processed, and the value of the field is used. All other symbols are treated as constants.

File Manager assigns to each field defined in a template a unique field reference number. When you want to refer to a field in a selection criteria expression, you specify the field's Reference number prefixed by #. You can only refer to fields defined in the record you are currently working with. You cannot refer to fields defined in a different record type. In record identification criteria, you can only refer to fields defined in the static portion of the record (that is, the portion of the record that precedes any variable-length array defined with the OCCURS DEPENDING ON clause).

REXX expression evaluation only processes data in the form of “typeless” character strings (typeless because they are not, as in the case of COBOL, of a particular data type such as binary, packed-decimal, and so forth). Therefore, when you refer to a numeric field, File Manager converts the value of the field to a numeric character string that can be processed by REXX when evaluating the selection criteria expression. The number of integer and decimal digits in the character string is determined by the field definition in your template. For example, if you refer to a packed-decimal field with a COBOL PICTURE clause of 999V99, File Manager converts the value of the field to a character string consisting of numeric digits, a period for the virtual decimal place, and, if the value of the field is negative, a leading sign character (such as -123.45). Note that all numeric fields are treated as signed, regardless of whether the COBOL PICTURE clause contains a sign symbol.

Occasionally, you might want to evaluate the value of a numeric field without converting it to a numeric character string. To do this, prefix the field reference number by #u instead of #. This tells File Manager not to convert the number to a numeric character string. For example, if you wanted to test a two-byte binary numeric field (with a field reference number of 45) for a special value of X'FFFF', you could code:

```
#u45 == 'FFFF'x
```

When you refer to a field in an array, you must qualify the field reference with the required number of subscripts enclosed in parentheses and separated by commas. The number of subscripts you specify must equal the number of dimensions in the array that contains the field you are referencing. In COBOL terms, there must be a subscript for each OCCURS clause in the hierarchy containing the field, including any OCCURS clause for the field itself. Each subscript you specify must be a positive integer in the range 1 to the maximum number of occurrences of the field as specified in the OCCURS clauses. If the field you refer to is in a variable-length array (specified using the OCCURS DEPENDING ON clause), you should ensure that you do not refer to an occurrence of the field that, for any given record, might not exist. If you do refer to a non-existent field, the selection criteria cannot be satisfied, and the record is not selected.



Note: The object of an OCCURS DEPENDING ON clause must be defined as a field in the static portion of the same record as the array (that is, the portion of the record that precedes any variable-length array



defined with the OCCURS DEPENDING ON clause). If the object of the OCCURS DEPENDING ON clause is not so defined, you cannot refer to any fields in the array or any fields in the record that follow the array.

Function call

A call to a REXX built-in function.

Sub-expressions

Terms in an expression bracketed within left and right parentheses.

Related concepts

[Support for variable-length arrays on page 182](#)

Handling floating point numbers

The internal expression processor operates on internal floating point fields in their native, hexadecimal floating point format. External floating point fields are converted to double-precision internal format before being processed as if they were internal floating point fields. If two fields in a comparison have different precisions, then the field with the greater precision is rounded to the lesser precision, and the comparison is performed using the lesser precision. Because internal floating point fields are converted to external (decimal) format and passed to REXX as strings, and external floating point fields are also passed as strings, the result of evaluating a comparison can differ between REXX and the internal expression processor.

To ensure consistency, pay attention to the following points when coding expressions involving floating point fields:

- When comparing a floating point field to a constant, make sure you use a constant that matches the external representation used by FMN. For example, `-2.2527494E+08` and `-2.2527495E+08` are both stored as `'C7D6D6C4'x` when entered for a single-precision floating point field, but File Manager always displays the data as `-2.2527494E+08`. Using either value matches with the internal expression processor, but only `-2.2527494E+08` matches with REXX.
- Use hex strings and unformatted field references instead of external format to precisely represent internal floating point values. For example, instead of `#2 = -2.2527494E+08` you can use `#U2 = x2c(C7D6D6C4)`. This technique can only be applied if your expression requires REXX, because the `x2c()` function is not processed internally.
- Comparing floating point fields with different precisions using REXX might not produce the results expected because the external representations of floating point numbers with values that match (with or without rounding) but with different precisions are generally not the same. For example, the external representation of `'C7D6D6C4'x (-2.2527494E+08)` is different from that for `'C7D6D6C4 00000000'x (-2.2527494400000000E+08)` because the extra precision of the field produces a more precise external representation. This situation, where the internal values match exactly can be handled in REXX by truncating the longer field (assuming `#2` refers to a short float and `#3` refers to a long float):

```
#U2 = Substr(#U3,1,4)
```

Simulating the rounding process to achieve the same results as the internal processor, and therefore achieving a more general test of equality between fields of different precision requires the following extraordinary expression:

```
#U2 = d2c(c2d(Substr(#U3,1,4))+Substr(x2b(c2x(Substr(#U3,5,1))),1,1),4)
```

This works by:

- Truncating the long float to four bytes and converting it to decimal.
- Adding the high-order byte of the discarded half of the characteristic.
- Converting the result back to internal format.

The addition is valid because the characteristic is in the rightmost bits of the field, and any carry from the addition increments the mantissa as required. The only case it does not handle is that of exponent overflow.

Comparison operators

REXX comparison operators compare two terms and return the value 1 if the result of the comparison is true, or 0 otherwise.

Comparison operators can compare numbers or character strings. The most commonly used comparison operators are:

Operator

Meaning

=

Equal

≠, \=

Not equal

<

Less than

≧, \<

Not less than

>

Greater than

≦, \>

Not greater than

<=

Less than or equal to

>=

Greater than or equal to

><

Greater than or less than (same as not equal)

<>

Less than or greater than (same as not equal)

The “not” character (≠), is synonymous with the backslash (\). You can use the two characters interchangeably.

When comparing terms using these comparison operators, if both terms in the expression are numeric, REXX performs a numeric comparison. Otherwise, both terms are treated as character strings and REXX performs character comparison. (A number in REXX is a string that contains one or more decimal digits, an optional decimal point, and an optional leading sign character. The string can contain one or more leading or trailing blanks, and the sign character can be separated from the digits by one or more blanks.)

In a character comparison, leading and trailing blanks are ignored, and the shorter string is padded with blanks on the right. Character comparisons are case-sensitive. Therefore, you should delimit character strings with quotation marks to prevent lowercase characters being translated to upper case. For example, if the field #4 contains the value `MixedCase` both the following comparison operations would be true:

```
#4 = 'MixedCase'
#4 = '  MixedCase  '
```

but the following comparison operation would not be true:

```
#4 = MixedCase
```

In numeric comparisons, the comparison is effected by subtracting the two numbers (calculating the difference) and then comparing the result with 0. For example, the comparison operation:

```
#6 = 10
```

is identical to the operation:

```
(#6 - 10) = 0
```

In addition to these comparison operators, REXX provides a number of “strict” comparison operators that are mainly intended for use when comparing character strings. The strict comparison operators all have one of the characters defining the operator doubled, such as `==` (strictly equal).

The strict comparison operators are:

Operator

Meaning

`==`

Strictly equal

`~=, \=`

Strictly not equal

`<<`

Strictly less than

`<<=, \<<`

Strictly not less than

`>>`

Strictly greater than

`->>, \>>`

Strictly not greater than

`<<=`

Strictly less than or equal to

`>>=`

Strictly greater than or equal to

When you use the `==` comparison operator (strictly equal), the two character strings being compared must be identical (character by character) and of the same length to be considered strictly equal. Leading and trailing blanks are significant. For example, continuing the example using field `#4` that contains the value `MixedCase`, only the first of the following comparison operations would be true:

```
#4 == 'MixedCase'
#4 == '  MixedCase  '
```

Similarly, the strict comparison operators such as `>>` or `<<` carry out a simple character-by-character comparison, with no padding of either of the strings being compared. The comparison of the two strings is from left to right. If one string is shorter than and is a leading substring of another, then it is smaller than (less than) the other. The strict comparison operators do not attempt to perform a numeric comparison on the two terms, and should not be used to compare numeric fields.

Arithmetic operators

You can process numeric terms in comparison expressions using the arithmetic operators:

Operator

Meaning

`+`

Add

`-`

Minus

`*`

Multiply

`/`

Divide

`%`

Integer divide (divide and return the integer part of the result)

`//`

Remainder (divide and return the remainder—not modulo, because the result might be negative)

**

Power[®] (raise a number to a whole-number power)**Prefix -**Same as the subtraction: `0 - number`**Prefix +**Same as the addition: `0 + number`

You can use these operators to produce an intermediate result that you can compare with another term. For example, if the field #6 contains a numeric value representing an employee's annual salary, and the fields #15 and #23 contain numeric values representing the employee's annual travel allowance and annual bonus, respectively, you could use the following comparison to select records for employees with a combined annual payment of greater than \$100,000:

```
(#6 + #15 + #23) > 100000
```

For another example, if field #45 contains the number of sick days an employee is entitled to annually, and the field #46 contains the number of sick days an employee has used in the current year, you could use the following comparison to select records for employees who have used 50% or more of their sick day entitlements:

```
(#46 / #45) >= .5
```



Note: In each of these examples, the arithmetic sub-expression is contained in parentheses. This ensures that the entire sub-expression is evaluated before the comparison operation.

The order of precedence of arithmetic operators is as follows (highest is at the top):

Operator**Meaning**

+ - * \

Prefix operators

**

Power[®]

* /

Multiply and divide

+ -

Add and subtract

For example, * (multiply) has a higher priority than + (add), so `3+2*5` evaluates as `13` (rather than the `25` that would result if strict left to right evaluation occurred). To force the addition to occur before the multiplication, you could rewrite the expression as `(3+2)*5`. Adding the parentheses makes the first three tokens a sub-expression.

Logical (boolean) operators

REXX comparison expressions return a true (1) or false (0) value when processed. Logical operators combine two comparisons and return the true (1) or false (0) value depending on the results of the comparisons.

The logical operators are:

Operator

Meaning

&

AND

Returns 1 if both comparisons are true. For example:

```
(4 > 2) & (a = a)      /* true, so result is 1 */
(2 > 4) & (a = a)      /* false, so result is 0 */
```

|

Inclusive OR

Returns 1 if at least one comparison is true. For example:

```
(4 > 2) | (5 = 3)      /* at least one is true, so result is 1 */
(2 > 4) | (5 = 3)      /* neither one is true, so result is 0 */
```

&&

Exclusive OR

Returns 1 if only one comparison (but not both) is true. For example:

```
(4 > 2) && (5 = 3)     /* only one is true, so result is 1 */
(4 > 2) && (5 = 5)     /* both are true, so result is 0 */
(2 > 4) && (5 = 3)     /* neither one is true, so result is 0 */
```

Prefix - \

Logical NOT

Returns the opposite response. For example:

```
\ 0                    /* opposite of 0, so result is 1 */
\ (4 > 2)                /* opposite of true, so result is 0 */
```

Logical expressions are used in complex comparisons and can act as checkpoints to stop unwanted conditions (such as testing a field for a value of zero before using it as a divisor). When you have a series of logical expressions, for clarification, use one or more sets of parentheses to enclose each expression. For example:

```
(#46 = 999) | ((#45 > 0) & (#46 / #45) >= .5)
```

Useful functions

REXX provides a rich set of built-in functions, including character manipulation and conversion functions. Some of these functions might be of use when you are writing your comparison expressions, and they are described below. File Manager also provides some functions that might be of use. They are also described below. To call a function, type the function name directly followed by one or more arguments within parentheses. There can be no space between the function name and the left parenthesis. For example:

```
function(arguments)
```

A function call can contain up to 20 arguments separated by commas. Each argument can be one or more of the following:

Argument

Example

Blank

```
function()
```

Constant

```
function(55)
```

Symbol

```
function(#5)
```

Literal string

```
function('With a literal string')
```

Option recognized by function

```
function(option)
```

Another function

```
function(function(arguments))
```

Combination of argument types

```
function('Literal string', #5, option)
```

Some of the built-in functions provided by REXX that you might find useful are:

ABS()

Figure 87. Syntax

```
►► ABS — (number) —◄◄
```

Returns the absolute value of a *number*. For example, if you want to select records in which field #12 contains a value in the range -10 to +10, you could specify:

```
ABS(#12) <= 10
```

MAX()

Figure 88. Syntax

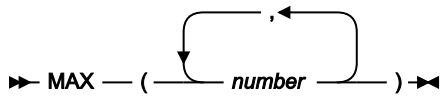

Returns the largest number from the list specified. For example, if you want to select records in which any of fields #10, #11, or #12 contains a value greater than 55, you could specify:

```
MAX(#10, #11, #12) > 55
```

MIN()

Figure 89. Syntax

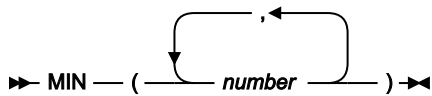

Returns the smallest number from the list specified. For example, if you want to select records in which any of fields #10, #11, or #12 contains a value less than 0, you could specify:

```
MIN(#10, #11, #12) < 0
```

POS()

Figure 90. Syntax

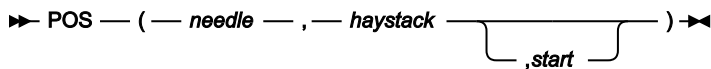

Returns the position of one string, *needle*, in another, *haystack*. Returns 0 if *needle* is a null string, or is not found in *haystack*, or if *start* is greater than the length of *haystack*. By default the search starts at the first character of *haystack* (that is, the value of *start* is 1). You can override this by specifying *start* (which must be a positive whole number), the point at which the search starts. For example, if you want to select records in which any character in field #22 is a blank, you could specify:

```
POS(' ', #22) > 0.
```

SUBSTR()

Figure 91. Syntax

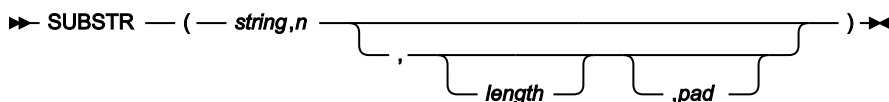

Returns the substring of *string* that begins at the *n*th character and is of length *length*, padded with *pad* if necessary. *n* is a positive whole number. If *n* is greater than the length of *string*, then only pad characters are returned.

If you omit *length*, the rest of the string is returned. The default *pad* character is a blank.

For example, if you want to select records in which characters 4-6 of field #22 are the string 'NOT', you could specify:

```
SUBSTR(#22,4,3) == 'NOT'
```

The functions provided by File Manager that you might find useful are shown below.

FLD()

Refer to a field from the current input record. For details, see [FLD on page 1653](#).

COntains()

Check a field for a list of character values. For details, see [CONTAINS on page 1644](#).

NCOntain()

Check a field for a list of numeric values. For details, see [NCONTAIN on page 1672](#).

Examples of REXX comparison expressions

The following are examples of REXX comparison expressions:

Example 1

Select records in which the transaction date (field #14) is any date in July 2000, or the transaction value (field #27) is greater than \$100,000.00

```
(#14 >= 20000701 & #14 < 20000801) | #27 > 100000.00
```

Example 2

Select records in which the count of credit notes (field #62) is greater than 10% of the count of invoices (field #61)

```
#62 > #61/10
```

Example 3

Select records in which the employee identifier (field #17) starts with any of the letters A, C, or E.

```
CO(SUBSTR(#17,1,1), 'A', 'C', 'E')
```

Example 4

Select records in which the supplier number (field #23) is 997644 or 997645, and the item description (field #33) contains the word 'CABINET'

```
NCO(#23,997644,997645) & CO(#33,'CABINET')
```

Example 5

Select records in which the 4-byte packed decimal field starting at position 17 in the record contains a negative value

```
FLD(17,4,P) < 0
```

Example 6

Select records in which either the transaction value (field #27) is greater than \$50,000.00 and the purchase order number (field #25) starts with characters other than 'TX', or the transaction value is greater than \$70,000 and the supplier number (field #23) is 984545, but not if both sets of conditions are true

```
(#27 > 50000.00 & SUBSTR(#25,1,2) != 'TX') &&
(#27 > 70000.00 & #23 = 984545)
```



Note: Examples 1 and 6 would be processed internally.

Filtering record display using templates

One of the main reasons for using a template to view your data is that it allows you to filter the display of your records by applying record identification or record selection criteria.

The tasks described in this section are:

- [Displaying "suppressed" records on page 309;](#)
- [Changing display of the record type on page 310;](#)
- [Displaying "not-selected" records on page 311;](#)
- [Hiding or showing records in SNGL display format on page 313;](#)
- [Using the SHOW command in an editor session on page 314;](#)
- [Viewing segmented data on page 314 and](#)
- [Adjusting your view to allow for header information on page 316.](#)

Displaying "suppressed" records

When you are viewing a data set using a template with multiple record types, you can instruct File Manager to include all record types in actions of commands, or only the record type that is current. Only one record type can be "current" at any one time. The inclusion of all record types, or limiting to one record type, is controlled by the SHOW SUP command setting. Once your records can be identified by type (either by the record length or by record identification criteria) and the current SHOW SUP setting is OFF, File Manager *suppresses* the display of all but one record type and groups the other record types into a single display line. By default, the first record type identified is displayed.

You can choose to hide suppressed record groups from display, or represent them by shadow lines:

```
- - - - - record type - - - - - n Line(s) suppressed
```

In TABL display format, you can only show fields from one record type on the screen at a time. Records belonging to other record types are either grouped and re-displayed as suppressed record lines or, if SHOW SUP ON is in effect or the **Expose option Suppressed on the Editor Options panel is selected**, represented by a line containing the name of their respective record type. In other display formats, there is no display limitation and the contents of records belonging to other record types are displayed.



Note: Suppressed records are only hidden from display. They are still selected and are still included in any print, copy or create data functions.

You can control whether the suppressed record groups are completely hidden or are represented by shadow lines.

- To hide the shadow line for suppressed record groups, enter `SHADOW SUP OFF` on the Command line. The shadow lines disappear, and `SHAD` appears at the top left of the screen, indicating that there are records that are hidden because shadow lines have been turned off.

You can also hide the shadow line for suppressed records by deselecting the **See shadow lines** option, **Suppressed**, on the Editor Options panel.

- To turn on shadow lines for suppressed record groups, enter `SHADOW SUP ON` on the Command line.

You can also turn on shadow lines for suppressed records by selecting the **See shadow lines** option, **Suppressed**, on the Editor Options panel.

Figure 92. View panel displaying suppressed records

```

Process  Options  Help
-----
View          FMN.V14R1M20.SFMNSAM1(FMNCDATA)          Rec 13 of 40
Record 13----- Format TABL
REC-TYPE NAME          EMPLOYEE-NO    AGE    SALARY    MONTH(1)    #7
#2          #3          #4          #5          #6          #7
AN 1:2     AN 3:20     BI 23:2    BI 25:2    PD 27:4     BI 31:4
<>        <---+---1---+--->    <---+>    <---+>    <---+--->    <---+--->
01         Bill McCork          4565     40     76200     10
01         Keith Sampson       2329     40     71550     26
01         John Neptune        3486     40     69000     30
01         Brian Van Der Velde 4574     30     84500     34
01         Ann Norwich         7838     33     67000     2
01         Michael Bevan       5455     46     83250     10
01         Mary Sands          7790     36     58000     18
01         Antony Burke        7732     46     102000    6
- - - - - REC-TYPE02 - - - - - 20 Line(s) suppressed
**** End of data ****

Command ==> ----- Scroll PAGE
F1=Help    F2=Zoom    F3=Exit    F4=CRetrieve F5=RFind    F7=Up
F8=Down    F9=Swap    F10=Left   F11=Right   F12=Cancel
    
```

Related topics

- [Managing templates on page 199](#)
- [Defining criteria expressions on page 289](#)
- [SHOW \(REC\) primary command on page 1222](#)
- [SHADOW primary command on page 1220](#)

Changing display of the record type

When only one record type is being displayed, to change the current record type in any display format except SNGL:

1. If necessary, turn on the shadow lines for your suppressed records, by entering `SHADOW SUP ON` on the Command line.
2. Type `VIEW` (or `v`) on the Command line.
3. Move the cursor to a shadow line for the suppressed record type you want to view.
4. Press Enter. The suppressed records are displayed and the previous record type becomes suppressed.

Related topics

- [Managing templates on page 199](#)
- [Defining criteria expressions on page 289](#)
- [Record Selection Criteria panel on page 991](#)
- [Record Identification Criteria panel on page 982](#)
- [SHADOW primary command on page 1220](#)
- [VIEW primary command on page 1237](#)

Displaying "not-selected" records

A record is considered to be *selected* if all of the following conditions are true:

- The record length matches the length of one of the record types (level-01 items) in the template. If any of the data description entries for the fields in a record type included an OCCURS DEPENDING ON clause, then records of various lengths might match a record type; for details, see [Support for variable-length arrays on page 182](#).
- The record data matches the record identification criteria for a type with that record length.

If a record matches the record identification criteria for a record type, but the record length is outside the valid range for that record type, then the record matches the record type only if you choose the **Length error** option on the Editor Options (option 0.6) panel. If you choose this option then such records appear with a `=LGTH` indicator in their prefix area. If you do not choose this option, then the record does not match the record type.

- The record data matches the record selection criteria for that type.
- The record type is indicated as being selected on the Record Selection panel (when editing the template).

Otherwise, a record is considered to be *not-selected* for processing.

You can choose to show not-selected records, hide them, or represent them by shadow lines.

```
----- n Line(s) not selected
```

- To show not-selected records, enter `SHOW NOT ON` on the Command line. (In SNGL or TABL display format, the record data is formatted according to the structure of the current record type.)

You can also show not-selected records by selecting the **Expose** option, **Not selected**, on the Editor Options panel.

- To group not-selected records, enter `SHOW NOT OFF` on the Command line. The records are either completely hidden or represented by shadow lines, depending on the current setting of the SHADOW command.
- To turn on shadow lines for not-selected records, enter `SHADOW NOT ON` on the Command line.

You can also turn on shadow lines for not-selected records by selecting the **See shadow lines** option, **Not selected**, on the Editor Options panel.

- To turn off the shadow lines, completely hiding all but the selected records of the current record type, enter `SHADOW NOT OFF` on the Command line. The shadow lines disappear, and `SHAD` appears at the top left of the screen, indicating that there are records that are hidden because shadow lines have been turned off.

You can also turn off the shadow lines by deselecting the **See shadow lines** option, **Not selected**, on the Editor Options panel.

Figure 93. View panel displaying the not-selected shadow line

```

Process  Options  Help
-----
View          FMN.V14R1M20.SFMNSAM1(FMNCDATA)          Rec 0 of 40
REC-TYPE NAME          JOB-TITLE      ADDR1          Record 0----- Format TABL
#2          #3              #4              #5              #6              +
AN 1:2      AN 3:20         AN 23:14        AN 37:20        AN 57:20
<>          <-----1-----> <-----1-----> <-----1-----> <-----1----->
**** Top of data ****
-----
----- 20 Line(s) not selected
02          Grant Smith      Developer       22  Montrose St     Thornlie
02          Andrew Apple    Developer       44  Eagle Rise      Riverton
02          Graham Prestcott Developer       256 Hay St       Cannington
02          Bill Somers     Developer       84  Murchison Rd    Dianella
02          Ted Dexter      Developer       92  Smith St        Belmont
02          Roddy Armstrong Manager         184 Alexander Dve Swan View
02          Cliff Roberts   Manager         28  Bern Rd         Middleswan
02          James Browne    Manager         123 Wellington St Guildford
02          Silvia Carrot   Programmer       48  Small Lane      Mt Pleasant
02          Dan Peters      Programmer       661 Ayton Way    Floreat Park
02          John Laws       Tech Writer     20  Uppercrust Cres Shents
Command ===> ----- Scroll PAGE
F1=Help      F2=Zoom        F3=Exit        F4=CRetriev    F5=RFind       F7=Up
F8=Down      F9=Swap        F10=Left       F11=Right      F12=Cancel
    
```

Related topics

- [Managing templates on page 199](#)
- [Defining criteria expressions on page 289](#)
- [SHOW \(REC\) primary command on page 1222](#)
- [SHADOW primary command on page 1220](#)

Seeing why a record is not-selected

In an editor session, if a record is not selected, File Manager indicates the reason in the prefix area for the record.

When you use the SHOW command (or one or more of the Expose options on the on the Editor Options panel is selected) to show not-selected records, the prefix area (if displayed) indicates why each record was not selected. One of the following values is displayed in the prefix area of each not-selected record:

=DATA

Indicates the record was not selected because, although it matched one of the record types identified in the template, it did not match the record selection criteria provided for that record type.

=LGTH

Indicates the record was not selected because one of the following is true:

- The record length did not fall within the valid range for any of the record types in the template.
- The record length falls within the valid range for a record type in the template, but that record type contains a variable-length array, and the record length is not consistent with the value of the field that defines the number of items in the array.

Related topics

[Managing templates on page 199](#)

[Defining criteria expressions on page 289](#)

[Support for variable-length arrays on page 182](#)

[SHOW \(REC\) primary command on page 1222](#)

[SHADOW primary command on page 1220](#)

Hiding or showing records in SNGL display format

In SNGL display format, the VIEW command does not apply: the current record type automatically changes to match the record being displayed. The record type used to format the record being displayed is indicated at the top of the screen.

In this display format, shadow lines are not displayed. If SHOW NOT OFF is in effect, then not-selected records are hidden; if SHOW SUP OFF is in effect, then suppressed records are hidden.

If you use the Next function key (F11) or Previous function key (F10) to scroll through records in SNGL display format, then the only indication that a hidden record has been skipped is that the record number (shown in the upper right corner of the screen) skips accordingly.

If you display a not-selected record in SNGL display format, then the record type used to format the data is the record type that was current prior to showing the not-selected record.

Related topics

[Managing templates on page 199](#)

[Defining criteria expressions on page 289](#)

[SHOW \(REC\) primary command on page 1222](#)

[SHADOW primary command on page 1220](#)

[VIEW primary command on page 1237](#)

[SNGL on page 107](#)

Using the SHOW command in an editor session

The SHOW command in an editor session has the following features:

- If you use the SHOW command to show not-selected records, then the prefix area (if displayed) indicates why each record was not selected. For details, see [Seeing why a record is not-selected on page 312](#).
- If you use the SHOW command to show not-selected records in TABL display format, and the records contain invalid data when interpreted according to the field definitions for the current record type, then the invalid data is shown as highlighted asterisks. Additionally, in Edit, File Manager moves the cursor to the first occurrence of invalid data.

Examples

In SNGL display format, to show only the selected records for the current record type, enter:

```
SHOW NOT OFF
SHOW SUPP OFF
```

(or just `SHOW ALL OFF`)

In SNGL display format, to show all selected records, enter:

```
SHOW NOT OFF
SHOW SUPP ON
```

(as you step through the records using the Next function key (F11) and the Previous function key (F10), the field headings change to match the type of the current record)

In SNGL display format, to show all records, enter:

```
SHOW NOT ON
SHOW SUPP ON
```

(not-selected records are formatted according to the record type that was current prior to moving to that record).

Related topics

[SHOW \(REC\) primary command on page 1222](#)

[SHADOW primary command on page 1220](#)

Viewing segmented data

When viewing data using a segmented data template, in either the View or Edit panels, only one segment type is displayed at a time in TABL, CHAR, HEX or LHEX display modes, depending upon the current setting of the SHOW SUP command. In this respect, viewing segmented data is very similar to viewing unsegmented data with many record types.

To view a different segment type in the editor panel:

1. Type the `VIEW (V)` primary command on the command line.
2. Place your cursor on the shadow line for the segment type you want to display and press Enter.

To view a different segment type in the Edit panel you can use the method described above or you can:

1. Enter the `v` command in the prefix field for the appropriate shadow line.



Note: Both of these methods are identical to changing record types in unsegmented data.

Because segmented records typically have many segment types, each of which will display as a separate shadow line, you may find it convenient to hide the shadow lines while looking at a particular segment type. To do this:

1. Enter the `SHAD SUP OFF` primary command on the command line.

For example, if this command is applied to the sample data seen in [Figure 56: TABL view of segmented data with the DEPT Record Type selected. on page 178](#), the result would be:

Figure 94. Segmented records with “suppressed” shadow lines turned off.

```
SHAD
REC-TYPE DEPT-ID JOB-DESC
#2      #3      #4
AN 1:2  AN 3:3  AN 6:20
<>      <->      <-----1----->
*****  ****  Top of data  ****
000001  01      FIN      Accountant
000003  01      FIN      Purchasing Officer
000005  01      FIN      Accounts Receivable
000007  01      MKT      Sales Representative
000009  01      MKT      Promotions Manager
000011  01      MKT      Market Research
000013  01      ADM      Chief Executive
000015  01      ADM      Secretary/PA
000017  01      ADM      Receptionist
000019  01      ADM      Clerical Officer
*****  ****  End of data  ****
```

To switch the segment types, you need to redisplay the shadow lines (`SHAD SUP ON`), then re-apply the `VIEW` command to the required Record Type.

Viewing segmented data in SNGL display mode

In SNGL display mode, the File Manager default is to hide the suppressed records. (This is controlled by the **Expose (do not group) records of types** editor option, for which you can select these types of records: **Not selected, Suppressed, Length error**). This means that when you access SNGL mode, you will only see one segment type as you scroll through the data using the `NEXT` (F11) and `PREVIOUS` (F10) commands.

To view all the segment types in SNGL mode, you need to display the suppressed records, by entering the `SHOW SUP ON` command. When the suppressed records are displayed, the `NEXT` (F11) and `PREVIOUS` (F10) commands scroll through each segment type, treating each as a separate record. To scroll through the physical records, you can use the `NEXTREC` (Shift+F11 or F23) and `PREVREC` (Shift+F10 or F22) commands. These commands take you to the beginning of the next or previous physical record, that is, you will view the first segment type of each record. You can also use the `UP` (F7) or `DOWN` (F8) commands to scroll within the current record.

To find a segment type and then scroll through segmented data in SNGL display mode, viewing the same segment type:

1. Enter the SHOW SUP ON command to display all the segment types.
2. Use the NEXT command (F11) to scroll through the segment types until the type you want is displayed.
3. Enter the SHOW SUP OFF command. This hides the display of the suppressed records.
4. Use the PREV or NEXT commands to scroll, looking at the same segment type each time.

To switch the segment types, you need to redisplay the suppressed records (SHOW SUP ON), scroll to the desired segment type and then re-hide the suppressed records.

Related topics

[NEXTREC primary command on page 1192](#)

[PREVREC primary command on page 1199](#)

Adjusting your view to allow for header information

When you are using a copybook or template to format your records, there are times when the information in your records is displaced because your copybook or template defines its fields as beginning to the right or left of the actual data in the record. For example, your records may include header information, which is not defined in the copybook record structure, or your copybook may include a definition for some header information which is not in the actual record. (PL/I copybooks are sometimes coded with a 4 byte RDW field that File Manager strips from the record, as it isn't normally considered part of the data.) To map your template to your records without changing the originating copybook, you can specify an offset value, which changes the template's field starting positions to the left or right.

The offset value is an integer between -32760 and 32760, which is applied to one or more Level 01 fields in the template. The starting position of each field within the Level 01 record structure is increased or decreased by this value. A positive offset moves the fields to the right and some fields might be mapped beyond the length of the record. Data that falls beyond the length of the record is not represented. You cannot edit a field where the data you supply would fall beyond the physical end of the record (whether the record is of fixed or variable length). A negative offset moves the fields to the left and all fields with a resultant zero or negative start location are removed from the display.

All required fields must have a positive start location. Required fields are fields such as OCCURS DEPENDING ON target fields, PL/I REFER fields, or fields referenced in record identification or record selection criteria. If a required field would have a negative or zero start column value under the supplied offset, the offset is invalid, and thus not allowed. If the first element of a dimensioned field is at a zero or negative start location, that field (all array elements) is removed from the display.

The offset is applied before values are calculated for use in identification or selection criteria.

Related topics

[OFFSET primary command on page 1193](#)

[Managing templates on page 199](#)

[Selecting records with templates on page 284](#)

[Defining criteria expressions on page 289](#)

[Manipulating the display of fields in records on page 225](#)

Example of a positive offset

If your copybook defined its fields as:

Ref	Field Name	Picture	Type	Start	End	Length
1	1 REC-TYPE02		AN	1	80	80
2	2 REC-TYPE	XX	AN	1	2	2
3	2 NAME	X(20)	AN	3	22	20
4	2 JOB-TITLE	X(14)	AN	23	36	14
5	2 ADDR1	X(20)	AN	37	56	20
6	2 ADDR2	X(20)	AN	57	76	20
7	2 POSTCODE	X(4)	AN	77	80	4

**** End of data ****

and your data records, without a template, consisted of (note the header information in bold):

```

-----1-----+-----2-----+-----3-----+-----4-----+-----5-----+-----6-----+-----7-----+
00000000102Grant Smith      Developer    22 Montrose St   Thornlie
00000000202Andrew Apple     Developer    44 Eagle Rise    Riverton
00000000302Graham Prestcott Developer    256 Hay St       Cannington
00000000402Bill Somers      Developer    84 Murchison Rd  Dianella
00000000502Ted Dexter       Developer    92 Smith St      Belmont
00000000602Roddy Armstrong  Manager     184 Alexander Dve Swan View

```

applying the template generated from this copybook would display your data as:

```

REC-TYPE NAME                JOB-TITLE    ADDR1        ADDR2
#2      #3                    #4          #5          #6          +
AN 1:2  AN 3:20              AN 23:14    AN 37:20    AN 57:20
<>      <-----1-----+-----> <-----1-----> <-----1-----+-----> <-----1----->
00      0000000102Grant Smith  Developer    22 Montrose St   Thornlie
00      0000000202Andrew Apple  Developer    44 Eagle Rise    Riverton
00      0000000302Graham Prestcott Developer    256 Hay St       Cannington
00      0000000402Bill Somers   Developer    84 Murchison Rd  Dianella
00      0000000502Ted Dexter    Developer    92 Smith St      Belmont
00      0000000602Roddy Arms trong Manager     184 Alexander Dve Swan View

```

By adjusting the template with an offset of 10, the records would display as:

```

REC-TYPE NAME                JOB-TITLE    ADDR1        ADDR2
#2      #3                    #4          #5          #6          +
AN 11:2 AN 13:20             AN 33:14    AN 47:20    AN 67:20
<>      <-----1-----+-----> <-----1-----> <-----1-----+-----> <-----1----->
02      Grant Smith          Developer    22 Montrose St   Thornlie
02      Andrew Apple         Developer    44 Eagle Rise    Riverton
02      Graham Prestcott     Developer    256 Hay St       Cannington
02      Bill Somers          Developer    84 Murchison Rd  Dianella
02      Ted Dexter           Developer    92 Smith St      Belmont
02      Roddy Armstrong      Manager     184 Alexander Dve Swan View

```

Example of a negative offset

If your copybook defined its fields as:

Ref	Field Name	Picture	Type	Start	End	Length
1	1 REC-TYPE02		AN	1	84	84
2	2 REC-RDW	9(8)	BI	1	4	4
3	2 REC-TYPE	XX	AN	5	6	2

4	2	NAME	X(20)	AN	7	26	20
5	2	JOB-TITLE	X(14)	AN	27	40	14
6	2	ADDR1	X(20)	AN	41	60	20
7	2	ADDR2	X(20)	AN	61	80	20
8	2	POSTCODE	X(4)	AN	81	84	4

**** End of data ****

and your data records, without a template, consisted of:

02	Grant Smith	Developer	22	Montrose St	Thornlie	614
02	Andrew Apple	Developer	44	Eagle Rise	Riverton	613
02	Graham Prestcott	Developer	256	Hay St	Cannington	602
02	Bill Somers	Developer	84	Murchison Rd	Dianella	456
02	Ted Dexter	Developer	92	Smith St	Belmont	620
02	Roddy Armstrong	Manager	184	Alexander Dve	Swan View	613

applying the template generated from this copybook would display your data as:

REC-RDW	REC-TYPE	NAME	JOB-TITLE	ADDR1		
#2	#3	#4	#5	#6		
BI 1:4	AN 5:2	AN 7:20	AN 27:14	AN 41:20		
<-----1>	<>	<-----1----->	<-----1----->	<-----1----->	<-----1----->	
****	Top of data	****				
-252524647	an	t Smith	Deve loper	22	Montrose St	Thor
-252526187	dr	ew Apple	Deve loper	44	Eagle Rise	Rive
-252524647	ah	am Prestcott	Deve loper	256	Hay St	Cann
-252525943	ll	Somers	Deve loper	84	Murchison Rd	Dian
-252517499	d	Dexter	Deve loper	92	Smith St	Belm
-252520042	dd	y Armstrong	Mana ger	184	Alexander Dve	Swan

By adjusting the template with an offset of -4, the records would display as:

REC-TYPE	NAME	JOB-TITLE	ADDR1	ADDR2	
#3	#4	#5	#6	#7	+
AN 1:2	AN 3:20	AN 23:14	AN 37:20	AN 57:20	
<>	<-----1----->	<-----1----->	<-----1----->	<-----1----->	
****	Top of data	****			
02	Grant Smith	Developer	22	Montrose St	Thornlie
02	Andrew Apple	Developer	44	Eagle Rise	Riverton
02	Graham Prestcott	Developer	256	Hay St	Cannington
02	Bill Somers	Developer	84	Murchison Rd	Dianella
02	Ted Dexter	Developer	92	Smith St	Belmont
02	Roddy Armstrong	Manager	184	Alexander Dve	Swan View

Specifying an offset value

You can specify the offset value for a record in three different ways:

1. When you are editing or viewing a data set with a template, use the OFFSET command to enter an offset value. This offset value only applies to the current editor session.



Note: Under some circumstances, when you use the OFFSET command in an editor session, the command only affects the display formatting of records. You must re-enter the editor session for the select of records or segments to reoccur. These circumstances apply on one of these situations:



- A template indicating segmented records and some selection criteria are present
- Record sampling
- A record limit of MEMORY

For more information on using the OFFSET primary command, see [OFFSET primary command on page 1193](#).

2. When you are editing a template, you can enter an offset value in the Field Selection/Edit panel to change the starting position of the currently displayed layout. If the template contains more than one Level 01 field, you can use the OFFSET primary command in the Record Type Selection panel to change one or more Level 01 fields. If you wish, you can save the offset changes in the template, so that they apply to subsequent editor sessions. For more information about specifying an offset in a template, see [Specifying offset values on page 288](#).
3. When you are running a File Manager function using a template, batch keywords let you specify offset values. The following functions support the use of offset keywords:

Function

Keywords

DSC

OFFSETIN, OFFSETOUT

DSEB

OFFSETIN

DSM

OFFSETOLD, OFFSETNEW

DSP

OFFSETIN

DSU

OFFSETIN

For more information about using these keywords, see the relevant function description in [Functions on page 1241](#).

Chapter 7. Managing data sets

Large-scale file management tasks, such as data creation and data copying, can be performed by treating your data sets as entire units, rather than working with individual records within data sets.

Similar tasks can be performed on HFS files and between z/OS® data sets and HFS files. They are described in [Using UNIX System Services and the Hierarchical File System on page 497](#).

Working with data set lists

The data set list facility provides an easy way to select frequently-used data sets within File Manager and is available for functions whose entry panel allows you to specify the primary data set and, optionally, a copybook or template.

The data set list facility is available with these functions:

- Browse
- Compare
- Copy
- Create
- Edit
- Print
- View



Note: The use of data set lists is not supported through the FM/CICS interface.

Data set lists are lists of up to 30 data set names, and optionally the names of the volumes on which the data sets reside, member names, Copybook or Template data set names, and member names.

File Manager maintains a special dynamic “*reference list*” (called REFLIST) of the last 30 data sets referenced by the function entry panel.



Note: Merely typing a data set name in a panel does not cause File Manager to add that name to the reference list. The data set name has to be actually *allocated* by File Manager before it is added to the reference list.

In addition to File Manager maintaining the reference list, you can create and maintain your own “*personal data set lists*” with details of up to 30 data sets in each list. You allocate a name to each personal data set list you create so that you can identify it. You can use personal data set lists to retrieve frequently used data set names and to create customized data set lists. This facility is similar to ISPF personal data set lists, but the lists are not interchangeable between ISPF and File Manager.

Each list (that is, REFLIST and any personal data set lists you have created) includes the data set name and provision for storing associated details such as member name, volume serial, copybook or template data set name, and member name.

File Manager maintains data set lists for each user ID, across functions, and from one File Manager session to another. For example, say you browsed a data set a few days ago and now want to print some records from that same data set, you

can find the details of that data set in REFLIST (and any personal data set lists you may have added the data set details to) providing you have not accessed more than 30 data sets in the meantime.

You can open any list (making it the *“current data set list”*) and retrieve details to the function entry panel.

Whenever you view or edit a data set, File Manager records the name of the data set in the reference list (REFLIST). If you specified a volume name on the function entry panel, or a member name for a PDS data set, File Manager also records those details in the reference list. For a PDS, if you do not enter a member name on the function entry panel, but instead select it from the member selection list, File Manager records just the data set name.

File Manager also records the copybook or template data set name and member name, but only if they are *used*. For example, if the Copybook/template processing option is set to **3. None** then, even if the Copybook or Template **Data set name** and **Member** entry fields are not blank, File Manager does not record the contents of those entry fields in the reference list as those details were not used. This avoids the reference list (and potentially any personal data set lists) from holding irrelevant and unnecessary information.

You create personal data set lists by typing in the data set names (and optionally other details), or by saving an existing list (including the reference list) with a new name.

Accessing data set lists

You can access data set lists using either the Process pull-down menu on the function entry panel or the fastpath commands REFL, REFD, and REFA.

Process pull-down menu

The function entry panels have a pull-down menu (when you select Process on the action bar) that helps you use data set lists. The Process pull-down menu allows you to access data set lists (including the reference list, REFLIST) and define, modify, save and delete personal data set lists. From the Process pull-down menu, you can select one of the following:

Current Data Set List

Displays the contents of the current data set list and allows you to modify, save, or delete the list.

Personal Data Set Lists

Displays names of all of your personal data set lists, as well as REFLIST. You can then open a list to make it active (making it the *“current data set list”*), and update, delete, or save the list to another name.

Fastpath commands

You can use the following fastpath commands to access and manage data set lists:

REFA

Adds the name of the data set (and associated information) most recently referenced by the function entry panel to the specified data set list.

REFD

Displays the list of data set lists.

REFL

Displays the current data set list.

Related information:

[Personal Data Set List panel on page 966](#)

[Personal Data Set Lists panel on page 968](#)

Managing personal data set lists

You can create, change, or delete data set lists through a set of panels which are accessible by means of the Process pull-down menu available on the function entry panel. You can also access the data set list panels with the REFL and REFD fastpath commands.

Making a list the current data set list

Before you can retrieve information from a data set list, you must make the data set list the *current* data set list.

The current data set list determines:

- The list used by the NRETRIEV primary command (or related function key if allocated to NRETRIEV).
- The list displayed when you select the **Current data set list** option on the Process pull-down menu from the action bar.
- The list displayed when you issue the REFL fastpath command.

To make a data set list the current data set list, perform either of these actions:

- Enter the REFD fastpath command to display the **Personal Data Set Lists** panel, and then enter the O line command to open the required data set list.
 - Save an existing list to a new name. The newly-saved list becomes the current data set list.
-

Related information:

[Personal Data Set List panel on page 966](#)

[Personal Data Set Lists panel on page 968](#)

Creating a new personal data set list

To create a new personal data set list, perform one of these actions:

- Start with an empty list by selecting the **Personal Data Set Lists** option from the Process pull-down menu on the function entry panel, and use the N (New list) line command to create a new list, then enter the data set names and optional additional information (member name, volume, copybook or template data set name and member name) and use the A (Save as) line command to save it with whatever name you choose.
- Start with the reference list (REFLIST) by selecting the **Personal Data Set Lists** option from the Process pull-down menu on the function entry panel, and use the A (Save as) line command to save it with a new name, and then change the list as needed.
- Start with another personal data set list by selecting the **Personal Data Set Lists** option from the Process pull-down menu on the function entry panel, and use the A (Save as) line command to save it with a new name, and then change the list as needed.

**Note:**

1. For details about how to add a description to a data set entry, see [Adding a description to an entry in a data set list on page 325](#).
2. The N (New list) and A (Save as) line commands are also available when you are modifying an open list.

 Related information:

[Personal Data Set List panel on page 966](#)

[Personal Data Set Lists panel on page 968](#)

Editing an existing data set list

You can modify any data set list (including the reference list, REFLIST) by:

- Adding a new data set entry to the list.
- Deleting a data set entry from the list.
- Changing details (including adding a description) for an existing data set entry.

Adding a new entry to a data set list

There are three ways you can add a new entry to a data set list:

- **Overtyping an existing entry on the list**

For an existing entry on the data set list, overwrite the details with new information. If necessary, you can also enter new details on any blank lines.

- **Editing the list**

1. Use the REFL fastpath command or the Process drop-down menu to display the data set list you want to edit on the Personal Data Set List panel.
2. Enter the E (Extended Edit) line command to display the Edit Personal Data Set List panel.
3. Type in the details of the new data set entry. When you are adding a new entry to a data set list, you might find the following line commands useful:

I

Insert a list entry

R

Repeat a list entry

• Using the REFA fastpath command

Use the REFA fastpath command to add the name of the data set (and associated information) most recently referenced by the function entry panel to the specified data set list.

For example:

```
REFA NEWLIST
```

adds the name of the data set most recently referenced by the function entry panel to the data set list, NEWLIST.

The list name must begin with an alphabetic character, followed by any valid alphanumeric character for a total length of up to 8 characters. If the specified list name does not exist, File Manager creates it.



Note: For details about how to add a description to a data set entry, see [Adding a description to an entry in a data set list on page 325](#).

Related information:

[Personal Data Set List panel on page 966](#)

[Personal Data Set Lists panel on page 968](#)

[Edit Personal Data Set List panel on page 865](#)

Deleting an entry from a data set list

To delete an entry in a data set list:

1. Use the REFL fastpath command or the Process drop-down menu to display the data set list you want to edit on the Personal Data Set List panel.
2. Enter the E (Extended Edit) line command to display the Edit Personal Data Set List panel.
3. Type D (Delete a list entry) against the data set entry you want to delete and press Enter. File Manager deletes the entry from the list.

Related topics

[Edit Personal Data Set List panel on page 865](#)

Changing details for an existing entry in a data set list

To change the details for an existing entry in a data set list:

1. Perform either of these actions:
 - To modify the current data set list, either use the REFL fastpath command or, on the function entry panel select the **Current® Data Set List** option from the Process pull-down menu, to open and display the current data set list, and modify the list as required.
 - To modify a data set list other than the current data set list, either use the REFD fastpath command or, on the function entry panel select the **Personal Data Set Lists** option from the Process pull-down menu, to display the list of data set lists and use the O (Open) or E (Edit) line command on the Personal Data Set Lists panel to open and display the required data set list, and modify the list as required.
2. Change any of the existing information by overtyping it.



Note: For details about how to add a description to a data set entry, see [Adding a description to an entry in a data set list on page 325](#).

Related information:

[Personal Data Set List panel on page 966](#)

[Personal Data Set Lists panel on page 968](#)

Adding a description to an entry in a data set list

You can add a description to an individual entry within a data set list.

For example, you might want to further identify a data set called EMPOSEAS with the description "Employees who have worked overseas in the last five years".

To add or view descriptions while modifying a personal data set list, on the Personal Data Set panel, perform either of these actions:

- Type the E (Extended Edit) line command to display the Edit Personal Data Set List panel.
- Enter the LISTVIEW command.

File Manager changes the format of the display to include an extra (third) line where you can add or view the description for that data set entry.

Related information:

[Personal Data Set List panel on page 966](#)

[Personal Data Set Lists panel on page 968](#)

[Edit Personal Data Set List panel on page 865](#)

[LISTVIEW primary command on page 1181](#)

Deleting a data set list

To delete a personal data set list, perform one of these actions:

- Select the **Personal Data Set Lists** option from the Process pull-down menu (or use the REFD fastpath command).
- Place a D next to the list you want to delete and press Enter.
- While viewing a list, place a D in the action field and press Enter.



Note:

1. If you delete the currently active list, then REFLIST becomes the current data set list.
2. You cannot delete the reference list, REFLIST. You can, however, clear its contents. When you use the D line command against REFLIST, File Manager deletes the contents of REFLIST, leaving REFLIST as an empty data set list.

Related information:

[Personal Data Set List panel on page 966](#)

Retrieving details from a data set list

You can speed up the selection of commonly-used data sets from the function entry panel by retrieving the data set name and any associated details from a data set list.

When File Manager retrieves details from a data set list, it fills the **Data set name** entry field on the panel with the retrieved name. If other details (such as the associated member name, volume serial, copybook or template data set name and member name details) are also stored for that entry in the data set list, File Manager also retrieves those details and fills the corresponding entry fields on the panel with the retrieved names.



Note: You can only retrieve details from the current data set list. See [Making a list the current data set list on page 322](#).

There are two ways to retrieve data set details: *progressive retrieval* using the NRETRIEV primary command, and *point-and-shoot retrieval*.

Progressive retrieval (NRETRIEV primary command)

To progressively retrieve the details of each data set held in the current data set list:

1. Make the required data set list the current data set list.
2. From the function entry panel, enter the NRETRIEV primary command (or press the function key to which you have assigned the NRETRIEV primary command).

File Manager retrieves the first data set name from the current data set list.

3. To retrieve the details for the next data set in the current data set list, repeat the NRETRIEV primary command (or press the associated function key again).
4. Continue to retrieve the details for each data set in the current data set list until you have retrieved the details for the data set you want.

Point-and-shoot retrieval

To retrieve the details of a specific data set from the current data set list:

1. Open the required data set list to make it the current data set list.
2. Place the cursor in the field to the left of the data set name you want, and press Enter.

The function entry panel is redisplayed with the selected name in the **Data Set Name** field and any associated information in the other entry panel fields.

Related information:

[Personal Data Set List panel on page 966](#)

[Personal Data Set Lists panel on page 968](#)

[Edit Personal Data Set List panel on page 865](#)

[NRETRIEV primary command on page 1193](#)

Allocating program function keys

If you are accessing data set lists frequently, you will probably find it worthwhile to allocate one or more program function (PF) keys to commands used to manage data set lists.

The commands for which you may find it helpful to allocate a PF key are:

LISTVIEW

On the Personal Data Set List panel, toggles the format of the display to include an extra (third) line where you can add or view the description for that data set entry.

On the Personal Data Set Lists panel, toggles between the standard and extended list format. The extended list format shows the first 6 data set names for each list.

NRETRIEV

Retrieves the details of the first data set entry from the current data set list. Repeated use of NRETRIEV returns details of the next data set in the current data set list. You can only use NRETRIEV on the function entry panel.

REFD

Displays the list of data set lists.

REFL

Displays the current data set list.

To allocate PF keys to one or more of the above commands, use the ISPF command, KEYS.

Creating data sets and records

Using the Data Create Utility, you can:

- Create new records in existing sequential data sets or VSAM data set members, appending to or replacing the existing records.
- Create new records in existing PDS or PDSE members, replacing the existing records.
- Create new records in new VSAM data set members and new PDS or PDSE data set members.
- Create new records in entirely new sequential data sets, VSAM data sets and PDS or PDSE data sets.

With this utility, you can specify the number of records that are to be created and how they are to be initialized. You can use fill characters and patterns to initialize the data. By using a copybook or a template, you can also initialize records at the field level. You can change the data create attributes for individual fields by editing the template.

Creating data without using a template

To create data in a new or existing data set, without using a template:

1. From the Primary Option Menu panel, select option **3. Utilities** and then option **1. Create**.

The Data Create Utility panel is displayed.

2. Do one of the following:
 - Specify the name of an existing data set; for PDS(E) data sets, also specify a new or existing member.

The new records replace or are appended to the records in the existing data set or member, depending upon how you set the **Disposition** Processing Option.

- Specify the name of a new data set; for PDS(E) data sets, also specify a new member name.

When you press Enter to process this panel, you are asked to allocate and define the new data set.

3. If you are creating data in variable length records and you want the new records to have a length less than that of the maximum record size, type a value in the **Record length** field. Otherwise, leave this field empty. (The field is ignored for fixed length and undefined length records.)
4. Enter the number of records that you want to create, in the **Records** field.



Note: To create an empty data set, specify the number of records as 0.

5. To initialize the data at the record level, enter a value in the **Fillchar** field.
6. If you would like to include a sequence field as part of the record, specify the **Sequence field position**, **Sequence field length** and **Sequence field increment** values.
7. If you have specified the name of a new data set and you want to use another data set as a model, specify the name of the model data set in the **Like data set** field.
8. Select your **Disposition** Processing Option.

1. Old/Reuse

Choose this option when you want your new data to initialize from the beginning of an existing data set, replacing any existing records.



Note: If your VSAM data set is set to NOREUSE, selecting this option results in an error when the panel is processed.

2. Mod

Choose this option when you want your new data to be appended to any existing records in the data set.



Note: You cannot append records to a PDS or PDSE member or to a packed sequential data set. You also cannot append packed records to a non-packed sequential data set. You must use the Old/Reuse option to replace these records.

9. In the **Copybook or template** processing option, select **3. None**.

The contents of the Copybook or Template **Data set name** and **Member** fields are ignored.

10. If you want to select a range of PDS(E) members based on one or more criteria, select the **Advanced member selection** option to display the Advanced Member Selection panel.

For details about selecting a range of PDS(E) members, see [Selecting a range of PDS\(E\) members on page 70](#).

11. If you want to generate the JCL needed to run this function in batch, select the **Batch execution** option. The generated JCL is displayed in an Edit session when the panel is processed.
12. If you want to run a user I/O exit in conjunction with your create action, select the **Use I/O exit** option and then specify the exit name in the adjacent field.

This option is only available when File Manager is installed with the option **USEIOX=ENABLE**, and the **Exit enabled** field in the Set System Processing Options panel is set to YES. If a default is specified with either of those options, it is displayed in the field to the right of [Use I/O exit](#).

13. If you want to create the new records in ISPF PACK format, select option **2 Pack** in the ISPF Packing field.



Note: This option is only applicable to PDS or PDSE members. You cannot specify Pack if you have elected to use an I/O exit.

14. Press Enter.

If you have specified an existing data set and the process is successful, a message is displayed to show the number of records written to the file.

If you have specified a new data set name, you are asked to allocate it. When the data set has been successfully allocated, the Data Create panel is displayed again, with a message to show the number of records written to the file.

Related topics

[Specifying a data set and a member name on page 42](#)

[Allocating a new data set on page 332](#)

[Using File Manager functions in batch jobs on page 508](#)

[Data Create Utility panel on page 824](#)

[DSG \(Data Set Generate\) on page 1372](#)

Creating data sets using a template

When you use a template to create a data set, the template provides structure for the data. You can also use “create attributes” in the template to initialize field values in the data set.

Initialization can be performed at two levels: record level and field level. Field-level initialization takes place when you specify that a copybook or template is to be used. In this case, the record is first filled with the character specified by the **Fillchar** entry field. Selected fields are then individually initialized using the field create attributes specified in a template.

When File Manager is creating a data set, it uses only the first record type described in the template. The length of the records written depends upon whether the records are fixed-length or variable-length, and the length of the record description in the template:

- For fixed-length records, all records are created with the record length specified for the data set. If the length of the record in the template is less than the data set record length, the records are padded with the value specified for the **Fillchar** field.
- For variable-length records, the length of each record depends upon the length of the record built using the field attributes in the template. If the template record description contains one or more variable-length arrays, the length of the record varies according to the values assigned to the objects of the OCCURS DEPENDING ON clauses or, in the case of a template created from a PL/I copybook, arrays or variables whose number of elements or length is controlled by a REFER variable.



Note: The length of the record in the template must always be less than or equal to the maximum data set record length.

To create data in a new or existing data set, using a template:

1. From the Primary Option Menu panel, select option **3. Utilities** and then option **1. Create**.

The Data Create Utility panel is displayed.

2. Do one of the following:

- Specify the name of an existing data set; for PDS(E) data sets, also specify a new or existing member.

The new records replace or are appended to the records in the existing data set or member, depending upon how you set the **Disposition** Processing Option.

- Specify the name of a new data set; for PDS(E) data sets, also specify a new member name.

When you press Enter to process this panel, you are asked to allocate and define the new data set.

3. If you are creating data in variable length records and you want the new records to have a length less than that of the maximum record size, type a value in the **Record length** field. Otherwise, leave this field empty. (The field is ignored for fixed length and undefined length records.)
4. Enter the number of records that you want to create, in the **Records** field.



Note: To create an empty data set, specify the number of records as 0.

5. To initialize the data at the record level, enter a value in the **Fillchar** field.

To initialize data at the field level, you must use a template in which the Create Attributes values have been defined for the template fields. If these values have not yet been defined for your template, you can select the **Edit Template** option and define them as part of this process.

If you would like to include a sequence field as part of the record, you must specify this as part of your template Create Attribute values. When you are using a template, information in the **Sequence field position**, **Sequence field length** and **Sequence field increment** fields is ignored.

6. If you have specified the name of a new data set and you want to use another data set as a model, specify the name of the model data set in the **Like data set** field.
7. Specify your template by doing *one* of the following:

- In the Copybook or Template **Data set name** and **Member** fields, specify the name of an existing copybook or template, then set the **Copybook or Template** processing option to **1. Above**.
 - Set the **Copybook or Template** processing option to **2. Previous**. This tells File Manager to use the copybook or template that you have most recently associated with this data set (discrete to each user). File Manager ignores the contents of the **Data set name** and **Member** fields.
 - Set the **Copybook or Template** processing option to **4. Create Dynamic**. File Manager ignores the contents of the **Data set name** and **Member** fields and displays the Dynamic Template panel when you press Enter to process the Create Data panel.
8. If you want to run this process as a batch job, select the **Batch execution** option. See [Using File Manager functions in batch jobs on page 508](#) for details about using batch mode.
 9. Select your **Disposition, Use I/O exit, Use proc** and **ISPF Packing** Processing Options to suit your needs (see [Creating data without using a template on page 328](#) for details).
 10. Press Enter.

If you have specified an existing data set and template, and the process is successful, a message is displayed to show the number of records written to the file.

If you have elected to create a dynamic template, the Dynamic Template panel is displayed. If you have specified an existing template and selected the Edit Template option, the appropriate template editing panel is displayed. When you have finished defining your template, File Manager either creates the records or asks you to allocate a new data set, depending upon whether you specified an existing or new data set name.

If you have specified a new data set name, you are asked to allocate it after your template has been specified or created. When the data set has been successfully allocated, the Data Create panel is displayed again, with a message to show the number of records written to the file.

Related topics

[Setting the Data Create Attributes in your template on page 333](#)

[Specifying a data set and a member name on page 42](#)

[Allocating a new data set on page 332](#)

Allocating a new data set

When you specify an output data set that does not exist, File Manager prompts you to allocate the new data set by displaying two panels. You select the organization type for the new data set on the first panel. Your choice of data set organization determines which panel is displayed next. You can also provide a "Like data set" to be used as a model to provide data set attributes for the new data set. You can either specify the name of the model data set (which must already exist) directly on the Data Set Create utility panel, or on the new data set Allocation panel. You enter allocation specific information, such as primary and secondary space allocation and record length on the second panel. The second panel allows either the creation of a VSAM data set, a physical sequential or partitioned data set, an HFS file, or an IAM KSDS or ESDS data set.

To allocate a new data set:

1. On the Allocate: New Data Set Organization panel, select the option for the data set organization type.
2. If you want to copy the allocation attributes of an existing data set, specify the name of the data set in the **Existing Data Set** field.
3. Press Enter. The panel that is appropriate for the selected data set organization type is displayed.
4. Complete the fields in this panel to create the data set you require. For general information about defining data sets, see the *DFSMS Using Data Sets* manual for your operating system. For specific information about valid field values, use the field-level Help (put your cursor in the field and press F1).

Related topics

[Creating data without using a template on page 328](#)

[Creating data sets using a template on page 330](#)

[Allocate panel on page 737](#)

DFSMS Using Data Sets

Setting the Data Create Attributes in your template

To enter create attributes for a field:

1. Display your template (dynamic or copybook) in the Field Selection/Edit panel.

For details on how to do this, see [Editing a template on page 218](#).

2. Type **E** or **DT** in the **Cmd** field adjacent to the relevant field, and press Enter.
 - If E is entered, the Field Attributes panel is displayed.
 - If DT is entered the Date/Time Attributes panel is displayed.
3. Enter values in the **Create Attributes** fields of the Field Attributes panel or the **Create/Modify Attributes** fields of the Date/Time Attributes panel.
4. Press the Exit function key (F3) to return to the Field Selection/Edit panel.

An "E" is displayed under the **SHE** column to indicate that the attributes for the field have changed.

5. Save your changes and exit from your template.

Related topics

[Field Attributes panel - alphanumeric fields on page 876](#)

[Field Attributes panel - numeric field on page 883](#)

Creating, replacing, and adding data using existing data

When you are in an Edit or View editor session, you can create data elsewhere from the data you are currently editing or viewing.

You can create or replace data in a member of a partitioned data set (PDS or PDSE) or a sequential, VSAM, or z/FS data set, using data from one or more lines of the data in the current editor session.

You can also add data to a sequential, VSAM, or z/FS data set, using data from one or more lines of the data in the current editor session.

- To *create* data in a new member or a new data set using one or more lines of the data in the current editor session, use the CREATE (or CREATEX) primary command. See [Creating a new member or data set using data from an edit session on page 334](#).
- To *replace* data in an existing member or a data set with one or more lines of the data in the current editor session, use the REPLACE (or REPLACEX) primary command. See [Replacing a member or data set using data from an edit session on page 336](#).
- To *add* data to an existing data set using one or more lines of the data in the current editor session, use the APPEND (or APPENDX) primary command. See [Adding data to a data set using data from an edit session on page 338](#).
- To *create* data in a new member or a new data set using *all* of the data in the current editor session, use the SAVEAS (or SAVEASX) primary command. See [Using all the data from an edit session to create a new member or data set on page 339](#).

Creating a new member or data set using data from an edit session

The CREATE primary command (or its abbreviation, CRE) creates a new member of a partitioned data set (PDS or PDSE) or a new sequential, VSAM, or z/FS data set from one or more lines of the data in the current editor session. If the specified member or data set exists, a warning panel is displayed and a choice is presented, allowing you to either replace the existing member (or data set) or to stop processing. (To replace an existing member or data set without being prompted, use the REPLACE primary command. See [Replacing a member or data set using data from an edit session on page 336](#).)

To specify the lines to be put into the new member or data set, use one of these:

- C or CC prefix commands (to copy lines)
- M or MM prefix commands (to copy lines, then delete them)
- A label range. (You must specify the "from" and "to" labels on the REPLACE command.)

Note that the lines that are copied or moved to the specified data set or member are only those lines which are *not grouped*. This means that lines in any of these groups are not copied (or moved):

- Excluded groups.
- Suppressed groups (groups of other record types when using a template).
- Not-selected groups (groups of not-selected records when using a template).

This allows for a wide variety of control over what you create in the target member or data set, matching the current SHOW settings in the editor session.

If you specify the member name or data set name as part of the CREATE primary command, and the move or copy line commands (or range operand) are entered, the new member or data set is created immediately from the data in the current editor session. The allocation attributes for a data set created in this way are taken from the data set in the current editor session.

When the current editor session is using a PDS, you can enter the member name with or without parentheses which is taken to mean a member within the same PDS.

You can specify a partially-qualified or fully-qualified data set name as part of the command.

Examples:

```
CREATE MEMNAM
```

Creates the new member, MEMNAM.

```
CREATE (MEMNAM)
```

Creates the new member, MEMNAM.

```
CREATE datasetname(MEMB1)
```

Creates member, MEMB1.

```
CREATE 'userid.datasetname(MEMB2)'
```

Creates member, MEMB2.

```
CREATE 'userid.datasetname'
```

Creates data set *userid.datasetname*, based on the current data set attributes.

If you enter the CREATE command without a member name or data set name, or you enter the extended version of this command, CREATEX (or its abbreviation, CREX), File Manager displays an extended create panel allowing you to enter the name of a target data set and, optionally, member. This panel also allows you to decide what data set to use as a model, or, if you want, to manually enter allocation attributes for the target data set. Otherwise, the default data set attributes are taken from the data set on which the editor session is currently operating.

Examples:

```
CRE .STRT .END
```

Displays an extended create panel where you can enter the data set name and, optionally, the member name.

```
CREX 'userid.dataset'
```

Displays an extended create panel where you can enter the data set name and, optionally, the member name.

The **Pack** option on the extended create panel allows you to choose whether the data being created is stored in ISPF packed or standard format. The displayed default reflects the current pack mode of the data being edited or viewed.

After the create processing is completed, File Manager returns you to the existing editor session.



Note:



1. In a CICS® environment, CICS® resources are not available as a target for this command. Also, MQ resources are not available as a target for this command.
2. If the target file for a CREATE is a KSDS VSAM, the occurrence of duplicate keys causes an informational message to be displayed, but processing of the command continues.

Related topics

[CREATE, CREATEX primary commands on page 1141](#)

[Create panel on page 820](#)

Replacing a member or data set using data from an edit session

The REPLACE primary command (or its abbreviation, REPL) creates, if it does not already exist, a new member of a partitioned data set (PDS or PDSE) or a new sequential, VSAM, or z/FS data set from one or more lines of the data in the current editor session. If the specified member or data set already exists, it is overwritten. (To display a warning panel that prompts you when you attempt to replace an existing member or data set, use the CREATE primary command. See [Creating a new member or data set using data from an edit session on page 334.](#))

To specify the lines to be put into the new member or data set, use one of these:

- C or CC prefix commands (to copy lines)
- M or MM prefix commands (to copy lines, then delete them)
- A label range. (You must specify the "from" and "to" labels on the REPLACE command.)

Note that the lines that are copied or moved to the specified data set or member are only those lines which are *not grouped*. This means that lines in any of these groups are not copied (or moved):

- Excluded groups.
- Suppressed groups (groups of other record types when using a template).
- Not-selected groups (groups of not-selected records when using a template).

This allows for a wide variety of control over what you create in the target member or data set, matching the current SHOW settings in the editor session.

If you specify the member name or data set name as part of the REPLACE primary command, and the move or copy line commands (or range operand) are entered, the new member or data set is created immediately from the data in the current editor session. The allocation attributes for a data set created in this way are taken from the data set in the current editor session.

When the current editor session is using a PDS, you can enter the member name with or without parentheses which is taken to mean a member within the same PDS.

You can specify a partially-qualified or fully-qualified data set name as part of the command.

Examples:

```
REPLACE MEMNAM
```

Replaces or creates the new member MEMNAM.

```
REPLACE (MEMNAM)
```

Replaces or creates the new member, MEMNAM.

```
REPLACE datasetname(MEMB1)
```

Replaces or creates member, MEMB1.

```
REPLACE 'userid.datasetname(MEMB2)'
```

Replaces or creates member, MEMB2.

```
REPLACE 'userid.datasetname'
```

Replaces or creates data set *userid.datasetname*, based on the current data set attributes.

If you enter the REPLACE command without a member name or data set name, or you enter the extended version of this command, REPLACEX (or its abbreviation, REPLX), File Manager displays an extended replace panel allowing you to enter the name of a target data set and, optionally, member. This panel also allows you to decide what data set to use as a model, or, if you want, to manually enter allocation attributes for the target data set. Otherwise, the default data set attributes are taken from the data set on which the editor session is currently operating.

Examples:

```
REPL .STRT .END
```

Displays an extended replace panel where you can enter the data set name and, optionally, the member name.

```
REPLX 'userid.dataset'
```

Displays an extended replace panel where you can enter the data set name and, optionally, the member name.

The **Pack** option on the extended replace panel allows you to choose whether the data being created is stored in ISPF packed or standard format. The displayed default reflects the current pack mode of the data being edited or viewed.

After the replace processing is completed, File Manager returns you to the existing editor session.



Note:

1. In a CICS® environment, CICS® resources are not available as a target for this command. Also, MQ resources are not available as a target for this command.
2. If the target file for a replace is a KSDS VSAM, the occurrence of duplicate keys causes an informational message to be displayed, but processing of the command continues.

Related topics

[REPLACE, REPLACEX primary commands on page 1207](#)

[Replace panel on page 1012](#)

Adding data to a data set using data from an edit session

The APPEND primary command (or its abbreviation, APP) adds data from one or more lines of the data in the current editor session to a sequential, VSAM, or z/FS data set.

To specify the lines to be added to a data set, use one of these:

- C or CC prefix commands (to copy lines)
- M or MM prefix commands (to copy lines, then delete them)
- A label range. (You must specify the "from" and "to" labels on the append command.)

Note that the lines that are copied or moved to the specified data set are only those lines which are *not grouped*. This means that lines in any of these groups are not copied (or moved):

- Excluded groups.
- Suppressed groups (groups of other record types when using a template).
- Not-selected groups (groups of not-selected records when using a template).

This allows for a wide variety of control over what you create in the target data set, matching the current SHOW settings in the editor session.

If you specify the data set name as part of the APPEND primary command, and the move or copy line commands (or range operand) are entered, the specified data in the current editor session is appended to the data set immediately.

You can specify a partially-qualified or fully-qualified data set name as part of the command.

Example:

```
APPEND 'userid.datasetname'
```

Appends data to *userid.datasetname*.

If you enter the APPEND command without a data set name, or you enter the extended version of this command, APPENDX (or its abbreviation, APPX), File Manager displays an extended append panel allowing you to enter the name of a target data set.

Examples:

```
APP .STRT .END
```

Displays an extended append panel where you can enter the data set name.

```
APPX 'userid.dataset'
```

Displays an extended append panel where you can enter the data set name.

The **Pack** option on the extended append panel allows you to choose whether the data being created is stored in ISPF packed or standard format. The displayed default reflects the current pack mode of the data being edited or viewed.

After the append processing is completed, File Manager returns you to the existing editor session.



Note:

1. In a CICS® environment, CICS® resources are not available as a target for this command. Also, MQ resources are not available as a target for this command.
2. If the target file for an append is a KSDS VSAM, the occurrence of duplicate keys causes an informational message to be displayed, but processing of the command continues.

Related topics

[REPLACE, REPLACEX primary commands on page 1207](#)

[Replace panel on page 1012](#)

Using all the data from an edit session to create a new member or data set

The SAVEAS primary command creates a new member of a partitioned data set (PDS or PDSE) or a new sequential, VSAM, or z/FS data set from *all* the lines of the data in the current editor session. If the specified member or data set exists, a warning panel is displayed and a choice is presented, allowing you to either replace the existing member (or data set) or to stop processing.

Note that the lines that are copied to the specified data set or member are only those lines which are *not grouped*. This means that lines in any of these groups are not copied:

- Excluded groups.
- Suppressed groups (groups of other record types when using a template).
- Not-selected groups (groups of not-selected records when using a template).

This allows for a wide variety of control over what you create in the target member or data set, matching the current SHOW settings in the editor session.

If you specify the member name or data set name as part of the SAVEAS primary command, the new member or data set is created immediately from the data in the current editor session. The allocation attributes for a data set created in this way are taken from the data set in the current editor session.

When the current editor session is using a PDS, you can enter the member name with or without parentheses which is taken to mean a member within the same PDS.

You can specify a partially-qualified or fully-qualified data set name as part of the command.

Examples:

```
SAVEAS MEMNAM
```

Replaces or creates the member, MEMNAM.

```
SAVEAS (MEMNAM)
```

Replaces or creates the member, MEMNAM.

```
SAVEAS datasetname(MEMB1)
```

Replaces or creates member, MEMB1.

```
SAVEAS 'userid.datasetname(MEMB2)'
```

Replaces or creates member, MEMB2.

```
SAVEAS 'userid.datasetname'
```

Replaces or creates data set *userid.datasetname*, based on the current data set attributes.

If you enter the SAVEAS command without a member name or data set name, or you enter the extended version of this command, SAVEASX, File Manager displays an extended saveas panel allowing you to enter the name of a target data set and, optionally, member. This panel also allows you to decide what data set to use as a model, or, if you want, to manually enter allocation attributes for the target data set. Otherwise, the default data set attributes are taken from the data set on which the editor session is currently operating.

Examples:

```
SAVEAS
```

Displays an extended Saveas panel where you can enter the data set name and, optionally, the member name.

```
SAVEASX 'userid.dataset'
```

Displays an extended Saveas panel where you can enter the data set name and, optionally, the member name.

The **Pack** option on the extended Saveas panel allows you to choose whether the data being created is stored in ISPF packed or standard format. The displayed default reflects the current pack mode of the data being edited or viewed.

After the saveas processing is completed, the editor session you are returned to is an edit of the target PDS member or data set as specified, and the previous member or data set is released without any save occurring. Also note that any starting position, record limits, or sampling information that may have been previously specified, is not active for this edit of the SAVEAS target data set.



Note:

1. In a CICS® environment, CICS® resources are not available as a target for this command. Also, MQ resources are not available as a target for this command.
2. If the target file for a SAVEAS is a KSDS VSAM, the occurrence of duplicate keys causes an informational message to be displayed, but processing of the command continues.

Related topics

[SAVEAS, SAVEASX primary commands \(data\) on page 1216](#)

[Saveas panel on page 1013](#)

Copying data sets

When you are using File Manager under ISPF, you can use the Copy Utility (option 3.3) to copy data from one data set to another data set; when you are programming a batch job, REXX procedure or TSO clist, you can use the equivalent function, DSC (Data Set Copy). Whether you are using the panel or the function, the Copy Utility (option 3.3) lets you copy data using no templates, a “From” template only, or both “From” and “To” templates, in order of increasing flexibility.

You can also invoke the Copy Utility by issuing the COPY line command (or by selecting **Copy** from the Process pull-down menu) on the Data Set List panel, reached using the Catalog Services Utility (3.4). For more information, see [Working with a list of catalog entries on page 418](#).

With or without templates, you can enhance File Manager copy processing by specifying a REXX procedure or DFSORT statements. Using a procedure potentially allows you greater flexibility than any of the choices listed here, but it involves the extra complexity of programming.

With or without templates, you can copy records where the input and output data sets have a different record format, record length, or block size.

You can use the Copy Utility to:

- Copy data from any supported data set to any other supported data set. Concatenated like and unlike sequential data sets are supported. Note that, under some conditions (with tape data sets), File Manager may not be able to detect unlike data set attributes and still invoke DFSORT for copy processing. Such invocation may fail since DFSORT does not allow for unlike concatenation of data sets. In such cases, the DFSORT use may be disabled with the NOSORT function to allow for successful processing of concatenated data sets with unlike attributes.

Concatenated partitioned data sets with like attributes are fully supported. Mixed partitioned data sets with like and unlike attributes are processed correctly providing that the members being selected for processing come from libraries with matching attributes, otherwise errors may be reported.

- Select the records to be copied using the start key (VSAM only), skip and copy count fields, or a conditional expression defined in an input template.
- Change file attributes. You can copy records where the input and output data sets have differing record formats, record lengths or block sizes. The copy process truncates or pads records appropriately. To specify a pad character, use the **PAD** option on the Set System Processing Options panel (option 0.2).
- Copy selected fields, change the size of fields, and create new fields in the output file by using a “From” template with a “To” template.
- Generate data in external format.
- Allocate a non-VSAM data set, or define a VSAM data set.
- Copy sequential data sets or PDS or PDSE members, including member generations, converting the data to or from ISPF PACK data format.



Note: File Manager supports the copying of Load Modules, when the following conditions are met:

- Your input and output data sets are PDS or PDSEs.
- Your TSO environment is active (and you can use the TSO authorized program services), or you are running File Manager as program-authorized.
- You have not specified a REXX or DFSORT user procedure.
- You have not specified Start key, Skip or Copy counts.
- You are not using templates.
- You do not request member record counts.

Copying without a template

When you are copying data sets and do not use a template, all data in an input data set record is copied to the output data set.

You can limit the number of records selected by using the **Start key**, **Skip count**, and **Copy count** fields on the Copy Utility (option 3.3) panel. For example, you can specify the number of records to be copied.

If you are not using a template for your copy, use the Copy Utility panel (see [Figure 206: Copy Utility: "From" panel on page 790](#)) as follows:

1. From the Primary Option Menu panel, select option **3.3** to display the Copy Utility panel.
2. Perform either of these actions
 - Specify the data set that contains the data you want to copy, using a combination of the **Data set name**, **Member**, and **Volume serial** entry fields as appropriate.
 - To select a range of members based on selection criteria, specify the data set name or name pattern for a PDS(E) data set, optionally the member name or pattern, and select the **Advanced member selection** option.



Note: If you enter details in the **Member** field and select the **Advanced member selection** option, File Manager populates the **Member name** field on the subsequent Advanced Member Selection panel with the same value.

3. Set your record-level selection, using the following entry fields on the Copy Utility panel:

Start key

If required, specify a **Start key** for the data (VSAM only). Copying starts at the first record with a key or slot number greater than or equal to the specified value. If the key contains lowercase characters, blanks, or commas, enclose it in quotation marks. Keys may also be in hexadecimal format (e.g. X'0102').

Skip count

If required, specify a **Skip Count** for the data. Copying starts after skipping the number of records specified in the field.

Include

If required, specify the number of physical records that to be included in a repeating sample from a data set. Both **Include** and **Repeat Skip** fields must have non-zero values for sampling to take effect.

Repeat skip

If required, specify the number of physical records to be skipped in a repeating sample from a data set. Both **Include** and **Repeat Skip** fields must have non-zero values for sampling to take effect.

Copy count

Specify the number of records to be copied. Enter ALL to copy all records.



Note: The Start key and Skip count fields are mutually exclusive.

- Select **2. None** in the **Copybook/template usage** field.



Note: When this field is set to None, data in the **Copybook or Template Data set name** and **Member** fields is ignored.

- Select the processing options that you want:

Batch execution

Select this option when you want to generate the JCL needed to run the function in batch. The generated JCL is displayed in an Edit session.

Use proc

Select this option when you want to run a REXX procedure or DFSORT statements in conjunction with your copy action, and then specify the procedure name in the adjacent field.

To create a temporary procedure for one-time use enter an asterisk (*). File Manager displays an Edit panel that you can use to create a new procedure.

To use an existing procedure, specify the name of the member containing the procedure you want to use. The member must belong to the PDS allocated to ddname FMNEXEC. You can enter the name of the member or a member name pattern (other than *). If you specify a pattern, the Member Selection panel for the PDS is displayed when you press Enter. You can then select the required member by entering an **s** in the **Sel** field.

Ignore length mismatch

Select this option when you want to include records in the copy process that are shorter than the matching template structure length.

Use I/O exit

Select this option when you want to run a user I/O exit that processes the "From" (input) data set in conjunction with the copy action. If selected, specify the exit name in the adjacent field.



Note: This option is only available when File Manager is installed with the option **USEIOX=ENABLE**, and the **Exit enabled** field in the Set System Processing Options panel is set to YES. If a default is specified with either of those options, it is displayed in the field to the right of Use I/O exit.

Do not select this option if you plan to use the ISPF Packing option on the next panel.

Skip member selection list

Select this option when you have either used a generic name in the Member field or specified Advanced member selection, and want to copy all members that match the name or range of names, without further refining the member list. This option is ignored if errors are found whilst copying.

Directory integrity

Forces an override of the default PDS(E) member processing method which allows for faster PDS directory access.

This option has significant performance impact. When selected, the members are processed in a way which allows concurrent directory updates as File Manager accesses the members using current directory information.

When not selected, the member processing is performed faster, but may be affected by PDS(E) directory updates, possibly causing I/O errors if the data set is updated concurrently.

Report PDS record counts

Select this option when you want the count of records for copied PDS(E) members to be displayed (online) or printed (batch).

6. Press Enter. The Copy To panel is displayed.
7. Type the "To" data set details. Use a combination of the **Data set name**, **Member**, and **Volume serial** entry fields (the volume serial is only required for data sets which are not accessible via the system catalog) to specify the data set (and PDS(E) member if appropriate) to which you want to copy the data.

If the output data set does not exist, File Manager displays the Allocation panels to help you create a new data set.

8. Select the processing options for the Copy To panel:

DISP

Determines the disposition of the "To" (output) data set. Specify OLD or MOD.

1. OLD

Select this option when you want the copied records to be placed into the "To" data set, starting from the beginning of the data set and overwriting any existing records.

2. MOD

Select this option when you want the copied records to be appended to the end of an existing output data set.



Note: You cannot append records to a PDS or PDSE member or to a packed sequential data set. You also cannot append packed records to a non-packed sequential data set. You must use the OLD option to replace these records.



Note: SMS might modify the allocation of new data sets on your system. For details, contact your SMS Administrator.

Replace members

Select this option when you want to replace like-named members in an output partitioned data set.

Use I/O exit

Select this option when you want to run a user I/O exit that processes the “To” (output) data set in conjunction with the copy action. If selected, specify the exit name in the adjacent field.

If you specify an I/O exit, you cannot use the ISPF Packing option.

ISPF Packing

Provided that the output data set is a sequential, PDS or PDSE file, an I/O exit routine is not used and the DISP is set to OLD, select one of these options to control the copy behavior when processing data that is in ISPF PACK format.

1. Asis

Select this option when you want File Manager to write the output in the same format (packed or unpacked) as the input records. If the input data is packed, it is unpacked for the processing operation, and then written out in ISPF PACK format.

2. Pack

Select this option when you want File Manager to write the output in ISPF PACK format, regardless of the format of the input records. If the input data is packed, it is unpacked for the processing operation, and then written out in the ISPF PACK format.

3. Unpack

Select this option when you want File Manager to write the output in unpacked format, regardless of the format of the input records. If the input data is packed, it is unpacked for the processing operation, and then written out without the ISPF PACK format.

4. None

Select this option when you do not want File Manager to check for packed records or unpack records for processing. If the input data is packed, any processing actions operate on the records in their packed format.

This is the only option allowed when an I/O exit has been specified, when the Disposition is set to MOD or when the Copy To data set is not a sequential file or PDS(E) member.

5. Skip

Select this option when you want to halt the copying or processing actions, if the input data is packed.

9. Press Enter.

If you selected the **Advanced member selection** option, File Manager displays the Advanced Member Selection panel:

- a. Specify the selection criteria to select the members you want to copy and press Enter.
- b. If you have left the **Member name** field on the Advanced Member Selection panel blank or have entered an asterisk (*) or a mask, (and you did not select the **Skip member name list** on the Copy From panel), File Manager displays the Member selection panel. In this case, select the members you want to copy (either by typing an "S" in the **Cmd** field, or with the SELECT primary command) and press Enter.

File Manager copies the selected data in the "From" data set to the "To" data set.

Care must be taken when attempting to combine the **Use proc**, **Use I/O exit** and **ISPF Packing** options. You cannot use an I/O exit and the ISPF Packing option at the same time. You can provide a procedure and use an I/O exit or the ISPF Packing option but you cannot include *Fastproc DFSORT statements in your procedure.

Related topics

[Allocating a new data set on page 332](#)

[Copy From panel on page 789](#)

[Copy To panel on page 796](#)

[Specifying a data set and a member name on page 42](#)

[DSC \(Data Set Copy\) on page 1302](#)

[Selecting a range of PDS\(E\) members on page 70](#)

[Advanced Member Selection panel on page 726](#)

Renaming members as you copy

You can use the Copy Utility to change the names of multiple members in a PDS(E), as you copy members from one data set to another. For example, you might want to copy a range of members named TESTxxx to a new data set and rename all of these as PRODxxx.

To rename members as you copy:

1. In the Copy From panel, enter a member name mask in the **Member** field.

OR

Select the **Advanced member selection** option and specify a range of member names.

2. Specify the remainder of your copy options, as required, then press Enter.
3. In the Copy To panel, enter a new member name mask in the form of a member name pattern.

A member name pattern can consist of any characters that are valid in a member name and two special pattern characters: the asterisk (*) and percent sign (%).

Asterisk (*)

The asterisk is a place-holding character that means multiple characters with no change. Only one asterisk should appear in the mask. Any subsequent asterisk characters are treated as percent signs.

For example, if you enter:

```
ABC*
```

The renamed members all begin with ABC followed by the remainder of the old member name.

Percent sign (%)

The percent sign is a place-holding character that means a single character with no change. As many percent symbols as necessary may appear anywhere in a member name. For example, if you enter:

```
%%%A*
```

The 1st 3 characters of the renamed members remain unchanged, the 4th character is replaced with the letter "A" and the remainder of the old member name remains unchanged.

4. Press Enter. The new member names are displayed in the Prompt field on the Member selection panel.

Sel	Name	Prompt	Alias-of	Size	Created
_	DATA1	TEST1		43	01/01/09
_	DATA2	TEST2		21	02/09/06
_	DATA3	TEST3		40	02/09/06

5. Select the members that you want to copy and press Enter. The Prompt field entry changes to `*COPIED` for the members that were successfully copied and renamed.

Copying with a copybook or template

When you choose to use templates in your copy action, you can specify a "From" template only or both "From" and "To" templates.

"From" template only

Excludes not-selected records from the output data set.

You can use the "From" template to exclude not-selected input records from being copied to the output data set. During the copy, the Copy Utility uses the "From" template to provide information about the selected record types, record identification criteria, record selection criteria and record structure. Once selected, the entire

contents of the record are copied. Any field selection and field resequencing settings in the "From" template are ignored for copying, as field mapping and field create attributes are taken from the "To" template.

You determine which records are selected or excluded by editing the template and:

- selecting record types;
- specifying record identification criteria; and/or
- specifying record selection criteria.

Not-selected records:

- do not match a record type in the template, due to either record identification criteria or record length;
- match a record type, but belong to an unselected record type; or
- do not meet the record selection criteria for the record type.

"From" and "To" templates (based on the same copybook or dynamic template structure)

Allows you to specify how fields in the input data set are mapped to the output data set: to the same field (this is the default), to a different field or unmapped.

You can use the "To" template to specify field mapping to determine which fields in the input data set are copied to the fields in the output data set. Unmapped fields are initialized in the output data set according to "create attributes" in the "To" template. (If no create attributes have been specified, then unmapped numeric fields are initialized to zero and unmapped alphanumeric fields are initialized to blanks.)

File Manager ignores any record type selection, record identification criteria or record selection criteria in the "To" template, as this information is drawn from the "From" template.

The only information in the "To" template that is used for copying is the record structure, field mapping and field create attributes.

If PAD=ON is specified then a field by field copy is done for all fields and the output record length is equal to the layout length of the record type.

If PAD=OFF is specified then the input record copy is copied to the output record and the length of the output record matches the input record length. Only fields that change in value due to scrambling, data create, or code page changes are subsequently processed. For scrambling of fields the performance is improved if you run with PAD=OFF.

"From" and "To" templates (based on different copybook or dynamic template structures)

Allows the input and output data sets to have different record structures, according to the differences in the copybook or dynamic template.

The Copy Utility inserts, deletes or moves fields, or changes field lengths or data types, according to the differences between the templates. For example:

- To insert a field, use a “To” template that is identical to the “From” template, except for an inserted field definition.
- Similarly, to delete a field, use a “To” template that is identical to the “From” template, but with the unwanted field removed.

Typically, you create the “To” template by copying the “From” copybook or dynamic template, then you edit the “To” copybook (or dynamic template) so that it describes the record structure that you want in the output data set.

The table below summarizes how the Copy Utility uses information in the “From” and “To” templates:

The Copy Utility determines...	Using this information...	In this template...	
		From	To
Which records are copied	Selected record types Record identification criteria Record selection criteria	✓	
Which fields are copied, and to where	Field mapping		✓
How new (or unmapped) fields are initialized	Create attributes		✓
Whether mapped date and time fields are modified when copied	Date/Time Create/Modify attributes		✓

By default, the Copy Utility maps fields in the “From” template to fields with the same name in the “To” template. You can edit the field mapping in the “To” template, and either delete the mapping for a field (so that its value in the output data set is initialized, rather than copied from the input data set), or specify yourself which field in the “From” template is mapped to a field in the “To” template.

The Copy Utility truncates or pads records appropriately. You can specify the pad character in the **PAD** field on the Set Processing Options (option 0) panel.

If you *are* using a copybook or template for your copy, use the Copy Utility panel (see [Figure 206: Copy Utility: “From” panel on page 790](#)) as follows:

1. From the Primary Option Menu panel, select option **3. Utilities** and then option **3. Copy**.

The Copy Utility panel is displayed.

2. Enter the “From” data set details.
3. Enter the “From” copybook or template details. Use a combination of the **Data set name** and **Member** entry fields to specify the copybook or template that describes the data in the “From” data set.

You can select data for copying at either record level or field level:

- For record-level selection, set the record identification and record selection criteria in your "From" template.
- For field-level selection, use a "From" template with a "To" template, and specify the selected fields, field attributes and field mapping in your "To" template.

If you specify both record-level and field-level selection, File Manager first selects data at record level, then at field level.

4. Select Copybook/template Processing Option **1. Above** or **3. Create dynamic** press Enter.

If you selected option 1, an extended version of the Copy To panel appears. This form of the panel allows you to specify the "To" copybook or template.

If you selected option 3, then you must create the dynamic template. Once you have done so, the extended Copy To panel is displayed.

5. Type the "To" data set details.
6. Select Copybook/template Processing Option **1. Above**, **2. None** or **3. Create dynamic** press Enter.
7. If you selected option 1, enter the "To" copybook or template details. Use a combination of the **Data set name** and **Member** entry fields to specify the copybook or template that contains field selection and mapping information for your "To" data set.
8. If required, select the **Edit template mapping** option. When the template is displayed, you can specify the mapping of input fields to output fields the data creation patterns for new fields.
9. Press Enter. File Manager copies the selected data in the "From" data set to the "To" data set.

Related topics

[Copying without a template on page 342](#)

[Specifying a data set and a member name on page 42](#)

[Mapping fields between templates on page 251](#)

[DSC \(Data Set Copy\) on page 1302](#)

Scrambling data

Scrambling data allows you to create test data based on production (or "live") data, but with the ability to change the values of certain fields. In this way, you can avoid sensitive or confidential information appearing in test data.

When can you scramble data?

When you use the Copy Utility (option 3.3) to copy data from one data set to another data set, you can choose to scramble some or all of the fields being copied.

For scrambling to occur during the copy process, you must supply an *output template* which has mapped fields *marked for scrambling*.

Scrambling rules

File Manager scrambles data according to these rules:

- If you do not specify any value or range options:
 - Uppercase alphabetic characters are scrambled to other uppercase alphabetic characters.
 - Lowercase alphabetic characters are scrambled to other lowercase alphabetic characters.
 - DBCS characters are scrambled to other DBCS characters.
 - Numerics are scrambled to other numerics.
 - Any other characters remain unchanged.
 - Repeatable scrambling produces unique results for numeric fields defined with **Leading zeros** set to YES, and all non-numeric and non-DBCS fields.
- If you provide a value list, then the field is populated with a value from the list.
- If you provide a range, then the resultant number is in the range provided.
- If you specify a scramble type of random or repeatable and also the value option and a value data set, then the field is populated with a value from the data set.
- If you specify a scramble type of translate, then the input field value is matched and the corresponding output value is used from the value data set.
- If date and time scrambling options are defined for a field they take precedence over other scrambling options specified for the field.

Related information:

[Specifying scrambling options on page 245](#)

[Field Attributes panel - alphanumeric fields on page 876](#)

[Field Attributes panel - numeric field on page 883](#)

[Value List Edit panel on page 1081](#)

[Scramble Exit Specification panel on page 1014](#)

Copying records with segmented data templates

Previous releases of File Manager that copied data with a segmented template, desegmented the output file. This behaviour has been changed so segmented data can be copied, and the record segment relationships, or physical record structures, are maintained. This means you can:

- Selectively copy records from a segmented data set using an input template with selection criteria.
- Use an input and output template to reformat segmented data. This includes the ability to scramble output. Note that the output segment lengths will be determined by the output template, and input segments will be padded or truncated during reformatting. To ensure you do not get unexpected results, make sure you do not have length errors when mapping input segments.
- Use a procedure to drop or insert segments within a physical record. Procedure processing sees the input data one segment at a time. Coding a RETURN 'DROP' will remove that segment from the current output record. Coding a WRITE() statement inserts a segment on the current output record. Coding a RETURN 'STOP' will only write out

the current physical record if the segment being processed is the last segment on that physical record, otherwise it behaves like a RETURN 'STOP IMMEDIATE' where the current physical record being processed is not written. See given examples:

Example 1.

Insert a new segment in the output record.

Consider the following input segmented record:

```
AsegBsegCsegDseg
```

is mapped by a segmented template with 5 layouts mapping segments A to E:

```

$$FILEM DSC ,
$$FILEM TCIN=MYSEG.TEMPLATE(SEGTP),,
$$FILEM PROC=*
IF FLD(1,1) = 'D' THEN DO          /* found a Dseg */
  WRITE()                          /* Write out current segment */
  OVLY_OUT('E',1)                  /* Create 'Eseg' in output area */
END                                /* normal return writes Eseg */

```

After running the above procedure, the output record would be

```
AsegBsegCsegDsegEseg.
```

Example 2.

Delete a segment in the output record.

Consider the following input segmented record:

```
AsegBsegCsegDseg
```

```

$$FILEM DSC ,
$$FILEM TCIN=MYSEG.TEMPLATE(SEGTP),,
$$FILEM PROC=*
IF FLD(1,1) = 'C' THEN          /* found a Cseg */
  Return 'DROP'                 /* drop this segment */

```

After running the above procedure the output record would be

```
AsegBsegDseg
```

Example 3.

Desegment a segmented file.

```

//DDIN   DD DISP=SHR,DSN=MYSEG.DATA
//DDOUT  DD DUMMY
//DDDESEG DD DISP=SHR,DSN=MYDESEG.DATA
//SYSIN  DD *
$$FILEM DSC ,
$$FILEM TCIN=MYSEG.TEMPLATE(SEGTP),
$$FILEM PROC=*
WRITE(DDDESEG) /* Write segment out as physical record */
RETURN 'DROP'  /* don't copy any data */
/*

```

Related topics

[Segmented data templates on page 177](#)

[Setting up a template to be used with segmented data on page 212](#)

Generating data in external format - XML representation

A traditionally formatted data set or file, with format described by a template (copybook), can be represented in an external format. This is possible by applying external format rules to the data in a character format determined by the input template. The output of a copy operation has an external format which can be recognized by applications on various platforms.

You can request that the output of the copy operation be "well-formed" XML data. (XML concepts and terminology are described in the XML Specification 1.0, www.w3.org). The output format derived from the input template also conforms to XML rules. A typical record in the output file is an XML line corresponding to an elementary data item in the input record, and has the format:

```
start-tag content end-tag
```

where *start-tag* and *end-tag* include the data item name and *content* is a character representation of the data item.

Using the copybook shown in [About copybook templates on page 175](#):

```
01 ORDERS.
  05 ORDER-ID      PIC X(5) .
  05 CUSTOMER-ID   PIC X(5) .
  05 ORDER-DATE .
    10 ORDER-YEAR  PIC 9(4) .
    10 ORDER-MONTH PIC 9(2) .
    10 ORDER-DAY   PIC 9(2) .
```

and the input record with an Order ID of O1002 and a Customer ID of C0015 made on 20050110, the corresponding sequence of XML lines is:

```
<ORDER>
  <ORDER-ID>O1002</ORDER-ID>
  <CUSTOMER-ID>C0015</CUSTOMER-ID>
  <ORDER-DATE>
    <ORDER-YEAR>2005</ORDER-YEAR>
    <ORDER-MONTH>01</ORDER-MONTH>
    <ORDER-DAY>10</ORDER-DAY>
  </ORDER-DATE>
</ORDER>
```

File Manager assumes that the names used in a copybook or template are legitimate XML names according to the XML specification. It does not check that each data name, other than FILLER, is unique within the containing group. However, names which do not start with a letter or an underscore are prefixed with an underscore.

The format of elementary data depends on the input template or copybook. The result is similar to the output from the Print Utility. Numeric data is converted to character representation. File Manager removes leading zeros and blanks, trailing blanks, skips a positive sign, and so on. Character data is included into the XML content with trailing blanks removed (leading blanks are significant in data and are not suppressed).

There are situations when data cannot be represented in the XML output by its value. Data may not match the data type requirements. For example, when a numeric field contains non-numeric characters. Character data can contain non-printable and special characters. Non-printable characters are defined by the default (or customized) FMNTRTBS translation table. The following special characters have special meaning in the XML output and require different representation:

- ">" (greater than)
- "<" (less than)
- "'" (apostrophe)
- "'" (quote)
- "&" (ampersand)

The XML output is generated in the character set of the input data (EBCDIC, DBCS), but can optionally be converted to Unicode. File Manager uses standard z/OS® support for Unicode, assuming that appropriate infrastructure and services are present. Conversion to Unicode is possible if the conversion environment is created and activated (for details, see the z/OS Support for Unicode Using Conversion Services). File Manager assumes CCSID 0037 for EBCDIC, 0939 for DBCS (MBCS), and 1200 for Unicode.

You can tailor the format and content of the XML output by specifying:

- How to represent special characters
- How to represent non-printable characters
- How to represent invalid data
- Whether FILLER should be included or ignored
- Whether redefinitions are to be included or ignored
- Whether to get the XML output in the character set of input data (EBCDIC, DBCS) or in Unicode
- The number of blanks used to indent each logical level of XML tag nesting for better readability (logical levels 1, 2, 3, and so on), is assigned by File Manager by renumbering user levels specified in the copybook (for example 01, 05, 10, and so on)

The XML output contains additional information included as separate lines, or attributes following data-element names. They document:

- The input data set name and the template (copybook). For example:

```
<INPUT FILE="FMN.SEQ1" FORMAT="FMN.TEMPLATE(SEQ1)">
```

- The record sequence number and, in the case of keyed data, the key value. For example:

```
<ORDER SEQ_NUMBER="998" KEY="01002">
```

- The occurrence number, if the data element is an array. For example:

```
<MONTH-END ITEM_NUMBER="(2)">24</MONTH-END>
```

- Non-printable or special characters found in the content of the element and converted according to processing parameters. For example:

```
<EMP-ID NONPRINT_CHAR="REPLACE">AA..17</EMP-ID>
<JOB-ID SPECIAL_CHAR="ESCAPE">A15&B32</JOB-ID>
```

- Any invalid data conditions met when converting a numeric data to a character string; the element is presented according to processing parameters. For example, skipped:

```
<EMP-SALARY INVALID_DATA="SKIP"></EMP-SALARY>
```

In the cases of invalid data, non-printable and special characters, the attributes document the actual processing of particular data rather than the parameters specified. For example, if a data field contains both non-printable and special characters, with SKIP and REPLACE as the corresponding parameters, the content is skipped. REPLACE is inconsistent with SKIP in this case and is ignored. In general, if a data field contains both special and non-printable characters, SKIP and HEX have precedence over all other options. CDATA has less priority than SKIP and HEX, but higher priority than the rest of the options.

The XML output can be any data set allowed by the Copy Utility, except for VSAM KSDS. The output data set may be fixed or variable in length. If you want an output record created for each XML line, make sure that the maximum logical record length (LRECL) can contain the largest generated XML line. The size of the line depends on the names used in the template, the maximum length of the character representation of values, and the way the special and non-printable characters and invalid data are processed. Some special characters are substituted with strings, some data presented in hexadecimal form, and so on. This can make the line considerably longer than expected. If you want each XML line to be placed in a single output record, and the record is not long enough for a particular XML line, File Manager truncates the XML line, ends processing and reports an error (and, if in batch, sets a tailorable condition code of 8 indicating a truncation error). If you decide that an XML line can span multiple output records, the output data set can have any logical record length.

To generate XML-formatted output, use the Copy From panel as follows:

1. From the Primary Option Menu panel, select option 3 (Utilities), and then option 3 (Copy). File Manager displays the Copy Utility panel.
2. Enter the "From" data set details.
3. Enter the "From" copybook or template details. Use a combination of the **Data set name** and **Member** entry fields to specify the copybook or template that describes the data in the "From" data set. You can select data for copying at either record level or field level:
 - For record-level selection, set the record identification and record selection criteria in your "From" template.
 - For field-level selection, use a "From" template with a "To" template, and specify the selected fields, field attributes and field mapping in your "To" template.

If you specify both record-level and field-level selection, File Manager first selects data at record level, then at field level.

4. For **Output Format** select **1** to indicate that you want output in XML format.
5. Select Copybook/template Processing Option 1 (Above) or 3 (Create dynamic) press Enter.

If you selected option 1, File Manager displays an extended version of the Copy To panel. This form of the panel allows you to specify the additional options.

If you selected option 3, then you must create the dynamic template. Once you have done so, File Manager displays the extended Copy To panel.

6. Type the "To" data set details.

7. Optionally, customize the generation of output. For XML, you can affect the generation and readability by specifying how to represent non-printable characters and invalid data, whether to include fillers and redefines, how to indent when nesting successive levels of XML tag nesting, and so on.
8. Press Enter. File Manager generates the selected data from the "From" data set and writes it, in XML format, to the "To" data set.

Related topics

[Specifying a data set and a member name on page 42](#)

[Copy From panel on page 789](#)

[Copy To panel on page 796](#)

[DSC \(Data Set Copy\) on page 1302](#)

Copying files or members containing JCL

If the file or PDS(E) members you are copying contain JCL, you can instruct File Manager to maintain the integrity of the JCL syntax where the contents of the file or PDS(E) member have been changed during the copy process.

To maintain the integrity of JCL syntax as you copy, in the Copy From panel:

1. Select the **JCL Source format** option.
2. Select the **Use proc** option.
3. Specify the remainder of your copy details as required and press Enter.
4. Specify details on the Copy To panel as necessary and press Enter.

File Manager copies the selected data in the "From" data set to the "To" data set, maintaining the integrity of any JCL where the JCL is changed during the copy process.

Related topics

[Copy From panel on page 789](#)

[Copy To panel on page 796](#)

[DSC \(Data Set Copy\) on page 1302](#)

[Working with files or members containing JCL on page 378](#)

Using a DFSORT or REXX procedure

You can specify an existing DFSORT or REXX procedure, or create a new one, to further enhance the way in which data is selected and copied.

You can code any number of DFSORT or REXX statements and functions to manipulate the output record, select specific records, print reports and tally numeric values.

When you are coding a REXX procedure, be aware of the following:

- A copy procedure is run after record-level selection, and any field selection supplied in a template, has been performed.
- If the record has been reformatted as a result of the template processing, the variable INREC contains the input record value and the variable OUTREC contains the reformatted output record.
- If a Copy count is specified, this can affect the number of records presented to the REXX procedure. The Copy count only applies to the number of records written to the primary output data set. It does not apply to records written in the REXX procedure with the WRITE() function.
- When using the PRINT() function with field formatting (TABL or SNGL), the template is determined as follows:
 - If an input template without an output template has been specified, the input template is used.
 - If an output template is specified, and the record value specified to print is the input record, the input template is used. Otherwise the output template is used.
 - If a record cannot be matched against a record layout in the selected printing template, it is not printed. Ensure the record value matches the template that File Manager uses to print the data set.

Related topics

[Enhancing File Manager processing on page 517](#)

Example 1

This shows a DFSORT procedure that copies records, inserting 40 bytes of blanks, following by 40 bytes of the input file, beginning from position 41.

```
*FASTPROC
OUTREC FIELDS=(1,40,40X,41,40)
```

Example 2

This shows a REXX procedure that copies records and writes type 01 to DD01, type 02 to DD02, type 03 to DD03, and the rest to the default output file. The type starts in column 10 for a length of 2.

```
ddname = 'DD' || fld(10,2) /* DDname for WRITE function */
if nco(fld(10,2),1,2,3) then do /* does it contain 1,2,3 */
  write(ddname) /* Yes Write to DDnn */
  return 'DROP' /* don't copy to output DD */
end
```



Note: The records that are not processed by the procedure are, by default, copied to the primary output data set.

Example 3

This shows a combination of DFSORT and REXX statements that copies records with type A and prints the first 10. The type value is in column 6.

```
*FASTPROC
OMIT COND=(1,6,CH,NE,C'A')
*REXXPROC
If prtcount() <= 10 then print(inrec,'CHAR') /* Print 10 */
```

```

RETURN                                /* Copy      */
return 'DROP'                          /* Drop the rest */

```

Example 4

This shows a REXX statement that changes the output records to uppercase while copying.

```
upper outrec
```

REXX member selection

For PDS or PDSE data sets, you can determine whether a member should be copied or not copied, depending upon a condition being true within the member records. This conditional test is supplied to File Manager via a REXX procedure that includes at least one of the following RETURN strings:

RETURN PROCESS MEMBER

Indicates that the entire member is to be included in the copy. No more records in this member are passed to the REXX proc. The member is copied intact, subject to any specified template processing, which is performed before the user REXX proc is invoked.

RETURN DROP MEMBER

Indicates that the member is to be excluded from the copy. No more records in this member are processed. Processing continues with the next member.

When REXX member selection is in effect, records are read from an input member and then cached in memory until the decision is made whether the member is to be copied. Once the decision has been made, the entire member is either copied or dropped, depending upon the return string specified.

If the entire member is processed without encountering a DROP MEMBER or PROCESS MEMBER return string, the member is processed according to the specified default action.

If either of these strings is returned by the REXX processing when REXX member selection HAS NOT been specified, it is treated as if it was a RETURN with no argument strings, except that a warning message is issued. Subsequent records continue to be passed to the REXX proc. Similarly, if a DROP, STOP or STOP IMMEDIATE string is returned by the REXX processing when REXX member selection HAS been specified, it is treated as if it was a RETURN with no argument strings, except that a warning message is issued. Subsequent records continue to be passed to the REXX proc until a decision has been made on whether to DROP or PROCESS the member.

Other REXX statements that control the dropping or updating of records are not performed when REXX member selection is used. Any changes to the special File Manager-defined REXX variable OUTREC are ignored. However, REXX statements that do not involve updating or dropping records are performed. This may lead to some unexpected results. In general, if you need to copy members of a PDS conditionally based on the contents of the member, and also want to manipulate the contents of the member, try to execute this task as a two-step process using separate REXX procedures.

To specify conditional member processing:

1. On the Copy Utility - Copy From panel, specify your data set name and other copy options.
2. Select the **REXX member selection** option and specify the default action (P or D) in the adjacent field. If this field is left blank, P is assumed. P denotes process or copy the member, D specifies drop or do not copy the member.
3. Select the **Use proc** option and specify an existing REXX procedure or enter an * in the field to create a new REXX procedure. This procedure must contain a conditional test and at least one of the relevant RETURN strings.
4. Complete the copying process as required.

Example 1

In this example, the SUBSTR function is used to test records in each member being processed. When the procedure encounters a record in which the condition tests as True, the entire member is dropped from processing. All other members are copied or not copied, according to the default setting on the Copy From panel.

```
if substr(inrec,4,3) == '333'
then RETURN DROP MEMBER
return
```

Example 2

This example demonstrates what happens when you use REXX member selection at the same time as other REXX procedure statements. In this scenario, you are attempting to copy members in a data set and to tally a value in those members at the same time.

The first member (MEM1) contains 5 records:

```
AAA111BBB456CCC789
AAB222BBB456CCC789
AAC333BBB456CCC789
AAA444BBB456CCC789
AAA555BBB456CCC789
```

The second member (MEM2) contains 4 records:

```
AAA001BBB456CCC789
AAA002BBB456CCC789
AAA003BBB456CCC789
AAA004BBB456CCC789
```

The Copy Utility **REXX member selection** default is set to 'P', and the following procedure is supplied.

```
/* rexx */
if substr(inrec,1,3) == 'AAA' /* If cols 1-3 in current rec contain 'AAA' */
then x = tally(4,3,Z,'total') /* then add up the value in columns 4-6 */
if substr(inrec,4,3) == '333' /* If cols 4-6 contain '333' */
then RETURN DROP MEMBER /* then drop member from copy processing */
if substr(inrec,4,3) == '003' /* If cols 4-6 contain '003' */
then RETURN PROCESS MEMBER /* then process (copy) member */
return
```

The tally for "total" includes the first record from MEM1, even though MEM1 is dropped from the copy process. The second and third records don't satisfy the 'AAA' requirement and so aren't tallied, and the subsequent records won't be processed because the decision to drop has been made while processing the third record.)

The tally for "total" also includes the first three records in MEM2. The fourth record is not processed by the REXX proc because the decision to copy has been made while processing the third record.

The end result of this copy action is that MEM1 is dropped, MEM2 is copied, and the tally for "total" equals 117. (111 + 1 + 2 + 3).

Related topics

- [Copy From panel on page 789](#)
- [RETURN return values on page 1714](#)
- [External REXX functions on page 1624](#)

Cloning data sets

The clone utility provides a convenient way to copy multiple sequential, partitioned, GDG, and VSAM data sets.

Output data sets can be automatically created with the attributes of the corresponding input data sets. When used with File Manager remote services the output data sets can be on another LPAR or machine that File Manager can connect to.

Define the CLONE command without LIBDEFs

Using ISPF option 3.9, specify a command as illustrated below:

Figure 95. Command Table Utility Extended Command Entry

```

File  Menu  Utilities  Help
-----
Command Table Utility
Extended Command Entry

Command ==> _____

Make changes to the command and select Update to update the entry or
Cancel to ignore the changes.

Verb   . . . CLONE _____
Trunc  . . . 2
Action . . . SELECT CMD(%FMNCLONE) _____
_____
_____

Description File Manager Clone data sets
_____

Enter / to select option
/ Allow mixed-case in Action field

Update                               Cancel
    
```

Define the CLONE command with LIBDEFs

Using ISPF option 3.9, specify a command as illustrated below:

Figure 96. Command Table Utility Extended Command Entry

```

File  Menu  Utilities  Help
-----
Command Table Utility
Extended Command Entry

Command ==> _____

Make changes to the command and select Update to update the entry or
Cancel to ignore the changes.

Verb . . . CLONE _____
Trunc . . . 2 _____
Action . . . SELECT CMD(%FMNELIBD CLN) _____
_____
_____

Description File Manager Clone data sets
_____

Enter / to select option
/ Allow mixed-case in Action field

Update                               Cancel

```

Clone Data Sets panel

Entering the CLONE command (or your customized ISPF command name) displays the **Clone Data Sets** panel.

```

----- Clone Data Sets -----
- Command ==> -----
0 Prefix:                               List  Report
  Input . FMN.DEMO01.**                 +  1 View
  Output . KEEPER.DEMO01                 +
1 Suffix:
2   Input . _____
3   Output . _____
4 Remote System ID:
5   Data set _____
6   Input . _____ Output . _____
7 Clone list:
9   Data set _____
1  Member . _____ Edit
1 Output Volume and classes:
1   Volume . _____ Data _____ Storage _____ Management _____
1 Options:
1 Enter "/" to select option
S / Batch _ Jobcard _ Replace _ Report _ Sysin _ 1. Input
  _ Generations _____ _ IAM-VSAM          2. Output
3

```

The clone command keeps the last 50 entries in a history table. The full command history can be retrieved by pressing Enter with the cursor positioned on a blank input prefix field. The **Remote System ID** data set and **Clone list** data set names can be retrieved similarly by pressing Enter with the cursor positioned on a blank data set field.

The + sign adjacent to the prefix fields is a point-and-shoot field that will produce a list of data sets matching the specified prefix. For data sets located on a remote system (where the **Remote System ID** field is nonblank) File Manager will be used, otherwise an ISPF data set list is produced.

Pressing Enter on this panel runs the clone command. A list of "from" and "to" data set names is produced for you to review. At this point you can remove selected data sets from the list of data sets to be cloned.

To edit the resulting File Manager copy statements select either the **Batch** or **Sysin** options. To view the foreground copy report select the **Report** option or use option **1** after completion of the copy process.

The following section describes the fields on the **Clone Data Sets** panel.

Prefix Input and Output values

Use the **Prefix Input** field to identify the data sets that are to be cloned. The prefix portion is identified as the qualifiers that precede an ****** value in a qualifier. The number of prefix qualifiers is used to determine the number of qualifiers that will be changed in the qualifying data sets. If you specify a clone list member with input data set names without a corresponding data set name, the number of prefix qualifiers to be replaced will be determined by the input prefix.

Press Enter with the cursor positioned on a blank input prefix to retrieve a previous command.

Press Enter with the cursor positioned on the adjacent **+** sign to show a data set list of matching data sets.

The **Prefix Output** field is used to determine the output data set name if you are changing the high-level qualifiers. The input prefix, if provided, will determine the number of prefix qualifiers changed from the input data set when determining the output data set name. If the input prefix hasn't been specified and the clone list member provides the input data set name but not the corresponding output on a given line, this value will be used to derive the corresponding output data set name. You can specify **%** and ***** in qualifiers that have a corresponding qualifier on the input data set. Specify **%** to inherit that character from the corresponding position in the input data set name. Use ***** to inherit the remaining characters in the corresponding qualifier of the input data set. (Use ***** only at the end of an output qualifier.)

Press Enter with the cursor positioned on the adjacent **+** sign to show a data set list of matching data sets.

Example 1. Copy all data sets with hlq FMN to hlq USER1.NEW

```
Prefix
Input . FMN.**
Output . USER1.NEW1
```

Example 2. Valid use of * character

```
Prefix
Input . FMN.PI*.**
Output . USER1.AA*
```

Result:

```
Input data set name: FMN.PI53019.DATA
Output data set name: USER1.AA53019.DATA
```

Example 3. Invalid use of generic % character in output mask

```
Prefix
Input . FMN.PI*.**
Output . USER1.AA*.NEW%
```

NEW% has no corresponding input qualifier so it cannot be resolved.

Suffix Input and Output values

The **Suffix Input** field is specified in conjunction with an output suffix. If a data set selected for copy has a matching suffix then this value will be replaced with the output suffix. If a data set does not have a matching suffix the output suffix will be appended to the output data set name.

The output suffix will append or replace an input suffix when determining the output data set name. If a matching input suffix is found it will be replaced with the output suffix, otherwise the output suffix will be appended.



Remember: This might lead to data set names that exceed the maximum length.

Example 4. Output data sets where a suffix is replaced with NEW

```
Prefix
Input . FMN.**
Suffix
Input . OLD
Output . NEW
```

Result:

```
Input data set name: FMN.FMDATA.OLD
Output data set name: FMN.FMDATA.NEW
Input data set name: FMN.FMDATA.XXX
Output data set name: FMN.FMDATA.XXX.NEW
```

Example 5. Output data sets with NEW appended

```
Prefix
Input . FMN.**
Suffix
Output . NEW
```

Result:

```
Input data set name: FMN.FMDATA
Output data set name: FMN.FMDATA.NEW
Input data set name: FMN.FMDATA.XXX
Output data set name: FMN.FMDATA.NEW.XXX
```

Remote System ID

You can copy data sets to or from a remote system by providing either an input or an output remote system ID. A remote system ID is a 1- through 8-character name that identifies credentials to be used by File Manager. These credentials are defined in a data set which you can specify on this panel.



Important: Although the user ID and password on the credentials data set are not visible, ensure that this data set is protected by your external security product so that only the owner of the credentials data set has READ access.

Data set

The name of the data set where your remote credentials will be stored.

To select a previously used value, position the cursor on a blank value and press Enter. To select from a list of data sets, enter a generic name. If the **Data set** field is left blank and an input or output remote system ID is entered, the data set name defaults to *userid.FMNAUTH*.

If the data set doesn't exist you will be prompted to allocate it.

Input

This a 1- through 8-character File Manager remote system identifier. If you specify this the resulting copy job will add the prefix `RM:remote_value:` to all input data set names.

To select from a list, position the cursor to a blank value or enter a generic value.

To define a new remote system enter a new name or use the I line command from an existing list of remote system definitions.

Output

This a 1- through 8-character File Manager remote system identifier. If you specify this the resulting copy job will add the prefix `RM:remote_value:` to all output data set names.

To select from a list, position the cursor to a blank value or enter a generic value.

To define a new remote system enter a new name or use the I line command from an existing list of remote system definitions.

Clone list

Data set

The clone list data set contains members where you can specify the following values:

- Multiple input and output prefix values or individual data sets.
- Optional input templates for record selection.
- Optional output templates for record reformatting.

To select a previously used value, position the cursor on a blank value and press Enter. To select from a list of data sets, enter a generic name. If the **Data set** field is left blank and a member is specified, the data set name defaults to *userid.FMCLONE*.

If the data set doesn't exist you will be prompted to allocate it.

Member

Specify the name of a member that contains one or more lines in the following format:

```
Input_dsn Input_template Output_dsn Output_template
```

Where:

Input_dsn

This identifies the input data sets and member names for the copy process. You can use generic values % and * to provide generic values to be used in the data set and member selection process. Specify the member name in parentheses.

Input_template

This will be used for record selection in the copy process. Specify - to bypass.

Output_dsn

This determines the corresponding output data set and member names. If this is not specified then you must provide a value for output prefix or output suffix. You can provide an output member mask in parentheses if members are to be renamed.

Output_template

This will be used for record reformatting or scrambling during the copy process. Specify - to bypass.

Select the **Edit** option or enter the E line command from a member list or specify a new member name to edit the member. If you specify a generic member name or position the cursor on a blank member name a list will be produced where you can provide a description of the member for later reference.

Processing options

Enter / to select any of the following options.

Batch

Produce and edit batch JCL that will perform the copy process.

Jobcard

Customize the File Manager job card.

Replace

Replace like members in an output partitioned data set.

Report

View the foreground copy report for the clone operation immediately after the clone process completes.

Sysin

Edit the foreground copy SYSIN statements before the process is invoked.

Redefine like

This provides the option to delete and define an existing output data set based on either the corresponding input or its previous definition.

1. Input

Redefine all the output files with the attributes of the corresponding input data set.



Note: If the input is a GDG then the output GDG and all of its associations will be deleted.

2. Output

Redefine output VSAM and GDG base definitions. Use for non-reusable VSAM data sets or to clear a GDG and all of its associations before copying.

Generations

Enter / to copy generation members for PDSE Version 2 data sets. You can provide a number in the following input field to limit the number of generations to process with the copy.

IAM-VSAM

This option appears if IAM is installed. Enter / to convert IAM data sets to VSAM.

Clone Member List panel

You can insert, delete, rename, find, and select new members from the **Clone Member List** panel.

Process			
File Manager	Clone Member List	Row 1 to 3 of 3	
Command ==>	-----	Scroll	CSR
Name	Description	Date Changed	Size
- DEM01	<u>Copy fmn.** data sets</u>	2018/08/22 10:57	1
- PI99999	<u>Copy fmn.pi99999 to keeper.apar.pi99999</u>	2018/07/06 14:50	1
- XCRUZ	<u>Cruise data sets</u>	2018/10/18 19:47	6
***** Bottom of data *****			

Field descriptions

Name

Clone member name.

Description

Input field to update or view existing member descriptions.

Date changed

The date and time when the member was last modified.

Size

The number of lines in the member.

Primary commands

L *string*

Search for *string* in the member name and description fields.

Example: L JCL will search the member name and description for the value "JCL".

F *string*

Search the contents of the members for one or more strings. This performs an enhanced search of the clone data set for *string*. Use AND & OR | connectors to provide more than one string. Select the member by pressing Enter with the cursor positioned on a member name in the enhanced search report.

S *member*

This will select the member for the **Clone Data Sets** panel if it exists, otherwise an edit session will open in which you can edit the member.

Line commands

S

Select the member and return to the **Clone Data Sets** panel.

E

Edit the member

V

View the member

I

Insert the member

R

Rename the member

D

Delete the member

Review Clone List panel

Use the **Review Clone List** panel to review the data sets that will participate in the copy process. You can select entries to remove from the list of data sets to be cloned.

If the panel display is 80 characters wide then the full names for the **From** and **To** data sets might not be visible in the area provided. Use the left (F10) and right scroll keys (F11) in the **From** or **To** fields to scroll both columns simultaneously. Use the expand key (F4) to see the full data set name in a window.

```

Process
-----
File Manager          Review Clone List          Row 1 to 4 of 4
Command ==> <-----> Scroll CSR

Review the list of data sets below and use the D line command to delete
data sets you don't want copied. Press Enter to continue with the copy.
Use F3 or Cancel to return.

  From                + To                +
- FMN.DEM001.EXEC    + KEEPER.DEM001.EXEC
- FMN.DEM001.MSGS    + KEEPER.DEM001.MSGS
- FMN.DEM001.PANELS  + KEEPER.DEM001.PANELS
- FMN.DEM001.SKELS   + KEEPER.DEM001.SKEL
***** Bottom of data *****

```

Primary command

F string

Move the cursor to the next row that contains *string* in the **From** or **To** data set names.

Line command

D

Remove the entry from the copy list.

Finding and changing data in multiple PDS members

When you need to search for or change a string in more than one PDS member, the Find/Change Utility provides an efficient way to work with multiple members. You can use the panel to select and refine a list of data set members, then enter FIND or CHANGE commands on the Command line. While you can use this utility to find and change data in VSAM and sequential data sets, it might be simpler to make changes in these types of data sets via the Edit panel.

You can also use the Find/Change Utility in conjunction with a REXX procedure, allowing you to create sophisticated find and change routines.

When you specify a PDS, File Manager allows you to search for or change a string across a list of selected members within the PDS. When working with compressed non-VSAM extended format data sets (compressed PSE data sets), the CHANGE command is not supported, however, the FIND command can be used.

The overall process for using this utility is to:

1. Select the Find/Change Utility option from the Utility Functions panel. The Find/Change Utility panel (shown in [Figure 247: Find/Change Utility panel on page 902](#)) is displayed.
2. Build a list of PDS members to be processed (or specify a single VSAM or sequential data set).
3. Specify the number of records to be searched in each data set or PDS(E) member.
4. Specify where a listing of the results of your changes is to be stored.
5. Select your processing options.
6. Enter a FIND or CHANGE command in the Command line or specify a REXX procedure to be used.
7. Press Enter to process the panel and command.



Note: If your PDS data set list has over 1,000 members or your sequential data set has over 10,000 records, you will see a progress indicator in the upper right corner of the screen, displaying the count of members or records processed in the FIND or CHANGE action. For example:

Figure 97. Progress indicator showing PDS members

Process	Options	Help
File Manager	Find/Change Utility	2000/4887 mbrs read...
Input Partitioned, Sequential or VSAM Data Set, or HFS file:		
Data set/path name	. MANYMBR2	
Member	* _____	(Blank - selection, pattern - process list)
Volume serial . . .	_____	(If not cataloged)
Record count . . .	ALL _____	(Number of records to be searched)

When the command has finished running, the Listing data set, showing the results of your command, is displayed in a Browse session.

8. Press F3 to return to the Find/Change Utility panel.

Building your member list for processing

The Find/Change Utility is particularly useful when you are working with partitioned data sets. You can specify that either *all* members or only *selected* members of a PDS are searched by the FIND or CHANGE command you enter on the Command line.



Note: The selection described in this section is not applicable when the batch execution option is selected.

Perform either of these actions

- Specify the sequential data set, VSAM data set, or PDS member that contains the data you want to search, using a combination of the **Data set name**, **Member**, and **Volume serial** entry fields.

If you leave the **Member** entry field blank, File Manager displays the F/Change Member Selection panel showing all members of the PDS:

- Select the members you want either by typing an “S” in the **Cmd** field, or with the SELECT primary command, and press Enter.
- Press F3 (Exit).

The Find/Change Utility panel is redisplayed showing the selected members in the **Process List**.

You can also select members by entering a member name pattern in the **Member** entry field.

For example, to select all members whose name starts with “TRAN”:

1. Enter `TRAN*` in the **Member** entry field
2. Press Enter

The Find/Change Utility panel shows the relevant members in the **Process List**.

- To select a range of members based on selection criteria, specify the data set name or name pattern for a PDS(E) data set, optionally the member name or pattern, and select the **Advanced member selection** option:
 - When you press Enter, File Manager displays the Advanced Member Selection panel.



Note: If you enter details in the **Member** field and select the **Advanced member selection** option, File Manager populates the **Member name** field on the subsequent Advanced Member Selection panel with the same value.

- Specify the selection criteria to select the members you want to print and press Enter.

If you have left the **Member name** field on the Advanced Member Selection panel blank or have entered an asterisk (*) or a mask, File Manager displays the F/Change Member Selection panel. In this case, select the members you want to search (either by typing an "S" in the **Cmd** field, or with the SELECT primary command) and press Enter. The selected members are shown in the **Process List** on the Find/Change Utility panel.

Related topics

[Find/Change Utility panel on page 901](#)

[Specifying a data set and a member name on page 42](#)

[Member Selection panel on page 946](#)

[FCH \(Find/Change\) on page 1503](#)

[Selecting a range of PDS\(E\) members on page 70](#)

[Advanced Member Selection panel on page 726](#)

Refining the list of selected members

You can further refine the list of selected members in the **Process List** by using the FIND command to search for a specific string. The **Process List** is then reduced to only those members that contain the specified string.

For example, having created a **Process List** of members whose name start with "TRAN", to refine the list to members that contain the string "salesperson-code":

1. Enter `FIND SALESPERSON-CODE` on the Command line.
2. Press Enter. File Manager displays a panel showing the records within each member that contain the string "salesperson-code".

Figure 98. Find/Change Utility: example of results from FIND command

```

Menu  Utilities  Compilers  Help
-----
BROWSE   FMNUSER.SRCHF0R.LIST                               Line 00000000 Col 001 080
***** Top of Data *****
IBM File Manager for z/OS
Find/Change Listing DSN:FMNUSER.FMOS390.COPY

TRANREC2          ----- STRING(S) FOUND -----
Record Number
  18              05 salesperson-code              Pic 9(4).

-- Find/Change summary section --
Records found: 1 Records processed: 65
Members w/recs: 1 Members wo/recs: 1
Search cols: 1:80 Longest line: 80
Edit options in effect: CAPS:OFF
Search argument: >SALESPERSON-CODE<
***** Bottom of Data *****
Command ==> _____ Scroll ==> PAGE_
F1=Help   F2=Split   F3=Exit   F5=Rfind  F7=Up     F8=Down   F9=Swap
F10=Left  F11=Right  F12=Cancel

```

3. Press F3 (Exit). The Find/Change Utility panel is redisplayed showing the refined list of members in the **Process List**.

Alternatively, you can use the FINDNOT command to reduce your list of members to only those that DO NOT contain a string. The FINDNOT command can only be used for a PDS or PDS/E data set.

The output listing displayed after the FINDNOT command is issued, is similar to that displayed for the equivalent FIND command, except that:

- The summary section contains the list of members that were excluded from the process list as a result of the search string being found.
- When LIST=LONG is specified, only the first occurrence of the specified string in each member is displayed.
- The summary section contains an extra statement indicating that the search was initiated by the FINDNOT command and showing the count value of the number of members NOT satisfying the search criteria.

You can also exclude members from the **Process List** by entering **s** in the **Sel** field for the members you want to exclude. You can toggle between excluding a member or not by entering **s** in the **Sel** field.

To refresh the **Process List** to its original state (that is, the list of members as determined by the combination of the **Data set name**, **Member**, and **Volume serial** entry fields), press the Refresh function key (F5).

When you have generated the desired **Process List**, you can use the FIND or CHANGE primary commands to find or alter data in the selected members.



Note: You can restore your refined Process List to the full list (as specified by the data set Input fields), by entering the REFRESH command (F5).

Related topics

[FIND/FX primary command on page 1157](#)

[FINDNOT primary command on page 1168](#)

Specifying where your results are stored

Use the **Listing data set** entry field to specify the data set in which the Find/Change Utility results are stored. If you leave this field blank, the output is stored in the data set *userid.SRCHFOR.LIST* where *userid* is your ISPF user ID.

The listing data set can be an existing data set (in which case it is overwritten). If it is not, it is allocated for you.

Specifying your processing options

Once you have your list of data sets or members built up, you can specify the processing options that you would like to use when performing your find or change operations.

Choose among the following options:

JCL source format

Select this option when your data set contains JCL and you want that JCL syntax to be preserved when making changes.

The following JCL statements are supported:

- DD
- EXEC
- JCLLIB
- JOB
- OUTPUT
- PROC
- SET
- XMIT

All other statement types are treated as data records.

When File Manager recognizes one of the supported statement types, it attempts to process the CHANGE command in such a way as to preserve the JCL syntax. For the eligible JCL statements, changes in a record that would result in the text being longer than 255 characters before reformatting (due to the new string being longer than the old string) within a JCL statement, are not made.

The file must be non-VSAM and have a fixed record length of 80.

Use REXX proc

You can use this option to specify a REXX procedure that manipulates your records in more complex ways than by issuing FIND and CHANGE commands within the panel.

REXX no update

Select this option when your REXX procedure performs no updates to the FCH data set. If selected, it forces the allocation of the data set as input only. All updates to the data are ignored.

Use I/O exit

Select this option when you want to specify a user I/O exit for compressed or encrypted data sets.

Immediate change

Select this option when you intend to use the CHANGE command, but want the input data set to be updated immediately (without displaying the changes in the listing data set).

Batch execution

Select this option when you want File Manager to create JCL that reflects the FIND or CHANGE command that you entered on the Command line. The JCL is presented in an Edit session which you can edit before submitting.

Batch execution restricts the member selection to the pattern specified in the member field. Batch execution does not produce a pop-up selection panel for member selection. If you leave the member field blank, an asterisk (*) is substituted in the JCL generated. For more information, see [FCH \(Find/Change\) on page 1503](#).

Stats off

When selected, this option ensures that the ISPF statistics for PDS or PDSE members, if present, are not updated. Selecting this option improves performance when processing PDS or PDSE data sets with many members.

Directory integrity

Forces an override of the default PDS(E) member processing method which allows for faster PDS directory access.

This option has significant performance impact. When selected, the members are processed in a way which allows concurrent directory updates as File Manager accesses the members using current directory information.

When not selected, the member processing is performed faster, but may be affected by PDS(E) directory updates, possibly causing I/O errors if the data set is updated concurrently.

Listing Option

Use this option to choose the format of the output report.

1

A full report, including each record found or changed.

2

A summary report providing totals for records processed and strings found and changed.

ISPF Packing

Provided that the output data set is a sequential, PDS or PDSE file, an I/O exit routine is not used and the DISP is set to OLD, select one of these options to control the copy behavior when processing data that is in ISPF PACK format.

1. Asis

Select this option when you want File Manager to write the output in the same format (packed or unpacked) as the input records. If the input data is packed, it is unpacked for the processing operation, and then written out in ISPF PACK format.

2. Unpack

Select this option when you want File Manager to write the output in unpacked format, regardless of the format of the input records. If the input data is packed, it is unpacked for the processing operation, and then written out without the ISPF PACK format.

3. Pack

Select this option when you want File Manager to write the output in ISPF PACK format, regardless of the format of the input records. If the input data is packed, it is unpacked for the processing operation, and then written out in the ISPF PACK format.

4. None

Select this option when you do not want File Manager to check for packed records or unpack records for processing. If the input data is packed, any processing actions operate on the records in their packed format.

This is the only option allowed when an I/O exit has been specified, or when the data set is not a sequential file or PDS(E) member.

5. Skip

Select this option when you want to halt the processing actions if the input data is packed.

Specifying multiple arguments for FIND

You can specify multiple arguments for the FIND command, by using OR clauses or AND clauses. You cannot use both AND and OR clauses in the same search. If you specify one or more OR clauses, then a record is selected when any of the arguments are found in the record. If you specify one or more AND clauses, then a record is selected only if all of the arguments are found in the record. The maximum number of arguments that you can specify is 16.

When you use a FIND command in batch, you may need to use more than one line to specify multiple arguments. To indicate that a line is continued, ensure the last item on the line is a blank-delimited comma.

The following command finds records containing either of the strings "GROSS" or "NET":

```
FIND GROSS | NET
```

The following command finds only records containing all of the strings "HAPPY DAYS?," "HERE", and "AGAIN":

```
FIND 'HAPPY DAYS' AND HERE AND AGAIN
```

Related topics

- [FIND/FX primary command on page 1157](#)

Using the CHANGE command in the Find/Change Utility

The CHANGE command operates on the data set or data set members selected in the Find/Change Utility.

The CHANGE command or any of its abbreviations is entered on the Command line, together with the desired parameters. To find and replace long strings that do not fit on the Command line, enter the CHANGE primary command (or one of its abbreviations, such as C) *with no parameters*, or enter the CX command on the Command line with no parameters. This displays the Extended Command Entry panel, in which you can enter long strings and the CHANGE command parameters.

You can limit the effects of the change command by issuing the BOUNDS command before issuing the CHANGE command, or by using one or more of the following parameters:

col1 and col2

Col1 is the first column to be included in the range of columns to be searched. It must be greater than or equal to 1, and less than or equal to the maximum record length. *Col2* specifies the last column to be included in the range of columns to be searched.

MAXINREC(*n*)

The MAXINREC(*n*) parameter allows you to specify the maximum number of **changes** that can be made within a **single record**.

MAXRECS(*n*)

The MAXRECS(*n*) parameter allows you to specify the maximum number of **records** that can be changed within a **single data set or PDS member**.

FIRST(*n*)

The FIRST(*n*) parameter allows you to specify the maximum number of **total changes** that can be performed within a **single data set or PDS member**.

Suppose you want to change the string "SALESPERSON-CODE" to "SALESPERSON-NUMB" in certain members of a PDS.

1. Select the members you want to search.
2. Enter `CHANGE SALESPERSON-CODE SALESPERSON-NUMB`. File Manager displays a panel showing the changed records (only one in this case) as shown in [Figure 99: Find/Change Utility: example of results from CHANGE command on page 376](#).

Figure 99. Find/Change Utility: example of results from CHANGE command

```

Menu  Utilities  Compilers  Help
-----
BROWSE  FMNUSER.SRCHFOR.LIST                      Line 00000000 Col 001 080
***** Top of Data *****
IBM File Manager for z/OS
Find/Change Listing DSN:FMNUSER.FMOS390.COPY

TRANREC2          ----- STRING(S) FOUND -----
Record Number
  18              05 salesperson-numb          Pic 9(4).

-- Find/Change summary section --
Records found: 1 Records processed: 33
Members w/recs: 1 Members wo/recs: 0
Search cols: 1:80 Longest line: 80
Edit options in effect: CAPS:OFF
Count  Value
Found   :      1  >SALESPERSON-CODE<
Changed :      1  >SALESPERSON-numb<
Command ==>
F1=Help   F2=Split   F3=Exit   F5=Rfind   F7=Up       Scroll ==> PAGE_
F10=Left  F11=Right  F12=Cancel

```



Note: On the Find/Change Utility report, the record number can have one of these prefixes:

K

Indicates the change involved a key.

X

Indicates that although it was eligible to be changed, the change could not be performed due to record length restrictions.

KX

Indicates both of the above.

3. Press F3 (Exit)

The PDS Find/Change pop-up window appears.

4. Press Enter to save or F3/End to cancel changes.

Related topics

[CHANGE/CX primary command on page 1129](#)

Specifying context in the output listing

There are times when you might want to view the context of a found or changed string, in the output listing. To do this, you can enter the VCONTEXT command, or set its value as an option, on the Find/Change Utility panel, with parameters to specify how many records before and after the found or changed string should be displayed. For example, if you entered `VCON 2 2`, each found or change string is displayed with the 2 prior and subsequent records. This can be particularly useful when searching data set members containing JCL.

The VCONTEXT command affects all output displays for the remainder of the current session. It can be changed within a session or reset to zero by entering the command with no parameters.



Note: The VCONTEXT command only affects the output display when the **Listing Option** is set to **Long**.

Figure 100. Sample output listing with VCONTEXT 2 2 specified

```

***** Top of Data *****
IBM File Manager for z/OS
Find/Change Listing DSN: USERID.MANYMBR2

M100                ----- STRING(S) FOUND/CHANGED -----
Record Number
  3  //*ROUTE PRINT STLVM20.gregcz
  4  //*=====
  5  //*CLEANUP EXEC PGM=IEFBR14
  6  //*OLDLISTS DD DISP=(MOD,DELETE),
  7  //*          DSN=ECHAS.PLX370.TEST.LISTPLX,
  83 //*UNIDATA DD SYSOUT=*
  84 //*=====
  85  //*TESTASM EXEC PGM=IEFBR14 ASMA90,COND=(9,LE,COMPILE)
  86  //*TESTASM EXEC PGM=ASMA90,COND=(9,LE,COMPILE)
  87  //*TESTASM EXEC PGM=ASMA90,PARM='ADATA',COND=(9,LE,COMPILE)

-- Find/Change summary section --
Records found: 2 Records processed: 111
ISPF packing option: ASIS
Search cols: 1:80 Longest line: 80
Edit options in effect: CAPS:OFF

Found      :          Count  Value
                2  >EXEC PGM=IEFBR14<
-----

```

Related topics

[VCONTEXT primary command on page 1235](#)

Changing data with a REXX procedure

You can specify an existing REXX procedure, or create a new one, to further enhance the way in which data is searched.

The find/change procedure is an alternative way to specify find and change commands that provides the flexibility of a REXX procedure. For Find/Change Utility, the REXX procedure is mutually exclusive to the primary commands CHANGE, BOUNDS, and CAPS.

However, you can use the FIND primary command to refine the selection list for the procedure. To do this, do not select the procedure until you have produced the list of members to be processed. You can deselect a record by executing an exit DROP statement. The Find/Change Utility report prefixes each record number *selected* by the REXX procedure with an "S", each record *changed* by the REXX procedure with a "C", and each record *added* by the REXX procedure with a "+".

For general information about using REXX procedures with File Manager options, see [Enhancing File Manager processing on page 517](#).

Working with files or members containing JCL

When using the DSC or FCH utility with a file that contains JCL and the JCL Source format option has been selected, there are two methods used to maintain integrity.

The choice of method can be specified using the JCL installation option or the SET JCL function.

Important:

1. The following rules only apply to cards that are changed. If a card is not changed the syntax is *not* checked.
2. Any JCL file that is referenced is assumed to have valid syntax. The integrity checking performed by File Manager should not be seen as a method of remedying invalid JCL.

JCL=COMPAT

When a JCL statement has been continued over multiple lines, File Manager reformats the physical JCL records into a single logical JCL statement for processing and then builds a new set of physical JCL records.

- The rules only apply to legitimate JCL cards (// cards but not /**):
 - When a change would cause truncation due to the insertion of characters, the card is split at a suitable position. If possible, File Manager inserts the part that was cut into the next card; otherwise, an extra card is created.
 - When a change causes the removal of data, the card is changed to a comment card.
 - In both of the above, File Manager attempts to maintain the integrity of matching quotation marks, matching brackets, and commas between parameters.
- The rules do not apply to:
 - Comment (/**) cards.
 - Embedded comments at the end of a legitimate JCL card
 - Non-JCL cards. For example, data cards.
 - JCL cards contained within a DD DATA construct as these are considered to be data cards.

When reformatting JCL cards, File Manager takes into account the following:

- The first card of a logical JCL statement contains one of the following statement types:

CNTL
 COMMAND
 DD
 ENDCNTL
 EXEC
 IF
 THEN
 ELSE

ENDIF
 INCLUDE
 JCLLIB
 JOB
 OUTPUT
 PEND
 PROC
 SET
 XMIT

- Each logical JCL card may consist of one or more physical JCL cards.
- Comment (//*) cards are not candidates for reformatting.
- Data cards (no “//” in columns 1-2) are not candidates for reformatting.
- Each logical JCL card can have embedded comment (//*) cards which are also not candidates for reformatting.
- The logical JCL statement line consists of the logical JCL statement itself (name, operation, and parameter fields), with continuation syntax removed. The logical JCL statement is delimited with a x'FF'. Any comments are then appended, with each comment being separated by a x'FF' delimiter.
- Each physical JCL card consists of 4 parts:

Name part

Contains the contents of column 1 up to the last character before the *parameter part*, including the card type. For example, DD, JOB, and so on. This part may also only contain “//” as in the case of a continuation line.

Parameter part

Contains the contents of the first character after the *name part*, including any blanks after the last character of the *parameter part*.

Embedded comment part

This part is optional. It contains the contents of the first non-blank character after the *parameter part* up to column 71 inclusive. Column 72 is a special column and as such is not considered a candidate for reformatting.

Sequence number part (including continuation character)

Contains the contents of columns 72 to 80.

When building a new set of physical JCL cards from a logical JCL statement, the following processing takes place:

- If the logical JCL statement line is unchanged, File Manager does not change any part of the associated physical records.
- If the logical JCL statement line content changes in any way, then File Manager reflows the logical JCL contents into the associated physical records.



Note: It is possible for a logical JCL statement change to require reflowing even if the old and new strings are identical in length-- the changed logical JCL statement might need to be broken into physical records differently.

- File Manager attempts to maintain the contents of the existing physical line (columns 73–80) and the existing JCL statement comment fields. However:
 - File Manager does not attempt to associate any part of a logical JCL statement with the related physical line columns (columns 73–80), or with the JCL statement comment fields. The physical columns (columns 73–80), the JCL statement comment fields, and logical lines are treated independently of each other.
 - JCL statement comment fields may be truncated.
 - File Manager may remove redundant blanks from, and otherwise reformat, the physical JCL lines.
 - If a logical JCL statement is changed and it requires fewer physical records, File Manager turns the "extra" physical records at the end into JCL comment statements, which start with `/*` and contain blanks in the JCL statement area. Data in the comment record columns 73–80 remains unchanged from the original non-comment record data.
- If an entire sub-parameter is removed as a result of a change, and this was the only information on a card, the card is changed to be a comment card.

// JCL statements passed to a REXX procedure

The following additional rules apply to JCL statements (those starting with `//`) that are passed to a REXX procedure.

- The REXX input and output buffers (INREC and OUTREC) contain the logical JCL statement, including the `//` at the front.
- The REXX procedure processing can only access and affect the logical JCL statement.
- File Manager ignores any changes made to the `//` characters in bytes 1 and 2 of a logical JCL statement in an output buffer (OUTREC).

JCL=RECORD

File Manager processes each physical JCL record as is, unless it contains a parameter field enclosed in apostrophes. If this parameter continues across multiple records, the records are flowed together to join the parameter before processing.

When a record is changed, and the total length exceeds 71 columns, the fields are continued onto one or more new records. If it is not possible to interrupt the statement the change fails.

When a change removes all parameter data from a record:

- If it contains embedded comment data the record is changed to a JCL comment statement.
- If it does not contain any other JCL field data the record is deleted.

These rules do not apply to:

- Non-JCL cards. For example, data cards.
- JCL cards contained within a DD DATA construct, as these are considered to be data cards.
- Data in columns 73-80.

Comparing data sets

When you are using File Manager under ISPF, you can use the Compare Utility (option 3.11) to compare data from one data set with data in a second data set; when you are programming a batch job, REXX procedure or TSO clist, you can use the equivalent function, DSM (Data Set Compare). Typically, the first data set contains the original version of some data (the “Old” data set), and the second data set contains an updated version of the data (the “New” data set).



Note: The terms “Old” and “New” do not imply any significance in regard to the dates on which the data sets or templates were created or modified. Any data set or template can be specified as either “Old” or “New”.

Whether you are using the panel or the function, you can compare data without using templates, or by specifying a template to format either the “Old” data set (the “Old” template) or the “New” data set (the “New” template), or for both “Old” and “New” data sets, in order of increasing flexibility.

Record selection can be performed at the record level using the **Start key**, **Skip count**, and **Compare count** fields, or at the field level using conditional expressions defined in the template, or at a combination of both levels. The **Start key** (or slot) and **Skip count** fields are honored before field-level selection takes place. The **Number of differences to report** option allows you to limit the number of differences reported by the compare operation.

To perform field-level selection you must specify a template or copybook. If field-level selection is in effect, the compare count is not met until the specified number of records have been selected.



Note: The subset of data set records defined by the total of all record and field-level selection criteria is referred to as the “compare” set.

You can use the Compare Utility to:

- Compare data from any supported data set to data in any other supported data set.
- Select the records to be compared (the compare set), using the start key (VSAM only), skip and copy count fields, a conditional expression defined in a template, or a combination of all of these.
- Perform a field-level comparison. By using an “Old” copybook or template with a “New” copybook or template you can compare selected fields, with the result of the comparison reflecting the types of data in the fields.
- Restrict the number of differences reported with the Compare Utility option, **Number of differences to report**.
- Create output data sets containing records identified as inserted, deleted, old and new changed records, and old and new matched records.
- Perform load module comparison. Load module and CSECT information from both “Old” and “New” versions of the module is extracted and compared. By selecting from various compare criteria, you can see differences between specific attributes of load modules like load module size, link date, CSECT names, and compilers used.

The compare operation can be performed in the background (batch execution) or in the foreground.

With or without templates, you can compare records where the "Old" and "New" data sets have different:

- Record formats
- Record lengths
- Block sizes

Comparing data sets without using a template

A "simple" compare: all data in the "Old" data set is compared with that in the "New" data set, with only the limited additional options that you can specify on the Compare Utility (option 3.11) panel (for example, you can specify the number of records to be compared).

To perform a compare between data sets:

1. From the Primary Options menu, select the Compare Utility (option 3.11).

The Compare Utility - "Old" data set entry panel ([Figure 198: Compare Utility - "Old" data set entry panel on page 764](#)) is displayed.

2. Specify the "Old" data set information.
3. Set your record-level selection, using the following fields:

Start key

If required, specify a **Start key** for the data (VSAM only). The comparison starts at the first record with a key or slot number greater than or equal to the specified value. If the key contains lowercase characters, blanks, or commas, enclose it in quotation marks. Keys may also be in hexadecimal format (e.g. X'0102').

Skip count

If required, specify a **Skip Count** for the data. The comparison starts after skipping the number of records specified in the field.

Compare count

Specify the number of records to be compared. Enter ALL to compare all records.



Note: The Start key and Skip count fields are mutually exclusive.

4. Select **3. None** in the **Copybook/template usage** field.



Note: When this field is set to None, data in the **Copybook or Template Data set name** and **Member** fields is ignored.

5. If you want to run this process as a batch job, select the **Batch execution** option.

6. If required, select the **Use I/O exit** option to run a user I/O exit that processes the “Old” (input) data set in conjunction with the compare action. If selected, specify the exit name in the adjacent field.



Note: This option is only available when File Manager is installed with the option **USEIOX=ENABLE**, and the **Exit enabled** field in the Set System Processing Options panel is set to YES. If a default is specified with either of those options, it is displayed in the field to the right of **Use I/O exit**.

7. Press Enter. The Compare Utility - “New” data set entry panel is displayed.
8. Specify the “New” data set, **Start key**, **Skip count**, **Compare count** and **Use I/O exit** fields as required for the “New” data set and press Enter.

The Compare Utility - Options panel is displayed.

9. Set the **Compare type** to **1. Record** (you cannot use the Formatted option unless you have specified a template for both the “Old” and “New” data sets).
10. Select your **Listing type** from the available options.
11. If you have selected a listing type of **Long**, you can choose to exclude certain categories of records from the output report by selecting one or more of the **Long Report** options:
 - To exclude inserted records from the report, select **Inserted**.
 - To exclude deleted records from the report, select **Deleted**.
 - To exclude changed records from the report, select **Changed**.
 - To exclude matched records from the report, select **Matched**.
12. If required, select the **Clear print data set** option. This option overrides your current Print DISP setting but has no effect if File Manager print output is not directed to a data set.
13. If required, select the **Create result data sets** option to create one or more output data sets containing the results of the compare process. (You specify the output data sets on the subsequent Output Data Sets panel.)



Note: If you have selected the synchronization option, **Read-ahead**, this option is ignored.

14. Select your **Listing options** from the list.
15. If your data is in a sequential data set or PDS or PDSE member, is in ISPF PACK format and you have not specified an I/O exit, you can select an ISPF Packing option.

1. Unpack

Select this option when you want File Manager to unpack the data before any user processing or comparison occurs.

2. None

Select this option when you do not want File Manager to detect the ISPF PACK format and to operate on any packed data in its packed format.

This is the only valid option when your data is not a sequential or PDS data set, or when the Use I/O exit option has been used.

3. Skip

Select this option when you want File Manager to detect data in ISPF PACK format and stop any processing or comparison for the data set or member.

16. If required, in **Number of differences to report**, specify the maximum number of differences (found in the compare operation) that you want reported.
17. Note: When you compare data sets without using a template, the **Template Reporting Options** on the Compare Utility - Options panel have no effect.
18. Press Enter.

If you selected Read Ahead or Keyed Synchronization, the relevant panel for that option is displayed. Complete the details as instructed above and press Enter again to continue.

The comparison operation is performed and the results are displayed on the screen.

If you selected "Batch Execution", the result is an ISPF Edit session containing the generated JCL and File Manager control statements to execute the requested comparison.

If you did not select the "Batch Execution" Processing Option, the result is a report. This might be directed to the print data set or elsewhere depending upon your Print PRINTOUT setting.



Note: For best viewing when you are comparing wide files using the **Wide listing** and **Show hex chars** options, set your PRINTOUT to SYSOUT=C. This prevents the report lines from wrapping around on the screen.

19. If the report has been displayed online, press the Exit function key (F3) to return to the Compare Utility - "Old" Data Set Entry panel.

Related topics

[Compare Utility: "Old" and "New" panels on page 764](#)

[Compare Utility: Options panel on page 773](#)

[Setting your Print Processing Options on page 403](#)

Comparing data sets using templates

When you choose to use templates in your comparisons, you can specify an "Old" template only, a "New" template only or both "Old" and "New" templates.

"Old" template only or "New" template only

This excludes records not-selected in either the "Old" or the "New" data set.

During the compare, the Compare Utility uses the "Old" or "New" template to provide information about the selected record types, record identification criteria and record selection criteria for the "Old" and "New" data sets. Any field selection and field resequencing information in the templates is ignored, however, you can

specify fields to be used in a multi-segment key that can be used with the Keyed Synchronization comparison option.

You determine which records are selected or excluded by editing the template and:

- Selecting record types
- Specifying record identification criteria
- Specifying record selection criteria

Not-selected records:

- do not match a record type in the template, due to either record identification criteria or record length;
- match a record type, but belong to an unselected record type; or
- do not meet the record selection criteria for the record type.

"Old" and "New" templates (based on the same copybook or dynamic template structure)

This allows you to exclude records from both the "Old" and the "New" data sets, based upon the template information, and allows you to specify which fields in the "Old" data set are compared with which fields in the "New" data set.

During the compare, the Compare Utility uses the "Old" and "New" templates to provide information about the selected record types, record identification criteria and record selection criteria.

You can also specify key segment sequencing to create a multi-segment key that can be used with the Keyed Synchronization comparison option.

If a formatted comparison is performed, the record structure, field output width and field heading attributes in the "Old" and "New" templates are also used. Field mapping information is taken from the "New" template and only fields that have been mapped are compared. A field in the "Old" template can be mapped to the same field in the "New" template (this is the default), to a different field or unmapped.

"Old" and "New" templates (based on different copybook or dynamic template structures)

This allows you to exclude records from both the "Old" and "New" data sets and allows the "Old" and "New" data sets to have different record structures, according to the differences in their copybook or dynamic templates.

You may have existing templates for both data sets, or you might copy a template describing one of the data sets and edit it to describe the other data set.

The table below summarizes how the Compare Utility uses information in the "Old" and "New" templates:

The Compare Utility determines...	Using this information...	In this template...	
		Old	New
Which records are compared	Selected record types Record identification criteria Record selection criteria	✓	✓
Which fields are compared, and with what	Field mapping		✓

If a formatted comparison is performed then, by default, the fields in the “Old” template are mapped to fields in the “New” template that have the same name. You can edit the field mapping in the “New” template, and either delete the mapping for a field (so that it is not compared), or specify which field in the “Old” template is mapped to a field in the “New” template.

To perform a compare using templates:

1. From the Primary Options menu, select Compare Utility (option 3.11).

The Compare Utility - “Old” Data Set Entry panel is displayed.

2. Specify the “Old” data set information and, optionally, the “Old” template information.
 - To use a template, choose any one of these methods:
 - Specify an existing dynamic template, an existing copybook template or an existing copybook on which you want to base a new template and choose **1. Above** from the Processing Options.
 - Choose **2. Previous** from the Processing Options. The template most recently associated with the “Old” data set is used and the contents of the “Old” template fields are ignored.
 - Choose **4. Create Dynamic** from the Processing Options. The contents of the “Old” template fields are ignored and you are asked to create the new template when Enter is pressed.
 - If you want to map fields from the “Old” to the “New” data set, you *must* specify an “Old” template.
 - If you want to edit the “Old” template information before using it, select the **Edit template** option.
 - Press Enter.
 - If Processing Option 1 or 2 was selected AND the **Edit template** option was NOT selected, the Compare Utility - “New” Data Set Entry panel is displayed.
 - If Processing Option 1 or 2 was selected AND the **Edit template** option WAS selected, the panel appropriate for editing the template is displayed. Make your record identification, record selection, field attribute and key sequencing choices and press the Exit function key (F3) to return to the “Old” data set panel. Press Enter again to move to the “New” data set panel using the modified template.
 - If Processing Option 4 was selected, the Dynamic Template panel is displayed. Create and save your new dynamic template. If you want to include key sequence information, select option **1 Edit template field attributes and selection** and make your selections in the Field Selection/Edit panel. When you have finished creating your template, press the Exit function key (F3) to move to the “New” data set panel.



Note: If you do not want to save the changes to your template, you can use the RunTemp function key (F6) in place of the Exit function key (F3).

- In the Compare Utility - "New" Data Set Entry panel, specify the "New" data set information and, optionally, the "New" template information.
 - If you want to map fields from the "Old" to the "New" data set, you *must* specify an "New" template.
 - If you want to edit the "New" template information before using it, select the **Edit template** option.
- Press Enter.
 - If Processing Options 1 or 2 were selected and the **Edit template** option was NOT selected, the Compare Utility - Options panel is displayed.
 - If Processing Options 1 or 2 were selected and the **Edit template** option WAS selected, the appropriate panel for editing the template is displayed. Make your record identification, record selection, field attribute and key sequencing choices, and press the Exit function key (F3) to return to the "New" data set panel. Press Enter again to move to the Options panel using the modified template.
 - If Processing Option 4 was selected, the Dynamic Template panel is displayed. Create and save your new dynamic template. If you want to include key sequence information, select option **1 Edit template field attributes and selection** and make your selections in the Field Selection/Edit panel. When you have finished creating your template, press the Exit function key (F3) to move to the Options panel.



Note: If you do not want to save the changes to your template, you can use the RunTemp function key (F6) in place of the Exit function key (F3).

- Select a combination of Compare, Processing and Listing options. These options apply whether the comparison type is record or formatted, except that for formatted comparisons the word "record" refers only to those parts of the record specified in the mapping.
 - If you want to use the field mapping information within the "New" template, you *must* choose the **Formatted** Compare Type.
 - If you want to edit the field mapping information within the "New" template, select the **Edit template mapping** option.
 - If you select Keyed synchronization, you can:
 - Specify the location, length and data type of your key segments in the Keyed Synchronization Settings panel that is displayed after the Compare Options panel. If a data type is not explicitly specified, type AN is used.
 - Use a template to specify fields to be included in the key and the sequence in which they are concatenated (known as key sequence information). If you want to use an intrinsic key as well as your own key sequence information, you must start the key sequence at 2 or higher. If your key sequence information starts at 1, any intrinsic key information is ignored for that data set.
- Select your **Template Reporting Options** from the list:

Show template layouts

Select this option to report template layout information. You must also have set the **Compare type** to **2. Formatted**.

Show template criteria

Select this option to report template criteria information. A terse layout report is also generated, containing only the fields referred to in the criteria expressions.

Show mapped fields

Select this option to report mapped template fields. You must also have set the **Compare type** to **2. Formatted**.

Show unmapped fields

Select this option to report unmapped template fields. You must also have set the **Compare type** to **2. Formatted**.

Show array elements

If field information is reported (that is, if you have selected any of the first four **Template Reporting Options**), select this option to report all occurrences of any array elements. Note that for COBOL OCCURS DEPENDING ON tables, the maximum occurrences are reported, and for PL/1 REFER arrays, the minimum occurrences are reported.

Show start/end as hex offset

If field information is reported (that is, if you have selected any of the first four **Template Reporting Options**), select this option to report all field start and end positions as hexadecimal offsets.

Show length in hex

If field information is reported (that is, if you have selected any of the first four **Template Reporting Options**), select this option to report all field lengths in hexadecimal.

Show field statistics

This option produces the field statistics report showing the number and percentage of mismatches by field. This option only applies when the synchronization option is One-to-one or Keyed.

- Press Enter.

- If you have not selected the **Edit template mapping** option, the comparison operation is performed, using the current settings and template information. The result is either a Compare Report or a batch job (displayed in the Edit panel).



Note: If no fields are selected in the saved or default-generated field mapping, the **Edit template mapping** option is forced.

- If you have selected the **Edit template mapping** option, the appropriate panel for editing the field mapping is displayed. Make mapping choices and press the Exit function key (F3) to return to the Options panel. Press Enter again to perform the compare with the modified template.
- When you have finished viewing the report or editing the batch JCL, press the Exit function key (F3) to return to the “Old” data panel.

Related topics

[Compare Utility: Options panel on page 773](#)

[Editing a template on page 218](#)

[Creating dynamic templates on page 214](#)

[Mapping fields between templates on page 251](#)

Record synchronization

File Manager synchronizes records for comparison in several ways.

1. One-to-one

When you select this option, the compare sets are assumed to contain records in a corresponding sequence.

Non-matching records are regarded as changed records. No attempt is made to resynchronize the compare sets when non-matching records are encountered, and comparison proceeds with the next record from each compare set. Trailing records in the “New” compare set are regarded as unpaired insertions, and trailing records in the “Old” compare set are regarded as unpaired deletions.

2. Read-ahead

The data sets are assumed to contain roughly corresponding records.

Specification requirements

When read-ahead synchronization is requested, you specify a limit and a length for read-ahead synchronization processing.

The read-ahead synchronization limit controls how far ahead File Manager looks for matching records when a pair of non-matching records is found. You should try to specify a read-ahead limit a little larger than the maximum number of contiguous non-matching records you expect to be encountered in the data sets.

The read-ahead synchronization length determines how many contiguous matching records must be found for synchronization to be recognized. If you are comparing "data" records, where false matches due to blank records or other commonly repeated records are unlikely, you should specify a small read-ahead synchronization length, such as the default value of 1. If you are comparing "text" or "source" records, where false matches due to blank records or other commonly repeated records might be common, you should specify a read-ahead synchronization length greater than one.

How the records are synchronized

When non-matching records are encountered, File Manager attempts to resynchronize the data sets by looking ahead in each data set by up to the number of records specified by the read-ahead limit. If the resynchronization is successful then the non-matching records are regarded as some combination of paired and unpaired insertions and deletions, depending on where the resynchronization occurred. If the resynchronization fails, then all of the "old" and "new" records from the first mismatch up to the resynchronization limit are regarded as paired insertions and deletions.



Note: Read-ahead synchronization can only produce matched records and inserted/deleted records. By definition there cannot be changed records, so selecting the **Highlight changes** option will not highlight changes or produce a changed line.

3. Keyed

When you select this option, the compare sets are assumed to be sequenced by a key, which consists of one or more segments of the record (up to sixteen). When you press Enter to process this panel (after having made your selections for the remaining options) the Keyed Synchronization Settings panel is displayed, in which you must specify at least one key segment (and up to sixteen key segments). Any existing key segment information, such as that drawn from an intrinsically keyed data set, is displayed in the panel. You can edit or modify these details.

When you have not used a template, the following applies:

- If your data set contains an intrinsic key, as in KSDS data sets, File Manager automatically attempts to use this key as the first (or only) segment in the synchronization key.
- You can specify the location, length and data type of your key segments in the Keyed Synchronization Settings panel that is displayed after the Compare Options panel. If a data type is not explicitly specified, type AN is used.

When you define multiple key segments, each segment is checked in the specified key segment order. If an alphanumeric key field falls partly or wholly outside of a record so that the key is truncated, the key comparison is performed as though the key were padded with hex zeros or the pad character if the padding option is on. For other key types, any truncated key after the first record results in a sequence error as well as a truncation error.

If the keys do not match, records are read from the compare set with the lower ordered key until a matching or greater ordered key is found. Non-matching records with matching keys are regarded as changed records

(tallied as paired changes in the comparison summary). Records with non-matching keys are regarded as unpaired insertions and deletions. Records with keys that are out of sequence are flagged with a plus sign (+) in the comparison report. Records with truncated keys are flagged with a minus sign (-) in the comparison report. Records with keys that are both out of sequence and truncated are flagged with an asterisk (*) in the comparison report.

If you opt to use intrinsic keys for both your “Old” and “New” data sets and there is a length mismatch, File Manager uses the shorter of the two keys as the segment length. If there is any other type or length mismatch between key segments defined for the “Old” and “New” data sets, the Keyed Synchronization Settings panel contains additional columns that indicate the conflict.

You can ignore the conflict and process the panel using the values shown for the “Old” data set, or you can edit the “Old” key segment information and then continue.

4. Read-ahead Keyed

The data sets are assumed to contain roughly corresponding records.

Specification requirements

When read-ahead keyed synchronization is requested you specify a limit and a length for read-ahead synchronization processing plus key fields, which will be used for the synchronization process. Therefore, unlike Read-ahead, Read-ahead Keyed can detect and report changes to records that synchronize according to key fields but differ in regard to comparison. The order of the key fields is not used in the synchronization process.

The read-ahead keyed synchronization limit controls how far ahead File Manager will look for matching key fields when a pair of non-matching key fields is found. You should specify a read-ahead limit a little larger than the maximum number of contiguous non-matching key fields that you expect to be encountered in the data sets.

The read-ahead keyed synchronization length determines how many contiguous matching key fields must be found for synchronization to be recognized.

- If you are comparing "data" records, where false matches due to blank records or other commonly repeated records might not occur, you should specify a small read-ahead keyed synchronization length, such as the default value of one.
- If you are comparing "text" or "source" records, where false matches due to blank records or other commonly repeated records might be common, you should specify a read-ahead keyed synchronization length that is greater than one.

How the records are synchronized

When non-matching key fields are encountered, File Manager attempts to resynchronize the data sets by looking ahead in each data set by up to the number of records that are specified by the read-ahead limit. If the resynchronization is successful, the non-matching records will be regarded as some combination of paired and

unpaired insertions and deletions depending on where the resynchronization occurred. If the resynchronization fails, all of the "old" and "new" records from the first mismatch up to the resynchronization limit will be regarded as paired insertions and deletions, and the comparison will be terminated.

You can also use record selection to affect the apparent synchronization of your data sets. As a simple example, imagine you have copied a file and inserted ten new records at the start. To verify that you have not corrupted any of the existing records you might compare the original data set with the new data set, and request a read-ahead comparison with a limit of ten, which would show the added records as unpaired insertions. Alternatively, you might request a one-to-one comparison with a skip count of ten on the "New" data set, which would create a New compare set that ignores the added records completely.

Creating key sequencing for use in a multi-segment key

When you use the keyed synchronization comparison option, you can specify up to 16 segments of record information to be used as the key. A key segment consists of the key's location in the "Old" and "New" data sets and the key's length and data type. These values are built using one of the following sources or a combination of these elements:

- The intrinsic data set keys (where the data set is keyed, for example, VSAM KSDS).
- The key segment sequence information stored in your templates.
- The key location and length information supplied in the Keyed Synchronization Settings panel. This panel is displayed whenever you choose the keyed synchronization option.

To create the key segment sequence information in your template:

1. Display your template in the Field Selection/Edit panel.

When this is done as part of editing or creating a template within the compare process, the panel shows the **Key** field in place of the **Rdf** field. When done as part of editing or creating a template from any other location within File Manager, you need to enter the KEYFLDS command to display this field.

Figure 101. Field Selection/Edit showing the Key field

Process		Options		Help		
File Manager		Field Selection/Edit				Line 1 of 8
----- Criteria - Enter 1 or 2 to specify expression by field -----						
1	Id :					+
2	Sel:					+
Offset		0				
Cmd	Seq	SHE	Key	Ref	Field Name	Picture Type Start Length
					**** Top of data ****	
---	---	---		1	1 REC-TYPE01	AN 1 80
---	---	---		2	2 REC-TYPE	XX AN 1 2
---	---	---		3	2 NAME	X(20) AN 3 20
---	---	---		4	2 EMPLOYEE-NO	9(4) BI 23 2
---	---	---		5	2 AGE	9(4) BI 25 2
---	---	---		6	2 SALARY	9(7) PD 27 4
---	---	---		7	2 MONTH OCCURS 12 TIMES	9(8) BI 31 4
---	---	---		8	2 FILLER	XX AN 79 2
					**** End of data ****	
Command ==>						Scroll PAGE
F1=Help	F2=Split	F3=Exit	F4=Expand	F5=RFind	F6=RunTemp	
F7=Up	F8=Down	F9=Swap	F10=Left	F11=Right	F12=Cancel	

- In the Key fields adjacent to the fields you want to use in your multi-segment key, enter a number between one and sixteen.

Your numbers do not need to start at one and do not need to be sequential, but must be unique. The numbers provided indicate the sequence of the fields within the multi-segment key. If you are using a keyed data set (for example, VSAM KSDS) and want to include the data set's intrinsic key in your multi-segment key, you must start the numbering at two or higher. (The intrinsic data set key is always included at position one in the key sequence.)

- Save your template.

When your modified template is used in the compare process, the position and length information of the selected fields is pre-loaded into the appropriate sequence slots of the Keyed Synchronization Settings panel.

Comparison output

This section provides a general description of the comparison report produced by the File Manager Compare Utility, and lists the special flagging characters that can appear in the report to indicate various conditions. See the [Compare Utility: Options panel on page 773](#) for a description of the different listing types and how the listing options affect the report.

If you run the comparison in the foreground and you have your print output directed to the File Manager print data set, the Print Browse function is invoked to display the comparison report.

Report sections

The File Manager compare utility report contains five sections:

Prologue

The prologue is generated unless you select report **Listing Type** = "none". It lists the data sets being compared, and any copybooks or templates that were specified to filter or format the records.

Body

The report body is generated unless you select report **Listing Type** = "summary" or **Listing Type** = "none". The contents of the body is determined by the **Listing Type** (delta, matching or long) and the **Listing Options**, and whether the comparison type is record or formatted.

Summary

The summary is generated unless you select report **Listing Type** = "none". It tallies the number of records processed, the number of matching records found, the number of insertions and deletions found, the number of records that were not selected by record identification and selection criteria processing, and the number of records that were not compared due to invalid data in a formatted comparison.

The number of records not selected or not compared is only reported for non-zero totals. The number of records processed includes the "not compared" total but excludes the "not selected" total. A summary of the type of comparison and the options specified is provided. For keyed comparisons, the key segment positions and lengths are also listed.

Template details

Template details are reported when you select one of the template reporting options, unless you also select **Listing type** = "none". For each template used in a formatted comparison, the template fields can be listed along with their attributes (**Show template layouts** option). Identification and selection criteria in the templates can be listed (**Show template criteria** option) for both record comparisons and formatted comparisons. For formatted comparisons, the template mapping information can also be listed (**Show mapped fields** and **Show unmapped fields** options). You can choose the manner in which template field information is reported by means of the **Show array elements**, **Show start/end as hex offset**, and **Show length in hex** options.

If you have selected the **Show template layouts** option, each 01-level is reported, followed by each of its fields. For each field, the field name, picture clause, type, start, end, and length are reported. If possible, each field is reported on a single line, and the report layout is adjusted to allow for the maximum length of the content of the field name and picture columns. If necessary, the field name, picture clause, and remaining information is reported on separate lines.

If you have selected the **Show template criteria** option, and the template was not dynamically created from a copybook, then the identification and selection criteria expressions, if any, are reported. If either expression is not present, a message is written to the report to indicate this. Within the expressions field, names are appended to the reference identifiers as an aid to readability.

If you have selected the **Show mapped fields** option or the **Show unmapped fields** option, each new 01-level is reported, followed by each of its fields in the same format as the layout information report. Each mapped field is followed by similarly formatted information for the corresponding field from the mapped old template layout. The mapped old field information is preceded by an equals sign (=) in the **Ref** column. Similarly, each unmapped (new) field is preceded by an asterisk (*) in the **Ref** column. A horizontal rule indicates the end of the new fields, and is followed by any unmapped fields in the old template layout. These fields are also preceded by an asterisk (*) in the **Ref** column. Whether mapped or unmapped fields or both are present in the mapping information report is determined by which mapping reporting options you selected.

Field statistics

Field statistics are produced when the **Show Field Statistics** option has been selected for a formatted compare where the synchronization option is One-to-one or Keyed.

Field Statistics report

This shows the old and new field names, number of mismatches and two percentage values. The percentage values are calculated as followed:

Compared

This is percentage of the number of mismatches for the given field to the number of compared records for that record type.

Changed

This is the percentage of the number of mismatches for the given field to the number of changed records for that record type.

Body section record formats

Within the body section, any records that are printed are presented in one of four basic ways, depending on the type of comparison (record or formatted) and whether the “wide listing” option is selected. Variations on the basic layouts are created if the “show hex chars” or “highlight changes” options are selected.

Narrow record report

This report is produced when the “record” Comparison Option is selected but the “wide listing” Listing Option is not selected.

The width of the report is restricted to 132 characters, with long records being split over several lines. For matching records, only the “New” record is reported. For paired insertions and deletions and changed records, the “New” record is reported first, followed by the “Old” record. For unpaired insertions and deletions, the “orphaned” record is reported. When both the “New” and “Old” record must be split, the record sections are interspersed so that corresponding bytes remain vertically adjacent.

This format is useful if you need to print the comparison report.

Wide record report

This report is produced when both the “record” Comparison Option and the “wide listing” Listing Option are selected.

The report uses the full width of the File Manager list data set. Matching and non-matching records are reported or suppressed in the same way as for the narrow record report.

This format is generally easier to analyze than the narrow record report if you only want to review the report online.

Narrow formatted report

This report (also referred to as "single" format) is produced when the "formatted" Comparison Option is selected but the "wide listing" Listing Option is not selected.

The width of the report is restricted to 132 characters, split vertically to display fields from the "Old" and "New" data sets. Fields from the "New" data set are placed on the left side of the report, and fields from the "Old" data set are placed on the right side.

For matching records, only the "New" record fields are reported, but the "Old" record number is still reported on the right to help distinguish matching records from unpaired insertions. For paired insertions and deletions and changed records, fields from both records are reported. For unpaired insertions and deletions, the fields from the "orphaned" record are reported and the other half of the report is left blank.

This format is useful if you need to print the comparison report.

Wide formatted report

This report (also referred to as "table" format) is produced when both the "formatted" Comparison Option and the "wide listing" Listing Option are selected.

Like the wide record report, it uses the full width of the File Manager list data set, with each field formatted across the width of the report. The formatting of the fields is adjusted from normal print formatting so that the "Old" and "New" data can be vertically aligned as best as is possible for the mapped fields.

This format is generally easier to analyze than the narrow formatted report if you only want to review the report online.

Body section flags

The following flags can appear in the body section to indicate various conditions. For record comparisons and wide formatted comparisons, the flags appear in the ID column at the left of each line of data, unless otherwise indicated. For narrow formatted comparisons, the flags appear to the left of the record header information that precedes the fields for a record, or to the left of the field name.

I

Indicates an inserted record in the "New" data set.

D

Indicates a deleted record in the "Old" data set.

C

Indicates a changed record in the "New" data set when the comparison was performed using keyed synchronization. This highlights the special case where the records had matching keys but altered data.

O

Indicates the old data in a changed record when the comparison was performed using keyed synchronization.

+

Indicates a key sequence error in a “keyed” synchronization comparison.

-

Indicates a key truncation error in a “keyed” synchronization comparison.

*

Indicates both a key sequence error and a key truncation error in a “keyed” synchronization comparison.

x

Indicates invalid key data in a keyed synchronization comparison. This flag can only appear when one of the key segments has been defined with the packed data type, and the data in that segment in the current record is not valid packed decimal data.

!

Indicates a record that could not be compared in a formatted comparison because one of the fields contained invalid data, or because a field was partly or wholly outside the record. It also indicates a record whose type is not included in the template mapping.

?

Indicates a record that could not be compared in a formatted comparison because one of the fields in the corresponding record from the other data set contained invalid data, or a field that was partly or wholly outside the record. It also indicates a mapping mismatch between the record type identified for the new record and the record type identified for the old record. In this case, both the new and old records in an insert/delete pair are flagged with “?”. Changes are not highlighted for the highlight changes option because there is no mapping to define which fields to compare.

|

If the “highlight changes” Listing Option is selected with reports other than “narrow formatted”, this appears beneath the “Old” data set record in a paired insertion and deletion or changed record to indicate the changed data.

*

If the “highlight changes” Listing Option is selected for a “narrow formatted” report, this appears to the left of the new field name in a paired insertion and deletion or changed record to indicate the changed field.

When arrays are being compared and the number of array elements in the old record is different to the number of array elements in the new record, the array elements which are not matched are reported as changed fields.

Template details section

The template details section appears after the comparison summary. The information it contains depends on the combination of template reporting options you specify, the comparison type, and the information contained in the templates used in the comparison. Subject to these conditions, the overall order of presentation is as follows:

(page break)

old template report:

- first old layout
- first old layout criteria
- second old layout
- second old layout criteria
- ⋮

(page break)

new template report:

- first new layout
- first old layout criteria
- second new layout
- second new layout criteria
- ⋮

(page break)

mapping report:

data for mapped layouts:

- first mapped new layout fields and associated old fields
- unmapped old fields associated with first mapped new layout
- second mapped new layout fields and associated old fields
- unmapped old fields associated with second new layout map
- ⋮

data for unmapped layouts:

- first unmapped new layout
- second unmapped new layout
- ⋮
- first unmapped old layout
- second unmapped old layout
- ⋮



Note:

1. If the old and new templates are the same, allowing for the application of any offsets, then only one template report is produced. In this case, unmapped old fields are only reported when a layout is not mapped to itself, and unmapped old layouts are not reported at all (as they would just duplicate the unmapped new layouts).
2. Mapped old fields and unmapped old and new fields are flagged in the mapping report as described in the next section.



3. A separator line consisting of hyphens appears between the mapped new layout fields and associated old fields, and any unmapped old fields associated with a mapped new layout.
4. Any unmapped old layouts are separated from any preceding unmapped new layouts by the text *"Unmapped old template layouts:"*.

Template details flags

The following flags can appear in the template details mapping report to indicate the relationship between old and new data set template fields. The flags appear at the left side of the **Rel** column.

=

Indicates the flagged old data set template field is mapped to the preceding new data set template field.

*

Indicates the flagged old or new data set template field is unmapped.

Formatted comparison of unlike fields

When a formatted comparison is requested and the template mapping specifies that fields with unlike attributes are to be compared, File Manager attempts to compare the data in the fields in a meaningful way.

The first step is to classify each of the fields as being numeric data, bit string data, or character data. All internal (binary, packed decimal and floating point) and external (zoned decimal and external floating point) numeric data types are classified as numeric. Bit fields up to 64-bits long are classified as bit strings. All other fields, including any grouped items that have been mapped, are classified as character data.

The next step is to determine how to compare the fields. The following table shows what comparison method is used for each combination of data classifications (redundant combinations have been left blank).

Table 5. Comparison method for formatted comparison of unlike fields

Data type	numeric	bit string	character
numeric	numeric	numeric	numeric
bit string		bit string	bit string
character			character

Numeric comparison

Fields that are not defined as internal numeric types are first converted to an internal numeric type compatible for comparison with the other field. If the conversion fails, the fields do not match. Packed and zoned decimal

fields are validated before comparison, and if the validation fails, the fields do not match. Other than conversion and validation errors, and errors of precision for floating point numbers, the data types and lengths of the fields do not affect the result of the comparison.



Note: A character field containing an (external) floating point number is valid even if the field with which it is being compared is not defined as floating point.

Bit string comparison

Bit string comparison results in a match if corresponding bits in the two fields all match.

Character comparison

The result of a character comparison depends on which additional formatted Comparison Options were specified. If no additional options were specified then the fields must be the same length and corresponding bytes in each field must match exactly. You can use the additional options to specify that either leading or trailing blanks, or both, are ignored when a character comparison is performed. You can also specify an option that causes fields to match even when blank-delimited "words" have been reformatted in the field. With this option, the leading and trailing blanks options are redundant, because any contiguous series of blanks in either field is treated as if it were a single blank. To compare character fields of different lengths, specify one of these options, otherwise none of the records match. Finally, you can specify an option to ignore case when comparing character fields.



Note: Records that fail validation are flagged with an exclamation mark (!) in the comparison report. For a wide (table format) listing the flag appears in the "ID" column. For a narrow (single format) listing the flag appears to the left of the record heading.

Comparing load modules

Load modules are, as members of libraries, sequential data sets, and can be compared by content like other data sets. A record-mode compare helps to check whether load modules are the same or not, but as the result contains differences between module texts, a further analysis is usually required.

However, in most cases, you are likely to want to see differences at a logical level, rather than at record level. You may want to know, for example, if both versions of a module were linked at the same time, and if CSECTs differ in size or were compiled using the same compiler versions.

A formatted comparison of load modules allows you to compare load modules at the logical level, with the ability to select properties to be compared and reported

Conceptually, you can see the process of a formatted comparison of two load modules in the following way:

- You define information you want to compare, by selecting compare criteria at the load module level:
 - Load module size.
 - Load module entry point address.

- Version of the linkage editor or binder used to prepare the load module.
- Load module link date and time.
- AMODE and RMODE of load module.
- Load module authorization code (AC).
- Load module link attributes.
- Compile options
- Program attributes

And at the CSECT level (if you want CSECTs to be compared):

- CSECT size.
 - CSECT address.
 - Version of a language compiler used to compile the CSECT.
 - CSECT compile date.
 - AMODE and RMODE of CSECT.
 - AMASPZAP IDR data.
 - Text - CSECT content (instructions and constants).
- For each of the compared load modules, File Manager creates one or more logical records containing information extracted from load module. Load module properties, such as load module size, Entry Point Address, and load module link date, constitute fields of one logical record. Each CSECT has its own dedicated logical record containing CSECT properties, such as CSECT size, address, and compilation date. If additional CSECT information, ZAP IDR or CSECT text, need to be compared, the logical record is split into a number of physical records, with the layout appropriate to the information they hold.
 - There is a natural mapping determined by the layouts of the records and the compare criteria you selected. It defines the compare process as a formatted comparison. The record representing information at the load module level is compared with the corresponding record representing the second module. Corresponding records (records of the same CSECT name) representing CSECTs are also compared. The comparison report shows differences in a similar way to any other type of formatted comparison. Indentation shows the hierarchy of information: load module ► CSECT ► CSECT text and ZAP IDR data.

You can perform load module comparison using either the Compare Utility (3.11, or DSM in batch) or the Load Module Compare Utility (3.10.2, or CLM in batch). They share the same ISPF variables and, in batch, have the same syntax.

To perform a formatted comparison of load modules:

1. From the Primary Options menu, select Compare Utility (option 3.11).

File Manager displays the Compare Utility - "Old" Data Set Entry panel.

2. Specify the "Old" load module information.
3. Press Enter.

File Manager displays the Compare Utility - "New" Data Set Entry panel.

4. Specify the "New" load module information.
5. Press Enter.

File Manager identifies the load module on both "Old" and "New" sides and assumes that you want to perform a load module formatted comparison. Accordingly, File Manager displays the Compare Load Module Options panel, instead of the Compare Options panel.

6. Specify:

- **Comparison type:** "Formatted", unless you want the content of the load modules to be compared in record mode.
- **Compare level:** "Module" level is more general than the "CSECT" level.
- **Load module criteria:** specify the load module properties you want to compare. If no criteria is selected, then only a comparison of the load module name is performed.
- **CSECT criteria:** specify the CSECT properties you want to compare (only applicable if **Compare level** is CSECT).
- **Processing Options:** specify as required.
- **Listing Options:** specify as required.

7. Press Enter to perform the compare.

8. When you have finished viewing the report or editing the batch JCL, press the Exit function key (F3) to return to the "Old" data panel.

Related topics

[Compare Utility: "Old" and "New" panels on page 764](#)

[Compare Utility: Load module options panel on page 768](#)

Printing from File Manager

Using File Manager, you can print entire data sets, selected records from data sets, audit trail reports, template definitions and various other reports generated by File Manager utilities.

Your print output can be directed to the current SYSPRINT allocation, a temporary data set, a REXX stem variable, or to your terminal, depending upon your Print Processing options. You can also use these options to specify the format and layout of your print output.

If you are working in online mode and your print output has been directed to a temporary data set, you can send that data set to a printer by taking the following steps:

1. From the Command line of any menu or Entry panel, enter the PB command (Print Browse), or for the File Manager debug trace, enter the PBT command (Print Browse Trace). This displays the current contents of your temporary print or trace data set.
2. Enter the PRINT command. This sends the data set to the SYSOUT class *c* allocated to a printer in your work environment.

Setting your Print Processing Options

The Print Processing Options control such things as the destination of your print output, the page format to use and the number of records to print.

Additional Print formatting options information (redefined fields, field reference number, field type and length values, picture clause, start location, structure) are shared with the Edit/Browse options and can be set using Edit/Browse options (0.6) in Settings.

To set your options:

1. From the File Manager Primary Options Menu, select option **0 Settings**. The Set Processing Options Menu panel is displayed.
2. Select option **1 Print**. The Set Print Processing Options panel is displayed.
3. Set your print processing options:

Output destination

Where you want the printed output sent:

SYSPRINT

Send print output to the current SYSPRINT allocation.

Typically, SYSPRINT is allocated to the terminal, making this option synonymous with TERMINAL. However, you can allocate SYSPRINT in other ways.

Terminal

Send print output to the terminal.

Data set

Output is accumulated in the print data set specified in the **Data set name** field. This data set can be browsed using the PB command or sent to the JES spool queue for printing by issuing the PRINT command while browsing the data set. (The output is sent to the JES spool queue class specified in the Output class field.)

REXX

Send print output to the REXX stem variable FILEM.

Choose this option when you want to control your printing from within a REXX program.

Record length

How many columns wide the output is

Page skip

Whether output from each function starts on a new page

Wide print

Whether the maximum print line length for print output is used

Translate non-printable chars

Whether non-printable characters are translated to blanks

Uppercase message text

Whether all message text is translated to uppercase.

Data prefix

Whether the output contains a data header for each record

Header page

Whether the output contains a header page at the beginning

Data set DISP

Whether the print output is appended to the existing data set (MOD) or replaces it (OLD).



Note: This option only affects output sent to the print data set specified in the PRINTDSN option.

Dump format

Which format (updown or across) is used for hexadecimal print output

Data set name

The print data set where print output is directed when the PRINTOUT print option is set to SYSOUT=c

Output class

The class of the JES spool queue to be used when the PRINT command is issued while browsing the temporary print data set.

Lines per page

How many lines per page the output has

Record limits

Which part of each record to print

4. Press the Exit function key (F3) to save your changes and exit from the panel.

Related topics

[Set Print Processing Options panel \(option 0.1\) on page 1025](#)

[Editor Options panel on page 868](#)

Printing data sets

You can use the Print Utility to print supported data sets or members in a selected format. Concatenated like and unlike sequential data sets are supported. Note that, under some conditions (with tape data sets), File Manager may not be able to detect unlike data set attributes and still invoke DFSORT for print processing. Such invocation may fail as DFSORT does not

allow for unlike concatenation of data sets. In such cases, you can disable DFSORT with the NOSORT function to allow for successful processing of concatenated data sets with unlike attributes.

You can print data by record, by block (non-VSAM) or control interval (VSAM), or by field using a template. You can select records for printing using any (or none) of these:

- The start key (VSAM only).
- Skip and print count fields.
- Criteria and record type selection defined in a template.

You can use a template to:

- Select the records you want to print
- Select the fields you want to print
- Specify the number of columns allocated to each field when printing in TABL format
- Suppress leading zeros for numeric fields
- Modify field headings

In SNGL print format, additional record information (redefined fields, field reference number, field type and length values, picture clause, start location, structure) can be printed depending on the Edit/Browse options. Numeric fields can be left-justified depending on the options.

An example showing how the print output in SNGL print format can vary (depending on the Edit/Browse options) is shown in [Printing a single record on page 411](#).

You can also use a DFSORT™ or REXX procedure, contained in a specified PDS member, to further enhance the Print Utility.

The Print Utility can be run in foreground or as a batch job.

To print a data set:

1. From the Primary Option Menu panel, select **3. Utilities**.
2. From the Utilities Menu panel, select **2. Print**. The Print Utility panel shown in [Figure 291: Print Utility panel on page 977](#) is displayed.
3. Perform either of these actions
 - Specify the data set or PDS member that contains the data you want to print, using a combination of the **Data set name**, **Member**, and **Volume serial** entry fields.
 - To select a range of members based on selection criteria, specify the data set name or name pattern for a PDS or PDSE and optionally the member name or pattern, and select the **Advanced member selection** option.



Note: If you enter details in the **Member** field and select the **Advanced member selection** option, File Manager populates the **Member name** field on the subsequent Advanced Member Selection panel with the same value.

4. Select the data that you want to print, at either the record level or field level:

- For record-level selection, use the following entry fields on the Print Utility panel:

Start key

The starting key or slot location for a VSAM file

Skip count

The number of records to be skipped before processing begins

Include

The number of physical records that to be included in a repeating sample from a data set. Both **Include** and **Repeat Skip** fields must have non-zero values for sampling to take effect.

Repeat skip

The number of physical records to be skipped in a repeating sample from a data set. Both **Include** and **Repeat Skip** fields must have non-zero values for sampling to take effect.

Print count

The number of records to be printed

- For field-level selection, use a template.

If you specify both record-level and field-level selection, File Manager first selects data at record level, then at field level.

5. Specify your processing options to control the way in which the data is selected and printed.

You can specify:

- The print format
- If a template is to be used
- Block or control interval printing
- If you want to edit a template
- Batch or foreground processing
- A procedure to be called by the Print Utility

6. If your data is in a sequential data set or PDS or PDSE member, is in ISPF PACK format and you have not specified an I/O exit, you can select an ISPF Packing option.

1. Unpack

Select this option when you want File Manager to unpack the data before any user processing or printing occurs.

2. None

Select this option when you do not want File Manager to detect the ISPF PACK format and to operate on any packed data in its packed format.

This is the only valid option when your data is not a sequential or PDS data set, or when the Use I/O exit option has been used.

3. Skip

Select this option when you want File Manager to detect data in ISPF PACK format and stop any processing or printing for the data set or member.

7. Additional print formatting options are available after selecting the **Additional print options** option. These options allow for the printed output to contain additional information about record structure, as well as controlling the inclusion of records when their length does not match the layouts of the template records.
8. Press Enter.

If you selected the **Advanced member selection** option, File Manager displays the Advanced Member Selection panel:

- a. Specify the selection criteria to select the members you want to print and press Enter.
- b. If you have left the **Member name** field on the Advanced Member Selection panel blank or have entered an asterisk (*) or a mask, File Manager displays the Member selection panel. In this case, select the members you want to print (either by typing an "S" in the **Cmd** field, or with the SELECT primary command) and press Enter.

File Manager sends the output to the location specified in your Set Print Processing Options.

If you have sent the output to a print data set, you can view the data set using Print Browse (option 3.9). While you are using Print Browse, you can use the PURGE primary command to clear the print data set. To transfer the contents of the print data set to a SYSOUT class, press the Print function key (F4).

By using a print data set in this way, you can avoid print width truncation that might occur with TABL format printing.

Related topics

- [Print Utility panel on page 977](#)
- [Managing templates on page 199](#)
- [Setting your Print Processing Options on page 403](#)
- [Selecting a range of PDS\(E\) members on page 70](#)
- [Advanced Member Selection panel on page 726](#)
- [Editor Options panel on page 868](#)
- [Print Options panel on page 975](#)

Using a DFSORT or REXX procedure

You can specify an existing DFSORT or REXX procedure, or create a new one, to further enhance the way in which data is selected and printed.

If you have a template, first use the selection criteria within the template to select your data. For more sophisticated tasks, use DFSORT statements to select data, manipulate the output records, and to write to other files. Use REXX to execute other functions that are provided by File Manager, and to perform complex tasks that cannot be achieved any other way.



Note: In REXX procedures for the Print Utility, avoid using the PRINT() function, as its output is interspersed with the output from the Print Utility.

For general information about using DFSORT or REXX procedures, see [Enhancing File Manager processing on page 517](#).

Example 1

This is a DFSORT procedure that prints all records where the surname at column 10 is “Smith”.

```
*FASTPROC
OMIT COND=(10,10,CH,NE,C'SMITH ')
```

Example 2

This example uses REXX to report on total salaries paid, where the salary is a packed number starting at column 20 for a length of 7.

```
rc = tally(20,7,P,'Total Salaries Paid')
```

REXX member selection

For PDS or PDSE data sets, you can determine whether a member should be printed or not printed, depending upon a condition being true within the member records. This conditional test is supplied to File Manager via a REXX procedure that includes at least one of the following RETURN strings:

RETURN PROCESS MEMBER

Indicates that the member is to be included in the print. No more records in this member are passed to the REXX proc. The member is printed intact, subject to any specified template processing, which is performed before the user REXX proc is invoked.

RETURN DROP MEMBER

Indicates that the member is to be excluded from the print. No more records in this member are processed. Processing continues with the next member.

When REXX member selection is in effect, records are read from an input member and then cached in memory until the decision is made whether the member is to be printed. Once the decision has been made, the entire member is either printed or dropped, depending upon the return string specified.

If the entire member is processed without encountering a DROP MEMBER or PROCESS MEMBER return string, the member is processed according to the specified default action. If either of these strings is returned by the REXX processing when REXX member selection HAS NOT been specified, it is treated as if it was a RETURN with no argument strings, except that a warning message is issued. Subsequent records continue to be passed to the REXX proc. Similarly, if a DROP, STOP or STOP IMMEDIATE string is returned by the REXX processing when REXX member selection HAS been specified, it is treated as if it was a RETURN with no argument strings, except that a warning message is issued. Subsequent records continue to be passed to the REXX proc until a decision has been made on whether to DROP or PROCESS the member.

Other REXX statements that control the dropping or updating of records are not performed when REXX member selection is used. Any changes to the special File Manager-defined REXX variable OUTREC are ignored. However, REXX statements that do not involve updating or dropping records are performed. This may lead to some unexpected results. In general, if you need to print members of a PDS conditionally based on the contents of the member, and also want to manipulate the contents of the member, try to execute this task as a two-step process using separate REXX procedures.

To specify conditional member processing:

1. On the Print Utility panel, specify your data set name and other print options.
2. Select the REXX member selection option and specify the default action (P or D) in the adjacent field. If this field is left blank, P is assumed. P denotes process or print the member, D specifies drop or do not print the member.
3. Select the Use proc option and specify an existing REXX procedure or enter an * in the field to create a new REXX procedure. This procedure must contain a conditional test and at least one of the relevant RETURN strings.
4. Complete the printing process as required.

Example 1

In this example, the SUBSTR function is used to test records in each member being processed. When the procedure encounters a record in which the condition tests as True, the entire member is dropped from processing. All other members are printed or not printed, according to the default setting on the Print Utility panel.

```
if substr(inrec,4,3) = '333'
then RETURN DROP MEMBER
return
```

Example 2

This example demonstrates what happens when you use REXX member selection at the same time as other REXX procedure statements. In this scenario, you are attempting to print members in a data set and to tally a value in those members at the same time.

The first member (MEM1) contains 5 records:

```
AAA111BBB456CCC789
AAB222BBB456CCC789
AAC333BBB456CCC789
AAA444BBB456CCC789
AAA555BBB456CCC789
```

The second member (MEM2) contains 4 records:

```
AAA001BBB456CCC789
AAA002BBB456CCC789
AAA003BBB456CCC789
AAA004BBB456CCC789
```

The Print Utility REXX member selection default is set to 'P', and the following procedure is supplied.

```
/* rexx */
if substr(inrec,1,3) = 'AAA' /* If cols 1-3 in current rec contain 'AAA' */
then x = tally(4,3,Z,'total') /* then add up the value in columns 4-6 */
```

```

if substr(inrec,4,3) = '333' /* If cols 4-6 contain '333' */
then RETURN DROP MEMBER /* then drop member from print processing */
if substr(inrec,4,3) = '003' /* If cols 4-6 contain '003' */
then RETURN PROCESS MEMBER /* then process (print) member */
return

```

The tally for “total” includes the first record from MEM1, even though MEM1 is dropped from the print process. The second and third records don't satisfy the 'AAA' requirement and so aren't tallied, and the subsequent records won't be processed because the decision to drop has been made while processing the third record.)

The tally for “total” also includes the first three records in MEM2. The fourth record is not processed by the REXX proc because the decision to print has been made while processing the third record. The end result of this print action is that MEM1 is dropped, MEM2 is printed, and the tally for “total” equals 117. (111 + 1 + 2 + 3).

Printing DBCS data

When printing in character or hexadecimal format, you can also print double-byte character set (DBCS) data, if you have the necessary hardware. Use Set DBCS Format (option 3.0) to specify which data in each record is in DBCS format, mixed format, or EBCDIC format within an input record; and use Compiler Language Selection (option 0.5) to specify a DBCS-capable language.

If you want to align DBCS and EBCDIC data in printed output, use a font that sets the width of each DBCS character to 2 EBCDIC bytes.

If printing in TABL or SNGL format, the format definition is taken from the template, and any DBCS formatting set by this option is ignored.

When you select the Set DBCS Format option, the Set DBCS Format panel shown in [Figure 309: Set DBCS Format panel on page 1019](#) is displayed.

You can define up to 32 fields in ascending order. They must not overlap, but they need not be contiguous. Specify for each field:

Start column

The first column in the record where the data is located.

End column

The last column in the record where the data is located. An asterisk (*) indicates end of record.

Type

The type of data:

EB

EBCDIC

DB

DBCS

These are graphics fields, that is, data that is DBCS, but stored without the shift-out and shift-in characters.

MI

Mixed format

For all areas you do not define, File Manager creates an EBCDIC field definition.



Note:

1. To cause the type DB to correctly format DBCS characters for printing, the language used for File Manager must be a DBCS-capable language.
2. To print a listing of the current format definitions, enter the LIST primary command.
3. To restore your definitions to the default value of `1,* ,EB`, enter the RESET primary command.

Printing a single record

At times, you may want to print a single record. Instead of setting up your template and selection criteria to narrow your selected records down to the one you require, you can print individual records. To do this:

1. Display your data in a Browse or Edit panel.
2. Select your display format (SNGL, TABL, CHAR, HEX or LHEX).
3. Scroll your data until the record that you want to print is at the top of the data area.
4. Enter one of the following primary commands:
 - RD ("Record Dump") - this prints the current record in dump format, with hexadecimal values under the record data.
 - RP ("Record Print") - this prints the current record. The format of the output from the RP command depends on the display format when you enter the RP command. While printing records in SNGL view, additional information (redefined fields, field reference number, field type and length values, picture clause, start location, structure) can be printed depending on the Edit/Browse options. Numeric fields can be left-justified depending on the options.

Examples

Here is an example of RD output when the display format is CHAR:

```

-----1-----2-----3-----4-----5-----6-----7-----8
          CHAR CToyota          Avalon          AVALONConq
          ZONE CE9A9A844444444444444444CA8999444444444444CECDDDC999
          NUMR 336863100000000000000015136500000000000001513653658
            01---+-----1-----2-----3-----4-----5-
          CHAR Duncan Autos          SedanAuto62995PSteeLYYYY
          ZONE 29CA98894CAA9A44444444444444E8889CAA9FFFFFDEA889EEEE
          NUMR 8C44531501436200000000000000254151436629957235538888
            101---+-----1-----2-----3-----4-----5-

```

Here is an example of RP output when the display format is CHAR:

```

-----1-----2-----3-----4-----5-----6-----7-----8
IBM File Manager for z/OS
                                CToyota          Avalon          AVALONConq
                                Duncan Autos      SedanAuto62995PSteeLYYYY
    
```

Here is an example of RP output when the display format is SNGL (with all additional formatting options selected):

```

-----1-----2-----3-----4-----5-----6-----7-----8
Ref Field                          Picture Typ Start  Len  Data
-----
Record Number - 8

  1 1 VEHICLE-REC                    AN    1  159
  2 2 VEHICLE-TYPE                   X     AN    1    1  C
  3 2 VEHICLE-MAKE                   X(20) AN    2   20  Toyota
  4 2 VEHICLE-MODEL                  X(20) AN   22   20  Avalon
  5 2 MODEL-CODE                     X(6)  AN   42    6  AVALON
  6 2 VEHICLE-SUB-MODEL              X(20) AN   48   20  Conquest
  7 2 YEAR-OF-MANUFACTURE            9(4)  ZD   68    4  2000
  8 2 NUMBER-ADVERTISED              9(4)  ZD   72    4    1
  9 2 FOR-SALE OCCURS 1 TO 100 TIMES DEPENDING ON NUMBER-ADVERTISED
    2 FOR-SALE(1)                    AN   76   84
 10 3 REGO-NUMBER                    X(8)  AN   76    8  1ARW-832
 11 3 COLOUR                         X(8)  AN   84    8  Green
 12 3 ODOMETER                       X(7)  AN   92    7  53864
 13 3 ASKING-PRICE                   S9(6) PD   99    4  25289
 14 3 DEALER                         X(25) AN  103   25  Duncan Autos
 15 3 BODY-TYPE                      X(5)  AN  128    5  Sedan
 16 3 TRANS-TYPE                     X(4)  AN  133    4  Auto
 17 3 ENGINE-TYPE                    9     ZD  137    1    6
 18 3 ENGINE-CAPACITY                9(4)  ZD  138    4  2995
    
```

Here is an example of RP output when the display format is SNGL (with no additional formatting options selected):

```

-----1-----2-----3-----4-----5-----6-----7-----8
Field                                Data
-----
Record Number - 8

VEHICLE-TYPE                          C
VEHICLE-MAKE                          Toyota
VEHICLE-MODEL                         Avalon
MODEL-CODE                            AVALON
VEHICLE-SUB-MODEL                     Conquest
YEAR-OF-MANUFACTURE                   2000
NUMBER-ADVERTISED                     1
REGO-NUMBER(1)                        1ARW-832
COLOUR(1)                             Green
ODOMETER(1)                           53864
ASKING-PRICE(1)                       25289
DEALER(1)                             Duncan Autos
BODY-TYPE(1)                          Sedan
TRANS-TYPE(1)                         Auto
ENGINE-TYPE(1)                        6
ENGINE-CAPACITY(1)                   2995
    
```

Here is an example of RP output when the display format is TABL:

```

-----+-----1-----+-----2-----+-----3-----+-----4-----+-----5-----+-----6-----+-----7-----+-----8
VEHICLE-TYPE VEHICLE-MAKE          VEHICLE-MODEL          MODEL-CODE VEHICLE-SUB-MO
AN 1:1      AN 2:20                AN 22:20              AN 42:6   AN 48:20
-          <-----+-----1-----+-----> <-----+-----1-----+-----> <-----+> <-----+-----1-----
C          Toyota              Avalon                 AVALON     Conquest

```

Related topics

[Browse panel on page 746](#)

[RD primary command on page 1201](#)

[RP primary command on page 1214](#)

Printing your Audit Trail Report

Use the Print Audit Trail Report function to print an audit trail report using the contents of the audit trail data set. An audit trail data set is created if:

- The **Create an audit trail** option is selected when you use either the Edit data or Edit MQ data function.
- The auditing setting in the FMN0POPT macro has been set to YES or DEMAND.
- A SAF rule is in place for the function and resource.



Note: You can create an audit trail data set yourself using the batch job FMNSMFX (supplied with File Manager). This job creates an audit trail data set using data from the SMF log file. For details, see the *File Manager for z/OS Customization Guide*.

When you select the **Print audit trail report** option, the Print Audit Trail panel shown in [Figure 289: The Print Audit Trail panel on page 974](#) is displayed.

To print an audit trail report:

1. Specify the name of the audit trail data set that contains the audit trail data you want to print (**Data set name**).

If File Manager created the audit trail data set, the name is in the format *userid.FMNLOG.Dyymmdd.Thhmmss* where:

userid

is the ID of the user

FMNLOG

is a constant that identifies the data set as an audit log (trail)

Dyymmdd

is the date File Manager created the audit trail data set

Thhmmss

is the time File Manager created the audit trail data set



Note: If the AUDITHLQ option is set in the FMN0POPT macro (see *File Manager for z/OS Customization Guide*), audit trail data sets have the name *audithlq.userid.FMNLOG.Dyyymmdd.Thhmmss*.

If you created the audit trail data set yourself, use the data set name you specified in the supplied batch job FMNSMFX. For details, see the *File Manager for z/OS Customization Guide*.

2. To help identify your audit trail report, use the **Description** entry field. If the description contains embedded spaces, you must enclose it in quotation marks. The description you enter appears on the Formatted Audit Event Records section of the report.
3. Select the processing options you want:
4. Press Enter.

Audit trail report

The audit trail report is divided into two sections: Detailed Statistics and Summary Statistics.

The Detailed Statistics section shows all audited inserted, deleted, read, written, and before and after change records. The format of this section of the report can be further controlled by the options available on the Print Audit Trail panel. If a template was used when accessing the data, the report is formatted.

The Summary Statistics section lists the totals of the records reported together with the function and resource information pertaining to this report.

Chapter 8. Using File Manager utilities

File Manager offers many utilities that you can use to work with your data, memory and storage systems.

This chapter provides information about and instructions for using these utilities. The major tasks and concepts are:

- [Managing catalog entries on page 415](#)
- [Displaying a Volume Table of Contents \(VTOC\) on page 432](#)
- [Browsing AFP Print documents on page 437](#)
- [Browsing your user storage on page 437](#)
- [Viewing load module information on page 438](#)

Managing catalog entries

To manage your catalog entries from within File Manager, you can use the Catalog Services Utility.

Catalog Services uses IDCAMS system services to obtain and process catalog information. For instance, the effect of using the Alter, Define, and Delete services, is the same as using the equivalent IDCAMS command with the same parameters.



Note: To use Catalog Services effectively, you need a basic understanding of the catalog system and IDCAMS usage. For more information about IDCAMS, see *z/OS DFSMS Access Method Services for Catalogs*.

The tasks and concepts described in this section are:

- [Available catalog services on page 415](#)
- [Selecting your service on page 416](#)
- [Working with a list of catalog entries on page 418](#)
- [Viewing your Catalog Entry Details on page 422](#)
- [Defining a new Catalog Entry on page 426](#)
- [Changing an existing Catalog Entry on page 429](#)
- [Recalling catalog entries on page 431](#)

Available catalog services

The services you can choose are:

List catalog entries

Displays a subset of catalog entries based on a generic name or entry type.

Display entry information

Displays the details of a single catalog entry.



Note: In batch, you can use the DSI function to print the details about a data set.

Print catalog entries

Prints a list of catalog entries that match the criteria (data set name, catalog name, and type) that you have specified. The printed output is produced according to the print options you have specified.

Alter catalog entry

Changes the definition of a single catalog entry.

Define catalog entry

Defines a new catalog entry, of the type specified. For non-VSAM entries, you can choose whether or not to allocate the data set as you are defining it. For other data types, the data set allocation is automatically done.

Delete catalog entry

Deletes a single catalog entry.

Related topics

[Printing from File Manager on page 402](#)

Selecting your service

To select an IDCAMS service:

1. From the Utility Functions menu, select **4 Dslist**. The Catalog Services panel is displayed.
2. Enter the **Data set name**:
 - Specify either a fully-qualified data set name or a generic data set name when you want to:
 - list catalog entries; or
 - print catalog entries.
 - Specify a fully-qualified data set name when you want to:
 - alter a catalog entry;
 - define a catalog entry;
 - delete a catalog entry; or
 - display entry information.
3. Optionally enter a catalog name. If you leave the **Catalog ID** entry field blank, File Manager uses the system catalog search order.
4. Select the **Entry type**.

You can use the entry type processing option to restrict the catalog search to a specified type, or to search all types by selecting **Any**. The effect of this option depends on the catalog service you have chosen:

- For all services, except "Define catalog entry", it simply restricts the search to entries of the specified type.
- When you select an entry type (other than **Any**) with the "Define catalog entry" service, it predetermines or restricts the type of entry to be defined.

Restricting the search (by using an entry type other than **Any**) is most useful with a generic data set specification.

The entry type processing options are:

Any

Any catalog entry.¹

Non-VSAM

A non-VSAM data set entry. This type includes all non-VSAM data sets (such as PDSs, PDSEs, IAM and ordinary sequential data sets) but does not include non-data set types (such as aliases and GDGs).

VSAM

Any VSAM data set entry. This type includes all VSAM data sets, not just clusters and their components.¹

AIX®

A VSAM alternate index entry.

Alias

An alias entry.

Cluster

A VSAM cluster entry.^{1, 2}

Data

A VSAM data component entry.^{1, 2}

GDG

A generation data group entry.

Index

A VSAM index component entry.^{1, 2}

OAM

An Object Access Method entry.³

Page space

A system page data set entry.³

1. If you specify this entry type, and define a new catalog entry without using an existing catalog entry as a model, File Manager displays a pop-up menu, from which you can select a specific entry type.
2. When a component of a VSAM data set matches a search, all the components of the data set appear in the resulting list, whether they match the search or not. For example, if you have a VSAM ESDS with a cluster called FMN.ESDS and a data component called FMN.ESDS.D and specified the generic data set name `FMN.ES*` with entry type Data, both the cluster and data components are displayed, even though the type of the cluster is not a match. In fact, it would be displayed even if its entry name did not match.
3. These services are not supported:
 - “Define catalog entry”
 - “Delete catalog entry”
 - “Alter catalog entry”

Path

A VSAM path entry.

User catalog

A user catalog entry.³

5. To generate the data set list with all data sets matching the qualifiers in the **Data set name** field, including data sets with additional qualifiers, select the **Include Additional Qualifiers** option.
6. If you are defining, deleting, listing, or printing a catalog entry and you want to run the command in batch, select the **Batch execution** option.
7. To show all dates on the Data Set List panel and listing as YY/MM/DD (instead of the default YYYY.DDD), select the **YY/MM/DD date format (def. YYYY.DDD)** option.
8. To limit the number of data sets selected for VTOC or catalog processing, select the **Processing limit** option and type the maximum number of entries in the adjacent entry field.
9. Select one of the services listed at the top of the Catalog Services panel by typing the appropriate entry on the Command line. Leave the Command line blank for the "List catalog entries" service.
10. Press Enter. File Manager searches the system catalogs for the data set or sets you have specified and performs the service you have requested.



Note: Catalog Services attempts to help you to invoke IDCAMS such that your request is successful, but this is not always possible. If an error occurs, a pop-up window might be displayed containing IDCAMS messages.

Related topics

[Specifying a data set and a member name on page 42](#)

[Catalog Services panel on page 756](#)

Working with a list of catalog entries

When you select the "List catalog entries" option on the Catalog Services panel, a list of catalog entries is displayed.

A sample catalog services data set list is shown in [Figure 196: Catalog Services: list of catalog entries \(initial display\) on page 759](#). The list includes the following information for each entry:

Field descriptions

Catalog Id

The catalog used for the current list function, if applicable.

Types

The entry type used for current list function.

Type

The type of a specific catalog entry.

Volume

The first volume in volser-list.

MV

A multi-volume data set indicator:

blank

single volume

*

single volume with multi-volume capability

2-9

number of volumes

!

more than 9 volumes

Created

Creation date.

Dsorg

The organization of the data set:

PS

Sequential

PSU

Sequential unmovable

PSE

Sequential extended format

PO

Partitioned

POU

Partitioned unmovable

POE

Partitioned extended (PDSE)

DA

Direct

DAU

Direct unmovable

HFS

MVS Hierarchical File System

VS

VSAM

VSE

VSAM extended format

Blank

None of the above

Recfm

The record format of the data set.

Lrecl

The logical record length of the data set.

XT

Number of extents.

KB allocd

Number of kilobytes currently allocated for a VSAM, NVSAM or PDSE data set.

%Used

The percentage of currently allocated space used for a VSAM, NVSAM or PDSE data set. For VSAM files this figure is calculated using the FREESPC value.

KB Avail

Number of kilobytes currently available for a VSAM, NVSAM or PDSE data set.

%Avail

The percentage of currently available space for a VSAM, NVSAM or PDSE data set.

%HiUsed

The highest used byte as a percentage for a data set. For VSAM files this figure is calculated using the HI-URBA value.

Hi KB Avail

Number of kilobytes above the highest used byte for a data set.

%HiAvail

The percentage of space above the highest used byte.

SYS%

This column contains the value χ if the data set is managed by the DFSMS SYS% conversion utility, otherwise, it is blank.

To scroll to see more information, press the Right function key (F11).

If a catalog error occurs (for example, if the data component of a VSAM cluster is not found), ERROR appears in the **Entry type** field. You can look for more information about such errors by entering the AMSMSG command and viewing the IDCAMS messages.

To update your list view, to include any changes that you have made and also any changes made by other users since you first displayed the list, enter the REFRESH primary command.

To view or find a data set entry, choose from the following techniques:

- To move forward or backward through the list, use the Down function key (F8) or the Up function key (F7). You can also enter a value in the **Scroll** field. You can also use the scroll commands to move the display window over the list.
- Use the FIND command to search for a character string that forms part or all of the data set name.
- Use the LOCATE command to scroll to a particular row number.

To select a service, perform either of these actions

- Type the line command:
 1. Move the cursor to the beginning of the line that contains the name of the entry that you want to work with.
 2. Type the command (for example, `BROWSE`). You can type an equal sign (=) to perform the same command for more than one entry.

You can abbreviate the line commands to their first letter, (for example, A instead of ALTER) except in the case of EDIT and EXTENTS, where you would use the first two letters.

- Select the function from the Process pull-down menu:
 1. Move the cursor to the entry with which you want to work.
 2. Press the Process function key (F6). (If the cursor is outside the list area, you work with the first entry in the list.) The selected line is highlighted in another color. The Process pull-down menu opens below the action bar as shown in [Figure 102: Catalog Services: list of catalog entries with Process pull-down menu on page 422](#).
 3. Select an option on the menu to perform a function such as browse or edit.

To define or delete a catalog entry and run the function in batch:

1. Select the **Batch execution** option on the Catalog Services panel.
2. Select the **with list** option on the Catalog Services panel.
3. On the Data Set List panel, enter the DEFINE or DELETE line command against the catalog entry you want to work with.

Figure 102. Catalog Services: list of catalog entries with Process pull-down menu

Process	Options	Help
1. Alter		Data Set List
2. Define		Row 00001 of 00012
3. Copy		Types ALLVSAM
4. Delete		Dsorg Recfm L
5. List	A.**	* * *
6. Browse	A.ESDS	09/08/14
7. AFP Browse	A.ESDS.DATA	09/08/14
8. Edit	A.ESDSN	09/08/17
9. View	A.ESDSN.DATA	09/08/17
10. Info	A.ESDS2	09/08/14
11. Extents	A.ESDS2.DATA	09/08/14
12. Print	A.KSDS	07/08/30
13. Recall	A.KSDS.DATA	07/08/30
14. Rename	A.KSDS.INDEX	07/08/30
15. AMS message	A.KSDS2	08/12/17
16. Refresh	A.KSDS2.DATA	08/12/17
17. Exit	A.KSDS2.INDEX	08/12/17
	**	

Command ==>

F1=Help	F2=Split	F3=Exit	F4=CRetriev	F5=RFind	Scroll PAGE
F7=Up	F8=Down	F9=Swap	F10=Left	F11=Right	F6=Process
					F12=Cancel

Related topics

- [Scrolling to see data on page 117](#)
- [Catalog Services Data Set List panel on page 759](#)
- [FIND/FX primary command on page 1157](#)
- [LOCATE primary command on page 1182](#)
- [REFRESH primary command on page 1205](#)
- [Catalog Services Data Set List panel on page 759](#)
- [Manipulating your view of selection lists on page 62](#)

Viewing your Catalog Entry Details

To view the Catalog Entry Details for your data set:

- Perform either of these actions:
 - In the Catalog Services panel, type a fully qualified data set name (and optionally the catalog name) for the *existing* entry, then enter **I** on the Command line.
 - From the Catalog Services panel, display a list of data set names.
- In the Data Set List panel, enter **I** in the line command field adjacent to the entry you want to view.

An Entry Details panel for the entry type of your data set is displayed, showing the catalog information. For example, if your data set is a VSAM KSDS file, the VSAM Entry Details panel is displayed.

The Entry Details panel shows basic information about your data set. From this panel, you can display another panel that shows information about the associations for your data set. For VSAM files only, you can display another panel that shows the VSAM Extent information.

To display or alter any other information, you must use the IDCAMS utility. For more information about IDCAMS parameters, see z/OS DFSMS Access Method Services for Catalogs.

Related topics

- [AIX Entry Detail panel on page 734](#)
- [GDG Entry Detail panel on page 910](#)
- [IAM KSDS Define panel on page 916](#)
- [Non-VSAM Entry Detail panel on page 957](#)
- [Path Entry Detail panel on page 959](#)
- [VSAM Entry Detail panel on page 1102](#)

Viewing association information

When there is more than one AIX®, path or alias association for your entry, the Entry Details panel shows a message in the relevant field, for example:

```
VSAM Associations:
  Path . . . . . *** multiple paths defined over cluster ***
  AIX . . . . . *** multiple AIXs associated with cluster ***
```

You can display these associations in a separate panel. To do this, enter the ASSOCS command, or press the ASSOCS function key (F6). The Associations Information panel appropriate for your current entry type is displayed.

To return to the Entry Detail panel from the Associations Information panel, enter the INFO primary command, or press the INFO function key (F6).



Note: If you do not alter the PF key assignments, F6 acts as a toggle switch between these two panels.

Related topics

- [AIX Association Information panel on page 733](#)
- [Non-VSAM Association Information panel on page 955](#)
- [VSAM Association Information panel on page 1098](#)
- [ASSOCS primary command on page 1120](#)
- [INFO primary command on page 1176](#)

Statistics for VSAM data sets

To display more information about the statistics of a VSAM data set, enter the STATS command, or press the STATS function key (F11). The VSAM Extent Detail panel is displayed, showing VSAM statistics for every extent on every volume for the selected data set.

To return to the Entry Detail panel from the VSAM Extent Details panel, enter the INFO primary command, or press the INFO function key (F11).



Note: If you do not alter the PF key assignments, F11 acts as a toggle switch between these two panels.

Related topics

- [AIX Association Information panel on page 733](#)
- [Non-VSAM Association Information panel on page 955](#)
- [VSAM Association Information panel on page 1098](#)
- [STATS primary command on page 1229](#)
- [INFO primary command on page 1176](#)

Displaying volume information

To display volume information for a VSAM or non-VSAM data set, from the VSAM Entry Detail panel or Non-VSAM Entry Detail panel, enter the VOLUME primary command, or press the Volumes function key (F5). File Manager displays a pop-up Volume Information panel (see [Figure 103: Volume Information panel on page 424](#)) showing a list of allocated volumes for the selected data set.

Figure 103. Volume Information panel

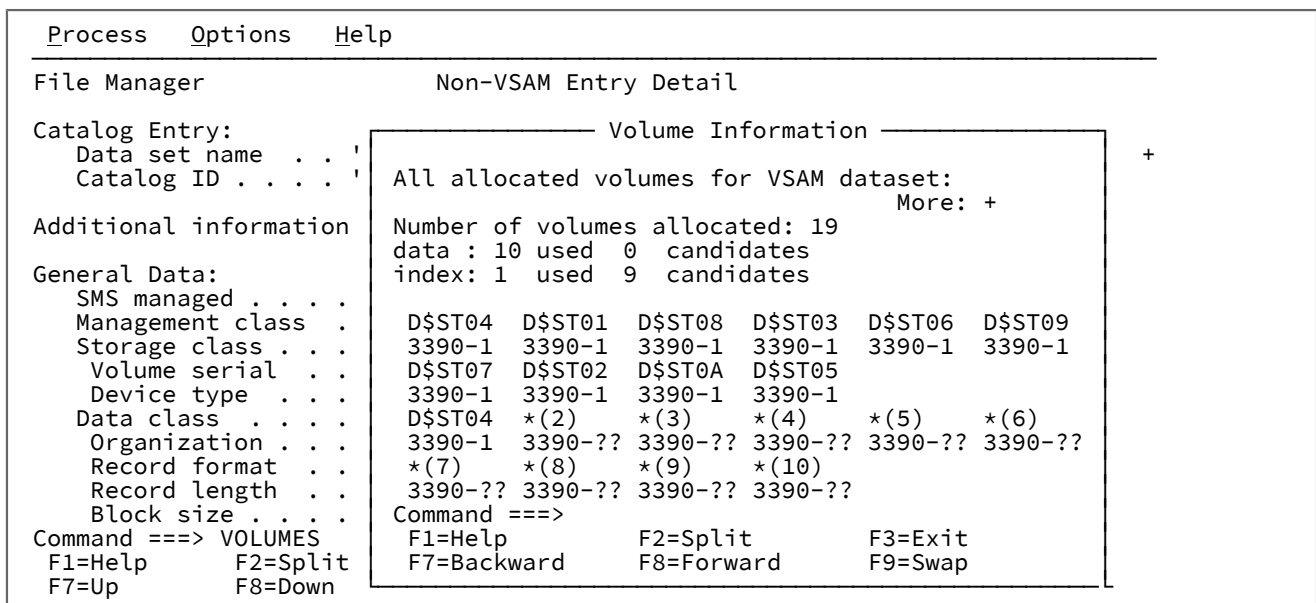

To return to the VSAM Entry Detail panel or Non-VSAM Entry Detail panel from the pop-up Volume Information panel, press the Exit function key (F3).

Related topics

- [VSAM Entry Detail panel on page 1102](#)
- [Non-VSAM Entry Detail panel on page 957](#)
- [VOLUME primary command on page 1237](#)

Displaying extent details for non-VSAM data sets

To display extent details for a non-VSAM data set, from the Non-VSAM Entry Detail panel, enter the EXTENT primary command, or press the Extents function key (F11). File Manager displays the Non-VSAM Extent Information panel showing.

To return to the Non-VSAM Entry Detail panel from the Non-VSAM Extent Information panel, press the Exit function key (F3).

Related topics

[Non-VSAM Entry Detail panel on page 957](#)

[Non-VSAM Extent Information panel on page 958](#)

[EXTENT primary command on page 1154](#)

IAM Entry Detail display

IAM is a product that provides an alternative for VSAM (KSDS and ESDS) cluster processing. This is provided through its own emulation code and internal data set format. The data sets that IAM creates are considered by z/OS® as non-VSAM data sets (with a DSORG of either PS or DA).

File Manager recognizes when IAM is present and when displaying information about non-VSAM data sets provides IAM-related information for those data sets that are controlled by IAM.

IAM Entry detail panels contain information describing the non-VSAM data set that IAM uses to emulate a VSAM cluster. This includes the data set name, the catalog in which it belongs, the type of cluster being emulated (KSDS or ESDS), creation and expiry dates of the data set and, if applicable the SMS classes associated with this non-VSAM data set.

The IAM product provides its own form of LISTCAT information which it normally sends to the IAMPRINT data set or, if no IAMPRINT DD is allocated IAM sends the LISTCAT information as TSO messages to the user's screen (when using TSO). File Manager dynamically allocates a temporary data set to the IAMPRINT DD in order to capture and present this information on the same panel as the non-VSAM data set details.



Note: For more information, refer to your IAM documentation.

If you select an IAM entry, the IAM Entry Detail panel is displayed. [Figure 104: Example: Catalog Services parameters for an IAM entry \(first panel\) on page 426](#) shows an example of the first part of this panel. You can scroll up and down the list of parameters.



Figure 104. Example: Catalog Services parameters for an IAM entry (first panel)

```

Process  Options  Help
-----  -
File Manager          IAM Entry Detail          Line 1 of 32

IAM NONVSAM Entry details:
Catalog Id . . . . 'CATALOG.UCATAPC'
Data set name . . 'FMNUSER.TESTMV.IAM.ESDS'
VSAM data type . . ESDS          (KSDS or ESDS)
Creation date . . 2001.331      Expiration date . (NONE)
SMS managed . . . Y          Data class . . . *UNKNOWN
Storage class . . . BASE      Management class . STANDARD
Last backup date . 0000.000.0000

IAM details from IAMPRINT:
IAM100 IAM FILE ANALYSIS - DSN=FMNUSER.TESTMV.IAM.ESDS
-----
FILE FORMAT -- = ENHANCED - FILE STATUS ----- = LOADED
RECORD SIZE -- = 27990 - FREESPACE - CI% ----- = 0
CI SIZE ----- = 32768 - FREESPACE - CA% ----- = 0
BLOCK SIZE --- = 32760 - EXTENDED PE ----- = 8635 BLOCK
BLOCK FACTOR - = 1 - REQUESTED OVERFLOW ---- = 0 RECS

Command ==>
F1=Help      F2=Split      F3=Exit      F4=CRetriev  F7=Up        Scroll CSR
F9=Swap      F10=Actions   F11=Stats    F12=Cancel   F8=Down

```

Defining a new Catalog Entry

You can define a new catalog entry, using an existing entry as a model, or you can define a new entry without a model and specify all of the required fields yourself. If you define a new non-VSAM catalog entry, you must choose to either only define the catalog entry or define the entry and allocate the data set.

To define a new catalog entry using an existing catalog entry as a model:

1. In the Catalog Services panel:
 - a. Type the data set name (and optionally the catalog name) for the *existing* entry.
 - b. To run the define function in batch, select the **Batch execution** option.
 - c. Enter `DEF` on the Command line.
 - d. Press Enter.
 - e. If you are defining an alternate index for a VSAM file (AIX®), you can also request that the newly defined AIX® is built following the define, or that an existing AIX® is deleted, redefined and rebuilt. The define, build and redefine functions are available for online and batch processing.

When you define an alternate index for a VSAM file (AIX®), File Manager displays a pop-up panel as shown in [Figure 105: Catalog Services panel on page 427](#).

Figure 105. Catalog Services panel

```

Process  Options  Help
-----
File Manager          Catalog Services          More:  +
blank List catalog entries          A Alter catalog entry
  DEF Define catalog entry          DEL Delete catalog entry
  I Display entry information        P Print catalog entries

Data Set:
Data set name . 'SYATES.UNITTEST.RFM0189.ESDS4.AIX1'
Catalog ID   . .

Processing Options:
Entry Type
4 1. Any          6.
  2. Non-VSAM    7.
  3. VSAM        8.
  4. AIX         9.
  5. Alias       10.

Command ==>
F1=Help    F2=Split    F3=Exit    F4=CRetrieval F7=Backward F8=Forward
F9=Swap    F10=Actions F12=Cancel

Select the type of AIX processing:
- 1. AIX define only
  2. AIX define and build
  3. AIX redefine and rebuild

Command ==>
F1=Help    F2=Split    F3=Exit    F4=CRetrieval F7=Backward F8=Forward
F9=Swap    F10=Actions F12=Cancel

```

Select the type of AIX® processing you want:

- To define an AIX®, select **1. AIX® define only**.
- To define and build an AIX®, select **2. AIX® define and build**.
- To delete, recreate, and then rebuild an existing AIX®, select **3. AIX® redefine and rebuild**.

A Define panel for the entry type of your existing data set is displayed, containing the information copied from your model. For example, if your existing data set was a VSAM KSDS file, the VSAM Define panel is displayed.

2. Alter the contents of the **Data set name** field to specify a new, unique data set name.
3. For the **Catalog ID** field:
 - If SMS is active on the system, the new value for the catalog ID is copied from the model data set but prefixed with an asterisk (*) to indicate a “comment” value. this value is ignored unless you remove the asterisk.
 - If SMS is not active on the system, the catalog name is copied from the model data set.

Do one of the following:

- Blank the field out, to allow the system to assign your data set using the catalog selection order for IDCAMS DEFINE.
- Remove the asterisk (*) from the existing entry, to assign your data set to the same catalog.

If the specified catalog is not the same as the related user catalog for this Entry type, a warning message is issued. You can Exit from the message (F3) and change or blank out the catalog name, or you can press Enter to continue using the initial catalog name. If you choose to continue, you need to supply the catalog name in all future searches for the Entry.

- Specify an alternative Catalog ID.

4. For VSAM data sets, alter the component name or names, listed under the Basic Information heading, to unique names suited to your data set.

OR

Blank out the component name or names listed under the Basic Information heading. File Manager generates new component names based upon the following AMS rules:

- a. IF the last qualifier of the Entry data set name is CLUSTER, it replaces the last qualifier with DATA for the data component and INDEX for the index component. For example:

```
Cluster name: SALES.REGION2.CLUSTER
Generated data name = SALES.REGION2.DATA
Generated index name = SALES.REGION2.INDEX
```

- b. ELSE if the cluster name is less than or equal to 38 characters, then append .DATA to the end of the cluster name for the data component and .INDEX for the index component. For example:

```
Cluster name: DEPT64.ASSET.INFO
Generated data name = DEPT64.ASSET.INFO.DATA
Generated index name = DEPT64.ASSET.INFO.INDEX
```

- c. ELSE if the cluster name is between 39 and 42 characters inclusive, then append .D to the end of the cluster name for the data component and .I for the index component.

```
Cluster name: DEPTABCD.RESOURCE.REGION66.DATA1234.STUFF
Generated data name = DEPTABCD.RESOURCE.REGION66.DATA1234.STUFF.D
Generated index name = DEPTABCD.RESOURCE.REGION66.DATA1234.STUFF.I
```

- d. ELSE if the name is longer than 42 characters, and the last qualifier is not CLUSTER, use the first (N-1) qualifiers of the cluster, alternate index, or user catalog name up to the first four qualifiers, and append as many 8-character qualifiers as necessary to produce a 5-qualifier name. For example:

```
Cluster name: DIV012.GROUP16.DEPT98.DAILYLOG.DEC1988.BACK
Generated data name = DIV012.GROUP16.DEPT98.DAILYLOG.TY7RESNO
Generated index name = DIV012.GROUP16.DEPT98.DAILYLOG.YIIQHNTNTR
```

After a name is generated, AMS searches the catalog to ensure that the name is unique. If a duplicate name is found, AMS continues generating new names using the format outlined in [4.d on page 428](#) until a unique one is produced.

5. Alter any of the remaining parameters (copied from the existing entry) to suit your new entry.
6. Press Enter to process your define request.

To define a new catalog entry *without* an existing catalog entry as a model:

1. In the Catalog Services panel:
 - a. Type a new, unique data set name (and optionally a Catalog ID).
 - b. Select your **Entry Type** option.
 - c. To run the define function in batch, select the **Batch execution** option.
 - d. Enter `DEF` on the Command line.
 - e. If you are defining an alternate index for a VSAM file (AIX®), you can also request that the newly defined AIX® is built following the define, or that an existing AIX® is deleted, redefined and rebuilt. The define, build and redefine functions are available for online and batch processing.

When you define an alternate index for a VSAM file (AIX®), File Manager displays a pop-up panel as shown in [Figure 105: Catalog Services panel on page 427](#). Select the type of AIX® processing you want:

- To define an AIX®, select **1. AIX® define only**.
 - To define and build an AIX®, select **2. AIX® define and build**.
 - To delete, recreate, and then rebuild an existing AIX®, select **3. AIX® redefine and rebuild**.
- f. Press Enter.

You might be prompted to further refine your entry type, depending on which Entry Type you selected.

A Define panel for the entry type that you selected is displayed. If this is the first catalog entry you have defined in your current session, the fields in this panel are empty. If you have previously defined a catalog entry with the same type, the field information is pre-filled with the values last used in the panel.

2. Supply the required values and press Enter to process the define request. (File Manager prompts you to complete all of the required fields).

[AIX Entry Detail panel on page 734](#)

[GDG Entry Detail panel on page 910](#)

[IAM KSDS Define panel on page 916](#)

[Non-VSAM Define panel on page 955](#)

[Non-VSAM Allocate panel on page 954](#)

[Path Entry Detail panel on page 959](#)

[VSAM Define panel on page 1099](#)

Changing an existing Catalog Entry

1. Perform either of these actions:
 - In the Catalog Services panel, type a fully qualified data set name (and optionally the catalog name) for the *existing* entry, then enter `A` on the Command line.
 - From the Catalog Services panel, display a list of data set names.

To rename a VSAM data set (CLUSTER and its corresponding components), enter `REN(ame)` in the line command field adjacent to the entry you want to change. File Manager displays the VSAM Entry Rename panel for the data type of your data set is displayed, showing the data set information that can be changed. The component names of a VSAM CLUSTER are adjusted automatically based on the newly entered data set name. If a finer degree of control over the component names is required, then the `ALTER` command may be used to adjust component names manually. To change any additional VSAM parameters, use the `ALTER` command.

2. In the Data Set List panel, enter `A` in the line command field adjacent to the entry you want to view.

An Entry Details panel for the data type of your data set is displayed, showing the catalog information that can be altered in editable fields. For example, if your data set is a VSAM KSDS file, the VSAM Entry Details panel is displayed.

3. Alter any of the parameters to suit your requirements.
4. For VSAM data sets, if you alter the data set name and want the component names to match your new name, blank out the component name or names listed under the Basic Information heading. File Manager generates new component names based upon the following ASM rules:

- a. IF the last qualifier of the Entry data set name is CLUSTER, it replaces the last qualifier with DATA for the data component and INDEX for the index component. For example:

```
Cluster name: SALES.REGION2.CLUSTER
Generated data name = SALES.REGION2.DATA
Generated index name = SALES.REGION2.INDEX
```

- b. ELSE if the cluster name is less than or equal to 38 characters, then append .DATA to the end of the cluster name for the data component and .INDEX for the index component. For example:

```
Cluster name: DEPT64.ASSET.INFO
Generated data name = DEPT64.ASSET.INFO.DATA
Generated index name = DEPT64.ASSET.INFO.INDEX
```

- c. ELSE if the cluster name is between 39 and 42 characters inclusive, then append .D to the end of the cluster name for the data component and .I for the index component.

```
Cluster name: DEPTABCD.RESOURCE.REGION66.DATA1234.STUFF
Generated data name = DEPTABCD.RESOURCE.REGION66.DATA1234.STUFF.D
Generated index name = DEPTABCD.RESOURCE.REGION66.DATA1234.STUFF.I
```

- d. ELSE if the name is longer than 42 characters, and the last qualifier is not CLUSTER, use the first (N-1) qualifiers of the cluster, alternate index, or user catalog name up to the first four qualifiers, and append as many 8-character qualifiers as necessary to produce a 5-qualifier name. For example:

```
Cluster name: DIV012.GROUP16.DEPT98.DAILYLOG.DEC1988.BACK
Generated data name = DIV012.GROUP16.DEPT98.DAILYLOG.TY7RESNO
Generated index name = DIV012.GROUP16.DEPT98.DAILYLOG.YIIQHNTNTR
```

After a name is generated, AMS searches the catalog to ensure that the name is unique. If a duplicate name is found, AMS continues generating new names using the format outlined in [4.d on page 430](#) until a unique one is produced.

5. Press Enter to process your request.

Related topics

- [AIX Entry Detail panel on page 734](#)
- [Catalog Services Data Set List panel on page 759](#)
- [GDG Entry Detail panel on page 910](#)
- [IAM Entry Details panel on page 917](#)
- [Non-VSAM Entry Detail panel on page 957](#)
- [Path Entry Detail panel on page 959](#)
- [VSAM Entry Detail panel on page 1102](#)

Deleting a catalog entry

1. To run the delete function in batch, select the **Batch execution** option on the Catalog Services panel.
2. Perform either of these actions:
 - In the Catalog Services panel, type a fully qualified data set name (and optionally the catalog name) for the *existing* entry, then enter `DEL` on the Command line.
 - From the Catalog Services panel, display a list of data set names.

3. In the Data Set List panel, enter `DEL` in the line command field adjacent to the entry you want to view.

A Delete Entry panel is displayed, showing the data set name, catalog ID and volume serial.

4. Specify your additional delete options, by entering Y or N in the fields:

Erase

Specify Y if the space occupied by the data set is to be overwritten with binary zeros when the data set is deleted; specify N if the space is not to be overwritten; or leave blank to use the erase option set when the catalog entry was defined or last altered.

Purge

Specify Y to delete the catalog entry regardless of the retention period specified, otherwise specify N.

Scratch

Specify Y if the data set is to be removed from the VTOC of the volume on which it resides, otherwise specify N.

This parameter is not applicable to entries which do not have a VTOC entry.

5. Press Enter to process your request.



Note: For non-VSAM data sets, the `DEL` command does not remove the actual data set, unless you specify Y for Erase, Purge and Scratch.

Recalling catalog entries

When a catalog entry has been migrated or archived, the status is indicated in the **Prim volume** column of the Data Set List panel as follows:

Figure 106. Migrated catalog entries in Data Set list

Process Options Help				Row 00001 of 00027	
File Manager		Data Set List		Types ALL	
Catalog ID ' '		Type	Volume	MV	Creat ±
Data Set Name		*	*	*	*
PAM.V99R1M0.S*					
PAM.V99R1M0.SPAMCLIB		HSM	MIGRAT		19/02
PAM.V99R1M0.SPAMDBRM		NVSAM	D\$FM09		19/02
PAM.V99R1M0.SPAMEXEC		NVSAM	D\$FM10		19/02
PAM.V99R1M0.SPAMMAC1		NVSAM	D\$FM00		19/02
PAM.V99R1M0.SPAMMENU		NVSAM	D\$FM19		19/02
PAM.V99R1M0.SPAMMJPN		NVSAM	D\$FM09		19/02
PAM.V99R1M0.SPAMMKOR		NVSAM	D\$FM03		19/02
PAM.V99R1M0.SPAMMODA		HSM	MIGRAT		19/02
PAM.V99R1M0.SPAMMODJ		NVSAM	D\$FM00		19/02
PAM.V99R1M0.SPAMMODK		NVSAM	D\$FM10		19/02
PAM.V99R1M0.SPAMMOD1		HSM	MIGRAT		19/02
PAM.V99R1M0.SPAMMOD2		NVSAM	D\$FM04		19/02
PAM.V99R1M0.SPAMPENU		NVSAM	D\$FM09		19/02
PAM.V99R1M0.SPAMPJPN		NVSAM	D\$FM16		19/02
PAM.V99R1M0.SPAMPKOR		NVSAM	D\$FM13		19/02
Command ==>		Scroll PAGE			
F1=Help	F2=Split	F3=Exit	F4=CRetriev	F5=RFind	F6=Process
F7=Up	F8=Down	F9=Swap	F10=Left	F11=Right	F12=Cancel

To recall these entries:

1. Enter the RECALL line command in the Command area adjacent to the catalog entry.



Attention: A TSO message is displayed, that tells you to press the ATTENTION key to free your TSO session.

Do not do this.

```
ARC1020I DFSMSHSM IS RECALLING FROM DASD
DSN=XYZ.TEST.DTCU.ASMLLST, YOU MAY
CONTINUE THE RECALL IN THE BACKGROUND AND FREE
YOUR TSO SESSION BY PRESSING THE ATTENTION KEY
```

2. Wait until TSO indicates that the recall has been completed by displaying

```
***
```

after the message.

3. Press Enter to return to the File Manager screen.

OR:

1. Enter the command corresponding to the action you wish to take for that data set. For example, to recall a data set to copy it using the File Manager data set copy function, enter `COPY` against the file, or specify the data set in the copy utility as normal, to recall the data set.

Related topics

[Catalog Services Data Set List panel on page 759](#)

Displaying a Volume Table of Contents (VTOC)

To display or print a list of data sets on one or more disks, you can use the Work with VTOC utility. With this utility, you can list either all the data sets, or a subset of the data sets based on a generic data set name. You can also use Work with VTOC to display or print a volume summary list (VTOC list), or print a combined data set and VTOC list.

See [Display VTOC panel on page 837](#) for details.

The information in the data set list includes:

- Data set name
- Volume (VOLSER)
- Disk extents
- File organization information
- Creation, expiration, and referred dates

In online mode, you can enter commands to invoke functions that operate on individual data sets.

See [Display VTOC Data Set List panel on page 843](#) for details.

The information in the volume summary list includes:

- Volume information
- VTOC information
- Free space information
- Data set statistics

See [Volume Summary/Selection panel on page 1097](#) for details.



Note: Work with VTOC shows “never to expire” expiration dates of 99/999 and 99/366 as 9999.999 and 9999.366, respectively. An expiration date that was explicitly specified as 99/365 is also considered “never to expire”, and is shown as 9999.365. If you sort the list by expiration date, values beginning with 9999 appear first.

To display the VTOC information:

1. From the Utility Functions menu panel, select option **5. VTOC**. The Display VTOC panel shown in [Figure 225: Work with VTOC panel on page 838](#) is displayed.
2. Specify the disk volume or volumes with which you want to work. You can specify a generic volume serial number, such as D\$US1*.



Note: If you specify a pattern that causes a large number of volumes to be accessed, the operation can take a long time.

3. You can limit the data sets that are listed by specifying selection criteria in a number of fields on the Display VTOC panel:

Data set name

Specify a generic data set name. If you do not specify a data set name, File Manager uses the default generic data set name of '*' which causes all data sets to be listed or included. If you do not type quotation marks around the data set name (mask), File Manager prefixes the data set name with your TSO PROFILE PREFIX (usually your user ID). For example, to limit the data sets to just the ones starting with your TSO PROFILE PREFIX, specify the generic data set name of ** (no quotation marks). Any valid ISPF data set name mask can be used as the generic name.

Volume serial

Specify a fully-qualified or generic volume serial number.

Volume status

Specify a fully-qualified volume status string of PRIVATE, PRIV/RSDNT, RESIDENT, PUBLIC, or STORAGE.

Unit

Specify a fully-qualified or generic device address.

Device type

Specify a fully-qualified or generic device type.

SMS SG

Specify a fully-qualified or generic SMS storage group name.

To select a non-SMS controlled volume in an SMS environment, specify the reserved name, `NONSMS`.

Processing limit

Type a "/" to select this option and then specify the maximum number of data sets to be selected for VTOC processing.

4. If required, select the **Batch execution** option. File Manager then displays the Display VTOC Batch Sort Options panel.

On this panel, select the appropriate sort option. File Manager then generates the batch job stream and the JCL is presented in an Edit session. If necessary, you can change the JCL before submitting the job.

5. To display dates in the format YY/MM/DD (instead of the default format YYYY.DDDD), select the **YY/MM/DD date format (default: YYYY.DDD)** option.
6. By default, for data sets with multiple extents, the display format suppresses the data set name on the second and subsequent extents. To show the data set name for each extent, select the **Repeat data set name for each extent** option.

To update your list view, to include any changes that you have made and also any changes made by other users since you first displayed the list, enter the REFRESH primary command.

To display or print a volume summary list (like the one shown in [Figure 107: Work with VTOC: list of volumes on page 435](#)):

1. Enter the line command **V** to display the list.
2. Enter the line command **P** to print the list. File Manager then displays the Display VTOC Batch Sort Options panel.

On this panel, select the appropriate sort option. File Manager then produces the requested VTOC listing.

When you specify a generic volume serial number, File Manager displays a list of those volumes that contain data sets with names that match the specified data set name. If you select a data set list command, a data set list with all data sets matching the specified data set name and volume serial is produced.

Figure 107. Work with VTOC: list of volumes

Process	Options	Help								Row 00001 of 00005		
File Manager		Volume Summary/Selection										
Unit *	DSN	'DTORNEY.FMDATA.**'										
DevType *	VOLSTATE	ALL							SMS SG *			
Volumes 5	Data sets 7	VSAM 3							non-VSAM 4			
VOLSER D\$US5*	Trks used N/A	Free N/A							Utilized N/A			
VOLSER UNIT	Dtype	SMS-SG	Total	Used	%Used	Free	trk	Tot	DSN	VSAM	nVSA ±	
D\$US5* *	*	*										
— D\$US51	E801	3390	PRIMARY	150255	128750	86	21505	1			1	
— D\$US53	E81C	3390	PRIMARY	150255	142702	95	7553	1			1	
— D\$US55	E929	3390	PRIMARY	150255	141320	94	8935	1			1	
— D\$US57	EA52	3390	PRIMARY	150255	127706	85	22549	2		2		
— D\$US58	EA55	3390	PRIMARY	150255	131406	87	18849	2		1	1	
**** End of data ****												
Command ==>												
F1=Help	F2=Split	F3=Exit	F4=CRetriev	F5=RFind	F6=Process	Scroll PAGE						
F7=Up	F8=Down	F9=Swap	F10=Left	F11=Right	F12=Cancel							

To see more information about a volume listed on the Volume Summary/Selection panel, enter the line command I (Information) in the **Sel** field next to the volume you are interested in. The I line command displays the Disk Volume Details panel showing detailed information about the volume you selected.



Note: To show data set statistics on the Disk Volume Details panel (under the heading "Data Sets"), the **Limited information for VTOC list** option on the Display VTOC panel (that you used to navigate to this point) must be deselected.

On the Volume Summary/Selection panel you can use the S (Select) line command to select which volume you want to work with. If you want lists of data sets from more than one volume, you can enter the S line command on multiple lines. If you are going to select many volumes, you can use the ALL command to fill in the S on every line for you (you might then, if you wish, deselect any volume by overtyping its S with a blank).

File Manager lists the data sets as shown in [Figure 108: Work with VTOC: list of data sets on page 436](#).

Figure 108. Work with VTOC: list of data sets

Process	Options	Help	
File Manager		Display VTOC Data Set List	
Unit *	DSN	'PAM.V99R1M0.S*'	
DevType *	VOLSTATE	ALL	SMS SG *
Volumes 10	Data sets	27	VSAM 0
VOLSER *	Trks used	3752	Free N/A
Data Set Name		Seq	Volume Begin CYL-HD ±
PAM.V99R1M0.S*		*	* Utilized N/A
_____	PAM.V99R1M0.SPAMCLIB	1	D\$FM08 32 14
_____	PAM.V99R1M0.SPAMDBRM	1	D\$FM09 8802 4
_____	PAM.V99R1M0.SPAMEXEC	1	D\$FM10 1060 0
_____	PAM.V99R1M0.SPAMMAC1	1	D\$FM00 7885 1
_____	PAM.V99R1M0.SPAMMENU	1	D\$FM19 172 13
_____	PAM.V99R1M0.SPAMMJPN	1	D\$FM09 9025 8
_____	PAM.V99R1M0.SPAMMKOR	1	D\$FM03 6363 10
_____	PAM.V99R1M0.SPAMMODA	1	D\$FM02 2881 0
_____	PAM.V99R1M0.SPAMMODA	2	D\$FM02 109 0
_____	PAM.V99R1M0.SPAMMODA	3	D\$FM02 109 10
_____	PAM.V99R1M0.SPAMMODA	4	D\$FM02 110 5
_____	PAM.V99R1M0.SPAMMODA	5	D\$FM02 111 0
Command	===>	Scroll PAGE	
F1=Help	F2=Split	F3=Exit	F4=CRetriev
F7=Up	F8=Down	F9=Swap	F10=Left
			F11=Right
			F12=Cancel

By using the RIGHT and LEFT commands or corresponding function keys, you can scroll the list to see the other columns.

To print a combined data set and volume summary list report, use the **PC** line command. File Manager produces a summary output for each disk, followed by the list of data sets located on the volume that match the selection mask (if any).

Using line commands with Work with VTOC

For each *line* command (see [Display VTOC Data Set List panel on page 843](#)), perform either of these actions

- Type the command:
 1. Move the cursor to the beginning of the line that contains the name of the entry that you want to work with.
 2. Type the command (for example, `BROWSE`). You can type an equal sign (=) to perform the same command for more than one entry.

You can abbreviate the line commands to their first letter, for example, A instead of ALTER except in the case of EDIT and EXTENTS where you would use the first two letters.

- Select the function from the Process pull-down menu:
 1. Move the cursor to the entry with which you want to work.
 2. Press the Process function key (F6). (If the cursor is outside the list area, you work with the first entry in the list.) The selected line is highlighted in another color. The Process pull-down menu opens below the action bar.
 3. Select an option on the menu to perform a function such as browse or edit.

Related topics

[Manipulating your view of selection lists on page 62](#)

Browsing AFP Print documents

AFP Print Browse provides a formatted display of an Advanced Function Printing (LIST3820) document. For File Manager to be able to process the AFP file, it must have undergone the final processing performed by ACIF or a similar product. In particular, the file must contain the following records:

- begin document 'd3a8a8'x,
- begin multifunc overlay 'd3a8df'x,
- begin image block 'd3a87b'x
- presentation text 'd3ee9b'x

File Manager formats any readable text using the embedded position information and stores it in a temporary file. Graphical data is not included.

When you select the AFP Print Browse option, the AFP Print Browse panel shown in [Figure 180: AFP Print Browse panel on page 730](#) is displayed.

You can specify the range of pages to be formatted and change the viewing size for better formatting results.

You can also use the FIND primary command to find the next occurrence of a character string. For example, `FIND MISPELL` finds the next occurrence of “mispell” in the LIST3820 document.

The formatted data is displayed with additional page separator lines. You can use scroll commands (see [Scrolling to see data on page 117](#)) and step from page to page through the document.

AFP Print Browse primary commands

You can enter the following primary commands on the command line:

- FIND - see [FIND/FX primary command on page 1157](#)
- LOCATE - see [LOCATE primary command on page 1182](#)
- NEXTPAGE - this command is unique to the AFP Browse panel. For an explanation of its function, see [AFP Print Browse panel on page 730](#)
- PREVPAGE - this command is unique to the AFP Browse panel. For an explanation of its function, see [AFP Print Browse panel on page 730](#)

Browsing your user storage

You can use Memory Browse to display your user storage in dump format.

As you review your data, File Manager saves up to 64 browse addresses in a pointer chain. You can move forwards and backwards through this chain, to return to previously visited areas.

To view your user storage:

1. Perform either of these actions:

- From the Utility Functions menu, select option **8 Storage**.
- From any panel in File Manager, enter the MB primary command.

The Memory Browse panel, shown in [Figure 275: Memory Browse panel on page 952](#), is displayed.

2. Scroll through your storage area, using any of the following techniques.

- Use the DOWN (F8), UP (F7), TOP and BOTTOM commands. The areas reviewed using these commands are not saved in your pointer chain.
- Enter a location, in hexadecimal format, into the **Browse address** field and then enter the NEXT command. This sets a new browse address and saves the current browse address to the chain.
- Place the cursor onto a pointer value visible on the screen and then enter the NEXT command. This sets a new browse address and saves the current browse address to the chain.
- Enter a FIND command on the Command line. This sets a new browse address and saves the current browse address to the chain.
- Check that your cursor is not on a data field, then enter the NEXT or BACK commands without parameters to move through existing addresses in your chain.

3. You can use the **Search limit** field to restrict the area searched.

Memory Browse primary commands

You can enter the following primary commands on the command line:

- BACK - this command is unique to the Memory Browse panel. For an explanation of its function, see [Memory Browse panel on page 952](#)
- BOTTOM - see [BOTTOM primary command on page 1122](#)
- CLIPBOARD - this command is unique to the Memory Browse panel. For an explanation of its function, see [Memory Browse panel on page 952](#)
- DOWN - see [DOWN primary command on page 1146](#)
- FIND - see [FIND/FX primary command on page 1157](#)
- NEXT - this command is unique to the Memory Browse panel. For an explanation of its function, see [Memory Browse panel on page 952](#)
- TOP - see [TOP primary command on page 1232](#)
- UP - see [UP primary command on page 1234](#)

You can also browse the data saved to the clipboard by the PUT command during an Edit session. To do this, perform either of these actions

- Enter `MB` on the Command line of the Edit panel (the Memory Browse panel is displayed) and enter `CLIPBOARD` on the Memory Browse Command line to display the saved data
- Enter `MB CLIPBOARD` on the Command line of the Edit panel to display the saved data directly.

Viewing load module information

Use View Load Module to display or print a list of the symbols in a load module (or program object).

Symbols include CSECTs, common sections, entry points, and ZAPs. This utility also works in batch and with REXX.

To view your Load Module information:

1. From the Utility Functions menu, select option **3.10.1 Load Module Information**. The View Load Module selection panel, shown in [Figure 270: View Load Module: selection panel on page 935](#), is displayed.
2. Specify the load module you want to display, using the fields under the heading **Input**.
3. Use the **Processing Options** to specify the order in which the symbols are displayed, and if you want the output to be displayed on a terminal or spooled to a printer.
4. If desired, select the YY/MM/DD date format option. (The default date format is Julian.)
5. Press Enter. File Manager displays the contents of the specified load module as shown in [Figure 263: View Load Module: Information panel on page 927](#).
6. Use the DOWN (F8), UP (F7), TOP, and BOTTOM commands to scroll through your data.

Working with WebSphere® MQ

You can access WebSphere® MQ queues on the z/OS® system where File Manager is running.

From the Primary Option Menu panel, select option **9 WebSphere® MQ**. File Manager displays the WebSphere MQ Functions panel:

```

  Process  Options  Help
  -----
File Manager                Websphere MQ Functions

 1 List          List Managers and queues.
 2 View          View a WMQ queue.
 3 Edit          Edit a WMQ queue.
:

```

To access WebSphere® MQ queues, from the WebSphere MQ Functions panel select option **1 List** to display the Websphere MQ Managers panel.

```

  Process  Options  Help
  -----
File Manager                Websphere MQ Managers                Row 0001 of 0004

  SSID  ↓ Name      Active  Code  Reason
  <----+--> <----+--> <----+--> <----+--> <-----10-----2---->
- CSQ1   CSQ1MSTR Active   0     MQRN_NONE
- CSQ2   CSQ2MSTR Active   0     MQRN_NONE
- CSQ3   CSQ3MSTR Active   0     MQRN_NONE
- CSQ4   CSQ4MSTR Active   2     MQRN_Q_MGR_NOT_AVAILABLE
**** End of data ****
:

```

The WebSphere® MQ Managers panel shows a list of WebSphere® MQ queue managers and, for each one, whether File Manager is able to connect to the queue manager.

If File Manager cannot connect to a queue manager, the connection completion code and the MQ mnemonic for the reason code are displayed in the list.

If the required WebSphere® MQ libraries are not available to File Manager, the queue managers are shown but the connection status shows `*NOLIB*`.

```

Process  Options  Help
-----
File Manager                Websphere MQ Managers                Row 0001 of 0004
SSID   ↓ Name      Active  Code   Reason
<----+----> <----+----> <----+----> <----+----> <----+-----10-----2---->
_ *NOLIB*
:
    
```

- To **display the attributes of a queue manager** from the list of queue managers displayed on the WebSphere® MQ Managers panel, enter the I prefix command. File Manager displays the Websphere MQ Manager Information panel.

For each attribute, you can obtain a description by placing the cursor on the field and pressing the Help function key (typically F1).

To change any attributes, enter the ALTER primary command (to enable each attribute for editing), type the new values and press the Exit function key (F3) to perform the changes (File Manager issues an ALTER QMGR command).

- To **select a queue manager** from the list of queue managers displayed on the WebSphere® MQ Managers panel, enter the S prefix command. File Manager displays the WebSphere® MQ Queue List panel showing a list of the queues for that queue manager. By default, the queues are sorted by queue name.

```

Process  Options  Help
-----
File Manager                Websphere MQ Queue List CSQ2        Row 0001 of 0109
Queue                               ↓ Descr                               →
<----+-----10-----+-----2-----+-----3--> <----+-----10-----2-----+-----3-----4-->
_ CICS01.INITQ                       CKTI initiation queue
_ COOL                               Coolest queue ever
_ CSQ1.XMIT.QUEUE                    Transmission queue for CSQ1
_ CSQ2.DEAD.QUEUE                    CSQ2 dead-letter queue
_ CSQ2.DEFXMIT.QUEUE                 CSQ2 default transmission queue
_ CSQ3.XMIT.QUEUE                    Transmission queue for CSQ3
_ CSQ4IVPG.TRIGGER                   WebSphere MQ IVP INITIATION QUEUE
_ CSQ4IVP1.TRIGGER                   WebSphere MQ IVP INITIATION QUEUE
_ D3.CSQ2.ANYQ
_ FMN.TEST.NOGET                     RFM0037 GET NOT ENABLED
:
    
```

The WebSphere® MQ Queue List panel shows the attributes for each queue in the displayed list. You can scroll right or left through the attributes for a queue as indicated by the arrows (→ and ←).



Note: For a description of these attributes, see *“Administering MQ by using MQSC commands”* in the IBM® MQ documentation.

From the WebSphere® MQ Queue List panel, you can invoke various actions by typing one of these prefix commands against a listed queue:

A

To add a queue.

File Manager displays the Websphere MQ Queue Information panel with all blank fields allowing you to enter details for the new queue. When you press the Exit function key (F3), File Manager issues a DEFINE QLOCAL command with the attributes set as entered on the panel.

D

To delete the queue.

E

To edit the queue.

File Manager displays the Websphere MQ Queue Editor Entry from which you navigate to edit the queue.

**Notes:**

1. When editing a remote queue or an alias to a remote queue, message data is written to the associated transmission queue according to the remote queue definition.
2. When editing a queue, File Manager first checks if the user has CONTROL access to the *qmgr.CONTEXT.queue* resource in the MQADMIN class. This check is performed when the File Manager session is started, consequently, the user must have authority to perform this check. When a message is updated, the MQ message context is preserved if the user has CONTROL access to the *qmgr.CONTEXT.queue* resource in the MQADMIN class. If not, the message context is replaced with a default message context in accordance with MQ normal operation.

I

To view information about the queue.

File Manager displays the Websphere MQ Queue Information panel. On this panel, you can change the attributes of the queue by entering the ALTER primary command (File Manager issues an ALTER QLOCAL command).

If you change the name of a queue, File Manager issues a DEFINE QUEUE command (rather than an ALTER command). This is a simple way of duplicating the attributes of a queue under a new name.

R

To discard (reset) all current messages on the queue (File Manager issues an EMPTY QLOCAL command).

V

Provided there are messages on the selected queue, File Manager displays the WebSphere MQ Queue Editor Entry panel showing the names of the WebSphere® MQ queue and WebSphere® MQ manager already entered.

From this point, you can now start a View session (provided GET is enabled for the queue) to display the contents of the selected queue:

1. To include message header information (the message descriptor), select (with the an "/") the **Include descriptors** option.
2. To format the message (or header) contents, similar to a traditional File Manager view, specify a copybook or template in the **Copybook or Template** entry fields.

To display both the message descriptor information and the message data in a formatted sense, use the segmented data option on the template.

Sample copybooks and templates are provided in the sample library (SFMNSAM1). The member FMNPMQMD is a PL/I copybook extracted from the Websphere MQ supplied copybook which describes common message header descriptions. This sample may be extended to include your application data layout definition by adding the appropriate PL/I statements, or a %INCLUDE statement.

Likewise, the member FMNCMQMD is a COBOL copybook which describes common message header descriptions.

The member FMNTPMQD is the template version of the PL/I copybook and the member FMNTCMQD is the template version of the COBOL copybook.

Both templates include the identification criteria used to identify each message header type as shown in [Table 6: Criteria for identifying message header types on page 442](#). These can be determined by inspecting the copybook.

Table 6. Criteria for identifying message header types

Layout name	PL/I template: add this ID criteria	COBOL template: add this ID criteria
MQCIH	#2== ' CIH '	#3== ' CIH '
MQDH	#2== ' DH '	#3== ' DH '
MQDLH	#2== ' DLH '	#3== ' DLH '
MQIIH	#2== ' I IH '	#3== ' I IH '
MQMDE	#2== ' MDE '	#3== ' MDE '
MQMD1	#2== ' MD ' & #3=1	#3== ' MD ' & #4=1
MQMD2	#2== ' MD ' & #3=2	#3== ' MD ' & #4=2
MQRFH1	#2== ' RFH ' & #3=1	#3== ' RFH ' & #4=1
MQRFH2	#2== ' RFH ' & #3=2	#3== ' RFH ' & #4=2
MQRMH	#2== ' RMH '	#3== ' RMH '
MQTM	#2== ' TM '	#3== ' TM '

Layout name	PL/I template: add this ID criteria	COBOL template: add this ID criteria
MQTMC2	#2== 'TMC '	#3== 'TMC '
MQWIH	#2== 'WIH '	#3== 'WIH '
MQXQH	#2== 'XQH '	#3== 'XQH '

3. Press Enter to view the contents of the queue as shown in [Figure 109: Viewing the contents of a queue on page 443](#).

Figure 109. Viewing the contents of a queue

```

  Process  Options  Help
  -----
View      CSQ2:D3.CSQ2.ANYQ      +
Top of 12
  Col 1
Format CHAR
Record AT TOP

-----+-----10-----+-----2-----+-----3-----+-----4-----+-----5-----+-----6-----+-----7--
***** **** Top of data ****
000001 08062107301100001 THIS IS A MESSAGE TEXT
*0000051..*0000061..*0
000002 08062107322900001 THIS IS A MESSAGE TEXT
*0000051..*0000061..*0
000003 08062107342300001 THIS IS A MESSAGE TEXT
*0000051..*0000061..*0
000004 08062107342300002 THIS IS A MESSAGE TEXT
*0000051..*0000061..*0
000005 08062107342300003 THIS IS A MESSAGE TEXT
*0000051..*0000061..*0
000006 08062107342300004 THIS IS A MESSAGE TEXT
*0000051..*0000061..*0
000007 08062107342300005 THIS IS A MESSAGE TEXT
*0000051..*0000061..*0
000008 08062107342300006 THIS IS A MESSAGE TEXT
*0000051..*0000061..*0
000009 08062107342400007 THIS IS A MESSAGE TEXT
*0000051..*0000061..*0
000010 08062107342400008 THIS IS A MESSAGE TEXT
*0000051..*0000061..*0
000011 08062107342400009 THIS IS A MESSAGE TEXT
*0000051..*0000061..*0
000012 08062107342400010 THIS IS A MESSAGE TEXT
*0000051..*0000061..*0
***** **** End of data ****

Command ==>
Scroll PAGE
F1=Help      F2=Zoom      F3=Exit      F4=CRetriev  F5=RFind
F6=RChange   F7=Up        F8=Down      F9=Swap      F10=Left     F11=Right
F12=Cancel

```

To view WebSphere® MQ queues, from the Websphere MQ Functions panel select option **2 View** to display the Websphere MQ Queue Editor Entry panel.

To *edit* WebSphere® MQ queues, from the Websphere MQ Functions panel select option **3 Edit** to display the Websphere MQ Queue Editor Entry panel.



Note: Editing a queue retrieves messages in browse mode into virtual storage for the edit session. In an edit session, you can perform deletes, updates and inserts. When editing a remote queue or an alias to a remote queue, message data can only be inserted.

For messages that are updated in the edit session, at save time (including the save and exit performed as a result of pressing the F3 function key) the original message is destructively read from the queue and the updated message PUT to the queue. Messages are read in physical order. This means that updated messages appear in a different physical order than when the queue was first read by the editor. Because the messages are loaded into virtual storage, for queues with a high depth, not all of the messages may be able to be loaded into storage. If this does not provide all of the messages that you are expecting, use a template to select the particular messages that you are interested in.

Related topics

[WebSphere MQ Functions panel on page 1108](#)

[WebSphere MQ Managers panel on page 1109](#)

[WebSphere MQ Managers Information panel on page 1110](#)

[WebSphere MQ Queue Editor Entry panel on page 1112](#)

[WebSphere MQ Queue Information panel on page 1114](#)

[WebSphere MQ Queue List panel on page 1116](#)

Chapter 9. Tape Specific Functions

When you select Tape Specific Functions, the Tape Specific Functions panel shown in [Figure 328: Tape Specific Functions panel on page 1048](#) is displayed.

Tape Specific Functions allow you to:

- Obtain overall information about tape contents
- Write special tape records
- Erase tapes physically

Specifying tape input or output

When you use File Manager tape options, you can process tape data in one of two ways: basic tape or labeled tape:

Basic tape

With basic tape processing, you work with tape files and tape blocks. The first tape mark after a data record or after the leading tape mark is treated as the end of a file. Basic tape functions cannot process multivolume input tape files. No tape label processing is performed; tape label sets are processed as ordinary tape files.

You can move the tape forward or backward by a number of physical records or a number of tape files. Tape input is read from the current position of the input tape, and tape output is written to the current position of the output tape.



Note:

1. For output tapes, you can position the tape before the last tape mark of a file if you want to extend the tape file.
2. To process a labeled input tape without label processing, position the tape at the first data record; for example, by using Forward Space File (option 4.15.2) to skip the tape label file.
3. If the first record read is a tape mark, File Manager considers it a leading tape mark and continues. To copy a null file correctly, position the tape in front of the tape mark, which is then treated as a leading tape mark. To copy consecutive files (including null files) from a multivolume input tape, use Backward Space Record (option 4.15.3) before each copy command.



4. At the end of tape, File Manager writes two tape marks to indicate the end of volume, unloads the full tape, and requests the mounting of another volume on the tape output device. You can thus create an unlabeled multivolume tape file.
5. For tape functions that cross tape marks and for tape output functions, BLP or NL processing is recommended.

Labeled tape

For labeled tape processing, you specify a file ID. An input tape must be positioned in front of the specified label set. (If the file IDs do not match, the function ends with an error.) An output tape must be positioned at the beginning of a tape or immediately after a labeled file.

File Manager processes SL and AL (ANSI) labels. On input, the label format is recognized automatically. For output, use the **TAPELBL** entry field from the Set Processing Options panel to select the label type.

Labeled tape processing is specified when the tape is opened (during interactive allocation). Only the following options are enabled for output label processing:

- Create Tape Data (option 4.7)
- Sequential Data to Tape (option 4.2.7)
- VSAM to Tape (option 4.2.6)



Note: Not all combinations of File Manager keyword values are supported by the underlying operating environment. For information on supported combinations, see your operating environment documentation.

You can specify tape input or output as follows:

1. Specify a ddname for the tape unit.
2. For an output tape, optionally specify a tape mode code, as shown in [Tape density and mode values on page 449](#). By default, File Manager does not change density, and uses buffered write mode where applicable.
3. If the ddname is not allocated, you are asked for allocation information.

The first File Manager option that uses a tape opens the tape. If the DDNAME you specify is not allocated, File Manager prompts for the information required by displaying the Tape Allocation panel shown in [Figure 110: Tape Allocation panel on page 447](#). File Manager then dynamically allocates and opens the tape. The tape remains open until you rewind and unload it using Tape Rewind-Unload (option 4.15.6) or exit from FMN.

- You must specify the unit. Other panel input depends on the specified label value. When you use any tape options to process multiple files (that is, go over tape marks), or any tape output options, BLP or NL processing is recommended. (File Manager basic tape output options do not create labeled tapes).
- If you specify BLP (provided you are authorized), the VOLSER is not verified and any data set name is ignored. If input tape label processing is desired (SL or AL), both the VOLSER and data set name are required and must match. To allocate a scratch tape for output (nonspecific request), omit the VOLSER.

Figure 110. Tape Allocation panel

Process	Options	Help
File Manager	Tape Allocation	
Tape Allocation:		
DDNAME to use	. . WHICHTAP	
Volume serial(s)	
Unit	device number, generic, or group name
Label value	. . . SL_	SL, NL, AL or BLP
Data set name	
Sequence number	relative position of data set on tape
Expiration date	yyyy.ddd, leave blank if none desired
Open for write	. . NO_	NO or YES
Disposition	. . . MOD_	OLD, MOD, NEW, or CAT (for NEW,CATLG)
Command ==>		
F1=Help	F2=Split	F3=Exit
F9=Swap	F10=Actions	F12=Cancel
	F4=CRetriev	F7=Backward
		F8=Forward

When you allocate a tape, you are asked for the following information:

DDNAME to use

The ddname for the tape unit

Volume serial

The actual volser (which is verified if label processing is requested), or an external number to be used for mounting the tape if you do not know the actual volume serial (which requires BLP). For example, you might use Tape Label Display (option 4.8) to find out the actual volume serial number.

To access a volume set, specify up to five volsers in parentheses, for example: (FMO005 FMO006 FMO007).

Volume sets are supported by the Tape Label Display (option 4.8), Tape to Labeled Tape (option 4.2.3), and basic tape output functions.

To access a scratch tape (a non-specific volume request), do not enter a volser. The tape should not be write-protected, and the operator might need to confirm that the tape can be used. The tape is opened using OPEN=OUTIN, so that the tape can later be used for input if desired.

Unit

Tape unit number. You can respond with a device number, device type (generic name), or group name (symbolic name).

Label value

`SL` for standard label processing (the default), `AL` for ANSI label processing, `BLP` for bypass label processing, or `NL` for no labels.

If File Manager is running APF-authorized, BLP is set internally for some functions if the user has the appropriate authority. BLP is reset when the function ends.

Data set name

The name of the tape data set that you want to work with, if label processing is used.

Sequence number

The relative position of a data set on the tape.

Expiration date

The expiration date for the data set.

Open for write

Specify `YES` to access a tape in read/write mode. The tape should not be write-protected, and the operator might need to confirm that the tape can be used. The tape is opened using `OPEN=INOUT`, so that the tape can be used for output if desired but labels are not rewritten during open.

Disposition

Data set status. Default is MOD.

OLD

The file already exists.

MOD

If the file already exists, add records to the end of the file; otherwise create a new file.

NEW

Create a new file.

CAT

If the step terminates normally, the file is cataloged.

If the File Manager session abends, you might need to use the TSO `FREE` command to remove any File Manager allocations.



Note: You can also allocate tapes outside File Manager. For example, you might want to use allocation parameters that you cannot specify within File Manager.

If you use options that are not enabled for output label processing, the tape remains open until you rewind and unload it (using Tape Rewind-Unload) or exit File Manager. If you use an option that is enabled for output label processing (Create Tape Data, Sequential Data to Tape, VSAM to Tape), the tape is rewound and unloaded after the file is closed and the task has completed.

Tape density and mode values

Table 7: Density/mode values for tapes that are not 7-track on page 449 and Table 8: Tape conversion mode values for 7-track tapes on page 449 show the density and mode values that are available.

Table 7. Density/mode values for tapes that are not 7-track

Tape Mode (mm)	3480 / 3490 Cartridge Tapes
08	Compaction (IDRC), buffered write mode
28	Compaction (IDRC), immediate write mode
00 or BU	No compaction, buffered write mode
20 or IM	No compaction, immediate write mode
Tape Mode (mm)	3400 Tapes
C8 *	800 bpi, dual density
C0 *	1600 bpi, dual density
D0 *	6250 bpi, dual density
Tape Mode (mm)	3424 / 9348 Tapes
42 *	1600 bpi, buffered write mode
62 *	1600 bpi, immediate write mode
C2 *, 00 or BU	6250 bpi, buffered write mode
E2 *, 20 or IM	6250 bpi, immediate write mode
Tape Mode (mm)	9346 / 9347 Streamer Tapes
50 or LL	IBM 9347, low speed, long gap
60 or LS	IBM 9347, low speed, short gap
90 or HL	IBM 9347, high speed, long gap
30 or HS	IBM 9347, high speed, short gap
00 to FE	IBM 9346, forced streaming mode

Table 8. Tape conversion mode values for 7-track tapes

Tape Mode (mm)	Density (bpi)	Parity	Translation	Conversion
10 *	200	Odd	Off	On
20 *		Even	Off	Off
28 *		Even	On	Off

Table 8. Tape conversion mode values for 7-track tapes (continued)

Tape Mode (mm)	Density (bpi)	Parity	Translation	Conversion
30 *		Odd	Off	Off
38 *		Odd	On	Off
50 *	556	Odd	Off	On
60 *		Even	Off	Off
68 *		Even	On	Off
70 *		Odd	Off	Off
78 *		Odd	On	Off
90 *	800	Odd	Off	On
A0 *		Even	Off	Off
A8 *		Even	On	Off
B0 *		Odd	Off	Off
B8 *		Odd	On	Off

**Note:**

1. For mm values marked with an asterisk (*), the tape must be positioned at the load point.
2. If the mm value is omitted, the system default is used.

Tape block size considerations

File Manager can process input and output tape blocks that are larger than 64KB. The theoretical limit for a tape block is 10MB.

If you use tape blocks that are larger than 64KB (32KB for labeled tape processing), be aware that other software may not be able to process such large tape blocks. The hardware that you are using may also limit the block size.

File Manager supports LBI (Large Block Interface) for tape. Note that data sets (which require LBI) can not be allocated while using the ISPF interface. However, existing data set (or data sets) pre-allocated using JCL (in batch) may be processed for both input and output.

Specifying the number of tape files to process

Several File Manager tape options let you specify the number of tape files that you want to work with.

- You can accept the default (to process one tape file).
- You can specify a number of tape files from 1 to 99 999.

- With some tape options, you can specify `EOV` to process all files until the end-of-volume (double tape mark or EOV label).
- With Tape to Tape (option 4.2.1), you can specify `EOT` to copy until the physical end-of-tape. Continuation volumes are not requested.
- With some options, you can specify `EOD` to process all files until a specified delimiter is encountered. First, use the **EOD** entry field on the Set Processing Options (option 0) panel to set an EOD delimiter, then use a tape option with `EOD` as the number of files.

Some tapes (such as program installation tapes) may have multiple tape marks between files. To make sure that all files are processed or to process input tapes beyond the end-of-volume, specify `EOD` or a number greater than the number of files on the tape. To prevent a tape from running off the reel, File Manager stops if it encounters a data check after a tape mark. If reading records does not produce a data check, File Manager processes all records until the physical end of the tape is reached.

Processing tapes with data-check errors

You can process input tapes that have data-check errors. When a data-check error is found, File Manager lets you change, accept, or bypass the tape block containing the error. You can browse the block and be prompted for what to do next with the block.

The blocks that you change are printed, so you have a log of any changes you make.

ASCII translation

Use the **ASCII** entry field on the Set Tape Processing Options panel (option 0.3) to translate tape data between ASCII and EBCDIC format for all tape input and output options except the following:

- Initialize Tape (option 4.12)
- Tape Browse (option 4.1)
- Tape Label Display (option 4.8)
- Tape to Labeled Tape (option 4.2.3)
- Tape to Tape Compare (option 4.9)
- Tape Update (option 4.3)

For Tape Label Display, ASCII translation is automatically performed when needed. For Initialize Tape and Tape Browse, you can specify ASCII input or output on the respective panels. For the other functions, translation is not supported by FMN.

ASCII data is translated to EBCDIC format using the FMNA2E table. EBCDIC data is translated to ASCII format using the FMNE2A table. To translate data from one ASCII format to another ASCII format, customize these tables so that FMNA2E is different from FMNE2A. (For details, see the *File Manager for z/OS Customization Guide*.)

To translate tape data, set the **ASCII** entry field on the Set Processing Options panel to the appropriate value:

NO

Data not translated. This is the default.

IN

Translates ASCII tape data to EBCDIC format

OUT

Translates EBCDIC data to ASCII format for tape output

BOTH

Translates tape data from one ASCII format to another



Note: Translating labels or varying-length format tapes may produce incorrect output.

Exported Stacked Volumes (ESVs)

In this document, movement of logical volumes (and the data they contain) *out of* a Virtual Tape Server (VTS) is referred to as 'export', and movement of logical volumes *into* a VTS is referred to as 'import'. A physical volume managed by a VTS that contains logical volumes that can be removed from the VTS is referred to as an 'Exported Stacked Volume'.

Other terms used in this document in discussions about using File Manager options with Exported Stacked Volumes are:

Internal Stacked Volume. A volume internal to a VTS used to archive logical volumes when the raid array is full. This volume is not in the same format as an Exported Stacked Volume.

logical volume. A tape volume created in a VTS. A logical volume may be physically on raid array in the VTS, on an Internal Stacked Volume, or on an Exported Stacked Volume. The logical volume is equivalent to a physical tape volume in a non-VTS environment.

Requirements for Exported Stacked Volumes

All VTS export volumes are written on devices that support the locate block CCW. File Manager uses the locate block CCW to find the start of a logical volume, therefore the input device for the Exported Stacked Volume must support the locate block CCW.

ESV options

File Manager provides two options for working with Exported Stacked Volumes:

- Exported Stacked Volume Copy (option 4.2.8). See [Exported Stacked Volume Copy \(option 4.2.8\) on page 462](#).
- Exported Stacked Volume List (option 4.14). See [Exported Stacked Volume List \(option 4.14\) on page 475](#).

For further information about using these options, see [EVC \(Exported Stacked Volume Copy\) on page 1499](#) and [EVL \(Exported Stacked Volume List\) on page 1501](#).

The following provides some additional information about Exported Stacked Volume Copy and Exported Stacked Volume List.

- Only Exported Stacked Volumes created with the VTS export function are supported by Exported Stacked Volume Copy and Exported Stacked Volume List. Exported Stacked Volume Copy and Exported Stacked Volume List do not support Internal Stacked Volumes that were not created by the VTS export function. Currently an Internal Stacked Volume is not compatible with an Exported Stacked Volume.

To use a Exported Stacked Volume with Exported Stacked Volume Copy or Exported Stacked Volume List, the volume must first be removed from the tape library where it was created, and either inserted into another tape library as a normal SL volume, or mounted on a stand alone tape drive.

- For the input Exported Stacked Volume:
 - The input allocation may be SL or BLP. If SL is used, the operating system checks for a correct set of standard label headers (an input Exported Stacked Volume contains SL header records).
 - During the copy process the volume is no longer treated as an SL volume.
 - The volume is rewound at the start of Exported Stacked Volume Copy or Exported Stacked Volume List (for both SL and BLP), the standard label headers internally checked by Exported Stacked Volume Copy or Exported Stacked Volume List, and the volume verified to ensure that it was created by the VTS export function.
- For a valid input Exported Stacked Volume, the Table of Contents (located at the end of an Exported Stacked Volume) is read. The Table of Contents is used to:
 - Verify that requested logical volumes exist on the input Exported Stacked Volume.
 - Index into the input Exported Stacked Volume to locate the start of a logical volume (performance).

Using primary commands with Tape Specific Functions

For some tape functions, you can use *primary commands*.

Primary commands are commands you enter on the Command line or, where applicable, by using a function key. [Table 9: Primary commands you can use with Tape Specific Functions on page 453](#) shows which primary commands you can use with which tape function.

Table 9. Primary commands you can use with Tape Specific Functions

Command	Tape function		
	Tape Browse ¹ (4.1)	Tape Update ¹ (4.3)	Tape Record Load ¹ (4.4)
BID	✓		
BSF	✓	✓	
BSR	✓	✓	
COPY		✓	✓

1. You can also use scrolling primary commands as described in [Scrolling to see data on page 117](#)

Table 9. Primary commands you can use with Tape Specific Functions

(continued)

Command	Tape function		
	Tape Browse ¹ (4.1)	Tape Update ¹ (4.3)	Tape Record Load ¹ (4.4)
FIND	✓	✓	✓
FSF	✓	✓	
FSR	✓	✓	
LOCATE	✓	✓	✓
RD	✓	✓	✓
REW	✓	✓	
RFIND	✓	✓	✓
RP	✓	✓	✓
RUN	✓	✓	
TOF	✓	✓	
ZOOM	✓	✓	

The following sections describe each of the primary commands in [Table 9: Primary commands you can use with Tape Specific Functions on page 453](#).

BID

The BID primary command lets you work with the hardware block ID instead of the block numbers within a file. File Manager displays the block ID (including flag byte) for every data block and tape mark. To locate a block with a specific block ID, enter the desired value in the Block-Id field. Enter BID again to return to the block number display. (Working with block IDs may be helpful to move the tape over defective areas which cannot be crossed with other tape positioning commands.)

You can only use BID with Tape Browse (option 4.1).

BSF

The BSF primary command moves the tape backwards a specified number of files.

Figure 111. Syntax

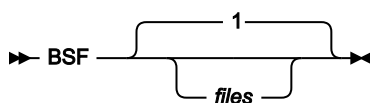

1. You can also use scrolling primary commands as described in [Scrolling to see data on page 117](#)

For example, the command `BSF 3` moves the tape backward 3 files.

You can only use BSF with Tape Browse (option 4.1) and Tape Update (option 4.3).

 **Note:** You can also use Backward Space File (option 4.15.1).

BSR

The BSR primary command moves the tape backward a specified number of records.

Figure 112. Syntax

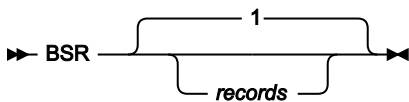

For example, the command `BSR 10` moves the tape backward 10 records.

You can only use BSR with Tape Browse (option 4.1) and Tape Update (option 4.3).

 **Note:** You can also use Backward Space Record (option 4.15.3).

COPY

The COPY primary command copies the data denoted by a specified column range within the record replacing the existing data, starting at the first byte of data displayed. COPY is only available when zoomed in on a record (see [Zooming in to see all of a record on page 112](#)). For further details, see [COPY primary command on page 1138](#).

You can only use COPY with Tape Update (option 4.3) and Tape Record Load (option 4.4).

FIND

The FIND primary command finds the next occurrence of a character string in the data you are viewing.

Figure 113. Syntax

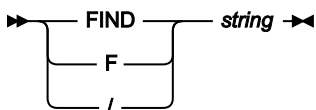

If the character string is found, it is displayed at the top position. To find the next occurrence of the same string, use the RFIND command, or enter the FIND command with no argument. A message is displayed if the string cannot be found.

The string can be:

- A character string not starting or ending with a quotation mark and not containing any embedded blanks or commas. The case of the string is ignored. Uppercase and lowercase representations of the same character match. For example, "Mixed" matches "MIXED".
- A character string enclosed in quotation marks. The string can contain blanks and commas. The case of the string is ignored. For example, "Exact string" matches "exact string".
- C followed by a character string enclosed in quotation marks (C'Frog'), or a character string enclosed in quotation marks followed by c ('Frog'C). The string can contain blanks and commas. The string must match exactly (including case). For example, "Exact string" does not match "exact string".
- X followed by a hexadecimal string enclosed in quotation marks (X'C1C2'), or a hexadecimal string enclosed in quotation marks followed by x ('C1C2'X).

FSF

The FSF primary command moves the tape forward a specified number of files.

Figure 114. Syntax

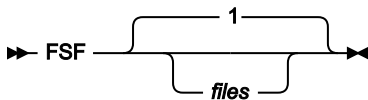

For example, the command `FSF 2` moves the tape forward 2 files.

You can only use FSF with Tape Browse (option 4.1) and Tape Update (option 4.3).



Note: You can also use Forward Space File (option 4.15.2).

FSR

The FSR primary command moves the tape forward a specified number of records.

Figure 115. Syntax

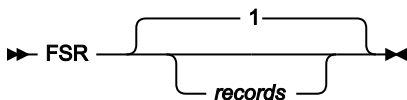

For example, the command `FSR 8` moves the tape forward 8 records.

You can only use FSR with Tape Browse (option 4.1) and Tape Update (option 4.3).



Note: You can also use Forward Space Record (option 4.15.4).

LOCATE

The LOCATE primary command positions a specified line number at the top of the display.

Figure 116. Syntax

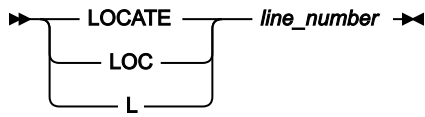

For example, the command `L 18` positions line 18 at the top of the display.

RD

The RD primary command prints the current record in dump format.

REW

The REW primary command rewinds the tape to the load point.

You can only use REW with Tape Browse (option 4.1) and Tape Update (option 4.3).



Note: You can also use Tape Rewind (option 4.15.5).

RFIND

The RFIND primary command repeats the FIND primary command with the previous search string.

RP

The RP primary command prints the current record in character format.

RUN

The RUN primary command rewinds the tape and unloads it.

You can only use RUN with Tape Browse (option 4.1) and Tape Update (option 4.3).



Note: You can also use Tape Rewind-Unload (option 4.15.6).

TOF

The TOF primary command moves the tape to the beginning of the current file.

You can only use TOF with Tape Browse (option 4.1) and Tape Update (option 4.3).

ZOOM

In CHAR, LHEX, HEX, or TABL display formats, if you want to display all data in a particular record without having to scroll left or right, you can “zoom in” by moving the cursor to the record, then pressing the Zoom function key (F2). To zoom out, press the Zoom function key (F2) again.

You can only use ZOOM with Tape Browse (option 4.1) and Tape Update (option 4.3).

For further details, see [Zooming in to see all of a record on page 112](#).

Tape Browse (option 4.1)

Use Tape Browse to browse physical records on a tape. You can display a screen full of records, scroll backward and forward over tape data, search for specific data, and press F2 (Zoom) for a closer look on a single record.

You can specify a range of files to view, and whether to translate ASCII data to EBCDIC for display.

When you select Tape Browse, the Tape Browse panel shown in [Figure 117: Tape Browse panel on page 458](#) is displayed.

Figure 117. Tape Browse panel

```

Process  Options  Help
-----
File Manager                    Tape Browse
Tapes:  No tapes allocated

Input:
  DDNAME to use  . _ _ _ _ _ _ _ _   enter new name, or select one from above
  Files . . . .  . 1 _ _ _ _ _      number of files or EOF
  Initial BSF . . YES _ _ _ _ _     NO to start from current tape position
  ASCII data . . NO _ _ _ _ _ _     YES to translate ASCII data for display

Command ==>>  _ _ _ _ _ _ _ _ _ _ _ _ _ _ _ _ _ _ _ _ _ _ _ _ _ _ _ _ _ _ _ _ _ _
F1=Help      F2=Split    F3=Exit     F4=CRetrieV  F7=Backward  F8=Forward
F9=Swap      F10=ActiOns F12=Cancel

```

Tape Data Copy Function (option 4.2)

When you select Tape Data Copy Function, the Tape Data Copy Function menu shown in [Figure 118: Tape Data Copy Function panel on page 459](#) is displayed. This panel allows you to duplicate a tape, copy tape data to another storage device, change the record organization, record format, and block size, recover data from a defective tape, and translate between ASCII and EBCDIC formats.

Figure 118. Tape Data Copy Function panel

<u>P</u> rocess	<u>O</u> ptions	<u>H</u> elp
File Manager		Tape Data Copy Functions
1	Tape to tape	Copy tape volume to tape volume
2	Tape reformat	Copy and reformat single tape file
3	Multifile	Copy multivolume and multiple tape files
4	To VSAM	Copy from tape to VSAM data set
5	To QSAM	Copy from tape to QSAM data set
6	From VSAM	Copy from VSAM data set to tape
7	From QSAM	Copy from QSAM data set to tape
8	ESV	Copy Exported Stacked Volume
Command ==>		
F1=Help	F2=Split	F3=Exit
F9=Swap	F10=Actions	F12=Cancel
	F4=CRetriev	F7=Backward
		F8=Forward

Tape to Tape (option 4.2.1)

Tape to Tape copies one or more files from tape to tape without label processing. Tape labels are treated as data. If multiple output volumes are required, the label information may be incorrect.

Also see [Specifying the number of tape files to process on page 450](#).

For further information, refer to the online help or [TT \(Tape to Tape\) on page 1596](#).

Tape to Tape Reblocked (option 4.2.2)

Tape to Tape Reblocked copies one file from tape to tape. You can change the record format and reblock the tape file. Tape labels are treated as data.

For further information, refer to the online help or [TTR \(Tape to Tape Reblocked\) on page 1599](#).

Tape to Labeled Tape (option 4.2.3)

Tape to Labeled Tape copies IBM-standard labeled tapes (without requiring you to specify every file ID). Labels read from the input tape are interpreted and copied to the output tape. Copying multivolume and multifile tapes is supported. However, multivolume output tapes are not supported: if the output volume is too short, copying continues on the next tape, but no end-of-volume (EOV) label is written on the full output volume, and no IBM-standard VOL1, HDR1, and HDR2 labels are written on the continuation volume.

Figure 119. Tape to Labeled Tape panel

```

Process  Options  Help
-----
File Manager                Tape to Labeled Tape

Tapes:  No tapes allocated

Input:
DDNAME to use ._____  enter new name, or select one from above
Type of tape  . SL___    SL or MIXED (mixture of SL and NL files)

Output:
DDNAME to use ._____  enter new name, or select one from above
Tape mode . . . ___    optional recording mode or density code
Files . . . . ALL__    number of files to be copied or ALL
New Volser(s) ._____  or * or blank

Command ==> _____
F1=Help      F2=Split      F3=Exit      F4=CRetrieV  F7=Backward  F8=Forward
F9=Swap      F10=Actions   F12=Cancel

```

You can copy all of the files on the tape (by default) or specify the number of files that you want to copy (see [Specifying the number of tape files to process on page 450](#)). You can start copying at a specific file by positioning the tape at the header label (HDR1) of the desired file. You can also append files on the output volume by positioning the output tape after the last file (EOF2 TM) of the output volume.

You can copy a tape that contains both labeled and unlabeled files by specifying the type as `MIXED`. Non-labeled files are tolerated and copied as non-labeled files.

**Note:**

1. Any user labels on the input tape are not copied.
2. File Manager may force bypass label processing (BLP) when switching to the next volume. If BLP is forced, for security reasons the tape is freed (unallocated) when the Tape to Labeled Tape ends.
3. Do not copy HSM backup tapes using Tape to Labeled Tape because File Manager cannot update the HSM internal information regarding the location of the backup data sets.
4. No recataloging or RACF® processing of the data sets takes place because of data set naming conventions on tape.
5. In some error conditions (for example, if unexpired output volumes are used), prompts are sent to the operator console.

For further information, refer to the online help or [TLT \(Tape to Labeled Tape\) on page 1573](#).

Tape to VSAM (option 4.2.4)

Tape to VSAM (option 4.2.4) copies all or selected tape records to a VSAM data set. Use VSAM to Tape (option 4.2.6) to restore the file to tape.

You can specify the number of records to skip from the beginning of the file and the number of records to copy (see [Specifying the number of tape files to process on page 450](#)).

You can also use Tape to VSAM to convert a multiple-file tape into a single VSAM ESDS (tape image file), which can be distributed across a network. Specify a number of files other than one, but no tape file ID or start position. See [Copying tape data across a network on page 463](#).

For further information, refer to the online help or [TV \(Tape to VSAM\) on page 1602](#).

Tape to Sequential Data (option 4.2.5)

Tape to Sequential Data copies all or selected tape records to a sequential data set on disk, tape, or SYSOUT. You can specify the number of records to skip from the beginning of the file and the number of records to copy (see [Specifying the number of tape files to process on page 450](#)).

You can also use Tape to Sequential Data to convert a multiple-file tape into a single sequential data set (tape image file) which can be distributed across a network. Specify a number of files other than one, but no tape file ID or start position. See [Copying tape data across a network on page 463](#).

Use Sequential Data to Tape (option 4.2.7) to restore the file to tape.

For further information, refer to the online help or [TS \(Tape to Sequential Data\) on page 1592](#).

VSAM to Tape (option 4.2.6)

VSAM to Tape copies all or selected records from a VSAM data set to tape. Bypass label processing (BLP) is recommended for this option.

You can specify the number of records to skip from the beginning of the input data set, or the key or slot value to start processing. You can also specify the output record format and block size.

If you used Tape to VSAM to copy a multfile tape to a single VSAM ESDS (tape image file), you can use VSAM to Tape to copy the file back to tape. The resulting tape is an exact copy of the original tape. See [Copying tape data across a network on page 463](#).

For further information, refer to the online help or [VT \(VSAM to Tape\) on page 1616](#).

Sequential Data to Tape (option 4.2.7)

Sequential Data to Tape copies all or selected records from a sequential data set to tape. Bypass label processing (BLP) is recommended for this option.

You can specify the number of records to skip from the beginning of the input data set. You can also specify the output record format and block size.

If you used Tape to Sequential Data to copy a multifile tape to a sequential data set, you can use Sequential Data to Tape to copy the file back to tape. The resulting tape is an exact copy of the original tape. See [Copying tape data across a network on page 463](#).

For further information, refer to the online help or [ST \(Sequential Data to Tape\) on page 1568](#).

Exported Stacked Volume Copy (option 4.2.8)

When you use Exported Stacked Volume Copy (option 4.2.8), File Manager displays the Exported Stacked Volume Copy panel as shown in [Figure 120: Exported Stacked Volume Copy panel on page 462](#).

Figure 120. Exported Stacked Volume Copy panel

Process	Options	Help
File Manager	Exported Stacked Volume Copy	
Tapes: No tapes allocated		
Input:		
DDNAME to use ._____	enter new name, or select one from above	
Logical vol(s)_____	enter logical volume(s) to be copied	
Output:		
DDNAME to use ._____	enter new name, or select one from above	
Tape mode . . .__	optional recording mode or density code	
Command ==> _____		
F1=Help	F2=Split	F3=Exit
F9=Swap	F10=Actions	F12=Cancel
	F4=CRetriev	F7=Backward
		F8=Forward

The following points relate to Exported Stacked Volume Copy:

- Copying from an Exported Stacked Volume to disk is not currently supported.
- Copying part of a logical volume or certain files from a logical volume contained on an Exported Stacked Volume is not currently supported. The complete logical volume must be copied.
- For the output volumes:
 - The allocation may be SL, NL, or BLP. If SL is used, the operating system checks for a correct set of standard label headers.
 - During the copy process the volume is no longer treated as an SL volume.
 - The volume is rewound at the start of Exported Stacked Volume Copy (for SL, NL, and BLP).
 - If the volume contains a VOL1 header, the VOLSER in the VOL1 is saved and used to change the VOL1, HDR1, and EOF1, of records from the logical input volume prior to writing to the output volume. This results in a change of VOLSER for the logical volume being copied.

To keep the VOLSER on the physical output volume the same as the VOLSER on the logical input volume, initialize the physical output volume with the same VOLSER as the logical volume prior to starting Exported Stacked Volume Copy.

- If the output volume contains no VOL1 record initially, then the VOLSER of the logical input volume is retained, but no update of tape management systems occurs.
- Exported Stacked Volume Copy extracts a block of data from an Exported Stacked Volume and writes the physical block of data to the output volume. A block of data may be user data or HDR, or EOF records. There is no open or close performed for each file on the logical volume. Hence there is no interface to tape management systems, and the catalog information for individual data sets on the volume is not updated.
- After the Table of Contents has been read, the Exported Stacked Volume is then rewound before the copy process starts.
- Requested logical volumes are copied to the physical volumes. The copies are in the same order as the requested list of volumes.
- Up to five serial numbers of logical volumes contained on an input Exported Stacked Volume can be processed within a single File Manager command.

Each logical volume requested is copied to a separate single physical output volume. Therefore, a request for four logical volumes to be copied requires four physical output volumes. There must be a one-to-one correspondence of logical input volumes to physical output volumes.

Currently this utility does not output a single logical input volume to more than a single volume. Therefore, if the output volume is too short to hold the logical input volume, the copy stops.

For further information, refer to the online help or [EVC \(Exported Stacked Volume Copy\) on page 1499](#).

Copying tape data across a network

To send the contents of a tape across a network:

1. Use Tape to VSAM (option 4.2.4) or Tape to Sequential Data (option 4.2.5) to copy all the files on the tape, including tape marks, to a VSAM entry-sequenced data set or a sequential data set. See [Specifying the number of tape files to process on page 450](#).

Each tape mark is converted to an 80-character record that has the format:

```
FILEMTMFILEMTMFILEMTMFILEMTMFILEMTMFILEMTMFILEMTMFILEMTMFILEMTMFI  
L  
EMTMFILEMTMFI
```

2. Transfer the file or data set across the network, using a file transfer program, such as the IBM® File Transfer Program.
3. At the other end, use the VSAM to Tape (option 4.2.6) or Sequential Data to Tape (option 4.2.7) to copy the data set to a tape. File Manager converts the tape-mark records back to tape marks on the output tape.

Tape Update (option 4.3)

Use Tape Update to make interactive changes to tape blocks in a tape file, while copying it to another tape. (The data on the input tape remains unchanged.) At any time, both tapes are positioned at the same block within the file. When you end Tape Update, the remaining data (up to the limit of files specified) is copied.

To update a tape block, perform the following steps:

1. Select the Tape Update (option 4.3). The Tape Update panel shown in [Figure 121: Tape Update panel on page 464](#) is displayed.

Figure 121. Tape Update panel

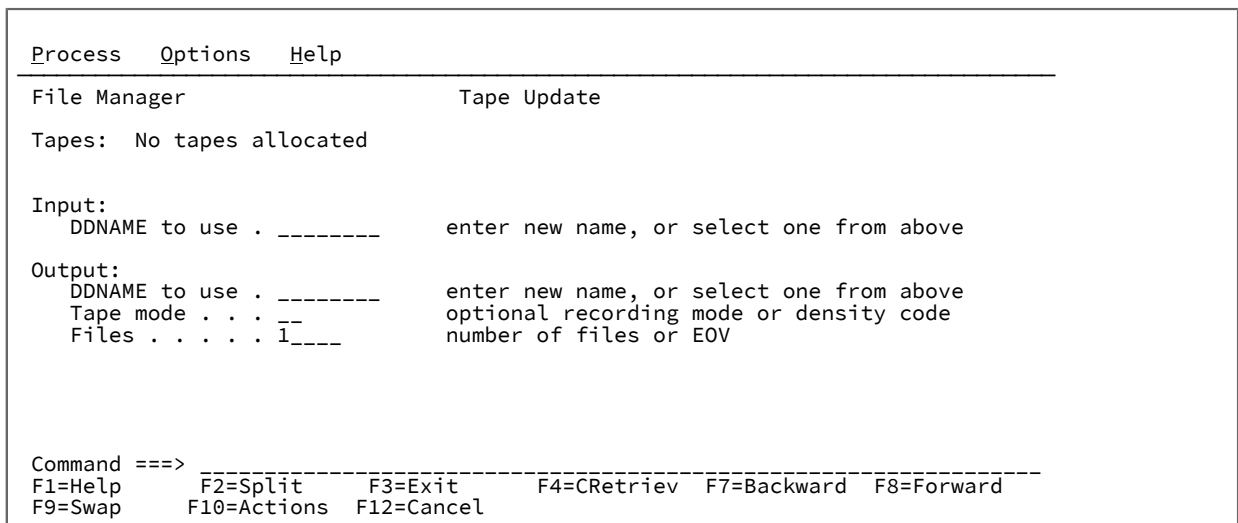

2. Select the first block that you want to update. Either move the cursor to the block, or use any of the positioning options that are available in Tape Positioning Functions (option 4.15).
3. Press the Zoom function key (F2). This gives you a detailed view of the selected record.
4. Update the block in any of these ways:
 - Overtyping the length field with a new record length.
 - Overtyping the existing text with new text.
 - Entering a column number in the **Col** field, and using the GET or COPY command to overwrite data in the block, starting at the specified column.

For the GET command, the data that you previously copied to the buffer with the PUT command is written. For the COPY command, you specify the columns of the current block that you want to copy.

For example, if the value in the **Col** field is 5 and you enter `COPY 10-12`, the data in columns 10 to 12 replaces the data that was previously in columns 5 to 7. If you enter `COPY 10`, the character in column 10 replaces the character that was previously in column 5.

5. Use the Exit function key (F3) to save your changes or press the Cancel function key (F12) to discard the changes. A log of your changes is printed. You can select another block to update or leave the function.

Special considerations

There are several differences between Tape Update and the other update functions:

- Tape Update *copies* tape blocks from one device to another device, with the changes that you specify. If you make a mistake, you still have the original data on the input tape as a backup.
- You can copy and update several consecutive tape files by specifying the number of files that you want to update. To update all the files until a double tape mark or an EOV label is reached, specify `EOV` in the **Files** entry field.
- When you use Tape Update, both the input tape and the output tape are backspaced to the nearest tape mark (if they are not already positioned immediately after a tape mark).
- Blocks are copied dynamically, as you move through the files. For example:

1. You select Tape Update and specify an input tape and an output tape. You accept the default (to update only one tape file).

One screen of data is displayed while copying to the output tape.

2. You move forward 50 blocks.

The first 50 blocks are written to the output tape.

3. You move backward 10 blocks.

Both tapes move back 10 blocks.

4. You change the current block (block 41).

The changed block is written to the output tape.

5. You end Tape Update.

All blocks from block 42 to the end of the file are written to the output tape.

- Because blocks are copied dynamically, *always* make your updates in ascending order, starting at the beginning of the file. Simply scrolling backwards does not cause any updates to be lost. However, if you *update* a block (with a lower block number than previously changed blocks), all previous changes to blocks with a higher number are lost. Also, if you rewind the tapes, *all* updates are lost.

For example, if you change block 50, then change block 40, then end Tape Update, this is what happens:

1. Blocks 1 to 50 are copied.
 2. The changed block 50 is written.
 3. The changed block 40 is written.
 4. Blocks 41 to the end of the file are copied. The change that you made to block 50 is lost.
- Throughout the update process, the two tapes should remain in synchronization. If an input/output error causes the tapes to get out of synchronization, use Tape Rewind (option 4.15.5) to rewind the tapes and restore synchronization. (Note, however, that rewinding the tapes causes all previous updates to be lost.)

Tape Update does not support ASCII conversion.

Tape Record Load (option 4.4)

When you select Tape Record Load, the Tape Record Load panel shown in [Figure 122: Tape Record Load panel on page 466](#) is displayed. This panel allows you to copy a specified number of tape records to another tape and change selected blocks.

Figure 122. Tape Record Load panel

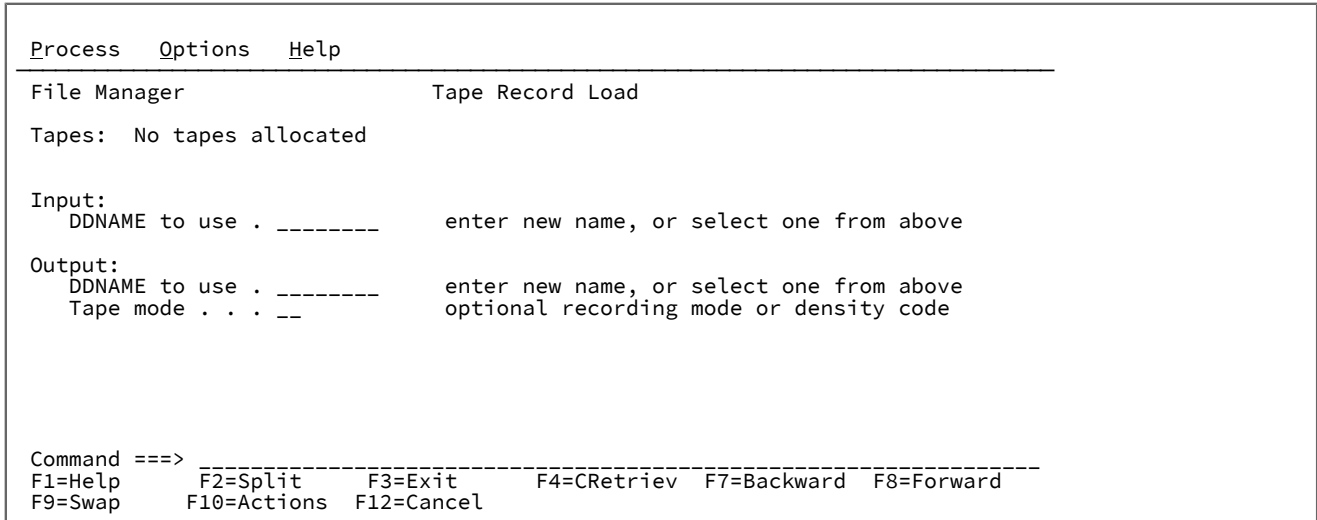

Like Tape Update (option 4.3), Tape Record Load copies from one tape file to another tape file with the change that you specify. If you make a mistake, you still have the original data on the input tape as a backup.

Unlike Tape Update, Tape Record Load lets you start and stop copying at any location within a file. You can therefore make a copy of a file with certain records removed. By using Tape Record Load repeatedly, you can combine data from two or more input files, or rearrange the data from a single input file.

For further information, refer to the online help.

Tape Print (option 4.5)

Use Tape Print (option 4.5) to print tape records in character or hexadecimal format. You can specify the record format, the record length, the number of files that you want to print, and the maximum number of records to print per file.

You can control the format of the printed output using the **DUMP** entry field of Set Print Processing Options panel (see [Set Print Processing Options panel \(option 0.1\) on page 1025](#)).

When you select Tape Print, the Tape Print panel is displayed.

Figure 123. Tape Print panel

<u>P</u> rocess	<u>O</u> ptions	<u>H</u> elp
File Manager		Tape Print
Tapes: No tapes allocated		
Input:		
DDNAME to use . _____		enter new name, or select one from above
Print Options:		
Print format . CHAR_		CHAR or HEX
Record format . U__		F,FB, V,VB,VS,VBS, D,DB,DS,DBS, or U
Record length . _____		if deblocking desired, fixed format only
Records ALL_____		limit number of records to be printed
Files 1_____		number of tape files, EOV, or EOD
Command ==>		
F1=Help	F2=Split	F3=Exit
F9=Swap	F10=Actions	F12=Cancel
	F4=CRetrieV	F7=Backward
		F8=Forward

Printing starts with the block following the current position and with the first block of each subsequent file. A leading tape mark is printed, if it exists. If you do not specify the number of blocks or files to be printed, one file is printed (up to the next tape mark).

For further information, refer to the online help or [TP \(Tape Print\) on page 1577](#).

Controlling print output

Several options on the Set Processing Options (option 0) panel affect the printed output:

DATAHDR

Whether the output contains a data header for each record

DUMP

Which format (updown or across) is used for hexadecimal print output

HEADERPG

Whether the output contains a header page at the beginning

PAGESIZE

How many lines per page the output has

PAGESKIP

Whether output from each function starts on a new page

PRINTDSN

The print data set where print output is directed when the PRINTOUT print option is set to SYSOUT=c

PRINTLEN

How many columns wide the output is

PRINTOUT

Where the output is sent

PRTRTRANS

Whether non-printable characters are translated to blanks

RECLIMIT

Which part of each record to print

For more information, see [Set Print Processing Options panel \(option 0.1\) on page 1025](#).

Tape Map (option 4.6)

Use Tape Map (option 4.6) to print a summary (map) of the data contained on a tape. You can produce a map of the entire tape, or of a specific number of tape files.

When you select Tape Map, the Tape Map panel shown in [Figure 124: Tape Map panel on page 468](#) is displayed.

Figure 124. Tape Map panel

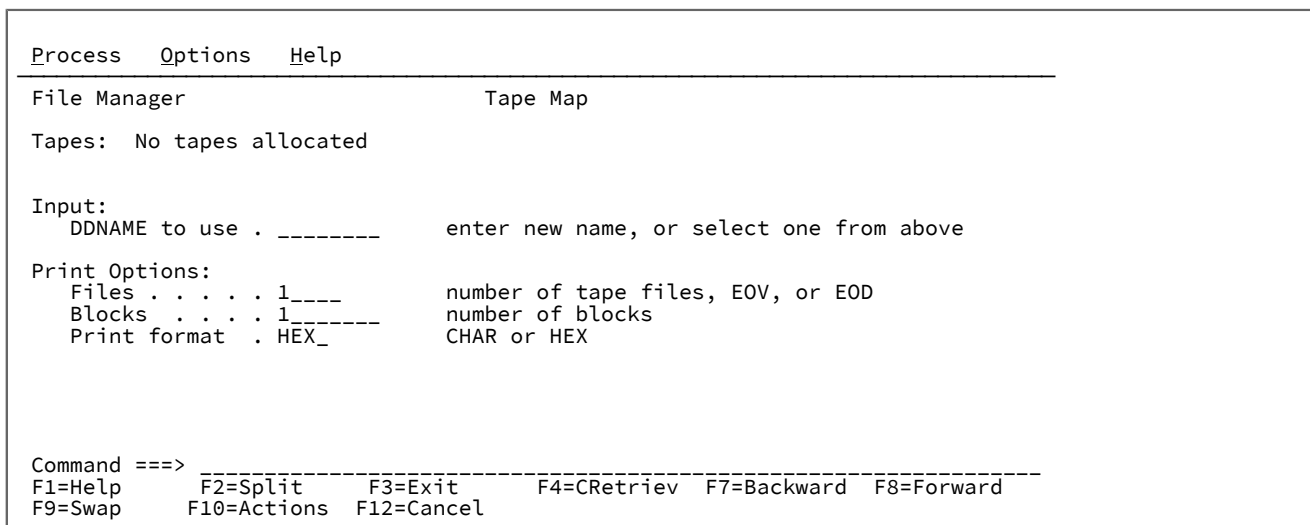

Tape Map prints from each file the number of blocks specified (in hexadecimal format or character format), followed by a summary of the space that the files take up on the tape. The output is affected by several options within Set Processing Options (option 0). These are described in [Controlling print output on page 467](#).

Figure 125: A tape map: output from Tape Map (option 4.6) on page 469 shows sample output from Tape Map.

When you select Tape Label Display (option 4.8), the Tape Label Display panel shown in [Figure 127: Tape Label Display panel on page 470](#) is displayed.

Figure 127. Tape Label Display panel

```

Process  Options  Help
-----
File Manager                Tape Label Display

Tapes:  No tapes allocated

Input:
DDNAME to use . _____ enter new name, or select one from above
Label printout LONG_       specify SHORT to only print VOL1 and
                             first HDR label set

Command ==>> _____
F1=Help   F2=Split   F3=Exit   F4=CRetrie v F7=Backward F8=Forward
F9=Swap   F10=Actions F12=Cancel
    
```

You can use Tape Label Display even if you do not have access to the data on the tape, because only the tape labels are read. To mount and process tapes with unknown volsers and labels, the Tape Label Display turns on BLP internally. If your installation does not allow BLP usage but File Manager is running APF-authorized, File Manager forces BLP for this function; for security reasons, the tape is freed (unallocated) when Tape Label Display ends.

[Figure 128: A tape label summary: output from Tape Label Display on page 470](#) shows an example of the default output from Tape Label Display. You can also request a shorter report that lists only the VOL1 label and the header labels for the first data set.

Figure 128. A tape label summary: output from Tape Label Display

```

:
IBM File Manager for z/OS                               6/09/2000 (2000.161) 12:59
Page 1
$$FILEM TLB INPUT=TAPEIN
* * * * Device 0580, TAPEIN, VOLSER=0GB220, 9 Track, 1600-BPI, Ring=in
* * * *
VOL1 label = VOL10GB220 GA2972A
-----
Data set 0001 1...5...10...15...20...25...30...35...40...45...50...55...60...65...70...75...80
HDR1 label = HDR1FMNUSER.TEST.FILE 0GB22000010001 0001470000000000000000IBM OS/V5 370
HDR2 label = HDR2V327600008440FMNUSER /ISPFPROC B 800000
* Tape mark
* Tape mark
1 data block(s) skipped
* Tape mark
EOF1 label = EOF1FMNUSER.TEST.FILE 0GB22000010001 0001470000000000000000IBM OS/V5 370
EOF2 label = EOF2V327600008440FMNUSER /ISPFPROC B 800000
* Tape mark
-----
* Tape mark
-----
End of volume (double tape mark) reached, label summary follows
Label summary for volume 0GB220:
Data Set Name Blocks BLKSIZE LRECL RECFM Created Expires Security
1 FMNUSER.TEST.FILE 1 32760 84 VB 2000147 NO
:
    
```

For further information, refer to the online help or [TLB \(Tape Label Display\) on page 1571](#).

Tape to Tape Compare (option 4.9)

Use Tape to Tape Compare to compare, byte by byte, the data on one tape with the data on another. Tape to Tape Compare is particularly useful if you have made a copy of a tape, and want to check that the duplicate is exactly the same as the original.

When you select Tape to Tape Compare, the Tape to Tape Compare panel shown in [Figure 129: Tape to Tape Compare panel on page 471](#) is displayed.

Figure 129. Tape to Tape Compare panel

```

Process  Options  Help
-----
File Manager          Tape to Tape Compare
Tapes:  No tapes allocated

Input:
  DDNAME to use . _____  enter new name, or select one from above
  DDNAME to use . _____  enter new name, or select one from above
  Files . . . . . 1_____  number of tape files, EOV, or EOD

Command ==>
F1=Help      F2=Split      F3=Exit      F4=CRetriev  F7=Backward  F8=Forward
F9=Swap      F10=Actions   F12=Cancel

```

You can compare an entire tape, or a specific number of files. Tape to Tape Compare stops processing as soon as it finds the first difference. Be sure to position the tapes as needed before starting the comparison.

To compare all the files on the tapes, enter `EOV` in the **Files** entry field. If you do not specify a value for **Files**, only one file (from the current block to the next tape mark) is compared.

When a difference is found, File Manager lists:

- The two records that do not match
- The lengths of these records on the two tapes
- The location of the first different byte
- The number of blocks and bytes compared

If no difference is found, File Manager lists the number of blocks and bytes compared.



Note: An input/output error is considered a difference, even if the same error occurs on both tapes.

For further information, refer to the online help or [TTC \(Tape to Tape Compare\) on page 1598](#).

Tape Record Scan (option 4.10)

Use Tape Record Scan to find specific data on a tape.

When you select Tape Record Scan, the Tape Record Scan panel shown in [Figure 130: Tape Record Scan panel on page 472](#) is displayed.

Figure 130. Tape Record Scan panel

Process	Options	Help
File Manager	Tape Record Scan	
Tapes: No tapes allocated		
Input:		
DDNAME to use . _____	enter new name, or select one from above	
Record format : U__	F,FB, V,VB,VS,VBS, D,DB,DS,DBS, or U	
Record length . _____	if deblocking desired, fixed format only	
Scan Options:		
Pattern scan . NO_	YES or NO	
Scan position . 1____	byte position within record to start at	
Scan argument . _____		
Number of hits 1_____	or ALL to list all scan hits in the file	
Records ALL_____	limit number of records to be scanned	
Command ==>		
F1=Help	F2=Split	F3=Exit
F9=Swap	F10=Actions	F12=Cancel
	F4=CRetrieval	F7=Backward
		F8=Forward

When using Tape Record Scan:

- You identify the tape device (**DDNAME to use**)
- You can specify a record format (**Record format**) and, if the records are fixed-length, the record length (**Record length**), to deblock the tape records while searching.
- You can specify where in each record you want to search (**Scan position**). The default is to search for strings that start in column 1.
 - To search for strings that start in column *n*, enter **NO** in the **Pattern scan** entry field and enter *n* in the **Scan position** entry field.
 - To search for strings anywhere in the record, enter **YES** in the **Pattern scan** entry field.
 - To search for strings anywhere from column *n* to the end of the record, enter **YES** in the **Pattern scan** entry field and enter *n* in the **Scan position** entry field.
- The string to search for has the same format as used by the FIND command in all functions, as well as for Disk Record Scan.
 - A character string not starting or ending with a quotation mark and not containing any embedded blanks or commas. The case of the string is ignored. Uppercase and lowercase representations of the same character match. For example, 'Mixed' matches 'MIXED'.
 - A character string enclosed in quotation marks. The string can contain blanks and commas. The case of the string is ignored. For example, 'Exact string' matches 'exact string'
 - c followed by a character string enclosed in quotation marks (C'Frog'), or a character string enclosed in quotation marks followed by c ('Frog'C). The string can contain blanks and commas. The string must match exactly (including case). For example, 'Exact string' does not match 'exact string'
 - x followed by a hexadecimal string enclosed in quotation marks. For example, x'C1C2'.

- You can specify the number of occurrences of the string that should be found before the search stops. The default is to stop after the first occurrence.
- You can specify the number of records to search through. The default is to scan to the end of the file.

Tape Record Scan stops after finding the specified number of occurrences of the string. The tape is positioned immediately after the record containing the last occurrence. If the string is not found, the tape stops after the next tape mark.

For further information, refer to the online help or [TRS \(Tape Record Scan\) on page 1589](#).

Write Tape Mark (option 4.11)

When you select Write Tape Mark, the Write Tape Mark panel shown in [Figure 131: Write Tape Mark panel on page 473](#) is displayed.

Figure 131. Write Tape Mark panel

```

Process  Options  Help
-----
File Manager                Write Tape Mark

Tapes:  No tapes allocated

Output:
  DDNAME to use  .-----   enter new name, or select one from above
  Tape mode     . . .--    optional recording mode or density code
  Tape marks    . . 1___   number of tape marks to be written

Command ==> -----
F1=Help      F2=Split   F3=Exit     F4=CRetriev F7=Backward F8=Forward
F9=Swap      F10=Action F12=Cancel

```

Write Tape Mark allows you to write one or more tape marks at the current position.

For further information, refer to the online help or [WTM \(Write Tape Mark\) on page 1621](#).

Initialize Tape (option 4.12)

Use Initialize Tape (option 4.12) to initialize a labeled or unlabeled tape. The tape is rewound, and the appropriate header information is written.

When you select Initialize Tape, the Initialize Tape panel shown in [Figure 132: Initialize Tape panel on page 474](#) is displayed.

Figure 132. Initialize Tape panel

```

Process  Options  Help
-----
File Manager          Initialize Tape

Tapes:  No tapes allocated

Output:
DDNAME to use .-----   enter new name, or select one from above
Tape mode . . .--       optional recording mode or density code
Volume serial .-----   volume identifier or blank for NL tape
Data set name .-----
ASCII format . NO_       YES or NO
Scale percent . 0_       optional scale percentage or 0 for all

Command ==>
F1=Help   F2=Split   F3=Exit   F4=CRetriev  F7=Backward  F8=Forward
F9=Swap   F10=Actions  F12=Cancel

```

To initialize with labels, File Manager writes a volume label set in either IBM® standard format or ANSI type 3 or 4 (ASCII) format. For NL initialization, File Manager writes a single tape mark.

Specify a DDNAME for the tape. If the DDNAME is not allocated, you are asked for allocation information. To check existing labels on the output tape before creating the new label set, specify the appropriate label value on the tape allocation panel. Specifying BLP initializes the tape unconditionally.

When Initialize Tape has finished, the tape remains positioned after the label set.

It is recommended that you unload the tape and reallocate it with the new volume serial number, to make your system aware of the new volume serial number.

You can initialize a tape with ANSI type 3 or 4 labels to be used with ASCII files. You can also specify a file identifier to be used for the file header label. Omit the volser to initialize an NL tape.

You can add a scaling capacity to the tape provided the function is supported by the hardware. The scaling capacity limits the amount of the tape actually used.

For further information, refer to the online help or [INT \(Initialize Tape\) on page 1521](#).

Erase Tape (option 4.13)

When you select Erase Tape, the Erase Tape panel shown in [Figure 133: Erase Tape panel on page 475](#) is displayed. This panel allows you to erase a tape from the current position until end-of-tape (EOT).

Figure 133. Erase Tape panel

```

Process  Options  Help
-----
File Manager                Erase Tape

Tapes:  No tapes allocated

Output:
  DDNAME to use ._____  enter new name, or select one from above
  Tape mode . . .__      optional recording mode or density code

Command ==> _____
F1=Help   F2=Split   F3=Exit   F4=CRetriev F7=Backward F8=Forward
F9=Swap   F10=Actions F12=Cancel

```

Erase Tape:

1. Writes two tape marks at the current tape position
2. Erases the remaining tape data to the end of the tape (data security erase)
3. Rewinds the tape

Erase Tape can be used only with tape units that support the data security erase I/O command code, such as the IBM® 3400 series.

For more information, refer to the online help or [ERT \(Erase Tape\) on page 1498](#).

Exported Stacked Volume List (option 4.14)

When you select Exported Stacked Volume List, the Exported Stacked Volume List panel shown in [Figure 134: Exported Stacked Volume List panel on page 475](#) is displayed.

Figure 134. Exported Stacked Volume List panel

```

Process  Options  Help
-----
File Manager                Exported Stacked Volume List

Tapes:  No tapes allocated

Input:
  DDNAME to use ._____  enter new name, or select one from above
  Type of listing SHORT    enter LONG to list logical volume details
  Logical vols(s)_____  For LONG, enter logical volume(s)
                           to be listed
                           or
  Logical start . 0___     enter logical start volume
  Logical end . . 0___     enter logical end volume

Command ==> _____
F1=Help   F2=Split   F3=Exit   F4=CRetriev F7=Backward F8=Forward
F9=Swap   F10=Actions F12=Cancel

```

Exported Stacked Volume List prints the table of contents (TOC) from an Exported Stacked Volume.

File Manager first verifies that the volume loaded was created by the VTS export function. It then forward-spaces the volume to the table of contents and prints a listing of the table of contents. The sequence printed is the same as the sequence of the logical volumes on the Exported Stacked Volume.

You can obtain a more detailed list of the table of contents by entering `LONG` in the **Type of listing** entry field. The LONG listing type shows standard label header and trailer information, and the location of tape marks.

For further information, refer to the online help or [EVL \(Exported Stacked Volume List\) on page 1501](#).

Tape Positioning Functions (option 4.15)

When you select Tape Positioning Functions, the Tape Positioning Functions menu shown in [Figure 135: Tape Positioning Functions menu on page 476](#) is displayed.

Figure 135. Tape Positioning Functions menu

```

Process  Options  Help
-----
File Manager          Tape Positioning Functions
1  BSF          Backspace file
2  FSF          Forward space file
3  BSR          Backspace record
4  FSR          Forward space record
5  REW          Rewind
6  RUN          Rewind and unload

Command ==>>
F1=Help      F2=Split      F3=Exit      F4=CRetriev  F7=Backward  F8=Forward
F9=Swap      F10=Actions   F12=Cancel
    
```

The Tape Positioning Functions menu allows you to select one of the options shown below. For further information, refer to the online help or the File Manager option indicated.

- Backward Space File (see [BSF \(Backward Space File\) on page 1248](#))
- Forward Space File (see [FSF \(Forward Space File\) on page 1519](#))
- Backward Space Record (see [BSR \(Backward Space Record\) on page 1249](#))
- Forward Space Record (see [FSR \(Forward Space Record\) on page 1520](#))
- Tape Rewind (see [REW \(Tape Rewind\) on page 1545](#))
- Tape Rewind-Unload (see [RUN \(Tape Rewind-Unload\) on page 1546](#))



Note: To correctly position a tape, you should know the format of the tape. Refer to *z/OS DFSMS: Using Magnetic Tapes*.

Chapter 10. Disk/VSAM Data Functions

Use the options on this menu to work directly with data, rather than working with records or templates. Because you are directly working on the data, use these options with care.

Processing disk records

You can process physical disk extents *within a data set*.

Each disk function works with a single volume. If a data set is split across two or more volumes, disk functions apply to the volser that you specify or (if the data set is cataloged) the first volume listed for the data set in the catalog.

Specifying disk input and output

All disk functions normally work with a disk data set.

To work with a disk data set, specify the data set name. If the data set is not cataloged, specify the volser of the disk.

Specifying disk extents

In most disk functions, you can specify a disk address or a disk address range. You can specify these addresses in the form *cylhd*, where the last 2 digits represent the head value and the other digits represent the cylinder.

If the **CYLHD** entry field of the Set Processing Options panel has the value ABSOLUTE, each *cylhd* value represents an absolute address (counting from the beginning of the physical disk). If the entry field has the value RELATIVE, each *cylhd* value represents an address relative to the beginning of the data set. (See [Set System Processing Options panel \(option 0.2\) on page 1031](#) for more information.)

The entry panels for the Disk/VSAM Data Functions tell you whether absolute or relative addresses are in effect.

Disk Browse (option 5.1)

Use this option to display the data structure on a physical disk.

You can change the top record of the display by overtyping the cylinder, head and record numbers displayed in the top left of the panel. You can also overtype the column number, to reposition the data. File Manager changes the column number when it repositions a record after a FIND primary command.

Disk Browse primary commands

The primary commands that you can use with the Disk Browse panel are:

- Standard scrolling forwards and backwards
- FIND
- RD
- RFIND

- RP
- ZOOM

These commands follow the standard browse primary command syntax explained in [Primary commands on page 1118](#), except for FIND. Because of the display constraints when browsing disks, RD always prints the current record in dump format, and RP always prints the current record in character format.

FIND

You use this primary command to search for specific data.

Figure 136. Syntax

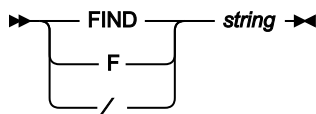

Parameters

string

Search string. Can be:

- A character string not starting or ending with a quotation mark and not containing any embedded blanks or commas. The case of the string is ignored. Uppercase and lowercase representations of the same character match. For example, `Mixed` matches `MIXED`.
- A character string enclosed in quotation marks. The string can contain blanks and commas. The case of the string is ignored. For example, `'Exact string'` matches `'exact string'`.
- C followed by a character string enclosed in quotation marks (C'Frog'), or a character string enclosed in quotation marks followed by c ('Frog'C). The string can contain blanks and commas. The string must match exactly (including case). For example, `C'Exact string'` does not match `C'exact string'`.
- X followed by a hexadecimal string enclosed in quotation marks (X'C1C2'), or a hexadecimal string enclosed in quotation marks followed by x ('C1C2'X).

If the string is found, it is displayed at the top position. The **Col** field indicates the position in the record. To find the next occurrence of the same string, press the RFind function key (F5) or enter the FIND command with no argument. A message is displayed if the string cannot be found. (See [Primary commands on page 1118](#) for more information about browse commands.)

Disk Track Edit (option 5.2)

Use this option to create, modify and manipulate records on a disk track.

You must specify the device, the data set name, or both and optionally the physical location of the track.

If you specify a track, File Manager presents the data immediately for editing.

If you do not specify a track, File Manager displays the selected extent in browse mode.

To edit and update a record:

1. Select the record that you want to update. Either move the cursor to the record, or use any of the locate commands that are available in browse functions.
2. Press the Zoom function key (F2). This gives you a detailed view of the selected record.
3. Update the record by:
 - Overtyping the existing text with new text. (You can overwrite the characters or the hex.)
 - Entering a column number in the **Col** field, and use the GET or COPY command to overwrite data in the record, starting at the specified column.

For the GET command, the data that you previously copied to the buffer with the PUT command is written. For the COPY command, you specify the columns of the current record that you want to copy.

For example, if the value in the **Col** field is 5 and you enter `COPY 10-12`, the data in columns 10 to 12 replaces the data that was previously in columns 5 to 7. If you enter `COPY 10`, the character in column 10 replaces the character that was previously in column 5.

- Entering a standard primary edit command.
4. Use the Exit function key (F3) to save your changes or the Cancel function key (F12) to discard the changes. A log of your changes is printed. You can now select another record to update.

Disk Track Edit primary commands

The primary commands that you can use with the Disk Track Edit panel are:

- Standard scrolling forwards and backwards
- ADDKEY
- BOUNDS
- CHANGE
- COPY
- DELETE
- GET
- EXCLUDE
- FIND
- RCHANGE
- RD
- RECOVER
- RFIND
- RP
- ZOOM

These commands follow the standard edit primary command syntax explained in [Primary commands on page 1118](#), except for ADDKEY, CHANGE, EXCLUDE, and FIND. Because of the display constraints when browsing disks, RD always prints the current record in dump format, and RP always prints the current record in character format.

ADDKEY

This primary command adds a key field to the current record. The command is available only when a single record is displayed using the ZOOM command.

FIND

This primary command finds the next occurrence of a character string in the data being browsed. When the string is found, File Manager positions the cursor at the beginning of the string and, if necessary, scrolls the data to bring the string into view.

There are two forms of the FIND command. The first form is simply `FIND string`. The second form, as detailed below, is only available when zoomed on a disk track.

Figure 137. Syntax

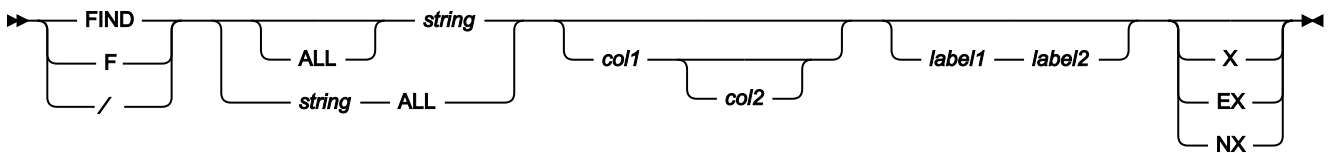

Parameters

ALL

Searches forwards from the top of data. Same as FIRST, except that ALL also displays the total number of occurrences of *string* in the records searched.



Note: Suppressed or not-selected records that are hidden from display or represented by shadow lines are not searched, even when you specify ALL.

col1

The first column to be included in the range of columns to be searched. Must be greater than or equal to 1, and less than or equal to the maximum record length.

col2

The last column to be included in the range of columns to be searched. Must be greater than or equal to *col1* and less than or equal to the maximum record length. If not specified, the last column of the record is used.

EX

Excluded records only.

label1

Label identifying the start of a range of records. The label must start with a period (.) followed by one to four alphabetic characters (no numeric or special characters). Labels starting with the letter "Z" indicate an editor-assigned label.

label2

Label identifying the end of a range of records. The label must start with a period (.) followed by one to four alphabetic characters (no numeric or special characters). Labels starting with the letter "Z" indicate an editor-assigned label.

NX

Non-excluded records only.

X

Same as EX.

string

Search string. Can be:

- A character string not starting or ending with a quotation mark and not containing any embedded blanks or commas. The case of the string is ignored. Uppercase and lowercase representations of the same character match. For example, `Mixed` matches `MIXED`.
- A character string enclosed in quotation marks. The string can contain blanks and commas. The case of the string is ignored. For example, `'Exact string'` matches `'exact string'`.
- C followed by a character string enclosed in quotation marks (C'Frog'), or a character string enclosed in quotation marks followed by c ('Frog'C). The string can contain blanks and commas. The string must match exactly (including case). For example, `C'Exact string'` does not match `C'exact string'`.
- X followed by a hexadecimal string enclosed in quotation marks (X'C1C2'), or a hexadecimal string enclosed in quotation marks followed by x ('C1C2'X).

To find the next occurrence of the same string, press the RFind function key (F5), or enter the FIND command with no parameters. A message is displayed if the string cannot be found.

CHANGE

Use this primary command to locate and replace one or more occurrences of a character string in the data being edited.

The CHANGE command only affects the record you have zoomed in on.

After the data has been changed, File Manager places the cursor at the beginning of the changed string, automatically scrolling, if necessary, to bring the string into view.

Figure 138. Syntax

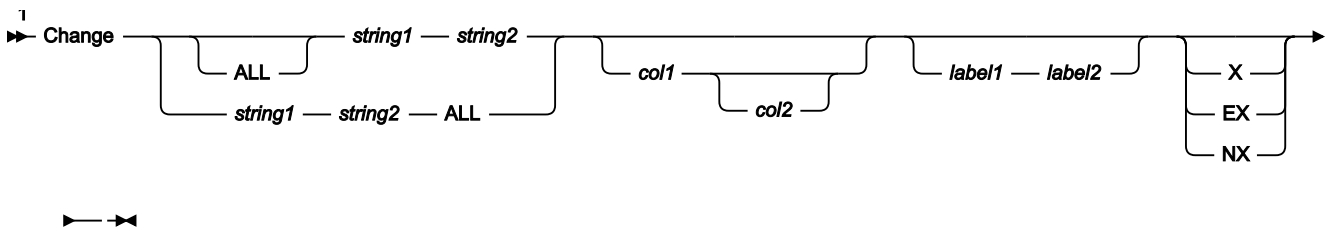

Notes:

¹ If none of these parameters (X, EX, or NX) are specified, excluded and non-excluded records are searched.

Parameters

ALL

Causes the search to begin at the top of the data and find and replace all occurrences of the string. If you do not limit the search to non-excluded records, then all excluded records containing the string are shown and replaced.

col1

The first column to be included in the range of columns to be searched. Must be greater than or equal to 1, and less than or equal to the maximum record length.

col2

The last column to be included in the range of columns to be searched. Must be greater than or equal to *col1* and less than or equal to the maximum record length. If not specified, the last column of the record is used.

EX

Excluded records only.

label1

Label identifying the start of a range of records. The label must start with a period (.) followed by one to four alphabetic characters (no numeric or special characters). Labels starting with the letter "Z" indicate an editor-assigned label.

label2

Label identifying the end of a range of records. The label must start with a period (.) followed by one to four alphabetic characters (no numeric or special characters). Labels starting with the letter "Z" indicate an editor-assigned label.

NX

Non-excluded records only.

string1

The string you want to search for. The string can be:

- A character string not starting or ending with a quotation mark and not containing any embedded blanks or commas. The case of the string is ignored. Uppercase and lowercase representations of the same character match. For example, the following command changes the strings `black`, `Black`, and `BLACK`:

```
CHANGE black white
```

- A character string enclosed in quotation marks. The string can contain blanks and commas. The case of the string is ignored. For example, `'Exact string'` matches `'exact string'`. The string can be a null string (`' '`). If `string1` is a null string, `string2` is inserted at the current column position.
- C followed by a character string enclosed in quotation marks (`C'Frog'`), or a character string enclosed in quotation marks followed by `c` (`'Frog'C`). The string can contain blanks and commas. The string must match exactly (including case). For example, `C'Exact string'` does not match `C'exact string'`. The string can be a null string (`' '`). If `string1` is a null string, `string2` is inserted at the current column position.
- X followed by a hexadecimal string enclosed in quotation marks (`X'C1C2'`), or a hexadecimal string enclosed in quotation marks followed by `x` (`'C1C2'X`).

string2

The string you want to replace `string1`. The string can be:

- A character string not starting or ending with a quotation mark and not containing any embedded blanks or commas. If CAPS ON or CASE UPPER is in effect, `string2` is translated to uppercase.
- A character string enclosed in quotation marks. It can contain blanks and commas. Case is respected and retained unless CASE UPPER is in effect, in which case `string2` is translated to uppercase. The string can be a null string (`' '`).
- X followed by a hexadecimal string enclosed in quotation marks (`x'C1C2'`). If CASE UPPER is in effect, all hexadecimal representations of lowercase characters are translated to their equivalent uppercase characters.

X

Same as EX.

See [CHANGE/CX primary command on page 1129](#) for more information about the parameters used with the CHANGE primary command.

EXCLUDE

The EXCLUDE primary command excludes from display certain records in the data being edited.

Figure 139. Syntax

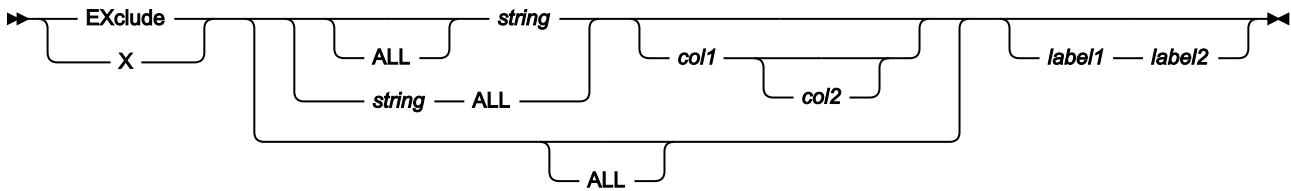

Parameters

ALL

Causes the search to begin at the top of the data and find all occurrences of *string*. If not specified, the search begins at the cursor location (if the cursor is within the data portion of the screen) or the beginning of the first record displayed, and searches ahead to find the next occurrence of *string* in a record that is not already excluded.



Note:

1. The command EXCLUDE ALL excludes all displayed records.

col1

The first column to be included in the range of columns to be searched. Must be greater than or equal to 1, and less than or equal to the maximum record length.

col2

The last column to be included in the range of columns to be searched. Must be greater than or equal to *col1* and less than or equal to the maximum record length. If not specified, the last column of the record is used.

label1

Label identifying the start of a range of records. The label must start with a period (.) followed by one to four alphabetic characters (no numeric or special characters). Labels starting with the letter "Z" indicate an editor-assigned label.

label2

Label identifying the end of a range of records. The label must start with a period (.) followed by one to four alphabetic characters (no numeric or special characters). Labels starting with the letter "Z" indicate an editor-assigned label.

string

The search string you want to search for. Records containing this string, within the limits imposed by the other EXCLUDE command parameters, are excluded. The string can be:

- A character string not starting or ending with a quotation mark and not containing any embedded blanks or commas. The case of the string is ignored. Uppercase and lowercase representations of the same character match. For example, `Mixed` matches `MIXED`.
- A character string enclosed in quotation marks. The string can contain blanks and commas. The case of the string is ignored. For example, `'Exact string'` matches `'exact string'`.
- C followed by a character string enclosed in quotation marks (C'Frog'), or a character string enclosed in quotation marks followed by c ('Frog'C). The string can contain blanks and commas. The string must match exactly (including case). For example, `C'Exact string'` does not match `C'exact string'`.
- X followed by a hexadecimal string enclosed in quotation marks (X'C1C2'), or a hexadecimal string enclosed in quotation marks followed by x ('C1C2'X).

Disk Print (option 5.3)

Use this option to print the records in a disk extent in character or hexadecimal format.

Specifying what you want to print

To print records from a disk, you must specify the range of tracks that you want to print.

1. Specify the beginning of the range, in one of the following ways:
 - The beginning address in the form `cylhd`, where the last two digits represent the head and the other digits represent the cylinder
 - A track number, in the form `Rnnnnnnn`
 - An asterisk (*), which means the beginning of the data set
2. Specify the end of the range, in one of the following ways:
 - The end address in the form `cylhd`
 - A track number, in the form `Rnnnnnnn`
 - A number of tracks, in the form `Nnnnnnnn`
 - An asterisk (*), which means the end of the data set

Depending on the value of the **CYLHD** entry field of the Set Processing Options, you specify either the absolute disk location or the relative location within the data set.

If a defective track with an assigned alternate track is encountered, File Manager processes the contents of the alternate track.

When you print records from a disk, you can specify any of the following dump types:

KD

Prints the key fields (if any) and data fields. This is the default.

CKD

Prints the home address and record 0 fields, followed by the count, key and data fields.

KEY

Prints *only* the key field and not the data portion of each record

CNT

Prints *only* the home address and count fields and not the key field and data portion of each record

Controlling print output

Several options on the Set Processing Options (option 0) panel affect the printed output:

DATAHDR

Whether the output contains a data header for each record

DUMP

Which format (updown or across) is used for hexadecimal output

HEADERPG

Whether the output contains a header page at the beginning

PAGESIZE

How many lines per page the output has

PAGESKIP

Whether output from each function starts on a new page

PRINTLEN

How many columns wide the output is

PRINTOUT

Where the output is sent

PRTRANS

Whether non-printable characters are translated to blanks

RECLIMIT

Which part of each record to print

For more information, see [Set Print Processing Options panel \(option 0.1\) on page 1025](#).

You can also specify a record length, to deblock each physical record into logical records. The physical block size does not need to be a multiple of the record length that you specify.

Disk Record Scan (option 5.4)

Use this option to find specific data on a disk.

Limit the search to a range of records by entering an extent begin and extent end, as you do for the print function. (See [Specifying what you want to print on page 485](#) for more information.)

You must specify the type of scan you want performed by entering a value in the **Scan type** field. Values are:

D

Searches the data field of each record.

K

Searches the key field of each record.

E

Searches for end-of-file records. If you select E, you do not need to specify a search string.

Scanning starts at the scan position (default 1). If you specify that pattern scanning is to be used, then scanning looks for the occurrence of the scan argument anywhere from the start position. If you specify that pattern scanning is not to be used, then scanning looks only at the start position.

If you specify a record length, physical blocks are deblocked into logical records before searching.

The scan argument is the string that you want File Manager to search for. The string can contain up to 50 characters. It has the same format as the find string (see [Disk Browse \(option 5.1\) on page 477](#)). The string does not apply if the scan type is E. Otherwise, it is required.

The output of this option is a list of records that meet your search conditions.

Write EOF Record (option 5.5)

Use this option to write a logical EOF marker into a sequential disk file.

File Manager retrieves the record at the specified location and rewrites it as an end-of-file indicator. File Manager writes a special record with a data length of zero (null record). All data on the track past this EOF record is lost. File Manager prints a log of the retrieved record, provided your print output is not routed to the terminal. Alter the destination of the print log by changing the value in the **PRINTOUT** entry field of the Set Print Processing Options panel (see [Set Print Processing Options panel \(option 0.1\) on page 1025](#)). The EOF record has a data length of zero.

Data Set Extents (option 5.6)

Use this option to display the begin and end of the extents of a data set.

The display panel shows absolute disk extents and disk extents relative to the beginning of the data set. You can use this information for all disk functions which prompt you for the location of a disk extent.

For multivolume data sets only the extents on the selected volume are shown.

[Figure 140: Data set extents display on page 488](#) shows an example of DSX output.

Figure 140. Data set extents display

```

Process  Options  Help
-----
File Manager                Data Set Extents
Input:
-----
File Manager Messages
-----
VOLSER: MVS4W4  Data Set Name: FMUSER.FMOS390.QSAM
Absolute and relative extent limits within data set:
-----
Ext  Tracks  Begin - ABSOLUTE - End      Begin - RELATIVE - End
 0    1    Cyl-hd Rnnnnn  Cyl-hd Rnnnnn  Cyl-hd Rnnnnn  Cyl-hd Rnnnnn
 0    1    69  0  1035  69  0  1035  0  0  0  0  0  0
 1    1    69  1  1036  69  1  1036  0  1  1  0  1  1
 2    1    69  2  1037  69  2  1037  0  2  2  0  2  2
 3    1    69 13  1048  69 13  1048  0  3  3  0  3  3
 4    1    70  4  1054  70  4  1054  0  4  4  0  4  4
-----
Press the CANCEL or EXIT key to remove the message Pop-Up          6
-----
Command ==>  Scroll PAGE_
F1=Help      F2=Split    F3=Exit     F4=CRetriev F7=Backward
F8=Forward   F9=Swap     F10=Actions F12=Cancel
-----
Command ==>  -----
F1=Help      F2=Split    F3=Exit     F4=CRetriev F7=Backward F8=Forward
F9=Swap     F10=Actions F12=Cancel

```

VSAM Update (option 5.7)

Use this option to display VSAM data and update records or control intervals.

Be careful when updating control intervals. If you make incorrect changes to control information, the data set may become unusable.

To update a record:

1. Locate the record you want to update. As well as using standard ways of scrolling or finding, you can overwrite the RBA, key and slot fields. By default keyed access is used for keyed data, and addressed access for non-keyed data. Specifying a RBA for a KSDS sets addressed sequence for subsequent scrolling.
2. Select the record with the Zoom function key (F2).
3. Change the data, using standard edit techniques.
4. Press the Exit function key (F3) to save the changed record, or Cancel function key (F12) to discard the changes.

File Manager prints a log of the changed record, provided your print output is not routed to the terminal. Alter the destination of the print log by changing the value in the **PRINTOUT** entry field of the Set Print Processing Options panel (see [Printing from File Manager on page 402](#)). You can select another record to update or leave the function.

To specify control interval access to see full control intervals (including control information) instead of logical records, enter YES in the **CI access** field. Control intervals are processed in addressed sequence. You cannot use CI access with a compressed KSDS (this is a system restriction).

VSAM update uses the same primary commands as [Disk Track Edit \(option 5.2\) on page 478](#).

Data in Virtual (option 5.8)

Use this option to browse a data-in-virtual data set at the terminal.

Chapter 11. OAM Functions

Use the options of the OAM Functions menu to display, backup, and restore the contents of OAM collections or optical volumes. When you work with one object, you can browse, print, or update object data, and copy or erase objects.

These functions use the same primary commands as the Disk/VSAM Data Functions (option 5).

Introducing the Object Access Method

This section provides a brief introduction to Object Access Method (OAM). For more information, see the z/OS DFSMS Object Access Method Application Programmer's Reference.

In OAM, an *object* is a stream of bytes with a name. The content, format, and structure of that byte stream are unknown to OAM. For example, an object could be a compressed scanned image, or coded data. There are no individual records within an object.

A *collection* is a group of objects that typically have similar performance, availability, backup, retention, and class transition characteristics. Every object must be assigned to a collection. Object names must be unique within a collection; the same object name can be used in different collections.

OAM is an access method of MVS/DFP, the base for DFSMS. OAM uses the SMS-supplied hierarchy definition and management parameters to place user-accessible objects anywhere in the storage hierarchy. The hierarchy consists of DASD, library-resident optical volumes, and shelf-resident optical volumes. The location of an object in the hierarchy is unknown to the user; device-dependent information (such as track size) is not required.

For each object, the user can specify:

Storage Class

The level of service for the object, independent of the physical device or medium containing the object

Management Class

Backup, retention, and class transition characteristics for the object

The storage class and management class may be overridden by your installation defaults.

Object Directory List (option 6.1)

Use this option to list the objects from a collection, or a primary or backup optical volume. You can print the list, or, if you display the list, you can browse, print, update, or erase any of the listed objects.

Select the objects by a fully qualified or a generic object name, and specify the collection name, the volser of an optical volume, or both.

The information listed includes:

- Object name
- Object size

- Object location (DASD or optical)
- Volume serial number (if known)
- Creation and expiration dates
- Storage class
- Management class

Sort the list by object name, size, creation date, or expiration date.

You can use the display as a selection list. To invoke a File Manager command for an object, position the cursor on the desired line, press Process function key (F6), and select the function from the pull-down menu, or type a line command over the beginning of the object name.

The following figures show the object directory entry and display panels.

Figure 141. Object Directory List display panel

```

Process  View  Options  Help
-----
File Manager          ODL - Object Directory List          Line 1 of 12
Collection FMNUSER.OAM.CLLCT01          SC DB2DASD  MC MAGONLY

---- Object Name ---- sorted by NAME__ ---- ----Creation---- -Object- Location
....5...10...15...20...25...30...35...40.... ---Date--- -Time --size-- - VOLSER
FMNUSER.SIMOBJ.T01          2000-03-09 16:48          7040 D  N/A
FMNUSER.SIMOBJ.T02          2000-03-09 16:48          7865 D  N/A
FMNUSER.SIMOBJ.T03          2000-03-09 16:48          13566 D N/A
FMNUSER.SIMOBJ.T04          2000-03-09 16:48          14280 D N/A
FMNUSER.SIMOBJ.T05          2000-03-09 16:49          242028 D N/A
FMNUSER.SIMOBJ.T06          2000-03-09 16:49          6776 D  N/A
FMNUSER.SIMOBJ.T07          2000-03-09 16:49          1596 D  N/A
FMNUSER.SIMOBJ.T08          2000-03-09 16:49          223380 D N/A
FMNUSER.SIMOBJ.T09          2000-03-09 16:49          17760 D N/A
FMNUSER.SIMOBJ.T10          2000-03-09 16:49          5445 D  N/A
FMNUSER.SIMOBJ.T11          2000-03-09 16:49          11704 D N/A
FMNUSER.SIMOBJ.T12          2000-03-09 16:49          669696 D N/A

Command ==>----- Scroll PAGE_
F1=Help F2=Browse F3=Exit F4=CRetrieve F5=RFind F6=Process F7=Up
F8=Down F9=Swap F10=Actions F11=RgtLeft F12=Cancel

```

By pressing the Rgtleft function key (F11) you can switch between two display formats to see all the information you would get on a full-width printout. The second display format is shown in [Figure 142: Object Directory List display panel \(alternative display\) on page 492](#).

Figure 142. Object Directory List display panel (alternative display)

Process	View	Options	Help
File Manager		ODL - Object Directory List	Line 1 of 12
Collection	FMNUSER.OAM.CLLCT01	SC DB2DASD	MC MAGONLY
----	Object Name	----- sorted by NAME__	----- Storage
....5...	10...	15...	20...
25...	30...	35...	40....
		--class-	--class-
		---	date---
			-ID-
FMNUSER.SIMOBJ.T01		DB2DASD	MAGONLY
FMNUSER.SIMOBJ.T02		DB2DASD	MAGONLY
FMNUSER.SIMOBJ.T03		DB2DASD	MAGONLY
FMNUSER.SIMOBJ.T04		DB2DASD	MAGONLY
FMNUSER.SIMOBJ.T05		DB2DASD	MAGONLY
FMNUSER.SIMOBJ.T06		DB2DASD	MAGONLY
FMNUSER.SIMOBJ.T07		DB2DASD	MAGONLY
FMNUSER.SIMOBJ.T08		DB2DASD	MAGONLY
FMNUSER.SIMOBJ.T09		DB2DASD	MAGONLY
FMNUSER.SIMOBJ.T10		DB2DASD	MAGONLY
FMNUSER.SIMOBJ.T11		DB2DASD	MAGONLY
FMNUSER.SIMOBJ.T12		DB2DASD	MAGONLY
Command	===>		Scroll PAGE_
F1=Help	F2=Browse	F3=Exit	F4=CRetrieve
F5=RFind	F6=Process	F7=Up	
F8=Down	F9=Swap	F10=Actions	F11=RgtLeft
F12=Cancel			

To move forward or backward through the library member list, use the Down function key (F8) or Up function key (F7), or use the LOCATE command.

Object Browse (option 6.2)

Use this function to browse an OAM object.

Browsing objects is similar to general browsing. For more information, see [Viewing and changing data sets on page 87](#).

Object Print (option 6.3)

Use this option to print an OAM object in character or hexadecimal format.

You can specify the block size for the output, the number of bytes to skip from the beginning of the object, and the maximum number of bytes to print.

Controlling print output

Several options on the Set Processing Options (option 0) panel affect the printed output:

DATAHDR

Whether the output contains a data header for each record

DUMP

Which format (updown or across) is used for hexadecimal output

HEADERPG

Whether the output contains a header page at the beginning

PAGESKIP

Whether output from each function starts on a new page

PRINTLEN

How many columns wide the output is

PRINTOUT

Where the output is sent

PRTRANS

Whether non-printable characters are translated to blanks

RECLIMIT

Which part of each block to print

For more information, see [Set Print Processing Options panel \(option 0.1\) on page 1025](#).

Object Update (option 6.4)

Use this option to update an object.

To locate specific data, use the standard locate and positioning commands.

To update an OAM object:

- Overtyping the existing text with new text.
- Enter a column number in the **Col** field, and use the GET or COPY command to overwrite data, starting at the specified column.

For the GET command, the data that you previously copied to the buffer with the PUT command is written. For the COPY command, you specify the columns that you want to copy. For example, if the value in the **Col** field is 5 and you enter `COPY 10-12`, the data in columns 10 to 12 replaces the data that was in columns 5 to 7. If you enter `COPY 10`, the character in column 10 replaces the character that was in column 5.

Use the Exit function key (F3) to save your changes or Cancel function key (F12) to discard the changes.

Object Erase (option 6.5)

Use this option to erase an OAM object. When you specify the object, File Manager removes it from the collection.

Object Copy Functions (option 6.6)

When you select this option, you have a choice of copies. You can copy to and from VSAM, to and from QSAM, or object to object.

When you copy object to object, you copy to a different object collection, or to a different name within the same collection. You can optionally change the management class and storage class.

You can also use the copy options to back up and restore objects.

Backing up OAM objects

Use the To VSAM option to back up one or more OAM objects to a VSAM data set.

Use the To QSAM option to back up one or more OAM objects to a sequential data set.

Object to VSAM (option 6.6.1)

Use this option to copy an object to a VSAM data set, for backing up (as described below).

Object to Sequential Data (option 6.6.2)

Use this option to copy an object to a QSAM data set, for backing up (as described below).

VSAM to Object (6.6.3)

Use this option to copy an object from a VSAM data set, for restoring (as described below).

Sequential Data to Object (option 6.6.4)

Use this option to copy an object from a QSAM data set, for restoring (as described below).

Object to Object (option 6.6.5)

Use this option to copy an object within a collection, using a different object name, or into another collection.

Backing up a single OAM object

To back up a single OAM object, specify:

- The collection name and object name for the object.
- The output data set, according to the normal rules for sequential output or VSAM output functions.
- For VSAM output, whether you want to replace any existing records in the data set.
- Whether you want to create an object header. (An object header is a header record with directory information for every object copied, for later use in object restore operations.)

If you want only the data within the object, specify that you do not want an object header. For VSAM, the output data set can be a linear data set, an ESDS or RRDS with an appropriate block size, or a KSDS (if the OAM object contains information that can be used as keys).

If you want the object as such (for example, to create a backup copy that you might later copy back to an OAM object collection), you should specify that you want an object header. For VSAM, you should use an ESDS.

The object header is intended for use by the File Manager option only. It is not designed for use by products other than File Manager.

- The block size for the output data set. The default is 4096.
- The other input parameters (such as *limit* parameter or the optical disk volume serial number) apply when you are backing up a single object.

Backing up many OAM objects

To back up many OAM objects, specify:

- Which objects you want to back up. You must specify a collection name, an optical disk volume serial number, or both. You can back up all of the objects within the collection, volume, or collection/volume combination, or you can back up a subset of the objects based on these criteria:
 - A generic object name, containing at least one percent sign (%), asterisk (*), or double asterisk (**). (With a non-generic object name, you back up a single object as described previously.)
 - The *limit* parameter, to limit the backup to objects on DASD, objects on optical disks, or objects on a specific optical disk volume. (If you specify an optical disk volume serial number, you must also specify VOLSER for the *limit* parameter.)
 - The earliest creation date
 - The latest creation date
- The output data set, according to the normal rules for sequential output or VSAM output functions. For VSAM output, the data set must be an ESDS.
- For VSAM output, whether you want to replace any existing records in the data set.
- The block size for the output data set. The default is 4096.
- The *header* parameter does not apply when you are backing up many objects. A header is automatically generated for each object. This object header is intended for use by File Manager options only. It is not designed for use by products other than File Manager.

Restoring OAM objects

Use the From VSAM option to restore one or more OAM objects from a VSAM data set.

Use the From QSAM option to restore one or more OAM objects from a sequential data set.

To restore one or more objects, you should know whether the backup data set was created by a single-object backup or a multiple-object backup.

Restoring an object that was backed up individually

The instructions in this section tell you how to:

- Restore an object that was backed up as a single object with an object header.
- Restore an object that was backed up as a single object without an object header.
- Create an OAM object from a data set that was not previously an OAM object. (This is equivalent to the previous case, because File Manager does not know if a data set with no header was formerly an OAM object.)

In any of these cases, specify:

- The input data set, according to the normal rules for VSAM input or sequential input functions.
- The collection name, object name, storage class, and management class. By default, the values in the object header (if any) are used.
- Whether you want to replace any existing object with the same name in the same collection.

Restoring one or more objects from a multiple-object backup

Follow the instructions in this section to:

- Restore all of the objects from a multiple-object backup.
- Restore some of the objects from a multiple-object backup.
- Restore one of the objects from a multiple-object backup.

In any of these cases, specify:

- The input data set, according to the normal rules for sequential input or VSAM input functions.
- Which object or objects you want to restore. You can restore all of the objects in the data set, or you can restore a subset of the objects based on these criteria:
 - Collection name
 - Object name or generic object name
 - The *limit* parameter, to restore only objects that were backed up from DASD, from optical disks, or from a specific optical disk volume.
 - The earliest creation date
 - The latest creation date
- The storage class and management class.
- Whether you want to replace any existing object with the same name in the same collection.

The object or objects that meet the specified criteria are restored. Each object has the same object name and the same collection as it had before it was backed up. You cannot change the object name or collection name with this function.

Chapter 12. Using UNIX™ System Services and the Hierarchical File System

z/OS® UNIX™ System Services gives the z/OS® operating system an open standards interface. It contains a UNIX™ shell and utilities, which you can use to enter shell commands, write shell scripts, and work with the file system.

z/OS® UNIX™ provides a Hierarchical File System (HFS) for z/OS®. A file within z/OS® UNIX™ is called an HFS file. HFS files are organized in a hierarchy of files and directories in a tree much like UNIX™. A directory can contain files or other subdirectories.

To access the Hierarchical File System:

1. Select option 8 (**HFS**) from the Primary Option Menu.

File Manager displays the Access Hierarchical File System panel.

2. On the Access Hierarchical File System panel, select the required option so that File Manager invokes standard ISPF services to enable access to UNIX System Services and HFS utilities.

If you are familiar with File Manager functions, there is a convenient way to access HFS files. For basic functions, you can specify an HFS file in the same panels and batch commands as an z/OS® data set.

File Manager can access an HFS file as a simulated QSAM/BSAM file. This means that at the I/O level, the file is seen as a single-volume, physical, sequential data set that resides on DASD. It is allocated dynamically or referred using a DD statement (PATH parameter).

The following sections summarize the main features and differences.

Specifying an HFS file

An HFS file is identified by means of a path leading to it. File Manager requires an absolute path; file specification starts from the root. Paths are specified in the same fields and using the same batch parameters as z/OS® data sets. A name is considered a path name if contains a slash ("/). A correct absolute path name must start with a slash, otherwise, it is treated as a data set name.

A path name is case-sensitive and can contain spaces, commas, and other special characters. In batch, the path name needs to be enclosed in single quotation marks. In fullscreen mode, use of apostrophes is optional.

File Manager allows for an absolute path name up to 255 characters long. Fields in panels dedicated for data set names can also carry path names. They are expandable and allow for long name specification. Also, the syntax used in batch allows for specification of path names, even if they do not fit into one line.

In batch, you can specify the path name with a PATH JCL parameter, and refer to it in File Manager control statements with a ddname. For a description of PATH and other path-related parameters, see the JCL manuals.

The following File Manager functions support HFS files:

- Edit
- View
- Create (DSG)
- Copy (DSC)
- Print (DSP)
- Compare (DSM)
- DSEB (in Browse mode only)
- Find (FCH)

Using directories

HFS files are maintained in directories, which constitute a hierarchical structure, not supported by standard z/OS® data management access methods. However, File Manager allows for specifying a path to a directory (like specifying a PDS library without member).

An HFS directory is displayed in a similar way to a PDS directory. Each entry on the list contains an object name and basic attributes. An entry in the directory can describe another directory. Navigations through the nested lists of entries is supported. The object name may not fit into one line of the list, with only a part of name being displayed. To see the whole name, position the cursor at the name and press Enter to display a pop-up window showing the absolute path name. For the copy operation, the pop-up window also allows you to specify the target file or a PDS member name (if copying to a PDS library).

Selecting files for processing

An absolute path name may specify a file, a group of files with names matching a pattern, or a directory. In on-line mode, the scope of files displayed or processed depends on the last component of the path name specified as shown in [Table 10: Scope of files displayed or processed according to pathname specified on page 498](#).

Table 10. Scope of files displayed or processed according to pathname specified

Last component of path name specified	Files displayed or processed
A file	The file is processed.
A directory	A list of all names in the directory is displayed. You can select files to be processed.
A name containing wildcard characters	A list of all matching names is displayed. You can select files to be processed.
An asterisk (*)	Where possible (for example, Print, Copy, Find), all files in the directory (but not in subdirectories) are processed without displaying the list of names.

When you are creating JCL and control statements for submission (in batch), the rules are the same. However, you can only select one file for further processing.

In batch, as it is not possible to navigate through subdirectories and dynamically select files, all files which are referred to by a path name are processed. In the other words, the rules are the same as when processing on-line, except that all files within the scope determined by the path name are selected.

Logical record length

HFS files are byte-oriented, not record-oriented like z/OS® data sets. An HFS file is either defined as a *text* file, where record boundaries are determined by a delimiter (such as NL, LF, CR, and so on), a *binary* file (no specific boundaries), or neither a text or binary file. When accessing the file as a simulated QSAM data set, File Manager must identify logical records. The choice is left to you, rather than based on the file type. File Manager assumes text mode (delimited records), unless you request binary mode. In text mode, records are variable-length with the data residing between delimiters. In binary mode, delimiters are not distinguished; the records are user-defined and of fixed length (80 is the default).

File Manager assumes a maximum block size of 32760 bytes. The maximum record length is 32752 for variable-length records, and 32760 for fixed-length records. If the record length is greater than the limit, you must use binary mode.

Processing an HFS file

File Manager allows for various processing at record level. A record simulated in an HFS file can be subject to the same processing as a record belonging to an z/OS® data set. The similarity at record level enable HFS files to be viewed, edited, copied, and compared using the same functions and panels as z/OS® data sets. Also, the same rules for using templates and manipulating data apply. Some specific differences are mentioned in the following sections.

Viewing and editing HFS files

HFS files are viewed and edited in the same way as z/OS® data sets (see [Viewing and changing data sets on page 87](#)). You can specify an existing HFS file or directory as input. When you use Edit, File Manager uses the in-memory technique if the file fits into memory, otherwise it uses an auxiliary edit. In-place edit is not used.

A viewed or edited file can be interpreted as a text or binary file. If the **Binary mode** option is not selected, text mode is assumed and records are determined by delimiters. If you select the **Binary mode** option, the records are determined by record size defined in `reclen`, or by the default, 80 bytes. In View or Edit, records in text mode are assumed to be variable-length and up to 32752 characters long. However, if the size of the whole file is less than the record size limit, file size is assumed as the maximum record size.

If you specify a path to the HFS directory as an input file, File Manager displays the directory list. You can select one or more HFS files and then view or edit them. If you select a subdirectory, File Manager displays a new list, allowing selection on the next level. To return to the previous list, press the Exit function key (F3). In this way, you can navigate through the directories and choose the files to be displayed.

To display a pop-up window with the absolute path name (including the complete file name, which may be shortened on the list), position the cursor at the file name and press Enter.

Creating HFS files

You can create new records in an existing HFS file in the same way as you do for z/OS® files, or create a new file and initialize it with new records. The rules are described in [Creating data sets and records on page 328](#). If the file already exists, specify the same options as for an z/OS® file. If you are creating a new file, select **9 (HFS)** on the Allocate: New Data Set Organization panel. Then, on the File Attributes panel, define the privileges details for accessing the file.

A viewed or edited file can be interpreted as a text or binary file. If you do not select the **Binary mode** option, text mode is assumed and records are determined by delimiters. If you select the **Binary mode** option, the records are determined by record size defined in reclen, or by the default, 80 bytes.

You cannot specify a path to the HFS directory. Only a regular file can be allocated or initialized.

Copying HFS files

You can copy HFS files to and from other HFS files and z/OS® data sets. In general, the methods are the same as described in [Copying data sets on page 341](#). When you specify an HFS file as either the *"From"* or *"To"* object, File Manager treats it as a sequential data set.

Both source and target files can be interpreted as text or binary files. If the **Binary mode** option is not selected, text mode is assumed and records are determined by delimiters. If you select the **Binary mode** option, the records are determined by record size defined in reclen, or by the default, 80 bytes.

If you specify a path to the HFS directory as an input file, File Manager displays the directory list. You can select one or more HFS files and copy them. If you select a subdirectory, File Manager displays a new list, allowing selection on the next level. To return to the previous list, press the Exit function key (F3). In this way, you can navigate through the directories and choose the files to be displayed.

To display a pop-up window with the absolute path name (including the complete file name, which may be shortened on the list), position the cursor against the file name and press Enter. If this is the *"From"* HFS directory, the pop-up window allows you to rename the target file (if the *"To"* specification describes an HFS directory) or the target member (if the *"To"* specification describes a PDS library).

If the directory is specified in batch, all regular files from this directory, but not from sub-directories, are copied.

When you copy members from a PDS library to an HFS directory, member names become file names (they can be changed in the fullscreen mode). When you copy from an HFS directory to a PDS library, the targets are members and their names must conform to a member name. If you do not rename the target files, File Manager derives the file name in the following way:

- Translates the file name to uppercase.
- If the name is longer than 8 characters, characters from the ninth position onwards are ignored.
- Starting from the first character, File Manager uses the maximum number of characters (up to a maximum of 8) that conform to member name rules to form the file name. If the first character violates the member name rules, the target name is not created and the file is not copied.

Comparing HFS files

An HFS file can be compared to another HFS file or to an z/OS® data set. You can specify the “*Old*” or the “*New*” object (or both) as a path describing the file. The compare operation and options for an HFS file are the same as for a BSAM/QSAM data set and are as described in [Comparing data sets on page 381](#).

A compared file can be interpreted as text or binary files. If the **Binary mode** option is not selected, text mode is assumed and records are determined by delimiters. If you select the **Binary mode** option, the records are determined by record size defined in *reclen*, or by the default, 80 bytes.

If you specify a path to an HFS directory as the “*Old*” or “*New*” file, the directory list is displayed (fullscreen mode). You must select an HFS file from the list before the compare starts. The subjects of the compare are always files and data sets, not directories.

To display a pop-up window with the absolute path name (including the complete file name, which may be shortened on the list), position the cursor against the file name and press Enter.

You cannot specify a directory in batch.

The compare output does not differ significantly from the output produced when data sets are compared. The only difference is “*file*” is used instead of “*data set*”.

Printing HFS files

You can print HFS files in the same way that you print z/OS® files and as described in [Printing from File Manager on page 402](#).

A printed file can be interpreted as text or binary files. If the **Binary mode** option is not selected, text mode is assumed and records are determined by delimiters. If you select the **Binary mode** option, the records are determined by record size defined in *reclen*, or by the default, 80 bytes.

If you specify a path to the HFS directory as the input file, File Manager displays the directory list. You can select one or more HFS files for printing. If you select a subdirectory, File Manager displays a new list, allowing selection on the next level. To return to the previous list, press the Exit function key (F3). In this way, you can navigate through the directories and choose the files to be displayed.

To display a pop-up window with the absolute path name (including the complete file name, which may be shortened on the list), position the cursor against the file name and pressing Enter. If the directory is specified in batch, all regular files from this directory, but not from sub-directories, are printed.

The printed output does not differ significantly from the output produced when you print data sets. The only difference is “*file*” used instead of “*data set*”.

Finding a string in HFS files

You can search HFS files in the same way that you find strings in z/OS® files as described in [Finding and changing data in multiple PDS members on page 368](#).

A searched file can be interpreted as text or binary. If the Binary mode option is not selected, text mode is assumed and records are determined by delimiters. If you select the Binary mode option, the records are determined by record size defined in reclen, or by the default, 80 bytes.

If you specify a path to the HFS directory as the input file, File Manager displays the directory list. You can select one or more HFS files for processing. If you select a subdirectory, File Manager displays a new list, allowing selection on the next level. To return to the previous list, press the Exit function key (F3). In this way, you can navigate through the directories and choose the files to be processed. This allows you to build a process list which you can further refine and search.

To display a pop-up window with the absolute path name (including the complete file name which may be shortened on the list), position the cursor against the file name and press Enter.

If the directory is specified in batch, all regular files from this directory, but not from sub-directories, are searched.

The output from the find process does not differ significantly from the output produced when you search data sets. The only difference is the words "path" and "file" are used instead of "data set" and "member" respectively.

Related topics

[Primary Option Menu panel on page 970](#)

[Access Hierarchical File System panel on page 725](#)

Chapter 13. Introduction to programming with File Manager functions

Most of the tasks that you can perform using File Manager panels under ISPF can also be performed by calling equivalent File Manager functions from batch jobs, REXX procedures or TSO clists.

Summary of File Manager functions

File Manager functions are listed below, arranged according to the tasks they can perform and the data types you can use them with.

Where a File Manager function has an equivalent panel that you can use under ISPF, the panel option number is listed in the **Equivalent panel** column. Functions marked “*batch only*” cannot be used in REXX procedures or TSO clists.

For a list of functions where you can use templates, see [Where can you use templates? on page 34](#).

Listing catalogs and directories

What you can list	Function	Equivalent panel
System catalog entries	SCS	3.4
VSAM catalog entries	SCS	3.4
VTOC entries	DVT	3.5
OAM objects	ODL	6.1
MQ Managers	MQL	9.1
MQ Queues	Queues	9.1 after selecting a manager

Editing, updating, comparing, and creating data

What you can edit	Function	Equivalent panel
VSAM data	DSEB (batch only)	2
Sequential data	DSEB (batch only)	2
CICS® resource	DSEB (batch only)	2

What you can update	Function	Equivalent panel
VSAM data	DSU (batch only)	
Sequential data	DSU (batch only)	
CICS® resource	DSU (batch only)	



Note: The difference between updating data (DSU) and editing data (DSEB) is that DSU operates on a per-record basis: each record in a data set is treated separately, in sequence. Using DSEB you can move between the records in a data set as you choose, similar to the way you can scroll around a data set in an edit panel.

What you can compare	Function	Equivalent panel
VSAM data	DSM	3.11
Sequential data	DSM	3.11
MQ data	DSM	3.11
CICS® resource	DSM	3.11

What you can create	Function	Equivalent panel
Sequential data	DSG	3.1
VSAM data	DSG	3.1
MQ data	DSG	3.1
Tape data	BT	4.7
CICS® resource	DSG	3.1

Copying data

Copy from	Copy to (function, equivalent panel)						
	VSAM	QSAM	Tape	OAM	REXX	MQ	CICS®
VSAM	DSC, 3.3	DSC, 3.3	VT, 4.2.6	VO, 6.6.3	VX	DSC, 3.3	DSC, 3.3
QSAM	DSC, 3.3	DSC, 3.3	ST, 4.2.7 QT, 4.2.7	SO, 6.6.4 QO, 6.6.4		DSC, 3.3	DSC, 3.3
Tape	TV, 4.2.4	TS, 4.2.5 TQ, 4.2.5	TT, 4.2.1 TTR, 4.2.2 TLT, 4.2.3		TX	DSC, 3.3	DSC, 3.3
OAM	OV, 6.6.1	OS, 6.6.2 OQ, 6.6.2		OO, 6.6.5			
REXX	XV		XT				
MQ	DSC, 3.3	DSC, 3.3	DSC, 3.3			DSC, 3.3	DSC, 3.3
CICS®	DSC, 3.3	DSC, 3.3	DSC, 3.3			DSC, 3.3	DSC, 3.3

Printing data

What you can print	Function	Equivalent panel
VSAM data	DSP	3.2
Sequential data	DSP	3.2
MQ data	DSP	3.2
CICS® resource	DSP	3.2
Tape data	TP	4.5
Tape data	TP	4.5
CKD disk tracks	DP	5.3
OAM objects	OP	6.3

Erasing data

What you can erase	Function	Equivalent panel
Tape records	ERT	4.13
OAM objects	OE	6.5

Managing data sets

What you can do	Function	Equivalent panel
Alter a data set	DSFA	
Allocate a data set	DSFC	
Delete a data set	DSFD	
Rename a data set	DSFR	

Managing tapes

What you can do	Function	Equivalent panel
Space backward by record	BSR	4.15.3
Space backward by file	BSF	4.15.1
Space forward by record	FSR	4.15.4
Space forward by file	FSF	4.15.2
Rewind	REW	4.15.5
Rewind and unload	RUN	4.15.6
Initialize	INT	4.12

What you can do	Function	Equivalent panel
Write tape marks	WTM	4.11
Compare two tapes	TTC	4.9
Print tape label information	TLB	4.8
Print a tape map	TMP	4.6

Managing your processing environment

What you can do	Function	Equivalent panel
Query File Manager version	VER	See note
Format DBCS data	FMT	3.0
End File Manager job	EOJ	
Change processing options	SET	0



Note: To query the File Manager version from the ISPF interface, select **Help > About** from the action bar.

Using File Manager functions in REXX procedures or TSO clists

To call a File Manager function from a REXX procedure, use the following syntax:

```
FILEMGR "$function-name-parameters"
```

To call a File Manager function from a CLIST, use the following syntax:

```
FILEMGR $function-name-parameters
```

Join the parameter names and values with an equal sign or a blank. Separate these pairs with a comma or blank. For example:

```
FILEMGR "$DSP DSNIN='FMUSER.TEST.KSDS1',FORMAT=HEX,KEY=000100,NLRECS=20"
```

Within a REXX procedure, all profile settings are taken from the installation defaults. For details on changing File Manager default profile settings, see *File Manager for z/OS Customization Guide*.

Example

The following example shows a REXX procedure that uses File Manager functions.

Figure 143. Example REXX procedure using File Manager functions

```

/* REXX */
/* *****/
/* Example: Execute File Manager functions from REXX */
/* *****/
parse upper source environment.
/* List the catalog entries on the printout */
FILEMGR "$SCS FUNCTION=PRINT" /* call SCS for the master catalog */
say "SCS return code:" RC
/* Provided the installation default for PRINTOUT is PRINTOUT=REXX */
/* then commands from this platform will be directed to the stem */
/* variable FILEM. */
filem.0=0 /* discard any previous output */
/* call SCS for a user catalog */
FILEMGR "$SCS CATALOG='CATALOG.PRODUCTS.UCAT',DSNAME='ADSM.**'," ,
"FUNCTION=PRINT, SORTBY=DATE"
say "SCS return code:" RC
/* Display the FILEM.n variable contents */
SAY ">>> SCS output:"
DO i=1 to filem.0 /* process all printed lines */
SAY filem.i /* display the printline */
END

```

Invoking File Manager panels from REXX procedures or TSO clists

You can directly invoke File Manager panels from any REXX procedure or TSO clist (or ISPF Command line).

For example, from any ISPF Command line, enter the following command to display the File Manager Print Utility (option 3.2) panel:

```
FILEMGR DSP
```

(that is, as if you were calling the function, but with no \$ before the function name and no parameters following it, except for DSB, DSE, and DSV as described below)



Note: Except for View (option 1) and Edit (option 2), you cannot specify any parameters when you use this method to invoke a panel. If you specify a valid data set name after DSB, DSE, or DSV then you bypass the entry panel (where you would normally specify the data set name), and go directly to viewing or editing the specified data set.

For a complete list of the equivalent function names you can use to invoke File Manager panels, see [Summary of File Manager panels on page 717](#).

Invoking File Manager functions from a REXX procedure or CLIST in /BATCH mode

Some functions which do not require user interaction (such as DSC, DSP, DVT, FCH, and SCS) and are otherwise available for JCL batch processing can also be invoked from a REXX program under TSO/ISPF in a “pseudo-batch” mode.

This mode can be achieved by specifying a /BATCH parameter on File Manager invocation. When specified, it forces batch-type processing while executing under TSO/ISPF.

Before invoking the program you must allocate all the required data sets, including SYSIN and SYSPRINT. By default, report output is written to SYSPRINT. Sections of the output can be directed instead to the following ddnames:

FMNROPT

File Manager active options

FMNRPRM

\$\$\$FILEM command parameters and return codes

FMNRPRC

REXX procedure statements read from SYSIN

FMNREPT

Command reports and return codes

FMNRSUM

TALLY summary report

If FMNPRINT is present in the JCL, it is used instead of SYSPRINT. If FMNIN is present in the JCL, it is used instead of SYSIN.

The following shows a sample program invocation from a REXX program using the /BATCH parameter:

```
/* rexx */
"ALLOC DD(SYSPRINT) NEW LRECL(132) RECFM(F B) DSORG(PS) REUSE SPACE(1 1) CYL"
"ALLOC DD(DDIN) DA('TEST.PDS') SHR REU"
"ALLOC DD(SYSIN) NEW LRECL(80) RECFM(F B) DSORG(PS) REUSE SPACE(1) TRA"
PARM.0 = 3;
PARM.1 = "$$FILEM SET HEADERPG=NO"
PARM.2 = "$$FILEM FCH MEMBER=* INPUT=DDIN "
PARM.3 = "C '12AFSDF' '2ASDFSDF'"
"EXECIO * DISKW SYSIN (STEM PARM. FINIS"
"CALL *(FMNMAIN) '/BATCH'"
/* or "FILEMGR '/BATCH'" */
SAY RC
"EXECIO * DISKR SYSPRINT (STEM SP. FINIS"
DO I = 1 TO SP.0
SAY SP.I
END
"FREE DD(DDIN SYSIN SYSPRINT)"
```

Using File Manager functions in batch jobs

You can perform file management tasks by calling File Manager functions from a batch job.

Edit models are provided that insert predefined statements and instructions for a selected File Manager function or REXX external function.

JCL syntax for File Manager batch jobs

To use a File Manager function in a batch job, include the following statement: `//stepname EXEC PGM=FILEMGR`

By default, report output is written to SYSPRINT. Sections of the output can be directed instead to the following ddnames:

FMNROPT

File Manager active options

FMNRPRM

\$\$FILEM command parameters and return codes

FMNRPRC

REXX procedure statements read from SYSIN

FMNREPT

Command reports and return codes

FMNRSUM

TALLY summary report

If FMNPRINT is present in the JCL, it is used instead of SYSPRINT. If FMNIN is present in the JCL, it is used instead of SYSIN.

You might also need a STEPLIB statement or other DD statements, depending on which File Manager functions the batch job contains.

When you code File Manager control statements, you must:

- Begin each control statement with `$$FILEM` in columns 1 to 7, followed by a blank in column 8, followed by the command name, followed by the first parameter (if any).
- Specify parameters and their values separated by an equal sign, as follows:

```
PARAMETER=value
```

- Follow each parameter (except the last one) immediately with a comma.

Comment statements, which begin with an asterisk (*), are also allowed.

To continue a control statement onto the next line, end the first line with a comma and begin the next line with `$$FILEM` and a blank.

To continue a parameter that does not fit onto one line, do not use a continuation character. Instead, split the parameter into more than one line, enclosing each part in apostrophes. For example:

```
$$FILEM DSNIN='u/test/this is a regular HFS file ',
$$FILEM 'that has a v',
$$FILEM 'ery long name'
```

**Notes:**



1. If the control statement contains only the function name, there must be a space between the function name and the comma.
2. To continue FIND and CHANGE commands in the FCH (Find/Change) utility, end the first line with a comma (the continuation line does not contain \$\$FILEM).
3. To change processing options in batch or to reset options to the installation default, use the SET function.

Example

Example

In HEX format, the following example shows a batch job that uses the DSP File Manager function to print 20 records of a data set (starting at the record with key value 0001000):

```
//jobcard
//ABC EXEC PGM=FILEMGR
//SYSPRINT DD SYSOUT=*
//SYSIN DD *
$$FILEM DSP DSNIN='FMUSER.TEST.KSDS1',
$$FILEM FORMAT=HEX,KEY=000100,NLRECS=20
/*
```

Using File Manager edit models

This topic explains how to use edit models to create batch JCL to access File Manager functions.

The ISPF environment of your site must be configured to enable access to the File Manager edit models. See *"Implementing File Manager edit models in ISPF Edit"* in the *File Manager for z/OS Customization Guide*.

Edit models

An ISPF edit model is a predefined set of statements. You can include these statements in a member that you are editing and then modify them to suit your needs. Along with the edit models that are shipped with ISPF, File Manager includes edit models for the File Manager Base component, FM/Db2, and FM/IMS functions and REXX external functions.

An edit model has two parts:

Data lines

These are the actual lines that are placed in the data you are editing. In the File Manager ISPF models the data lines describe the format of function parameters.

Notes

Notes provide tutorial information about the function parameters. These describe how to update the data lines to your requirements.

When you enter the MODEL command, you can select the File Manager function for the data type (JCL or EXEC) of the member that is being edited.

Using edit models

If you edit a member of a data set of type JCL or EXEC and then issue the MODEL command, a list of applicable File Manager functions or REXX external functions is displayed.

JCL

The **File Manager Models** panel lists the available edit models, grouped by category.

You can enter RF to display another panel which lists the available edit models for REXX external functions.

EXEC

The **REXX Models** panel is displayed.

Enter FF to display the **File Manager REXX Function Models** panel, which lists the available edit models for REXX external functions.

Enter the function name to insert the statements from that edit model in the edit session. For example, enter DSEB to insert the Batch Edit model. Use the A (after) or B (before) line command to insert the statements at a specific location.

Issue the RESET command to permanently remove the note lines, leaving only the data lines.

Edit model example: JCL that calls the DSC function

This example shows how to use edit models to generate a batch job to copy a data set using the DSC function.

1. Select option 2 from the ISPF Primary Option Menu.
2. In the **Edit Entry Panel**, enter the name of a new member in a data set of type "JCL". Example:

```
Data Set Name . . . 'EXAMPLE.JCL(newdscx)'
```

3. In the edit session, enter the MODEL primary command.

```

File Edit Edit_Settings Menu Utilities Compilers Test Help
-----
EDIT          EXAMPLE.JCL(NEWDSCX) - 01.00          Columns 00001 00072
Command ==> model                               Scroll ==> CSR
***** ***** Top of Data *****
!!!!!!
!!!!!!

```

The **File Manager Models** panel lists the available edit models in the JCL class.

```

                                File Manager Models
Option ==> jb
-----
Enter number or service name (RF for External Rexx Functions)
Enter END command to cancel MODEL command.

FM/BASE
AUD Audit Base/Db2/IMS
CLM Load Module compare
DSB Resource Browse
DSC Resource Copy
DSE Resource Edit
DSEB Batch Edit
DSM Compare
DSG Generate
DSP Print
DSU Resource Update
DSV Resource view
FCH Find/Change
NSRT NOSORT (no DFSORT)
PBK Print Copybooks
SET Set options
SETRC Set Return code
VER Version information
VLM View load Module

Base Templates
BTB Batch Template Build
BTU Batch Template Update
TPIM Template Import
TPXP Template Export

Db2 Templates
D2TP DB2 Template Crt/Upd

IMS Templates
ICU IMS Criteria Update
ITU IMS Template Update
IVU IMS View Update

Data set functions
DSFA Data Set Alter
DSFC Data Set Allocate
DSFD Data Set Delete
DSFR Data Set Rename

Db2 functions
BSQL Batch SQL
DBC Batch Db2 Copy
DBI Batch Db2 Import
DBP Batch Db2 Print
DBX Batch Db2 Export
D2G Db2 Data Generation

IMS functions
DBI IMS Initialization
IBB IMS Batch Browse
IEB IMS Batch Edit
ILB IMS Load
IPR IMS Print
IXB IMS Extract

File Manager JCL
JB FM/Base JCL
JD FM/Db2 JCL
JI FM/IMS JCL

F1=Help F3=Exit F12=Cancel
    
```

4. Enter JB.

The edit model for the File Manager Base component JCL is copied into the edit session.

```

File Edit Edit_Settings Menu Utilities Compilers Test Help
-----
EDIT          EXAMPLE.JCL(NEWDSGX) - 01.00          Columns 00001 00072
Command ==>                                     Scroll ==> CSR
***** ***** Top of Data *****
=NOTE= -----
=NOTE= --
=NOTE= -- BASE JCL
=NOTE= --
=NOTE= -----
000001 //FILEMGR EXEC PGM=FILEMGR
000002 //STEPLIB DD DSN=FMN.SFMNMOD1,DISP=SHR
=NOTE= If using WMQ queues via batch, uncomment and update MQHLQ to suit
=NOTE= your sites WMQ high level qualifier
=NOTE= DD DSN=MQHLQ.SCSQLOAD,DISP=SHR
=NOTE= DD DSN=MQHLQ.SCSQANLE,DISP=SHR
=NOTE= DD DSN=MQHLQ.SCSQAUTH,DISP=SHR
=NOTE= If referring to CICS resources uncomment and update CICS HLQ to suit
=NOTE= your sites CICS high level qualifier
=NOTE= DD DSN=CICSHLQ.SDFHEXCI,DISP=SHR
=NOTE= Uncomment and update IGY if you need the COBOL compiler in STEPLIB
=NOTE= DD DSN=IGY.SIGYCOMP,DISP=SHR
=NOTE= //FMNCOB DD DUMMY Include to force use of FM COBOL Compiler
=NOTE= //FMNCLERR DD SYSOUT=* Include to force output of Compiler listing
000003 //FMNFRPT DD SYSOUT=*
000004 //SYSTSPRT DD SYSOUT=*
:
    
```

Notes are identified by the characters =NOTE= in the line command field. The notes contain information to help in modifying the JCL statements and parameters.

5. Issue the RESET command to permanently remove the note lines, leaving only the data lines.
6. Overtyping line 000013 with the A line command and then enter the MODEL primary command.

```

File Edit Edit_Settings Menu Utilities Compilers Test Help
EDIT          EXAMPLE.JCL(NEWDSCX) - 01.00          Columns 00001 00072
Command ==> model          Scroll ==> CSR
***** ***** Top of Data *****
000001 //FILEMGR EXEC PGM=FMNMAIN
000002 //STEPLIB DD DSN=FMN.SFMNMOD1,DISP=SHR
000003 //FMNFRPT DD SYSOUT=*
000004 //SYSTSPRT DD SYSOUT=*
000005 //SYSTSIN DD *
000006 //SYSPRINT DD SYSOUT=*
000007 //SYSOUT DD SYSOUT=*
000008 //FMNTSPRT DD SYSOUT=*
000009 //SYSTEM DD SYSOUT=*
000010 //FMNODPP DD DISP=SHR,DSN=OPTIM.ODPP.SAMPLIB(ENVVARS)
000011 //FMNAUTH DD DISP=SHR,DSN=fmn.auth.dsn
000012 //FMNEXEC DD DISP=SHR,DSN=fmn.exec.library
a //SYSIN DD *
***** ***** Bottom of Data *****

```

7. Enter DSC.

The edit model for the data set Resource Copy function is copied into the edit session.

```

File Edit Edit_Settings Menu Utilities Compilers Test Help
EDIT          EXAMPLE.JCL(NEWDSCX) - 01.00          Columns 00001 00072
Command ==>          Scroll ==> CSR
***** ***** Top of Data *****
000001 //FILEMGR EXEC PGM=FMNMAIN
000002 //STEPLIB DD DSN=FMN.SFMNMOD1,DISP=SHR
000003 //FMNFRPT DD SYSOUT=*
000004 //SYSTSPRT DD SYSOUT=*
000005 //SYSTSIN DD *
000006 //SYSPRINT DD SYSOUT=*
000007 //SYSOUT DD SYSOUT=*
000008 //FMNTSPRT DD SYSOUT=*
000009 //SYSTEM DD SYSOUT=*
000010 //FMNODPP DD DISP=SHR,DSN=OPTIM.ODPP.SAMPLIB(ENVVARS)
000011 //FMNAUTH DD DISP=SHR,DSN=fmn.auth.dsn
000012 //FMNEXEC DD DISP=SHR,DSN=fmn.exec.library
000013 //SYSIN DD *
=NOTE= The following are main parameters that will be used for Data Set Copy
000014 $$FILEM DSC ,
=NOTE= *****
=NOTE= **
=NOTE= ** Main DSC parameters input/output resources **
=NOTE= **
=NOTE= *****
000015 $$FILEM DSNIN=dsname,
=NOTE= DSNIN=dsname
=NOTE= Defines the name of the From data set or an absolute path to the
:

```

8. Once again, issue the RESET command to remove the note lines.

```

File Edit Edit_Settings Menu Utilities Compilers Test Help
-----
EDIT          EXAMPLE.JCL(NEWDSCX) - 01.00          Columns 00001 00072
Command ==>                                     Scroll ==> CSR
***** ***** Top of Data *****
000001 //FILEMGR EXEC PGM=FMNMAIN
000002 //STEPLIB DD DSN=FMN.SFMNMOD1,DISP=SHR
000003 //FMNFRPT DD SYSOUT=*
000004 //SYSTSPRT DD SYSOUT=*
000005 //SYSTSIN DD *
000006 //SYSPRINT DD SYSOUT=*
000007 //SYSOUT DD SYSOUT=*
000008 //FMNTSPRT DD SYSOUT=*
000009 //SYSTEM DD SYSOUT=*
000010 //FMNODPP DD DISP=SHR,DSN=OPTIM.ODPP.SAMPLIB(ENVVARS)
000011 //FMNAUTH DD DISP=SHR,DSN=fmn.auth.dsn
000012 //FMNEXEC DD DISP=SHR,DSN=fmn.exec.library
000013 //SYSIN DD *
000014 $$FILEM DSC ,
000015 $$FILEM DSNIN=dsname,
000016 $$FILEM INPUT=ddname,
000017 $$FILEM VOLSERIN=volser,
000018 $$FILEM MEMBER=member1,
000019 $$FILEM DSNOUT=dsname,
:

```

You now have a JCL member that can be used to copy a data set using the File Manager DSC function.

Destination of File Manager print output

Any File Manager print output that you produce in a batch job is sent to SYSPRINT by default.

Sections of the output can be directed instead to the following ddnames:

FMNROPT

File Manager active options

FMNRPRM

\$\$FILEM command parameters and return codes

FMNRPRC

REXX procedure statements read from SYSIN

FMNREPT

Command reports and return codes

FMNRSUM

TALLY summary report

If FMNPRINT is present in the JCL, it is used instead of SYSPRINT.

In a REXX procedure, the destination for File Manager print output depends on the value of the PRINTOUT parameter of the SET function:

SYSPRINT

Output is sent to the current SYSPRINT allocation.

SYSOUT=c

Output is accumulated in the data set specified by the PRINTDSN parameter of the SET function.

To browse your print output online, use Print Browse (option 3.9). This option is a shortcut to browsing the data set specified by the PRINTDSN parameter. To go to the Print Browse panel directly from any other File Manager panel, enter `PB` on the Command line. For information about using the Print Browse panel, see [Printing from File Manager on page 402](#).

TERMINAL

Output is sent to the terminal.

REXX

Output is written to a REXX stem variable. Each line of output corresponds to a variable named FILEM.*nnn*. FILEM.0 contains a line count.

After your first printing operation, lines of output are written in variables FILEM.1 to FILEM.*n*, and FILEM.0 has the value *n*. The next printing operation begins with FILEM.*n+1*.

Handling errors

File Manager sets the following return codes:

0

All File Manager functions processed successfully.

16

File Manager terminated because of an error. File Manager or system messages identify the error. For more information about File Manager messages, see [Messages on page 1717](#).

>100

Not enough storage to load File Manager.

If an error is detected, File Manager issues an error message and terminates. If an error causes the system to cancel a File Manager function (for example, a file open error), File Manager tries to recover from the cancel condition and close any files left open before it terminates.

Some File Manager functions have their own return codes. If you receive a return code that is not listed above, refer to the description of the function in [Functions on page 1241](#).

**Notes:**

1. In addition to the return codes provided by File Manager, you can create your own return codes during the installation and customization of the product. These customized codes take precedence over any default File Manager return codes. The functions that can have customized return codes are:
 - CLM (Load Module Compare)
 - DSC (Data Set Copy)



- DSEB (Data Set Edit Batch)
- DSG (Data Set Generate)
- DSM (Data Set Compare)
- DSP (Data Set Print)
- DSU (Data Set Update)
- DVT (Display VTOC)
- FCH (Find/Change)

If you receive return codes that do not match the ones described here or in the Function Reference chapter, they might have been customized for your site. Contact your File Manager systems administrator for information.

2. In batch, you may want to transform an original or customized non-zero return code to an abend (Abend 999, Reason Code=888 (hex: 378)). It could also be forced by installation at your site. Abnormal termination of a File Manager step prevents execution of successors (steps or jobs). Check the ABENDCC option of the SET command, or contact your File Manager system administrator for details.

Chapter 14. Enhancing File Manager processing

You can enhance normal processing of a number of File Manager tasks by supplying a procedure that runs in conjunction with the File Manager process.

The procedure can comprise DFSORT™ statements, REXX statements, or a combination of both. There is a File Manager subset of the REXX language, called FASTREXX, that File Manager processes internally with high performance.

Why enhance File Manager processing?

Enhanced processing allows end users to easily perform tasks that would otherwise need to be done by skilled application programmers, and to concentrate on business results rather than data processing problems.

The main benefit of using File Manager enhanced processing is that File Manager performs all data set input and output (I/O) operations for you, allowing you to concentrate on what you want to do with each data record. You can write record-handling instructions that are independent of the data file organization, without the need to write “*peripheral*” code for such things as I/O and error handling. This can greatly improve your productivity. Typically, when you use enhanced processing, you write small, easy-to-maintain “*programs*” that allow you to focus on the business task rather than on data processing tasks. You simply choose which File Manager utility to enhance, and then specify the processing that is desired for each record or library member.

Which tasks can be enhanced

You can supply a procedure with DFSORT or REXX statements to enhance normal File Manager processing according to your own requirements.

Table 11. Situations in which you can supply an enhanced procedure

When performing this task...	REXX	DFSORT
Copying data with the Copy Utility (option 3.3) or DSC function	✓	✓ ¹
Editing a data set with the DSEB function (not available in panels) ²	✓	
Printing data with the Print Utility (option 3.2) or DSP function	✓	✓ ¹
Updating records in a data set with the DSU function (not available in panels) ²	✓	
Finding or changing data with the Find/Change Utility (option 3.6) or FCH function	✓	

Choosing the right function to enhance

With enhanced processing it can be unclear which function or panel to invoke for a particular task, and what combination of template, DFSORT and REXX (or FASTREXX) processing is best to use.

1. DFSORT cannot be used on a PDS or PDSE.
2. You *must* supply REXX statements with the DSEB and DSU functions. In other situations, this is optional.

Typically, you get the best performance by using the function or panel that requires the least enhancement to perform the task, and by using the best-performing enhancement technique that can provide the desired result.

For more information about performance considerations, see [Choosing between FASTREXX, REXX, and DFSORT for your procedure on page 521](#).

DSC function or Copy Utility (option 3.3)

First, consider whether you can perform the copying task by enhancing the function or panel with FASTREXX or DFSORT statements in a procedure. A task performed with only FASTREXX or DFSORT uses far less system resources than the equivalent task performed with REXX or template processing that requires REXX.

If neither FASTREXX nor DFSORT is suitable for the copying task, before resorting to using REXX, consider whether the task can be performed with template processing that does not require REXX. You can also use template processing for selecting, reformatting, and initializing records, and it uses less system resources than the equivalent task performed with REXX in a procedure. If you are using templates for record selection, try to code selection expressions that exploit the power of the File Manager internal expression processor, avoiding the need to invoke REXX to process the expressions (see [About expression processing on page 295](#)).

DSP function or Print Utility (option 3.2)

As with copying, you can use FASTREXX or DFSORT procedures or templates to help perform complex printing tasks without the overhead of external REXX processing. Using FASTREXX, DFSORT, or a template, you can specify complex criteria to select only certain records, and which fields from those records to print.

In some cases, you might want to use DSC or the Copy Utility (option 3.3) to reformat the fields in a data set and copy the reformatted fields to a new data set, before using DSP or the Print Utility (option 3.2) to print the new data set.

DSEB function (not available in panels)

DSEB is the only function where you can move forwards and backwards through the records in a data set, rather than dealing with each record independently, in sequence. Use DSEB when you need to compare values in different records, or where you need the flexibility to scroll or search forwards or backwards through a data set. Note that DSEB only lets you *"edit in place"*; You cannot insert or delete a record or change a record's length.

DSEB has no default action of its own, such as printing or copying; you must supply a procedure containing REXX statements to perform whatever actions you require.

Before you decide to use DSEB, consider whether you can use DSU. DSU is faster than DSEB, especially with FASTREXX.



Note: FASTREXX processing is not supported for the DSEB function.

DSU function (not available in panels)

DSU is a general-purpose function for working with each record in a data set independently, in sequence. DSU is the same as the FCH function or the Find/Change Utility (option 3.6), except that DSU does not produce a report. Use DSU when you want to examine and potentially update each record, without needing to move backwards through the records or compare values of different records. However, before you decide to use DSU, consider whether you can use a combination of the primary commands available with the FCH function and the Find/Change Utility.

DSU only lets you “*edit in place*”. That is, you cannot insert or delete a record, or change a record's length.

DSU has no default action of its own, such as printing or copying; you must supply a procedure containing REXX statements to perform whatever actions you require.

FCH function or Find/Change Utility (option 3.6)

When using this function or panel, you can either supply a procedure containing REXX statements (as described in this chapter), or a sequence of primary commands (such as FIND and CHANGE; for details, see [Finding and changing data in multiple PDS members on page 368](#) and [FCH \(Find/Change\) on page 1503](#)). For better performance, use the primary commands instead of a REXX procedure wherever possible.

Creating and supplying a procedure

Your procedure, containing DFSORT or REXX statements or a combination of all of these, can be supplied as:

- A temporary procedure, created as you process a relevant File Manager panel, or invoke a relevant File Manager function from a REXX program;
- A saved procedure, nominated as you process a relevant File Manager panel or invoke a relevant File Manager function in batch or from a REXX program; or
- An inline procedure, nested in a batch job stream, that invokes a relevant File Manager function.

Saved procedures must reside in a member of a fixed or variable format PDS. The record length of the data set is unrestricted, but must be at least large enough for complete tokens to be entered, with consideration given to the statement continuation requirements of DFSORT (as processed by File Manager, see below) and REXX. A record length of 80 meets these requirements comfortably. With this length, procedure statements can be copied into a temporary Edit session without truncation or used as an inline procedure in a JCL Edit session.

Whether a procedure is entered at the terminal, saved in a PDS, or supplied as an inline procedure in JCL, it must follow the rules described below for File Manager procedures, as well as the specific rules for DFSORT and REXX statements defined by the DFSORT and REXX products.

Procedure statement types

File Manager supports two types of procedure statements, that you can use to enhance the File Manager functions. These are:

- **A subset of DFSORT statements**

DFSORT is IBM's sort, merge, copy, analysis and reporting product. File Manager can exploit DFSORT's high-performance copy option for the DSC and DSP functions. (To configure File Manager to work with DFSORT, refer to the *File Manager for z/OS Customization Guide*.)

If the data to be processed is suitable, you can enhance the File Manager print and copy actions by supplying a procedure containing statements from the subset of the applicable DFSORT statements supported by File Manager, instead of using equivalent REXX statements.

If DFSORT is available, the input data set is not partitioned and the record format is not undefined, File Manager automatically uses the DFSORT COPY option to perform simple data set to data set copy and print actions. You can enhance this processing by supplying a procedure containing DFSORT statements.



Note:

1. File Manager does not use DFSORT COPY if the input data set is VSAM, unless there are DFSORT commands in the procedure.
2. You cannot use DFSORT on a PDS or PDSE.

- **REXX programming statements**

REXX is a general purpose programming language similar to PL/I. It includes extensive parsing capabilities for character manipulation, extensive mathematical capabilities, and many built-in functions that perform processing, searching, and comparison tasks.

REXX statements can be processed one at a time by the REXX interpreter or translated into another form for execution (compiled) like a traditional programming language. The initial overhead of compilation usually results in faster execution than interpretation when a large number of records is being processed. In either case, File Manager is able to exploit the power of REXX when processing REXX statements in a procedure.

FASTREXX

For a restricted set of REXX statements, File Manager can process the procedure internally, saving the overhead of invoking REXX, and generally resulting in faster processing of the procedure. Within File Manager, this subset of statements is referred to as FASTREXX.

For the procedure to be executed as FASTREXX, every statement in it must be in the FASTREXX subset, otherwise the whole procedure is executed as REXX.

If the procedure is not eligible for internal processing, it is either run by invoking REXX, or the File Manager function invoking the procedure is terminated, depending on the use of the *REXXPROC and *FASTREXX statements in the procedure.

Choosing between FASTREXX, REXX, and DFSORT for your procedure

In general, FASTREXX is the best compromise between performance and function.

FASTREXX is somewhat more CPU-intensive than DFSORT, but much less so than REXX. It has easier syntax than DFSORT, requires only one language to be learned, and has more function and flexibility than DFSORT, with performance that is close to that of DFSORT. Be aware though that FASTREXX is a subset of REXX and can degrade into REXX, which is the slowest (but most flexible) of the three procedure languages.

REXX is a complete programming language. As such, it is more flexible, but uses significantly more CPU than DFSORT and FASTREXX. There is a *“Compiler and Library for REXX on zSeries”* product which can be purchased and used by (among others) File Manager. However, while compiled REXX is definitely more CPU-efficient than ordinary REXX, FASTREXX uses significantly less CPU than compiled REXX.

DFSORT is slightly more CPU-efficient than FASTREXX. However, using DFSORT does have some drawbacks:

- You must use an additional language (DFSORT control statements).
- File Manager only uses DFSORT when the data is in sequential files, or on VSAM files if there are DFSORT statements in the procedure. File Manager does not use DFSORT when the data is in a PDS or PDSE or an MQ queue.

You should only use DFSORT for jobs where performance is critical.



DFSORT licensing and installation:

1. To use DFSORT for I/O or as your procedure language, DFSORT must be installed so that File Manager can use it. DFSORT is an optional, priced feature of z/OS®. Ordinary users cannot use DFSORT unless the site has a license for it. However, there is an installation procedure which allows File Manager to use DFSORT even if your site does not have a DFSORT license.
2. File Manager uses DFSORT for I/O processing whenever possible. Therefore, regardless of which user procedure language you choose to use, File Manager should be enabled to use DFSORT.

Should you combine DFSORT with REXX or FASTREXX processing? If you can do this in such a way as to optimize performance (using careful measurement), the answer may be yes. However, it comes at the cost of an increase in complexity in writing, maintaining, and debugging the user procedure. The guideline of keeping things simple strongly favors using FASTREXX.

Coding DFSORT procedure statements

If you want to use DFSORT statements in a procedure, then the first line in the procedure must contain the string `*FASTPROC` coded in column one. You must then code your DFSORT statements in the subsequent lines, prior to any REXX statements. DFSORT statements are coded in columns 1-71.

File Manager supports only the following DFSORT statements:

- INCLUDE/OMIT
- INREC
- OUTREC
- OUTFIL

No other DFSORT statements are supported, except that DFSORT format comment statements can be interspersed with the DFSORT statements. These statements have an asterisk (*) in column 1; they are ignored by File Manager and are not listed in any output.

You can use the DFSORT INCLUDE and OMIT statements to conditionally select records, INREC and OUTREC statements to reformat data, and OUTFIL statements to write to data sets in addition to the primary output data set. This eliminates the need for REXX processing in many basic scenarios.

The DFSORT statements and the output from DFSORT are only displayed if an error is detected. However, if a listing of the DFSORT control statements and output are especially required, the following File Manager control statement can be used in a batch job:

```
$$FILEM SHOWSORT
```

This must be placed as the first File Manager control statement. The output is written to the SYSPRINT data set.

For general information about writing DFSORT statements and for the details of DFSORT statement syntax, see the *DFSORT Application Programming Guide*.

Pay particular attention to the following points:

DFSORT labels

DFSORT syntax allows a statement label to be coded in column one. This means that operation keywords (such as INCLUDE) must not begin before column two.

DFSORT keywords

DFSORT keywords must be coded in upper case.

Statement continuation

Statements ending with a comma or semicolon are concatenated with the next statement at the first non-blank character.

Statements with a non-blank character in column 72 are concatenated with the next statement. All blanks up to and including column 71 are included in the concatenated statement.



Note: These continuation rules are specific to File Manager, and are a little different from the standard DFSORT statement continuation rules. If you are using DFSORT statements coded for use with the DFSORT product, you might need to modify them to use them in a File Manager procedure.

Specifying data positions in variable-length records

Data positions in DFSORT control statements that refer to variable-length records must allow four extra bytes for the record descriptor word (RDW) preceding the data. For example, the following INCLUDE statement for a fixed-length record:

```
INCLUDE COND=(1,2,CH,EQ,'01')
```

becomes:

```
INCLUDE COND=(5,2,CH,EQ,'01')
```

for a variable-length record.

When File Manager uses DFSORT to process records, all VSAM data sets, except for fixed-length relative record data sets (RRDS's), are treated as variable-length. Non-VSAM data sets are treated as fixed or variable-length, according to the data set specifications.

Using OUTFIL statements

When using OUTFIL statements to write multiple output files, direct one of them to the same file as the File Manager output so any data not needed for the OUTFIL data sets is discarded (see [Copying data on page 539](#) for an example).

The following examples demonstrate some simple DFSORT statements.

Example 1

To include all records where columns 1-4 contain the name FRED.

```
*FASTPROC
INCLUDE COND=(1,4,CH,EQ,C'FRED')
```

Example 2

To process only those records where columns 1-80 are not all blank.

```
*FASTPROC
OMIT COND=(1,80,CH,EQ,C'
col 72
X
')
```

Coding REXX procedure statements

File Manager has no special syntactical requirements for REXX statements coded in procedures, except when combining REXX statements with DFSORT statements (see [Combining DFSORT and REXX statements in a procedure on page 529](#)), or when invoking FASTREXX processing. In addition to the standard REXX statements, File Manager introduces several new REXX variables and functions that you can use to enhance File Manager processing.

For general information about writing REXX, see the *z/OS TSO/E REXX Reference*. For information about the REXX variables, see [How REXX-enhanced processing works on page 533](#). For information about the additional REXX functions, see [External REXX functions on page 1624](#).



Note: Users familiar with REXX in the z/OS® environment might be accustomed to coding a comment containing the word “REXX” at the start of their REXX programs to enable them to run from the SYSPROC DD data set concatenation. This special comment is *not* required in File Manager procedures.

The following examples demonstrate some simple REXX statements.



Note: REXX is case-insensitive when processing REXX keywords and function and variable names. The use of upper and mixed case in these examples is purely stylistic.

REXX example 1

To change all records into upper case:

```
Upper OUTREC
```

REXX example 2

To reformat text so that it is justified to the left and right margins:

```
OUTREC = Justify(OUTREC,Length(OUTREC))
```

REXX example 3

This example invokes the CHANGE function provided by File Manager to change the first occurrence of a pair of slash characters (/) to a pair of question marks (?), but only if the first two characters of the record contain '01'. Otherwise, it changes the first pair of slashes to exclamation marks (!):

```
If Substr(INREC,1,2) == '01' Then
  OUTREC = Change(OUTREC,'//','??')
Else
  OUTREC = Change(OUTREC,'//','!!')
```



Note: This example can be coded more efficiently in FASTREXX. See [FASTREXX example 3 on page 527](#).

Using internal (FASTREXX) processing

File Manager attempts to use FASTREXX or REXX processing, depending upon the first *REXXPROC or *FASTREXX statement found in the procedure.

If no *REXXPROC or *FASTREXX statement is found, the REXX statements are processed as if they were preceded by a *REXXPROC statement.



Note:



1. FASTREXX processing is supported for the DSEB function as long as it adheres to the following rules.
2. Default length for packed fields: If you omit the length for a function that refers to a packed field processing, the length is re-calculated for each record processed.

***REXXPROC**

The *REXXPROC statement indicates that the subsequent procedure statements are REXX statements (separating them from any preceding DFSORT statements). The statements are processed internally (using FASTREXX) if possible. If FASTREXX processing is not possible, the REXX statements are processed by invoking REXX.

***FASTREXX (ON)**

The *FASTREXX (or *FASTREXX ON) statement indicates that the subsequent procedure statements are REXX statements (separating them from any preceding DFSORT statements), and should be processed internally if possible. If FASTREXX processing is not possible, the File Manager function terminates, indicating FASTREXX processing was not possible.

***FASTREXX OFF**

The *FASTREXX OFF statement indicates that the subsequent procedure statements are REXX statements (separating them from any preceding DFSORT statements), and should be processed by invoking REXX.

***FASTREXX CHECK**

The *FASTREXX CHECK statement indicates that the subsequent procedure statements are REXX statements (separating them from any preceding DFSORT statements), and should be processed by invoking REXX. However, File Manager indicates whether FASTREXX processing was possible for the procedure.

***FASTREXX NORUN**

The *FASTREXX NORUN statement indicates that the subsequent procedure statements are REXX statements (separating them from any preceding DFSORT statements), and should be checked to determine whether FASTREXX processing is possible for the procedure. The File Manager function does not run, but File Manager indicates whether FASTREXX processing is possible for the procedure.

For a procedure to be eligible for FASTREXX processing, it must consist only of:

- Null clauses. Null clauses consist only of blanks or comments. They are ignored when REXX statements are processed internally.
- DO-END, DO WHILE-END, DO UNTIL-END, DO FOREVER-END ITERATE LEAVE
- SELECT-WHEN-OTHERWISE-END clauses
- LABEL and SIGNAL label clause support
- IF-THEN-ELSE instruction clauses whose condition expressions are valid for internal processing. These clauses are supported if the condition expression is valid for internal processing, and the THEN and ELSE clauses are also valid for internal processing. The following functions can be included in an expression that is to be processed internally:
 - CMP_DATE
 - CMP_TIME

- FLD
- FLD_CO
- FLD_TM
- FLD_TYPE
- I_LENGTH
- O_LENGTH
- PRTCOUNT
- RECSIN
- RECSOUT
- RECCUR
- TFLD
- FLDI
- FLDO
- TESTC
- TESTN
- DOWN
- UP
- FINDNEXT
- FINDPREV

Refer to [About expression processing on page 295](#) for more information about the eligibility of condition expressions for internal processing.

- NOP instruction clauses (these are ignored).
- RETURN instruction clauses.
- Command clauses consisting only of an invocation of one of a limited set of functions. These are:
 - CHG_OUT
 - CHG_VAR
 - FLD_OUT
 - VAR_OUT
 - OVLY_OUT
 - OVLY_VAR
 - PRT_IN
 - PRT_OUT
 - PRT_VAR
 - SET_OLEN
 - TALLY
 - WRITE
 - SETC
 - SETN
 - TOP
 - BOT
 - DOWN

- UP
- RECCUR
- FINDPREV
- FINDNEXT
- UPDATE

The function performs the requested action, and returns a single blank as the command, which is ignored by the File Manager host command environment.

To be eligible for internal (FASTREXX) processing, all of the arguments passed to a command function must be literals or unassigned symbols. Specifically:

- Nested function invocations are not supported.
- Field reference symbols (#ref) are not supported.
- Assignment clauses are not supported.
- Label clauses are not supported.
- The following symbols are not supported, as they involve implicit assignment:
 - INREC and OUTREC

(Instead, you must use the set of functions that act directly on the input and output record.

-)
- RC
- RESULT
- SIGL

The following examples illustrate some simple FASTREXX-eligible statements:

FASTREXX example 1

To change the first byte in every record to a blank:

```
OVLV_OUT(' ',1,1)
```

FASTREXX example 2

To pad every record to a length of 100 with blanks (records longer than 100 bytes would remain unchanged):

```
OVLV_OUT(' ',1,100,'C',' ')
FLD_OUT(1,,1)
```

FASTREXX example 3

This example invokes the CHG_OUT function provided by File Manager to change the first occurrence of a pair of slash characters (/) to a pair of question marks (?), but only if the first two characters of the record contain '01'. Otherwise, it changes the first pair of slashes to exclamation marks(!):

```
If FLD(1,2) == '01' Then
  CHG_OUT('//','??')
Else
  CHG_OUT('//','!!')
```

REXX coding hints and tips

Use “*strict comparison*” for strings, rather than using REXX's looser comparison.

REXX draws a very important distinction between using “=” for an equality test and using “==”. (Similar comments also apply to < and <<, and other operators, but the most important issue is equality testing.)

When you use “==”, REXX treats the arguments as strings and compares the arguments unchanged. However, when you use “=”, REXX attempts to transform the arguments prior making the comparison. REXX first tries to convert both arguments to numeric values; if this fails, it treats the arguments as strings, stripping leading and trailing blanks and then, if the resulting strings are of unequal length, padding the shorter string on the right with blanks.

For File Manager REXX programming, a good practise is to use “==” for all string comparisons, and to use “=” only with care for numeric comparisons.

When you use the strict equality operator (“==”), you must pad literals with blanks as required. For example, if the first 10 bytes of each record contain an uppercase name with trailing blanks, the result of the following statement is true:

```
FLD(1,10) = 'FRED'
```

but the following statement is false:

```
FLD(1,10) == 'FRED'
```

To avoid the problem shown by the second example, (but still keeping with the preferred use of “==” rather than the looser “=”), you could code either of the following alternatives:

```
STRIP(FLD(1,10)) == 'FRED'
```

```
FLD(1,10) == 'FRED ' (six trailing blanks)
```

Ultimately, the last choice is best because it allows FASTREXX processing, which the use of the STRIP function does not.

Here are some examples of possibly unexpected results:

REXX	Result
<code>IF 'A ' = ' A'</code>	True
<code>IF 'C140'x = '40C1'x</code>	True
<code>IF 'A ' == ' A'</code>	False
<code>IF '01' = '1 '</code>	True
<code>IF '001' = '1E0'</code>	True (1E0 is scientific notation)
<code>IF '+ 1.00' = ' 1E0'</code>	True
<code>IF '12345678901' = 12345678902</code>	True (it's longer than the default REXX numeric precision for integers)

Coding end of file procedure

To code an end of file procedure you need to use the *EOFPROC statement, as shown here:

*EOFPROC

If this statement is coded, then all the subsequent REXX statements are treated as procedural statements to be run once at normal completion of the function processing. This could be end of file, or when a processing limit has been reached, or after a STOP condition has been issued from a REXX procedure. The input and output records will be positioned at the last record processed by the function. This end of file procedure is only run for the functions DSC, DSP, DSU, and DSEB. The procedure is ignored for any other functions. If you have previously coded an *FASTREXX ON statement, then this procedure must be eligible for FASTREXX processing, as described in the given example, to avoid syntax errors. If internal FASTREXX processing is not required, then File Manager chooses either the internal or REXX processing, for the end of file procedure. So one procedure could be running under REXX, while the the other could be FASTREXX. See given examples for usage scenarios.

Example 1.

Perform a copy with a record processing REXX procedure and end of file procedure.

```

$$FILEM DSC PROC=*
SAY 'NORMAL PROCESS RECORD NUMBER' SUBSTR(INREC,5,2)
*EOFPROC
SAY 'END OF FILE PROC INREC' SUBSTR(INREC,8)

```

Example 2.

Perform a copy with a FASTREXX end of file procedure.

```

$$FILEM DSC PROC=*
*EOFPROC
SETC(PRTVAR, ' ') /* CLEAR IT */
SETC(INSUB, '&ZINREC(8)') /* SUBSTR */
OVLY_VAR(PRTVAR, 'END OF FILE PROC INREC ',1) /* LITERAL */
OVLY_VAR(PRTVAR, '&INSUB',0) /* EOF VALUE*/
PRT_VAR(PRTVAR) /* PRINT IT */

```

Example 3.

Perform a copy using *FASTPROC, *REXXPROC, and *EOFPROC statements.

```

$$FILEM DSC PROC=*
*FASTPROC
OMIT COND=(68,2,CH,EQ,C'XX')
*REXXPROC
SAY 'NORMAL PROCESS RECORD NUMBER' SUBSTR(INREC,5,2)
*EOFPROC
SAY 'END OF FILE PROC INREC' SUBSTR(INREC,8)

```

Combining DFSORT and REXX statements in a procedure

When you want your procedure to contain both DFSORT and REXX statements, then you must code the DFSORT statements before the REXX statements, and the REXX statements must be separated from the DFSORT statements by a line containing the string *REXXPROC or one of the *FASTREXX statements coded in column one. For more information about how enhanced processing interacts with DFSORT and REXX, see [How enhanced processing works on page 533](#).

While the DFSORT *FASTPROC statements must be placed before the REXX statements, when a combination of DFSORT and REXX statements are used, the order of execution is:

1. DFSORT OMIT or INCLUDE statements, INREC statements and OUTREC statements, in that order.
2. REXX statements
3. DFSORT OUTFIL statements

Example

This example combines DFSORT and REXX statements in one procedure to change all records, where columns one and two contain '01', into upper case and discard all other records:

```
*FASTPROC
INCLUDE COND=(1,2,CH,EQ,C'01')
*REXXPROC
Upper OUTREC
```

Supplying a procedure to enhance File Manager processing

How you supply a procedure to enhance File Manager processing depends on whether you are using a File Manager panel, running File Manager in batch, or invoking File Manager from a REXX program.

Supplying a procedure when using a File Manager panel

If you are using one of the File Manager panels that supports enhanced processing, specify the procedure name in the **Use proc** or **Use REXX proc** field on the panel:

```
/ Use proc _____
```

If you enter an * (asterisk) as the *proc* name, then File Manager displays an ISPF edit panel where you can enter a temporary procedure for one time use. Use this method only for short, ad hoc procedures. If you want, you can use ISPF's CREATE command to save the procedure for later use.

Alternatively, you can allocate an FMNEXEC DD that identifies a PDS where your saved procedures reside. If you specify a member name, then File Manager either edits a new member or runs with an existing member. Specifying a blank or a pattern other than * displays a member selection list of the PDS allocated to FMNEXEC. Concatenated FMNEXEC data sets are not supported under ISPF.

For example, if you store your procedures in a PDS called 'USERID.FMNEXEC' then, before using the **Use proc** field, you must issue a TSO ALLOC command similar to the following:

```
TSO ALLOC DD(FMNEXEC) DSN('USERID.FMNEXEC') SHR
```

If errors are detected in the procedure when the function is run, File Manager displays the errors in a message box. Correct the errors and rerun the function.

Supplying a procedure when running File Manager in batch

If you are using one of the File Manager functions that supports enhanced processing, then you use the PROC parameter to supply the procedure.

The procedure that you use to enhance File Manager processing can either be a member of the PDS allocated to ddname FMNEXEC, or it can be coded in-line (by specifying an asterisk as the procedure name).

To use a procedure stored in a member of a PDS:

1. Code an `FMNEXEC DD` statement that specifies the name of the PDS that contains the member.
2. Code `PROC=member-name` in the File Manager control statements.

For example, to use the REXX procedure stored in FMNUSER.EXEC(EXAMPLE):

```
//jobcard
//*
//FILEMNGR PROC
//FILEMAN EXEC PGM=FILEMGR
//STEPLIB DD DISP=SHR,DSN=hlq.SFMNMOD1
//SYSPRINT DD SYSOUT=*
//SYSABEND DD SYSOUT=*
//SYSUDUMP DD SYSOUT=*
//          PEND
//*
/* Run DSU function with an existing REXX procedure.
/* The REXX procedure used is in member EXAMPLE in FMNUSER.EXEC.
/* Member BATCH of PDS FMNUSER.FMN.CNTL is updated.
/* The updated member is printed.
/*
//EXAMPLE EXEC FILEMNGR
//FMNEXEC DD DISP=SHR,DSN=FMNUSER.EXEC
//INDD DD DISP=SHR,DSN=FMNUSER.FMN.CNTL
//SYSIN DD *
$$FILEM DSU INPUT=INDD, MEMBER=BATCH, PROC=EXAMPLE
$$FILEM DSP DSNIN=FMNUSER.FMN.CNTL (BATCH)
/*
```

To use an inline procedure:

1. Code `PROC=*` in the File Manager control statements.
2. Code your DFSORT or REXX statements in the SYSIN data stream, following the `PROC=*` statement.
3. Terminate the DFSORT or REXX statements with a line containing a slash and a plus sign (/+) in columns 1–2.

For example:

```

//jobcard
/*
//FILEMNGR PROC
//FILEMAN EXEC PGM=FILEMGR
//STEPLIB DD DISP=SHR,DSN=hlq.SFMNMOD1
//SYSPRINT DD SYSOUT=*
//SYSABEND DD SYSOUT=*
//SYSUDUMP DD SYSOUT=*
// PEND
/*
/* Run DSU function with a REXX EXEC specified as an in-line proc.
/* Member BATCH2 of PDS FMNUSER.FMN.CNTL is updated.
/* The updated member is printed.
/*
//EXAMPLE2 EXEC FILEMNGR
//INDD DD DISP=SHR,DSN=FMNUSER.FMN.CNTL
//SYSIN DD *
$$FILEM DSU INPUT=INDD,MEMBER=BATCH2,PROC=*
  outrec = change(outrec,'//','??');
/*
$$FILEM DSP DSNIN=FMNUSER.FMN.CNTL(BATCH2)
/*

```

When coding an inline procedure, do not begin comments in column 1; if you do, the `/*` is interpreted as an end-of-data delimiter.

Supplying a procedure when invoking File Manager from a REXX program

You can specify a PROC parameter to enhance File Manager processing even when you are invoking the File Manager function from a REXX program.

To use a procedure stored in a member of a PDS:

1. Allocate an FMNEXEC DD that identifies a PDS where your saved procedures reside.
2. Code **PROC=member-name** in the File Manager function invocation.

For example, to use the procedure stored in USERID.FMNEXEC(TOTALS):

```

/* REXX program to print a data set, with enhanced processing */
/* as defined in the "nested" REXX procedure named TOTALS      */
"ALLOC DD(FMNEXEC) DSN('USERID.FMNEXEC') SHR"
:
FILEMGR "$DSP DSNIN='FMNUSER.TEST.KSDS1',PROC=TOTALS"
:
"FREE DD(FMNEXEC)"

```



Note: The TSO commands ALLOC and FREE can also be issued outside the REXX program.

To enter a procedure from the terminal

1. Code **PROC=*** in the File Manager function invocation.
2. When you run the REXX program and it invokes the File Manager function, File Manager prompts you to enter procedure statements with the following messages:

```
SYSIN DD is allocated to terminal
Enter card input (EOD=NULL REPLY):
```

Type your procedure statements, pressing the Enter key at the end of each line.

3. Enter **/+** as the last line to complete the procedure and indicate end of data. File Manager then runs the requested function using the entered procedure.

How enhanced processing works

File Manager implements enhanced processing by exploiting the power of DFSORT and REXX to extend the basic operation of File Manager functions and panels. Various details of how File Manager interacts with these external products is discussed in the following sections.

How REXX-enhanced processing works

File Manager defines two special REXX variables, INREC and OUTREC, that you can use in the REXX statements that you supply to perform enhanced processing. When the File Manager function or panel invokes REXX, the contents of each input record selected for processing are passed in both INREC and OUTREC. When REXX is invoked, the contents of INREC and OUTREC are identical, unless you are using the DSC function or the Copy Utility (option 3.3) with an output template that performs field mapping to reformat records. If you are using DSC or the Copy Utility to reformat records then, when REXX is invoked, INREC contains the input record, and OUTREC contains the reformatted output record.

The INREC variable is intended to be used as a reference variable. Any changes made to it are ignored by File Manager. The OUTREC variable can be updated by the procedure, and (unless you “drop” the record from further processing, as described below) when REXX processing completes, is passed back for processing by the File Manager panel or function that you are enhancing. For example, the following code processes a data set containing records with a type indicator in the first two bytes. Records with type '01' are all 80-bytes long and are to be passed on for output without change. Records with type '02' are variable in length, all less than 80 bytes long, and contain data divided into two sections (each at most 40 bytes long) by a slash character ('/'). These records are reformatted into two 40-byte halves that are concatenated to make 80-byte records to be passed on for output.

```
/* Reformat varying length records as fixed
   using an arbitrarily located delimiter */
If Substr(inrec,1,2) == '02' Then Do
  Parse Var inrec left '/' right
  outrec = Left(left,40) || Left(right,40)
End
```

If the value of the OUTREC variable is longer than the record length allowed in the data set specified by the function or panel you are using, then it is truncated. If the value of OUTREC is shorter than the record length, it is padded using the character specified by the **PAD** field on the Set Processing Options (option 0) panel (if you are enhancing a panel) or the character specified by the PAD parameter of the SET function (if you are enhancing a function).

How DFSORT-enhanced processing works

File Manager extracts the DFSORT control statements, if any, from the procedure, and invokes DFSORT to perform the required input and output operations. The control statements are passed to DFSORT and processed by that product according to its rules. If template processing is not required, and the procedure does not contain any REXX statements, then the entire operation is performed under the control of DFSORT.

If File Manager needs to get control during the operation, to perform template processing or execute REXX statements contained in the procedure, then it does this via DFSORT's E35 exit. This means that all of the processing for the INCLUDE, OMIT, INREC, and OUTREC statements is performed before File Manager regains control for each record. When File Manager regains control, it first applies the record identification and selection criteria associated with the input template, and the mapping (for the REXX OUTREC variable) associated with the output template, then invokes REXX to process REXX procedure statements, if any, and finally it applies any formatting operations associated with the output template.

When File Manager returns control to DFSORT any OUTFIL control statements found in the procedure are processed. This means that your OUTFIL statements must be coded to take into account not only the effect of any INREC or OUTREC statements coded in the procedure, but also the effect of any template or REXX processing that might also have been performed. Correspondingly, any templates used or REXX statements processed must allow for the effect of any INREC or OUTREC statements coded in the procedure.

Enhanced processing modes

There are two primary modes of enhanced processing:

- Enhanced record processing
- Enhanced member processing

A single execution of a File Manager utility can perform one or the other mode of processing, but not both.

In both enhanced record and enhanced member processing, individual records are presented to the user procedure. In enhanced record processing, the user procedure can make decisions about what to do with each record. In enhanced member processing, the user procedure cannot change individual records, but it can make decisions about how to process the entire member.

Enhanced record processing

The following sections describe how File Manager performs enhanced record processing for each utility function.

Copy Utility (option 3.3) or Data Set Copy function (DSC)

In DSC record processing, each record is read from the input file. The input record is passed to the user procedure in an *"input record buffer"*, and also in an initially identical *"output record buffer"*. The user procedure can take a number of actions or, as long as they are mutually compatible, any combination of actions, based on data inside the record and from other sources. The user procedure then returns control to File Manager. At this point, File Manager copies the output record from the user procedure to the primary output file (assuming that those are the instructions from the user procedure).

For each input record, the procedure can:

- Leave the output record unchanged and return it for copying to the output file. (RETURN command)
- Modify some or all of the output record and then return it for copying to the output file. (RETURN command)
- Choose to not copy the output record to the output file. (RETURN DROP command)
- Stop processing the input file and therefore stop writing to the output file. (RETURN STOP and RETURN STOP IMMEDIATE commands)
- Format new records based on any data in the input record and write one or more new records to one or more output files other than the primary output file. (WRITE command)

A user procedure is optional for DSC.

Print Utility (option 3.2) or Data Set Print function (DSP)

The record processing for DSP is very similar to that for DSC. However, whereas DSC writes the user procedure's output record to an output file, DSP formats the output record as requested for printing and sends it to the print destination.

A user procedure is optional for DSP.

Data Set Update (DSU) function

DSU record processing differs from DSC and DSP in that the records in the data set are not copied. Instead, records can be optionally updated by the user procedure. The user procedure is invoked after File Manager reads a record. The user procedure's input and output record buffers are set to the record as present in the file.

For each input record, the procedure can:

- Leave the output record unchanged. If the output record is unchanged, File Manager does not update the file record. (RETURN command)
- Modify some or all of the output record and then return it for updating in the file. (RETURN command)
- Explicitly choose to not update the file record. (RETURN DROP command)
- Stop processing the input file. (RETURN STOP and RETURN STOP IMMEDIATE commands)
- Format new records based on any data in the input record, and write one or more new records to one or more output files other than the primary output file. (WRITE command)

There are a few restrictions on DSU. The main restriction is that DSU performs an *"update in place"*. That is, the updated data set record must be the same length as the record prior to updating.

A user procedure is required for DSU.

Data Set Edit in Batch (DSEB) function

DSEB record processing is similar to that for DSU. Like DSU, the DSEB user procedure can perform an *"update in place"* at any record. However, in DSEB, the user procedure can only traverse the records in the data set by including navigational commands such as UP() and DOWN(). As a result, the input data set records can be traversed and updated in any order.

A user procedure is required for DSEB.

Find/Change Utility (option 3.6) or Find/Change function (FCH)

Normal FCH usage is without a user procedure. In this case, FCH primary commands are used to search for strings (and possibly change them) in a data set or library.

An FCH user procedure can perform complex logic instead of a simple string match on a record. It can then use RETURN or RETURN DROP to indicate whether the record should be reported as selected ("*found*") in the FCH output report. The user procedure can also change the record by RETURNing a changed output record; in this case the record is always also considered found or selected.

Enhanced member processing

You can enhance the following utilities with member processing:

- Copy Utility (option 3.3) or Data Set Copy function (DSC)
- Print Utility (option 3.2) or Data Set Print function (DSP)

The key concept is that the user procedure is presented with each record in the member. The user procedure tests each record for some conditions and then tells File Manager whether or not the entire member should be copied or printed.

Member processing always requires a user procedure. The commands, RETURN PROCESS MEMBER and RETURN DROP MEMBER, enable the user procedure to indicate respectively whether or not the current utility operation (print or copy) should be performed on the member. If the user procedure makes no decision, File Manager continues to pass records to the user procedure by using the RETURN command.

For member processing, you must specify the MEMPROC option, as well as a default behavior (PROCESS or DROP). If the entire member is read and no decision is made by the user procedure (that is, there is no RETURN PROCESS MEMBER or RETURN DROP MEMBER command returned), then the default behavior (PROCESS or DROP) is used.

Changes made by the user procedure to the output record are ignored during member processing.

Using templates with enhanced processing

If you specify a template for DSEB and DSU, it is ignored, except for calls in a REXX program to the REXX external function PRINT that specify TABL or SNGL format. For details, see [PRINT on page 1681](#).

For the other functions and panels that you can enhance, any record selection by the template is performed before the procedure is run; only those records that the template selects are passed to the procedure for further processing.

Regardless of whether or not the template you are using selects only certain fields, the INREC and OUTREC variables defined for the REXX environment contain complete records with all fields. However, after the REXX statements in the procedure have been processed (or when you call the PRINT function in the procedure with TABL or SNGL format), the record is printed using only the fields selected by the template.

You cannot specify a template for use with FCH or Find/Change Utility (option 3.6).

For information on using templates, see [Creating and editing templates on page 173](#).

Working with an entire data set (DSEB only) or per record

Except for the DSEB function, the REXX statements that you supply are run against each input record in sequence, either until the end of the input data set is reached, or until a RETURN STOP (or RETURN STOP IMMEDIATE) statement is executed. However, the REXX statements you supply with a DSEB function are run only once, for the entire input data set. In the REXX statements for a DSEB function, you can use various external REXX functions (described later in this chapter) to move between records in the input data set.

Dropping a record from further processing

Except for the DSEB function, if the REXX code returns normally after processing a record, then that record is considered to be “selected”, and the contents of OUTREC are used as the output record for copying, printing, updating, or inclusion in a Find/Change report (according to the function or panel you are enhancing). However, if a RETURN DROP (or RETURN STOP IMMEDIATE) statement is executed, then the current record is “dropped” from further processing by File Manager, and is not copied, printed, updated, or included in a Find/Change report.

For Data Set Copy (DSC) and Data Set Print (DSP), the DFSORT OMIT statement can be used to “drop” a record from further processing.

For DSEB, the contents of OUTREC are only written to the output data set when you call the UPDATE function. If you leave the procedure or move to another record before calling the UPDATE function, then any changes to the current OUTREC are lost.

Performance tips

Make your REXX procedures FASTREXX eligible

Look for a way to code your requirements using FASTREXX wherever possible. You can test your existing procedures to see if they are FASTREXX eligible by using the *FASTREXX CHECK or *FASTREXX NORUN statements.

Use DFSORT for performance-critical jobs

DFSORT processing is more efficient than FASTREXX and significantly more efficient than REXX. See [Choosing between FASTREXX, REXX, and DFSORT for your procedure on page 521](#).

For maximum efficiency when mixing DFSORT and REXX statements, where appropriate:

- Use DFSORT in preference to REXX when you can achieve the same result from either.
- Use DFSORT INCLUDE or OMIT statements to restrict the amount of REXX processing to be done by restricting the number of calls to REXX.
- Write multiple output files by using DFSORT OUTFIL rather than REXX write statements.
- Be prepared to use two passes through the data, rather than one, if that would make processing more efficient.
- Make the REXX part of your procedures FASTREXX eligible wherever possible.

Do not use EXITs in REXX

Use RETURN to terminate all your REXX processing. Do not use EXIT statements. EXIT statements in REXX used with File Manager cause excessive CPU usage.

Run with the REXX compiler

Compiled REXX runs considerably faster than interpreted REXX. However, because File Manager modifies the REXX you supply to run in the File Manager environment, you cannot supply pre-compiled REXX code. Instead, by supplying the DD card for the REXX compiler library, you instruct File Manager to compile your REXX before running it. This approach reduces CPU usage and run time.

File Manager runs the compiler when you allocate the data set containing your REXX compiler to the DD name FMNRXCMP. For example, in batch, use the following JCL DD statement:

```
//FMNRXCMP DD DSN=rex.c.compiler.loadlib,DISP=SHR
```

When running a procedure from a panel, you can enter a TSO ALLOC command on the Command line. For example,

```
TSO ALLOC DD(FMNRXCMP) DSN(' rex.c.compiler.loadlib' ) SHR
```

The REXX compiler has no effect on DFSORT or FASTREXX processing.

REXX and DFSORT Examples

The examples in this section demonstrate the use of REXX and DFSORT statements to achieve common tasks.

Printing data

The following excerpt from a batch job uses the DSP print function to:

- Skip the first 900,000 records
- Exclude all records from further processing where the first 4 characters are not "CHAX"
- Print the next 1000, non-excluded records, formatted using template TEMPL98

```
:
//SYSIN DD DATA
$$FILEM DSP FORMAT=TABL,
$$FILEM POSITION=900000,
$$FILEM NLRECS=1000,
$$FILEM TCIN=FMNUSER.FMNAFDAT.TEMPLATE(TEMPL98),
$$FILEM DSNIN=FMNUSER.FMNAFDAT.SAMP,
$$FILEM PROC=*
*FASTPROC
OMIT COND=(1,4,CH,NE,C'CHAX')
+/
:
```

Copying data

By default, the DSC (Data Set Copy) function simply copies the contents of one data set to another (using DFSORT if available). The following excerpt from a batch job enhances the DSC function to:

- Include in the input stream only those records whose first two characters are “01” or “02”.
- Add two lines to SYSPRINT that tally the total values of the “salary” (a 4-byte packed decimal field found at position 27) and “month 1 payment” (a 4-byte binary field found at position 31) fields in the “01”-type records.
- In each output record, change the first occurrence of “Grant Smith” to “Fred Bloggs”.
- Write only those records whose first two characters are “02” to the default output data set (DDOUT), adding a sequence field in 1-6 and shifting the rest of the data over.
- Write to another data set (OUT01) only those records whose first two characters are “01”, unchanged.
- Print the first ten output records (to SYSPRINT) in hexadecimal format.

```

:
//DDIN      DD DSN=FMNUSER.FMNAFDAT.SAMPMVS,DISP=SHR
//DDOUT     DD DSN=FMNUSER.FMNAFDAT.SAMP02,DISP=SHR
//OUT01     DD DSN=FMNUSER.FMNAFDAT.SAMP01,DISP=SHR
//SYSIN     DD *
$$$FILEM DSC INPUT=DDIN,
$$$FILEM   PROC=*
*FASTPROC
  INCLUDE COND=(1,2,CH,EQ,C'02',OR,1,2,CH,EQ,C'01')
  OUTFIL FNames=DDOUT,INCLUDE=(1,2,CH,EQ,C'02')
  OUTREC=(SEQNUM,6,ZD,1,74)
  OUTFIL FNames=OUT01,INCLUDE=(1,2,CH,EQ,C'01')
*REXXPROC
  outrec = change(outrec,'Grant Smith','Fred Bloggs')
/* Print the first 10 output records in hex */
  if prtcount() < 10 then print(outrec,'hex')
  if fld(1,2) == '01' then do
    tally(27,4,'P','Salary Total')
    tally(31,4,'B','Total Month 1 Payment')
  end
end
/+
/*
:

```

Updating records in a data set

The following example searches every member of the partitioned data set FMNUSER.TESTPDS for records that contain both “JAMES” (starting at column 6) and “BROWNE” (starting at column 20), then changes “JAMES” in those records to “JIMMY”.

```

:
$$$FILEM DSU DSNIN='FMNUSER.TESTPDS',
$$$FILEM MEMBER=*,
$$$FILEM PROC=*
if fld(1,5) == 'JAMES' & fld(20,6) == 'BROWNE' then
  CHG_OUT('JAMES', 'JIMMY', 0)
/+
:

```

Editing a data set

The following example shows how you can use the DSEB (Data Set Edit Batch) function to edit a data set from a batch job (this example performs the editing “on itself”):

```

:
$$FILEM DSEB DSNIN=FMNUSER.JCL(AAADSU4),
$$FILEM PROC=*

bot()                /* Go to the last record */
rc = findprev('/+')  /* Find the input sentinel */
If rc = 0 then do    /* We found it ok */
  say 'We found it at' rc
  up(1)              /* backup a record */
  outrec = change(inrec,'fred','john') /* change fred to john */
  say 'inp-'inrec
  say 'out-'outrec
  update()           /* and do the update */
end

rc = findprev('sentinel',40)
If rc = 0 then do
  outrec = change(inrec,'sentinel','marker ')
  update()
end

/* this is a comment with fred in it */
/+
:

```

Examples of tasks that can be performed easily using FASTREXX

Some of the tasks you can perform easily with FASTREXX include:

- Record editing.
- Writing one or more optionally edited records to one or more output files, depending on data in the input record.
- Determining whether to copy or print a member based on some condition inside the member.

The following sections provide examples of each of the above tasks and how FASTREXX can be used to perform them.



Note: For simplicity, the examples shown assume Data Set Copy is being performed.

Record Editing

Record editing can include any combination of:

- Rearranging fields of certain records.
- Adding constants or text to certain records.
- Removing fields from certain records.
- Dropping whole records from the output based on the contents of the record.

Example:

Rearrange a record of type "A" (as designated in the first byte) to be a record of type "Z", by reversing the first field of 20 bytes (first name) and the next field of 30 bytes (last name). Then drop the next 4 bytes (52 thru 55) and include the rest of the record. Also, drop all records of type "B".

FASTREXX:

```
If FLD(1,1) = "B" Then RETURN DROP
If FLD(1,1) = "A" Then Do
  SET_OLEN( 0 )
  OVLY_OUT( "Z", 1, 1 )
  FLD_OUT( 22, 30 )
  FLD_OUT( 2, 20 )
  FLD_OUT( 56 )
End
```

REXX:

```
InitChar = SUBSTR( INREC, 1, 1 )
If InitChar = "B" Then RETURN DROP
If InitChar = "A" Then Do
  OUTREC = OVERLAY("Z" || FLD( 22, 30 ) || FLD( 2, 20 ), OUTREC, 1 )
End
```

DFSORT:**Note:**

1. Requires DFSORT PTFs UQ95214 and UQ95213
2. This only works on sequential input files.

```
*FASTPROC
OMIT COND=(1,1,CH,EQ,'B')
OUTFIL IFTHEN=(WHEN=(1,1,CH,EQ,'A'),
  OVERLAY=(1:'Z',22,30,2,20,52)),
IFTHEN=(WHEN=NONE,
  BUILD=(1))
```

Splitting an input file into multiple output files based on record data

This example shows how to split an input file into one or more output files based on the contents of each input record.

Example**Example**

Split the input file into multiple output files based on the packed value in bytes 1-4. If the value is greater than 100, put the record in DD OV100; if it is less than 10, put the record in LT10; and if the value is in the middle, put the record in MIDDLE. If the value in bytes 1-4 is not packed, put the record into DD ERROR.



Note: In the REXX and FASTREXX solutions, there is potential for an error to occur. File Manager does not open any of the secondary output DDs for output until there is a WRITE command to that DD executed.

For example, suppose there is never a WRITE to the file ERROR and that ERROR is allocated NEW in the DD card, with BLKSIZE=0 for DFSMS to determine. After DSC executes with the control cards shown below, ERROR will not have been opened, so the BLKSIZE will not have been set acceptably by DFSMS and so it will still be zero. All attempts to read ERROR will generate errors. Therefore, before running this utility you should create empty secondary output data sets. You can use File Manager Data Set Generate (DSG) with NLRECS=0.

This discussion only applies to secondary (WRITE) output data sets. File Manager always opens the primary DSC output data set.

FASTREXX:

```

$$$FILEM DSG OUTPUT=ERROR,NLRECS=0
$$$FILEM DSG OUTPUT=OV100,NLRECS=0
$$$FILEM DSG OUTPUT=LT10,NLRECS=0
$$$FILEM DSG OUTPUT=MIDDLE,NLRECS=0
$$$FILEM DSC PROC=*
  If \ FLD_TYPE(1,4,"P") Then WRITE( ERROR )
  Else If FLD(1,4,"P") > 100 Then WRITE( OV100 )
  Else If FLD(1,4,"P") < 10 Then WRITE( LT10 )
  Else WRITE( MIDDLE )
  RETURN DROP

```

REXX:

(Same as FASTREXX)

Either copying or printing a member based on some condition inside the member

This example shows how to selectively copy or print a member based on some condition inside the member.

Example

Example

Copy all members which contain the character string *"Hello Mom"* (with any letter in uppercase or lowercase).

FASTREXX:

```

/* Requires option MEMPROC=DROP */
If FLD_CO( 1, 0, "U", "HELLO MOM" ) Then RETURN PROCESS MEMBER

```

REXX:

(Same as FASTREXX)

DFSORT:

Not applicable.

Relative positioning support

The following sections show how you can use enhanced processing with the relative positioning support provided by File Manager.

Input record relative positioning

File Manager allows a FASTREXX program to search an input record and use the resulting successful search position to make other tests at a fixed offset from the located string. You can also perform this task in full REXX, using REXX variables and non-FASTREXX functions. However, it executes more efficiently if done in FASTREXX using relative positioning.

File Manager maintains an internal *“current position”* in the input buffer, and also sets the value in the REXX variable, INPOS. (Note: you cannot use REXX variables in FASTREXX.)

To set the current position in the input buffer, use the function FLD_CO (Field Contains). If the search operation is successful, the current position is set to the starting byte of the located string.

You can refer to the input buffer position wherever an input or output buffer position is required in a FASTREXX function. You can adjust it positively (for example, P7 is the current position plus 7 bytes), or negatively (for example, N2 is the current position minus 2 bytes).

Example

Print all members of a JCL library which execute a program with a name like %%DBG* (any 2 initial characters and any following allowed). The way this is implemented is to test if the JCL record contains " EXEC PGM=" and then test the program name for "DBG" at a relative position.

FASTREXX:

```
If FLD_CO(1, 0, C, " EXEC ") ,
  & FLD_CO(P4, 0, C, " PGM=") ,
  & FLD(P7,3) = "DBG" Then
  RETURN PROCESS MEMBER
```

REXX:

```
P = Pos( " EXEC ", INREC, 1 )
If P = 0 Then RETURN
P = Pos( " PGM=", INREC, P )
If P = 0 Then RETURN
If Substr( INREC, P+7, 3 ) = "DBG" Then
  RETURN PROCESS MEMBER
```

DFSORT:

(Can't be done.)

Output record relative positioning

File Manager maintains an internal *“current position”* in the output record, and also sets the value in the REXX variable, OUTPOS. After any operation that modifies the output record, File Manager resets the value in OUTPOS to point to the next

byte position after the most recent change to the output record. By using the value held in OUTPOS, you can easily append fields to the output record.

Example

Rearrange the input record fields in the output record. The first step is to “clear” the output record by setting its length to zero. Then fields and constants are appended to the output record. The only field and length references needed are in the input record. When no reference is made to an output position, it defaults to the current output position.

FASTREXX:

```
SET_OLEN( 0 )
OVLV_OUT('First name: ')
FLD_OUT(31,20)
OVLV_OUT('Last name: ',P5) /* Skips 5 bytes, filled by PAD character */
FLD_OUT(1,30)
```

Chapter 15. Redefines criteria

Redefines criteria can be specified for a field with a REDEFINES clause, or a field that is the target of a REDEFINES clause.

The selection of fields (see [Table 12: Selection behavior for redefines fields on page 545](#)) that map the same area can then be controlled using the redefines criteria.

Table 12. Selection behavior for redefines fields

Function description	Behavior
Edit or View Formatted	The Editor option Redefined fields will be selected when you run with a template that contains redefines criteria. The option will only persist if you return to the entry panel and navigate to the respective editor option panel from the Options pull-down menu. Otherwise it reverts the original value.
Edit or View Format SNGL	Only selected fields will appear.
Edit or View Format TABL	Fields that are not selected will be protected and blank.
Compare	New fields that are not selected will not take part in comparisons. A change will be recognized if the <i>“from”</i> field is not selected and the corresponding new field is selected.
Copy with an input and output template	If the <i>“from”</i> field is not selected, then the corresponding <i>“to”</i> field will not be processed. If a new field maps part of a redefined area, it will only be initialized if the mapped <i>“from”</i> fields for the corresponding area of the input record are selected.



Notes:

- For PL/I, UNION is equivalent to REDEFINES.
- For Assembler, File Manager interprets fields that map the same area as redefines in the resultant template layouts.

Specifying redefines criteria

Use the CR (free-format criteria) or the CF (criteria by field) prefix commands during a template edit from the Field Selection/Edit panel to specify criteria.

The following example illustrates how to do this using the CF command.

 **Restriction:** Only FASTREXX expressions are supported. REXX functions (such as SUBSTR and WORD), arithmetic expressions, and File Manager external REXX functions that aren't supported by FASTREXX cannot be used.

Example 1. CF (by field) prefix command

This example shows how to enter redefines criteria using the CF (by field) prefix command.

Example

```

Process  Options  Help
-----
File Manager      Field Selection/Edit      Line 1 of 11
Command ==>>  ----- Scroll CSR
-----
Criteria - Enter 1 or 2 to specify expression by field -----
1 Id : _____ +
2 Sel: _____ +
Offset 0 _____
Cmd Seq SHE Ref Field Name          Picture  Type  Start Length
-----
      1 1 REDEFINES-LAYOUT              AN      1      5
      2 2 REDEF-TYPE                    X       AN      1      1
cf     3 2 DATA-A                       AN      2      4
      4 3 DATA-A1                      XX      AN      2      2
      5 3 DATA-A2                      XX      AN      4      2
cf     6 2 DATA-B REDEFINES DATA-A    AN      2      4
      7 3 DATA-B1                      99     ZD      2      2
      8 3 DATA-B2                      99     ZD      4      2
cf     9 2 DATA-C REDEFINES DATA-A    AN      2      4
      10 3 DATA-C1                     S9(4)  BI      2      2
      11 3 DATA-C2                     S9(4)  BI      4      2
      **** End of data ****
    
```

Type the CF command next to a field that has a REDEFINES clause or is the target of a REDEFINES clause and then press Enter.

The **REDEFINES Criteria** panel is displayed for the first field, DATA-A.

```

Process  Options  Help
-----
File Manager  REDEFINES Criteria: DATA-A      Line 1 of 11
Command ==>>  ----- Scroll CSR
-----
Cmd Con ( Field Name          Op  Value
<-> - <-----1-----2-----3-----> <-> <-----1-----2----->
*** **** Top of data ****
AND 1 REDEFINES-LAYOUT
AND 2 REDEF-TYPE          =  A
AND 2 DATA-A
AND 3 DATA-A1
AND 3 DATA-A2
AND 2 DATA-B
AND 3 DATA-B1
AND 3 DATA-B2
AND 2 DATA-C
AND 3 DATA-C1
AND 3 DATA-C2
*** **** End of data ****
    
```

Enter the expression = A as shown in the sample panel for DATA-A definition. Note that the operator defaults to "=" if left blank.

Press F3.

```

Process  Options  Help
-----
File Manager  REDEFINES Criteria: DATA-B                               Line 1 of 11
Command ==> >-----> Scroll CSR

Cmd Con ( Field Name                               Op Value )
<-> - <-----1-----2-----3-----> <-> <-----1-----2-----> -
*** **** Top of data ****
-----
1 REDEFINES-LAYOUT
-----
AND - 2 REDEF-TYPE                               = B
-----
AND - 2 DATA-A
-----
AND - 3 DATA-A1
-----
AND - 3 DATA-A2
-----
AND - 2 DATA-B
-----
AND - 3 DATA-B1
-----
AND - 3 DATA-B2
-----
AND - 2 DATA-C
-----
AND - 3 DATA-C1
-----
AND - 3 DATA-C2
-----
*** **** End of data ****

```

Enter the expression = B as shown in the sample panel for DATA-B definition and then press F3.

```

Process  Options  Help
-----
File Manager  REDEFINES Criteria: DATA-C                               Line 1 of 11
Command ==> >-----> Scroll CSR

Cmd Con ( Field Name                               Op Value )
<-> - <-----1-----2-----3-----> <-> <-----1-----2-----> -
*** **** Top of data ****
-----
1 REDEFINES-LAYOUT
-----
AND - 2 REDEF-TYPE                               = C
-----
AND - 2 DATA-A
-----
AND - 3 DATA-A1
-----
AND - 3 DATA-A2
-----
AND - 2 DATA-B
-----
AND - 3 DATA-B1
-----
AND - 3 DATA-B2
-----
AND - 2 DATA-C
-----
AND - 3 DATA-C1
-----
AND - 3 DATA-C2
-----
*** **** End of data ****

```

Enter the expression = c as shown in the sample panel for DATA-C definition and then press F3.

```

Process  Options  Help
-----
File Manager                               Field Selection/Edit                               Line 1 of 11
Command ==> >-----> Scroll CSR

----- Criteria - Enter 1 or 2 to specify expression by field -----
1 Id : _____ +
2 Sel: _____ +
Offset @
Cmd Seq SHE Ref Field Name                               Picture Type Start Length
-----
**** Top of data ****
-----
1 1 REDEFINES-LAYOUT
-----
2 2 REDEF-TYPE                               X AN 1 1
-----
3 2 DATA-A
-----
4 3 DATA-A1
-----
5 3 DATA-A2
-----
6 2 DATA-B REDEFINES DATA-A
-----
7 3 DATA-B1
-----
8 3 DATA-B2
-----
9 2 DATA-C REDEFINES DATA-A
-----
10 3 DATA-C1
-----
11 3 DATA-C2
-----
**** End of data ****

```



Note: The fields that have redefines criteria (fields 3, 6, and 9) will have their reference number highlighted in red on the **Field Selection/Edit** panel.

Example 2. CR (free-format criteria) prefix command

This example shows how to enter redefines criteria using the CR (free-format criteria) prefix command.

Example

```

Process  Options  Help
-----
File Manager          Field Selection/Edit          Line 1 of 11
Command ==>> ----- Scroll CSR

----- Criteria - Enter 1 or 2 to specify expression by field -----
1 Id : _____ +
2 Sel: _____ +
Offset 0
Cmd Seq SHE Ref Field Name          Picture  Type Start Length
-----
      1 1 REDEFINES-LAYOUT             ***** Top of data *****
      2 2 REDEF-TYPE                  X        AN    1    1
      3 2 DATA-A                     AN       AN    2    4
      4 3 DATA-A1                    XX       AN    2    2
      5 3 DATA-A2                    XX       AN    4    2
      6 2 DATA-B REDEFINES DATA-A   AN       AN    2    4
      7 3 DATA-B1                    99      ZD    2    2
      8 3 DATA-B2                    99      ZD    4    2
      9 2 DATA-C REDEFINES DATA-A   AN       AN    2    4
     10 3 DATA-C1                    S9(4)   BI    2    2
     11 3 DATA-C2                    S9(4)   BI    4    2
      ***** End of data *****
  
```

Type the CR command next to a field that has a REDEFINES clause or is the target of a REDEFINES clause and then press Enter.

The **REDEFINES Criteria** panel is displayed for the first field, DATA-A.

```

Process  Options  Help
-----
File Manager          REDEFINES Criteria: DATA-A          Line 1 of 11
Command ==>> ----- Scroll CSR

----- Criteria - Enter 1 to specify expression by field -----
1: #2 = 'A' _____ +
Offset 0
Cmd Seq SHE Ref Field Name          Picture  Type Start Length
-----
      1 1 REDEFINES-LAYOUT             ***** Top of data *****
      2 2 REDEF-TYPE                  X        AN    1    1
      3 2 DATA-A                     AN       AN    2    4
      4 3 DATA-A1                    XX       AN    2    2
      5 3 DATA-A2                    XX       AN    4    2
      6 2 DATA-B REDEFINES DATA-A   AN       AN    2    4
      7 3 DATA-B1                    99      ZD    2    2
      8 3 DATA-B2                    99      ZD    4    2
      9 2 DATA-C REDEFINES DATA-A   AN       AN    2    4
     10 3 DATA-C1                    S9(4)   BI    2    2
     11 3 DATA-C2                    S9(4)   BI    4    2
      ***** End of data *****
  
```

Enter the expression `#2 = 'A'` as shown in the sample panel for DATA-A definition and then press F3.

```

Process  Options  Help
-----
File Manager          REDEFINES Criteria: DATA-B          Line 1 of 11
Command ==>> ----- Scroll CSR

----- Criteria - Enter 1 to specify expression by field -----
1: #2 = 'B'
Offset 0
Cmd Seq SHE Ref Field Name          Picture  Type Start Length
      **** Top of data ****
      1 1 REDEFINES-LAYOUT              AN      1      5
      2 2 REDEF-TYPE                    X       AN      1      1
      3 2 DATA-A                        AN      2      4
      4 3 DATA-A1                       XX      AN      2      2
      5 3 DATA-A2                       XX      AN      4      2
      6 2 DATA-B REDEFINES DATA-A     AN      2      4
      7 3 DATA-B1                       99      ZD      2      2
      8 3 DATA-B2                       99      ZD      4      2
      9 2 DATA-C REDEFINES DATA-A    AN      2      4
     10 3 DATA-C1                       S9(4)   BI      2      2
     11 3 DATA-C2                       S9(4)   BI      4      2
      **** End of data ****

```

Enter the expression #2 = 'B' as shown in the sample panel for DATA-B definition and then press F3.

```

Process  Options  Help
-----
File Manager          REDEFINES Criteria: DATA-C          Line 1 of 11
Command ==>> ----- Scroll CSR

----- Criteria - Enter 1 to specify expression by field -----
1: #2 = 'C'
Offset 0
Cmd Seq SHE Ref Field Name          Picture  Type Start Length
      **** Top of data ****
      1 1 REDEFINES-LAYOUT              AN      1      5
      2 2 REDEF-TYPE                    X       AN      1      1
      3 2 DATA-A                        AN      2      4
      4 3 DATA-A1                       XX      AN      2      2
      5 3 DATA-A2                       XX      AN      4      2
      6 2 DATA-B REDEFINES DATA-A     AN      2      4
      7 3 DATA-B1                       99      ZD      2      2
      8 3 DATA-B2                       99      ZD      4      2
      9 2 DATA-C REDEFINES DATA-A    AN      2      4
     10 3 DATA-C1                       S9(4)   BI      2      2
     11 3 DATA-C2                       S9(4)   BI      4      2
      **** End of data ****

```

Enter the expression #2 = 'C' as shown in the sample panel for DATA-C definition and then press F3.

```

Process  Options  Help
-----
File Manager          Field Selection/Edit          Line 1 of 11
Command ==>> _____ Scroll CSR

----- Criteria - Enter 1 or 2 to specify expression by field -----
1 Id : _____ +
2 Sel: _____ +
Offset _____ 0 _____ CCSID _____
Cmd Seq SHE Ref Field Name          Picture  Type Start Length
-----
          **** Top of data ****
          1 1 REDEFINES-LAYOUT          AN      1      5
          2 2 REDEF-TYPE              X       AN      1      1
          3 2 DATA-A                  AN      2      4
          4 3 DATA-A1                 XX      AN      2      2
          5 3 DATA-A2                 XX      AN      4      2
          6 2 DATA-B REDEFINES DATA-A AN      2      4
          7 3 DATA-B1                 99     ZD      2      2
          8 3 DATA-B2                 99     ZD      4      2
          9 2 DATA-C REDEFINES DATA-A AN      2      4
          10 3 DATA-C1                S9(4)  BI      2      2
          11 3 DATA-C2                S9(4)  BI      4      2
          **** End of data ****
    
```

 **Note:** The fields that have redefines criteria (fields 3, 6, and 9) will have their reference number highlighted in red on the **Field Selection/Edit** panel.

Selection rules and example

Selection rules:

1. The first field (and its children, if it has any) that has redefines criteria that evaluates as true for the current record is selected. All other fields (and their children, if any) that map the same area are not selected.
2. In the case where no redefines criteria evaluate as true, the first field (and its children, if it has any) that maps the area and does not have redefines criteria is selected. If there are no fields that map the area without redefines criteria, then no fields are selected.
3. Nested redefines criteria are only applicable if the parent redefines criteria evaluates as true. The same selection rules apply for nested redefines.

Example

Example

In the example we provided, consider processing the following data:

```

Record 1 AA1A2
Record 2 B0102
Record 3 C.... (X'C300010002')
    
```

Viewing this data using a template without redefines criteria in TABL mode results in the following display.

Figure 144. TABL format display without redefines criteria

Process	Options	Help
View	FMN.PI97117.DATA(TESTR)	Top of 3
Command ==>	-----	Scroll CSR
		Format TABL
		Record AT TOP
REDEF-TYPE	DATA-A1 DATA-A2 DATA-B1 DATA-B2 DATA-C1 DATA-C2	
#2	#4 #5 #7 #8 #10 #11	
AN 1:1	AN 2:2 AN 4:2 ZD 2:2 ZD 4:2 BI 2:2 BI 4:2	
-	<> <> <-> <-> <----> <---->	
*****	**** Top of data ****	
0000001	A A1 A2 *** ** -15887 -15886	
0000002	B 01 02 1 2 -3855 -3854	
0000003	C .. ** ** 1 2	
*****	**** End of data ****	

Viewing this data with the redefines criteria as illustrated in previous examples in TABL mode results in the following display.

Figure 145. TABL format display with redefines criteria

Process	Options	Help
View	FMN.PI97117.DATA(TESTR)	Top of 3
Command ==>	-----	Scroll CSR
		Format TABL
		Record AT TOP
REDEF-TYPE	DATA-A1 DATA-A2 DATA-B1 DATA-B2 DATA-C1 DATA-C2	
#2	#4 #5 #7 #8 #10 #11	
AN 1:1	AN 2:2 AN 4:2 ZD 2:2 ZD 4:2 BI 2:2 BI 4:2	
-	<> <> <-> <-> <----> <---->	
*****	**** Top of data ****	
0000001	A A1 A2	
0000002	B 1 2	
0000003	C 1 2	
*****	**** End of data ****	

Only the selected redefines fields are populated in TABL mode. Fields that are not selected are blank and protected.



Note: Changing the REDEF-TYPE value may change the selected fields if the redefine criteria yields a different result.

Viewing the redefined data in SNGL mode yields the following.

Figure 146. SNGL format display without redefines criteria

Process	Options	Help
View	FMN.SAMPLE.DATA(TESTR)	Rec 1 of 3
Command ==>	-----	Scroll CSR
		Format SNGL
		Record 1
		Top Line is 1 of 7
		Length 5
Current 01: REDEFINES-LAYOUT		
Field	Data	
REDEF-TYPE	A	
DATA-A1	A1	
DATA-A2	A2	
DATA-B1	***	
DATA-B2	***	
DATA-C1	-15887	
DATA-C2	-15886	
***	End of record	***

Figure 147. SNGL format display with redefines criteria

```

Process  Options  Help
-----
View          FMN.SAMPLE.DATA(TESTR)                      Rec 1 of 3
Command ==>> ----- Record 1 ----- Scroll CSR
                                         Format SNGL
                                         Top Line is 1 of 5
                                         Length 5
Current 01: REDEFINES-LAYOUT
Ref Field      Data
 1 1 REDEFINES-LAYOUT
 2 2 REDEF-TYPE      A
 3 2 DATA-A
 4 3 DATA-A1        A1
 5 3 DATA-A2        A2
*** End of record ***
    
```

REDEF-TYPE = 'A' results in field DATA-A being selected with its children.

```

Process  Options  Help
-----
View          FMN.SAMPLE.DATA(TESTR)                      Rec 2 of 3
Command ==>> ----- Record 2 ----- Scroll CSR
                                         Format SNGL
                                         Top Line is 1 of 5
                                         Length 5
Current 01: REDEFINES-LAYOUT
Ref Field      Data
 1 1 REDEFINES-LAYOUT
 2 2 REDEF-TYPE      B
 6 2 DATA-B REDEFINES DATA-A
 7 3 DATA-B1        1
 8 3 DATA-B2        2
*** End of record ***
    
```

REDEF-TYPE = 'B' results in field DATA-B being selected with its children.

```

Process  Options  Help
-----
View          FMN.SAMPLE.DATA(TESTR)                      Rec 3 of 3
Command ==>> ----- Record 3 ----- Scroll CSR
                                         Format SNGL
                                         Top Line is 1 of 5
                                         Length 5
Current 01: REDEFINES-LAYOUT
Ref Field      Data
 1 1 REDEFINES-LAYOUT
 2 2 REDEF-TYPE      C
 9 2 DATA-C REDEFINES DATA-A
10 3 DATA-C1        1
11 3 DATA-C2        2
*** End of record ***
    
```

REDEF-TYPE = 'C' results in field DATA-C being selected with its children.

Chapter 16. Enhanced ISPF: Reference List, Search, Change, and PDSE Workbench

File Manager provides several enhancements to the basic facilities that are available in an ISPF session: Enhanced Reference List, Enhanced Search, Enhanced Change, and PDSE Workbench.

The Enhanced Reference List provides an easy method to set up personal or global reference lists for data set and resource names that are commonly used with ISPF or File Manager utilities.

The Enhanced Search facility provides a sequential search of z/OS® resources. The tool supports scanning any combination of PDS, PDSE, VSAM, Non VSAM, HFS, CICS® resources, and WebSphere MQ queues. Once a search report is produced the user can navigate directly into the data in a view or edit session at the hit locations. Recursive scanning can then be performed with the touch of a key.

The Enhanced Change facility is like Enhanced Search with the addition of a “*replace*” feature.

Use PDSE Workbench to manage members of all PDS and PDSE data sets, including member generations.

Setting up the enhanced ISPF commands

There are two methods of setting up the enhanced ISPF commands.

Using LIBDEFs

If LIBDEF invocation of the enhanced list and search is required, copy member FMNELIBD from *hlq.SFMNSAM1* to a library that is available in the SYSEXEC DD for your TSO/ISPF users, and modify the exec source as follows:

```
LNG = 'ENU'
```

You can specify JPN for Japanese or KOR for Korean.

```
hlq = 'FMN'
```

Results in names in the form *hlq.SFMNxxxx* if *sfx=""*.

```
opt1 = ''
```

Specifies whether there is a separate installation options library.

```
sfx = ''
```

Results in names in the form *hlq.SFMNxxxx.sfx*

```
hlq2 = ''
```

libdef fixtest library first in the form *hlq2.SFMNxxxx*.

```
sfx2 = ''
```

libdef fixtest library first in the form *hlq2.SFMNxxxx.sfx2*.



Note: For a standard installation, you only need to modify the 'hlq = ' value to the installation value. Specify the 'optl = ' data set name if you have customized versions of the installation options module in a different library to hlq.SFMNMOD1.

Now refer to the following sections. If you have renamed the FMNELIBD exec, modify the command table and keys value to refer to the new name.

- [Define the search command with LIBDEFs on page 556](#)
- [Define the Enhanced Reference List command with LIBDEFs on page 556](#)
- [Define the Enhanced Change command with LIBDEFs on page 557](#)
- [Define the PDSE Workbench command with LIBDEFs on page 557](#)

Without using LIBDEFs

If you are not using LIBDEFs, refer to the following sections:

- [Define the search command without LIBDEFs on page 558](#)
- [Define the Enhanced Reference List command without LIBDEFs on page 558](#)
- [Define the Enhanced Change command without LIBDEFs on page 558](#)
- [Define the PDSE Workbench command without LIBDEFs on page 559](#)

Set up your edit or view function key

An edit macro is provided to perform:

- Primary commands for the search report.
- Editing of data from the search report.
- Various useful functions from an edit or view session when your cursor is positioned on a word or data set name you are interested in.

Use the ISPF KEYS command to assign this macro to a function key for edit and view sessions. In this example F4 is used but you can substitute another function key value for your own setup.

[Figure 148: Defining F4 with LIBDEFs on page 555](#) shows the key definition if you use LIBDEFs.

Figure 148. Defining F4 with LIBDEFs

```

----- Keylist Utility -----
File
PRIVATE          ISR Keylist ISRSPEC Change          Row 1 to 12 of 24
Command ==>>> _____ Scroll ==>>> PAGE

Make changes and then select File action bar.

Keylist Help Panel Name . . . ISRSPECH

Key      Definition          Format  Label
F1 . . . HELP                SHORT  Help
F2 . . . SPLIT               LONG   Split
F3 . . . EXIT                SHORT  Exit
F4 . . . FMNELIBD KEY      LONG EKEY
F5 . . . RFIND               SHORT  Rfind
:

```

Figure 149: Defining F4 without LIBDEFs on page 555 shows the key definition if you do not use LIBDEFs.

Figure 149. Defining F4 without LIBDEFs

```

----- Keylist Utility -----
File
PRIVATE          ISR Keylist ISRSPEC Change          Row 1 to 12 of 24
Command ==>>> _____ Scroll ==>>> PAGE

Make changes and then select File action bar.

Keylist Help Panel Name . . . ISRSPECH

Key      Definition          Format  Label
F1 . . . HELP                SHORT  Help
F2 . . . SPLIT               LONG   Split
F3 . . . EXIT                SHORT  Exit
F4 . . . FMNSRCHK         LONG EKEY
F5 . . . RFIND               SHORT  Rfind
:

```

Make PDSE Workbench available from an ISPF 3.4 data set display

Define one of the following REXX execs in a member of your choosing. The member must be in a data set that is available in the SYSEXEC or SYSPROC concatenation for the TSO ISPF session, or in ALTLIB.

If you use LIBDEFs:

```

/* REXX INVOKE PDSE2 WORKbench */
ARG DSN
address ISPEXEC
"SELECT CMD(%FMNELIBD FUN PWB "DSN") MODE(FSCR)"
exit

```

If you do not use LIBDEFs:

```

/* REXX INVOKE PDSE2 WORKbench */
ARG DSN
address ISPEXEC
"SELECT CMD(FILEMGR PWB "DSN") MODE(FSCR)"
exit

```

Define the search command with LIBDEFs

Using ISPF option 3.9, specify a command as illustrated below:

Figure 150. Command Table Utility Extended Command Entry

```

File  Menu  Utilities  Help
-----
Command Table Utility
Extended Command Entry

Command ===> _____

Make changes to the command and select Update to update the entry or
Cancel to ignore the changes.

Verb . . . EFind _____
Trunc . . . 2 _____
Action . . SELECT CMD(%FMNELIBD FND &ZPARM) _____
_____
_____

Description File Manager enhanced search facility _____
_____

Enter / to select option
/ Allow mixed-case in Action field

Update                               Cancel

```



Note: Choose a command name that is unique, memorable, and short to make the invocation of the search processing easy for the users. Do not use F as that will conflict with the editor FIND command. Alternate names could be ZF or SRCH.

Define the Enhanced Reference List command with LIBDEFs

Using ISPF option 3.9, specify a command as illustrated below:

Figure 151. Command Table Utility Extended Command Entry

```

File  Menu  Utilities  Help
-----
Command Table Utility
Extended Command Entry

Command ===> _____

Make changes to the command and select Update to update the entry or
Cancel to ignore the changes.

Verb . . . EList _____
Trunc . . . 2 _____
Action . . SELECT CMD(%FMNELIBD LST &ZPARM) _____
_____
_____

Description File Manager enhanced reference list _____
_____

Enter / to select option
/ Allow mixed-case in Action field

Update                               Cancel

```



Note: Choose a command name that is unique, memorable, and short to make the invocation of the search processing easy for the users.

Define the Enhanced Change command with LIBDEFs

Using ISPF option 3.9, specify a command as illustrated below:

Figure 152. Command Table Utility Extended Command Entry

```

File  Menu  Utilities  Help
-----Command Table Utility-----
                          Extended Command Entry
Command ==> _____

Make changes to the command and select Update to update the entry or
Cancel to ignore the changes.

Verb . . . EChange _____
Trunc . . . 2
Action . . . SELECT CMD(%FMNELIBD CHG &ZPARM)
_____
_____

Description File Manager enhanced change
_____

Enter / to select option
/ Allow mixed-case in Action field

Update                               Cancel

```



Note: Choose a command name that is unique, memorable, and short to make the invocation of the change processing easy for the users. Do not use C as that will conflict with the editor CHANGE command. Alternate names could be ZC or ECHG.

Define the PDSE Workbench command with LIBDEFs

Using ISPF option 3.9, specify a command as illustrated below:

Figure 153. Command Table Utility Extended Command Entry

```

File  Menu  Utilities  Help
-----Command Table Utility-----
                          Extended Command Entry
Command ==> _____

Make changes to the command and select Update to update the entry or
Cancel to ignore the changes.

Verb . . . PWB _____
Trunc . . . 2
Action . . . SELECT CMD(%FMNELIBD FUN PWB &ZPARM) NEWAPPL(FMN)
_____
_____

Description File Manager PDSE Workbench
_____

Enter / to select option
/ Allow mixed-case in Action field

Update                               Cancel

```



Note: Choose a command name that is unique, memorable, and short to make the invocation of the search processing easy for the users. Do not use F as that will conflict with the editor FIND command. Alternate names could be ZF or SRCH.

Define the search command without LIBDEFs

Using ISPF option 3.9, specify a command as illustrated below:

Figure 154. Command Table Utility Extended Command Entry

```

File  Menu  Utilities  Help
-----
                          Command Table Utility
                          Extended Command Entry

Command ==> _____

Make changes to the command and select Update to update the entry or
Cancel to ignore the changes.

Verb   . . .  EFind _____
Trunc  . . .  2
Action . . .  SELECT CMD(%FMNSRCH &ZPARM)
          _____
          _____

Description File Manager enhanced search facility
          _____

Enter / to select option
/ Allow mixed-case in Action field

                          Update                          Cancel
    
```

Define the Enhanced Reference List command without LIBDEFs

Using ISPF option 3.9, specify a command as illustrated below:

Figure 155. Command Table Utility Extended Command Entry

```

File  Menu  Utilities  Help
-----
                          Command Table Utility
                          Extended Command Entry

Command ==> _____

Make changes to the command and select Update to update the entry or
Cancel to ignore the changes.

Verb   . . .  EList _____
Trunc  . . .  2
Action . . .  SELECT CMD(%FMNSRCHL &ZPARM)
          _____
          _____

Description File Manager enhanced reference list
          _____

Enter / to select option
/ Allow mixed-case in Action field

                          Update                          Cancel
    
```

Define the Enhanced Change command without LIBDEFs

Using ISPF option 3.9, specify a command as illustrated below:

Figure 156. Command Table Utility Extended Command Entry

```

File  Menu  Utilities  Help
-----
Command Table Utility
Extended Command Entry

Command ==> _____

Make changes to the command and select Update to update the entry or
Cancel to ignore the changes.

Verb . . . EChange _____
Trunc . . . 2 _____
Action . . SELECT CMD(%FMNCHNG &ZPARM) _____
          _____
          _____

Description File Manager enhanced change
          _____

Enter / to select option
/ Allow mixed-case in Action field

Update                               Cancel

```

Define the PDSE Workbench command without LIBDEFs

Using ISPF option 3.9, specify a command as illustrated below:

Figure 157. Command Table Utility Extended Command Entry

```

File  Menu  Utilities  Help
-----
Command Table Utility
Extended Command Entry

Command ==> _____

Make changes to the command and select Update to update the entry or
Cancel to ignore the changes.

Verb . . . PWB _____
Trunc . . . 2 _____
Action . . SELECT CMD(%FILEMGR PWB &ZPARM) NEWAPPL (FMN) _____
          _____
          _____

Description File Manager PDSE Workbench
          _____

Enter / to select option
/ Allow mixed-case in Action field

Update                               Cancel

```

Using Enhanced Reference List, Search, and Change

Enhanced reference lists provide a method of grouping data set names and File Manager resources into member names in one or more reference data sets. This provides a mechanism to organize your data so it can be easily retrieved for various ISPF and File Manager processes.

The search and F4 key provide the navigational tools to process your data sets.

The Enhanced Change facility allows you to change strings on multiple VSAM files, sequential and partitioned data sets, and CICS resources. It uses the same reference members as enhanced search.

These topics describe how to use these productivity enhancing tools. It is assumed that EFind, EList, and EChange have been used for the ISPF commands, and F4 has been used for the Edit or View function key.

Reference data set

The reference data set is a partitioned data set containing members with lists of resources to be processed by the EFind command or F4 function key. Choose meaningful member names that make it easy to remember the list of resources they contain.

Member JCL may contain a list of JCL data sets that you frequently search. For example:

```
myhlq.JCL
TEST.JCL
PROD.JCL
```

Creating the reference data set

A reference data set can be created when you display the reference list or refer to a reference member for the first time via the EFind command. If the current reference data set does not exist, the following panel will be displayed.

```

Menu Utilities Compilers Options Status Help
-----
Allocate data set
Command ==> _____
0
0 The data set was not found
1 Data set name  userid.FMNSRCH.INDEX
2
3 Change the data set name or
4
5 Press ENTER to allocate a new data set
6
7 F1=Help      F2=Split    F3=Exit     F7=Backward  F8=Forward
9 F9=Swap      F12=Cancel
1
11 Workplace   ISPF Object/Action Workplace           Release . : ISPF 7.1
12 z/OS System  z/OS system programmer applications
13 z/OS User    z/OS user applications
14 IBMGSA      IBMGSA Development and Service Apps
S SDSF        SDSF
Enter X to Terminate using log/list defaults
F1=Help      F2=Split    F3=Exit     F7=Backward  F8=Forward  F9=Swap
F10=Actions  F12=retrieve
```

You can overwrite the reference data set name to choose an alternative name.



Note: The allocate dialog should be used to allocate the reference data set to ensure it is defined with the correct file attributes. When allocating a new reference data set, you will be subsequently placed in an edit session of a member



called DEFAULT; in this session, you can specify the resources you want the product to search by default. For more information, see [How the data set or resource list is determined on page 567](#).

Enhanced Reference List panel

You can insert, delete, rename, find, and select new members from the Enhanced Reference List. This panel can be produced as the primary panel by using the EList command or by entering a generic member name from the Enhanced Search Command panel that is produced when the EFind command is entered without parameters.

Figure 158. Enhanced Reference Member List

Process			
File Manager	Enhanced Reference List	Row 1 to 13 of 13	
Command ==>		Scroll	CSR
Data set name	DTORNEY.FMNSRCH.INDEX		
Member pattern	DE*		
Name	Description	Date Changed	Size
DEFAULT		2017/03/22 20:06	1
DEMOA	Simple template edit	2017/04/13 11:14	3
DEMOB	preparing a resource	2017/04/06 21:49	7
DEMO C	for demo	2017/04/06 22:26	11
DEMO1	Tech talk 1 - EXEC/Panels/skels	2017/04/12 21:13	14
DEMO2	Tech talk 2 - HFS and PDS	2015/12/01 13:32	2
DEMO3	Tech talk 3 - JCL	2015/12/01 13:34	2
DEMO4	Tech Talk 4 - CICS	2017/04/12 21:34	2
DEMO5	Tech Talk 5 - Proclib - substitutions	2015/12/01 14:00	12
DEMO6	Tech Talk 6 - MQ resources	2015/12/02 06:53	1
DEMO7	tech talk 7 - random	2015/12/02 07:01	3
DEMO8	Copy	2015/12/02 10:45	2
DEMO9	var substitutions / remote services	2017/04/12 21:42	7
***** Bottom of data *****			
F1=Help	F2=Split	F3=Exit	F4=Expand
F5=Backward	F6=Forward	F7=Backward	F8=Forward
F9=Swap	F10=Left	F11=Right	F12=Cancel

From the preceding panel, you can:

- Select or create a reference member data set.
- Filter the member list.
- Insert, rename, delete, edit, or view members.
- Update the member descriptions.
- Invoke the enhanced search against any member.

Primary Commands

L string

Searches for the value in the member name and description fields. **L JCL** searches member name and description for the value JCL.

F string

Searches the contents of the members for one or more strings. This performs an enhanced search of the reference data set for the string you entered. Use the AND & OR | connectors to provide more than one string. If your reference list was produced from the enhanced search command panel, you can select the member for that panel by pressing the enter key with the cursor that is positioned on a member name in the enhanced search report.

S member

For a list produced from the enhanced search command panel, this selects the member for the enhanced search panel if it exists; otherwise, you will be placed in an edit session with the member.

SORT column

You can sort any column by placing the cursor on the column header and pressing enter. Alternatively, you can issue the sort command where the column values are:

- NAME
- DESCRIPTION
- DATE
- SIZE

Line Commands

S

When the primary panel is the enhanced search command panel, this will select the member for the previous panel and return to that panel. When the primary panel is the list panel, this will edit the member.

F

Displays the enhanced search command panel with the reference member field that is populated with the corresponding member name. Only available when the primary panel is the list panel.

C

Displays the enhanced change command panel with the reference member field that is populated with the corresponding member name. Only available when the primary panel is the list panel.

E

Edits the member.

V

Views the member.

I

Inserts a new member.

R

Renames the member.

Field Descriptions

Data set name

This is the name of the data set that contains reference members.

Leave this field blank to select from a history list.

You can enter a generic name to select from a matching data set list. In a generic name, use the percent mark % to represent a single character and an asterisk mark * to represent any number of characters within one qualifier. Two asterisks ** represent any number of characters within any number of qualifiers.

If the data set name is not found in the catalog, a prompt to allocate the data set will be displayed.



Note: The allocate dialog should be used to allocate the reference data set to ensure it is defined with the correct file attributes.

Member pattern

Specifies a member pattern to filter the member list.

Column Descriptions:

Name

Reference member name.

Description

Input field to update or view existing member descriptions.

Date changed

The date and time the member was last modified.

Size

Number of lines in the member.

Specifying resource names in an reference member

A line can contain up to four resource names that can be used with the **F4** key to populate the corresponding File Manager functions. Only the first resource name on each line is used in determining the list of resources to be searched. The resource name can be any of the following types:

- A fully qualified data set name. TSO prefixing is not applied to names, and quotation marks should not be specified. Generic names are supported but be careful not to use ** because this will result in a long catalog search. You can also specify generic member names as part of the resource name.
- An HFS file name or directory name
- An FM/CICS resource name in the form: *rt:applid:rname*

Where:

rt

Is the resource type. Valid values are:

FI

For a CICS® File

TD

For Transient Data

TS

For a Temporary Storage Queue

applid

Is the VTAM® applid of the CICS® system. You can specify a generic name to search a list of CICS® systems if an FMNCICS DD describing CICS® applids has been allocated to the ISPF session. See *File Manager Customization Guide* for details.

rname

Is the name of the resource. You can specify a generic name to search a list of resources.

- An MQ queue might be specified in the following notation:

MQ: *Queue_manager* : *Queue_name*

Where:

Queue_manager

Is the name of a local queue manager. Generic names can be specified.

Queue_name

Is the queue name and it is case-sensitive. Generic names are supported.

- Remote resource definitions can be specified in the following form:

RM:*remote_id*:*resource name*

Where:

remote_id

Is the 1-8 character remote connection definition. Generic names are not supported. The remote ID must be defined; otherwise, an error occurs. Use the F4 function key with the Select option to verify what you have entered.

resource name

Any data set, path, or CICS® resource name can be specified.



Note: You can use the **F4** function key (see [Using the F4 function key on page 581](#)) with the Select option to list and populate resource names.

Examples

Example

1. The generic data set names

```
FMN.RFM*.CNTL
FMN.PM*.CNTL
FMN.PI*.CNTL
```

Example

2. A generic member name

```
DTORNEY.TESTPDS(A*)
```

Example

3. A generic data set name and member name

```
DTORNEY.TESTPD*(A*)
```

Example

4. An HFS directory

```
/u/fmn/SampLes
```

Example

5. The mixture of HFS and partitioned data sets

```
FMN.SOURCE
FMN.SAMPLES
/u/fmn/SampLes
```

Example

6. The Generic CICS® applid and Generic CICS® files

```
FI:CICSD*:MYFIL*
```

Example

7. The MQ messages

```
MQ:MQSS:MY.MSGS
MQ:MQSS.NEW.MSGS
```

Example

8. Four data set names to use with the F4 compare utility pull-down option

```
FMN.OLD FMN.TEMPLATE(OLD) FMN.NEW FMN.TEMPLATE(NEW)
```

EFind command syntax

Syntax

Use the ISPF command you have set up with the following syntax:

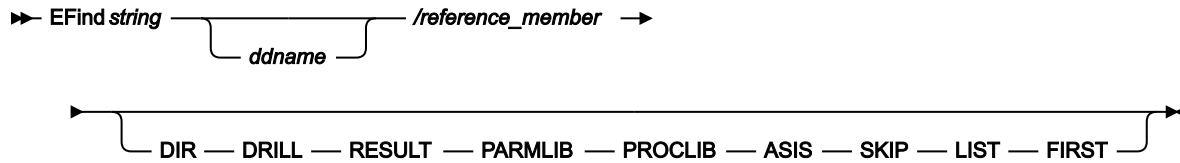
**string**

Is your search string. The search strings supported are those supported by the FCH function. So you can specify the string value in the form: X'hhhh' or C'cccc' or P'pppp', and so on.

You can also specify more than one string using Boolean operators. Examples:

```
string1 | string2 | string3
```

```
string1 & string2 & string3
```

prefix, suffix and word – keywords defining how the search string will be matched are also supported.

ddname

This refers to a ddname that has been allocated to your TSO/ISPF session. You can specify one or more ddnames.

For example, EFind ISPEXEC SYSPROC SYSEXEC will search SYSPROC and SYSEXEC DDs for the string "ISPEXEC".

DIR

Search restricted to directory names only, so only PDS and HFS directories will be searched.

DRILL

When searching HFS directories process all subdirectories. When searching version 2 PDSEs, process all member generations.



Note: Use this option with caution because it might result in a long search.

RESULT

Search restricted to the data sets and members or path names that matched the string on the previous search.

PARMLIB

Searches the current PARMLIB data sets for the string.

/reference_member

Searches the data sets specified in:

reference_dataset_name(reference_member) for the specified string. For more information about *reference_dataset_name*, see [Reference data set on page 560](#).

PROCLIB

Searches the current system proclib data sets for the string.



Restriction: This parameter is available for JES2 SDSF users only.

ASIS

If the input data set is ISPF packed, it is unpacked before any processing.

SKIP

If the input data is ISPF packed, no processing occurs.

LIST

Produces an intermediate member hit selection list with sortable columns. The search is limited to local partitioned data sets excluding load libraries.

FIRST

Limits the search to the first occurrence of a member if more than one partitioned data set is being processed.



Note: Enclose your search string in quotation marks if your string value conflicts with a keyword value.

How the data set or resource list is determined

If you specify PARMLIB, PROCLIB, ddnames, RESULT or /reference_member on the EFind command, these will be used to determine the data sets to be searched.

If none of these fields is specified, the EFind command will try to determine the data sets to be searched as follows:

- If there is an active EFind session, the current EFind data sets will be searched.
- From an ISPF edit or view session of a member in the reference data set. The resource names specified in the member will be searched. See [Specifying resource names in an reference member on page 563](#).



Note: You can exclude lines in the member to exclude resources from the search.

- From an ISPF 3.4 or DSLIST display, the data sets in the list will be searched.
- From an ISPF enhanced member list of a PDS or PDSE, the current data set name will be used.
- From an ISPF edit or view session of a member or data set that is not the reference data set. The data set name will be used as the search data set.
- If EFind is unable to determine the data set list then it will look for the DEFAULT member in the userid.FMNSRCH.INDEX data set.

EChange command syntax

Syntax

Use the ISPF command you have setup with the following syntax:

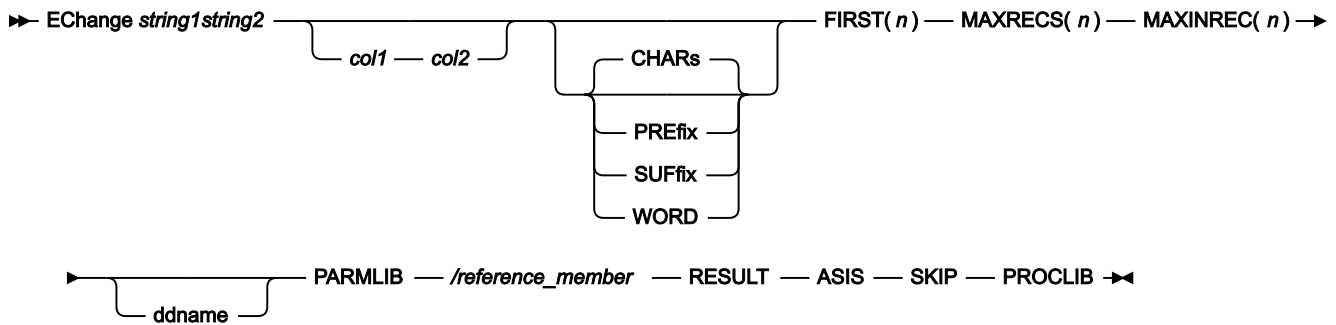

string1, string2

string1 is your search string. *string2* is your replace string.

The search strings supported are those supported by the FCH function. So you can specify the string value in the form: X'hhhh' or C'cccc' or P'pppp', and so on.

CHARS

Matches the search string anywhere in the data.

PREFIX

Matches the search string wherever it appears as a prefix in the data. To be a prefix, the matched text must be preceded by a non-alphanumeric character or be the start of a line or field, and must be followed by an alphanumeric character.

SUFFIX

Matches the search string wherever it appears as a suffix in the data. To be a suffix, the matched text must be preceded by an alphanumeric character, and must be followed by a non-alphanumeric character or be the end of a line or field.

WORD

Matches the search string wherever it appears as a word in the data. To be a word, the matched text must be preceded by a non-alphanumeric character or be the start of a line or field, and must be followed by a non-alphanumeric character or be the end of a line or field.

FIRST(*n*)

Specifies the maximum number of **total changes** that can be performed within a **single data set or PDS member**.

MAXRECS(*n*)

Specifies the maximum number of **records** that can be changed within a **single data set or PDS member**.

MAXINREC(*n*)

Specifies the maximum number of **changes** that can be made within a **single record**.

ddname

This refers to a ddname that has been allocated to your TSO/ISPF session. You can specify one or more ddnames.

For example, EC abc def SYSPROC SYSEXEC will search SYSPROC and SYSEXEC DDs for the string “*abc*” and replace it with the string “*def*”.

PARMLIB

This will search and change in the current PARMLIB data sets.

/reference_member

This will search and change the data sets specified in:

reference_dataset_name(reference_member) for the specified string.

RESULT

Search and change will be restricted to the data sets and members or path names that matched the string on the previous search.

ASIS

If the input data set is ISPF packed, it will be unpacked before any processing.

SKIP

If the input data is ISPF packed, no processing will occur.

PROCLIB

Search and change in the current system proclib data sets.



Restriction: This parameter is for JES2 users only. z/OS 2.2 SDSF is required on z/OS® systems earlier than V2.2.



Note: Enclose your search string in quotation marks if your string value conflicts with a keyword value.

Enhanced Search command panel

You can run all the options of the EFind command from the panel. File Manager maintains a history of the last 50 commands.

To invoke the panel, enter EF without specifying any parameters.



Note: When the primary panel is the reference member list, it can also be displayed using the F line command.

```

Menu Utilities Compilers Options Status Help
----- Enhanced Search Command -----
0 Command ==> _____
0 String:
0 _____ +
1 String options Columns ONED
2 - 1 Prefix From 06
3 - 2 Suffix To 8
4 - 3 Word LISH
5
6 Scope:
7 Member. _____ Edit F
9 DDnames _____ + ONED
1 DSNs . _____ + 2
1 GSA
1 F 7.1
1 Options:
1 Enter "/" to select option ISPF Pack
1 - Directory / Drill _____ Result Parmlib Proclib 1. Asis
S - Batch Jobcard Edit List First 2. Skip
F1=Help F2=Split F3=Exit F4=Expand F7=Backward
F8=Forward F9=Swap F10=Left F11=Right F12=Cancel
F10=Actions F12=retrieve
p
    
```

String

See the string description for the EFind command. This field is scrollable so you can use the F10, F11 (Left/Right), and F4 (Expand) keys to enter more than the displayed width. Leaving this field blank with the cursor that is positioned on it will display the history list of previous commands.

```

Process
-----
File Manager History Search Commands Row 1 to 13 of 14
Command ==> _____ Scroll CSR
D
R P
D I R A
I L E R
R L S M
- Search string T Member DDnames Data set names
- proclib sys1.**
s ipvsrvd PROCLIB /
- linklist /
- cruise SYSEXEC /
- cruise SYSEXEC /
- fmrn EXEC /
- apctoolz EXEC /
- fmnwdlst /
- fmninit SYSEXEC /
- isredit & line SYSEXEC
- isredit & line SYSEXEC
- abc
- getims JCL
F1=Help F2=Split JCL F3=Exit F4=Expand F7=Backward F8=Forward
F9=Swap F10=Left F11=Right F12=Cancel
    
```

From this panel, you can select (S) a previous command to populate the command panel or delete (D) a previous command from the history. If you select a previous command and run it unchanged, that command is moved to the top of the history search commands.

String Options

The default string matching option is character, but you can select **Prefix**, **Suffix**, or **Word** options. The details of the options are described in the field help. These options are the same options as available with the ISPF and File Manager editor FIND commands.

Columns

Use the **from** and **to** column numbers to limit the search area on a record as described for the ISPF editor and File Manager editor FIND commands.

Member

Use to specify your reference member. To produce a member list from which you can describe and maintain your reference members, enter a generic member name or leave the field blank with the cursor positioned on it and press **Enter**. For a detailed description of the commands available on the member list, see [Enhanced Reference List panel on page 561](#).

To edit a non-generic or the selected member, select the Edit option.

DDnames

Enter one or more ddnames that are separated by blanks. To select from a list, enter a generic ddname and use the S prefix command to select one or more ddnames from the list. A generic ddname contains at least one % or * character.

Use the scroll keys **F10**, **F11** (LEFT, RIGHT), or the **F4** (Expand) key to view or enter more than the display allows.

After you select one or more ddnames from the list, all data sets that are associated with the ddnames are searched. For example, if you enter **SYS* ISP* XYZCICS**, a selection list for ddnames matching **SYS***, and a selection list for ddnames matching **ISP*** are generated.

You can select one or more ddnames that are inserted where the generic name was typed.

DSNs

Specify one or more resource names to be searched. Examples:

- Generic data set names

```
FMN.RFM*.CNTL FMN.PM*.CNTL
```

- A generic member name

```
DTORNEY.TESTPDS(A*)
```

- A generic data set name and member name

```
DTORNEY.TESTPD*(A*)
```

- An HFS directory

```
/u/fmn/Samples
```

- A mixture of HFS and partitioned data sets

```
FMN.SOURCE FMN.SAMPLES /u/fmn/Samples
```

- A generic CICS® *applid* and Generic CICS® files

```
FI:CICSD*:MYFIL*
```

- MQ messages

```
MQ:MQSS:MY.MSGS MQ:MQSS.NEW.MSGS
```

Use the scroll keys **F10**, **F11** (LEFT, RIGHT), or the **F4** (Expand) key to view or enter more than the display allows.



Note: If you want to search the resources more than once, record the resource names in a reference member.

Directory

Enter / to limit the search to HFS directory file names and partitioned member names.



Note: If you select this option, only partitioned and HFS directories are searched.

Drill

Enter / to process all subdirectories under a specified HFS directory or all member generations in a specified version 2 PDSE.



Note: Use this option with caution because it might result in a long search.

For HFS directories, enter a number to restrict the depth of the nested subdirectories to include in the search.

For PDSEs that support member generations, enter a number to restrict the number of generations to be searched.

Result

Enter / to limit the search to the result of a previous search.

Parmlib

Enter / to include the current parmlib data sets in the search.

Proclib

Enter / to include the current system proclib data sets in the search. This parameter is for JES2 SDSF users only.

Batch

Enter / to generate JCL to run the enhanced search in a batch job.

Jobcard

Enter / to customize the File Manager job card that will be used for generating the JCL.

Edit

Enter / to change the default behavior of the Enter key from View to Edit on the resulting report.

List

Enter / to produce a member hit selection list with sortable columns. The search is limited to local partitioned data sets excluding load libraries.

First

Enter / to limit the search to the first occurrence of a member if more than one partitioned data set is being processed.

ISPF Pack

This option controls the behavior when processing ISPF packed data. Select one of the following options if your data sets contain packed data.

1. Asis

If the input data set is packed, it will be unpacked before any processing.

2. Skip

If the input data is packed, no processing occurs.

Leave this option blank when you do not want File Manager to check for packed records or unpack records for processing.



Note: This is recommended for optimal performance.

Enhanced Search member hit selection list panel

This panel appears if a successful enhanced search is performed with the List option specified.

Figure 159. Enhanced Search member hit selection list panel

Process Options Help											
File Manager				Member hit selection list				Row 00001 of 00048			
Command ==>											Scroll CSR
Data set SYS1.PROCLIB.TSD3.USER +											
Name	Prompt	Lib	Size	Created	Changed		ID	Init	Mod		
IPVBRETD	*	2	29	2018/11/16	2018/11/16	14:15:25	TYRONED	29	0		
IPVSAVD9		2	25	2017/01/16	2017/01/16	15:16:32	MHUGHES	25	0		
IPVSRVBD		2	31	2018/04/16	2020/01/06	12:24:48	BRETD	23	0		
IPVSRVC		2	25	2015/08/10	2021/07/06	18:48:10	TYRONED	25	0		
IPVSRVCL		2	51	2015/04/02	2016/11/16	14:22:29	JPHILP	17	0		
IPVSRVCP		2	15	2015/03/25	2016/11/16	14:22:33	JPHILP	15	0		
IPVSRVC4		2	24	2013/09/27	2016/11/16	14:22:35	JPHILP	21	0		
IPVSRVC5		2	27	2018/02/07	2018/05/09	13:02:40	KEISTEW	149	0		
IPVSRVD		1	24	2013/09/16	2013/09/23	08:22:43	TYRONED	23	0		
IPVSRVD		2	28	2015/08/10	2021/05/18	15:58:24	TYRONED	27	28		
IPVSRVDA		2	40	2017/04/27	2017/05/22	14:54:15	BRETD	36	0		
IPVSRVDB		2	87	2017/05/04	2017/05/22	08:51:21	TRAVIST	24	0		
IPVSRVDL		2	23	2015/03/25	2017/07/27	16:00:21	JPHILP2	21	0		
IPVSRVDP		2	16	2015/03/25	2017/06/22	11:54:24	JPHILP	15	0		
IPVSRVDX		2	28	2021/05/06	2021/05/06	10:44:16	TYRONED	28	0		
IPVSRVD1		2	15	2015/06/17	2016/12/01	15:24:07	JPHILP	15	0		

Field and Column descriptions

Data set

This field shows the first data set. If the resultant members are in more than one data set, then a Lib column is displayed. Position on the adjacent + sign and press **Enter** to view the other data set names.

Name

This is the member name.

Prompt

This field is used to display status values relevant to the action being performed.

Lib

This column appears if more than one library is processed.

Rel

This column appears only if a generation member is found in the search. This is the relative generation number of the member generation. The relative generation is either 0 or a negative number. The current member always has a relative generation = 0, with the most recent generation created having a relative generation of -1, then -2, and so on. The maximum number of generations is defined by the MAXGENS parameter when the PDSE version 2 data set is created.

Gen

This column appears only if a generation member is found in the search. This is the absolute generation number of the member generation. The absolute generation is either 0 or a positive number. The current member always has an absolute generation = 0. The absolute generation number never changes, with the first generation created having an absolute generation = 1, and always increases as each new generation is created.

Size**Created**

This is the creation date in the format *yyy/mm/dd*.

Changed

The date and time the member was last changed.

ID

The user ID of the last user who created or changed the member.

Init

The initial number of records in the member.

Mod

The number of modified lines in the member.

VV.MM

The version and revision number of the member.

Line commands

You can enter the following commands in the prefix area of the data display:

E

Edit the member positioning for the first hit line.

S

Show the enhanced search report for the selected member.

V

View the member positioning to the first hit line.

Example**Available commands**

The following primary commands are available:

- [BOTTOM primary command on page 1122](#)
- [DOWN primary command on page 1146](#)
- [FIND/FX primary command on page 1157](#)
- [HEX primary command on page 1172](#)
- [LEFT primary command on page 1178](#)
- [LOCATE primary command on page 1182](#)
- [REFRESH primary command on page 1205](#)
- [RESET primary command on page 1208](#)
- [RFIND primary command on page 1211](#)

- [RIGHT primary command on page 1212](#)
- [SORT primary command on page 1224](#)
- [TAILOR primary command on page 1230](#)
- [TOP primary command on page 1232](#)
- [UP primary command on page 1234](#)

Enhanced Change command panel

You can run all the options of the EChange command from the panel. File Manager maintains a history of the last 50 commands.

To invoke the panel, enter EC without specifying any parameters.



Note: When the primary panel is the reference member list, it can also be displayed using the C line command.

```

----- Enhanced Change Command -----
- FMNPCHNG ==> _____
I
0 Command:
0 Search _____ +
0 Replace _____ +
1 Options          Columns          Limits          Change
2 - 1 Prefix      ----- From      ----- MAXINREC    - ISPF
3   2 Suffix      ----- To        ----- MAXRECS     - Memory
4   3 Word
5 Member ----- _ Edit
6
7 Scope:
9 Member _____ _ Edit
1 DDnames _____ +
1 DSNs . _____ +
1
1 Options:
1 Enter "/" to select option
1 _ Immediate _ Result _ Parmlib _ Proclib _ 1. Asis      ISPF Pack
S  _ Batch     _ Jobcard _ Edit      _ 2. Skip
  F1=Help     F2=Split  F3=Exit    F4=Expand   F7=Backward
  F8=Forward  F9=Swap   F10=Left   F11=Right   F12=Cancel
F

```

Search

See the *string1* description for the EChange command. This field is scrollable so you can use the F10, F11 (Left/Right), and F4 (Expand) keys to enter more than the displayed width. Leaving this field blank with the cursor that is positioned on it will display the history list of previous commands.

Process		History Search Commands				Row 1 to 13 of 13	Scroll	CSR
File Manager	Command ==>							
		O	Member	Refer	DDnames	Data set names	I R A R T	
		P	ABCDEF				M E R O C	
Search	Replace	T					M S M C H	
- 'SETVAR '	' '			SETVAR				
- GALEVEL	PFM17237					IVP.V1R8M0.SERVE		
- new	old			VSAM				
- a	b					fmn.f2data.ksds		
- abc	def		ABCDEF	WEBINAR1				
-			ABCDEF			dtorney.cntl / /		
- FMN.SCLMV1	FMN.SCLMV1					fmn.f2data		
- '@@FLMETP,	'@@FLMETP,			V14PROJ		fmn14svc.projdef		
***** Bottom of data *****								
F1=Help	F2=Split	F3=Exit	F4=Expand	F7=Backward	F8=Forward			
F9=Swap	F10=Left	F11=Right	F12=Cancel					

From this panel, you can select (S) a previous command to populate the command panel or delete (D) a previous command from the history. If you select a previous command and run it unchanged, that command is moved to the top of the history search commands.

Replace

See the *string2* description for the EChange command. This field is scrollable so you can use the F10, F11 (Left/Right), and F4 (Expand) keys to enter more than the displayed width.

String Options

The default string matching option is character, but you can select **Prefix**, **Suffix**, or **Word** options. The details of the options are described in the field help. These options are the same options as available with the ISPF and File Manager editor FIND commands.

Columns

Use the **from** and **to** column numbers to limit the search area on a record as described for the ISPF editor and File Manager editor FIND commands.

Limits

Each field specifies a number. For a description of these fields refer to the MAXINREC(n), MAXRECS(n) and FIRST(n) parameters for the EChange command or press F1 with the cursor on the field.

Change

Use **ISPF** and **Memory** as follows:

ISPF

Enter / to enable the ISPF change behavior of compressing intermediate blanks in unquoted strings.

Memory

Enter / to perform a change in memory. The following changes occur:

1. Opens the data set or member for input and reads all the records into memory.
2. Supports record length changes when the search and replace strings are different lengths and the resultant length is less than or equal to the maximum logical record length of a variable length data set.
3. Opens for output and writes all the records loaded back to the data set when a change is made.



Note:

1. This option is ignored for VSAM files.
2. This option can be used to avoid the restrictions associated with opening the data set in UPDATE mode.
3. The function is terminated if there is insufficient memory to load the entire member or data set into memory. A larger region size may be required.
4. For compressed data sets, the change is always performed in memory.
5. Memory processing performs slower than update in place.

Member

The change command member is found in the change command data set and contains one or more change commands. You can list the members on your change command data set by placing the cursor on this field and entering a blank or generic name. For a detailed description of the commands available on the member list, see [Enhanced Reference List panel on page 561](#).

To edit a non-generic or the selected member, select the Edit option. The change command data set will be created the first time you enter a member name in this field or attempt to list members on your change command data set. The member list will allow you to describe your change member for future reference. Each member should contain one change command per line.

Scope

The scope fields are the same as for enhanced search.



Note: MQ and HFS resource names are not supported by the enhanced change facility.

Options

Immediate

Enter / to perform the updates immediately. If you select this option, the enhanced change report will show the changes that have already been made. If the option is not selected the enhanced change report will show changes that will be made if you confirm the changes when exiting the report.

Result

Enter / to limit the search to the result of a previous search.

Parmlib

Enter / to include the current parmliib data sets in the search.

Proclib

Enter / to include the current system proclib data sets in the search. This parameter is for JES2 SDSF users only.

Batch

Enter / to generate JCL to run the enhanced search in a batch job.

Jobcard

Enter / to customize the File Manager job card that will be used for generating the JCL.

Edit

Enter / to change the default behavior of the Enter key from View to Edit on the resulting report.

ISPF Pack

This option controls the behavior when processing ISPF packed data. Select one of the following options if your data sets contain packed data.

1. Asis

If the input data set is packed, it will be unpacked before any processing.

2. Skip

If the input data is packed, no processing will occur.

Leave this option blank when you do not want File Manager to check for packed records or unpack records for processing.



Note: This is recommended for improved performance.

Enhanced Change command member list panel

This panel displays the reference member list.

You can update the descriptions for each member by overtyping the description field. It will be displayed if you press Enter with the cursor on the blank member field value or if you enter a generic member name.

```

Process
-----
File Manager          Enhanced Change Command Members          Row 1 to 2 of 2
Command ==>> ----- Scroll CSR
Data set name      DTORNEY.FMNCHNG.COMMANDS
Member pattern     *
Name      Description          Date Changed          Size
- TEST1   multiple commands        2017/07/01 18:40      3
- TEST2   simple command             2017/12/22 13:19      1
***** Bottom of data *****
    
```

Primary commands

L string

Search for the value in the member name and description fields. Example:

L JCL

F string

Search the contents of the members for one or more strings. This performs an enhanced search of the reference data set for the string you entered. Use AND & OR | connectors to provide more than one string.

From the Enhanced Search Report pressing Enter on the member name line results in the associated member being selected for the previous command panel.

S member

Select a member for the previous command panel.

If the member does not exist an edit session will open in which you can create the member.

Line commands

S

Select a member for the previous command panel.

E

Edit the member

V

View the member

I

Insert a new member

R

Rename the member

D

Delete the member

Navigating the Enhanced search and Change report

You can navigate the reports as follows:

- Position the cursor on any line to view or edit the data set/member or path/file name.
 - Press **Enter** to view the data.
 - Press **F4** to edit the data.

The resultant view or edit session is positioned to the specific line if the cursor was on a data line, or at the first occurrence of the string if the cursor was positioned on a data set, member, path or name line. No action is taken if the cursor is not positioned in the report area.

- Position the cursor to the INDEX field in the heading to see the current list of data sets being searched.
- Press **F4** with the cursor positioned on the command line to select SUM, DS, or RES primary commands from a menu panel.
- Enter SUM primary command and press **F4** to see only data set , member, path and name lines.
- Enter DS primary command and press **F4** to see only data set and path lines.
- Enter RES primary command and press **F4** to return to original result with the search string highlighted.

For more information about navigating the reports with the **F4** function key, see [Using the F4 function key on page 581](#).

Using the F4 function key

Using F4 for enhanced search report filtering commands

When in a view session of the enhanced search report and your cursor is positioned on the command line you can enter F4 which will display the selection menu as illustrated below.

```

File Edit Edit_Settings Menu Utilities Compilers Test Help
-----
V Command ==> _____ EFAULT          Col 00001 00072
C                               Scroll ==> CSR
* 1 SUM      Only data sets/members ta *****
0 2 DS       Only data sets
0 3 RES      Original report
0
0
000005 -----
000006 >Data Set: FMN.PK95812.CNTL
000007 >Member : DRIVER
000008      12 // SET IPVLVL=ABC          <===== DON'T CHANGE UNLESS REQ
000009 -----
000010 >Data Set: FMN.PM16665.CNTL
000011 >Member : OVVAB
000012      32 OVLY_VAR('S','ABCDE');
000013      51 OVLY_VAR('S','ABCDE');
000014 >Member : OVVABRX
000015      32 OVLY_VAR('S','ABCDE');
000016      51 OVLY_VAR('S','ABCDE');
000017 -----
000018 >Data Set: FMN.PM22660.CNTL
000019 >Member : RVW

```

The options can be selected by number or placing your cursor on the value SUM, DS or RES and hitting enter. If you have a 3270 emulator session where you can set a double click to enter then you can double click on the value to drive the command.

The command descriptions are as follows:

Sum

This will show data set, member, path and file name lines only.

DS

This will show data set and path lines only.

RES

This will reset to the original search report highlighting.

Using F4 to edit a resource from the enhanced search report

If the cursor is positioned on the data set name or resource name where '>' is in column 1, pressing F4 will display the selection window. For more information, see [Using F4 from any edit or view session when positioned on a string or word on page 583](#).

If the cursor is positioned anywhere else on the search report and the command line is blank then hitting **F4** will result in an edit session of the corresponding data set. The resultant edit session will be positioned at the line shown on the enhanced search report.



Note: Pressing Enter instead of **F4** will result in a view session positioned to the referenced line.

```

File Edit Edit_Settings Menu Utilities Compilers Test Help
VIEW      Enhanced Search Report ABC Index DEFAULT          Col 00001 00072
Command ==> _____ Scroll ==> CSR
***** ***** Top of Data *****
000001 -----
000002 >Data Set: FMN.PI07105.CNTL
000003 >Member : DSC0C4A
000004      31  CHG_OUT('FMB','@B@',0)
000005 -----
000006 >Data Set: FMN.PK95812.CNTL
000007 >Member : DRIVER
000008      12  // SET IPVLVL=@B@          <===== DON'T CHANGE UNLESS REQ
000009 -----
000010 >Data Set: FMN.PM16665.CNTL
000011 >Member : OVVAB
000012      32  OVLV_VAR('S','@B@DE');
000013      51  OVLV_VAR('S','@B@DE');
000014 >Member : OVVABRX
000015      32  OVLV_VAR('S','@B@DE');
000016      51  OVLV_VAR('S','@B@DE');
000017 -----
000018 >Data Set: FMN.PM22660.CNTL
000019 >Member : RVW
    
```

Positioning at line 13 which is line 51 of member OVVAB and hitting F4 results in:

```

  File  Edit  Edit_Settings  Menu  Utilities  Compilers  Test  Help
-----
EDIT          FMN.PM16665.CNTL(OVVAB) - 01.03          Columns 00001 00072
Command ==>                                         Scroll ==> CSR
000051 OVLY_VAR('S','@#@#@#@');
000052 PRT_VAR('S');
000053 /+
***** ***** Bottom of Data *****

```

Using F4 from any edit or view session when positioned on a string or word

You can use the **F4** function key from any ISPF edit or view session and take advantage of the features provided. This doesn't have to be associated with an enhanced search.

In the following screen we position the cursor on the word ZINREC and press **F4**:

```

  File  Edit  Edit_Settings  Menu  Utilities  Compilers  Test  Help
-----
V      ZINREC
C      File Manager
0      Edit/View  Utility  Template
0      Command ==>
0
0      1 on page 583 View      View resource
0      2 on page 583 Edit      Edit resource
0      3 on page 583 Select    Select resource list
0      4 on page 584 Dslist    ISPF data set list
0      5 on page 584 Search    Nested search
0      6 on page 584 All      Show all occurrences
0      7 on page 584 First     Find first occurrence
0      8 on page 584 Prev      Find previous occurrence
0      9 on page 584 Next      Find next occurrence
0     10 on page 584 Last      Find last occurrence
0     11 on page 584 Rsearch   Search the resource
0     12 on page 584 PDSE2     Workbench
0     13 on page 584 Create     Allocate data set
0
0      t TALLY register
0

```

The selection window is displayed with options that can be selected by number or cursor position and enter. The word or data set name is displayed in the window title. This may be truncated to fit the window, but will not be truncated in the selected process.

The command descriptions are as follows:

1 View

If the cursor is positioned on a valid File Manager resource name then an ISPF view session is invoked for the resource. File Manager is used for resources not supported by ISPF view.

2 Edit

If the cursor is positioned on a valid File Manager resource name then an ISPF edit session is invoked for the resource. File Manager is used for resources not supported by ISPF edit.

3 Select

If the cursor is positioned on a valid File Manager resource name then a File Manager selection list for matching resource names is produced and you can use the S prefix command to select one or more names

that will be inserted at the current word start position replacing the current word. If you select more than one, these are inserted at the same start location on inserted lines.



Note: For HFS directories S selects and / displays nested directory entries.

4 Dslist

If the cursor is positioned on a valid data set name then an ISPF data set list is produced for data sets matching the name

5 Search

Perform a nested search for all occurrences of the word the cursor is currently positioned on.



Note: The data sets to be searched will be the active enhanced search resource list if you are editing or viewing as a result of an enhanced search command or the current data set if you are in a view or edit session..

6 ALL

This shows all records in the current view or edit session that contain the word the cursor is positioned on.

7 FIRST

This finds the first occurrence of the word the cursor is positioned on.

8 PREV

This finds the previous occurrence of the word the cursor is positioned on.

9 NEXT

This finds the next occurrence of the word the cursor is positioned on.

10 LAST

This finds the last occurrence of the word the cursor is positioned on.

11 RSearch

This displays the **Enhanced Search Command** panel with the DSNs field populated with the string name that you are positioned on.

12 PDSE2

This displays the PDSE Workbench member list display for the cursor positioned data set name.

13 This displays one of the following options:

Create

Allocates a new data set when the cursor-positioned data set name does not exist.

Change

Changes data set attributes when the cursor-positioned data set name is a non-VSAM data set.
For example, resize or convert a PDS to a PDSE, PDSE to PDSE2, and vice versa.

List

Invoke the File Manager catalog services dialog when the cursor-positioned data set name is a VSAM data set.

Data set name variable substitution

For View, Edit, Select, Dslist and Rsearch commands or any of the File Manager pull-down options, variable substitution is performed if the variable can be resolved within the current edit or view session. If the value in the window title has *&variable* names as a part of the string, File Manager resolves the variables when you select a command that requires a valid data set name.

See the following example:

```

File Edit Edit Settings Menu Utilities Compilers Test Help
-----
ISREDDE2  SYS1.PROCLIB.SYSPLEXD.USER(IPVSRVD) - 01.08      Columns 00001 00072
Command ==> _____ Scroll ==> CSR
000018 //SYSPRINT DD SYSOUT=*
000019 //STDOUT   DD SYSOUT=*
000020 //IPVTRACE DD SYSOUT=*
000021 /* Configuration details
000022 // SET FM=FMSTYLE&FMSTYLE
000023 //CONFIG   DD DISP=SHR,DSN=IPV.V1R8M0.SERVER.CONFIGS.&BLD(&SSL)
000024 //         DD DISP=SHR,DSN=IPV.V1R8M0.SERVER.CONFIGS.&BLD(&FM)
000025 //         DD DISP=SHR,DSN=IPV.V1R8M0.SERVER.CONFIGS.&BLD(FAV13)
000026 //         DD DISP=SHR,DSN=IPV.V1R8M0.SERVER.CONFIGS.&BLD(APA)
000027 //         DD DISP=SHR,DSN=IPV.V1R8M0.SERVER.CONFIGS.&BLD(DT)
***** Bottom of Data *****

```

Position the cursor on IPV.V1R8M0.SERVER.CONFIGS.&BLD(&FM) and press **F4**.

```

File Edit Edit Settings Menu Utilities Compilers Test Help
-----
- IPV.V1R8M0.SERVER.CONFIGS.&BLD -
V File Manager - 01.21      Columns 00001 00072
C Edit/View Utility Template Scroll ==> CSR
0
0 Command ==> _____
0
0 1 View      View resource
0 2 Edit      Edit resource
0 3 Select    Select resource list
0 4 Dslist    ISPF data set list
* 5 Search    Nested search
0 6 All       Show all occurrences
0 7 First     Find first occurrence
0 8 Prev      Find previous occurrence
0 9 Next      Find next occurrence
0 10 Last     Find last occurrence
0 11 Rsearch  Search the resource
0 12 PDSE2    Workbench
0 13 Change   Change data set attributes
0
0

```

Select 1 to view the data set and then press Enter.

```

  File  Edit  Edit_Settings  Menu  Utilities  Compilers  Test  Help
-----
ISREDDE2  IPV.V1R8M0.SERVER.CONFIGS.AD48553(FMSTYLEX) - 0 Columns 00001 00072
Command ==> _____ Scroll ==> CSR
***** ***** Top of Data *****
==MSG> -Warning- The UNDO command is not available until you change
==MSG>         your edit profile using the command RECOVERY ON.
000001 * Build creation process updates suffix to ptf level
000002 *****
000003 CONFIG=FM * Mandatory identifier
000004 * CONFIG=FM required for both ADFzCC and ZCC
000005 REST=YES
000006 API_TIMEOUT=300
000007 *
000008 *
000009 * Means able to run authorised.
000010 SPAWN_PROGRAM=FMNCSEP
000011 *
000012 SPAWN_STEPLIB=FMN.V14R1M0.OPTIONS.GMBLD1:
000013 FMN.V14R1M0.SFMNMODA.GMBLD1:
000014 FMN.V14R1M0.SFMNMOD1.GMBLD1
000015
000010 SPAWN_PARMS_SECTION
000011 FMNTRC=SYSOUT=H
000013 SYSPRINT=SYSOUT=H
000014 STDOUT=SYSOUT=H
000015 SYSTSPRT=SYSOUT=H
000016
000017 FMNLIB=FMN.V14R1M0.OPTIONS.AD48553:

```

Notice that the data set name has been changed as variable substitution has been performed.

Using the File Manager pull-down options from your F4 function key

To invoke a File Manager function where the entry panels are populated with the resource names from your edit or view session, use the F4 function key with the cursor positioned on a data set, HFS path/file, File Manager CICS® resource or File Manager MQ resource name. This is a simple way to populate FM functions from either a JCL member or a member that was set up with data sets in a particular order. If you followed the convention that is documented as follows or your JCL is running a File Manager function where the data set names and associated template names can be determined, File Manager populates the specific File Manager function that you select.

Populating File Manager Base function with more than one resource or data set name

The common File Manager Base function has one or two primary data sets, and one or two templates depending on the function. You can define a reference member or any member to provide data sets names in the following format:

```
DSN1(Member) Template1(member) DSN2(Member) Template2(Member)
```

These are four data sets names with optional member names. Use a dash (-) as a place holder where a data set name is not provided. The data set names and member names can be generic.

Example:

Edit a reference member with the following data sets:

```
FMN.FROM.PANELS - FMN.TO.PANELS -
```

Place the cursor on FMN.FROM.PANELS anywhere in the data set name and press **F4**.

```

File Edit Edit_Settings Menu Utilities Compilers Test Help
----- FMN.FROM.PANELS -----
E File Manager 0 Columns 00001 00072
C Edit/View Utility Template Scroll ==> CSR
*
= Command ==> _____
=
0 1 View View resource
0 2 Edit Edit resource
* 3 Select Select resource list
4 Dslist ISPF data set list
5 Search Nested search
6 All Show all occurrences
7 First Find first occurrence
8 Prev Find previous occurrence
9 Next Find next occurrence
10 Last Find last occurrence
11 Rsearch Search the resource
0 12 PDSE2 Workbench
0 13 Change Change data set attributes

Data *****

```

Place your cursor on Utility and press **Enter**.

```

File Edit Edit_Settings Menu Utilities Compilers Test Help
----- FMN.FROM.PANELS -----
E File Manager 0 Columns 00001 00072
C Edit/View Utility Template Scroll ==> CSR
*
= Command == 1. Create
= 2. Print
0 1 View 3. Copy
0 2 Edit 4. Catalog service
* 3 Select 5. Find/change
4 Dslist 6. Compare
5 Search 7. Load module browse
6 All 8. Load module compare
7 First 9. Exit
8 Prev
9 Next Find next occurrence
10 Last Find last occurrence
11 Rsearch Search the resource
0 12 PDSE2 Workbench
0 13 Change Change data set attributes

Data *****

```

Select option 3 or place your cursor on COPY and press **Enter**.

```

Process  Options  Help
-----
File Manager                      Copy Utility
Command ==> _____

From Partitioned, Sequential or VSAM Data Set, or HFS file:
Data set/path name . . 'FMN.FROM.PANELS' +
Member . . . . . _____ (Blank or pattern for member list)
Volume serial . . . . . _____ (If not cataloged)
Start key . . . . . _____ key or slot
Skip count . . . . . _____ Include _____ Repeat skip _____
Copy count . . . . . ALL number of records to be copied
From Copybook or Template:
Data set name . . . . . _____
Member . . . . . _____ (Blank or pattern for member list)
Processing Options:
Copybook/template      Enter "/" to select option
 2 1. Above            - Batch execution          - Advanced member selection
   2. None             - Use proc *                / Skip member name list
   3. Create dynamic   - Ignore length mismatch   - REXX member selection: D
- Edit template        - JCL Source format         - Directory integrity
- Type (1,2,S)         - MQ Include descriptor     - Report PDS record counts
- Export mode          - MQ Get destructive        - Binary mode, reflen_____
    
```

Press **Enter**:

```

Process  Options  Help
-----
Copy from File Manager.FROM.PANELS
Command ==> _____

To Partitioned, Sequential or VSAM Data Set, or HFS file:
Data set/path name . . 'FMN.TO.PANELS' +
Member name (or mask) . _____ (Blank or pattern for member list)
Volume serial . . . . . _____ (If not cataloged)

Processing Options:
Disposition              Execution "/" options          ISPF Packing
 1 1. Old or Reuse      / Replace members            4 1. Asis
   2. Mod                - Binary mode, reflen       2. Pack
Stats Option              3. Unpack
 1 1. Off
   2. Force              4. None
                        5. Skip
    
```

The **from** and **to** panels were populated according to the specification in the member.

Populating File Manager full-screen functions from File Manager batch JCL

Consider the following COPY job.

```

File Edit Edit_Settings Menu Utilities Compilers Test Help
VIEW          DTORNEY.CNTL(BNPPRF) - 01.10          Columns 00001 00072
Command ==>                                     Scroll ==> CSR
000010 //AFTER EXEC PGM=FILEMGR
000011 //SYSPRINT DD SYSOUT=*
000012 //IDIOPTS DD DSN=FMN.IDIOPTS,DISP=SHR
000013 //DDOUT   DD DISP=SHR,DSN=FMN.BNPPRF.TO.LARGE
000014 //SYSIN DD *
000015 $$FILEM DSC DSNIN=FMN.BNPPRF.FROM.LARGE,
000016 $$FILEM TCIN=DTORNEY.TEMPLATE(BNPPFROM),
000017 $$FILEM DISP=OLD,IGNLEN=YES,
000018 $$FILEM TCOUT=DTORNEY.TEMPLATE(BNPPTO)
***** Bottom of Data *****

```

Place the cursor on the input data set for the copy and run a File Manager compare.

```

File Edit Edit_Settings Menu Utilities Compilers Test Help
- FMN.BNPPRF.FROM.LARGE
V File Manager
C Edit/View Utility Template
0
0 Command == 1. Create
0 2. Print
0 1 View 3. Copy 0.LARGE
0 2 Edit 4. Catalog service
0 3 Select 5. Find/change
0 4 Dslist 6. Compare
0 5 Search 7. Load module browse
0 6 All 8. Load module compare
* 7 First 9. Exit
8 Prev
9 Next Find next occurrence
10 Last Find last occurrence
11 Rsearch Search the resource
0 12 PDSE2 Workbench
0 13 Change Change data set attributes
Data *****

```

Select the compare option.

```

Process Options Help
File Manager Compare Utility : Old Data Set
Command ==>
More: +
"Old" Partitioned, Sequential or VSAM Data Set, or HFS file:
Data set/path name . . 'FMN.BNPPRF.FROM.LARGE' +
Member . . . . . (Blank or pattern for member list)
Volume serial . . . . . (If not cataloged)
Start key . . . . . key or slot
Skip count . . . . . number of records to be skipped
Compare count . . . . . ALL number of records to be compared

"Old" Copybook or Template:
Data set name . . . . . 'DTORNEY.TEMPLATE'
Member . . . . . BNPPFROM (Blank or pattern for member list)

Processing Options:
Copybook/template usage Enter "/" to select option
1 1. Above - Edit template Type (1,2,S)
2 2. Previous - Advanced member selection
3 3. None / Skip member name list
4 4. Create dynamic / Batch execution
- Binary mode, reclen _____

```

Press **Enter**.

```

Process  Options  Help
-----
File Manager          Compare Utility : New Data Set
Command ==>> _____

"New" Partitioned, Sequential or VSAM Data Set, or HFS file:
Data set/path name . . 'FMN.BNPPRF.TO.LARGE' +
Member . . . . . _____ (Blank or pattern for member list)
Volume serial . . . . . _____ (If not cataloged)
Start key . . . . . _____ key or slot
Skip count . . . . . _____ number of records to be skipped
Compare count . . . . . _____ number of records to be compared

"New" Copybook or Template:
Data set name . . . . . 'DTORNEY.TEMPLATE'
Member . . . . . BNPPTO _____ (Blank or pattern for member list)

Processing Options:
Copybook/template usage          Enter "/" to select option
 1 1. Above                      _ Edit template _ Type (1,2,S)
 2 2. Previous                   _ Binary mode, reclen _____
 3 3. None
 4 4. Create dynamic
    
```

The **From** data set and template and **To** data set and template names were determined from the JCL, and you can run a compare.

F4 edit macro hot spots

To bypass the menu panel displayed by the F4 edit macro, a value can be entered either on the command line or assigned to a function key using the ISPF editor KEYS command.

For LIBDEF invocation, the format is:

```
FMNELIBD KEY value
```

For example: `FMNELIBD KEY 2`, invokes the edit function directly.

For non-LIBDEF invocation, the format is:

```
FMNSRCHK value
```

For example, `FMNSRCHK 2`, invokes the edit function directly.

To bypass the menu using a command-line value:

Type `2` on the command line and press **F4** with the cursor positioned on a data set name to edit a data set directly.

The **Report View Options** panel is displayed when the function key is used with the cursor on the command line of an enhanced search or indexed search report.

```

File Edit Edit_Settings Menu Utilities Compilers Test Help
-----
- Report View Options
V Command ==>> ROCLIB Col 00001 00072
C Scroll ==>> CSR
* 1 SUM Only data sets/members ta *****
0 2 DS Only data sets
0 3 RES Original report
0
0
0
    
```

Table 13. Report View Options hot spots

Option	Value
1 SUM	SUM
2 DS	DS
3 RES	RES

The enhanced search string selection menu is displayed when the cursor is positioned in the data area, in either a view or edit session, or on a data set name in an enhanced or indexed search report.

```

SYS1.PROCLIB.FMD3.USER
File Manager
Edit/View Utility Template
-----
Command ==>
0
0 1 View View resource
0 2 Edit Edit resource
0 3 Select Select resource list
0 4 Dslist ISPF data set list
0 5 Search Nested search
0 6 All Show all occurrences
0 7 First Find first occurrence
0 8 Prev Find previous occurrence
0 9 Next Find next occurrence
0 10 Last Find last occurrence
0 11 Rsearch Search the resource
0 12 PDSE2 Workbench
0 13 Change Change data set attributes
0
0
0
0
0
0
-----
Compilers Test Help
ROCLIB Col 00001 00072
Scroll ==> CSR
ta *****
    
```

The Primary Options menu panel can be bypassed by providing one of the following values on either the command line or using a function key definition.

Table 14. F4 string selection menu

Option	Value
1 View View resource	1
2 Edit Edit resource	2
3 SElect Select resource list	3
4 Dslist ISPF data set list	4
5 Search Nested search	5
6 ALL Show all occurrences	6
7 FIRST Find first occurrence	7
8 PREV Find previous occurrence	8
9 NEXT Find next occurrence	9

Table 14. F4 string selection menu (continued)

Option	Value
10 LAST Find last occurrence	10
11 Rsearch Search the resource	11
12 PDSE2 Workbench	12
13 Create Allocate data set	13

Table 15. Edit/View pull-down menu

Option	Value
1. View	FMDSV
2. Edit	FMDSE

Table 16. Utility pull-down menu

Option	Value
1. Create	FMDSG
2. Print	FMDSP
3. Copy	FMDSC
4. Catalog service	FMSCS
5. Find/Change	FMFCH
6. Compare	FMDSM
7. Load module browse	FMVLM
8. Load module compare	FMCLM
9. Enhanced change	FMChange

Table 17. Template pull-down menu

Option	Value
1. Print	FMPBK
2. Edit	FMPED
3. Update	FMPUP
4. Import	FMPIMP
5. Export	FMPEXP
6. List	FMPWT

Converting the BATCH report output to a navigational report

The search report for a batch job can be found in the FMNFRPT DD. If you edit the report, you can convert the report to an Enhanced Search Report format by pressing F4 with the cursor positioned on the command line. This allows enhanced search navigation to nested view and edit sessions via the enter and F4 keys.



Note: Nested searches are restricted to the data sets that are referenced in the batch search report.

Example

```

Menu Utilities Compilers Options Status Help
- Enhanced Search Command -----
0 Command ===> _____
0 String:
0 ISREDIT & LINE _____ + ONED
1 String options Columns 06
2 - 1 Prefix _____ From 8
3 - 2 Suffix _____ To
4 - 3 Word _____ LISH
5
6 Scope:
7 Member. DEMO1 _____ Edit F
9 DDnames _____ ONED
1 DSNs . _____ + 2
1 _____ + GSA
1 _____ F 7.1
1 Options:
1 Enter "/" to select option
1 - Directory - Drill - Result - Parmlib - Proclib - 1. Asis ISPF Pack
S - Batch - Jobcard - Edit - List - First - 2. Skip
F1=Help F2=Split F3=Exit F4=Expand F7=Backward
F8=Forward F9=Swap F10=Left F11=Right F12=Cancel
F10=Actions F12=retrieve
p

```

Press **Enter**.

```

File Edit Edit_Settings Menu Utilities Compilers Test Help
EDIT DTORNEY.FMD2.SPFTEMP1.CNTL Columns 00001 00072
Command ===> Sub Scroll ===> CSR
***** ***** Top of Data *****
000001 //FMNEBATJ JOB SDF2,
000002 // ACCT,MSGCLASS=H,
000003 // NOTIFY=&SYSUID,CLASS=A,
000004 // MSGLEVEL=(1,1)
000005 //*
000006 //FMBAT EXEC PGM=FILEMGR
000007 //SYSPRINT DD SYSOUT=*
000008 //FMNFRPT DD SYSOUT=*
000009 //SYSIN DD *
000010 $$FILEM FCHM ,
000011 $$FILEM DSNLIST=(FMN.EXEC,
000012 $$FILEM FMN.PANELS,
000013 $$FILEM FMN.SKELS,
000014 $$FILEM FMN.MSGS),
000015 $$FILEM DRILL=NO
000016 F ISREDIT & LINE WORD
***** ***** Bottom of Data *****
F1=Help F2=search F3=Exit F4=cnext F5=Rfind F6=Rchange
F7=Up F8=Down F9=Swap F10=Left F11=Right F12=retrieve

```

This example is JES2, so use SDSF to view the JOB output.

```

  Display Filter View Print Options Search Help
-----
SDSF HELD OUTPUT DISPLAY ALL CLASSES LINES 222          LINE 1-1 (1)
COMMAND INPUT ==>                                     SCROLL ==> CSR
PREFIX=FMNEBAT*  DEST=(ALL)  OWNER=*  SORT=JOBNAME/A  SYSNAME=
NP  JOBNAME  JobID  Owner  Prty  C  ODisp  Dest          Tot-Rec  Tot-
?   FMNEBATJ  JOB48740  DTORNEY  144  H  HOLD  LOCAL          222

```

Press **Enter** and use the SE line command to edit the batch report DD FMNFRPT.

```

  Display Filter View Print Options Search Help
-----
SDSF JOB DATA SET DISPLAY - JOB FMNEBATJ (JOB48740)    LINE 1-5 (5)
COMMAND INPUT ==>                                     SCROLL ==> CSR
PREFIX=FMNEBAT*  DEST=(ALL)  OWNER=*  SORT=DDNAME/D  SYSNAME=
NP  DDNAME  StepName  ProcStep  DSID  Owner  C  Dest          Rec-Cnt  Page
   SYSPRINT  FMBAT          103  DTORNEY  H  LOCAL          31
   JESYSMSG  JES2           4    DTORNEY  H  LOCAL          65
   JESMSGGL  JES2           2    DTORNEY  H  LOCAL          26
   JESJCL    JES2           3    DTORNEY  H  LOCAL          21
se  FMNFRPT  FMBAT          102  DTORNEY  H  LOCAL          79

```

Press **Enter**.

```

SDSF EDIT      FMNEBATJ (JOB48740) FMNFRPT          Columns 00001 00072
Command ==>   _____ Scroll ==> CSR
***** Top of Data *****
==MSG> -Warning- The UNDO command is not available until you change
==MSG>          your edit profile using the command RECOVERY ON.
-----
000001
000002 >Data Set: FMN.EXEC
000003 >Member : ACCAPAR
000004     147     address ISREDIT 'LINE_AFTER .ZLAST = DATALINE' string
000005     198     ADDRESS ISREDIT 'LINE 'cline '=' (curline)'
000006 >Member : ADDTEMP
000007     46     address ISREDIT 'LINE_AFTER .ZLAST = DATALINE' string
000008 >Member : BCKAPAR
000009     137     address ISREDIT 'LINE_AFTER .ZLAST = DATALINE' string
000010     166     ADDRESS ISREDIT 'LINE 'cline '=' (curline)'
000011 >Member : BLDAPAR
000012     137     address ISREDIT 'LINE_AFTER .ZLAST = DATALINE' string
000013     189     ADDRESS ISREDIT 'LINE 'cline '=' (curline)'
000014 >Member : CRTAPAR
000015     24     address ISREDIT 'LINE_AFTER .ZFIRST = DATALINE' string
000016     161     address ISREDIT 'LINE_AFTER .ZLAST = DATALINE' string
000017 >Member : DELETEIT
000018     49     address ISREDIT 'LINE_AFTER .ZLAST = DATALINE' string
000019 >Member : DUPCHK

```

Place the cursor on the command line and press the F4 function.



Note: Check your current KEY settings and change them for SDSF because it might be under a different ISPF profile.

```

File Edit Edit_Settings Menu Utilities Compilers Test Help
VIEW      Enhanced Search Report      Index BATCH      Report Converted
Command ==>                               Scroll ==> CSR
***** ***** Top of Data *****
000001 -----
000002 >Data Set: FMN.EXEC
000003 >Member : ACCAPAR
000004      147      address ISREDIT 'LINE_AFTER .ZLAST = DATALINE' string
000005      198      ADDRESS ISREDIT 'LINE 'cline '= (curline)''
000006 >Member : ADDTEMP
000007      46      address ISREDIT 'LINE_AFTER .ZLAST = DATALINE' string
000008 >Member : BCKAPAR
000009      137      address ISREDIT 'LINE_AFTER .ZLAST = DATALINE' string
000010      166      ADDRESS ISREDIT 'LINE 'cline '= (curline)''
000011 >Member : BLDAPAR
000012      137      address ISREDIT 'LINE_AFTER .ZLAST = DATALINE' string
000013      189      ADDRESS ISREDIT 'LINE 'cline '= (curline)''
000014 >Member : CRTAPAR
000015      24      address ISREDIT 'LINE_AFTER .ZFIRST = DATALINE' string
000016      161      address ISREDIT 'LINE_AFTER .ZLAST = DATALINE' string
000017 >Member : DELETEIT
000018      49      address ISREDIT 'LINE_AFTER .ZLAST = DATALINE' string
000019 >Member : DUPCHK

```

The spool report was converted to an enhanced search report.

Using the F4 data set processing options in JCL

The following table illustrates how the associated data set name is determined when you press F4 on lines with the respective statement type:

Table 18. How associated data set names are determined for specific statement types

Statement type	Data set name
<ul style="list-style-type: none"> // EXEC <i>procedure name</i> // EXEC PROC=<i>procedure name</i> // INCLUDE Member=<i>procedure name</i> 	<p>The first data set that contains the procedure where the search order is JCLLIB, System procedure libraries.</p> <p> Note: If variable substitution is performed for a nested view or edit session, the parameter values on an EXEC procedure statement will be used in the nested view session.</p>
<pre>// DSN=<i>data set name</i></pre> <pre>// EXEC PGM=<i>program name</i></pre>	<p><i>data set name</i></p> <p>The first data set that contains the program where the search order is STEPLIB or JOBLIB, LPA, LLA.</p>

Table 18. How associated data set names are determined for specific statement types (continued)

Statement type	Data set name
----------------	---------------



Note: If option 1 View or option 2 Edit is used with an EXEC PGM= statement, File Manager View Load module will be substituted.

```
// JCLLIB ORDER=
```

The cursor positioned data set name, or the first data set name in the ORDER= list.

Examples: Enhanced Reference List and Search

Example 1. Setting up default member first time usage

Enter the EF command.

```

Menu Utilities Compilers Options Status Help
----- Enhanced Search Command -----
0 Command ==> _____
0 String:
0 DSEB _____ + RNEY
1 String options Columns 06
2 - 1 Prefix _____ From 8
3 - 2 Suffix _____ To
4 3 Word LISH
5
6 Scope:
7 Member. _____ Edit F
9 DDnames _____ + RNEY
1 DSNs . _____ + 2
1 GSA
1 F 7.1
1 Options:
1 Enter "/" to select option ISPF Pack
1 - Directory - Drill - Result - Parmlib - Proclib - 1. Asis
S - Batch - Jobcard - Edit - List - First - 2. Skip
F1=Help F2=Split F3=Exit F4=Expand F7=Backward
F8=Forward F9=Swap F10=Left F11=Right F12=Cancel
F10=Actions F12=retrieve
    
```

Pressing enter with the other fields blank will create the reference data set and begin with an edit session of a member that is named DEFAULT. The following allocate panel will be displayed for the reference data set. If the default naming convention *userid.FMNSRCH.INDEX* is not appropriate, overwrite the name.

```

Menu Utilities Compilers Options Status Help
----- Allocate data set -----
0 Command ==> _____
1 The data set was not found
2
3 Data set name DTORNEY.FMNSRCH.INDEX
4
5 Change the data set name or
6
7 Press ENTER to allocate a new data set
8
9 F1=Help      F2=Split    F3=Exit      F7=Backward  F8=Forward
10 F9=Swap      F12=Cancel
11
12 Workplace   ISPF Object/Action Workplace      Release . : ISPF 7.1
13 z/OS System z/OS system programmer applications
14 z/OS User   z/OS user applications
15 IBMGSA     IBMGSA Development and Service Apps
16 SDSF
17
18 Enter X to Terminate using log/list defaults
19 F1=Help      F2=Split    F3=Exit      F7=Backward  F8=Forward  F9=Swap
20 F10=Actions  F12=Cancel

```



Note: If no other data sets are specified to the enhanced search, this member will be used. So this should contain your most commonly searched data sets.

The following example enters some generic names for JCL data sets.

```

File Edit Edit_Settings Menu Utilities Compilers Test Help
-----
EDIT DTORNEY.FMNSRCH.INDEX(DEFAULT) - 01.00 Columns 00001 00072
Command ==> _____ Scroll ==> CSR
***** ***** Top of Data *****
=NOTE= Specify 1 to 4 data set names in the following format:
=NOTE= Input_dsn Input_template Output_dsn Output_template
=NOTE= Where
=NOTE= Input_dsn : Input data set or path name
=NOTE= Input_template : Input template (specify - to bypass)
=NOTE= Output_dsn : Output data set or path name
=NOTE= Output_template: Output template
=NOTE= Note: Search only applies to the first data set name on the line.
' ' ' ' ' FMN.P*.CNTL
' ' ' ' ' FMN.R*.CNTL
' ' ' ' '
' ' ' ' '
' ' ' ' '
' ' ' ' '
' ' ' ' '
' ' ' ' '
' ' ' ' '
F1=Help      F2=cruise   F3=Exit      F4=EFind    F5=Rfind    F6=Rchange
F7=Up        F8=Down     F9=Swap      F10=Left   F11=Right   F12=retrieve

```

Press F3.

The following figure is a search report showing lines that were found to match the search string, DSEB.

```

File Edit Edit_Settings Menu Utilities Compilers Test Help
VIEW      Enhanced Search Report      Index DEFAULT      Col 00001 00072
Command ==> _____      Scroll ==> CSR
***** ***** Top of Data *****
000001 -----
000002 >Data Set: FMN.PI19593.CNTL
000003 >Member : TEST3
000004      25 $$$FILEM DSEB INPUT=DD01,NOUPDATE=YES,
000005 >Member : TEST4
000006      19 $$$FILEM DSEB INPUT=DD01,NOUPDATE=YES,
000007 -----
000008 >Data Set: FMN.USERXYZ.CNTL
000009 >Member : BATFUN3
000010      31 $$$FILEM DSEB NOUPDATE=YES,
000011 >Member : BATFUN4
000012      31 $$$FILEM DSEB NOUPDATE=YES,
000013 >Member : BATFUN5
000014      70 $$$FILEM DSEB ,
000015 >Member : BATFUN6
000016
000017      231 line(s) in 83 of 1108 Member(s) and 9 of 92 File(s).
000018 -----
000019 -----

```

If you place the cursor on the data on line 14 and press **Enter**, you can see FMN.USERXYZ.CNTL(BATFUN5) with the cursor placed on line 70.

```

File Edit Edit_Settings Menu Utilities Compilers Test Help
VIEW      FMN.USERXYZ.CNTL(BATFUN5) - 01.05      Columns 00001 00072
Command ==> _____      Scroll ==> CSR
000070 $$$FILEM DSEB ,
000071 $$$FILEM DSNIN=FMN.USERXYZ.DATA0,
000072 $$$FILEM MEMBER=DTTYPE5,
000073 $$$FILEM TCIN=FMN.USERXYZ.TEMPLATE.XML(DTTYPE),PROC=*
000074 do until(down(1) = 'EOF')
000075     SELECT
000076     WHEN(TID('REC-TYPE01')) THEN DO;
000077         IF CMP_DATE('START-DATE01',,, 'RG','10/02/1996','10/02/1999') THEN
000078             if val_fld('salary01') = 85000 then set_fld('salary01',90000);
000079             if val_fld('salary01') = 75000 then set_fld('salary01',80000);
000080             if val_fld('salary01') = 73000 then set_fld('salary01',78000);
000081             UPDATE()
000082         END;
000083     END
000084     WHEN(TID('REC-TYPE02')) THEN DO;
000085         IF CMP_TIME('BIRTH-TIME02',,, 'RG','08:00:00','10:00:00') THEN DO;
000086             if val_fld('salary02') = 85000 then set_fld('salary02',90000);
000087             if val_fld('salary02') = 75000 then set_fld('salary02',80000);
000088             if val_fld('salary02') = 73000 then set_fld('salary02',78000);
000089             UPDATE()

```

If you place the cursor on line 73 anywhere within the data set name FMN.USERXYZ.TEMPLATE.XML and press **F4**, the following panel is displayed.

```

File Edit Edit_Settings Menu Utilities Compilers Test Help
-----
V      FMN.USERXYZ.TEMPLATE.XML
C      File Manager
0      Edit/View  Utility  Template
0
0      Command ==>
0
0      1 View      View resource
0      2 Edit      Edit resource
0      3 Select    Select resource list
0      4 Dslist   ISPF data set list
0      5 Search    Nested search
0      6 All      Show all occurrences
0      7 First    Find first occurrence
0      8 Prev     Find previous occurrence
0      9 Next     Find next occurrence
0     10 Last     Find last occurrence
0     11 Rsearch  Search the resource
0     12 PDSE2   Workbench
0     13 Change   Change data set attributes
0
0
000085      SALARY = VAL_FLD('SALARY02') + 5000
000086      SET_FLD('SALARY02',SALARY)
000087      UPDATE()
000088      END;

```

From the menu above, you can choose any of the options by number or by placing the cursor on it and press **Enter**.



Note: If you select View or Edit and the data set name in the source includes a subsequent member name, the view or edit session is with that member.

If you select option 5 **nested search**, the following panel is displayed:

```

File Edit Edit_Settings Menu Utilities Compilers Test Help
-----
VIEW      Enhanced Search Report      Index DEFAULT      Col 00001 00072
Command ==>
***** ***** Top of Data *****
000001
000002 >Data Set: FMN.USERXYZ.CNTL
000003 >Member : BATFUN1
000004      32 $$$FILEM TCIN=FMN.USERXYZ.TEMPLATE.XML(DTTYPE),
000005      82 $$$FILEM TCOLD=FMN.USERXYZ.TEMPLATE.XML(DTTYPE),
000006      83 $$$FILEM TCNEW=FMN.USERXYZ.TEMPLATE.XML(DTTYPE),
000007 >Member : BATFUN2
000008      32 $$$FILEM TCIN=FMN.USERXYZ.TEMPLATE.XML(DTTYPE),
000009      87 $$$FILEM TCOLD=FMN.USERXYZ.TEMPLATE.XML(DTTYPE),
000010      88 $$$FILEM TCNEW=FMN.USERXYZ.TEMPLATE.XML(DTTYPE),
000011 >Member : BATFUN3
000012      34 $$$FILEM TCIN=FMN.USERXYZ.TEMPLATE.XML(DTTYPE),PROC=*
000013      86 $$$FILEM TCOLD=FMN.USERXYZ.TEMPLATE.XML(DTTYPE),
000014      87 $$$FILEM TCNEW=FMN.USERXYZ.TEMPLATE.XML(DTTYPE),
000015 >Member : BATFUN4
000016
000017      50 line(s) in 13 of 1108 Member(s) and 1 of 92 File(s).
000018
000019 >Member : BATFUN5

```

Navigation:

1. Repeat the process to create nested searches.
2. Use F3 to return to a previous search.
3. Use Cancel to exit all searches.

Example 2. Using the DIR DRILL and RESULT with HFS

To display the enhanced search panel, enter the EF command. Search for member names that contain ODP. Use a new reference member HFS to specify the directory to be searched.

```

Menu Utilities Compilers Options Status Help
- Enhanced Search Command -----
0 Command ==> _____
1 String:
0 ODPD _____ +
1 String options Columns
2 - 1 Prefix _____ From
3 - 2 Suffix _____ To
4 - 3 Word _____
5
6 Scope:
7 Member. HFS _____ / Edit
9 DDnames _____ +
1 DSNs . _____ +
1
1 Options:
1 Enter "/" to select option ISPF Pack
1 - Directory - Drill - Result - Parmlib - Proclib - 1. Asis
S - Batch - Jobcard - Edit - List - First - 2. Skip
F1=Help F2=Split F3=Exit F4=Expand F7=Backward
F8=Forward F9=Swap F10=Left F11=Right F12=Cancel
p
F10=Actions F12=retrieve
    
```

If you enter "/", the following panel is displayed:

```

File Edit Edit_Settings Menu Utilities Compilers Test Help
EDIT DTORNEY.FMNSRCH.INDEX(HFS) - 01.00 Columns 00001 00072
Command ==> _____ Scroll ==> CSR
***** ***** Top of Data *****
=NOTE= Specify 1 to 4 data set names in the following format:
=NOTE= Input_dsn Input_template Output_dsn Output_template
=NOTE= Where
=NOTE= Input_dsn : Input data set or path name
=NOTE= Input_template : Input template (specify - to bypass)
=NOTE= Output_dsn : Output data set or path name
=NOTE= Output_template: Output template
=NOTE= Note: Search only applies to the first data set name on the line.
/
F1=Help F2=cruise F3=Exit F4=EFind F5=Rfind F6=Rchange
F7=Up F8=Down F9=Swap F10=Left F11=Right F12=retrieve
    
```

If you place the cursor on "/" and press F4, the following panel is displayed:

```

File Edit Edit_Settings Menu Utilities Compilers Test Help
-----
E File Manager /
C Edit/View Utility Template
*
= Command ==>
=
0 1 View View resource
* 2 Edit Edit resource
3 Select Select resource list
4 Dslist ISPF data set list
5 Search Nested search
6 All Show all occurrences
7 First Find first occurrence
8 Prev Find previous occurrence
9 Next Find next occurrence
0 10 Last Find last occurrence
0 11 Rsearch Search the resource
0 12 PDSE2 Workbench
0 13 Create Allocate data set

0 Columns 00001 00072
Scroll ==> CSR
ta *****
able until you change
ommand RECOVERY ON.

Data *****

```

If you select option 3 **Select**, the following panel is displayed:

```

Process Options Help
-----
File Manager File Selection Row 00001 of 00016
Command ==> Scroll PAGE
PATH /
Name Prompt Typ Size Created Changed
* * * * *
. Dir 8192 14/01/06 14/01/07 09:32:45
.. Dir 8192 14/01/06 14/01/07 09:32:45
... Dir 8192 14/01/06 13/05/25 13:56:14
apc Dir 8192 06/08/06 15/09/04 12:07:17
bin Dir 16384 14/01/06 15/08/11 15:29:44
dev Dir 8192 02/06/21 14/08/20 12:24:40
etc Dir 8192 02/11/21 13/12/10 17:14:50
lib Dir 8192 14/01/06 13/12/18 10:26:53
opt Dir 8192 14/01/06 13/05/25 13:56:17
samples Dir 8192 14/01/06 14/11/18 09:49:16
service Dir 8192 14/01/07 14/01/07 09:32:45
tmp Dir 266240 02/06/21 15/10/04 11:42:18
/ u Dir 40960 09/05/01 15/09/18 11:55:00
usr Dir 8192 14/01/06 13/05/25 13:56:14
var Dir 8192 02/11/20 13/12/10 17:14:50
SYSTEM Dir 8192 14/01/06 13/05/25 13:56:14
**** End of data ****

```

Use **S** to select a directory to be inserted in the HFS reference member. Use **/** as illustrated above to display the nested directory list. Repeat the process until you find the directory to be searched. Select the directory to populate the reference member with an **S**.



Note: You can select more than one directory to be inserted into your reference member.

```

Process  Options  Help
-----
File Manager
Command ==>
PATH /u/fmn/odpp
Name Prompt Typ Size Created Changed
* * * * *
. Dir 8192 14/03/11 14/11/18 07:16:04
.. Dir 8192 09/05/01 15/09/30 10:32:36
licensefiles Dir 8192 14/03/11 14/03/11 11:08:33
licensev11 Dir 8192 14/11/18 14/11/18 08:14:24
odpp Dir 8192 14/03/11 14/03/11 11:05:51
odppbin Dir 8192 14/03/11 13/09/10 06:57:52
tracefiles Dir 98304 14/10/23 15/10/01 15:15:59
s Samples Dir 8192 14/03/11 14/04/29 13:45:48
**** End of data ****
    
```

Press F3 and enter the following command to search for the file names that contain string ODPP in the specified directory and any nested directories.

```

File Edit Edit_Settings Menu Utilities Compilers Test Help
-----
EDIT DTORNEY.FMNSRCH.INDEX(HFS) - 01.00 Columns 00001 00072
Command ==> EF ODPP DIR DRILL Scroll ==> CSR
***** Top of Data *****
000001 /u/fmn/odpp/Samples
***** Bottom of Data *****
    
```

Press F3 to produce the following report.

```

File Edit Edit_Settings Menu Utilities Compilers Test Help
-----
VIEW Enhanced Search Report Index HFS Col 00001 00072
Command ==> ef ccn result Scroll ==> CSR
***** Top of Data *****
000001 >Path : /u/fmn/odpp/Samples/binincl
000002 >Name : ODPPCmnAPI.h
000003 > : ODPPCmnErrCodes.h
000004 > : ODPPCmnOprH.h
000005 > : ODPPCommonH.h
000006 > : ODPPDataTypesH.h
000007 > : ODPPErrorHandlerCmnIncludesH.h
000008 > : ODPPHashErrs.h
000009 > : ODPPTokIdsH.h
000010 >Path : /u/fmn/odpp/Samples/include
000011 >Name : ODPPCmnAPI.h
000012 > : ODPPCmnErrCodes.h
000013 > : ODPPCmnOprH.h
000014 > : ODPPCommonH.h
000015 > : ODPPCOLN.cbl
000016 >
000017 > 23 line(s) in 0 of 0 Member(s) and 23 of 25 File(s).
000018 >
000019 > : ODPP HashErrs.h
    
```

To perform a nested search for the string **CCN** in only the file names that contain the string **ODPP**, enter the EF CCN RESULT nested command.

```

File  Edit  Edit_Settings  Menu  Utilities  Compilers  Test  Help
-----
VIEW          Enhanced Search Report          Index RESULT          Col 00001 00072
Command ==>                Scroll ==> CSR
***** ***** Top of Data *****
000001 -----
000002 >Path      : /u/fmn/odpp/Samples/include
000003 >Name      : ODPPCmnErrCodes.h
000004       55   #define CCNMAX                (CCNBASE + 51)
000005       287   CCN error codes
000006       290   #define CCNBASE                0x00001000
000007       291   #define ODPP_CCN_ERR_DATATYPE_NOTSUPPORTED  CCNBASE +
000008       292   #define ODPP_CCN_ERR_CCN_CTRLBLK_MALLO_FAILED  CCNBASE +
000009       293   #define ODPP_CCN_ERR_ROWSET_EMPTY                CCNBASE +
000010       294   #define ODPP_CCN_ERR_NO_SOURCE_DATA            CCNBASE +
000011       295   #define ODPP_CCN_ERR_NO_CCN_CTRLBLK            CCNBASE +
000012       296   #define ODPP_CCN_ERR_INVALID_METHOD            CCNBASE +
000013       297   #define ODPP_CCN_ERR_PREFIXTBL_MALLO_FAILED    CCNBASE +
000014       298   #define ODPP_CCN_ERR_INVALID_SRCCOL_INDEX      CCNBASE +
000015       299   #define ODPP_CCN_ERR_INVALID_COLLENGTH_FOR_DEC370  CCNBASE +
000016                                           CCNBASE +
000017 [ 53 line(s) in 0 of 0 Member(s) and 5 of 23 File(s). ]
000018                                           CCNBASE +
000019       305   #define ODPP_CCN_ERR_INVALID_IN_LENGTH            CCNBASE +

```



Note: The Index value in the header has changed from **HFS** to **RESULT**.

On the Enhanced Search Report, you can see the current data sets or path names that were used to produce the search results by placing your cursor on the Index value and press **Enter**.

```

----- Search Data Set List -----
-- ==> Row 1 to 2 of 2
F Data set list
C /u/fmn/odpp/Samples/include
* /u/fmn/odpp/Samples
0 ***** Bottom of data *****
0
0
0
0
0
0
0
0
0
0
0
0
0
0
0
0
0
0
0
0
0
0
0
0
0
0
0

Test  Help
-----
          Col 00001 00072
          Scroll ==> CSR
*****
-----
          (CCNBASE + 51)
          RTED                0x00001000
          _FAILED             CCNBASE +
          FAILED              CCNBASE +
          DEX                  CCNBASE +
          _FOR_DEC370         CCNBASE +
          _FOR_DEC370         CCNBASE +
          CCNBASE +
          CCNBASE +

```

Example 3. Using F4 with the enhanced search report

Press the **F4** key and select option 1 **SUM** on the command line.

```

File Edit Edit_Settings Menu Utilities Compilers Test Help
VIEW      Enhanced Search Report      Index RESULT      Col 00001 00072
Command ==> _____ Scroll ==> CSR
***** ***** Top of Data *****
- - - - - 1 Line(s) not Displayed
000002 >Path      : /u/fmn/odpp/Samples/include
000003 >Name       : ODPPCmnErrCodes.h
- - - - - 28 Line(s) not Displayed
000032 >Name       : ODPPCmnOprH.h
- - - - - 11 Line(s) not Displayed
000044 >Name       : ODPPDataTypesH.h
- - - - - 1 Line(s) not Displayed
000046 >Name       : ODPPWAPI.cbl
- - - - - 6 Line(s) not Displayed
000053 >Path      : /u/fmn/odpp/Samples
000054 >Name       : OdppCcnExitS.c
- - - - - 8 Line(s) not Displayed
***** ***** Bottom of Data *****

```

Press the **F4** key and select option 2 **DS** on the command line.

```

File Edit Edit_Settings Menu Utilities Compilers Test Help
VIEW      Enhanced Search Report      Index RESULT      Col 00001 00072
Command ==> _____ Scroll ==> CSR
***** ***** Top of Data *****
- - - - - 1 Line(s) not Displayed
000002 >Path      : /u/fmn/odpp/Samples/include
- - - - - 50 Line(s) not Displayed
000053 >Path      : /u/fmn/odpp/Samples
- - - - - 9 Line(s) not Displayed
***** ***** Bottom of Data *****

```

Press the **F4** key and select option 3 **RES** on the command line to restore the report to its original format.

Example 4. Using F4 in an edit or view session

Press the **F4** function key and select option 1 **View** with your cursor placed on a data set name FMN.REGTEST.DB2.EXPORT.EMP.RRDS1 to view the data set.

```

File Edit Edit_Settings Menu Utilities Compilers Test Help
- FMN.REGTEST.DB2.EXPORT.EMP.RRDS1
V File Manager
C Edit/View Utility Template
0
0 Command ==> _____
0
0 1 View      View resource
0 2 Edit      Edit resource
0 3 Select    Select resource list
0 4 Dslist    ISPF data set list
0 5 Search    Nested search
0 6 All       Show all occurrences
0 7 First     Find first occurrence
0 8 Prev      Find previous occurrence
0 9 Next      Find next occurrence
0 10 Last     Find last occurrence
0 11 Rsearch  Search the resource
0 12 PDSE2    Workbench
0 13 List     Catalog services
0
0
* Data *****

```



```

Process Options Help
-----
View          FMN.REGTEST.DB2.EXPORT.EMP.RRD  +          Top of 11
Command ==>> _____ Scroll PAGE
                Type RRDS      Slot _____ RBA          Format CHAR
                _____ Col 1 _____ Insert Length 91
                -----+-----10-----+-----2-----+-----3-----+-----4-----+-----5-----+-----6-----+-----7-----
***** **** Top of data ****
000001 000060..IRVING      F..STERN          D11642314.09.1973MANAGER ..M07.07.
000002 000150..BRUCE       ..ADAMSON         D11451012.02.1972DESIGNER..M17.05.
000003 000160..ELIZABETH    R..PIANKA         D11378211.10.1977DESIGNER..F12.04.
000004 000170..MASATOSHI    J..YOSHIMURA     D11289015.09.1978DESIGNER..M05.01.
000005 000180..MARILYN    S..SCOUTTEN       D11168207.07.1973DESIGNER..F21.02.
000006 000190..JAMES       H..WALKER         D11298626.07.1974DESIGNER..M25.06.
000007 000200..DAVID         ..BROWN           D11450103.03.1966DESIGNER..M29.05.
000008 000210..WILLIAM      T..JONES          D11094211.04.1979DESIGNER..M23.02.
000009 000220..JENNIFER      K..LUTZ           D11067229.08.1968DESIGNER..F19.03.
000010 200170..KIYOSHI       ..YAMAMOTO        D11289015.09.1978DESIGNER..M05.01.
000011 200220..REBA         K..JOHN           D11067229.08.1968DESIGNER..F19.03.
***** **** End of data ****
    
```

Return to the JCL view and select option 4 **Dslist** by using the F4 function key.

```

EDIT          FMN.PI07105.CNTL(DBITEST) - 01.00          Columns 00001 00072
Menu Options View Utilities Compilers Help
-----
DSLIST - Data Sets Matching FMN.REGTEST.DB2.EXPORT.EMP.RRDS1          Row 1 of 3
Command ==>> _____ Scroll ==>> PAGE
Command - Enter "/" to select action          Message          Volume
-----
          FMN.REGTEST.DB2.EXPORT.EMP.RRDS1          *VSAM*
          FMN.REGTEST.DB2.EXPORT.EMP.RRDS1.DATA      D$FM03
          FMN.REGTEST.DB2.EXPORT.EMP.RRDS1.TEST      D$FM15
***** End of Data Set list *****
    
```

Example 5. Enhanced find on current PARMLIB data sets

Issue the following command from the command line:

```
ef apf parmlib
```

```

File Edit Edit_Settings Menu Utilities Compilers Test Help
-----
VIEW          Enhanced Search Report          Index PARMLIB          Col 00001 00072
Command ==>> _____ Scroll ==>> CSR
***** ***** Top of Data *****
000001 -----
000002 >Data Set: SYS1.PARMLIB.FMD2
000003 >Member : IEASYS00
000004      20 LNKAUTH=APFTAB,          LINKLIST IS NOT APF AUTHORISED
000005 >Member : PROGD2
000006      4 /* COMBINED APF + LNKST&SYSCLONE.
000007      23 /* 02/07/13 JC ADD IAM V8 TO APF AND LL
000008      24 /* 26/04/12 JC ADD DB2VA10.DF22.SDSNEXIT LIB TO APF
000009      25 /* 20/12/11 JC ADD IMSVC10.IFF2 LIBS TO APF
000010      26 /* 05/09/11 JC ADD DB2VA10.DF12.SDSNEXIT LIB TO APF
000011      27 /* 25/08/11 JC ADD DB2V810.DF82.SDSNEXIT LIB TO APF
000012      28 /* 14/08/11 JC ADD DB2VA10.DF72.SDSNEXIT LIBS TO APF
000013      29 /* 19/01/11 JC ADD IMSVC10.IFE2 LIBS TO APF
000014      30 /* 31/10/10 AC ADD FMN12SVC DATASETS TO APF
000015      31 /* 30/09/10 JC ADD BLDAUS1.FMNV11.SFMNMOD1 TO APF
000016
000017      2552 line(s) in 32 of 374 Member(s) and 4 of 6 File(s).
000018
000019      37 /* 04/03/09 JC ADD IMSVB10.IFC2.** DATASETS TO APF
    
```

Example 6. Enhanced find on SYSPROC SYSEXEC DDs

Search for lines with ISREDIT and LINE strings by issuing the command:

```
EF ISREDIT & LINE SYSPROC SYSEXEC
```

```

File Edit Edit_Settings Menu Utilities Compilers Test Help
VIEW      Enhanced Search Report      Index DD LIST      Col 00001 00072
Command ==> _____ Scroll ==> CSR
***** ***** Top of Data *****
000001 -----
000002 >Data Set: FMN.EXEC
000003 >Member : ACCAPAR
000004      72  ADDRESS ISREDIT '(curline) = LINE 'cline
000005      99  ADDRESS ISREDIT '(curline) = LINE 'cline
000006     118  ADDRESS ISREDIT '(LBL,NEST) = LABEL' cline
000007     147  address ISREDIT 'LINE_AFTER .ZLAST = DATALINE' string
000008     198  ADDRESS ISREDIT 'LINE 'cline '= (curline)'
000009 >Member : ADDTEMP
000010      46  address ISREDIT 'LINE_AFTER .ZLAST = DATALINE' string
000011 >Member : BCKAPAR
000012      64  ADDRESS ISREDIT '(curline) = LINE 'cline
000013      89  ADDRESS ISREDIT '(curline) = LINE 'cline
000014     108  ADDRESS ISREDIT '(LBL,NEST) = LABEL' cline
000015     137  address ISREDIT 'LINE_AFTER .ZLAST = DATALINE' string
000016
000017 1198 line(s) in 229 of 3438 Member(s) and 23 of 49 File(s).
000018
000019      89  ADDRESS ISREDIT '(curline) = LINE 'cline

```

Example 7. Searching 3.4 data sets for specific members

Search for member names that contain MVP:

```

Menu Options View Utilities Compilers Help
ISRUDSL0 Data Sets Matching SYS1.PROCLIB      Row 1 of 12
Command ==> ef MVP dir      Scroll ==> PAGE
Command - Enter "/" to select action      Message      Volume
-----
SYS1.PROCLIB                               $$$R1A
SYS1.PROCLIB.FMD1                           D1SY01
SYS1.PROCLIB.FMD1.OLD                        D1SY01
SYS1.PROCLIB.FMD1.USER                       D1SY01
SYS1.PROCLIB.FMD2                           D2SY01
SYS1.PROCLIB.FMD2.USER                       D2SY01
SYS1.PROCLIB.FMD2.USER.OLD                   D2SY01
SYS1.PROCLIB.SYSPLEXD                        D$$SY01
SYS1.PROCLIB.SYSPLEXD.USER                   D$$SY01
SYS1.PROCLIB.TSD3                           D3SY01
SYS1.PROCLIB.TSD3.USER                       D3SY01
SYS1.PROCLIB.TSD3.USER.OLD                   D3SY01
***** End of Data Set list *****

```

Press **Enter**.

```

File Edit Edit_Settings Menu Utilities Compilers Test Help
VIEW      Enhanced Search Report      Index DSLIST      Col 00001 00072
Command ==> _____ Scroll ==> CSR
***** ***** Top of Data *****
000001 >Data Set: SYS1.PROCLIB.FMD1.USER
000002 >Member : MVPD10
000003 >      : MVPSRVC0
000004 >      : MVPSRVC2
000005 >      : MVPSRVC3
000006 >      : MVPSRVD0
000007 >      : MVPSRVD3
000008 >      : MVPSRVE2
000009 >Data Set: SYS1.PROCLIB.FMD2.USER
000010 >Member : MVPGSVRJ
000011 >      : MVPGSVR1
000012 >      : MVPSRTC6
000013 >      : MVPSRV
000014 >      : MVPSRVC
000015 >      : MVPSRVCD
000016
000017 53 line(s) in 53 of 1787 Member(s) and 4 of 12 File(s).
000018
000019 >      : MVPSRVC1

```

Example 8. Setting up reference members using F4 Select option

Enter the EL command that is followed by prefix command I to create a member.

```

Process
-----
File Manager      Enhanced Reference List      Row 1 to 3 of 3
Command ==> _____ Scroll CSR
Data set name  DTORNEY.FMNSRCH.INDEX
Member pattern  *
Name      Description      Date Changed      Size
I  DEFAULT _____  2016/07/17 14:35      2
  HFS _____  2016/07/17 16:14      1
***** Bottom of data *****

```

Press **Enter** and type a new member name and description.

```

Process
-----
F      Command ==> _____ 1 to 3 of 3
C      Member MYDSN _____ Scroll CSR
      Desc Example of selecting DSNs _____ Size
I      Press ENTER to edit the member. 35      2
      Press EXIT or CANCEL to cancel the insert. 14      1
      *****

```

Press **Enter** and type the high-level qualifier FMN.

```

File Edit Edit_Settings Menu Utilities Compilers Test Help
EDIT          DTORNEY.FMNSRCH.INDEX(MYDSNS) - 01.00         Columns 00001 00072
Command ==> _____ Scroll ==> CSR
***** ***** Top of Data *****
=NOTE= Specify 1 to 4 data set names in the following format:
=NOTE= Input_dsn Input_template Output_dsn Output_template
=NOTE= Where
=NOTE= Input_dsn      : Input data set or path name
=NOTE= Input_template : Input template (specify - to bypass)
=NOTE= Output_dsn    : Output data set or path name
=NOTE= Output_template: Output template
=NOTE= Note: Search only applies to the first data set name on the line.
|'|'|' FM
|'|'|'

```

Place the cursor on FM and press the **F4** function key.

```

File Edit Edit_Settings Menu Utilities Compilers Test Help
      FM
E  | File Manager          0           Columns 00001 00072
C  | Edit/View Utility Template         Scroll ==> CSR
*  | _____
=  | Command ==> _____
|  |
|  | 1 View      View resource
|  | 2 Edit      Edit resource
|  | 3 Select    Select resource list
|  | 4 Dslist    ISPF data set list
|  | 5 Search    Nested search
|  | 6 All       Show all occurrences
|  | 7 First     Find first occurrence
|  | 8 Prev      Find previous occurrence
|  | 9 Next      Find next occurrence
|  | 10 Last     Find last occurrence
|  | 11 Rsearch  Search the resource
|  | 12 PDSE2   Workbench
|  | 13 Create   Allocate data set
|  |
|  |
|  |
|  | ***** Bottom of Data *****
|  |
|  |

```

Select option 3 to bring up a selection list.

Change the data set to FMN.FMDATA.** in the heading, press **Enter**, and select a number of data sets as follows:

```

Process  Options  Help
-----
File Manager          DATA SET SELECTION          Row 00001 of 00080
Command ==>>>          Scroll PAGE
Data Set Selection for FMN.FMDATA.**
DATA SET NAME          TYPE  VOLUME  CREATED
FMN.FMDATA.**          *      *      *
- FMN.FMDATA           NVSAM D$FM07 2005.285
- FMN.FMDATA.CETEST    NVSAM D$FM16 2009.306
- FMN.FMDATA.CETEST1   NVSAM D$FM17 2009.317
- FMN.FMDATA.COPYGDG   NVSAM D$FM08 2015.171
s FMN.FMDATA.ESDS      ESDS   2009.192
- FMN.FMDATA.ESDS.DATA DATA  D$FM05 2009.192
- FMN.FMDATA.ESDS.EDIT ESDS   2010.301
- FMN.FMDATA.ESDS.EDIT.DATA DATA  D$FM06 2010.301
- FMN.FMDATA.ESDS.GAYATRI ESDS   2009.194
- FMN.FMDATA.ESDS.GAYATRI.DATA DATA  D$FM06 2009.194
s FMN.FMDATA.ESDS.NEW1X ESDS   2015.224
- FMN.FMDATA.ESDS.NEW1X.DATA DATA  D$FM16 2015.224
- FMN.FMDATA.ESDS.NEW2X ESDS   2015.224
- FMN.FMDATA.ESDS.NEW2X.DATA DATA  D$FM19 2015.224
s FMN.FMDATA.ESDS.NEW3X ESDS   2015.224
- FMN.FMDATA.ESDS.NEW3X.DATA DATA  D$FM15 2015.224
s FMN.FMDATA.ESDS.R4089 ESDS   2012.328

```

Press **Enter** to highlight the data sets for selection. Change the data set name in the header to find more data sets.

```

Process  Options  Help
-----
File Manager          DATA SET SELECTION          Row 00001 of 00001
Command ==>>>          Scroll PAGE
Data Set Selection for FMN.PI07105.DATA
DATA SET NAME          TYPE  VOLUME  CREATED
FMN.PI07105.DATA      *      *      *
s FMN.PI07105.DATA    PDSE  D$FM03 2013.343
****  END OF DATA  ****

```

To insert the data set names into the member, press **Enter** after you select additional data sets followed by **F3**.

```

File  Edit  Edit_Settings  Menu  Utilities  Compilers  Test  Help
-----
ISREDDE2  DTORNEY.FMNSRCH.INDEX(MYDSN) - 01.00          Columns 00001 00072
Command ==>>>          Scroll ==>>> CSR
***** ***** Top of Data *****
000100 FMN.FMDATA.ESDS
000200 FMN.FMDATA.ESDS.NEW1X
000300 FMN.FMDATA.ESDS.NEW3X
000400 FMN.FMDATA.ESDS.R4089
000500 FMN.PI07105.DATA
***** ***** Bottom of Data *****

```

Example 9. Using the List option

Enter the EL command that is followed by prefix command I to create a member.

```

Process  Options  Help
-----  -
Command ==>> _____ 00048
C _____ 1 CSR
D String: _____ +
String options _____
  1 Prefix _____ From _____ To _____ t Mod _
  2 Suffix _____
  3 Word _____
Scope: _____
Member _____ _ Edit _____ 5 0
DDnames _____ + _____ 7 0
DSNs . _____ + _____ 5 0
Options: _____ 9 0
Enter "/" to select option _____ 3 0
  Directory _ Drill _____ _ Result / Parmlib / Proclib _ 1. Asis 7 28
  Batch _ Jobcard _ Edit / List _ First 2. Skip 6 0
                                           4 0
                                           1 0
                                           5 0
                                           8 0
IPVSRVD1          2  15 2015/06/17 2016/12/01 15:24:07 JPHILP 15 0
  
```

Press **Enter**.

```

Process  Options  Help
-----  -
File Manager          Member hit selection list          Row 00001 of 00048
Command ==>> _____ Scroll CSR
Data set SYS1.PROCLIB.TSD3.USER          +
Name      Prompt  Lib Size Created      Changed      ID          Init Mod _
*         *         *         *         *         *         *
- IPVBRETD          2  29 2018/11/16 2018/11/16 14:15:25 TYRONED    29  0
- IPVSAVD9          2  25 2017/01/16 2017/01/16 15:16:32 MHUGHES    25  0
- IPVSRVBD          2  31 2018/04/16 2020/01/06 12:24:48 BRETD      23  0
- IPVSRVC           2  25 2015/08/10 2021/07/06 18:48:10 TYRONED    25  0
- IPVSRVCL          2  51 2015/04/02 2016/11/16 14:22:29 JPHILP     17  0
- IPVSRVCP          2  15 2015/03/25 2016/11/16 14:22:33 JPHILP     15  0
- IPVSRVC4          2  24 2013/09/27 2016/11/16 14:22:35 JPHILP     21  0
- IPVSRVC5          2  27 2018/02/07 2018/05/09 13:02:40 KEISTEW    149  0
- IPVSRVD           1  24 2013/09/16 2013/09/23 08:22:43 TYRONED    23  0
- IPVSRVD           2  28 2015/08/10 2021/05/18 15:58:24 TYRONED    27 28
- IPVSRVDA          2  40 2017/04/27 2017/05/22 14:54:15 BRETD      36  0
- IPVSRVDB          2  87 2017/05/04 2017/05/22 08:51:21 TRAVIST    24  0
- IPVSRVDL          2  23 2015/03/25 2017/07/27 16:00:21 JPHILP2    21  0
- IPVSRVDP          2  16 2015/03/25 2017/06/22 11:54:24 JPHILP     15  0
- IPVSRVDX          2  28 2021/05/06 2021/05/06 10:44:16 TYRONED    28  0
- IPVSRVD1          2  15 2015/06/17 2016/12/01 15:24:07 JPHILP     15  0
  
```

Position the cursor on the plus (+) symbol and press **Enter** for data set list to determine the data set name associated with the Lib column number.

```

-----  Library List -----
Command ==>> _____ Scroll CSR
C Lib Data Set Name
  <-> <---+-----10---+-----2---+-----3---+-----4--->
D  1 SYS1.PROCLIB.TSD3.USER
  2 SYS1.PROCLIB.SYSPLEXD.USER
  *** End of data ***
ID          Init Mod _
*
TYRONED     29  0
JPHILP      15  0
  
```

Viewing a member

Process Options Help									
File Manager Member hit selection list Row 00001 of 00048									
Command ==> Scroll CSR									
Data set SYS1.PROCLIB.TSD3.USER +									
Name	Prompt	Lib	Size	Created	Changed		ID	Init	Mod
*	*		*	*	*		*		
√ IPVBRETD		2	29	2018/11/16	2018/11/16	14:15:25	TYRONED	29	0
- IPVSAVD9		2	25	2017/01/16	2017/01/16	15:16:32	MHUGHES	25	0
- IPVSRVBD		2	31	2018/04/16	2020/01/06	12:24:48	BRETD	23	0
- IPVSRVC		2	25	2015/08/10	2021/07/06	18:48:10	TYRONED	25	0
- IPVSRVCL		2	51	2015/04/02	2016/11/16	14:22:29	JPHILP	17	0
- IPVSRVCP		2	15	2015/03/25	2016/11/16	14:22:33	JPHILP	15	0
- IPVSRVC4		2	24	2013/09/27	2016/11/16	14:22:35	JPHILP	21	0
- IPVSRVC5		2	27	2018/02/07	2018/05/09	13:02:40	KEISTEW	149	0
- IPVSRVD		1	24	2013/09/16	2013/09/23	08:22:43	TYRONED	23	0
- IPVSRVD		2	28	2015/08/10	2021/05/18	15:58:24	TYRONED	27	28
- IPVSRVDA		2	40	2017/04/27	2017/05/22	14:54:15	BRETD	36	0
- IPVSRVDB		2	87	2017/05/04	2017/05/22	08:51:21	TRAVIST	24	0
- IPVSRVDL		2	23	2015/03/25	2017/07/27	16:00:21	JPHILP2	21	0
- IPVSRVDP		2	16	2015/03/25	2017/06/22	11:54:24	JPHILP	15	0
- IPVSRVDX		2	28	2021/05/06	2021/05/06	10:44:16	TYRONED	28	0
- IPVSRVD1		2	15	2015/06/17	2016/12/01	15:24:07	JPHILP	15	0

Press **Enter**.

File Edit Edit_Settings Menu Utilities Compilers Test Help									
VIEW SYS1.PROCLIB.SYSPLEXD.USER(IPVBRETD) - 01.00 Columns 00001 00072									
Command ==> Scroll ==> CSR									
000015	//RUN	EXEC	PGM=IPVSRVX,REGION=40M,TIME=1440,						
000016	//		PARM=('&PORT &FAMILY &TRACE')						
000017	//*		Common component library						
000018	//STEPLIB	DD	DISP=SHR,DSN=IPV.V1R8M0.SIPVMODA.LVLTEST						
000019	//*								
000020	//SYSPRINT	DD	SYSOUT=H						
000021	//STDOUT	DD	SYSOUT=H						
000022	//IPVTRACE	DD	SYSOUT=H						
000023	//*		Configuration details						
000024	//	SET	FM=FMSTYLE&FMSTYLE						
000025	//CONFIG	DD	DISP=SHR,DSN=IPV.V1R8M0.SERVER.CONFIGS.&BLD(&SSL)						
000026	//	DD	DISP=SHR,DSN=IPV.V1R8M0.SERVER.CONFIGS.&BLD(&FM)						
000027	//	DD	DISP=SHR,DSN=IPV.V1R8M0.SERVER.CONFIGS.&BLD(FAV13)						
000028	//*	DD	DISP=SHR,DSN=IPV.V1R8M0.SERVER.CONFIGS.&BLD(APA)						
000029	//	DD	DISP=SHR,DSN=IPV.V1R8M0.SERVER.CONFIGS.&BLD(DT)						
*****	***** Bottom of Data *****								

Show the enhanced search report for selected member

```

Process  Options  Help
-----  -
File Manager      Member hit selection list      Row 00001 of 00048
Command ==>      Scroll CSR

Data set SYS1.PROCLIB.TSD3.USER
Name      Prompt  Lib Size Created      Changed      ID      Init Mod
*         *
s IPVBRETD      2      29 2018/11/16 2018/11/16 14:15:25 TYRONED      29 0
- IPVSAVD9      2      25 2017/01/16 2017/01/16 15:16:32 MHUGHES      25 0
- IPVSRVBD      2      31 2018/04/16 2020/01/06 12:24:48 BRETD        23 0
- IPVSRVC       2      25 2015/08/10 2021/07/06 18:48:10 TYRONED      25 0
- IPVSRVCL      2      51 2015/04/02 2016/11/16 14:22:29 JPHILP       17 0
- IPVSRVCP      2      15 2015/03/25 2016/11/16 14:22:33 JPHILP       15 0
- IPVSRVC4      2      24 2013/09/27 2016/11/16 14:22:35 JPHILP       21 0
- IPVSRVC5      2      27 2018/02/07 2018/05/09 13:02:40 KEISTEW      149 0
- IPVSRVD       1      24 2013/09/16 2013/09/23 08:22:43 TYRONED      23 0
- IPVSRVD       2      28 2015/08/10 2021/05/18 15:58:24 TYRONED      27 28
- IPVSRVDA      2      40 2017/04/27 2017/05/22 14:54:15 BRETD        36 0
- IPVSRVDB      2      87 2017/05/04 2017/05/22 08:51:21 TRAVIST      24 0
- IPVSRVDL      2      23 2015/03/25 2017/07/27 16:00:21 JPHILP2     21 0
- IPVSRVDP      2      16 2015/03/25 2017/06/22 11:54:24 JPHILP       15 0
- IPVSRVDX      2      28 2021/05/06 2021/05/06 10:44:16 TYRONED      28 0
- IPVSRVD1      2      15 2015/06/17 2016/12/01 15:24:07 JPHILP       15 0
    
```

Select a member.

```

File  Edit  Edit_Settings  Menu  Utilities  Compilers  Test  Help
-----
VIEW      Enhanced Search Report      Index PROCLIB      Col 00001 00072
Command ==>      Scroll ==> CSR

***** ***** Top of Data *****
000001 -----
000002 >Data Set: SYS1.PROCLIB.SYSPLEXD.USER
000003 >Member : IPVBRETD
000004      15 //RUN      EXEC PGM=IPVSRVX,REGION=40M,TIME=1440,
000005 -----
000006 -- Find/Change summary section --
000007 -----
000008 Found :      1 >PGM=IPVSRV<
000009 ***** ***** Bottom of Data *****
    
```

Examples: Enhanced Change

Example 1. Change all data sets in a reference member

This example shows issuing an EC command to change a string in all data sets listed in a reference member.

Enter the EC command.

```

Menu Utilities Compilers Options Status Help
-----
ISR@PRIM z/OS Primary Option Menu
Option ==> EC ABC DEF /CNTL
-----
0 Settings Terminal and user parameters User ID . : TDORNEY
1 View Display source data or listings Time. . . : 12:37
2 Edit Create or change source data Terminal. : 3278
3 Utilities Perform utility functions Screen. . : 1
4 Foreground Interactive language processing Language. : ENGLISH
5 Batch Submit job for language processing Appl ID . : ISR
6 Command Enter TSO or Workstation commands TSO logon : ISPF
7 Dialog Test Perform dialog testing TSO prefix: TDORNEY
9 IBM Products IBM program development products System ID : FMD2
10 SCLM SW Configuration Library Manager MVS acct. : IBMGSA
11 Workplace ISPF Object/Action Workplace Release . : ISPF 7.1
12 z/OS System z/OS system programmer applications
13 z/OS User z/OS user applications
14 IBMGSA IBMGSA Development and Service Apps
S SDSF SDSF

Enter X to Terminate using log/list defaults
F1=Help F2=Split F3=Exit F7=Backward F8=Forward F9=Swap
F10=Actions F12=retrieve

```

Press Enter to make a non-immediate change of the data sets defined in the reference member CNTL. The proposed changes are displayed in the Enhanced Change Report.

```

File Edit Edit_Settings Menu Utilities Compilers Test Help
-----
Enhanced Change Report Index CNTL Col 00001 00072
Command ==> ----- Scroll ==> CSR
***** ***** Top of Data *****
000001 -----
000002 >Data Set: TDORNEY.CNTL
000003 >Member : AA68093
000004 9 // SET IPVLV=DEF
000005 >Member : CHARS
000006 9 #DEFdefghi~`Diçñ
000007 >Member : DITQQ
000008 30 say CHANGE('DEFDEFDEF','DEF','DeF') 'DeFDEFDEF'
000009 31 say CHANGE('DEFDEFDEF','DEF','DeF',2) 'DeFDeFDEF'
000010 32 say CHANGE('DEFDEFDEF','DEF','DeF',0) 'DeFDeFDeF'
000011 33 say CHANGE('DEFDEFDEF','DEF','DeF',4) 'DEFDeFDEF'
000012 35 say CHANGE('DEFDEFDEF','a',,0) 'bcbcbc'
000013 >Member : EXTFN002
000014 38 SETC(DEF,'A')
000015 42 SETC(DEF,'A')
000016
000017 22 line(s) in 8 of 915 Member(s) and 1 of 1 File(s).
F1=Help F7=Up F8=Down F9=Swap F10=Left F11=Right F12=retrieve 6=Rchange

```

Press F3 to exit the report panel.

```

----- Change Save Warning -----
- FMNPCWRN ==> -----
I
O
0 You have NOT saved the changes you have made. Press ENTER to save
1 or PF3/END to cancel changes:
2
3 Total changes 36
4 Total members 8
5 Total files 1
F1=Help F2=Split F3=Exit F7=Backward F8=Forward
F9=Swap F12=Cancel
F

```

Press Enter to save the changes.

Example 2. Issue EC command from ISPF 3.4

This example shows issuing an EC command in a list of data sets in ISPF option 3.4.

Enter the EC command to change the string ABC to DEF.

```

Menu Options View Utilities Compilers Help
-----
ISRUDSL0 Data Sets Matching TDORNEY.CNTL Row 1 of 2
Command ==> EC ABC DEF Scroll ==> CSR

Command - Enter "/" to select action Message Volume
-----
          TDORNEY.CNTL D$US11
          TDORNEY.CNTL.VB D$US39
***** End of Data Set list *****

F1=Help      F2=Split      F3=Exit      F5=Rfind     F7=Up       F8=Down
F9=Swap     F10=Left     F11=Right   F12=retrieve
    
```

Press Enter. The proposed changes are displayed in the Enhanced Change Report.

```

File Edit Edit_Settings Menu Utilities Compilers Test Help
-----
Enhanced Change Report Index DSLIST Col 00001 00072
Command ==> Scroll ==> CSR
***** Top of Data *****
000001 -----
000002 >Data Set: TDORNEY.CNTL
000003 >Member : AA68093
000004 9 // SET IPVLVL=DEF
000005 >Member : CHARS
000006 9 #DEFdefghi~`ÐÐiçñ
000007 >Member : DITQQ
000008 30 say CHANGE('DEFDEFDEF','DEF','DeF') 'DeFDEFDEF'
000009 31 say CHANGE('DEFDEFDEF','DEF','DeF',2) 'DeFDeFDEF'
000010 32 say CHANGE('DEFDEFDEF','DEF','DeF',0) 'DeFDeFDeF'
000011 33 say CHANGE('DEFDEFDEF','DEF','DeF',,4) 'DEFDeFDEF'
000012 35 say CHANGE('DEFDEFDEF','a',,0) 'bcbcbc'
000013 >Member : EXTFN002
000014 38 SETC(DEF,'A')
000015 42 SETC(DEF,'A')
000016
000017 23 line(s) in 9 of 918 Member(s) and 2 of 2 File(s).
F1=Help      F7=Up       F8=Down     F9=Swap     F10=Left    F11=Right   F12=retrieve 6=Rchange
    
```

Place the cursor on the Index value DSLIST in the panel title and press Enter to see the data set list.

```

----- Search Data Set List ----- Test Help
==> ----- Row 1 to 2 of 2
-----
C Data set list
* TDORNEY.CNTL
0 TDORNEY.CNTL.VB
0 ***** Bottom of data *****
Right F12=retrieve
    
```

Example 3. EC command panel: batch option

This example shows generating JCL to submit the scan or change request as a batch job.

Enter EC to open the **Enhanced Change Command** panel.

Enter the *“before”* and *“after”* strings in the **Search** and **Replace** fields.

```

----- Enhanced Change Command -----
- I
0 Command:
  Search _____ +
0 Replace def _____ + ONED
1 Options Columns Limits Change 46
2 - 1 Prefix ----- From ----- MAXINREC - ISPF 8
3 - 2 Suffix ----- To ----- MAXRECS - Memory
4 - 3 Word ----- FIRST
5 Member ----- - Edit LISH
6
7 Scope:
9 Member ----- - Edit F
  ONED
1 DDnames _____ + 2
1 DSNs . _____ + GSA
  F 7.1
1
1 Options:
1 Enter "/" to select option ISPF Pack
1 - Immediate - Result - Parmlib - Proclib - 1. Asis
S - Batch - Jobcard - Edit 2. Skip
  F1=Help F2=Split F3=Exit F4=Expand F7=Backward
  F8=Forward F9=Swap F10=Left F11=Right F12=Cancel p
F

```

Press Enter to view and submit the batch JCL.



Note: Because the **Immediate** option was not selected the batch job will run scan mode only. To apply the changes, select the **Immediate** option and then press Enter. This will regenerate the JCL with the keyword UPDATE=YES.

Example 4. EC command panel: select from history

This example shows selecting a command from the history list of previous change requests.

Enter EC to open the **Enhanced Change Command** panel.

```

----- Enhanced Change Command -----
- I
0 Command:
  Search _____ +
0 Replace def _____ + RNEY
1 Options Columns Limits Change 46
2 - 1 Prefix ----- From ----- MAXINREC - ISPF 8
3 - 2 Suffix ----- To ----- MAXRECS - Memory
4 - 3 Word ----- FIRST
5 Member ----- - Edit LISH
6
7 Scope:
9 Member VSAM ----- - Edit F
  ONED
1 DDnames _____ + 2
1 DSNs . _____ + GSA
  F 7.1
1
1 Options:
1 Enter "/" to select option ISPF Pack
1 - Immediate - Result - Parmlib - Proclib - 1. Asis
S - Batch - Jobcard - Edit 2. Skip
  F1=Help F2=Split F3=Exit F4=Expand F7=Backward
  F8=Forward F9=Swap F10=Left F11=Right F12=Cancel p
F

```

Place the cursor in the blank **Search** field and then press Enter. The **History Change Commands** panel is displayed.

```

Process
-----
FMNPHCHG          History Change Commands          Row 1 to 13 of 14
Command ==>>    ----- Scroll CSR
                                     B
                                     P P A
                                     I R A R T
                                     M E R O C
                                     M S M C H
Search  Replace  T Member  Refer  DDnames  Data set names
- abc    def
- a      b
- 'SETVAR ' ''          SETVAR
- GALEVEL PFM17237          IVP.V1R8M0.SERVE
s new    old          VSAM
- a      b          fmn.f2data.ksds
-                ABCDEF  WEBINAR1
- abc    def          dtorney.cntl
- abc    def          dtorney.cntl / /
-                ABCDEF  fmn.f2data
- FMN.SCLMV1 FMN.SCLMV1 fmn14svc.projdef
- $TUTCMMSG $LEMSG          IVP18SVC.PROJDEF
- ',@@FLMETP ',@@FLMETP V14SQL
F1=Help  F2=Split  F3=Exit  F4=Expand  F7=Backward F8=Forward
F9=Swap  F10=Left  F11=Right F12=Cancel
    
```

Type S next to one of the saved commands. Press Enter to return to the **Enhanced Change Command** panel with the attributes of the saved request already filled in.

```

----- Enhanced Change Command -----
- FMNPHCHNG ==> -----
I
0 Command:
0 Search new +
0 Replace old +
1 Options Columns Limits Change
2 - 1 Prefix ----- From ----- MAXINREC - ISPF RNEY
3 - 2 Suffix ----- To ----- MAXRECS - Memory 46
4 - 3 Word ----- FIRST 8
5 Member ----- - Edit LISH
6
7 Scope: F
9 Member VSAM - Edit ONED
1 DDnames ----- +
1 DSNs . ----- +
1
1 Options:
1 Enter "/" to select option ISPF Pack
1 - Directory - Drill - Result - Parmlib - Proclib - 1. Asis
S - Batch - Jobcard - Edit 2. Skip
F1=Help F2=Split F3=Exit F4=Expand F7=Backward
F8=Forward F9=Swap F10=Left F11=Right F12=Cancel p
F
    
```

Press Enter to rerun the change command.

Indexed search

Use the indexed search to search for words in one or more partitioned data sets that are not load libraries. The search uses an index that contains all of the words and the occurrences of each word in a group of data sets.

The indexed search is quick way to search for all occurrences of a word in one or more partitioned data sets. The search supports pattern matching with wild cards. Wild card characters provide a convenient way to specify pattern matching characters. You can also use Boolean operators to specify more than one word. Unlike the Enhanced Search command, the indexed search is not a sequential search across data sets. It relies on a pre-built index to quickly identify matches.

Definitions

The following is a list of terms and a description of the artifacts used by the indexed search:

Index directory

A partitioned data set containing index members and corresponding descriptions.

Index member

An index definition that contains the following artifacts:

Index file

KSDS data set name containing all of the words and occurrences defined in a group of data sets.

Language file

Language definition to identify words in the associated group of data sets.

If you omit the language file, then the behavior defaults to automatic word detection, duplicate members are ignored, and words are not case sensitive.

Data set 1-*n*

Partitioned data sets grouped by language.

Checklist - steps required to set up the indexed search

The following are the high-level steps that must be performed before you can perform an indexed search:

1. Define ISPF commands for invoking the indexed search utility. See [Setting up the indexed search ISPF command on page 617](#).
2. Define one or more index directory data sets. See [Creating a new index directory data set on page 619](#).
3. Define one or more index members. See [Index definition members on page 620](#).
4. Build the index. See the "B" line command in [Index List panel on page 628](#).
5. Perform a search. See the "S" command in [Index List panel on page 628](#) to select an index member for searching, [Invoking the XFind command on page 618](#), or the [Index Search panel on page 631](#) for details on search expressions and navigation.

Setting up the indexed search ISPF command

You can define the indexed search command both with or without LIBDEFs.

This section describes defining the ISPF command for invoking the indexed search. You can define any name for the command. The name used for this example is XFIND. The abbreviated form is XF. XF is used throughout this section as the command that invokes an indexed search.

Define the indexed search command with LIBDEFs

Specify the command as follows:

Figure 160. Command Table Utility Extended Command Entry

```

File  Menu  Utilities  Help
-----Command Table Utility-----
                          Extended Command Entry
Command ==> _____

Make changes to the command and select Update to update the entry or
Cancel to ignore the changes.

Verb  . . . XFind _____
Trunc . . . 2
Action . . . SELECT CMD(%FMNELIBD IDX &ZPARM) NEWAPPL(FMN)
                _____
                _____

Description File Manager Indexed search
                _____

Enter / to select option
/ Allow mixed-case in Action field

Update                      Cancel

```

Define the indexed search command without LIBDEFs

Specify the command as follows:

Figure 161. Command Table Utility Extended Command Entry

```

File  Menu  Utilities  Help
-----Command Table Utility-----
                          Extended Command Entry
Command ==> _____

Make changes to the command and select Update to update the entry or
Cancel to ignore the changes.

Verb  . . . XFind _____
Trunc . . . 2
Action . . . SELECT CMD(%FMNINDEX &ZPARM) NEWAPPL(FMN)
                _____
                _____

Description File Manager Indexed search
                _____

Enter / to select option
/ Allow mixed-case in Action field

Update                      Cancel

```

Invoking the XFind command

Syntax

Use the XF command to invoke an indexed search using the following syntax:

```

▶ XFind [String] [Index]

```

Blank

The Index Search panel for the previous search index is displayed.

string

The Index search panel for the previous search index is displayed with all of the words matching the specified string.

Index

(The abbreviated form is represented by "I"). This shows the Index directory list panel.



Note: When using the XFind command for the first time, the **Index List panel** is displayed. See [Index List panel on page 628](#).

Creating a new index directory data set

Create a new index directory data set and allocate the index directory file.

The Index list panel is displayed the first time the XFind command is invoked or subsequently by specifying the **I** parameter with the XFind command:

```
XF I
```

To create a new index directory data set, complete the following steps:

1. Enter a new index directory data set name and press **Enter**. In the following example, the new index directory data set name is `FMN.XFIND.INDEX.DIR`

Process			
File Manager	Index List	Enter required field	
Command ==>		Scroll PAGE	
Data set name	FMN.XFIND.INDEX.DIR		
Member pattern	Jobcard	Reuse	
Name	Description	Date Changed	Size
***** Bottom of data *****			

2. Allocate the index directory file.

Process		Allocate data set
F	Command ==>	
C	The data set was not found	GE
D	Data set name	FMN.XFIND.INDEX.DIR
M	* Change the data set name or	***
	Press ENTER to allocate a new data set	
	Press EXIT or CANCEL to return without allocation.	

3. Press **Enter**. The new data set is allocated.

Now that the new data set is allocated, you can proceed to create an index member as described in [Index definition members on page 620](#).

Index definition members

Insert New member panel

The **Insert New member** panel to create a new index is displayed when:

1. A new index directory data set is created.
2. The prefix command, I, is entered on the **Index List** panel.
3. The primary command `S new_member_name` is entered on the **Index List** panel.

Figure 162. Insert New member panel

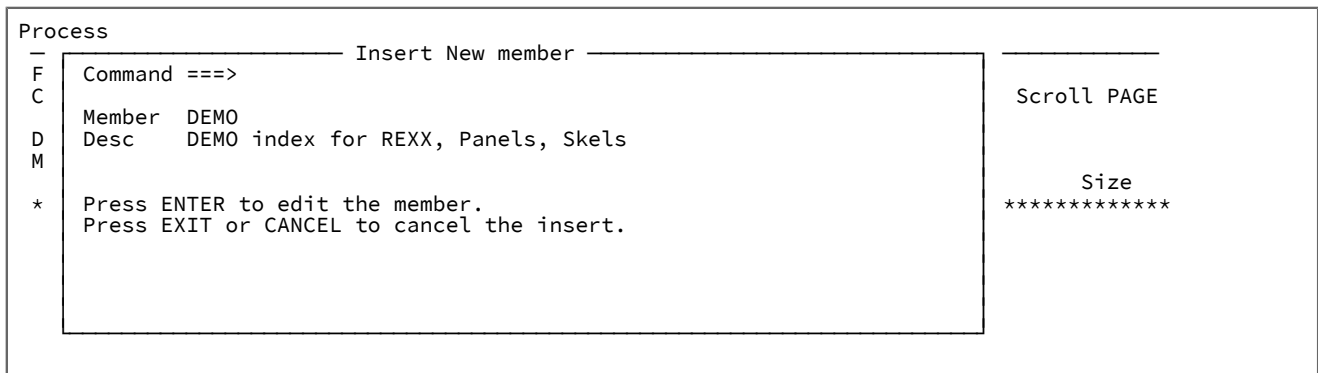

Field descriptions

Member

The name of the new index definition member to be created. This is the index name.

Description

A brief description of the index being created.

Editing an index definition member

An edit session on an index member occurs when:

- **Enter** is pressed from the **Insert New member** panel.
- The prefix command, E, is entered on the **Index List** panel.
- The primary command, `S existing_member_name`, is entered on the **Index List**

```

File Edit Edit_Settings Menu Utilities Compilers Test Help
EDIT          FMN.XFIND.INDEX.DIR(DEMO) - 01.00          Columns 00001 00072
Command ==>                               Scroll ==> PAGE
***** ***** Top of Data *****
=NOTE= INDEX Members consist of lines in the following form:
=NOTE= INDEX=index.data.set.name
=NOTE= LANG=language_dsn(member)
=NOTE= data set name 1
=NOTE= data set name 2
=NOTE=      :
=NOTE= data set name N
=NOTE= Repeat LANG= and data sets lines for different types
| | | | |
| | | | |
| | | | |
| | | | |
| | | | |
| | | | |
| | | | |
| | | | |
| | | | |
| | | | |
| | | | |
| | | | |
| | | | |
| | | | |
***** ***** Bottom of Data *****

```

where,

INDEX=

Identifies the index file which is a VSAM KSDS data set name that is created by the build job. This should be the first statement, and only one index data set name can be specified.



Note: A build deletes the data set if it exists and creates it with a size appropriate for the number of words and occurrences found.

LANG=

The data set name containing the language definition for the following data sets.

DSN1-DSNn

Each line following must contain a data set that must be partitioned and have a Variable or Fixed blocked record format.

All data sets must have like attributes.



Note: The **LANG=, DSN1-DSNn** grouping must be repeated for a different language or data sets with different attributes as illustrated in the following example.

Figure 163. Example

```

File Edit Edit_Settings Menu Utilities Compilers Test Help
EDIT          FMN.XFIND.INDEX.DIR(DEMO) - 01.00          Columns 00001 00072
Command ==>                               Scroll ==> PAGE
***** ***** Top of Data *****
=NOTE= INDEX Members consist of lines in the following form:
=NOTE= INDEX=index.data.set.name
=NOTE= LANG=language_dsn(member)
=NOTE= data set name 1
=NOTE= data set name 2
=NOTE=      :
=NOTE= data set name N
=NOTE= Repeat LANG= and data sets lines for different types
000001 INDEX=FMN.INDEX.DEMO          ①
000002 LANG=FMN.SFMNSAM1(FMNXREXX)
000003 FMN.DEMO01.EXEC
000004 FMN.EXEC
000005 LANG=FMN.SFMNSAM1(FMNXPNLS)
000006 FMN.DEMO01.PANELS
000007 FMN.PANELS
000008 LANG=FMN.SFMNSAM1(FMNXSKEL)
000009 FMN.DEMO 01.SKELS
000010 FMN.SKELS
    
```

Index definition build process

The following diagram illustrates the build process for creating an index file from the artifacts described in the index member.

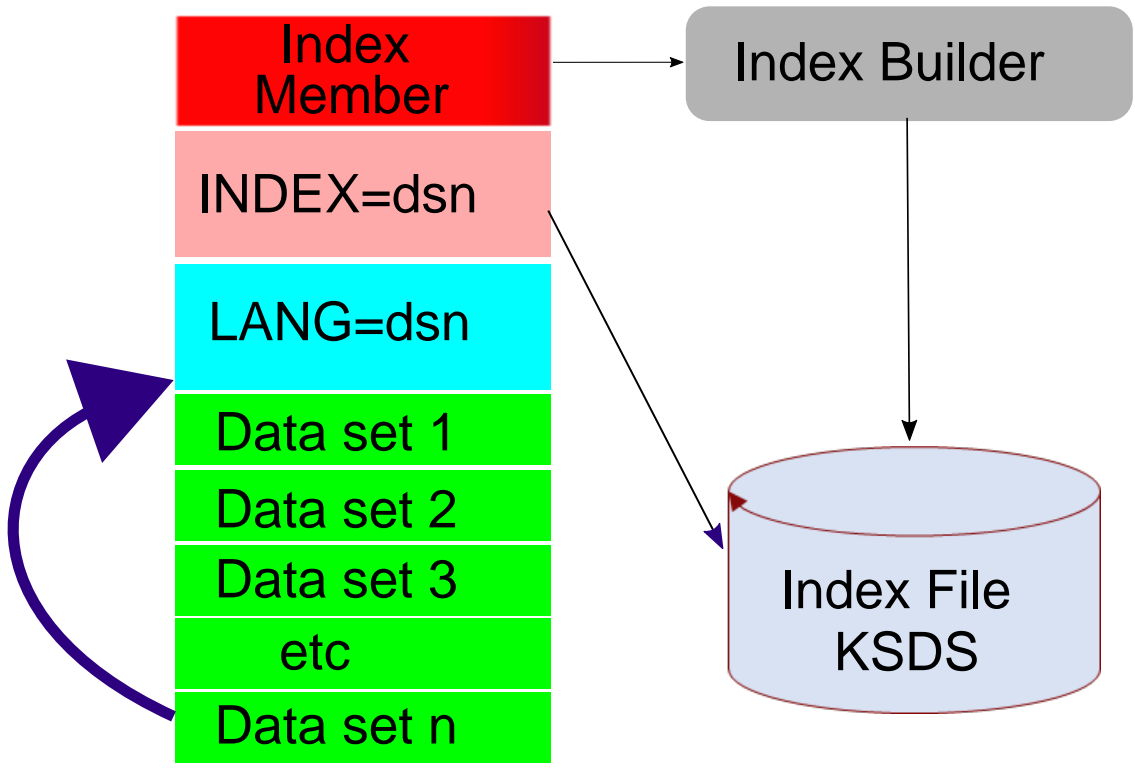

Customizing a language file

The language file has keywords that determine the following:

- The start and delimiter characters that are used in determining what constitutes a word.
- If the duplicate member names should be processed.
- If words are case sensitive.

Automatic word detection

Automatic word detection is the recommended method for determining words. It determines words for all languages and no understanding of the word parsing mechanism documented in this section is required.

Rules for automatic word detection

The following rules apply:

1. Umlauts, accented characters, and numbers are all processed as part of word.
2. Sequence numbers if detected in columns 73–80 and columns 1–6 are ignored for data sets that are fixed with a logical record length of 80.
3. Data set names or words joined by periods produce a long word including the periods and the individual words. For example, `FMN.SFMNMOD1`, produces the words `FMN`, `SFMNMOD1` and `FMN.SFMNMOD1` in the index.
4. COBOL or words joined by dashes produce a long word including the dashes and the individual words. For example, `REC-TYPE` produces the words `REC`, `TYPE` and `REC-TYPE` in the index.
5. A word prefixed with the ampersand character (&) produces the word with and without the prefix in the index. For example, `&MYVAR` produces the words `&MYVAR` and `MYVAR` in the index.

Activating automatic word detection

There are two methods of activation:

Omit the LANG= keyword from the build member definition

Duplicate members are ignored and word searching is not case sensitive.

Specify the LANGAUTO=YES keyword in the language file

The following table describes the provided language files for automatic word detection with the combinations of duplicate member and mixed case processing.

Table 19. Language files provided for automatic word detection and the combinations of duplicate member and mixed case

Member	Duplicate members	Mixed case
FMNAUDC	Yes	Yes
FMNAUTC	No	Yes
FMNAUTD	Yes	No

Table 19. Language files provided for automatic word detection and the combinations of duplicate member and mixed case (continued)

Member	Duplicate members	Mixed case
FMNAUTO	No	No

Default start and delimiter characters when not using automatic word detection

If you are not using automatic word detection, then words are determined by scanning for a start character and then scanning for a delimiter character on any given record.

The following tables show the default start and delimiter characters that are used to identify words.

The table highlighting the start characters contains all 256 characters of the EBCDIC (Extended Binary Coded Decimal Interchange) character set. The start characters are any alphabetic character: A-Z, a-z.

Figure 164. Start characters

	0	1	2	3	4	5	6	7	8	9	A	B	C	D	E	F
0																
1																
2																
3																
4			â	ã	à	á	ã	ä	ç	ñ	ç	.	<	(+	
5	&	é	ê	ë	è	í	î	ï	ì	ß	!	\$	*)	;	~
6	-	/	Â	Ã	À	Á	Ã	Ä	Ç	Ñ		,	%	_	>	?
7	ø	É	Ê	Ë	È	Í	Î	Ï	Ì	`	:	#	@	'	=	"
8	∅	a	b	c	d	e	f	g	h	i	«	»	ø	ý	þ	±
9	°	j	k	l	m	n	o	p	q	r	æ	ø	æ	,	Æ	¤
A	μ	~	s	t	u	v	w	x	y	z	i	¿	Ð	Ý	Þ	®
B	^	£	¥	.	©	§	¶	¼	½	¾	[]	-	-	-	x
C	{	A	B	C	D	E	F	G	H	I	-	ô	ö	ò	ó	õ
D	}	J	K	L	M	N	O	P	Q	R	¹	û	ü	ù	ú	ÿ
E	\	÷	S	T	U	V	W	X	Y	Z	²	Ô	Ö	Ò	Ó	Õ
F	0	1	2	3	4	5	6	7	8	9	³	Û	Ü	Ù	Ú	

The table highlighting the delimiter characters contains all 256 characters of the EBCDIC character set. The delimiter characters are any character in the EBCDIC character set that does not represent an alphabetic character (A-Z, a-z), numeric character (0-9), nor the underscore character (_).

Figure 165. Delimiter characters

	0	1	2	3	4	5	6	7	8	9	A	B	C	D	E	F
0																
1																
2																
3																
4			â	ã	à	á	ã	å	ç	ñ	ç	.	<	(+	
5	&	é	ê	ë	è	í	î	ï	ì	ß	!	\$	*)	;	~
6	-	/	Ã	Ä	À	Á	Ã	Å	Ç	Ñ		,	%	_	>	?
7	ø	É	Ê	Ë	È	Í	Î	Ï	Ì	`	:	#	@	'	=	"
8	Ø	a	b	c	d	e	f	g	h	i	«	»	ø	ý	þ	±
9	°	j	k	l	m	n	o	p	q	r	æ	ø	æ	„	Æ	¤
A	μ	~	s	t	u	v	w	x	y	z	i	¿	Ð	Ý	Þ	®
B	^	£	¥	·	©	§	¶	¼	½	¾	[]	-	-	´	x
C	{	A	B	C	D	E	F	G	H	I	-	ô	ö	ò	ó	õ
D	}	J	K	L	M	N	O	P	Q	R	¹	û	ü	ù	ú	ÿ
E	\	÷	S	T	U	V	W	X	Y	Z	²	ô	ö	ò	ó	õ

Language file keyword descriptions

When you specify keywords in a language file, ensure you specify one keyword per line.

With the default behavior, words must start with an English alphabetic character, number, or underscore. The start character and delimiter character keywords that follow, control changing this behavior.

Start character keywords

The following examples demonstrate how to specify start keywords, as well as, how to exclude start characters.

START='cccc'

In addition to the default start characters (any alphabetic character, a-z, A-Z), specify additional characters to be considered as start characters.

Example 1: Specify the percent (%) and at "@" characters as additional start characters

```
START=' &@'
```

Example 2: Recognize other characters, such as, umlaut characters and accented characters, as start characters

```
START=' áâãäåäçñéêëëíîïðóôöóúüúýÿÀÁÂÃÄÅÇÑÊËËÍÎÏÐÓÔÕÖÙÚÛ'
```

XSTART='cccc'

Exclude start characters.

Example: Create an index of capitalized words excluding lowercase characters

```
XSTART=' abcdefghijklmnopqrstuvwxyz'
```

Delimiter character keywords

The following examples demonstrate how to specify delimiter keywords in your search, as well as, how to exclude delimiter characters.

DELIM='cccc'

In addition to the default delimiter characters (any character that does not represent an alphabetic, numeric, or underscore character), specify additional characters to be considered as delimiter characters.

Example: Interpret the underscore (_) character as a delimiter

```
DELIM=' _ '
```

XDELIM='cccc'

Exclude delimiter characters.

Example 1: For COBOL source, do not consider the minus sign (-) as a delimiter character

```
XDELIM=' - '
```

Example 2: For JCL, do not consider a period (.) as a delimiter character

```
XDELIM=' . '
```

Example 3: Recognize other characters, such as, umlaut characters and accented characters, as part of the word

```
XDELIM=' äåäåäçñéèëèìíîïðóôöõöüüÿĂĂĂĂĂĂÇŃÉÊËËÍÎÏÏÏŸÓÓÓÓÓÓÛÛÛ '
```

XEND='ccc'

Exclude specific characters from the end of a string.

Example: For JCL, a period can occur as an intermediate character in a data set name, but not at the end

```
XEND=' . '
```

General keywords

General keywords enable you to specify special cases such as the following:

- Exclude words from being indexed.
- Provide a minimum length for a word.
- Use case-sensitive word matching.
- Process duplicate member names.

LANGAUTO=YES

Specify this keyword to activate automatic word detection.

XWORD=(word1,word2,... wordn)

Exclude words from being indexed. This keyword can be used for words that occur frequently.

Example: Exclude the words IF, THEN, DO, and END for the REXX language

```
XWORD=( IF , THEN , DO , END )
```

MARgins=(start,end)

Specify a start and ending column.

Example: For COBOL, process word starting from column 8 to column 72

```
MAR=( 8 , 72 )
```

MIN=*n*

Use this keyword to provide a minimum length for a word.

Example: Remove simple count variables that are one byte long such as, I, J, K.

```
MIN=2
```

CASE=YES

Specify **CASE=YES** to produce case-sensitive word matching for the index. The default is **NO**.

DUP=YES

Specify **DUP=YES** to process duplicate member names. The default is **NO**.

Example 1: JCL

```
START='&'
XDELIM='.&#'
XEND='.'
DUP=YES
XWORD=(DD,DSN)
```

Example 2: COBOL

```
XDELIM='-'
XEND='-'
MAR=(8,72)
XWORD(IF,PERFORM,CALL)
```

Example 3: Assembler

```
START='@&'
XDELIM='@'
MIN=2
MAR=1,72
```

Example 4: Treat numbers as words

The default behavior is to exclude numbers as start characters therefore excluding numbers as words. To recognize numbers as words, and allow for intermediate decimal points, specify the following:

```
START='0123456789'
XDELIM='.'
XEND='.'
```

Sample language file members provided in hlq.SFMNSAM1

Table 20. Sample language file members provided in

Member name	Description
FMNXASM	Assembler
FMNXASMN	Assembler with numbers
FMNAUDC	LANGAUTO=YES DUP=YES CASE=YES
FMNAUTC	LANGAUTO=YES DUP=NO CASE=YES
FMNAUTD	LANGAUTO=YES DUP=YES CASE=NO
FMNAUTO	LANGAUTO=YES DUP=NO CASE=NO
FMNXC	C or C++
FMNXCCAS	C or C++ with case sensitive words
FMNXCBL	COBOL
FMNxCBLN	COBOL with numbers
FMNXLST	CLIST
FMNXJCL	JCL
FMNXMSGGS	ISPF messages
FMNXPLI	PL/I
FMNXPLIN	PL/I with numbers
FMNXPNS	ISPF panels
FMNXREXX	REXX
FMNXSKEL	ISPF skeletons

Index List panel

The **Index List panel** displays the index directory list. From this panel you can perform the following actions:

- Select or create an index directory data set.
- Filter the member list.
- Insert, rename, delete, edit, or view members.
- Update the member descriptions.
- Build an index.
- Select an index.

Panel and field descriptions

The following panel displays when you enter the command XF I or XF for the first time.

Figure 166. Index List panel

```

Process  Options  Help
-----
File Manager          Index List
Command ===> _____

Data set name  FMN.XFIND.INDEX.DIR
Member pattern _____ _ Jobcard  _ Reuse
Name  Description          Date Changed  Size
- DEMO1  EXECs, Panels, Messages, and Skeletons  2022/03/20 11:51  13
- DEMO2  COBOL Source files  2022/03/20 11:51  20
- DEMO3  JCL and PROCLIB data sets  2022/03/20 11:51  15

***** Bottom of data *****

```

Data set name

This is the index directory data set name that contains index members.

Leave this field blank to select from a history list.

You can enter a generic name to select from a matching data set list. In a generic name, use the percent (%) sign to represent a single character and an asterisk (*) to represent any number of characters within one qualifier. Two asterisks (**) represent any number of characters within any number of qualifiers.

If the data set name is not found in the catalog, then a prompt to allocate the data set is displayed.



Note: Use the allocate dialog to allocate the index data set to ensure it is defined with the correct file attributes.

Member pattern

Specify a member pattern to filter the member list.

Jobcard

Enter the forward slash (/) to specify the job card for an index build job.



Note: Ensure **REGION=OM** is used because the index is built in memory before the data set is created.

Reuse

Enter the forward slash (/) to select this option to reuse the existing allocation rather than delete and define the data set during an index build.



Note: . It is recommended to use the default behavior because it sizes the data set exactly to the index being built. This option is only available for the unlikely event that a delete or define cannot be performed due to the data set being allocated, but not open to another address space.

Column descriptions

Name

The index member name.

Description

The input field to update or view existing member descriptions.

Date changed

The date and time the member was last modified.

Size

The number of lines in the member.

Primary commands

L string

Searches for the value in the member name and description fields. **L JCL** searches the member name and description for the value JCL.

F string

Searches the contents of the members for one or more strings. This performs an enhanced search of the index directory data set for the string specified. Use **AND** & or **OR** | connectors to provide more than one string.

S *membername*

Select an existing member for search processing or create a new member if the member name does not exist.

****SORT column****

You can sort any column by placing the cursor on the column header and pressing **Enter**. Alternatively, you can issue the sort command where the column values are:

- Name
- Description
- Date Changed
- Size

REFRESH

Refreshes the current member list.

Line commands

S

Selects an index member for subsequent search processing.

B

Edits a job that can be submitted to build or rebuild the index.



Note: It is recommended that **REGION=OM** is specified when running the job to ensure enough memory is available to build large indexes.

E

Edit a member.

V

View a member.

I

Insert a new member.

R

Rename a member.

D

Delete a member.

Index Search panel

The **Index Search panel** is displayed when:

- Selecting an index member from the index directory list.
- The XF command is entered, with or without a search string (with the exception of the initial invocation).
- A nested enhanced find command with a search string, for example, EF NEW.

Figure 167. Index Search panel

<u>P</u> rocess	<u>O</u> ptions	<u>H</u> elp
Index DEM01	EXECs, Panels, Messages, Skeletons	Row 00001 of 00000
Command ==> _____		Scroll <u>P</u> AGE
Search: _____		+
Word	Hits	Data sets Members
*		
<-----10-----2-----3-----4----->	<----->	<----->

The **Index Search panel** is displayed when no string is provided.

Specifying a search expression

Search

This is where you specify your search arguments which are one or more words connected by AND & or OR | clauses and perform an index search.

Specify a search expression in the search field to list matching words in the index. Position the cursor to the display word and press **Enter** to display an indexed search report.

To retrieve a previous search value, press **Enter** with a blank search value. Use the **S** prefix command to retrieve a previous search from the displayed list.

The search field is scrollable so use the F10 (left), F11 (right), and F4 (expand) keys to enter more than the displayed width.

Expression rules

The following rules apply when specifying the search expression:

- Each word specified must be no more than 46 characters long.
- The word can contain the following wild card characters so that pattern matching is performed: asterisk (*) or % (percent) sign.

*

Represents any number of characters. For example: *ABC* can be specified to match any word containing the characters ABC.

%

Matches any value in the specific position represented by the percent sign. For example: %ABC% can be specified to match any word that is 5 bytes long and contains ABC starting in the second byte.

- If only one word without a wild card character is specified, then it is treated as a prefix for matching words.
- If more than one word is specified, then words without wild card characters are matched exactly with index words.
- When the AND (&) connector is used in the expression, the index list displays the first word in the expression.. The number of occurrences is limited to lines that contain matches for all words in the expression. Any combination of AND (&) and OR (|) values are allowed in the one expression.

Example 1: AA & BB & CC

Result:

AA with the number of occurrences limited to lines containing BB and CC word values.

Example 2: AA | BB & CC | EE & FF

Result:

- **AA**: All lines containing **AA** as a word value.
- **BB**: With the number of occurrences limited to lines containing **CC** word values.
- **EE**: With the number of occurrences limited to lines containing **FF** word values.

Example 3: **AA*** | **BB*** & **CC***

Result:

- **AA***: All lines containing words with **AA** as a prefix.
- **BB***: Lines that contain both **BB** and **CC** prefixed words

Column descriptions

Word

Lists the words that match the expression. Position the cursor to a resultant word match and press **Enter** in this column to show the indexed search report.

Hits

Number of lines where the word occurs. Position the cursor and press **Enter** in this column to show the indexed search report.

Data sets

Number of data sets containing this word. Position the cursor and press **Enter** in this column to display the data sets containing this word.

Members

Number of members. Position the cursor and press **Enter** in this column to display a summarized indexed search report.

Navigation

The Indexed search report is similar to the Enhanced search report and the navigation of the report is similar. See [Navigating the Enhanced search and Change report on page 581](#) for details about how you can navigate the Indexed search report.

The usage of the enhanced search key for summarizing the report is identical, so it is important to set up the enhanced search key. See [Using F4 from any edit or view session when positioned on a string or word on page 583](#) and [Using the F4 function key on page 581](#) to learn how to use the function key.

In addition to enhanced search report navigation, indexed search supports the following primary command from all view or edit sessions produced:

/

If this command is issued with the cursor on a searchable word, then a nested **Index Search** panel with the matching words is displayed.

If you press **Enter** on any word from a resultant view or edit session of data – then a nested indexed search is performed and a nested indexed search report is produced.

The **CAN**cel primary command returns you to the previous Index search panel display.

Example

The following example demonstrates the following:

1. How to select the "DEMO1" index directory list and retrieve a list of previous searches and resubmit the indexed search for words matching "SET*SG".
2. How to display a list of the data sets containing occurrences of the word "SETMSG".
3. How to display an indexed report restricted to data set names and member names.
4. How to drill-down to the first occurrence of the word "SETMSG" in a specific member.
5. How to navigate to the full Index Search Report from either the **Word** column or the **Hits** column.
6. How to navigate to a specific line number of the member.
7. How to produce a nested Indexed Search Report for the word "APCT004C"
8. How to issue the / primary command with the cursor positioned on the "APCT004C" word display a nested **Index Search** panel with the matching words.

1. Select "DEMO1" from the **Index List** panel.

```

Process  Options  Help
-----
Index DEMO1      EXECs, Panels, Messages, and Skeletons  Row 00001 of 00000
Command ==>>>                               Scroll CSR

Search:
Word                               Hits      Data sets Members
*
<-----10-----2-----3-----4-----+ <-----> <-----> <----->
**** End of data ****
    
```

2. To retrieve a previous search argument, press **Enter** on the blank search argument. The list of previous search words are listed under **History Value**. Select the first search history value.

```

Process  Options  Help
-----
File Manager      History Selection List  Row 00001 of 00050
Command ==>>>                               Scroll CSR

History Value
s SET*SG
SETM
SET
SETMSG
SCLM
FMN
SET & ALLOC*
    
```

3. With the "SET*SG" word selected, press **Enter** to re-issue the search for the "SET*SG" word.

```

Process  Options  Help
-----
Index DEM01      EXECs, Panels, Messages, and Skeletons  Row 00001 of 00002
Command ==>                                           Scroll CSR

Search:  SET*SG
Word                                           Hits      Data sets  Members
*
<---+---10---+---2---+---3---+---4---+> <---+---> <---+---> <---+--->
SET_ERROR_MSG                                4          1          2
SETMSG                                         157        3          46
**** End of data ****

```

4. Position the cursor to `SETMSG` data sets and press **Enter** to list the data sets that contain the word `SETMSG`.

```

File  Edit  Edit_Settings  Menu  Utilities  Compilers  Test  Help
-----
VIEW      SYS22214.T172727.RA000.TYRONED.R0200234      Columns 00001 00072
Command ==>                                           Scroll ==> CSR
***** ***** Top of Data *****
000001 FMN.DEM001.EXEC
000002 FMN.EXEC
000003 FMN.PANELS
***** ***** Bottom of Data *****

```

5. Press the **F3** function key and the position the cursor to a number in the **Member** column. In this example, the cursor is positioned to `46`.

```

Process  Options  Help
-----
Index DEM01      EXECs, Panels, Messages, and Skeletons  Row 00001 of 00002
Command ==>                                           Scroll CSR

Search:  SET*SG
Word                                           Hits      Data sets  Members
*
<---+---10---+---2---+---3---+---4---+> <---+---> <---+---> <---+--->
SET_ERROR_MSG                                4          1          2
SETMSG                                         157        3          46
**** End of data ****

```

6. Press **Enter** to display an Indexed Search Report restricted to data set names and member names.

```

File  Edit  Edit_Settings  Menu  Utilities  Compilers  Test  Help
-----
VIEW      Indexed Search Report      Index DEM01      Col 00001 00072
Command ==>                                           Scroll ==> CSR
***** ***** Top of Data *****
000001 -----
000002 >Data Set: FMN.DEM001.EXEC
000003 >Member : APCTRTC
000004 >Member : APCT2AZB
000005 >Member : APCT2AZ0
000006 >Member : APCT2AZP
000007 >Member : BCK2AZ
000008 >Member : BPCT2AZ
000009 >Member : CAPART5
000010 >Member : CAPART6
000011 >Member : CNEXT
000012 >Member : CRUZP
000013 >Member : CRZT
000014 >Member : DUPCHK

```

7. Press **Enter** against any member to navigate to the first line containing an occurrence of the "`SETMSG`" word in that member.

```

File Edit Edit_Settings Menu Utilities Compilers Test Help
VIEW FMN.DEMO01.EXEC(APCTRTC) Columns 00001 00072
Command ==> Scroll ==> CSR
000351 'TBEND STATTAB'
000352 end
000353 else do;
000354 address ISPEXEC
000355 'SETMSG MSG(APCT017I)' /* no information available */
000356 end;
000357 return
000358 /* ----- */
000359 /* Issue a DBUTIL report to get various statistics */
000360 /* ----- */
000361 get_report:
000362 SCLMqual = ""||userid()||'.LOCK.SCAN'
000363 Sclmrept = sclmqual||'.REPT'||''
000364 Sclmarch = sclmqual||'.ARCH'||''
000365 Sclmmsg = sclmqual||'.MSGS'||''
000366
000367 /* get rid of the old ones */
000368 address TSO
000369 if sysdsn(SCLMrept) = 'OK' then
000370 'DELETE' sclmrept
    
```

8. Press the **F3** function key twice and press **Enter** at either the **Word** or **Hits** column to navigate to the full Indexed Search Report.

```

Process Options Help
Index DEMO1 EXECs, Panels, Messages, and Skeletons Row 00001 of 00002
Command ==> Scroll CSR
Search: SET*SG
Word Hits Data sets Members
*
<-----10-----2-----3-----4-----> <-----> <----->
SET_ERROR_MSG 4 1 2
SETMSG 157 3 46
**** End of data ****
    
```

9. Press **Enter** to display list of occurrences.

```

File Edit Edit_Settings Menu Utilities Compilers Test Help
VIEW Indexed Search Report Index DEMO1 Col 00001 00072
Command ==> Scroll ==> CSR
***** Top of Data *****
000001 -----
000002 >Data Set: FMN.DEMO01.EXEC
000003 >Member : APCTRTC
000004 355 'SETMSG MSG(APCT017I)' /* no information available */
000005 420 Address ISPEXEC 'SETMSG MSG(APCT017I)'
000006 509 'SETMSG MSG('MSGB')'
000007 515 'SETMSG MSG('MSGB')'
000008 637 'SETMSG MSG(APCT004F)' /* already allocated */
000009 642 'SETMSG MSG(APCT004C)'
000010 990 'SETMSG MSG(APCT001L)'
000011 1237 'SETMSG MSG(APCT001L)'
000012 2137 Address ISPEXEC "SETMSG MSG(FMNBE002)";
000013 2715 address ispexec 'SETMSG MSG(APCT009I)'
000014 3476 address ISPEXEC 'SETMSG MSG(APCT022I)' /* copy failed
000015 3482 address ISPEXEC 'SETMSG MSG(APCT021I)'
000016 >Member : APCT2AZB
000017 278 'SETMSG MSG(APCT017I)' /* no information available */
000018 343 Address ISPEXEC 'SETMSG MSG(APCT017I)'
000019 428 'SETMSG MSG('MSGB')'
    
```

10. Position the cursor to line 9 in the data area and press **Enter** to navigate to line 642 of the member.

```

File Edit Edit_Settings Menu Utilities Compilers Test Help
VIEW          FMN.DEMO01.EXEC(APCTRTC)          Columns 00001 00072
Command ==>          Scroll ==> CSR
000642  'SETMSG MSG(APCT004C)'
000643  exit
000644  end
000645
000646
000647  call Use_Qbaselib
000648  return
000649  /*****
000650  /* Allocate the data sets from the user upwards */
000651  /*****
000652  Use_Qbaselib:
000653  Address ISPEXEC
000654  'QBASELIB 'XLIBS' ID('liblist)
000655
000656  liblist = translate(liblist,' ','')
000657
000658  do i = 1 to words(liblist)
000659  libname = word(liblist,i)
000660  parse var libname . '.' grp.i '.' .
000661  end

```

11. Position the cursor to on the word "APCT004C" and press **Enter** to produce a nested indexed search report.

```

File Edit Edit_Settings Menu Utilities Compilers Test Help
VIEW          Indexed Search Report          Index DEMO1          Col 00001 00072
Command ==>          Scroll ==> CSR
***** ***** Top of Data *****
000001  -----
000002  >Data Set: FMN.DEMO01.MSGS
000003  >Member : APCT00
000004  241  APCT004C 'Release mismatch' .ALARM=YES .WINDOW=NORESP
000005  -----
000006  >Data Set: FMN.DEMO01.EXEC
000007  >Member : APCTRTC
000008  642  'SETMSG MSG(APCT004C)'
000009  >Member : APCT2AZB
000010  561  'SETMSG MSG(APCT004C)'
000011  >Member : APCT2AZO
000012  565  'SETMSG MSG(APCT004C)'
000013  >Member : APCT2AZP
000014  523  'SETMSG MSG(APCT004C)'
000015  >Member : BCK2AZ
000016  647  'SETMSG MSG(APCT004C)'
000017  >Member : BPCT2AZ
000018  566  'SETMSG MSG(APCT004C)'
000019  >Member : FMPROM

```

PDSE Workbench

Use PDSE Workbench to manage members of all PDS and PDSE data sets, including member generations.

Version 2 PDSE data sets support multiple levels, or generations, of members. For a PDSE to support member generations it must be created with these attributes:

- Data set type of LIBRARY.
- Data set version of 2.
- Number of generations (MAXGENS) greater than zero.

For example, in JCL, this would be:

```
//PDSEV2 DD DSN=USER.PDSE2.FB80,DISP=(NEW,CATLG),
//        DSNTYPE=(LIBRARY,2),MAXGENS=20,
```

```
//      RECFM=FB,LRECL=80,BLKSIZE=0,
//      UNIT=SYSALLDA,SPACE=(CYL,(10,10,1))
```



Note: A version 2 PDSE that is created with MAXGENS=0 will have the performance improvements of version 2 PDSE, but will not support member generations.

Terminology

Member generation

An earlier saved copy of a member.

Current member

The primary version of a member. By definition, the absolute and relative generation numbers for the current member are always zero.

Absolute generation number

The absolute generation number is a positive number, or 0 for the current member. The first generation created has an absolute generation of 1. The number increases as each new generation is created, even as older generations are removed:

GEN(n), GEN($n-1$), GEN($n-2$), ...



Note: The absolute generation number for a member never changes. When a member generation is deleted, the absolute generation number is never reused. Even when a current member and all of its generations are deleted, information about the last absolute generation number is retained in the PDSE structure. If the member is recreated, member generations will continue from the next absolute generation number.

Relative generation number

The relative generation number is a negative number, or 0 for the current member. The most recent generation created will have a relative generation of -1, then -2, and so on. The relative generation numbers of a generation change as each new generation is created, or a member generation is deleted or recovered:

GEN(-1), GEN(-2), ..., GEN(- n)

Generations

Generations can be referenced by either their absolute or relative generation number. Generations are only kept for primary members, not aliases. Alias information is retained with the generations.

Generation limit

The maximum number of generations to be retained for a member. The limit is set by the MAXGENS parameter when the version 2 PDSE is created and can be further constrained by system limit defined by MAXGENS_LIMIT in the IGDSMSxx parmlib member.



Note: The MAXGENS_LIMIT is a value in the range 0 to 2000000000 with a default value of 0 if not specified. This means, by default, member generations are not supported until the system programmer defines a value greater than zero for MAXGENS_LIMIT in the IGDSMSxx parmlib member.

Invoking PDSE Workbench

You can invoke the PDSE Workbench using any of the following methods.

- Invoking an ISPF command defined in the ISPF Command Table. See “Setting up your ISPF commands to invoke PDSE Workbench” in the *File Manager Customization Guide*.
- Invoking a REXX exec. See “Setting up a REXX exec to invoke PDSE Workbench” in the *File Manager Customization Guide*.
- Option 3.15 from the File Manager main menu.
- When editing or viewing a member in a version 2 PDSE, press the enhanced search function key (FMNELIBD KEY or FMNSRCHK) with any abbreviation of History in the command line to invoke the workbench for the current data set.
- When editing or viewing a member from an enhanced search report, enter H, HIST, or HISTORY on the command line to invoke the workbench for the current data set.
- When editing a member such as a JCL or reference list member and the cursor is on the name of a version 2 PDSE, pressing the enhanced search function key displays a menu. Select option 12 to invoke the workbench for that data set.



Note: You can use a function key to bypass the menu. Specify either FMNELIBD KEY 12 or FMNSRCHK 12 depending on which method you use to invoke the enhanced search feature.

- When a File Manager member list is displayed the workbench is invoked if any abbreviation of HISTORY is entered as a primary command.

Using PDSE Workbench

If the workbench is invoked through option 3.15 or an ISPF command without a data set name being provided, the PDSE Workbench Entry Panel is displayed.

Figure 168. PDSE Workbench Entry Panel

<u>P</u> rocess	<u>O</u> ptions	<u>H</u> elp
File Manager		PDSE Workbench Entry Panel
Data set name	. 'FMN.PH11137.PDSEV2F'	
Member *	Generation limit

If the data set name was provided or if Enter is pressed on the Entry panel shown in [Figure 168: PDSE Workbench Entry Panel on page 639](#), the PDSE Workbench Member List panel is displayed.

Figure 169. PDSE Workbench Member List panel

Process Options Help									
File Manager					PDSE Workbench Member List				
Data set name . 'FMN.PH11137.PDSEV2F'									
Member *					Generation limit _____				
Compare option <u>1</u> 1. ISPF 2. SuperC 3. File Manager									
Name	Prompt	Rel	Gen	Size	Created	Changed	ID		
*	*				*	*	*		
----- MEM1		0	0	2	2019/02/15	2019/02/15 09:43:05	HGRAMPA		
----- MEM1		-1	3	3	2019/02/15	2019/02/15 09:24:38	HGRAMPA		
----- MEM1		-2	2	2	2019/02/15	2019/02/15 09:22:09	HGRAMPA		
----- MEM1		-3	1	1	2019/02/15	2019/02/15 09:21:13	HGRAMPA		
----- MEM2TST		0	0	2	2019/02/15	2019/02/15 09:26:09	HGRAMPA		
----- MEM3TEST		0	0	1	2019/02/15	2019/02/15 09:27:49	HGRAMPA		
----- MEM3TEST		-1	2	1	2019/02/15	2019/02/15 09:27:49	HGRAMPA		
----- MEM3TEST		-2	1	1	2019/02/15	2019/02/15 09:27:49	HGRAMPA		
----- MEM4		-1	5	1	2019/02/15	2019/02/15 09:31:30	HGRAMPA		
----- MEM4		-2	4						

Customizing and sorting columns in the member list

The Member List panel displays a selection list of customizable columns. You can:

- Select and order columns.
- Change column widths.
- Change the sort order for column values.
- Provide filters for each column.
- Scroll right (F11) and left (F10) if the screen width doesn't accommodate all the columns.

You can customize all columns by using the TAILOR primary command. You can customize displayed columns by positioning the cursor on the filter value and pressing Enter.

You can change the sort order of the column values using the following methods:

- Position the cursor on the header for the field and press Enter. This sorts the list using the default sort order for that field.
- If the sort order indicator is displayed in the rightmost position of the header for the field, position the cursor on the sort order indicator and press Enter. This will sort the list using the next sort order sequence for that field (either Ascending, Descending, None).
- Issue the SORT command.
- Issue the TAILOR command and change the SORT sequence for any number of fields.

Highlighting of member names

Where generation information is displayed:

- Current members (generation 0) are highlighted in white.
- Member generations are blue.
- Orphaned member generations (without a generation 0) are red.

Where alias information is displayed:

- Primary members are highlighted in white.
- Aliases are blue.

Member list field descriptions

Use the input fields to specify the list of members and generations in PDSE Workbench.

For details of the columns displayed in the member list, see [Column descriptions on page 963](#)

Data set name

Specify a fully qualified or generic data set name of either a PDS or PDSE.

- Specify a generic data set name to select a data set from the data set selection list for processing by the PDSE Workbench.
- Leave the data set name blank to select from the history of up to 50 previous data sets used by the PDSE Workbench.

Member name

Specify a member name or member name pattern to display in the member list. Leave blank to display all members.

Generation limit

Defines the maximum number of member generations to be displayed for each member. Specify a value in the range 0 to 2000000000 or leave the field blank to indicate no limit. This field is ignored for data sets that do not support member generations.

Compare option

Enter one of the following values to set a prefix command (CC, CN, CP, or CS) to be used with the compare utility.

1. ISPF Edit compare, using the ISPF VIEW service. This is the default option.
2. SuperC compare.
3. File Manager Compare function (DSM).



Notes:



1. For the ISPF and SuperC compare utilities, selected member generations are copied to a temporary data set to perform the comparison.
2. To compare unformatted records such as program objects, where the compare option specifies ISPF Edit compare, the DSM function (Data Set Compare) will be used.

Primary commands

PDSE Workbench supports the following primary commands for working with member lists.

DELETE

The DELETE command allows for the deletion of multiple members within a PDS or PDSE, depending on the keyword specified.

For the standard member list primary commands, see “*Available commands*” in [Member Selection panel on page 946](#).

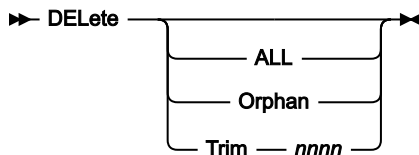

ALL

Delete all members that match the member name filter, and any related aliases. Aliases are not deleted unless the primary member name also matches the member name filter.

Orphan

Delete all orphaned members that match the member name filter. Orphan members are member generations without a current member. A current member is generation 0.

Trim

Retain up to the number of generations specified by *nnnn*. All other member generations that match the member name filter are deleted. This also applies to orphaned member generations and member generations that are not displayed because they exceed the generation limit.

nnnn must be in the range 0 to 2000000000.

Enter the DELETE command without any keywords to select the required DELETE option from a pop-up panel.

HIDE

The HIDE primary command toggles the display of the input fields on the PDSE Workbench. Hiding the input fields maximizes the size of the member list. When the input fields are hidden, enter HIDE to show them again.

►► Hide ◄◄

Prefix commands

PDSE Workbench supports the following prefix commands for working with member lists.

Alias

Display alias information for the selected member or current member.



Note: The Alias command is only available for PDSEs. It is not valid for member generations.

Browse

Browse the member, current member, or member generation using the ISPF Browse service.

Copy

For PDS, PDSE, and current members:

- Copy the member and any related aliases.

For member generations:

- Copy the member generation and save as a current member.



Note: COPY is not supported for member generation load modules, or program objects.

CC

Compare the selected member generation to the current member.



Note: The CC command is only available for PDSEs that are defined to support member generations.

CN

Compare the selected current member or member generation to the next generation of the same member in the member list.



Note: The CN command is only available for PDSEs that are defined to support member generations.

CP

Compare the selected member generation to the previous generation or the current generation of the same member in the member list.



Note: The CP command is only available for PDSEs that are defined to support member generations.

CS

Compare the selected member, current member, or member generation to another member, current member or member generation of the same data set. A Compare Selection List panel is displayed to allow the member or member generation to be selected.

Delete

For current members, perform one of the following actions:

- Delete the current member, related aliases, and all member generations.
- Delete the current member and any related aliases, then recover the most recent generation to become the current member.

For member generations:

- Delete the member generation.



Note: Deleting a member generation does not alter the absolute generation number of other member generations. Absolute generation numbers are never reused, even if a current member and all of its generations are deleted.

For all other data sets:

- Delete the member and any related aliases.

Edit

Edit the member or current member using the ISPF Edit service.



Note: For data sets with member generations, only the current member (generation 0) can be edited. Browse will be substituted for load modules. View will be substituted for member generations.

G

Synonym for the RESET prefix command.

Jcl

Generate the link-edit JCL for the load module.



Note: The JCL prefix command is only available for loadlib data sets. It is not valid for generation members.

Move

For PDS, PDSE, and current members:

- Move the member and any related aliases.

For member generations:

- Move the member generation and save it as the current member.



Note: MOVE is not supported for member generation load modules, or program objects.

Print

Invoke the File Manager PRINT utility to print the member. The Print line command is only supported for the current member (generation 0).

Rename

For current members:

- Rename the current member and all member generations.

For member generations:

- Rename is not supported.

For all other data sets:

- Rename the member.

RESet

Invoke the File Manager Reset ISPF statistics function to reset or delete the ISPF statistics for the member or current member.



Note: The Reset command is only available for data sets with formatted records. It is not valid for member generations.

RG

Recover the selected member generation so that it becomes the current member. The previous current member becomes relative generation -1.

Select or /

Select a member. The result depends on the data set and member:

- For a load library, Select will browse the member.
- For a generation member, Select will view the generation member.
- Otherwise, Select will edit the member.

SUbmIt

Submit the member to the JES internal reader.



Note: The SUBMIT prefix command is only available for data sets with formatted records. It is not valid for generation members.

View

View the member, current member, or member generation using the ISPF View service. Browse will be substituted for load modules.

VLM

Invoke the File Manager View Load Module utility to display information about the load module.



Note: The VLM command is only available for data sets with unformatted records (load modules or program objects). It is not valid for member generations.

Chapter 17. File Manager Service Provider for z/OS® Connect Enterprise Edition

File Manager Service Provider for IBM® z/OS® Connect Enterprise Edition enables client applications to access IBM® Z data sources using z/OS® Connect.

Using z/OS® Connect tooling, customers can create their own RESTful APIs and access IBM® Z data sources through the service provider. Clients can read data sequentially, by relative record position, or by key.

The supported data sources include:

- MVS™ data sets (including VSAM)
- UNIX System Services files
- CICS® files (including VSAM and CICS® TS and CICS® TD queues)
- Websphere MQ queues
- Db2®
- IMS™

Installation and customization of the service provider is described in the *File Manager Customization Guide*.

Methods for accessing IBM Z data sources

File Manager Service Provider supports two methods for accessing data: *generic* and *specific*.

The *generic* method involves using service archives (SAR files) provided by File Manager. This method provides a *generic* mapping of file data to a prescribed response format, that is, one format for all data sources. For example:

```
"records" :
[
  {
    "fields" :
    [
      {
        "field" : "CUSTOMER-NO",
        "value" : 7688
      },
      {
        "field" : "CUSTOMER-NAME",
        "value" : "MR JOHN DOE"
      }, ...
    ]
  }, ...
]
```

When using *generic* mappings, customers do not need to create SAR files.

Alternatively, customers who require a response mapping *specific* to a data resource can create their own SAR files using the provided File Manager Build Toolkit plug-in. APIs created using SAR files that are built by the Build Toolkit plug-in map data responses according to a given File Manager template or copybook. For example:

```
"records" :
[
  {
    "CUSTOMER-NO" : 7688,
    "CUSTOMER-NAME" : "MR JOHN DOE",
    ...
  }, ...
]
```

When using *specific* mappings, customers must create and manage their own SAR files using the File Manager z/OS Connect Build Toolkit plug-in.

Single reads versus multiple reads

Regardless of which method for accessing data is used (generic or specific), the File Manager Service Provider starts a File Manager "view" session to read records from a given data resource.

Starting a File Manager view session incurs a performance overhead. Consequently, the File Manager Service Provider supports the reuse of a session when multiple reads from a data resource are required by the API caller. This feature is unnecessary when a single read is required.

When executing an initial API call to read data, the API caller can indicate in the request payload that a session is required for subsequent reads. In this case, the service provider starts a view session and returns the requested records and a token that can be used on subsequent API calls. Instead of terminating the session after the initial API call, the service provider maintains the view session until either the API caller indicates that it is no longer needed or it times out through inactivity.



Tip: To reduce the performance overhead of starting a File Manager view session, use this feature in API calls when performing multiple rather than one-off reads from a data resource.

Requests and responses

The File Manager Service Provider expects JSON payloads from z/OS® Connect-defined APIs representing requests, and passes back JSON payloads as responses to these requests.

The content of requests differs depending on which access method is used and whether the target resource is a File Manager Base componentz/OS® file or an IMS™ or Db2® database.

All File Manager Service Provider requests require an HTTP Content-Type header in the following form:

```
Content-Type: application/json
```

All File Manager Service Provider initial requests to read a data resource (that is, requests that do not pass a token) require an HTTP Basic Authorization header in the following form:

```
Authorization : Basic credentials_string
```

where *credentials_string* represents a Base64 encoding of *userid:password*. For example:

```
Authorization : Basic dXNlcmlkOnBhc3N3b3Jk
```

Generic method requests for z/OS® files

The File Manager Service Provider accepts the following JSON for generic method requests to access z/OS® files.

```
{
  "resource" :
  {
    "resourceName" : "string",
    "volser" : "string",
    "dataCcsid" : number,
    "dbcsCcsid" : number,
  },
  "template" :
  {
    "templateName" : "string",
    "tplCcsid" : number,
    "copybookName" : "string",
    "language" : "string",
    "options" : "string"
  },
  "operation" :
  {
    "numRecords" : integer,
    "session" : boolean,
    "token" : "string"
    "timeout" : number
  },
  "position" :
  {
    "record" : integer,
    "key" : "string"
  }
}
```

Key fields for generic method requests are explained in the following table:

Key	Description
resource	Parameters associated with the data resource. Resource parameters are only required when performing a single or initial read from a data resource. Resource parameters are not required on subsequent read requests when a token is passed.
resourceName	Name of the data resource. Examples: MVS.DATASET, /uss/data.dat, FI:APPLID:CICSFILE, TD:APPLID:CICSTDQ, TS:APPLID:CICSTSQ, MQ:QMGR:QNAME where <i>APPLID</i> represents the application ID of the target CICS region, and <i>QMGR</i> represents the MQ system.
volser	Data resource volume serial, if applicable.
dataCcsid	CCSID of resource alphanumeric data. Default is 037.
dbcsCcsid	CCSID of graphic or double-byte data. Default is 930. This could be the same as dataCcsid and is needed to support GRAPHIC and DBCS fields.

Key	Description
template	Template parameters map the data resource and can be a File Manager template or a copybook. Template parameters are only required when performing a single or initial read from a data resource. Template parameters are not required on subsequent read requests when a token is passed.
templateName	Name of a File Manager template that maps the data resource. Example: MVS.DATASET(TEMPLATE).
tmplCcsid	CCSID of template or copybook. Default is 037.
copybookName	Name of a copybook that maps the data resource. A copybook can be used to map a data resource instead of a File Manager template.
language	Language of the copybook. Can be COBOL, PLI, HLASM, or AUTO. AUTO can be used when the copybook language is either COBOL or PLI.
options	<p>Compilation options for the copybook. To map data using a copybook, File Manager compiles the copybook to determine field offsets. In some cases, special compiler options are required to accurately determine these offsets. The options parameter can be used for this purpose. The following options are supported:</p> <ul style="list-style-type: none"> • COBOL: <ul style="list-style-type: none"> DBCS=,CDPC=,CAE=,MIXED=,CBLMAXRC=,RFROMn=,RTO= • PLI: <ul style="list-style-type: none"> BIN63=,DEC31=,GRAPHIC=,UNALIGNED=,PLIMAXRC=,PLILIBS= • HLASM: <ul style="list-style-type: none"> DBCS=,NOALIGN=,ASMMAXRC=,ASMLIBS= <p>For full details of the supported options refer to File Manager functions on page 1245.</p> <p>Multiple options can be comma separated. The options parameter is ignored if the language parameter is not specified.</p>
operation	Operation parameters affect the behavior of the service provider. All operation parameters are optional, but for performance reasons it is helpful to understand the correct use of the session and token parameters.
numRecords	The number of records to retrieve. The acceptable range is 0 - 10000. The default is 1.
session	Indicates whether to persist or end a File Manager session. A value of <i>true</i> instructs the service provider to start the session (if it is not already started) and keep it active for subsequent API calls. A value of <i>false</i> instructs the service provider to end the session when the API call is complete.

Key	Description
token	A session token, as returned in a previous API response. The token represents an active File Manager session and can be used for subsequent reads following an initial read that sets <code>"session" : true</code> . A successful initial read request with <code>"session" : true</code> returns a token in the response.
timeout	Time in seconds for which the File Manager view session can be inactive before it is terminated. Can be any value from 0 to 28800 (eight hours). The default is 300 (5 minutes). If the value is greater than the <code>max_timeout</code> in the <code>server.xml</code> configuration, the <code>timeout</code> value is ignored and the <code>max_timeout</code> value is used instead.
position	Position parameters affect the read position of the data resource. Can be a relative record position or a key position (if KSDS).
record	Relative record read position. If requested, the service provider will position to the nominated relative record position before reading records. The default is 1 for an initial read, or the current record position for a subsequent read. A read is considered a subsequent read if a valid token is passed.
key	Record key read position for KSDS. If requested, the service provider will position to the nominated key position or the next higher key position before reading records. The default is the first record for an initial read, or the current record position for a subsequent read. A read is considered a subsequent read if a valid token is passed. The key value can be expressed as a string, for example: <code>"ABC"</code> , <code>"C'ABC DEF'"</code> , <code>"X'C1F7'"</code> . The <code>C'string'</code> format must be used if the key value contains spaces or lowercase characters. The <code>key</code> and <code>record</code> parameters are mutually exclusive.

Generic method requests for IMS™

The File Manager Service Provider accepts the following JSON for generic method requests for access to IMS™ data.

```
{
  "resource" :
  {
    "ssid" : "string",
    "database" : "string",
    "psbMember" : "string",
    "pcbNumber" : "string",
    "pcbName" : "string",
    "regionType" : "string",
    "dataCcsid" : integer,
    "dbcsCcsid" : integer
  },
  "view" :
  {
    "viewName" : "string",
    "viewCcsid" : integer
  }
}
```

```

    },
    "operation" :
    {
        "numSegments" : integer,
        "session" : Boolean,
        "token" : "string",
        "timeout" : integer
    },
    "position" :
    {
        "segmentKeys" :
        [
            {
                "segmentName" : "string",
                "keyValue" : "string",
                "operator" : "string"
            }
        ]
    }
}

```

Key fields for generic method requests are explained in the following table.



Note: Parameters flagged as (Required) are only required for an initial request.

Key	Description
resource	(Required) Parameters associated with the IMS™ data resource. Resource parameters are only required when performing a single or initial read from a data resource. Resource parameters are not required on subsequent read requests when a token is passed.
ssid	(Required) The IMS™ subsystem identifier.
database	(Required) The name of the IMS™ database.
psbMember	The IMS™ Program Specification Block (PSB) member name. This is a member in the File Manager PSB data set concatenation. If psbMember is not specified File Manager will attempt to generate a dynamic PSB (if this is permitted).
pcbNumber	The Program Communication Block (PCB) number. This is the relative position of the PCB within the PSB member and must be numeric. The relevant PCB can be identified using pcbNumber or pcbName. The default is 1.
pcbName	Program Communication Block (PCB) name. This is the PCB label name within the PSB member. The relevant PCB can be identified using pcbNumber or pcbName.
regionType	(Required) The IMS™ region type. Must be "BMP" or "DLI".
dataCcsid	CCSID of resource alphanumeric data. Default is 037.
dbcsCcsid	CCSID of graphic or double-byte data. Default is 930. This could be the same as dataCcsid and is needed to support GRAPHIC and DBCS fields.

Key	Description
view	(Required) View parameters map the IMS™ database segments. View parameters are required when performing a single or initial read from an IMS resource. View parameters are not required on subsequent read requests when a token is passed.
viewName	(Required) Name of a File Manager/IMS view. Example: MVS.DATASET(MYVIEW).
viewCcsid	CCSID of the view. Default is 037.
operation	Operation parameters affect the behavior of the service provider. All operation parameters are optional, but for performance reasons it is helpful to understand the correct use of the session and token parameters.
numSegments	The number of database segments to retrieve. The acceptable range is 0 - 10000. The default is 1.
session	Indicates whether to persist or end a File Manager/IMS session. A value of <i>true</i> instructs the service provider to start the session (if it is not already started) and keep it active for subsequent API calls. A value of <i>false</i> instructs the service provider to end the session when the API call is complete.
token	A session token, as returned in a previous API response. The token represents an active FM/IMS session and can be used for subsequent reads following an initial read that sets <code>"session" : true</code> . A successful initial read request with <code>"session" : true</code> returns a token in the response.
timeout	Time in seconds for which the FM/IMS view session can be inactive before it is terminated. Can be any value from 0 to 28800 (eight hours). The default is 300 (5 minutes). If the value is greater than the <code>max_timeout</code> in the <code>server.xml</code> configuration, the <code>timeout</code> value is ignored and the <code>max_timeout</code> value is used instead.
position	Position parameters affect the read position within the IMS™ database. Positioning requires knowledge of the name of and hierarchical path to the relevant database segments and the length of the segment keys. Positioning occurs before the read request is satisfied.
segmentKeys	An array of database segment names and associated key values. Specify array elements in database hierarchical order. Note that the last segment listed in the array will be the segment that is positioned on.
segmentName	The name of the database segment to position on or after.
keyValue	The required value for the segment's key to position on or after.
operator	Logical operator for positioning based on segment/key value elements in the <code>segmentKeys</code> array. The operator can be EQ (equal) or GE (greater than or equal). The default is EQ. The operator parameter only takes effect when it is specified on the last element of the <code>segmentKeys</code> array (that is, the segment that is being positioned on) but applies to all segment/key value assignments that are specified in the array.

Key	Description
	<ul style="list-style-type: none"> • If EQ is specified, all segment/key value elements in the array are checked for equality when positioning. • If GE is specified and the database root segments are key sequenced, the test <i>"if greater than or equal to"</i> is applied to all segment/key value elements in the array when positioning. • If GE is specified and the database root segments are not key sequenced, the root segment is checked for equality and the test <i>"if greater than or equal to"</i> is applied to all other segment/key value elements in the array when positioning.

Generic method requests for Db2®

The File Manager Service Provider accepts the following JSON for generic method requests for access to Db2® data.

```
{
  "resource" :
  {
    "ssid" : "string",
    "owner" : "string",
    "tableName" : "string",
    "dataCcsid" : integer,
    "dbcsCcsid" : integer
  },
  "template" :
  {
    "templateName" : "string",
    "tplCcsid" : integer
  },
  "operation" :
  {
    "numRows" : integer,
    "session" : Boolean,
    "token" : "string",
    "timeout" : integer,
    "where" : "string",
    "maxRows" : integer
  },
  "position" :
  {
    "row" : integer
  }
}
```

Key fields for generic method requests are explained in the following table.



Note: Parameters flagged as (Required) are only required for an initial request.

Key	Description
resource	(Required) Parameters associated with the Db2® data resource. Resource parameters are only required when performing a single or initial read from a data resource. Resource parameters are not required on subsequent read requests when a token is passed.
ssid	(Required) The Db2® subsystem identifier.
owner	(Required) The name of the Db2® table owner.
tableName	(Required) The name of the Db2® table.
dataCcsid	CCSID of resource alphanumeric data. Default is 037.
dbcsCcsid	CCSID of graphic or double-byte data. Default is 930. This could be the same as dataCcsid and is needed to support GRAPHIC and DBCS fields.
template	Template parameters map the Db2® database rows. Template parameters are only required when performing a single or initial read from a Db2® resource. Template parameters are not required on subsequent read requests when a token is passed.
templateName	Name of a File Manager/Db2 template. Example: MVS.DATASET(MYTMPL).
tmplCcsid	CCSID of the template. Default is 037.
operation	Operation parameters affect the behavior of the service provider. All operation parameters are optional, but for performance reasons it is helpful to understand the correct use of the session and token parameters.
numRows	The number of table rows to retrieve. The acceptable range is 0 - 10000. The default is 1.
session	Indicates whether to persist or end a File Manager/Db2 session. A value of <i>true</i> instructs the service provider to start the session (if it is not already started) and keep it active for subsequent API calls. A value of <i>false</i> instructs the service provider to end the session when the API call is complete.
token	A session token, as returned in a previous API response. The token represents an active FM/Db2 session and can be used for subsequent reads following an initial read that sets <code>"session" : true</code> . A successful initial read request with <code>"session" : true</code> returns a token in the response.
timeout	Time in seconds for which the FM/Db2 view session can be inactive before it is terminated. Can be any value from 0 to 28800 (eight hours). The default is 300 (5 minutes). If the value is greater than the <code>max_timeout</code> in the <code>server.xml</code> configuration, the timeout value is ignored and the <code>max_timeout</code> value is used instead.

Key	Description
where	A valid Db2® WHERE clause that applies to the Db2® data resource on the initial API request when the Db2® session is started. The where clause can affect the result table for the session. This parameter is only valid on an initial API request, and is mutually exclusive with token.
maxRows	<p>The maximum number of rows in the result table for the Db2® session. A value of 0 requests all rows without a maximum.</p> <p> Note: Reading all rows in a large table or expected result table may take a long time.</p> <p>maxRows is mutually exclusive with token. The default is 10000.</p>
position	Position parameters affect the read position within the Db2® data resource. If requested, the service provider will position to the nominated row in the result table before reading the next rows. The default is 1 for an initial read, or the current row position for a subsequent read. A read is considered a subsequent read if a valid token is passed.
row	A relative row position within the result table. For an initial request, this can be the starting row for the result set.

Generic method responses for z/OS® files

A successful response generates an HTTP status code of 200. Failures produce an appropriate status code and an error message describing the cause of the failure.

File Manager Service Provider generates the following JSON format in response to successful generic method requests to access z/OS files:

```
{
  "records" :
  [
    {
      "last" : boolean,
      "layouts" :
      [
        {
          "layout" : "string",
          "fields" :
          [
            {
              "field" : "string",
              "type" : "string",
              "dimension" : integer,
              "value" : "string-number-array-or-null",
              "error" : "string"
            }
          ]
        }
      ]
    }
  ]
}
```

```
"token" : "string"
}
```

Key fields for a generic method response are explained in the following table:

Key	Description
records	An array of 0 or more record objects.
last	Indicates whether the record is the last in the data source. This key is only present if the value is true.
layouts	An array of 1 or more File Manager layouts associated with the record.
layout	The name of the record layout as in the File Manager template or copybook.
fields	An array of 1 or more data fields within the layout.
field	The name of the data field. If no template or copybook was specified when connecting to the data source, the name DATA is used.
type	The File Manager data type of the field. For a list of data types, see Dynamic Template panel on page 845 .
dimension	If the field is an array, the dimension of the array. For example, a value of 2 represents a two-dimensional array. This key is only present if the data field is an array.
value	The value of the data field. Can be a string, a number, an array, or null. A null value means the value could not be determined and an error key-value pair is generated.
error	Short error text explaining why the field value is null. For example: <ul style="list-style-type: none"> • The field is mapped past the end of the record. • The field is truncated. • The field does not contain data in a format that matches the data type.
token	A File Manager session token. A token is returned when a request sets <code>"session" : true</code> and does not also pass a token value. The token represents a File Manager session running in the z/OS® environment and can be used by subsequent requests when multiple reads by a client are required. To end the File Manager session, the client must send a request with the token and <code>"session" : false</code> , otherwise the session will eventually time out if inactive.

Generic method responses for IMS™

A successful response generates an HTTP status code of 200. Failures produce an appropriate status code and an error message describing the cause of the failure.

File Manager Service Provider generates the following JSON format in response to a successful generic method request for IMS™ data:

```
{
  "segments" :
  [
    {
      "last" : boolean,
      "layout" : "string",
      "segname" : "string",
      "fields" :
      [
        {
          "field" : "string",
          "type" : "string",
          "dimension" : integer,
          "value" : "string-number-array-or-null",
          "error" : "string"
        }
      ]
    }
  ] ,
  "token" : "string"
}
```

Key fields for a generic method response are explained in the following table:

Key	Description
segments	An array of 0 or more segments from the IMS™ data resource.
last	If present, is indicates that the segment is last in the IMS™ resource.
layout	The name of the segment layout that was used to map this segment.
segname	The name of the IMS™ database segment.
fields	Each segment is represented as an array of 1 or more fields.
field	The name of the layout field.
type	The File Manager data type of the field. For a list of data types, see Dynamic Template panel on page 845 .
dimension	If the field is an array, the dimension of the array. For example, a value of 2 represents a two-dimensional array.
value	The value of the data field. A null value means the value could not be determined.
error	Short error text explaining why the field value is null (that is, why the value could not be determined).
token	A File Manager session token. A token is returned when a request sets <code>"session" : true</code> and does not also pass a token value. The token represents a File Manager/IMS session running in the

Key	Description
	<p>z/OS® environment and can be used by subsequent requests when multiple accesses by a client are required.</p> <p>To end the FM/IMS session, the client must send a request with the token and <code>"session" : false</code>, otherwise the session will eventually time out if inactive.</p>

Generic method responses for Db2®

A successful response generates an HTTP status code of 200. Failures produce an appropriate status code and an error message describing the cause of the failure.

File Manager Service Provider generates the following JSON format in response to a successful generic method request for Db2® data:

```
{
  "rows" :
  [
    {
      "last" : boolean,
      "columns" :
      [
        {
          "column" : "string",
          "type" : "string",
          "dimension" : integer,
          "value" : "string-number-array-or-null",
          "error" : "string"
        }
      ]
    }
  ],
  "token" : "string"
}
```

Key fields for a generic method response are explained in the following table:

Key	Description
rows	An array of 0 or more rows from the Db2® data resource.
last	If present, is indicates that the row is last in the Db2® result table.
columns	Each row is represented as an array of 1 or more columns.
column	The name of the Db2® resource column.
type	The File Manager data type of the column. For a list of data types, see Dynamic Template panel on page 845 .
dimension	If the column is an array, the dimension of the array. For example, a value of 2 represents a two-dimensional array.

Key	Description
value	The column data value. A null value means the value could not be determined.
error	Short error text explaining why the column value is null (that is, why the value could not be determined).
token	<p>A File Manager session token. A token is returned when a request sets <code>"session" : true</code> and does not also pass a token value. The token represents a File Manager/Db2 session running in the z/OS® environment and can be used by subsequent requests when multiple accesses by a client are required.</p> <p>To end the FM/Db2 session, the client must send a request with the token and <code>"session" : false</code>, otherwise the session will eventually time out if inactive.</p>

Specific method requests for z/OS® files

The File Manager Service Provider accepts the following JSON for specific method requests for z/OS® files:

```
{
  "operation" :
  {
    "numRecords" : integer,
    "session" : boolean,
    "token" : "string"
  },
  "position" :
  {
    "record" : integer,
    "key" : "string"
  }
}
```

Key fields for specific method requests are explained in the following table:

Key	Description
operation	Operation parameters affect the behavior of the service provider. All operation parameters are optional, but for performance reasons it is helpful to understand the correct use of the session and token parameters.
numRecords	The number of records to retrieve. The acceptable range is 0 - 10000. The default is 1.
session	Indicates whether to persist or end a File Manager session. A value of <i>true</i> instructs the service provider to start the session (if it is not already started) and keep it active for subsequent API calls. A value of <i>false</i> instructs the service provider to end the session when the API call is complete.
token	A session token, as returned in a previous API response. The token represents an active File Manager session and can be used for subsequent reads following an initial read that sets

Key	Description
	"session" : true. A successful initial read request with "session" : true returns a token in the response.
position	Position parameters affect the read position of the data resource. Can be a relative record position or a key position (if KSDS).
record	Relative record read position. If requested, the service provider will position to the nominated relative record position before reading records. The default is 1 for an initial read, or the current record position for a subsequent read. A read is considered a subsequent read if a valid token is passed.
key	Record key read position for KSDS. If requested, the service provider will position to the nominated key position or the next higher key position before reading records. The default is the first record for an initial read, or the current record position for a subsequent read. A read is considered a subsequent read if a valid token is passed. The key value can be expressed as a string, for example: "ABC", "C'ABC DEF'", "X'ClF7' ". The <code>C'string'</code> format must be used if the key value contains spaces or lowercase characters. The <code>key</code> and <code>record</code> parameters are mutually exclusive.

All File Manager Service Provider initial requests to read a data resource (that is, requests that do not pass a token) require an HTTP Basic Authorization header in the following form:

```
Authorization : Basic credentials_string
```

where `credentials_string` represents a Base64 encoding of `userid:password`. For example:

```
Authorization : Basic dXNlcm1kOnBhc3N3b3Jk
```

Specific method requests for IMS™

The File Manager Service Provider accepts the following JSON for specific method requests for IMS™ data.

```
{
  "operation" :
  {
    "numSegments" : integer,
    "session" : Boolean,
    "token" : "string"
  },
  "position" :
  {
    "segmentKeys" :
    [
      {
        "segmentName" : "string",
        "keyValue" : "string",
        "operator" : "string"
      }
    ]
  }
}
```

```

}
}

```

Key fields for specific method requests are explained in the following table:

Key	Description
operation	Operation parameters affect the behavior of the service provider. All operation parameters are optional, but for performance reasons it is helpful to understand the correct use of the session and token parameters.
numSegments	The number of database segments to retrieve. The acceptable range is 0 - 10000. The default is 1.
session	Indicates whether to persist or end a File Manager/IMS session. A value of <i>true</i> instructs the service provider to start the session (if it is not already started) and keep it active for subsequent API calls. A value of <i>false</i> instructs the service provider to end the session when the API call is complete.
token	A session token, as returned in a previous API response. The token represents an active FM/IMS session and can be used for subsequent reads following an initial read that sets <code>"session" : true</code> . A successful initial read request with <code>"session" : true</code> returns a token in the response.
position	Position parameters affect the read position within the IMS™ database. Positioning requires knowledge of the name of and hierarchical path to the relevant database segments and the length of the segment keys. Positioning occurs before the read request is satisfied.
segmentKeys	An array of database segment names and associated key values. Specify array elements in database hierarchical order. Note that the last segment listed in the array will be the segment that is positioned on.
segmentName	The name of the database segment to position on or after.
keyValue	The required value for the segment's key to position on or after.
operator	<p>Logical operator for positioning based on segment/key value elements in the segmentKeys array. The operator can be EQ (equal) or GE (greater than or equal). The default is EQ.</p> <p>The operator parameter only takes effect when it is specified on the last element of the segmentKeys array (that is, the segment that is being positioned on) but applies to all segment/key value assignments that are specified in the array.</p> <ul style="list-style-type: none"> • If EQ is specified, all segment/key value elements in the array are checked for equality when positioning. • If GE is specified and the database root segments are key sequenced, all segment/key value elements in the array are checked <i>"if greater than or equal to"</i> when positioning. • If GE is specified and the database root segments are not key sequenced, the root segment is checked for equality and all other segment/key value elements in the array are checked <i>"if greater than or equal to"</i> when positioning.

Specific method requests for Db2®

The File Manager Service Provider accepts the following JSON for specific method requests for Db2®™ data:

```
{
  "operation" :
  {
    "numRows" : integer,
    "session" : Boolean,
    "token" : "string",
    "where" : "string",
    "maxRows" : integer
  },
  "position" :
  {
    "row" : integer
  }
}
```

Key fields for specific method requests are explained in the following table:

Key	Description
operation	Operation parameters affect the behavior of the service provider. All operation parameters are optional, but for performance reasons it is helpful to understand the correct use of the session and token parameters.
numRows	The number of table rows to retrieve. The acceptable range is 0 - 10000. The default is 1.
session	Indicates whether to persist or end a File Manager/Db2 session. A value of <i>true</i> instructs the service provider to start the session (if it is not already started) and keep it active for subsequent API calls. A value of <i>false</i> instructs the service provider to end the session when the API call is complete.
token	A session token, as returned in a previous API response. The token represents an active FM/Db2 session and can be used for subsequent reads following an initial read that sets <code>"session" : true</code> . A successful initial read request with <code>"session" : true</code> returns a token in the response.
where	A valid Db2® WHERE clause that applies to the Db2® data resource on the initial API request when the Db2® session is started. The where clause can affect the result table for the session. This parameter is only valid on an initial API request, and is mutually exclusive with token.
maxRows	The maximum number of rows in the result table for the Db2® session. A value of 0 requests all rows without a maximum.  Note: Reading all rows in a large table or expected result table may take a long time. maxRows is mutually exclusive with token. The default is 10000.

Key	Description
position	Position parameters affect the read position within the Db2® data resource. If requested, the service provider will position to the nominated row in the result table before reading the next rows. The default is 1 for an initial read, or the current row position for a subsequent read. A read is considered a subsequent read if a valid token is passed.
row	A relative row position within the result table. For an initial request, this can be the starting row for the result set.

Specific method responses for z/OS® files

A successful response generates an HTTP status code of 200. Failures produce an appropriate status code and an error message describing the cause of the failure.

File Manager Service Provider generates the following JSON format in response to a successful specific method request:

```
{
  "records" :
  [
    {
      "last" : boolean,
      "layouts" :
      {
        "layout-name" :
        {
          "field1-name" : "value",
          "field2-name" : "value",
          "field3-name" : "value",
          "fieldn-name" : "value"
        }
      }
    }
  ],
  "token" : "string"
}
```

Key fields for a *specific* method response are explained in the following table:

Key	Description
records	An array of 0 or more record objects.
last	Indicates whether the record is the last in the data source. This key is only present if the value is true.
layouts	An array of 1 or more File Manager layouts associated with the record.
<i>layout-name</i>	The key is the name of the record layout as in the File Manager template or copybook. The value is an object containing one or more fields related to the layout.
<i>field1-name</i> ... <i>fieldn-name</i>	The key is the name of the data field. The value is the value of the data field.

Key	Description
token	<p>A File Manager session token. A token is returned when a request sets <code>"session" : true</code> and does not also pass a token value. The token represents a File Manager session running in the z/OS® environment and can be used by subsequent requests when multiple reads by a client are required.</p> <p>To end the File Manager session, the client must send a request with the token and <code>"session" : false</code>, otherwise the session will eventually time out if inactive.</p>

Specific method responses for IMS™

A successful response generates an HTTP status code of 200. Failures produce an appropriate status code and an error message describing the cause of the failure.

File Manager Service Provider generates the following JSON format in response to a successful specific method request for IMS™ data:

```
{
  "segments" :
  [
    {
      "last" : boolean,
      "segment-name" :
      {
        "layout-name" :
        {
          "field1-name" : "value",
          "field2-name" : "value",
          "field3-name" : "value",
          "fieldn-name" : "value"
        }
      }
    }
  ],
  "token" : "string"
}
```

Key fields for a *specific* method response are explained in the following table:

Key	Description
segments	An array of 0 or more segments from the IMS™ data resource.
last	If present, indicates whether the segment is the last in the IMS™ resource.
<i>segment-name</i>	The key is the name of the IMS™ database segment.
<i>layout-name</i>	The key is the name of the record layout as in the File Manager view. The value is an object containing one or more fields related to the layout.

Key	Description
<i>field1-name</i> ... <i>fieldn-name</i>	The key is the name of the data field. The value is the value of the data field.
token	<p>A File Manager session token. A token is returned when a request sets <code>"session" : true</code> and does not also pass a token value. The token represents a File Manager/IMS session running in the z/OS® environment and can be used by subsequent requests when multiple reads by a client are required.</p> <p>To end the FM/IMS session, the client must send a request with the token and <code>"session" : false</code>, otherwise the session will eventually time out if inactive.</p>

Specific method responses for Db2®

A successful response generates an HTTP status code of 200. Failures produce an appropriate status code and an error message describing the cause of the failure.

File Manager Service Provider generates the following JSON format in response to a successful specific method request for Db2® data:

```
{
  "rows" :
  [
    {
      "last" : boolean,
      "columns" :
      {
        "column1-name" : "value",
        "column2-name" : "value",
        "column3-name" : "value",
        "columnn-name" : "value"
      }
    }
  ],
  "token" : "string"
}
```

Key fields for a *specific* method response are explained in the following table:

Key	Description
rows	An array of 0 or more rows from the Db2® result table.
last	If present, indicates whether the row is the last in the Db2® result table.
columns	An object containing 1 or more row columns and their values.
<i>column1-name</i> ... <i>columnn-name</i>	The key is the name of the column. The value is the value of the column.

Key	Description
token	<p>A File Manager session token. A token is returned when a request sets <code>"session" : true</code> and does not also pass a token value. The token represents a File Manager/Db2 session running in the z/OS® environment and can be used by subsequent requests when multiple reads by a client are required.</p> <p>To end the FM/Db2 session, the client must send a request with the token and <code>"session" : false</code>, otherwise the session will eventually time out if inactive.</p>

Creating z/OS® Connect APIs

Installing the z/OS® Connect EE API Editor into your Eclipse environment adds a perspective that allows you to create a z/OS® Connect EE API Project.

The z/OS® Connect EE API Editor is an Eclipse-based workstation tool that you install into IBM® Explorer for z/OS® to create REST APIs. Once the editor is installed into your Eclipse environment, a new perspective is available that allows you to create a z/OS® Connect EE API Project, using the **File > New** menu option.

The editor can be downloaded from the IBM® Mainframe Developer Center. Documentation for z/OS Connect and the z/OS Connect EE API editor is provided by IBM® Knowledge Center.

The API editor allows you to define the URL for your APIs, including path parameters and query strings. For example:

Figure 170. z/OS Connect EE API Editor

z/OS Connect EE API Editor

▼ Describe your API

Name: Description:

Base path:

Version:

+ Path

+ Methods ▼

▶ GET Service... Mapping... ↑ ↓ ✕

Each API must be associated with a service. For File Manager APIs, service archive files called `fmService.sar`, `fmIMSService.sar`, and `fmDB2Service.sar` are provided for this purpose. The service archive files are copied to a location

accessible from your Eclipse environment during installation of the File Manager Service Provider for z/OS Connect (see the *File Manager Customization Guide*).

Alternatively, you can create your own service archives (SAR files) using the provided File Manager Build Toolkit plug-in.

During API creation, you must associate the API with a File Manager service. Click the **Service** button and navigate to a File Manager service archive file on your file system:

Figure 171. Associating the API with a File Manager service

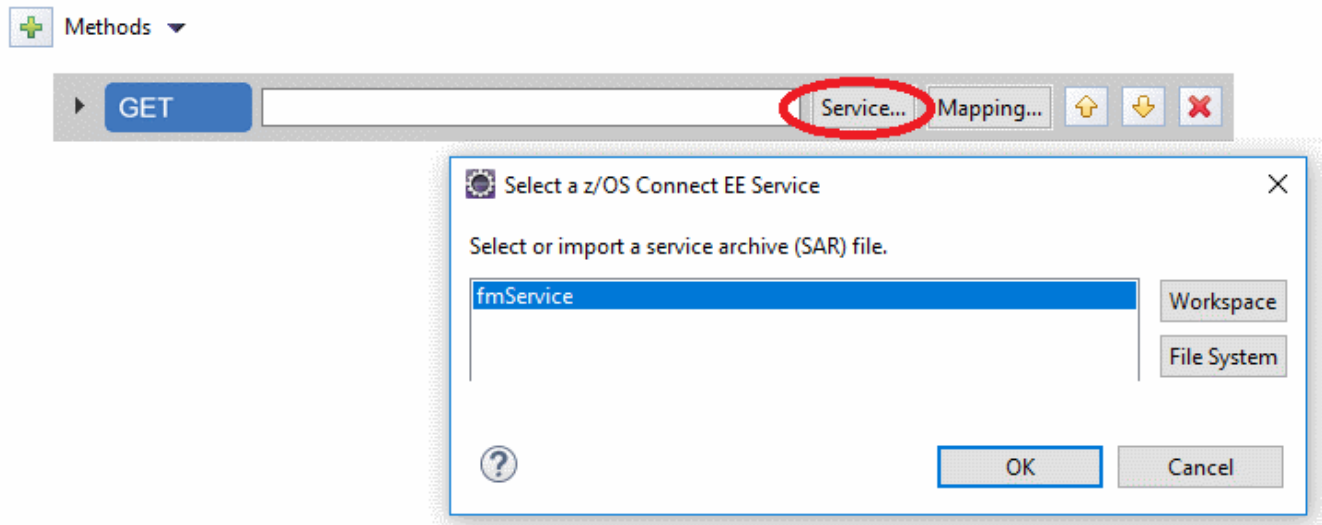

You can map data provided by the API caller into the JSON request schema expected by the File Manager Service Provider.

Figure 172. Generic request example: mapping API data in the request schema

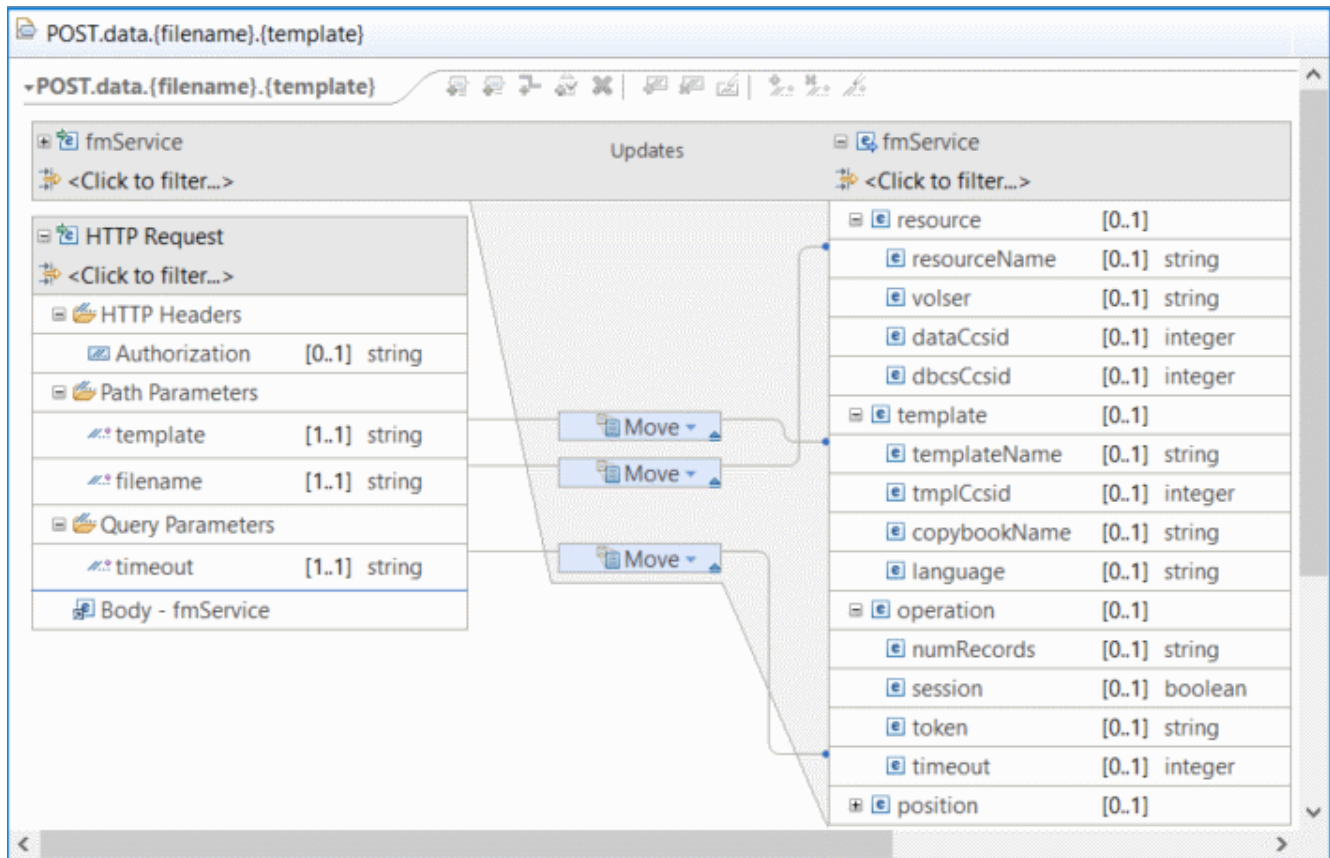

In [Figure 172: Generic request example: mapping API data in the request schema on page 669](#), the path parameters for file name and template name, and the query parameter for timeout, have been mapped to the request schema. API creators can map as little or as much of the request schema as required. Whatever is not mapped must be provided in the HTTP request body by the client issuing the REST API call.

New APIs can be deployed to your z/OS Connect WebSphere Liberty Profile (WLP) environment using the **z/OS Connect EE > Deploy API to z/OS Connect EE Server** menu option.

Using the Build Toolkit plug-in

z/OS® Connect provides a Build Toolkit (zconbt) for creating service archive (SAR) files. SAR files are used during z/OS® Connect API creation to associate APIs with service providers such as File Manager Service Provider.

The z/OS® Connect EE Build Toolkit is bundled with the z/OS® Connect host product. It provides a command line tool, zconbt, that runs in Windows, Linux, and z/OS® environments.

Documentation for the toolkit is provided in IBM® Knowledge Center. Installation of the File Manager Build Toolkit plug-in for use with zconbt is described in the *File Manager for z/OS® Customization Guide*.

zconbt command line utility

The zconbt utility expects as input a properties file and generates as output a SAR file.

The input and output file names are passed as parameters to the utility. For example:

```
> zconbt -p=customer1.properties -f=customer1.sar
```

The File Manager Build Toolkit plug-in expects the properties file to nominate a data resource (file) and a matching File Manager template, view, or copybook. The plug-in uses this information to build the SAR file. For example:

```
name=customer1
version=1.0
provider=filemanager
host=10.1.1.2
port=9043
userid=admin
passwd=s3cr3t
file=FMN.CUSTOMER.KSDS
template=FMN.TEMPLATE(CUST1)
connid=default
```

As with all SAR files, the `name` must be unique. For File Manager, the provider must be `filemanager`. The host, port, userid and passwd properties are used during SAR file creation to connect to a z/OS® system to access the template which is used to generate the SAR file's JSON response schema.

The z/OS® system must be running the ADFzCC server (IPVSRV) on the host and port number provided. The user ID must have read access to the template, view, or copybook file. The connid property associates the generated SAR file with a configuration element in the `server.xml` of the z/OS® Connect WLP server. For example:

```
<FileManager_Connection>
  id="default" runport="2800" max_timeout="1800"
</FileManager_Connection>
```

Once a SAR file has been created, it can be used to build z/OS Connect APIs using the z/OS Connect API Editor. See [Creating z/OS Connect APIs on page 667](#) for more information.

Build Toolkit plug-in properties

This topic describes the properties expected by the File Manager Build Toolkit plug-in.

Properties differ by resource type. Resource types include File Manager Base component, IMS™, and Db2®. File Manager Base component resources include MVS™ data sets, UNIX System Services files, CICS® files, CICS TD and TS queues, and MQ queues.

Build Toolkit plug-in properties for File Manager Base component resources

This topic describes the properties expected by the File Manager Build Toolkit plug-in for File Manager Base component resources.

File Manager Base component resources include MVS™ data set, UNIX System Services files, CICS® files, CICS TD and TS queues, and MQ queues.

Property	Importance	Description
name	Required	The name of the service. Must be unique across SAR files.
description	Optional	The description of the service. Recommended to help manage SAR files.
version	Required	The version of the service.
provider	Required	Must be <code>filemanager</code> .
file	Required	The name of the data resource for which the service applies. Examples: MVS.DATASET, /uss/data.dat, FI:APPLID:CICSFILE, TD:APPLID:CICSTDQ, TS:APPLID:CICSTSQ, MQ:QMGR:QNAME where <i>APPLID</i> represents the application ID of the target CICS region, and <i>QMGR</i> represents the MQ system.
volser	Optional	Data resource volume serial, if applicable.
dataCcsid	Optional	CCSID of resource alphanumeric data in the file. Default is 037.
dbcsCcsid	Optional	CCSID of graphic or double-byte data. Default is 930.
template	Required	Name of a File Manager template that maps the data resource. Example: MVS.DATASET(TEMPLATE).
language	Optional	Language of the copybook when the template property identifies a copybook. Can be COBOL, PLI, HLASM, or AUTO. Do not specify a language if the template property nominates a File Manager template.
tmplCcsid	Optional	CCSID of the template or copybook. Default is 037.
timeout	Optional	Time in seconds for which the File Manager view session can be inactive before it is terminated. Can be any value from 0 to 28800 (eight hours). The default is 300 (5 minutes). If the value is greater than the <code>max_timeout</code> in the <code>server.xml</code> configuration, the timeout value is ignored and the <code>max_timeout</code> value is used instead.
connid	Optional	Connection ID. Associates the generated SAR file with a configuration element in the <code>server.xml</code> of the z/OS® Connect WLP server. Default is <i>"default"</i> .
host	Required	The hostname or IP address of the ADFzCC server (IPVSRV) where the template or copybook resides. The host property is only relevant during SAR creation.
port	Required	The port number of the ADFzCC server (IPVSRV) where the template or copybook resides. The port property is only relevant during SAR creation.
userid	Required	A user ID that has read access to the template or copybook on the z/OS system running the IPVSRV server. The userid property is only relevant during SAR creation.

Property	Importance	Description
passwd	Required	A password of the user ID that has read access to the template or copybook on the z/OS® system running the IPVSRV server. The passwd property is only relevant during SAR creation.

Build Toolkit plug-in properties for IMS™ resources

This topic describes the properties expected by the File Manager Build Toolkit plug-in for IMS™ data resources.

Property	Importance	Description
name	Required	The name of the service. Must be unique across SAR files.
description	Optional	The description of the service. Recommended to help manage SAR files.
version	Required	The version of the service.
provider	Required	Must be <code>filemanager</code> .
ssid	Required	The IMS™ subsystem identifier.
database	Required	The name of the IMS™ database.
psbMember	Optional	The IMS™ Program Specification Block (PSB) member name. This is a member in the File Manager PSB data set concatenation. If psbMember is not specified File Manager will attempt to generate a dynamic PSB (if this is permitted). For a dynamic PSB, the pcbNumber and pcbName parameters are ignored.
pcbNumber	Optional	The Program Communication Block (PCB) number. This is the relative position of the PCB within the PSB member and must be numeric. The relevant PCB can be identified using pcbNumber or pcbName. The default is 1.
pcbName	Optional	Program Communication Block (PCB) name. This is the PCB label name within the PSB member. The relevant PCB can be identified using pcbNumber or pcbName.
regionType	Required	The IMS™ region type. Must be "BMP" or "DLI".
dataCcsid	Optional	CCSID of resource alphanumeric data in the database. Default is 037.
dbcsCcsid	Optional	CCSID of graphic or double-byte data. Default is 930.
viewName	Required	Name of a File Manager/IMS view. Example: MVS.DATASET(MYVIEW).
viewCcsid	Optional	CCSID of the FM/IMS view. Default is 037.
timeout	Optional	Time in seconds for which the FM/IMS view session can be inactive before it is terminated. Can be any value from 0 to 28800 (eight hours). The default is 300 (5 minutes).

Property	Importance	Description
		If the value is greater than the <code>max_timeout</code> in the <code>server.xml</code> configuration, the timeout value is ignored and the <code>max_timeout</code> value is used instead.
<code>connid</code>	Optional	Connection ID. Associates the generated SAR file with a configuration element in the <code>server.xml</code> of the z/OS® Connect WLP server. Default is <code>"default"</code> .
<code>host</code>	Required	The hostname or IP address of the ADFzCC server (IPVSRV) where the FM/IMS view resides. The <code>host</code> property is only relevant during SAR creation.
<code>port</code>	Required	The port number of the ADFzCC server (IPVSRV) where the FM/IMS view resides. The <code>port</code> property is only relevant during SAR creation.
<code>userid</code>	Required	A user ID that has read access to the FM/IMS view on the z/OS system running the IPVSRV server. The <code>userid</code> property is only relevant during SAR creation.
<code>passwd</code>	Required	A password of the user ID that has read access to the FM/IMS view on the z/OS® system running the IPVSRV server. The <code>passwd</code> property is only relevant during SAR creation.

Build Toolkit plug-in properties for Db2® resources

This topic describes the properties expected by the File Manager Build Toolkit plug-in for Db2® data resources.

Property	Importance	Description
<code>name</code>	Required	The name of the service. Must be unique across SAR files.
<code>description</code>	Optional	The description of the service. Recommended to help manage SAR files.
<code>version</code>	Required	The version of the service.
<code>provider</code>	Required	Must be <code>filemanager</code> .
<code>ssid</code>	Required	The Db2® subsystem identifier.
<code>owner</code>	Required	The name of the Db2® data resource owner.
<code>tableName</code>	Required	The name of the Db2® data resource.
<code>dataCcsid</code>	Optional	CCSID of resource alphanumeric data. Default is 037.
<code>dbcsCcsid</code>	Optional	CCSID of graphic or double-byte data. Default is 930.
<code>templateName</code>	Optional	Name of a File Manager/Db2 template that maps the Db2® data resource. Example: <code>MVS.DATASET(DB2TMPL)</code> .
<code>tmplCcsid</code>	Optional	CCSID of the template. Default is 037.
<code>timeout</code>	Optional	Time in seconds for which the FM/Db2 session can be inactive before it is terminated. Can be any value from 0 to 28800 (eight hours). The default is 300 (5 minutes).

Property	Importance	Description
		If the value is greater than the <code>max_timeout</code> in the <code>server.xml</code> configuration, the timeout value is ignored and the <code>max_timeout</code> value is used instead.
<code>connid</code>	Optional	Connection ID. Associates the generated SAR file with a configuration element in the <code>server.xml</code> of the z/OS® Connect WLP server. Default is <i>"default"</i> .
<code>host</code>	Required	The hostname or IP address of the ADFzCC server (IPVSRV) where the FM/Db2 template resides. The host property is only relevant during SAR creation.
<code>port</code>	Required	The hostname or IP address of the ADFzCC server (IPVSRV) where the FM/Db2 template resides. The host property is only relevant during SAR creation.
<code>userid</code>	Required	A user ID that has read access to the FM/Db2 template on the z/OS system running the IPVSRV server. The <code>userid</code> property is only relevant during SAR creation.
<code>passwd</code>	Required	A password of the user ID that has read access to the FM/Db2 template on the z/OS® system running the IPVSRV server. The <code>passwd</code> property is only relevant during SAR creation.

Deploying SAR files

Service archives (SAR files) created using the `zconbt` command-line utility must be deployed to your z/OS® Connect WLP environment.

Specifically, the SAR files must be deployed to the `/services` directory of any server that hosts APIs associated with the service archive. For example:

```
/var/zosconnect/servers/<yourServer>/resources/zosconnect/services
```

Use binary mode to transfer service archives.

Once SAR files have been deployed, the target z/OS® Connect WLP servers must be restarted or refreshed. To refresh a server, use the `REFRESH MODIFY` command:

```
modify <jobname>.<identifier>,zcon,refresh
```

where `<jobname>.<identifier>` matches the job name and optionally the job identifier of your z/OS® Connect WLP started task.

Configuring File Manager SAR files

Each SAR file that was built using the `zconbt` command and the File Manager Build Toolkit plug-in identifies a connection ID (`connid`).

This connection ID correlates with a configuration element in the `server.xml` of the z/OS® Connect WLP server. If `connid` is not specified in the properties file during SAR creation, a default value of *"default"* is used.

Associating a `connid` with a configuration element in `server.xml` allows each SAR file to have its own configuration or to share a configuration with other SAR files. The configuration element specifies the port number of the ADFz Common Components (IPVSRV) to use when starting File Manager sessions in response to API calls, and a maximum timeout value for these sessions. For example, in `server.xml`:

```
<FileManager_Connection id="default" runport="9043" max_timeout="1800" />
```

You can have as many `<FileManager_Connection>` configuration elements as are required by your SAR files. Your service will use the configuration element with an `id` that matches the `connid` specified in the properties file during SAR creation. For example, a SAR file created with `connid=IPVSRV7` will use a configuration element with a matching `id`. For example:

```
<FileManager_Connection id="IPVSRV7" runport="9143" max_timeout="3600" />
```

If a configuration element in the `server.xml` cannot be found that matches the `connid` of the SAR file, the element with `id="default"` is used.

The provided SAR files `fmService.sar`, `fmIMSService.sar`, and `fmDB2Service.sar` use `connids` `fmService`, `fmIMSService`, and `fmDB2Service` respectively.

Modifying templates

If you create a SAR file based on a template and later change the template, the response schema of your SAR file might be out of sync with the data returned by File Manager Service Provider.

The same is true if you change the structure of the data in a file nominated during SAR creation. To avoid these situations, rebuild SAR files when changes to the underlying template, view, or copybook are made.

Swagger documentation

The z/OS® Connect API Editor automatically generates Swagger documentation during API creation. A `swagger.json` file is created within the API project.

Figure 173. z/OS® Connect Swagger JSON

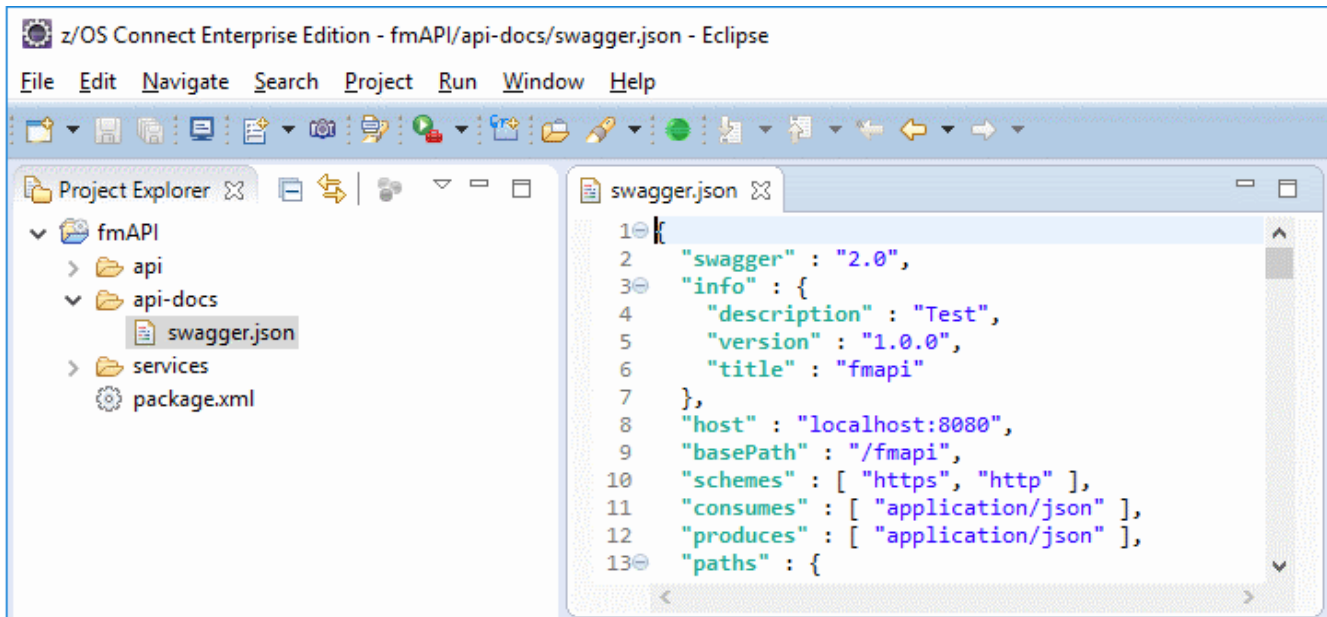

This content is also available via REST API from the z/OS Connect WLP server. For example:

```
GET https://your.server:port/<apiBasePath>/api-docs
```

Where *<apiBasePath>* is the name of your API as specified in the API Editor.

The *swagger.json* content can be viewed in a Swagger document editor such as Swagger UI or Swagger Codegen.

Alternatively, you can use the **z/OS Connect EE Servers** view in Eclipse: right-click on the API and select the **Open in Swagger UI** menu option.

Figure 174. Viewing swagger.json content in Swagger UI

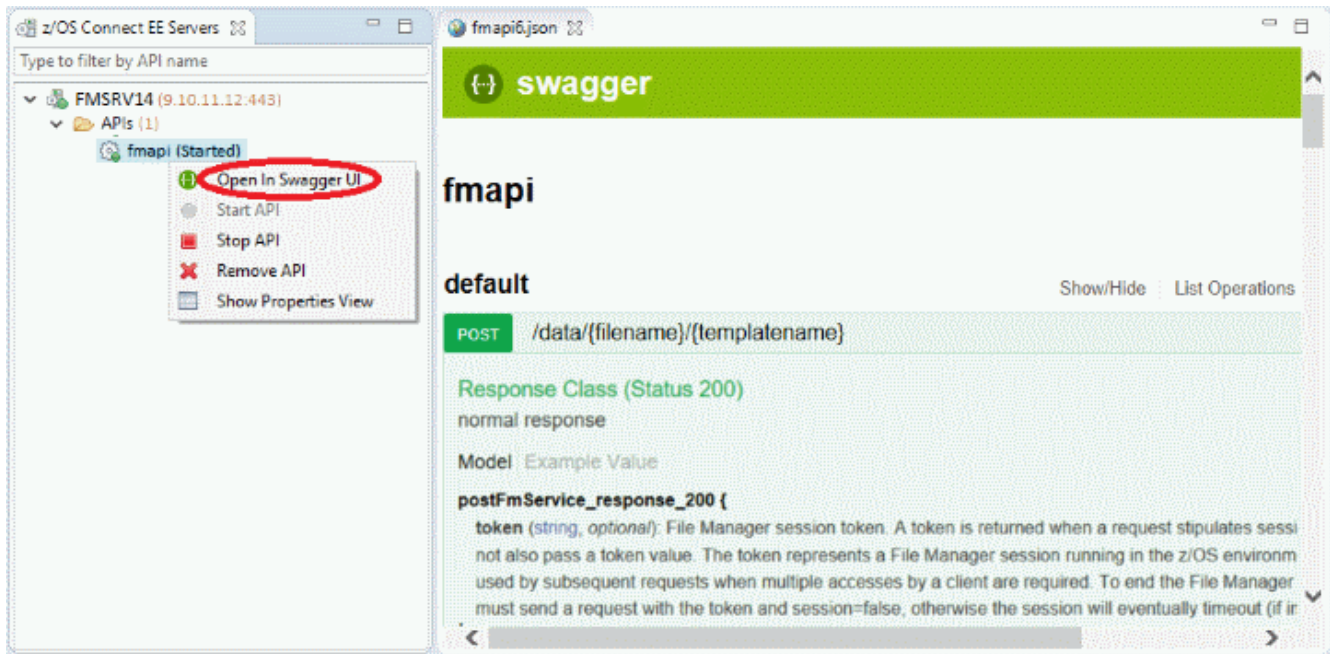

Security

The File Manager Service Provider for z/OS® Connect EE requires an API caller to pass an HTTP Basic Authorization header that identifies the user ID and password of the caller.

The header is in the following format:

```
Authorization : Basic credentials_string
```

where *credentials_string* represents a Base64 encoding of *userid:password*. For example:

```
Authorization : Basic "dXNlcmIkJ0nBhc3N3b3Jk"
```

The File Manager Service Provider performs all accesses to z/OS resources as the *userid* identified by the Basic Authorization credentials. Consequently, API callers can only access data resources they are authorized to access.



Important: Regardless of whether the API network is private or public, the Basic Authorization header only obfuscates rather than encrypts the user ID and password. For this reason, it is important that API requests to your z/OS® Connect WLP server use HTTPS.

When requested, a successful API request returns a token that can be used on subsequent API requests to read data from the same data resource. When using a token, the API does not need to pass the Basic Authorization header.

Tokens returned by the service provider have a default expiry of 5 minutes of inactivity. In some cases, the timeout can be overridden by the request. If the token is not used for the timeout period, it expires and can no longer be used by the API caller.

When using the File Manager Build Toolkit plug-in to create service archives (SAR files), the plug-in needs to connect to the ADFzCC server (IPVSRV) to extract File Manager template or copybook information. If the Toolkit environment is remote to your IPVSRV host, you should run the server with TLS enabled. Refer to the *File Manager Customization Guide*.

Troubleshooting

Use this information to troubleshoot File Manager API request failures.

Check the API response

APIs where possible return an error text in the HTTP response body. This is often the best place to begin when diagnosing an API failure. APIs also generate an HTTP status code, which may provide additional information.

Check that the z/OS Connect WLP server is running

An inability to connect to the z/OS Connect WLP server may indicate that the server is not running. Check that the server is running on your target z/OS system.

Check the port numbers in z/OS Connect WLP server.xml

If you are unable to connect to your z/OS Connect WLP server when it is running, you can verify that you are using the correct port number by viewing the server.xml.

By default, z/OS Connect creates the WLP server in `/var/zosconnect` and the `server.xml` can be found in the subdirectory with the name of your server. For example:

```
/var/zosconnect/servers/<yourServer>/server.xml
```

The port numbers are found in the `<httpEndpoint>` stanza. For example:

```
<httpEndpoint id="defaultHttpEndpoint"
  host="*"
  httpPort="9099"
  httpsPort="9043" />
```

Check that the API URL matches the deployed z/OS Connect API

When creating an API using the z/OS Connect API Editor, the API creator chooses the *base path* and *API path*. The URL of the resulting API should have the following structure:

```
https://<your.server>:<port><base.path><API.path>
```

Figure 175. Specifying a base path and API path in the z/OS Connect API Editor

The screenshot shows the 'z/OS Connect EE API Editor' window. Under the 'Describe your API' section, the 'Name' field is 'fmapi', 'Base path' is '/fmapi', and 'Version' is '1.0.0'. The 'Description' field contains 'FM API example'. Below this, the 'Path' section has a field containing '/data/{resource}/{template}'. The 'Methods' section shows a dropdown menu with 'POST' selected and a text field containing 'fmService'.

In this example shown in [Figure 175: Specifying a base path and API path in the z/OS Connect API Editor on page 679](#), the URL should look similar to the following:

```
https://<your.server>:<port>/fmapi/data/MY.FILENAME/MY.TEMPLATE(TMPL)
```

Check that the URL you are using is correct.

Check that the z/OS Connect API has been deployed

When an API has been created using the z/OS Connect API Editor, it must be deployed to the z/OS Connect host system before it is available. APIs can be deployed directly from the z/OS Connect Eclipse environment. Available APIs are listed in the z/OS Connect WLP JOBLOG when an API is deployed, or when the server is started.

Check that your API is listed as installed by looking for either of the following messages in the z/OS Connect WLP JOBLOG:

```
BAQR7000I: z/OS Connect API package API.name installed successfully.
```

```
BAQR7034I: z/OS Connect API package API.name updated successfully.
```

Check that the File Manager Service Provider is installed

Installation involves running the WLP installUtility command to install the File Manager Service Provider as a WLP feature. Verify that the feature has been installed by confirming that the following message appears in the z/OS Connect WLP server JOBLOG:

```
CWVKF0012I: The server installed the following features:
[...filemanager:fmProvider-2.0...]
```

Installation of the File Manager Service Provider for z/OS Connect is documented in the *File Manager Customization Guide*.

Check the HTTP API request headers

All File Manager Service Provider requests require an HTTP Content-Type header in the following form:

```
Content-Type: application/json
```

For single or initial requests to read a data resource, the caller must also provide an HTTP Basic Authorization header in the following form:

```
Authorization : Basic credentials_string
```

where *credentials_string* represents a Base64 encoding of *userid:password* for the target z/OS system.

Check that the z/OS Connect WLP server is accessible

Issue the following z/OS Connect REST API command:

```
https://<your.server>:<port>/zosConnect/services
```

This API will return a list all the services available on the server. If the File Manager service `fmService` is listed, your z/OS Connect WLP server is accessible.

Check that the ADFzCC server is running

The ADFz Common Components (ADFz Common Components) server is used to start or connect to File Manager sessions when an API request is issued. Therefore, the ADFzCC server must be running for the File Manager Service Provider to do its work. In addition, the ADFzCC server must be configured to run on the port specified in the `<FileManager_Connection>` stanza in the z/OS Connect WLP `server.xml`. For example:

```
<FileManager_Connection id="default" runport="2800" max_timeout="1800" />
```

Look for the following message in the ADFzCC server JOBLOG to confirm that the server's port number matches the port number specified in the `server.xml`:

```
IPV0015I ADFzCC server
Running on port <port_number>.
```

Check the z/OS Connect WLP JOBLOG for messages

Error messages related to a problem with an API or service provider might be logged in the z/OS Connect WLP JOBLOG. Check for messages related to your problem.

Check the z/OS Connect WLP trace and message logs

By default, WLP writes log and trace messages to the server's `logs` directory, for example:

```
/var/zosconnect/servers/<yourservice>/logs
```

Check the `trace.log` and `messages.log` files in this directory for messages related to your problem.

Example scenarios

The following examples illustrate the sequence of File Manager Service Provider REST API calls used to process some common file types under different scenarios.

Client applications issue HTTP REST API requests to the z/OS® Connect WLP server. z/OS® Connect maps the request headers and URL parameters into the request schema of the service associated with the API, and passes the final JSON payload to the service provider associated with the service.

The service provider validates the request JSON and performs the action requested. Essentially, the service provider reads records from a nominated data resource.

Clients can use the generic or specific methods to read data from data resources, and to indicate whether the service provider should persist a File Manager session when multiple reads from the resource are anticipated.

Generic method examples

The following examples demonstrate the generic method for data access.

z/OS® Connect can map as little or as much of the JSON request payload as required during API creation. In these examples, nothing is mapped, so the API caller passes all relevant parameters.

Example 1: Read an MVS™ data set sequentially

In the following example, File Manager Service Provider REST API calls are issued to start a persistent session to read records in an MVS™ data set, using a template to map fields in each record.

Example

Initial request

An initial API call to read data from a data resource requires an HTTP Basic Authorization header so that the caller can be authenticated for subsequent access to z/OS® data resources. For example:

```
Authorization : Basic dXNlcm1kOnBhc3N3b3Jk
```

where the string after the Basic keyword represents a Base64 encoding of *userid:password*.

All requests with a JSON payload also require a Content-Type header with a value of `application/json`.

The initial request also requires the name of the data resource and optionally the name of a File Manager template or copybook to map the data:

```
{
  "resource" :
  {
    "resourceName" : "MY.MVS.DATASET"
  },
  "template" :
  {
    "templateName" : "MY.TEMPLATE(MVSDS)"
  },
}
```

```

"operation" :
{
  "numRecords" : 1,
  "session" : true,
  "timeout" : 1800
}
}

```

This request reads one record from the beginning of data set MY.MVS.DATASET and uses a template found in MY.TEMPLATE(MVSDS) to map out the record fields in the response.

The service provider will persist a File Manager session because `session` is set to true. The session will remain active until a subsequent request is made with `session` set to false, or a timeout period of 1800 seconds (30 minutes) elapses with no activity on the session.

The caller can expect a token to be returned on an initial request when `session` is set to true, and can use the token on subsequent calls without the need to pass resource or template parameters or a Basic Authorization header.

Example

Successful response

A successful response (HTTP Status Code 200) will be similar to the following:

```

{
  "records" :
  [
    {
      "layouts" :
      [
        {
          "layout" : "CUSTOMER-ADDRESS",
          "fields" :
          [
            {
              "field" : "CUSTOMER-NO",
              "type" : "PD",
              "value" : 5788
            },
            {
              "field" : "CUSTOMER-STREET",
              "type" : "AN",
              "value" : "177A BLEEKER STREET"
            },
            {
              "field" : "CUSTOMER-CITY",
              "type" : "AN",
              "value" : "NEW YORK"
            },
            {
              "field" : "CUSTOMER-COUNTRY",
              "type" : "AN",
              "value" : "USA"
            }
          ]
        }
      ]
    }
  ]
}

```

```

    ]
  }
] ,
"token" : ""+WCCd/9g8fXy8PT58vfz9mD39fL48fU="
}

```

Example

Subsequent read requests

The API caller can now make subsequent requests using the response token and reuse the File Manager session maintained by the service provider. For example:

```

{
  "operation" :
  {
    "numRecords" : 1,
    "session" : true,
    "token" : "+WCCd/9g8fXy8PT58vfz9mD39fL48fU="
  }
}

```

When passing a token, the caller does not need to pass `resource` or `template` parameters as these are already known by the session associated with the token. The API caller can continue to read one or more records at a time until a response record object has `last` set to true, indicating that the last record has been read. For example:

```

{
  "records" :
  [
    {
      "last" : true,
      other response fields
    }
  ]
}

```

Example

Ending the session

At this point, the API caller sends a request to terminate the active File Manager session.

```

{
  "operation" :
  {
    "numRecords" : 0,
    "session" : false,
    "token" : "+WCCd/9g8fXy8PT58vfz9mD39fL48fU="
  }
}

```

Sending a request with `session` set to false will always terminate the File Manager session, providing the token is valid. Since the caller has already read the last record, setting `"numRecords" : 0` tells the service provider not to attempt to read any more records.

Example 2: Read a keyed record from a CICS® VSAM data set

In the following example, File Manager Service Provider REST API calls are issued to access a CICS® VSAM data set using a template, and read one record from a specified key position.

Example

Initial request

An initial API call to read data from a data resource requires an HTTP Basic Authorization header so that the caller can be authenticated for subsequent access to z/OS® data resources. For example:

```
Authorization : Basic dXNlcmlkOnBhc3N3b3Jk
```

where the string after the Basic keyword represents a Base64 encoding of *userid:password*.

All requests with a JSON payload also require a Content-Type header with a value of `application/json`.

The initial request also requires the name of the data resource and optionally the name of a File Manager template or copybook to map the data:

```
{
  "resource" :
  {
    "resourceName" : "FI:CICSR01:MYKSDS"
  },
  "template" :
  {
    "templateName" : "MY.TEMPLATE(MYKSDS)"
  },
  "operation" :
  {
    "numRecords" : 1,
    "session" : false
  },
  "position" :
  {
    "key" : "X'0007331C'"
  }
}
```

This request attempts to access a CICS® file called MYKSDS in the CICSR01 region, position at a key with hex value X'0007331C', and read one record. The service provider will not maintain a File Manager session or return a token because `session` is set to false.

Example

Successful response

A successful response (HTTP Status Code 200) will be similar to the following:

```
{
  "records" :
  [
    {
```



```

"layouts" :
[
  {
    "layout" : "CUSTOMER-ADDRESS",
    "fields" :
    [
      {
        "field" : "CUSTOMER-NO",
        "type" : "PD",
        "value" : 7331
      },
      {
        "field" : "CUSTOMER-STREET",
        "type" : "AN",
        "value" : "2 MACQUARIE STREET"
      },
      {
        "field" : "CUSTOMER-CITY",
        "type" : "AN",
        "value" : "SYDNEY"
      },
      {
        "field" : "CUSTOMER-COUNTRY",
        "type" : "AN",
        "value" : "AUSTRALIA"
      }
    ]
  }
]
}

```

The caller does not need to issue a second request to terminate the File Manager session because no session was maintained by the service provider.

Example 3: Read the entire contents of a UNIX System Services file

In the following example, File Manager Service Provider REST API calls are issued to read all records in a UNIX System Services file without using a template or copybook.

Example

Initial request

An initial API call to read data from a data resource requires an HTTP Basic Authorization header so that the caller can be authenticated for subsequent access to z/OS® data resources. For example:

```
Authorization : Basic dXNlcm1k0nBhc3N3b3Jk
```

where the string after the Basic keyword represents a Base64 encoding of *userid:password*.

All requests with a JSON payload also require a Content-Type header with a value of `application/json`.

The initial request also requires the name of the data resource.

This request will attempt to read the entire contents of the UNIX System Services file `filemanager.properties` in directory `/var/filemanager`.

```
{
  "resource" :
  {
    "resourceName" : "/var/filemanager/filemanager.properties"
  },
  "operation" :
  {
    "numRecords" : 10000
  }
}
```

No field mapping in the response will occur because no `template` parameters are provided. In addition, no session will be maintained because `session` is not specified and the default is false.

10,000 is the maximum number of records that can be read by a single request. If the file contains more than 10,000 records, a session would be required to read the records in blocks.

Example

Successful response

A successful response (HTTP Status Code 200) will be similar to the following:

```
{
  "records" :
  [
    {
      "layouts" :
      [
        {
          "layout": "UNKNOWN",
          "fields":
          [
            {
              "field": "DATA",
              "type": "AN",
              "value": "com.ibm.websphere.productId=filemanager"
            }
          ]
        }
      ]
    },
    {
      "last" : true,
      "layouts" :
      [
        {
          "layout": "UNKNOWN",
          "fields":
          [
            {
              "field": "DATA",
              "type": "AN",

```

```

    "value": "com.ibm.websphere.productInstall=/var/filemanager"
  }
]
}
]
}
]
}
}

```

The caller does not need to issue a second request to terminate the File Manager session because no session was maintained by the service provider. Because the second record returned is the last in the file, `last` is set to true.

Example 4: Read an IMS™ database sequentially

In the following example, File Manager Service Provider REST API calls are issued to start a persistent IMS™ session to read segments from an IMS™ database, using a File Manager/IMS view to map fields in each segment.

Example

Initial request

An initial API call to read data from an IMS™ data resource requires an HTTP Basic Authorization header so that the caller can be authenticated for subsequent access to IMS™ data resources. For example:

```
Authorization : Basic dXNlcmlkOnBhc3N3b3Jk
```

where the string after the Basic keyword represents a Base64 encoding of *userid:password*.

All requests with a JSON payload also require a Content-Type header with a value of `application/json`.

The initial request also requires the name of the IMS™ subsystem, the IMS™ database name, an IMS™ region type, and a File Manager/IMS view to map the data:

```

{
  "resource" :
  {
    "ssid" : "IFB2",
    "database" : "HDOU#1",
    "regionType" : "DLI"
  },
  "view" :
  {
    "viewName" : "IMS.VIEW(HDOU#1)"
  },
  "operation" :
  {
    "numSegments" : 1,
    "session" : true
  }
}

```

This request reads one segment from the beginning of IMS™ database HDOU#1 in IMS™ subsystem IFB2 as filtered by a File Manager/IMS view that is stored in IMS.VIEW(HDOU#1). The request uses a dynamic PSB because a `psbMember` is not

specified, and the request stipulates a region type of DLI. The request uses IMS.VIEW(HDOU#1) to map out the segment fields in the response.

The service provider will persist a File Manager/IMS session because `session` is set to true. The session remains active until a subsequent request is made with `session` set to false, or the default timeout period (5 minutes) elapses with no activity on the session.

The caller can expect a token to be returned on an initial request when `session` is set to true, and can use the token on subsequent calls without the need to pass resource or view parameters, or a Basic Authorization header.

Example

Successful response

A successful response (HTTP Status Code 200) will be similar to the following:

```
{
  "segments":
  [
    {
      "segment":
      {
        "layout": "PARTROOT",
        "segname": "PARTROOT",
        "fields":
        [
          {
            "field": "ROOT-TYPE",
            "type": "AN",
            "value": "02"
          },
          {
            "field": "ROOT-KEY",
            "type": "AN",
            "value": "922399-001"
          },
          {
            "field": "ROOT-SPACES",
            "type": "AN",
            "value": " "
          },
          {
            "field": "ROOT-WOSNAME",
            "type": "AN",
            "value": "CONNECTOR"
          }
        ]
      }
    }
  ],
  "token": "5Umys+Ng8fX18Pjx9fjy82D28/Lw9PA="
}
```

Example

Subsequent read requests

The API caller can now make subsequent requests using the response token and reuse the FM/IMS session maintained by the service provider. For example:

```
{
  "operation" :
  {
    "numSegments" : 1,
    "session" : true,
    "token": "5Umys+Ng8fX18Pjx9fjy82D28/Lw9PA="
  }
}
```

When passing a token, the caller does not need to pass resource or view parameters as these are already known by the session that is associated with the token.

The API caller can continue to read one or more segments at a time until a response segment object has `last` set to true, indicating that the last segment has been read. For example:

```
{
  "segments" :
  [
    {
      "last" : true,
      ... other response fields
    }
  ]
}
```

Example

Ending the session

At this point, the API caller sends a request to terminate the active FM/IMS session.

```
{
  "operation" :
  {
    "numSegments" : 0,
    "session" : false,
    "token": "5Umys+Ng8fX18Pjx9fjy82D28/Lw9PA="
  }
}
```

Sending a request with `session` set to false will always terminate the FM/IMS session, providing the token is valid. Since the caller has already read the last segment, setting `"numSegments" : 0` tells the service provider not to attempt to read any more segments.

Example 5: Read from a position within an IMS™ database

In the following example, File Manager Service Provider REST API calls are issued to position within an IMS™ database and then read a segment at that position.

Example

Initial request

An initial API call to read data from an IMS™ data resource requires an HTTP Basic Authorization header so that the caller can be authenticated for subsequent access to IMS™ data resources. For example:

```
Authorization : Basic dXNlcmlkOnBhc3N3b3Jk
```

where the string after the Basic keyword represents a Base64 encoding of *userid:password*.

All requests with a JSON payload also require a Content-Type header with a value of `application/json`.

The initial request also requires the name of the IMS™ subsystem, the IMS™ database name, a PSB member name, an IMS™ region type, and a File Manager/IMS view to map the data. Dynamic PSBs are supported and can be specified by using the `psbName` parameter and the value DYNAMIC.

The position parameters allow the specification of a series of `segmentKeys`, which match the hierarchy of the database and keyed segments. In this case, we are positioning on a root segment with a key value equal to "02922399-001":

```
{
  "resource" :
  {
    "ssid" : "IFB2",
    "database" : "HDOU#1",
    "psbMember" : "PHDOU#1",
    "pcbName" : "DBPCB1",
    "regionType" : "BMP"
  },
  "view" :
  {
    "viewName" : "IMS.VIEW(HDOU#1)"
  },
  "operation" :
  {
    "numSegments" : 1,
    "session" : false
  },
  "position" :
  {
    "segmentKeys" :
    [
      {
        "segmentName" : "PARTROOT",
        "keyValue" : "02922399-001",
        "operator" : "EQ"
      }
    ]
  }
}
```

This request reads one segment from the nominated position within the IMS™ database HDOU#1 in IMS™ subsystem IFB2. The request will use PSB member PHDOU#1 and the PCB with label DBPCB1 in the PSB member. The region type is BMP. The request will use the view IMS.VIEW(HDOU#1) to map out the segment fields in the response.

The service provider will not persist a File Manager/IMS session because `session` is set to `false`.

Example

Successful response

A successful response (HTTP Status Code 200) will be similar to the following:

```
{
  "segments":
  [
    {
      "segment":
      {
        "layout": "PARTROOT",
        "segname": "PARTROOT",
        "fields":
        [
          {
            "field": "ROOT-TYPE",
            "type": "AN",
            "value": "02"
          },
          {
            "field": "ROOT-KEY",
            "type": "AN",
            "value": "922399-001"
          },
          {
            "field": "ROOT-SPACES",
            "type": "AN",
            "value": " "
          },
          {
            "field": "ROOT-WOSNAME",
            "type": "AN",
            "value": "CONNECTOR"
          }
        ]
      }
    }
  ]
}
```

The caller does not need to issue a second request to terminate the FM/IMS session because no session was maintained by the service provider.

Example 6: Read a Db2® database sequentially

In the following example, File Manager Service Provider REST API calls are issued to start a persistent Db2® session to read rows from a Db2® table, using a File Manager template to map fields in each row.

Example

Initial request

An initial API call to read data from a Db2® data resource requires an HTTP Basic Authorization header so that the caller can be authenticated for subsequent access to Db2® data resources. For example:

```
Authorization : Basic dXNlcmk0bHc3N3b3Jk
```

where the string after the Basic keyword represents a Base64 encoding of *userid:password*.

All requests with a JSON payload also require a Content-Type header with a value of `application/json`.

The initial request also requires the name of the Db2® subsystem, the Db2® table owner, the Db2® table name, and optionally a File Manager/Db2 template to map the data. If you do not specify a template, the service provider will build a dynamic template and return all table columns and rows.

```
{
  "resource" :
  {
    "ssid" : "DFG2",
    "owner" : "DSN81010",
    "tableName" : "EMP"
  },
  "template" :
  {
    "templateName" : "DB2.TEMPLATE(EMPTMPL)"
  },
  "operation" :
  {
    "numRows" : 1,
    "session" : true,
    "timeout" : 300,
    "maxRows" : 0
  }
}
```

This request reads one row from the beginning of Db2® table EMP, which is owned by DSN81010, in Db2® subsystem DFG2. The request will use FM/Db2 template DB2.TEMPLATE(EMPTMPL) to map out the row columns in the response.

The service provider will persist a File Manager/Db2 session because `session` is set to true. The session will remain active until a subsequent request is made with `session` set to false, or a timeout period of 300 seconds (5 minutes) elapses with no activity on the session.

The `maxRows` parameter specifies 0, which means all rows in the table. The default is 10000 if `maxRows` is not specified.



Note: Reading all rows in a large table may take a long time.

The caller can expect a token to be returned on an initial request when `session` is set to true, and can use the token on subsequent calls without the need to pass resource or template parameters, or a Basic Authorization header.

Example

Successful response

A successful response (HTTP Status Code 200) will be similar to the following:

```
{
  "rows":
  [
    {
      "columns":
      [
        {
          "column": "EMPNO",
          "type": "CH(6)",
          "value": "000010"
        },
        {
          "column": "FIRSTNME",
          "type": "VC(12)",
          "value": "CHRISTINE"
        },
        {
          "column": "LASTNAME",
          "type": "VC(15)",
          "value": "HAAS"
        },
        {
          "column": "WORKDEPT",
          "type": "CH(3)",
          "value": "A00"
        },
        {
          "column": "JOB",
          "type": "CH(8)",
          "value": "PRES"
        },
        {
          "column": "SALARY",
          "type": "DEC(9,2)",
          "value": 52750
        }
      ]
    }
  ],
  "token": "1zcuItFg8fX18Pjx+PXw9GD29/Tx+Pk="
}
```

Subsequent read requests

The API caller can now make subsequent requests using the response token and reuse the FM/Db2 session maintained by the service provider. For example:

```
{
  "operation" :
  {
    "numRows" : 1,
    "session" : true,
    "token": "1zcuItFg8fX18Pjx+PXw9GD29/Tx+Pk="
  }
}
```

```
}
}
```

When passing a token, the caller does not need to pass resource or template parameters as these are already known by the session associated with the token.

The API caller can continue to read one or more rows at a time until a response row object has `last` set to true, indicating that the last row has been read. For example:

```
{
  "rows" :
  [
    {
      "last" : true,
      ... other response fields
    }
  ]
}
```

Ending the session

At this point, the API caller sends a request to terminate the active FM/Db2 session.

```
{
  "operation" :
  {
    "numRows" : 0,
    "session" : false,
    "token": "1zcuItFg8fX18Pjx+PXw9GD29/Tx+Pk="
  }
}
```

Sending a request with `session` set to false will always terminate the FM/Db2 session, providing the token is valid. Since the caller has already read the last row, setting `"numRows" : 0` tells the service provider not to attempt to read any more rows.

Example 7: Apply a WHERE clause to a Db2® table

In the following example, File Manager Service Provider REST API calls are issued to limit the result table using a Db2® WHERE clause, then read the first row in the result table.

Example

Initial request

An initial API call to read data from a Db2® data resource requires an HTTP Basic Authorization header so that the caller can be authenticated for subsequent access to Db2® data resources. For example:

```
Authorization : Basic dXNlcmlkOnBhc3N3b3Jk
```

where the string after the Basic keyword represents a Base64 encoding of `userid:password`.

All requests with a JSON payload also require a Content-Type header with a value of `application/json`.

The initial request also requires the name of the Db2® subsystem, the Db2® table owner, the Db2® table name, and optionally a File Manager/Db2 template to map the data. If you don't specify a template, the service provider will build a dynamic template and return all table columns and rows.

A WHERE clause is only valid on an initial API request that starts the Db2® session and builds the result table for the session.

```
{
  "resource" :
  {
    "ssid" : "DFG2",
    "owner" : "DSN81010",
    "tableName" : "EMP"
  },
  "template" :
  {
    "templateName" : "DB2.TEMPLATE(EMPTMPL)"
  },
  "operation" :
  {
    "numRows" : 1,
    "session" : false,
    "where" : "WORKDEPT = 'B01'"
  }
}
```

This request reads the first row from the beginning of Db2® table EMP, which is owned by DSN81010, in Db2® subsystem DFG2, after applying a WHERE clause of `WORKDEPT = 'B01'`. The request will use FM/Db2 template DB2.TEMPLATE(EMPTMPL) to map out the row columns in the response.

The service provider will not persist a File Manager/Db2 session because `session` is set to false.

Example

Successful response

A successful response (HTTP Status Code 200) will be similar to the following:

```
{
  "rows":
  [
    {
      "columns":
      [
        {
          "column": "EMPNO",
          "type": "CH(6)",
          "value": "000020"
        },
        {
          "column": "FIRSTNME",
          "type": "VC(12)",
          "value": "MICHAEL"
        }
      ]
    }
  ]
}
```

```

        "column": "LASTNAME",
        "type": "VC(15)",
        "value": "THOMPSON"
    },
    {
        "column": "WORKDEPT",
        "type": "CH(3)",
        "value": "B01"
    },
    {
        "column": "JOB",
        "type": "CH(8)",
        "value": "Manager"
    },
    {
        "column": "SALARY",
        "type": "DEC(9,2)",
        "value": 41250
    }
    ]
}
]
}

```

The caller does not need to issue a second request to terminate the FM/Db2 session because no session was maintained by the service provider.

Specific method examples

The following examples demonstrate the specific method for data access.

z/OS® Connect can map as little or as much of the JSON request payload as required during API creation. In these examples, nothing is mapped, so the API caller passes all relevant parameters.



Note: The specific method for accessing data requires the creation and deployment of a service archive (SAR file). The service archive is built using the z/OS® Connect Build Toolkit (zconbt) and prescribes a data resource and matching template, view, or copybook. APIs associated with the service archive during API creation apply to the prescribed data resource only. Therefore, in the following examples, no resource or template parameters are required. Refer to [Using the Build Toolkit plug-in on page 669](#) for more information on creating and deploying service archives.

Example 8: Read a CICS® VSAM file sequentially

In the following example, File Manager Service Provider REST API calls are issued to start a persistent session to read records in a CICS® VSAM data set, using a template to map fields in each record.

This example assumes that a service archive has been created and deployed that maps a CICS® VSAM file with a matching template or copybook. For example, the service archive could be created using the following properties file:

```

name=fmExample4
description=CICSR01:MYKSDS MAPPED BY MY.TEMPLATE(MYKSDS)
version=1.0

```

```

provider=filemanager
host=10.1.1.2
port=9043
userid=admin
passwd=s3cr3t
file=FI:CICSR01:MYKSDS
template=MY.TEMPLATE(MYKSDS)
timeout=300
connid=default

```

This example maps a CICS® VSAM file MYKSDS in CICS® region CICSR01 with a template found in MY.TEMPLATE(MYKSDS). This example assumes that the generated SAR file and APIs built in association have been deployed to your z/OS® Connect WLP server.

Example

Initial request

An initial API call to read data from a data resource requires an HTTP Basic Authorization header so that the caller can be authenticated for subsequent access to z/OS® data resources. For example:

```
Authorization : Basic dXNlcm1kOnBhc3N3b3Jk
```

where the string after the Basic keyword represents a Base64 encoding of *userid:password*.

All requests with a JSON payload also require a Content-Type header with a value of `application/json`.

The initial request does not need to name the data resource or provide template information because this information is already contained in the service archive associated with the API. Therefore, the API caller only needs to provide the optional `operation` and `position` parameters, if required:

```

{
  "operation" :
  {
    "numRecords" : 1,
    "session" : true
  }
}

```

This request will read one record from the beginning of the VSAM file MYKSDS in CICS® region CICSR01. Any records read will be mapped in the response by the template that was found in MY.TEMPLATE(MYKSDS) when the SAR file was created.

The service provider will persist a File Manager session because `session` is set to true. The session will remain active until a subsequent request is made with `session` set to false, or a timeout period of 300 seconds (5 minutes) elapses with no activity on the session. This timeout period is preset in the service archive.

The caller can expect a token to be returned on an initial request when `session` is set to true, and can use the token on subsequent calls without the need to pass a Basic Authorization header.

Example

Successful response

A successful response (HTTP Status Code 200) will be similar to the following:

```
{
  "records" :
  [
    {
      "layouts" :
      [
        {
          "CUSTOMER-ADDRESS" :
          {
            "CUSTOMER-NO" : 5788,
            "CUSTOMER-STREET" : "177A BLEEKER STREET",
            "CUSTOMER-CITY" : "NEW YORK",
            "CUSTOMER-COUNTRY" : "USA"
          }
        }
      ]
    }
  ],
  "token" : "zhRKQMhg8fXy8PX39/D3+GDx9vHz+PA="
}
```

Example

Subsequent read requests

The API caller can now make subsequent requests using the response token and reuse the File Manager session maintained by the service provider. For example:

```
{
  "operation" :
  {
    "numRecords" : 1,
    "session" : true,
    "token" : "zhRKQMhg8fXy8PX39/D3+GDx9vHz+PA="
  }
}
```

The API caller can continue to read one or more records at a time until a response record object has `last` set to true, indicating that the last record has been read. For example:

```
{
  "records" :
  [
    {
      "last" : true,
      etc.
    }
  ]
}
```

Example

Ending the session

At this point, the API caller sends a request to terminate the active File Manager session.

```
{
  "operation" :
  {
    "numRecords" : 0,
    "session" : false,
    "token" : "zhRKQMhg8fXy8PX39/D3+GDx9vHz+PA="
  }
}
```

Sending a request with `session` set to `false` will always terminate the File Manager session, providing the token is valid. Since the caller has already read the last record, setting `"numRecords" : 0` tells the service provider not to attempt to read any more records.

Example 9: Read a keyed record from a CICS VSAM data set

In the following example, File Manager Service Provider REST API calls are issued to access a CICS VSAM data set using a template, and read one record from a specified key position.

This example assumes that a service archive has been created and deployed that maps a CICS® VSAM file with a matching template or copybook. For example, the service archive could be created using the following properties file:

```
name=fmExample5
description=CICSR01:MYKSDS MAPPED BY MY.TEMPLATE(MYKSDS)
version=1.0
provider=filemanager
host=10.1.1.2
port=9043
userid=admin
passwd=s3cr3t
file=FI:CICSR01:MYKSDS
template=MY.TEMPLATE(MYKSDS)
timeout=300
connid=default
```

This example maps a CICS® VSAM file MYKSDS in CICS® region CICSR01 with a template found in MY.TEMPLATE(MYKSDS). This example assumes that the generated SAR file and APIs built in association have been deployed to your z/OS® Connect WLP server.

Example

Initial request

An initial API call to read data from a data resource requires an HTTP Basic Authorization header so that the caller can be authenticated for subsequent access to z/OS® data resources. For example:

```
Authorization : Basic dXNlcmlkOnBhc3N3b3Jk
```

where the string after the Basic keyword represents a Base64 encoding of `userid:password`.

All requests with a JSON payload also require a Content-Type header with a value of `application/json`.

The initial request does not need to name the data resource or provide template information because this information is already contained in the service archive associated with the API. Therefore, the API caller only needs to provide the optional `operation` and `position` parameters, if required:

```
{
  "operation" :
  {
    "numRecords" : 1,
    "session" : false
  },
  "position" :
  {
    "key" : " X'0007331C'"
  }
}
```

This request attempts to access a CICS® file called MYKSDS in the CICSRO1 region, position at a key with hex value X'0007331C', and read one record. The service provider will not maintain a File Manager session or return a token because `session` is set to `false`.

Example

Successful response

A successful response (HTTP Status Code 200) will be similar to the following:

```
{
  "records" :
  [
    {
      "layouts" :
      [
        {
          "CUSTOMER-ADDRESS" :
          {
            "CUSTOMER-NO" : 7331,
            "CUSTOMER-STREET" : "2 MACQUARIE STREET",
            "CUSTOMER-CITY" : "SYDNEY",
            "CUSTOMER-COUNTRY" : "AUSTRALIA"
          }
        }
      ]
    }
  ]
}
```

The caller does not need to issue a second request to terminate the File Manager session because no session was maintained by the service provider.

Example 10: Read the entire contents of an MVS™ data set member

In the following example, File Manager Service Provider REST API calls are issued to start a non-persistent session to read all records in an MVS™ member, using a template to map fields in each record.

This example assumes that a service archive has been created and deployed that maps an MVS™ data set member with a matching template or copybook. For example, the service archive could be created using the following properties file:

```
name=fmExample6
description=ADMIN.JCL(TERSE) MAPPED BY MY.TEMPLATE(JCL)
version=1.0
provider=filemanager
host=10.1.1.2
port=9043
userid=admin
passwd=s3cr3t
file=ADMIN.JCL(TERSE)
template=MY.TEMPLATE(JCL)
timeout=300
connid=default
```

This example maps an MVS™ data set member called ADMIN.JCL(TERSE) with a template found in MY.TEMPLATE(JCL). This example assumes that the generated SAR file and APIs built in association have been deployed to your z/OS® Connect WLP server.

Example

Initial request

An initial API call to read data from a data resource requires an HTTP Basic Authorization header so that the caller can be authenticated for subsequent access to z/OS® data resources. For example:

```
Authorization : Basic dXNlcm1kOnBhc3N3b3Jk
```

where the string after the Basic keyword represents a Base64 encoding of *userid:password*.

All requests with a JSON payload also require a Content-Type header with a value of `application/json`.

The API caller only needs to pass `"numRecords" : 10000`. The `session` parameter defaults to `false`:

```
{
  "operation" :
  {
    "numRecords" : 10000
  }
}
```

This request will attempt to read and return the entire contents of the ADMIN.JCL(TERSE) member, mapped by MY.TEMPLATE(JCL).

10,000 is the maximum number of records that can be read by a single request. If the file contains more than 10,000 records, a session would be required to read the records in blocks.

```

{
  "records" :
  [
    {
      "layouts" :
      [
        {
          "FILE" :
          {
            "RECORD" : "//ADMIN1  JOB(HCL),CLASS=A,NOTIFY=ADMIN"
          }
        }
      ]
    },
    {
      "layouts" :
      [
        {
          "FILE" :
          {
            "RECORD" : "//STEP1  EXEC PGM=AMATERSE,PARM=PACK"
          }
        }
      ]
    },
    {
      "layouts" :
      [
        {
          "FILE" :
          {
            "RECORD" : "//SYSUT1  DD DISP=SHR,DSN=ADMIN.BIN"
          }
        }
      ]
    },
    {
      "last" : true,
      "layouts" :
      [
        {
          "FILE" :
          {
            "RECORD" : "//SYSUT2  DD DISP=SHR,DSN=ADMIN.BIN.TERSED"
          }
        }
      ]
    }
  ]
}

```

The caller does not need to issue a fourth request to terminate the File Manager session because no session was maintained by the service provider. Because the second record returned is the last in the file, `last` is set to true.

Example 11: Read an IMS™ database sequentially

In the following example, File Manager Service Provider REST API calls are issued to start a persistent session to read segments from an IMS™ database, using a File Manager/IMS view to map fields in each segment.

This example assumes that a service archive has been created and deployed that maps an IMS™ database with a matching view. For example, the service archive could be created using the following properties file:

```
name=fmExample11
description=IFB2:HDOU#1 MAPPED BY MY.IMS.VIEW(HDOU#1)
version=1.0
provider=filemanager
host=10.1.1.2
port=9043
userid=admin
passwd=s3cr3t
ssid=IFB2
database=HDOU#1
regionType=DLI
view=MY.IMS.VIEW(HDOU#1)
timeout=300
connid=default
```

This example maps an IMS™ database HDOU#1 in subsystem IFB2 with a dynamic PSB (because psbMember is not specified), and a region type of DLI. The database is mapped by a File Manager/IMS view found in MY.IMS.VIEW(HDOU#1). This example assumes that the generated SAR file and APIs built in association have been deployed to your z/OS® Connect WLP server.

Example

Initial request

An initial API call to read data from an IMS™ data resource requires an HTTP Basic Authorization header so that the caller can be authenticated for subsequent access to IMS™ data resources. For example:

```
Authorization : Basic dXNlcm1kOnBhc3N3b3Jk
```

where the string after the Basic keyword represents a Base64 encoding of *userid:password*.

All requests with a JSON payload also require a Content-Type header with a value of `application/json`.

The initial request does not need to name the data resource or provide view information because this information is already contained in the service archive associated with the API. Therefore, the API caller only needs to provide the optional operation and position parameters, if required:

```
{
  "operation" :
  {
    "numSegments" : 1,
    "session" : true
  }
}
```

This request will read one segment from the beginning of the IMS™ database as filtered by the FM/IMS view. Any segments read will be mapped in the response by the view.

The service provider will persist a File Manager/IMS session because `session` is set to true. The session will remain active until a subsequent request is made with `session` set to false, or a timeout period of 300 seconds (5 minutes) elapses with no activity on the session. This timeout period is preset in the service archive.

The caller can expect a token to be returned on an initial request when `session` is set to true, and can use the token on subsequent calls without the need to pass a Basic Authorization header.

Example

Successful response

A successful response (HTTP Status Code 200) will be similar to the following:

```
{
  "segments":
  [
    {
      "PARTROOT":
      {
        "PARTROOT":
        {
          "ROOT-KEY": "3009280",
          "ROOT-SPACES": " ",
          "ROOT-TYPE": "02",
          "ROOT-WOSNAME": "HOUSING CONV"
        }
      }
    }
  ],
  "token": "/u5qZ/hg8fX18fH29Pjz9WD39fnw8/k="
}
```

Subsequent read requests

The API caller can now make subsequent requests using the response token and reuse the FM/IMS session maintained by the service provider. For example:

```
{
  "operation" :
  {
    "numSegments" : 1,
    "session" : true,
    "token": "/u5qZ/hg8fX18fH29Pjz9WD39fnw8/k="
  }
}
```

The API caller can continue to read one or more segments at a time until a response segment object has `last` set to true, indicating that the last segment has been read. For example:

```
{
  "segments" :
  [
```

```

    {
      "last" : true,
      ... other response fields
    }
  ]
}

```

Ending the session

At this point, the API caller sends a request to terminate the active FM/IMS session.

```

{
  "operation" :
  {
    "numSegments" : 0,
    "session" : false,
    "token": "/u5qZ/hg8fX18fH29Pjz9WD39fnw8/k="
  }
}

```

Sending a request with `session` set to false will always terminate the FM/IMS session, providing the token is valid. Since the caller has already read the last segment, setting `"numSegments" : 0` tells the service provider not to attempt to read any more segments.

Example 12: Read from a position within an IMS™ database

In the following example, File Manager Service Provider REST API calls are issued to access an IMS™ database mapped by a File Manager/IMS view, and read one segment from a specified key position.

This example assumes that a service archive has been created and deployed that maps an IMS™ database with a matching view. For example, the service archive could be created using the following properties file:

```

name=fmExample12
description=IFB2:HDOU#1 MAPPED BY MY.IMS.VIEW(HDOU#1)
version=1.0
provider=filemanager
host=10.1.1.2
port=9043
userid=admin
passwd=s3cr3t
ssid=IFB2
database=HDOU#1
psbMember=PHDOU#1
pcbNumber=1
regionType=BMP
view=MY.IMS.VIEW(HDOU#1)
timeout=300
connid=default

```

This example maps an IMS™ database HDOU#1 in subsystem IFB2 with PSB member PHDOU#1. The `pcbNumber=1` tells File Manager to use the first PCB in the PSB member. The region type is BMP and the database is mapped by the FM/IMS view found in MY.IMS.VIEW(HDOU#1). This example assumes that the generated SAR file and APIs built in association have been deployed to your z/OS® Connect WLP server.

Example**Initial request**

An initial API call to read data from an IMS™ data resource requires an HTTP Basic Authorization header so that the caller can be authenticated for subsequent access to IMS™ data resources. For example:

```
Authorization : Basic dXNlcmlkOnBhc3N3b3Jk
```

where the string after the Basic keyword represents a Base64 encoding of *userid:password*.

All requests with a JSON payload also require a Content-Type header with a value of `application/json`.

The initial request does not need to name the data resource or provide view information because this information is already contained in the service archive associated with the API. Therefore, the API caller only needs to provide the optional operation and position parameters, if required:

```
{
  "operation" :
  {
    "numSegments" : 1,
    "session" : false
  } ,
  "position" :
  {
    "segmentKeys" :
    [
      {
        "segmentName" : "PARTROOT",
        "keyValue" : "02922399-001",
        "operator" : "EQ"
      }
    ]
  }
}
```

This request reads one segment from the nominated position within the IMS™ database HDOU#1 in IMS™ subsystem IFB2. The request will use the FM/IMS view IMS.VIEW(HDOU#1) to map out the segment fields in the response.

The service provider will not persist a File Manager/IMS session because `session` is set to false.

Example**Successful response**

A successful response (HTTP Status Code 200) will be similar to the following:

```
{
  "segments":
  [
    {
      "PARTROOT":
      {
        "PARTROOT":
        {
```

```

        "ROOT-KEY": "922399-001",
        "ROOT-SPACES": " ",
        "ROOT-TYPE": "02",
        "ROOT-WOSNAME": "CONNECTOR"
    }
}
]
}

```

Example 13: Read a Db2® database sequentially

In the following example, File Manager Service Provider REST API calls are issued to start a persistent session to read rows from a Db2® database table, using a template to map columns in each row.

This example assumes that a service archive has been created and deployed that maps a Db2® table with a matching template. For example, the service archive could be created using the following properties file:

```

name=fmExample13
description=DFG2:DSN81010:EMP MAPPED BY MY.DB2.TEMPLATE(EMP)
version=1.0
provider=filemanager
host=10.1.1.2
port=9043
userid=admin
passwd=s3cr3t
ssid=DFG2
owner=DSN81010
tableName=EMP
template=MY.DB2.TEMPLATE(EMP)
timeout=300
connid=default

```

This example maps a Db2® database table EMP owned by DSN81010 in subsystem DFG2. The table is mapped by a File Manager template found in MY.DB2.TEMPLATE(EMP). This example assumes that the generated SAR file and APIs built in association have been deployed to your z/OS® Connect WLP server.

Example

Initial request

An initial API call to read data from an Db2® data resource requires an HTTP Basic Authorization header so that the caller can be authenticated for subsequent access to Db2® data resources. For example:

```
Authorization : Basic dXNlcm1kOnBhc3N3b3Jk
```

where the string after the Basic keyword represents a Base64 encoding of *userid:password*.

All requests with a JSON payload also require a Content-Type header with a value of `application/json`.

The initial request does not need to name the data resource or provide template information because this information is already contained in the service archive associated with the API. Therefore, the API caller only needs to provide the optional operation and position parameters, if required:

```
{
  "operation" :
  {
    "numRows" : 1,
    "session" : true
  }
}
```

This request will read one row from the beginning of the Db2® table as filtered by the FM/Db2 template. Any rows read will be mapped in the response by the template.

The service provider will persist a File Manager/Db2 session because `session` is set to true. The session will remain active until a subsequent request is made with `session` set to false, or a timeout period of 300 seconds (5 minutes) elapses with no activity on the session. This timeout period is preset in the service archive.

The caller can expect a token to be returned on an initial request when `session` is set to true, and can use the token on subsequent calls without the need to pass resource or template parameters, or a Basic Authorization header.

Example

Successful response

A successful response (HTTP Status Code 200) will be similar to the following:

```
{
  "rows":
  [
    {
      "columns":
      [
        {
          "PHONENO": "4978",
          "EDLEVEL": 18,
          "FIRSTNAME": "CHRISTINE",
          "MIDINIT": "I",
          "BIRTHDATE": "1933-08-14",
          "SALARY": 52750,
          "COMM": 4220,
          "LASTNAME": "HAAS",
          "WORKDEPT": "A00",
          "HIREDATE": "1965-01-01",
          "BONUS": 1000,
          "EMPNO": "000010",
          "JOB": "PRES"
        }
      ]
    }
  ],
  "token": "1NC6BNJg8fX18fH2+fP58GDy9/f39/Y="
}
```

Subsequent read requests

The API caller can now make subsequent requests using the response token and reuse the FM/Db2 session maintained by the service provider. For example:

```
{
  "operation" :
  {
    "numRows" : 1,
    "session" : true,
    "token": "1NC6BNJg8fX18fH2+fP58GDy9/f39/Y="
  }
}
```

The API caller can continue to read one or more rows at a time until a response row object has `last` set to true, indicating that the last row has been read. For example:

```
{
  "rows" :
  [
    {
      "last" : true,
      ... other response fields
    }
  ]
}
```

Ending the session

At this point, the API caller sends a request to terminate the active FM/Db2 session.

```
{
  "operation" :
  {
    "numRows" : 0,
    "session" : false,
    "token": "1NC6BNJg8fX18fH2+fP58GDy9/f39/Y="
  }
}
```

Sending a request with `session` set to false will always terminate the FM/Db2 session, providing the token is valid. Since the caller has already read the last row, setting `"numRows" : 0` tells the service provider not to attempt to read any more rows.

Example 14: Apply a WHERE clause to a Db2® table

In the following example, File Manager Service Provider REST API calls are issued to limit the result table using a Db2® WHERE clause, then read the first row in the result table.

This example assumes that a service archive has been created and deployed. If you don't specify a template in the properties when generating the SAR file, the service provider will build a dynamic template and return all table columns and rows. For example, the service archive could be created using the following properties file:

```
name=fmExample14
description=DFG2:DSN81010:EMP MAPPED BY MY.DB2.TEMPLATE(EMP)
version=1.0
```

```

provider=filemanager
host=10.1.1.2
port=9043
userid=admin
passwd=s3cr3t
ssid=DFG2
owner=DSN81010
tableName=EMP
timeout=300
connid=default

```

Example

Initial request

An initial API call to read data from an Db2® data resource requires an HTTP Basic Authorization header so that the caller can be authenticated for subsequent access to Db2® data resources. For example:

```
Authorization : Basic dXNlcmlkOnBhc3N3b3Jk
```

where the string after the Basic keyword represents a Base64 encoding of *userid:password*.

All requests with a JSON payload also require a Content-Type header with a value of `application/json`.

The initial request does not need to name the data resource or provide template information because this information is already contained in the service archive associated with the API. Therefore, the API caller only needs to provide the optional operation and position parameters, if required:

```

{
  "operation" :
  {
    "numRows" : 1,
    "session" : false,
    "where" : "WORKDEPT = 'B01'"
  }
}

```

This request reads the first row from the Db2® table EMP, which is owned by DSN81010, in Db2® subsystem DFG2, after applying a WHERE clause of `WORKDEPT = 'B01'`. The request will build a default template and return all columns in the row in the response.

The service provider will not persist a File Manager/Db2 session because `session` is set to false.

Example

Successful response

A successful response (HTTP Status Code 200) will be similar to the following:

```

{
  "rows":
  [
    {
      "last": true,
      "columns":

```

```
[
  {
    "PHONENO": "3476",
    "EDLEVEL": 18,
    "FIRSTNAME": "MICHAEL",
    "MIDINIT": "L",
    "BIRTHDATE": "1948-02-02",
    "SALARY": 41250,
    "COMM": 3300,
    "LASTNAME": "THOMPSON",
    "WORKDEPT": "B01",
    "HIREDATE": "1973-10-10",
    "BONUS": 800,
    "EMPNO": "000020",
    "JOB": "Manager"
  }
]
```

The caller does not need to issue a second request to terminate the FM/Db2 session because no session was maintained by the service provider.

Chapter 18. Function and panel reference lists

Introduction

Reference lists contain all the fields that are associated with either a function or a panel. You can save and retrieve reference lists for most of the commonly used functions or panels. A reference list is identified by a 1-8 character name and an optional description field that you provide when you issue the SAVEREF command. This is a convenient way to save all data set names and all the associated options for a given process, and retrieve them later.

FMNREFTB DD - Sharing reference lists

The reference list can be saved in an ISPF table in the ISPF user profile or the data set associated with DD FMNREFTB if allocated. You can share reference lists with other users by using the FMNREFTB DD. If you allocate an FMNREFTB DD, ensure that the associated data set is partitioned with a record format of fixed blocked and a logical record length of 80.

Save reference command: SAVEREF (SR SREF)

Use this command to save a new or replace an existing function or panel reference.

Syntax

SAVEREF *reference_name* (SR, SREF) where

reference_name

Is an optional 1-8 character unique name that is used to retrieve the reference field values. The value can be generic to produce a list of existing references that is replaced if selected. The value can also be a fully qualified name that is a new reference or an existing reference.

Save reference panel

```

Process  Options  Help
-----DSM Function Reference Save-----
Name . . . COMPARE1
Description compare for change fields on payroll data sets
Enter a new reference name and optionally a description
Press ENTER to save, EXIT to cancel

Command ==> _____

Processing Options:
Copybook/template usage      Enter "/" to select option
3 1. Above                    Edit template   Type (1,2,S)
   2. Previous                Advanced member selection
   3. None                    Skip member name list
   4. Create dynamic          / Batch execution
                               Binary mode, reclen

Command ==> saveref compare1

```

Field descriptions:**Name**

The reference name. Choose a memorable name for retrieval later.

Description

The description of the current set of field values.

Retrieve reference command. GETREF (GR GREF)**Syntax**

GETREF *reference_name* (GR, GREF) where

reference_name

Is an optional 1-8 character unique name that is used to retrieve the reference field values. The value can be generic or blank to produce a list of existing references. Or the value can be a fully qualified name of an existing reference to avoid the list.

Example

```

Process  Options  Help
-----
File Manager          Compare Utility : Old Data Set
More:                +
"Old" Partitioned, Sequential or VSAM Data Set, or HFS file:
Data set/path name . . 'FMN.REGTEST.PI53019.DATA' +
Member . . . . . CHFLD0 (Blank or pattern for member list)
Volume serial . . . . . (If not cataloged)
Start key . . . . . key or slot
Skip count . . . . . number of records to be skipped
Compare count . . . . . ALL number of records to be compared

"Old" Copybook or Template:
Data set name . . . . . 'FMN.REGTEST.PI53019.TEMPLATE'
Member . . . . . CHFLD (Blank or pattern for member list)

Processing Options:
Copybook/template usage Enter "/" to select option
 3 1. Above                - Edit template      Type (1,2,S)
  2. Previous             - Advanced member selection
  3. None                  - Skip member name list
  4. Create dynamic        / Batch execution
                               - Binary mode, reclen _____

Command ==> GR COMPARE1
    
```

Maintaining your saved references – Reference list

Use the reference list to update, delete, or rename existing references. You can produce the reference list when you issue a GETREF command with a blank or generic reference name or a SAVEREF command with a generic reference name.

Figure 176. Reference List Panel

```

Process  Options  Help
-----
File Manager          DSM Function Reference List          Row 00001 of 00003

Name      Description
*         *
- COMPARE1 compare for change fields on payroll data sets
- COMPARE2 compare for accounting data sets
- COMPARE3 compare for order processing
**** End of data ****

Command ==> _____ Scroll CSR
    
```

Field Descriptions:

Name

The name that is used to save the current field values for the function.

Description

The description of the saved field values. To change the description, overwrite the text in this field.

Line Commands:

S or /

Selects the reference for retrieval or to be replaced.

R

Renames the reference.

D

Deletes the reference.

Part II. File Manager Reference

Chapter 19. Panels and fields

This section of the manual lists all of the File Manager panels, provides a definition for each field in the panel and, where applicable, lists the value ranges that are valid for each field.

Summary of File Manager panels

The table below lists each File Manager panel. For information on using the panels, see the topic in the Panel column. For information about what you use the panel for, see the topic in the Usage column.

For most File Manager panels, there is an equivalent File Manager function that you can use when programming batch jobs, REXX procedures or TSO clists. These are listed in the “*Equivalent function*” column. For information on programming with File Manager functions, see [Introduction to programming with File Manager functions on page 503](#).

Table 21. File Manager panels

Option	Description	Panel	Usage	Equivalent function
0 0.1–0.9	Set Processing Options displays and changes parameters that affect File Manager behavior.	Set Processing Options panel on page 1029	Setting your default processing options on page 78	SET (Set Processing Options) on page 1550
1	View allows you to display and edit data but without the ability to save changes. You can scroll through the data, search for a line number or string, hide records, and copy data to the clipboard.	View panel on page 1083	Viewing and changing data sets on page 87	DSV (Data Set View) on page 1480 ¹
2	Edit allows you to display and edit data.	Editor panel on page 853	Viewing and changing data sets on page 87	DSE (Data Set Edit) on page 1342 ¹
3	Utility Functions	Utility Functions menu panel on page 1077		
3.0	Set DBCS Format allows you to specify which columns in a data record are in EBCDIC (the default), DBCS, or mixed format.	Set DBCS Format panel on page 1018	Printing DBCS data on page 410	FMT (Set DBCS Format) on page 1517

1. This function can only be invoked under ISPF, as described in [Invoking File Manager panels from outside File Manager on page 39](#).

Table 21. File Manager panels

(continued)

Option	Description	Panel	Usage	Equivalent function
3.1	Data Create Utility allows you to create sequential data sets, VSAM data sets or PDS members, and initialize their field values.	Data Create Utility panel on page 824	Creating data sets and records on page 328	DSG (Data Set Generate) on page 1372
3.2	Print Utility allows you to print data.	Print Utility panel on page 977	Printing from File Manager on page 402	DSP (Data Set Print) on page 1438
3.3	Copy Utility allows you to copy data from a partitioned, sequential, or VSAM data set to any other partitioned, sequential, or VSAM data set, with optional record selection and field-level reformatting.	Copy From panel on page 789	Copying data sets on page 341	DSC (Data Set Copy) on page 1302
3.4	Catalog Services displays or prints catalog information and lets you work with catalog entries.	Catalog Services panel on page 756	Managing catalog entries on page 415	SCS (Catalog Services) on page 1547
3.5	Work with VTOC displays or prints a list of the data sets on a disk volume obtained from the disk VTOC.	Display VTOC panel on page 837	Displaying a Volume Table of Contents (VTOC) on page 432	DVT (Display VTOC) on page 1491
3.6	Find/Change Utility allows you to search for or change a string in a partitioned, sequential or VSAM data set.	Find/Change Utility panel on page 901	Finding and changing data in multiple PDS members on page 368	FCH (Find/Change) on page 1503
3.7	AFP Print Browse provides a formatted display of an Advanced Function Printing (LIST3820) document.	AFP Print Browse panel on page 730	Browsing AFP Print documents on page 437	APB ¹
3.8	Memory Browse displays user storage in dump format.		Browsing your user storage on page 437	MB ¹
3.9	Print Browse browses print output.		Printing from File Manager on page 402	PB ¹
3.10	Load Module Utilities			

Table 21. File Manager panels

(continued)

Option	Description	Panel	Usage	Equivalent function
3.10.1	View Load Module allows you to display or print a list of the symbols (CSECTs, common sections, entry points, compiler options, and ZAPs) in a load module (or program object).	Load Module Information - Selection panel on page 935	Viewing load module information on page 438	VLM (View Load Module) on page 1607
3.10.2	Compare Load Modules allows you to perform load module comparison, with selection from various compare criteria on module and CSECT level.	Load Module Information panel on page 927	Comparing load modules on page 400	CLM (Compare Load Module) on page 1274
3.11	Compare data allows you to perform data set comparisons, with optional record selection and field level comparison mapping.	Compare Utility: "Old" and "New" panels on page 764	Comparing data sets on page 381	DSM (Data Set Compare) on page 1388
3.12	Print audit trail report prints the contents of the audit trail data set.	Print Audit Trail panel on page 974	Printing your Audit Trail Report on page 413	—
3.13	Copybook View and Print displays and prints a copybook or template definition.	Copybook View and Print: View panel on page 816	Copybook View and Print Utility on page 260	PBK
3.14 or 9.1	List WebSphere MQ managers and queues lists WebSphere MQ managers and queues.	WebSphere MQ Managers panel on page 1109	Working with WebSphere MQ on page 439	—
3.15	PDSE Workbench	PDSE Workbench Entry panel on page 960	Using PDSE Workbench on page 639	PWB (PDSE Workbench) on page 1544
4	Tape Specific Functions			
4.1	Tape Browse allows you to browse physical records on a tape.	Tape Browse panel on page 1040	Tape Browse (option 4.1) on page 458	TB ¹
4.2	Tape Data Copy Function	Tape Data Copy Functions panel on page 1040	Tape Data Copy Function (option 4.2) on page 458	

Table 21. File Manager panels

(continued)

Option	Description	Panel	Usage	Equivalent function
4.2.1	Tape to Tape copies tape files from one tape to another.	Tape to Tape panel on page 1050	Tape to Tape (option 4.2.1) on page 459	TT (Tape to Tape) on page 1596
4.2.2	Tape to Tape Reblocked copies a file from one tape to another, changing the block size and record format.	Tape to Tape Reblocked panel on page 1052	Tape to Tape Reblocked (option 4.2.2) on page 459	TTR (Tape to Tape Reblocked) on page 1599
4.2.3	Tape to Labeled Tape copies standard labeled tapes.	Tape to Labeled Tape panel on page 1050	Tape to Labeled Tape (option 4.2.3) on page 459	TLT (Tape to Labeled Tape) on page 1573
4.2.4	Tape to VSAM copies tape records to a VSAM data set.	Tape to VSAM panel on page 1054	Tape to VSAM (option 4.2.4) on page 460	TV (Tape to VSAM) on page 1602
4.2.5	Tape to Sequential Data copies tape records to a sequential data set.	Tape to QSAM panel on page 1053	Tape to Sequential Data (option 4.2.5) on page 461	TS (Tape to Sequential Data) on page 1592
4.2.6	VSAM to Tape copies VSAM records to a tape file.	VSAM to Tape panel on page 1107	VSAM to Tape (option 4.2.6) on page 461	VT (VSAM to Tape) on page 1616
4.2.7	Sequential Data to Tape copies sequential records to a tape file.	Sequential Data to Tape panel on page 1015	Sequential Data to Tape (option 4.2.7) on page 461	ST (Sequential Data to Tape) on page 1568
4.2.8	Exported Stacked Volume Copy copies a logical volume from an Exported Stacked Volume to a physical volume.	Exported Stacked Volume Copy panel on page 875	Exported Stacked Volume Copy (option 4.2.8) on page 462	EVC (Exported Stacked Volume Copy) on page 1499
4.3	Tape Update allows you to update tape records on-screen, while copying the data from one tape to another.	Tape Update panel on page 1055	Tape Update (option 4.3) on page 464	TU ¹
4.4	Tape Record Load copies a specified number of tape records to another tape, and allows you to alter selected blocks.	Tape Record Load (option 4.4) on page 466	Tape Record Load panel on page 1045	—
4.5	Tape Print print tape records, optionally deblocked.	Tape Print panel on page 1044	Tape Print (option 4.5) on page 466	TP (Tape Print) on page 1577

Table 21. File Manager panels

(continued)

Option	Description	Panel	Usage	Equivalent function
4.6	Tape Map summarizes tape contents for a specified number of files.	Tape Map panel on page 1042	Tape Map (option 4.6) on page 468	TMP (Tape Map) on page 1575
4.7	Create Tape Data writes test data to tape.	Create Tape Data panel on page 821	Create Tape Data (option 4.7) on page 469	BT (Create Tape File) on page 1250
4.8	Tape Label Display prints tape labels and a tape label summary.	Tape Label Display panel on page 1041	Tape Label Display (option 4.8) on page 469	TLB (Tape Label Display) on page 1571
4.9	Tape to Tape Compare compares two tapes byte by byte.	Tape to Tape Compare panel on page 1051	Tape to Tape Compare (option 4.9) on page 471	TTC (Tape to Tape Compare) on page 1598
4.10	Tape Record Scan scans for a specified string of data in a tape file.	Tape Record Scan panel on page 1046	Tape Record Scan (option 4.10) on page 471	TRS (Tape Record Scan) on page 1589
4.11	Write Tape Mark writes one or more tape marks at the current position.	Write Tape Mark panel on page 1117	Write Tape Mark (option 4.11) on page 473	WTM (Write Tape Mark) on page 1621
4.12	Initialize Tape	File Manager overview on page 29	Initialize Tape (option 4.12) on page 473	INT (Initialize Tape) on page 1521
4.13	Erase Tape erases a tape from the current position until end-of-tape (EOT).	Erase Tape panel on page 874	Erase Tape (option 4.13) on page 474	ERT (Erase Tape) on page 1498
4.14	Exported Stacked Volume List prints the table of contents (TOC) from an Exported Stacked Volume.	Exported Stacked Volume List panel on page 875	Exported Stacked Volume List (option 4.14) on page 475	EVL (Exported Stacked Volume List) on page 1501
4.15	Tape Positioning Functions	Tape Positioning Functions panel on page 1043	Tape Positioning Functions (option 4.15) on page 476	
4.15.1	Backward Space File moves a tape backward one or more tape files.		BSF on page 454	BSF (Backward Space File) on page 1248

Table 21. File Manager panels

(continued)

Option	Description	Panel	Usage	Equivalent function
4.15.2	Forward Space File moves a tape forward one or more tape files.		FSF on page 456	FSF (Forward Space File) on page 1519
4.15.3	Backward Space Record moves the tape backward one or more records.		BSR on page 455	BSR (Backward Space Record) on page 1249
4.15.4	Forward Space Record moves a tape forward one or more tape records or tape marks.		FSR on page 456	FSR (Forward Space Record) on page 1520
4.15.5	Tape Rewind rewinds a tape to the load point.		REW on page 457	REW (Tape Rewind) on page 1545
4.15.6	Tape Rewind-Unload rewinds a tape and unloads it.		RUN on page 457	RUN (Tape Rewind-Unload) on page 1546
5	Disk/VSAM Data Functions		Disk/VSAM Data Functions on page 477	
5.1	Disk Browse displays the data structure and contents of records stored on the tracks of the specified physical disk.		Disk Browse (option 5.1) on page 477	DB ¹
5.2	Disk Track Edit allows you to display and edit records on the specified physical disk.		Disk Track Edit (option 5.2) on page 478	DTE ¹
5.3	Disk Print prints records from the specified tracks on a physical disk.		Disk Print (option 5.3) on page 485	DP (Disk Print) on page 1286
5.4	Disk Record Scan searches the specified tracks of a physical disk for a particular string or an EOF record.		Disk Record Scan (option 5.4) on page 486	DRS (Disk Record Scan) on page 1289
5.5	Write EOF Record writes a logical EOF record at the specified absolute disk address.		Write EOF Record (option 5.5) on page 487	EOF

Table 21. File Manager panels

(continued)

Option	Description	Panel	Usage	Equivalent function
5.6	Data Set Extents displays the beginning and end addresses of the disk extents of a disk data set.		Data Set Extents (option 5.6) on page 487	DSX (Data Set Extents) on page 1490
5.7	VSAM Update allows you to select and then edit a single record in a VSAM data set.	VSAM Update (option 5.7) on page 488	VSAM Update (option 5.7) on page 488	VU ¹
5.8	Data In Virtual displays data-in-virtual data sets in full-screen mode. You can use this function to browse the data as a continuous string of bytes.		Data in Virtual (option 5.8) on page 489	
6	OAM Functions		OAM Functions on page 490	
6.1	Object Directory List displays or prints a list of Object Access Method (OAM) objects from a collection; if you display the list, you can browse, print, update, or erase any of the listed objects.		Object Directory List (option 6.1) on page 490	ODL (Object Directory List) on page 1523
6.2	Object Browse displays an OAM object.		Object Browse (option 6.2) on page 492	OB ¹
6.3	Object Print prints an OAM object.		Object Print (option 6.3) on page 492	OP (Object Print) on page 1528
6.4	Object Update allows you to display and edit an OAM object.		Object Update (option 6.4) on page 493	OU ¹
6.5	Object Erase erases an OAM object.		Object Erase (option 6.5) on page 493	OE ¹
6.6	Object Copy Functions			
6.6.1	Object to VSAM copies one or more OAM objects to a VSAM data set.		Object to VSAM (option 6.6.1) on page 494	OV (Object to VSAM) on page 1533

Table 21. File Manager panels

(continued)

Option	Description	Panel	Usage	Equivalent function
6.6.2	Object to Sequential Data copies one or more OAM objects to a sequential data set.		Object to Sequential Data (option 6.6.2) on page 494	OS (Object to Sequential Data) on page 1530
6.6.3	VSAM to Object copies data from a VSAM data set to one or more OAM objects.		VSAM to Object (6.6.3) on page 494	VO (VSAM to Object) on page 1614
6.6.4	Sequential Data to Object copies data from a sequential data set to one or more OAM objects.	Sequential Data to Object (option 6.6.4) on page 494	SO SO (Sequential Data to Object) on page 1565	
6.6.5	Object to Object copies an OAM object to another object within the same collection, or to another collection.	Object to Object (option 6.6.5) on page 494	Object to Object (option 6.6.5) on page 494	OO (Object to Object) on page 1526
7	Template and copybook utilities allows you to create, update and edit templates and copybooks.	Copybook and Template Utility functions panel on page 809		
7.1	Workbench allows you to create, edit or update a single template.	Template Workbench panel on page 1072	Creating and editing templates on page 173	AF ¹
7.2	Print allows you to view or print copybooks or templates.	Copybook View and Print: Entry panel on page 814	Copybook View and Print Utility on page 260	PBK (Print Copybook) on page 1536
7.3	Build allows you to compile copybooks into templates.	Template Build Utility panel on page 1056	Creating corresponding templates from selected copybooks on page 217	BTB (Batch Template Build) on page 1253
7.4	Update allows you to update templates.	Template Update Utility panel on page 1066	Updating one or more templates on page 224	BTU (Batch Template Update) on page 1263
7.5	Import allows you to import templates.	Template Import Utility panel on page 1062	Updating one or more templates on page 224	TPIMP (Import template from XML) on page 1584

Table 21. File Manager panels

(continued)

Option	Description	Panel	Usage	Equivalent function
7.6	Export allows you to export templates.	Template Export Utility panel on page 1058	Updating one or more templates on page 224	TPEXP (Export template to XML) on page 1579
7.7	Repository allows you to create and maintain repository data sets and entries.		Template repository utilities on page 193	
7.8	Template List displays a list of templates that includes all template types.	Template List Entry panel on page 275	Working with the Template List on page 271	Keyword invocation from REXX on page 271
8	Access Hierarchical File System invokes standard ISPF services to enable access to z/OS® UNIX® System Services and Hierarchical File System (HFS) Utilities.	Access Hierarchical File System panel on page 725	Using UNIX System Services and the Hierarchical File System on page 497	
9	WebSphere® MQ enables you to list, view, and edit MQ data.	WebSphere MQ Functions panel on page 1108	Working with WebSphere MQ on page 439	
10	CICS .		Accessing CICS resources on page 50	
11	Remote system definition enables you to connect to a remote system.	Remote System Definition panel on page 1009		

Access Hierarchical File System panel

The Access Hierarchical File System panel provides a means of invoking some of the z/OS® Unix Services utilities.

Panel and field definitions

Figure 177. Access Hierarchical File System panel

Process	Options	Help
File Manager		Access Hierarchical File System
1	HFS Browse	Browse data in HFS
2	HFS Edit	Edit data in HFS
3	USS ISPF shell	Invoke USS ISPF shell
Command ==>		
F1=Help	F2=Split	F3=Exit
F9=Swap	F10=Actions	F12=Cancel
	F4=CRetriev	F7=Backward
		F8=Forward

1 HFS Browse

OBROWSE. Browse an HFS file using the ISPF full-screen browse facility.

2 HFS Edit

OEDIT. Edit an HFS file using the ISPF editor.

3 USS ISPF shell

ISHELL. Work with ISPF shell - a panel interface for performing various user and administrator tasks.

Parent panels

- [Primary Option Menu panel on page 970](#)

Child panels

- Standard ISPF services panels.

Related tasks and examples

- [Using UNIX System Services and the Hierarchical File System on page 497](#)

Advanced Member Selection panel

The Advanced Member Selection panel provides a means of specifying a range of PDS(E) members to be included in a print, find/change, or copy action.

or range from

The first member within a partitioned data set to be selected. Padded with blanks to 8 characters. If omitted, all members from the start of the data set to the **to** member are selected.

to

The last member within a partitioned data set to be selected. Padded with blanks to 8 characters. If the last specified character is an asterisk, padded to 8 characters with high values. No other wildcarding is allowed. If omitted, all members from the **or range from** member to the end of the data set are selected.

Member exclude filters

Specify member name patterns to exclude from processing members that would otherwise be selected using the member name or member range options.

Multiple string arguments can be entered. Use the comma character as a delimiter between the strings. Strings can contain the * and % wildcard characters.

To specify a filter containing lowercase characters, use a character string in the format `c'string'`. Filters can also be specified as hexadecimal strings in the format `x'hex-digits'`.

The following is an example of filters that would exclude from processing members with names beginning with the characters `FMN*` or ending with the characters `99`:

```
FMN*,*99
```

Updated by (User id or mask)

The TSO user ID by which the member was last updated. You can specify a generic user ID by using asterisks (*) and percent signs (%) in the usual fashion.

or range from

The start of a range of user IDs. Padded with blanks to 8 characters.

to

The end of a range of user IDs. Padded with blanks to 8 characters. If the last specified character is an asterisk, padded to 8 characters with high values. No other wildcarding is allowed.

Date created (YYYY/MM/DD or mask)

The date on which a member was created, in YYYY/MM/DD format.

You can use a mask to specify a combination of dates. Cannot be used in conjunction with a date range.

or range from

The start of a range of "created on" dates, in YYYY/MM/DD format. If omitted or you specify an asterisk as the last character, the unspecified portions of the date default as follows:

DD

= 01

MM

= 01

YYYY

= 0000

No other wildcarding is allowed.

to

The end of a range of “*created on*” dates, in YYYY/MM/DD format. If omitted or you specify an asterisk as the last character, the unspecified portions of the date default as follows:

DD

= 31

MM

= 12

YYYY

= 9999

No other wildcarding is allowed.

Date modified (YYYY/MM/DD or mask)

The date on which a member was last updated, in YYYY/MM/DD format.

You can use a mask to specify a combination of dates. Cannot be used in conjunction with a date range.

or range from

The start of a range of dates on which a member was last updated, in YYYY/MM/DD format. If omitted or you specify an asterisk as the last character, the unspecified portions of the date default as follows:

DD

= 01

MM

= 01

YYYY

= 0000

No other wildcarding is allowed.

to

The end of a range of dates on which a member was last updated, in YYYY/MM/DD format. If omitted or you specify an asterisk as the last character, the unspecified portions of the date default as follows:

DD

= 31

MM

= 12

YYYY

= 9999

No other wildcarding is allowed.

Parent panels

- [Copy From panel on page 789](#)
- [Print Utility panel on page 977](#)
- [Find/Change Utility panel on page 901](#)

Child panels

- [Copy To panel on page 796](#)
- [Member Selection panel on page 946](#)

Related tasks and examples

- [Selecting a range of PDS\(E\) members on page 70](#)

AFP Print Browse panel

AFP Print Browse provides a formatted display of an Advanced Function Printing (LIST3820) document.

Panel and field definitions

Figure 180. AFP Print Browse panel

```

Process  Options  Help
-----
File Manager                AFP Print Browse

Input:
Data set name . 'FMNUSER.TESTING.LIST3820'_____
Member . . . . _____ if partitioned
Volume serial . _____ if not cataloged

Page Selection:
Start page . . 1___ first page to display
Number of pages 20_ number of pages to format for display
or * for all pages
View size . . . 100_ specify the expansion rate

Command ==>> _____
F1=Help      F2=Split      F3=Exit      F4=CRetriev  F7=Backward  F8=Forward
F9=Swap      F10=Actions   F12=Cancel
    
```

Data set name

Can be a fully-qualified data set name or a pattern. The name may include a member name or name pattern in parenthesis. If the member is specified here, the associated **Member** field must be empty.

Member

If you specified the name of a partitioned data set (PDS) without including a member name or name pattern in parenthesis in the **Data set name** field, then you can use this field to specify the member name or a member name pattern.

Volume serial

Serial number of the volume which contains the data set. Required for data sets which are not cataloged.

Start page

The number of the first page to display.

Range: 1-99999

Default: 1

Number of pages

The number of pages to display. Specify an asterisk * to include all pages to the end of the document.

Range: *,1-99999

Default: 20

View size

A measure for the virtual paper size to be used for formatting. Specify a higher value when the formatting results are not satisfactory, and a lower value to see more data on a screen.

Range: 50-400

Default: 100

Parent panels

- [Utility Functions menu panel on page 1077](#)

Child panels

- [AFP Print Browse output on page 732](#)

Equivalent functions

- None.

Related tasks and examples

- [Browsing AFP Print documents on page 437](#)

AFP Print Browse output

AFP Print Browse output panel displays the formatted Advanced Function Printing (LIST3820) document.

Panel and field definitions

Figure 181. AFP Print Browse: sample output

```

  Process  Options  Help
-----
File Manager      AFP Print Browse      Line 1 of 28
Document FMNUSER.TESTING.LIST3820      Col 1
Start page 1_____ Number of pages 20___ View Size 100
-----+-----1-----+-----2-----+-----3-----+-----4-----+-----5-----+-----6-----+-----7-----+-----8
===== Page 1 =====
Once a jolly swagman camped by a billabong,
Under the shade of a coolibah tree,
And he sang as he watched and waited 'til his billy boiled,
Who'll come a-waltzing, Matilda, with me?"

Waltzing Matilda, Waltzing Matilda,
Who'll come a-waltzing, Matilda, with me?
And he sang as he watched and waited 'til his billy boiled,
Who'll come a-waltzing, Matilda, with me?"

Along came a jumbuck to drink at the billabong,
Up jumped the swagman and grabbed him with glee,
And he sang as he stowed that jumbuck in his tucker bag,
"You'll come a-waltzing, Matilda, with me".
Command ==>
  F1=Help      F2=Split      F3=Exit      F4=CRetriev  F5=RFind      F6=NxtPage
  F7=Up        F8=Down       F9=Swap      F10=Left     F11=Right     F12=Cancel
  Scroll PAGE
  
```

Start page

The number of the first page to display.

Range: 1-99999

Default: 1

Number of pages

The number of pages to display. Specify an asterisk * to include all pages to the end of the document.

Range: *,1-99999

Default: 20

View size

A measure for the virtual paper size to be used for formatting. Specify a higher value when the formatting results are not satisfactory, and a lower value to see more data on a screen.

Range: 50-400

Default: 100

Example

Available commands

The following primary commands are available on this panel:

- FIND - see [FIND/FX primary command on page 1157](#)
- LOCATE - see [LOCATE primary command on page 1182](#)
- NEXTPAGE- this command is unique to the AFP Browse panel.
- PREVPAGE- this command is unique to the AFP Browse panel.

The NEXTPAGE primary command positions the display down to the beginning of the next page.

The PREVPAGE primary command positions the display up to the beginning of the previous page.

Parent panels

- [AFP Print Browse panel on page 730](#)

Child panels

- None.

Equivalent functions

- None.

Related tasks and examples

- [Browsing AFP Print documents on page 437](#)

AIX® Association Information panel

Panel and field definitions

Figure 182. AIX® Association Information panel

```

Process  Options  Help
-----
File Manager          AIX Association Information

AIX Catalog Entry:
  Data set name . . 'SYATES.UNITTEST.RFM0189.KSDS8.AIX1'
  Catalog ID . . . . 'CATALOG.SYSPLEXD.USER'

AIX Associations:
  Cluster . . . . . 'SYATES.UNITTEST.RFM0189.KSDS8'
  Data component . 'SYATES.UNITTEST.RFM0189.KSDS8.DATA'
  Index component  'SYATES.UNITTEST.RFM0189.KSDS8.INDEX'
  Path . . . . . 'SYATES.UNITTEST.RFM0189.KSDS8.AIX1PTH1'
  Path . . . . . 'SYATES.UNITTEST.RFM0189.KSDS8.AIX1PTH2'
  **** End of data ****

Command ==>
F1=Help      F2=Split    F3=Exit     F4=CRetriev F6=Info     F7=Up
F8=Down      F9=Swap     F10=Actions F12=Cancel

```

Parent panels

- [AIX Entry Detail panel on page 734](#)

Child panels

- None.

Equivalent functions

- None.

Related tasks and examples

- [Viewing association information on page 423](#)

AIX® Entry Detail panel

Panel and field definitions

Figure 183. (Part 1 of 2) AIX® Entry Detail panel

Process	Options	Help
File Manager		AIX Entry Detail
AIX Catalog Entry:		
Data set name . . .	'SYATES.UNITTEST.RFM0189.ESDS2.AIX1'	
Catalog ID	'CATALOG.UCATAPC'	
	More:	+
Basic Information:		
Creation date . . .	2003.351	Expiration date (NONE)
Data component . . .	'SYATES.UNITTEST.RFM0189.ESDS2.AIX1.DATA'	
Index component . . .	'SYATES.UNITTEST.RFM0189.ESDS2.AIX1.INDEX'	
AIX Associations:		
Cluster	'SYATES.UNITTEST.RFM0189.ESDS2'	
Data component . . .	'SYATES.UNITTEST.RFM0189.ESDS2.DATA'	
Path	'SYATES.UNITTEST.RFM0189.ESDS2.AIX1PTH1'	
SMS Attribute:		
SMS managed	Y	
AIX Attributes:		
CI size	20480	size of the data control intervals
Buffer space	41984	buffer space to be allocated at open time
Share options . . .	Cross region 1	Cross systems 3
Process options	Reuse N	Recovery . . Y
	Erase N	Extended . . N
	Upgrade . . . Y	Writecheck . N
F1=Help	F2=Split	F3=Exit
F8=Down	F9=Swap	F10=Actions
		F4=CRetriev
		F6=Assocs
		F7=Up
		F11=Stats
		F12=Cancel

Figure 184. (Part 2 of 2) AIX® Entry Detail panel

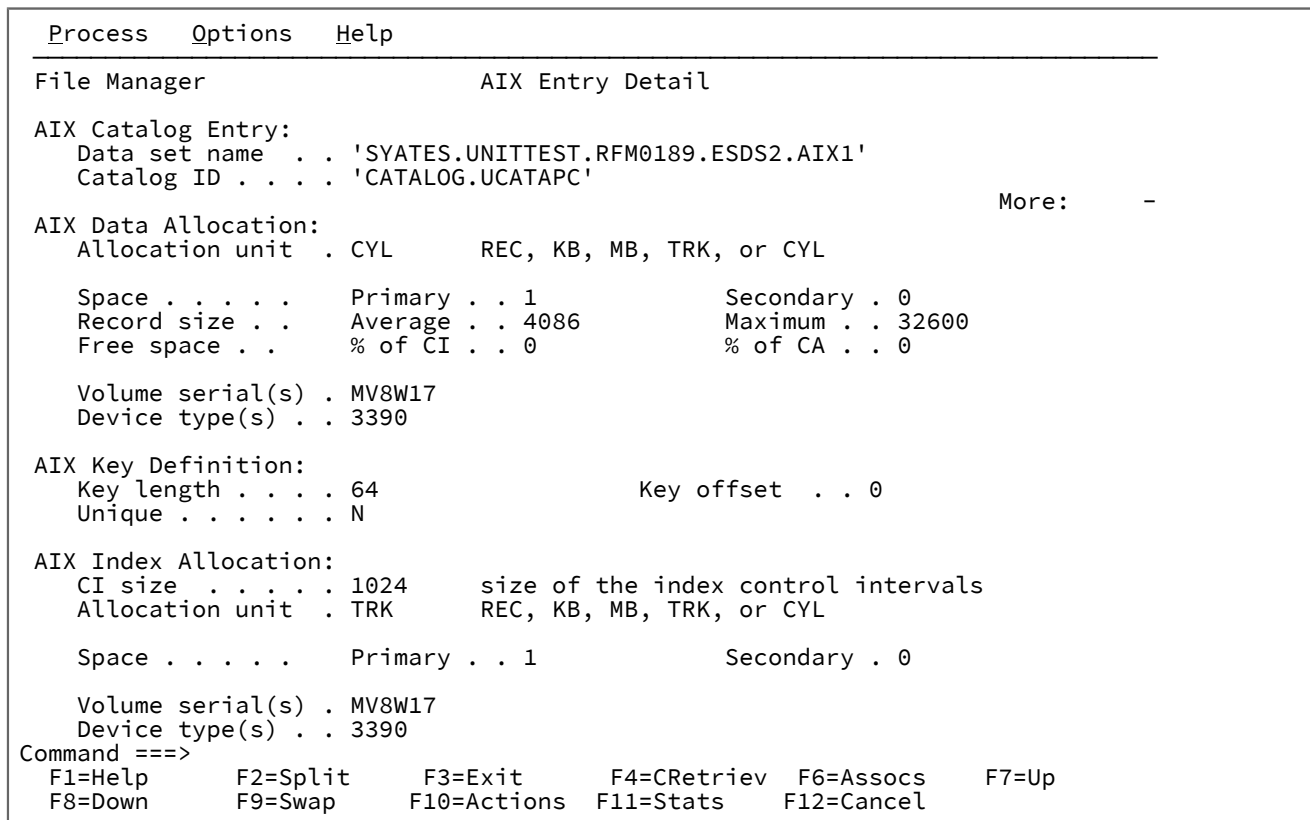

Example

Available commands

- [ASSOCS primary command on page 1120](#)
- [STATS primary command on page 1229](#)

Parent panels

- [Catalog Services panel on page 756](#)
- [Catalog Services Data Set List panel on page 759](#)

Child panels

- [AIX Association Information panel on page 733](#)

Related tasks and examples

- [Viewing your Catalog Entry Details on page 422](#)

Allocate panel

You use the Allocation panel to select the data set organization type for a new data set. File Manager displays this panel whenever you specify an output data set that does not exist, for example, as part of the Data Create or Copy process.

Panel and field definitions

Figure 185. Allocation panel

```

Process  Options  Help
-----
Allocate /u/testonly/xxx.txt

New Data Set Organization:
Select option      Instructions
- 1. KSDS          The above data set does not exist.
  2. ESDS          To define or allocate a new data set select a data
  3. RRDS          set organization and press ENTER or press PF3/EXIT
  4. VRRDS         or PF12/CANCEL to return without allocation.
  5. LDS
  6. Non VSAM
  7. IAM KSDS      For a new data set, enter a data set name
  8. IAM ESDS      below to copy existing allocation attributes.
  9. HFS

Existing Data Set:
Like data set . . . . . _____
Volume serial . . . . . _____

Command ==> _____
F1=Help      F2=Split    F3=Exit     F4=CRetrie v  F7=Backward  F8=Forward
F9=Swap      F10=Action s F12=Cancel

```

Allocate

Lists the new data set name that you are allocating.

New Data Set Organization

Option to select the data set organization type. Choose from:

1. KSDS

Key-sequenced data set. A type of VSAM data set that contains records in ascending collating sequence, and can be accessed by a field, called a key, or by a relative byte address.

2. ESDS

Entry-sequenced data set. A type of VSAM data set that contains records in the order in which they were entered. Records are added to the end of the data set, and can be accessed.

3. RRDS

Relative record data set. A type of VSAM data set that contains records in order by relative record number, and can be accessed only by this number. There are two types of RRDS: fixed-length and variable length. In this panel, the term RRDS refers specifically to the fixed-length type. However, in other situations where the types do not need to be differentiated, the term RRDS may be used for both types.

4. VRRDS

Variable length relative record data set. A type of VSAM data set that contains records in order by relative record number, and can be accessed only by this number. There are two types of RRDS: fixed-length and variable length. Within File Manager, the term VRRDS refers specifically to the variable-length type.

5. LDS

Linear data set. A type of VSAM data set that contains data that has no record boundaries. Linear data sets contain none of the control information that other VSAM data sets do and must be cataloged.

6. Non-VSAM

Allows you to specify a sequential or partitioned data set, using either an existing data set as a model, SMS class names and disk space requirements, or the system defaults.

7. IAM KSDS

Indexed Access Method - Key Sequence. A non-IBM data set type.

8. IAM ESDS

Indexed Access Method - Entry Sequence. A non-IBM data set type.

9. HFS

Hierarchical File System file. A non-z/OS file, processed in File Manager as a simulated QSAM/BSAM data set.



Note: File Manager only displays this option when you have specified an HFS path name (that is, a name starting with a "/>) in the **Data set/path name** field of the preceding panel.

Like data set

The name of an existing sequential or partitioned data set to be used as a model.

If you specify a mask in this field, File Manager displays the Model Data Set Selection panel listing the data sets matching the mask from which you can select the model data set.

The attributes of this data set are copied to the second allocation panel as the default values for your new data set.

Volume serial

The volume serial of an existing non-cataloged sequential or partitioned data set to be used as a model when option **6. Non-VSAM** has been selected.

You can only specify a volume serial if you have also specified a model data set (or mask) in the **Like data set** field.

Parent panels

- [Data Create Utility panel on page 824](#)
- [Copy To panel on page 796](#)

Child panels

- [VSAM Define panel on page 1099](#)
- [Allocate \(Two\) panel on page 739](#)
- [IAM KSDS Define panel on page 916](#)

Equivalent functions

- None.

Related tasks and examples

[Allocating a new data set on page 332](#)

Allocate (Two) panel

This is the second Allocate panel, in which you can define the attributes of a non-VSAM data set.

Panel and field definitions

Figure 186. Allocate (Two) panel

<u>P</u> rocess	<u>O</u> ptions	<u>H</u> elp
Allocate USERID.NEWD5		
Specify a model data set, SMS class names, or leave blank for defaults:		
Like data set . . .	_____	
Volume serial . . .	_____	
Device type . . .	_____	generic unit or device address
Data class . . .	_____	leave blank for default
Storage class . . .	_____	leave blank for default
Management class	_____	leave blank for default
Space Requirements:		
Space unit . . .	<u>TRK</u>	BLKS, TRKS, CYLS, KB, or MB
Primary units . . .	<u>5</u>	quantity of above units
Secondary units . . .	<u>5</u>	quantity of above units
Directory blocks	_____	leave blank for SMS default
Record format . . .	<u>FB</u>	if new format: U,F,V, or D, with B,S,A,M
Record length . . .	<u>50</u>	
Block size . . .	_____	physical output block size
Data set type . . .	<u>LIBRARY</u>	LIBRARY, PDS, BASIC, EXTR, EXTP or LARGE
Data set version	—	for data set name type
Max. generations	_____	maximum member generations for PDS/E V2
Allocate EAS . . .	<u>OPT</u>	blank, NO or OPT
Release unused . . .	<u>NO</u>	enter YES to free unused space, else NO
Expiration date . . .	_____	yyyy.ddd, blank for default
Command ==>		
F1=Help	F2=Split	F3=Exit
F9=Swap	F10=Actions	F12=Cancel
	F4=CRetriev	F7=Backward
		F8=Forward

Like data set

The name of an existing data set, to be used as a model for your new data set.

Volume serial

The volser of an existing data set, to be used as a model for your new data set.

Device type

Generic unit (EDT Esoteric Device Type) or device address. This field is mutually exclusive with the **Volume serial** field.

Data class

The name of a data class defined in your Storage Management System (SMS) installation. Do not enter a value on a system without SMS.

Storage class

The name of a storage class defined in your Storage Management System (SMS) installation. Do not enter a value on a system without SMS.

Management class

The name of a management class defined in your Storage Management System (SMS) installation. Do not enter a value on a system without SMS.

Space unit

Defines the unit of primary and secondary space to be allocated. A unit type is required, when a quantity is specified. Can be one of:

BLK

Block of average size.

KB

Kilobyte (1024 bytes).

MB

Megabyte (1048576 bytes).

TRK

Track of a direct access storage device (DASD).

CYL

Cylinder of a DASD.

Primary units

Amount of DASD space to be used for primary space allocation. The range depends on the space unit specified and the DASD device type.

Secondary units

Amount of DASD space to be used for secondary space allocations. The range depends on the space unit specified and the DASD device type.

Directory blocks

Number of blocks for the directory. You must specify a value when on a system without SMS, or when your SMS installation does not provide a default.

Range: 0-999999

Record format

Enter the record format, optionally followed by one or more attribute characters in the sequence shown.

F

Fixed

V

Variable

D

ASCII variable (tape only)

U

Undefined

Attribute characters:

B

Blocked

S

Spanned, V and D format only

A

with ANSI control characters

M

with machine code control characters.

If omitted, the record format of an old data set is not changed. For a new data set, the input record format (if any), or U is used.



Note: To create data with a record format not shown here, allocate the data set with the TSO ALLOCATE command to ddname QSAMOUT.

Record length

The length of the records to be created. Range is dependent upon the record format.

If the record format is VBS, the record length may be specified as 32768, meaning that you are defining an LRECL=X data set.

Block size

The average size of the physical blocks to be written.

Range: 0-32760

Data set type

Leave blank to request the system default data set type.

Library

Requests a PDSE. An active SMS is required.

PDS

Requests a PDS.

BASIC

Requests a basic sequential data set, which has a limit of 65535 tracks per volume.

LARGE

Requests a large format data set.

EXTR

Requests a extended format data set as required. An active SMS is required.

EXTP

Requests a extended format data set as preferred. An active SMS is required.

Data set version

The version number for a PDSE (data set type LIBRARY) or an extended format sequential data set (data set type EXTR or EXTP).

If zero is specified or the value is omitted the system default for the version is assigned.

Range: 0-2

Max. generations

The maximum number of generations maintained by the system for the members in a version 2 PDSE. The upper value might be limited by MAXGENS_LIMIT in the IGDSMSxx member of PARMLIB.

Range: 0-2000

Allocate EAS

Defines if a data set should be allocated in the Extended Addressing Space of an Extended Address Volume. Blanks indicate EATTR has not been specified.

NO

Cannot reside in an EAS.

OPT

Can optionally reside in an EAS.

Release unused

Specify YES to release any unused space when the data set is closed. The default is to keep the space allocated.

Expiration date

Use this field to protect valuable data by specifying a date from which the data set can be deleted. If you try to delete an unexpired data set, ISPF first displays a Confirm Delete panel followed by a Confirm Purge panel.

An expiration date is not required, but if you enter one it should be in one of these formats:

YYYY/MM/DD

Date shown in year, month, and day. The maximum expiration date allowed is 2155/12/31.

YYYY.DDD

Date shown in Julian format, such as 2026.066 for March 7, 2026. The maximum expiration date allowed is 2155.365. You can specify a DDD value of up to 366 if the YYYY value represents a leap year.

DDDD

The number of days, starting with the creation date, after which the data set can be deleted. DDDD has a range of 1 to 9999.

PERM, NOLIMIT, NEVER, 9999

Any one of these values is translated to a value of 1999.365. This is treated as permanent retention.

Parent panels

- [Allocate panel on page 737](#)

Child panels

- None.

Equivalent functions

- None.

Related tasks and examples

[Allocating a new data set on page 332](#)

Allocate (Three) panel

This is the third Allocate panel, in which you can define the attributes of an HFS file.

Panel and field definitions

Figure 187. Allocate (Three) panel

```

Process  Options  Help
-----
Allocate /u/testonly/xxx.txt

Specify attributes of a HFS file:

Select access level (0-7) for each class of users:
  Owner  . . . . 0
  Group  . . . . 0
  Other  . . . . 0
                                0 - No access
                                1 - Search access
                                2 - Write-only access
                                3 - Write and search access
                                4 - Read-only access
                                5 - Read and search access
                                6 - Read and write access
                                7 - Read, write, and search access

Command ==>
F1=Help      F2=Split    F3=Exit     F4=CRetriev F7=Backward F8=Forward
F9=Swap      F10=Actions F12=Cancel

```

Owner

Defines the access level to the created file for the owner. The access is specified by a number 0–7 (default 7). See below for details.

Group

Defines the access level to the created file for the group. The access is specified by a number 0–7 (default 7). See below for details.

Other

Defines the access level to the created file for other users. The access is specified by a number 0–7 (default 5). See below for details.

For each of the above classes of user, you specify the access level as 1–7:

0

No access

- 1
Search access
- 2
Write-only access
- 3
Write and search access
- 4
Read-only access
- 5
Read and search access
- 6
Read and write access
- 7
Read, write, and search access

Parent panels

- [Allocate panel on page 737](#)

Child panels

- None.

Equivalent functions

- None.

Related tasks and examples

- [Allocating a new data set on page 332](#)
- [Creating HFS files on page 500](#)

Append panel

Panel and field definitions

Figure 188. Append panel

Process	Options	Help
File Manager		
		Append
To Data set:		
Data set/path name	. . 'FMN.FMDATA'	
Member name (or mask)	
Volume serial	
Allocation Options:		
<u>1</u>	1. Allocate using the attributes of	
	'FMNUSER.DATA'	
	2. Specify allocation attributes	
Processing Options:		
ISPF Packing		Enter anything to select option
<u>1</u>	1. None	_ Binary mode, reclen _____
	2. Pack	
Command ==>		
F1=Help	F2=Split	F3=Exit
F9=Swap	F10=Actions	F12=Cancel
	F4=CRetrieve	F7=Backward
		F8=Forward

The **Allocation Options** are only required when the "To" data set does not exist.

The **Binary mode** and **reclen** parameters are only relevant for an HFS file.

Parent panels

Child panels

- [Allocate panel on page 737](#)
- [Allocate \(Two\) panel on page 739](#)
- [Allocate \(Three\) panel on page 744](#)

Equivalent functions

- None.

Related tasks and examples

- [Creating, replacing, and adding data using existing data on page 333](#)

Browse panel

You use the Browse panel to display a selected data set or data set member, scroll through the records and find specific information within the records.

The Browse panel displays different fields in the header area, depending upon the type of data set shown and whether or not a template has been used.

Panel and field definitions

Figure 189. Browse panel showing text file

Process	Options	Help					
Browse	FMN.V14R1M20.SFMNSAM1(FMNCDATA)		Record 0	Rec 0 of 40			
REC-TYPE	REC-ID	NAME	EMPLOYEE-NO	AGE	SALARY	Format TABL	
#2	#3 R # #4		#5	#6	#7	#8	
AN 1:2	AN 1:2	AN 3:20	BI 23:2	BI 25:2	PD 27:4	BI 31:4	
<>	<>	<-----1----->	<---->	<---->	<----->	<-----1>	
**** Top of data ****							
01	01	Grant Smith	7712	35	75000	6	
01	01	Andrew Apple	6645	53	78500	30	
01	01	Graham Prestcott	5583	28	48000	7	
01	01	Bill Somers	4418	33	68000	5	
01	01	Ted Dexter	3327	52	60250	14	
01	01	Roddy Armstrong	5683	34	77000	28	
01	01	Cliff Roberts	2265	57	100000	44	
01	01	James Browne	1117	46	125000	47	
01	01	Silvia Carrot	2308	29	61400	1	
01	01	Dan Peters	4479	54	63000	38	
01	01	John Laws	3422	21	46750	14	
01	01	Liz Childs	3439	55	66000	44	
Command ==>						Scroll PAGE	
F1=Help	F2=Zoom	F3=Exit	F4=CRetriev	F5=RFind	F7=Up		
F8=Down	F9=Swap	F10=Left	F11=Right	F12=Cancel			

Title

The Title identifies the function (Browse) and the data set being used. For a PDS or PDSE member the data set name includes the member name. Record number information, or short messages, appear to the right.

Record

The Record field shows the record number of the record that is currently at the top of the data area. You can scroll to a specific record by entering a new value in this field.



Note: The number shown is that of the record within the entire data set, regardless of any restrictions, such as selection criteria, that you may have used to limit the display of records.

The default value for this field is 0, which positions the display before the first record. When the field contains 0, the data area displays the

```
**** Top of data ****
```

message. Once you have scrolled away from this position, you cannot return to it by typing 0 in the Record field. Instead you need to enter a scrolling command, such as TOP, to return to 0.

Col

The Col field shows the column number of the column that is currently at the far left of the data area. You can scroll to a specific column (left or right) by typing a new value. The default value for this field is 1.

Scale

The Scale shows the columns of the data area.

Data Area

The Data Area shows the data in the selected display format. For a description of the different display formats, see [Selecting a display format on page 105](#).

Command

The Command line is a field in which you can enter Primary Commands, such as FIND.

Scroll

The Scroll field defines the current scroll amount. You can type a new value.

When a VSAM data set is displayed, additional fields can be seen.

Figure 190. Browse panel showing VSAM data set

Browse		FMN.REQ77.RRDS			Rec 0	
		Type	RRDS	Slot		Format CHAR
RBA	Col 1	Len				
80	80	01	Tyrone Dallas	.0...	-

Type

The type of VSAM data set, for example, RRDS. IAM files are also indicated.

Slot

The slot number of the currently selected RRDS file. You can type a new value in this field to move to a new file.

RBA

The Relative Byte Address of the currently selected RRDS file.

Column Headings

The Scale shows the column headings for the RBA (Relative Byte Address) and Len (Record Length) of each RRDS file in the data set.

When the VSAM data set is a KSDS file, the Key field can be used to position yourself within the data set.

Figure 191. VSAM KSDS data set

Browse		FMN.REQ77.KSDS			At top	
		Type	KSDS	Key		Format CHAR
RBA	Col 1	Len				
0	64	00000010	AAAb			
64	64	00000020	AAA			

Key

If the value you enter contains leading, embedded or trailing blanks, commas or quotation marks, it must be enclosed in quotation marks. You may also enter a hexadecimal string enclosed in quotation marks and preceded by X or x, for example, `x'c1c2'`. The maximum number of characters, including any required characters, is 250.

When your cursor is in this field, you can use the LEFT/RIGHT commands to scroll within the field (function keys F10/F11). You can also use the EXPAND function (F4), to open the Key field in a window.

When a data set is displayed in TABL format with a template, the column headings show the field names defined in the template.

Figure 192. PDSE member in TABL format

Browse		FMN.V14R1M20.SFMNSAM1(FMNCDATA)				Rec 0 of 40	
REC-TYPE	NAME	EMPLOYEE-NO	AGE	SALARY	MONTH(1)	MONTH(2)	Format TABL
#2	#3	#4	#5	#6	#7	#7	#7
AN 1:2	AN 3:20	BI 23:2	BI 25:2	PD 27:4	BI 31:4	BI 35:4	
<>	<---+---1---+--->	<---+>	<---+>	<---+--->	<---+--->	<---+--->	
01	Grant Smith	7712	96	75000	6	15	

When a data set is displayed in SNGL format with a template, the field and record number of the current record is shown.

Figure 193. PDSE in SNGL format

Browse		FMN.V14R1M20.SFMNSAM1(FMNCDATA)				Rec 21 of 40	
Current type is REC-TYPE02		Top Line is 1		of 7		in Record 21	
Ref	Field	Picture	Typ	Start	Len	Data	Format SNGL
2	REC-TYPE	XX	AN	1	2	02	
3	NAME	X(20)	AN	3	20	Grant Smith	
5	ADDR1	X(20)	AN	37	20	22 Montrose St	
6	ADDR2	X(20)	AN	57	20	Thornlie	
7	POSTCODE	X(4)	AN	77	4	6145	
**** End of record ****							

Example

Available commands

- [BOTTOM](#) primary command on page 1122
- [CANCEL](#) primary command on page 1124
- [CEDIT](#) primary command on page 1128
- [DEDIT](#) primary command on page 1142
- [DOWN](#) primary command on page 1146
- [END](#) primary command on page 1148
- [EXCLUDE/XX](#) primary command on page 1148
- [EXIT](#) primary command on page 1153
- [FE \(Find Error\)](#) primary command on page 1154
- [FILE](#) primary command on page 1157
- [FIND/FX](#) primary command on page 1157
- [FORMAT](#) primary command on page 1170
- [HEX](#) primary command on page 1172
- [JUST](#) primary command on page 1177
- [LEFT](#) primary command on page 1178
- [LOCATE](#) primary command on page 1182

- [NEXT primary command on page 1191](#)
- [NEXTREC primary command on page 1192](#)
- [OFFSET primary command on page 1193](#)
- [PIC primary command on page 1197](#)
- [PREVIOUS primary command on page 1198](#)
- [PREVREC primary command on page 1199](#)
- [RBALEN primary command on page 1200](#)
- [RECLLEN primary command on page 1204](#)
- [PROFILE primary command on page 1200](#)
- [RD primary command on page 1201](#)
- [RDF primary command on page 1203](#)
- [RECSTATS primary command on page 1205](#)
- [REFS primary command on page 1206](#)
- [RESET primary command on page 1208](#)
- [RFIND primary command on page 1211](#)
- [RIGHT primary command on page 1212](#)
- [RP primary command on page 1214](#)
- [SHADOW primary command on page 1220](#)
- [SHOW \(REC\) primary command on page 1222](#)
- [SLOC primary command on page 1224](#)
- [SORT primary command on page 1224](#)
- [STR primary command on page 1228](#)
- [TEDIT primary command on page 1231](#)
- [TOP primary command on page 1232](#)
- [TVIEW primary command on page 1233](#)
- [TYPE primary command on page 1233](#)
- [UP primary command on page 1234](#)
- [VIEW primary command on page 1237](#)
- [ZOOM primary command on page 1239](#)

Parent panels

- [Browse Entry panel on page 751](#)

Child panels

From the Browse panel, you can use primary commands to access the following panels:

- [Template Workbench panel on page 1072 \(TVIEW\).](#)
- [Record Type Selection panel on page 998 \(TEDIT - panel displays when template contains more than one record type\).](#)
- [Field Selection/Edit panel on page 891 \(TEDIT - panel displays when using a copybook template with only one record type\).](#)

- [Dynamic Template panel on page 845](#) (TEDIT - panel displays when using a dynamic template).
- [Record Selection Criteria panel on page 991](#) (CEDIT).
- [Record Identification Criteria panel on page 982](#) (CEDIT ID).

Equivalent functions

- [DSB \(Data Set Browse\) on page 1293](#)

Related tasks and examples

- [Viewing and changing data sets on page 87](#)
- [Manipulating your view of the data on page 103](#)
- [Viewing segmented data on page 314](#)
- [Segmented data templates on page 177](#)

Browse Entry panel

You use the Browse Entry panel to select a data set for viewing in the Browse panel.

Panel and field definitions

Figure 194. Browse Entry panel

```

  Process  Options  Help
  -----
File Manager                Browse Entry Panel

Input Partitioned, Sequential or VSAM Data Set, or HFS file:
Data set/path name 'MACHIND.SEQ1M' +
Member . . . . . _____ Blank or pattern for member list
Volume serial . . _____ If not cataloged
Start position . . _____ +
Record limit . . . _____ Record sampling _

Copybook or Template:
Data set name . . 'FMN.TEMPLATE'
Member . . . . . 'TEST01' Blank or pattern for member list

Processing Options:
Copybook/template  Start position type  Enter "/" to select option
 3 1. Above         - 1. Key             - Edit template  _ Type (1,2,S)
  2. Previous      - 2. RBA            - Include only selected records
  3. None          - 3. Record number - Binary mode, reclen _____
  4. Create dynamic 4. Formatted key

Command ==>
F1=Help      F2=Split    F3=Exit     F4=Expand   F7=Backward F8=Forward
F9=Swap      F10=Left   F11=Right  F12=Cancel

```

Data set/path name

Can be a fully-qualified data set name or a pattern, an HFS file or directory, a WebSphere® MQ queue name, or a CICS® resource.

For information about specifying a WebSphere® MQ queue name, see [Specifying an MQ manager or queue on page 48](#).

For information about specifying a CICS® resource, see [Specifying a CICS resource on page 48](#).

The data set name may include a member name or name pattern in parenthesis. If the member is specified here, the associated **Member** field must be empty.

When you specify an HFS file or directory, you must enter a full path name. If the path name is longer than the displayed entry field, press the Expand function key (F4) to display a pop-up window in which you can enter a longer name.

Member

If you specified the name of a partitioned data set (PDS) without including a member name or name pattern in parenthesis in the **Data set name** field, then you can use this field to specify the member name or a member name pattern.

Volume serial

Serial number of the volume which contains the data set. Required for data sets which are not cataloged.

Start position

Initial starting position for the data set to be browsed. The initial display is positioned at the specified record.

The default is the top of the data set. You can enter a negative record to indicate the number of records before the end of file. For example, to see just the last record on the file, enter -1 as the start point.

The format of the start position field is either numeric or character, depending upon the type of start position selected. For VSAM KSDS Key values, if the value you enter contains leading, embedded or trailing blanks, commas or quotation marks, it must be enclosed in quotation marks. You may also enter a hexadecimal string enclosed in quotation marks and preceded by X or x, for example, `x'c1c2'`. The maximum number of characters, including any required characters, is 250.

When your cursor is in this field, you can use the LEFT/RIGHT commands to scroll within the field (function keys F10/F11). You can also use the EXPAND function (F4), to open the key field in a window.



Note: The Erase EOF key only works on the displayed part of the key. When the key being displayed is larger than the field area on the screen, you must either scroll or expand the field to erase the unseen portions.

For all other data set formats, a valid unsigned number must be entered.

To specify a starting position as the number of records before the end of file, enter a negative record number. For example, to see just the last record on the file, enter a start position of -1.

If you specify a starting position, you should also specify the **Start position type** in the Processing Options. If you do not, File Manager assumes that the value provided in the Starting position field is a record number.

VSAM - KSDS: Key value

If the key is not matched, the record with a key greater than the value given is specified. If the key value is greater than the last record in the data set, the initial position is the "End of data" marker.

VSAM - ESDS: RBA (Relative Byte Address) Value

If the RBA is not matched, the record with a RBA greater than the value given is specified. If the RBA value is greater than that of the last record in the data set, the initial position is the “End of data” marker.

VSAM - RRDS: Slot value

If the slot number is greater than the last used slot in the data set, the initial position is the “End of data” marker.

QSAM: Record Number

If the Record Number is greater than that of the last record in the data set, the initial position is the “End of data” marker.

HFS

As for QSAM.

Record limit

This field restricts the number of records retrieved from a data set (from the start point or top) resulting in an edit or browse of a portion of the data set. You can use the keyword “*MEMORY*” as a record limit to restrict the number of records retrieved to as many as will fit comfortably in the available virtual storage.

The default start position is the top of the data set.

Record Sampling

Indicates whether you want record sampling to be performed on the data set. If you select this option, File Manager displays the Record Sampling panel.

Copybook or Template

Data set name and Member name of the template or copybook to be used to format your data.



Note: In the case of a copybook, this can be the name of a CA-Panvalet library, or a library accessed using the Library Management System Exit.

Copybook/template usage

Indicates if you want to use a template for a logical view of the data.

1

Use the template specified on the panel (or compile the specified copybook into a template, and use that).

2

Use the last template associated with the data set.

3

No logical view is to be used by the function.

4

Create a dynamic template.

Start position type

Determines how File Manager interprets the value provided in the Starting position field. If the Start position type is not specified, File Manager assumes that the value is a Record Number.

1. KEY

Only valid when the data set is a VSAM KSDS, VSAM AIX® or VSAM PATH.

2. RBA

Only valid when the data set is a VSAM KSDS, VSAM AIX® or VSAM ESDS.

3. Record Number

Default. Valid for any type of supported data set.

4. Formatted key

Only valid when the data set is a VSAM KSDS, VSAM AIX®, or VSAM PATH and when a template is provided. This displays the formatted key positioning panel.



Note: For templates with more than one layout, a 01 selection list is displayed first.

Edit template

Indicates if you want to edit the template before use. You edit the template when you need to change format, selection, data create attributes, and reformatting information for output copy templates.

Specify one of the following values:

blank

Invoke the current function without editing the template.

/

Edit the specified template. F3 will return to the entry panel and clear this option.

A

Always edit the specified template. When the template edit session is completed, F3 will invoke the current function. F12 will cancel the template edit session and return to the entry panel.

R

Edit the template and use the RUNTEMP command (F6) to invoke the current function. Exiting the function will re-edit the template. From the template edit session:

- Press F6 to rerun the function.
- Press F3 to save changes and return to the entry panel.
- Press F12 to discard changes and return to the entry panel.

Type (1,2,S)

The type of editing you want to perform.

You can specify one of the following values:

1

Edit the Record Identification Criteria by field first

2

Edit the Record Selection Criteria by field first

S

Edit the source definition for a template using the advanced copybook selection facility.

This option is ignored when editing a dynamic template.

Include only selected records

When the Edit or Browse session is either in-storage (a record limit of *MEMORY* is used, or omitted and set on by means of this option) or when you have selected **Record Sampling**, only the records selected by template processing are included in the Edit or Browse session.

This option does not alter the operation of edit or browse if a template is not used.

Binary mode

When processing an HFS file, allows you to specify binary mode (selected) or text mode (unselected).

reclen

When processing an HFS file and the **Binary mode** option is selected, records are derived based on the fixed record length specified. The default is 80.

Can be in the range: 1–32760

Use I/O exit

Allows you to specify a user I/O exit for compressed or encrypted data sets.

This option has two fields. To select the option, enter */* in the field to the left of Use I/O exit. With this selected, you can then specify which exit to use in the field to the right of the field label.

**Note:**



1. The fields only display if File Manager is installed with the option **USEIOX=ENABLE**, and the **Exit enabled** field (in the Set System Processing Options panel) is set to YES. If a default is specified with either of those options, it is displayed in the field to the right of [Use I/O exit](#).
2. I/O exits can only be used to process the data sets that you are using. They cannot be used to process the copybook or template that you are using to format the data set.

Parent panels

- [Primary Option Menu panel on page 970](#)

Child panels

Depending upon the options selected in the Browse Entry panel, the next panel displayed can be:

- [Browse panel on page 746](#)
- [Data Set Selection panel on page 829](#) (a pattern has been entered in the Data set name field)
- [Member Selection panel on page 946](#) (a pattern or a blank has been entered in the Member field)
- [Record Type Selection panel on page 998](#) (Edit Template is selected and the specified template was based on a copybook with more than one record type).
- [Field Selection/Edit panel on page 891](#) (Edit Template is selected and the specified template was based on a copybook with only one record type).
- [Dynamic Template panel on page 845](#) (Create Dynamic option is selected or Edit Template is selected and the specified template was created dynamically).
- [Record Sampling panel on page 988](#) (Record Sampling option selected)
- [Personal Data Set List panel on page 966](#) (Current® Data Set List option selected from the Process drop-down menu, or REFL fastpath command entered).
- [Personal Data Set Lists panel on page 968](#) (Personal Data Set Lists option selected from the Process drop-down menu, or REFD fastpath command entered).

Equivalent functions

- [DSB \(Data Set Browse\) on page 1293](#)

Related tasks and examples

- [Supplying a procedure when using a File Manager panel on page 530](#)
- [Starting an editor session without using templates on page 89](#)

Catalog Services panel

The Catalog Services panel is used to list or print catalog entries, and to invoke IDCAMS commands or other File Manager options for catalog entries.

Panel and field definitions

Figure 195. Catalog Services panel

Process	Options	Help
File Manager	Catalog Services	
blank	List catalog entries	A Alter catalog entry
DEF	Define catalog entry	DEL Delete catalog entry
I	Display entry information	P Print catalog entries
Data Set:		
Data set name	. 'FMNUSER.EXPORT'	
Catalog ID	. .	
Processing Options:		
Entry Type		
3	1. Any	5. Alias
	2. Non-VSAM	6. Cluster
	3. VSAM	7. Data
	4. AIX	
	8. GDG	11. Page space
	9. Index	12. Path
	10. OAM	13. User catalog
Enter "/" to select option		
-	Batch execution / with list	
-	Include Additional Qualifiers	
-	YY/MM/DD date format (def. YYYY.DDD)	
-	Processing limit @	
Command ==>		
F1=Help	F2=Split	F3=Exit
F9=Swap	F10=Actions	F12=Cancel
	F4=CRetriev	F7=Backward
	F8=Forward	

Data Set

Describes the data set to be processed:

Data set name

The data set name to be used as the target of the catalog service you have requested. For the list and print services, you can specify a generic data set name.

Catalog ID

The catalog to be searched in place of using the system catalog search order.

Processing Options

Entry type

Restricts the catalog search to the specified type. The effect of this option depends on the catalog service that has been requested. For all services except DEFINE, it simply restricts the search to entries of the specified type and is useful with the list or print service and a generic data set specification. With the DEFINE service, it predetermines or restricts the type of entry to be defined. If the type is ambiguous (Any, VSAM, Cluster, Data, or Index), File Manager displays a pop-up panel from which you can specify a specific entry type to be defined.

Batch execution

Presents the JCL to run the LIST, PRINT, DEFINE, or DELETE functions in batch. You can edit the JCL before submitting it. Use the Set Batch Job Card Information panel to tailor the default JOB card that File Manager uses to generate JCL.

with list

Used in conjunction with the **Batch execution** option. File Manager first displays a data set list matching the entered data set name allowing you to specify DEFINE or DELETE functions using prefix commands to produce JCL for a data set selected from the list.

Include Additional Qualifiers

When selected, generates the data set list with all data sets matching the qualifiers in the **Data set name** field, including data sets with additional qualifiers.

When not selected, the data set list is restricted to only include data sets with the qualifiers entered in the **Data set name field**. Data sets with additional qualifiers are not included.

YY/MM/DD date format (def. YYYY.DDD)

When selected, causes all dates on the Data Set List panel and listing to be shown as YY/MM/DD instead of the default YYYY.DDD.

Processing limit

When selected, only the specified number of entries are processed for display or print.

Parent panels

- [Utility Functions menu panel on page 1077](#)

Child panels

- [AIX Entry Detail panel on page 734](#)
- [Catalog Services Data Set List panel on page 759](#)
- [Delete Entry panel on page 834](#)
- [GDG Entry Detail panel on page 910](#)
- [IAM KSDS Define panel on page 916](#)
- [IAM Entry Details panel on page 917](#)
- [Non-VSAM Entry Detail panel on page 957](#)
- [Path Entry Detail panel on page 959](#)
- [VSAM Define panel on page 1099](#)
- [VSAM Entry Detail panel on page 1102](#)

Equivalent functions

- [SCS \(Catalog Services\) on page 1547](#)

Related tasks and examples

- [Managing catalog entries on page 415](#)

Catalog Services Data Set List panel

Panel and field definitions

Figure 196. Catalog Services: list of catalog entries (initial display)

Process		Options		Help	
File Manager		Data Set List		Row 00001 of 00027	
Catalog ID ''				Types ALL	
	Data Set Name	Type	Volume	MV	Creat ±
	PAM.V99R1M0.S*	*	*	*	*
	PAM.V99R1M0.SPAMCLIB	NVSAM	D\$FM08		19/02
	PAM.V99R1M0.SPAMDBRM	NVSAM	D\$FM09		19/02
	PAM.V99R1M0.SPAMEXEC	NVSAM	D\$FM10		19/02
	PAM.V99R1M0.SPAMMAC1	NVSAM	D\$FM00		19/02
	PAM.V99R1M0.SPAMMENU	NVSAM	D\$FM19		19/02
	PAM.V99R1M0.SPAMMJPN	NVSAM	D\$FM09		19/02
	PAM.V99R1M0.SPAMMKOR	NVSAM	D\$FM03		19/02
	PAM.V99R1M0.SPAMMODA	NVSAM	D\$FM02		19/02
	PAM.V99R1M0.SPAMMODJ	NVSAM	D\$FM00		19/02
	PAM.V99R1M0.SPAMMODK	NVSAM	D\$FM10		19/02
	PAM.V99R1M0.SPAMMOD1	NVSAM	D\$FM09		19/02
	PAM.V99R1M0.SPAMMOD2	NVSAM	D\$FM04		19/02
	PAM.V99R1M0.SPAMPENU	NVSAM	D\$FM09		19/02
	PAM.V99R1M0.SPAMPJPN	NVSAM	D\$FM16		19/02
	PAM.V99R1M0.SPAMPKOR	NVSAM	D\$FM13		19/02
Command	===>			Scroll PAGE	
F1=Help	F2=Split	F3=Exit	F4=CRetriev	F5=RFind	F6=Process
F7=Up	F8=Down	F9=Swap	F10=Left	F11=Right	F12=Cancel

Example

Available commands

In addition to the commands listed in [Manipulating your view of the data on page 103](#), the following primary command is available on this panel:

- [AMSMSG primary command on page 1118](#)

The line commands you can use with a list of catalog entries are:

AFP

Displays AFP (LIST3820) data using the File Manager AFP utility.

ALTER (A)

Lets you alter the parameters for the selected entry. A panel is displayed on which you can change parameters for the entry, as described in [Managing catalog entries on page 415](#).

To run the ALTER command in batch, first select the **Batch execution** option on the Catalog Services panel

BROWSE (B)

If the selected entry is an OAM object collection or a catalog, invokes the appropriate File Manager list option (Object Directory List or Catalog Services); otherwise, invokes Browse.

COPY (C)

Copies the selected entry. Invokes the Copy Utility (3.3) with the *“from”* data set prefilled to the selected data set.

DEFINE (DEF)

Lets you define a new entry that is similar to the selected entry. A panel is displayed on which you enter the name of the new entry. You can also change the parameters (copied from the existing entry), as described in [Managing catalog entries on page 415](#).

To run the DEFINE command in batch, first select the **Batch execution** option on the Catalog Services panel

DELETE (DEL)

Deletes the selected entry.

To run the DELETE command in batch, first select the **Batch execution** option on the Catalog Services panel

EDIT (ED)

Invokes Edit (option 2).

EXTENTS (EX)

For a data set entry, lists the statistics and extent information in the catalog.

INFO (I)

Displays the Non-VSAM Entry Detail panel or VSAM Entry Detail panel. Synonymous with **LIST**. If entered for a catalog, reinvokes catalog services to list the contents of the catalog. For all other catalog entries, displays the details and, for VSAM entries, also statistics and allocation information. The information displayed is the same as would be displayed for the selected entry using the information service from the entry panel.

LIST (L)

If the selected entry is a catalog, invokes Catalog Services for that catalog; otherwise, lists the parameters for the selected entry. Synonymous with **INFO**.

MEMBER (M)

If entered for a library data set entry, displays a member list.

PRINT (P)

Invokes Print Utility (option 3.2).

RECALL (REC)

If the selected entry has been migrated or archived, this command recalls the data set.

RENAME (R)

This is a synonym for Alter with non-VSAM data sets and it works identically. For VSAM data sets it invokes a separate VSAM Entry Rename panel.

VIEW (V)

Invokes AFP Print Browse (option 3.7) for non-VSAM data sets.



Note: Only use this command for data sets that contain data in Advanced Function Printing™ (LIST3820) format.

Line commands work differently according to the type of catalog entry. [Table 22: File Manager line commands available for different types of entries on page 761](#) shows the line commands that are available.

Table 22. File Manager line commands available for different types of entries

	Alter	Define	Delete	List	Browse	Edit	Print	View	Extents	Info
AIX®	yes	yes	yes	yes			yes		yes	yes
Alias		yes	yes	yes						
Cluster ²	yes	yes	yes ³	yes	yes	yes	yes		yes	yes
GDG		yes	yes	yes						
Non-VSAM	yes	yes	yes	yes	yes	yes	yes	yes	yes	yes
OAM				yes	yes ⁴					
Path	yes	yes	yes	yes	yes ⁵	yes ⁵	yes			
PGSPC				yes					yes	yes
UCAT				yes ⁶					yes	yes

 **Note:**

2. Represents the types: CLUST, DATA, ESDS, INDEX, KSDS, LDS, RRDS, and VRRDS. "CLUST" is only shown for a base component that has a DATA or INDEX component catalog error.
3. You can delete a cluster, but the deletion attempt might fail if the cluster is large or complicated (for example, with more than 1 AIX® or more than 20 volsers per component).
4. Object Directory List (option 6.1).
5. Is only successful if the path is defined over a base cluster rather than an alternate index.
6. Catalog Services is invoked again to list the entries in a catalog.

Table 22. File Manager line commands available for different types of entries

(continued)

	Alter	Define	Delete	List	Browse	Edit	Print	View	Extents	Info
	1. A blank space means that the line command is not available. 2. The word “yes” means that the line command is available.									

Parent panels

- [AIX Entry Detail panel on page 734](#)
- [Delete Entry panel on page 834](#)
- [GDG Entry Detail panel on page 910](#)
- [IAM KSDS Define panel on page 916](#)
- [IAM Entry Details panel on page 917](#)
- [Non-VSAM Entry Detail panel on page 957](#)
- [Path Entry Detail panel on page 959](#)
- [VSAM Define panel on page 1099](#)
- [VSAM Entry Detail panel on page 1102](#)

Equivalent functions

- [SCS \(Catalog Services\) on page 1547](#)

Related tasks and examples

- [Managing catalog entries on page 415](#)
- [Manipulating your view of selection lists on page 62](#)

Clipboard Manager panel

The Clipboard Manager panel lets you see and modify the clipboards available to the PASTE primary command. Clipboards are created using the CUT primary command in edit.

User Comment

The name of the clipboard.

Parent panels

- [Editor panel on page 853](#)

Child panels

None

Related tasks and examples

- [Copying data to and from a clipboard on page 167](#)

Compare Utility: "Old" and "New" panels

The Compare Utility "Old" and Compare Utility "New" panels are used to specify the "Old" and "New" data sets in the comparison, and the conditions that form the *compare* subsets. Optionally, you can also specify the name of the copybooks or templates that describe logical views of the data sets and further refine the "Old" and "New" compare sets.

Both panels contain the same fields.

Panel and field definitions

Figure 198. Compare Utility - "Old" data set entry panel

<u>P</u> rocess	<u>O</u> ptions	<u>H</u> elp
File Manager	Compare Utility	Top of data More:
"Old" Partitioned, Sequential or VSAM Data Set, or HFS file:		
Data set/path name . . .	COPYBOOK	+
Member	FMNCCPY	(Blank or pattern for member list)
Volume serial	_____	
Start key	_____	key or slot
Skip count	_____	number of records to be skipped
Compare count	ALL	number of records to be compared
"Old" Copybook or Template:		
Data set name	_____	
Member	_____	
Processing Options:		
Copybook/template usage	Enter "/" to select option	
3 1. Above	_ Edit template _ Type (1,2,S)	
2. Previous	_ Advanced member selection	
3. None	_ Skip member name list	
4. Create dynamic	_ Batch execution	
	_ Binary mode, reclen _____	
Command ==>		
F1=Help	F2=Split	F3=Exit
F4=Forward	F5=Swap	F6=Actions
		F7=Backward
		F8=Cancel

"Old" (or "New") Partitioned, Sequential or VSAM Data Set, or HFS file

You can use this panel to specify the data set, HFS file, WebSphere® MQ queue name, or a CICS® resource to be compared, and to define which records are to be compared. It contains:

Data set/path name

Can be a fully-qualified data set name or a pattern, an HFS file or directory, a WebSphere® MQ queue name, or a CICS® resource.

For information about specifying a WebSphere® MQ queue name, see [Specifying an MQ manager or queue on page 48](#).

For information about specifying a CICS® resource, see [Specifying a CICS resource on page 48](#).

The data set name may include a member name or name pattern in parenthesis. If the member is specified here, the associated **Member** field must be empty.

When you specify an HFS file or directory, you must enter a full path name. If the path name is longer than the displayed entry field, press the Expand function key (F4) to display a pop-up window in which you can enter a longer name.

Member

If you specified the name of a partitioned data set (PDS) without including a member name or name pattern in parenthesis in the **Data set name** field, then you can use this field to specify the member name or a member name pattern.



Note: The specification of a "New" member depends on the specification of an "Old" member. If the "Old" member specifies one member, the "New" member must also point to one member. If the "Old" member specifies a member name pattern, the "New" member must use the same pattern or an "*".

Volume

Specify a volume serial number if the data set is not cataloged.

Start key

VSAM only. Works in conjunction with **Skip count** to specify the first record from the data set to be included in the compare set.

If a start key or slot number is applicable to the data set, records are skipped until a record with a key or slot number greater than or equal to the specified value in the Start key field is found. If the key contains lowercase characters, blanks, or commas, enclose it in quotation marks. Keys can also be in hexadecimal format (for example, X'0102').

Skip count

Works in conjunction with **Start key** to specify the first record from the data set to be included in the compare set.

The number of records specified in the Skip count field is skipped after the start key or slot number (if applicable) has been honored.

Compare count

This field sets a limit on the number of records in the final compare sets that are included in the comparison.

"Old" (or "New") Copybook or Template

These fields identify either a copybook or a template. If a copybook is specified, it is compiled to create a temporary template that can optionally be saved if edit was requested.



Note: In the case of a copybook, this can be the name of a CA-Panvalet library, or a library accessed using the Library Management System Exit.

Processing Options

The processing options enable you to specify and modify a template that describes the logical view of your data set. The options are:

Copybook/template Usage

1. Above

Enter 1 to invoke data set compare with the specified copybook or template.

2. Previous

Enter 2 to invoke data set compare with the template last used with the specified input data set.

3. None

Enter 3 to invoke data set compare without a template.

4. Create dynamic

Enter 4 to create a dynamic template to be used when comparing.

Edit template

Specify / to edit the template before use. See [Creating and editing templates on page 173](#) for detailed information about creating and editing templates.

Type (1,2,S)

The type of editing you want to perform.

You can specify one of the following values:

1

Edit the Record Identification Criteria by field first

2

Edit the Record Selection Criteria by field first

S

Edit the source definition for a template using the advanced copybook selection facility.

This option is ignored when editing a dynamic template.

Advanced member selection

Enter "/" to specify a range of members to be selected rather than a specific or generic member name.

Skip member name list

Enter "/" to run without showing the member selection list.

Batch execution

Specify / to generate and edit a batch job to perform the comparison. For more information on editing these statements, see [DSM \(Data Set Compare\) on page 1388](#).



Note: This option is only available on the "Old" compare panel.

Binary mode

When processing an HFS file, allows you to specify binary mode (selected) or text mode (unselected).

reclen

When processing an HFS file and the **Binary mode** option is selected, records are derived based on the fixed record length specified. The default is 80.

Can be in the range: 1–32760

Use I/O exit

Allows you to specify a user I/O exit for compressed or encrypted data sets.

This option has two fields. To select the option, enter "/" in the field to the left of Use I/O exit. With this selected, you can then specify which exit to use in the field to the right of the field label.



Note:



1. The field only displays if File Manager is installed with the option **USEIOX=ENABLE**, and the **Exit enabled** field (in the Set System Processing Options panel) is set to YES. If a default is specified with either of those options, it is displayed in the field to the right of Use I/O exit.
2. I/O exits can only be used to process the data sets that you are using. They cannot be used to process the copybook or template that you are using to format the data set.

Parent panels

The Compare Utility: "Old" panel is accessed from the [Utility Functions menu panel on page 1077](#). The Compare Utility: "New" panel can only be accessed from the "Old" panel.

Child panels

- [Compare Utility: Options panel on page 773](#) (the "Old" and "New" data sets and templates, if specified, were fully qualified)
- [Data Set Selection panel on page 829](#) (a pattern has been entered in the Data set name field)
- [Member Selection panel on page 946](#) (a pattern or a blank has been entered in the Member field)
- [Record Type Selection panel on page 998](#) (Edit Template is selected and the specified template was based on a copybook with more than one record type).
- [Field Selection/Edit panel on page 891](#) (Edit Template is selected and the specified template was based on a copybook with only one record type).
- [Dynamic Template panel on page 845](#) (Create Dynamic option is selected or Edit Template is selected and the specified template was created dynamically).
- [Personal Data Set List panel on page 966](#) (Current® Data Set List option selected from the Process drop-down menu, or REFL fastpath command entered).
- [Personal Data Set Lists panel on page 968](#) (Personal Data Set Lists option selected from the Process drop-down menu, or REFD fastpath command entered).

Equivalent functions

- [DSM \(Data Set Compare\) on page 1388](#)

Related tasks and examples

- [Comparing data sets on page 381](#)

Compare Utility: Load module options panel

The Compare Utility - Load module options panel ([Figure 199: Compare Utility: Load module options panel on page 769](#)) allows you to specify the way in which the load module comparison is processed and the type of listing produced.

Panel and field definitions

Figure 199. Compare Utility: Load module options panel

Process	Options	Help
FMNPDSML ger	Compare Utility : Load Module Options	
		More: +
Compare Options:		
Compare level	Listing type	Long Report
<u>2</u> 1. Module	<u>2</u> 1. Summary	Enter "/" to exclude
2. CSECT	2. Delta	- Inserted
	3. Matching	- Deleted
	4. Long	- Changed
	5. None	- Matched
		Exclude + /
CSECTs . . . <u>cee*</u>		
Load module criteria:		
Enter "/" to select option		
<u>/</u> Size		CSECT criteria:
<u>/</u> Entry point address		Enter "/" to select option
<u>/</u> Linkage editor/Binder		<u>/</u> Size
<u>/</u> Link date and time		<u>/</u> Address
<u>/</u> AMode/RMode		<u>/</u> Compiler
<u>/</u> AC		<u>/</u> Compile date
<u>/</u> Link attributes		<u>/</u> AMode/RMode
		<u>/</u> IDR ZAP data
		- Text
		<u>/</u> Compile Options
		- Program Attributes
Processing Options:		
Enter "/" to select option		
<u>/</u> Clear print data set		Listing Options:
		Enter "/" to select option
		<u>/</u> Wide listing
		<u>/</u> Highlight changes
		- Show changed fields only
		<u>/</u> YY/MM/DD (default: YYYY.DDD)
		Number of differences to report <u>ALL</u>
Command ==>		
F1=Help	F2=Split	F3=Exit
F9=Swap	F10=Actions	F12=Cancel
	F4=CRetriev	F7=Backward
		F8=Forward

Compare Options

Compare Level

1. Module

Only information on the load module level is extracted and compared. CSECT information (and differences on CSECT level) are ignored. This is a general comparison.

2. CSECT

Information on both levels, load module and CSECT, is extracted and compared. This is a more detailed comparison.

Listing type

1. Summary

Generates a summary listing only.

2. Delta

Generates a delta listing containing all deleted and inserted records, as well as a summary.

3. Matching

Generates a listing containing only matching records, and a summary. Matching records are only listed once.

4. Long

Generates a listing containing all matching and non-matching records. Matching records are only listed once.

5. None

Suppresses the listing. A message is issued to indicate whether or not the data sets match.

Long Report

Selecting one or more of these options causes the compare result types to be excluded from the report. These options are used in conjunction with the **Long** listing type to tailor the output report. If a listing type other than **Long** has been selected, these options are ignored.

Inserted

When selected, excludes inserted records from the report.

Deleted

When selected, excludes deleted records from the report.

Changed

When selected, excludes changed records from the report.

Matched

When selected, excludes matched records from the report.

MQ Processing

Include descriptors

If this is selected (with the / character), the message descriptor data returned by the GET MQ API is added as a prefix to the record data, allowing this data to be examined in conjunction with the message data.

Otherwise only the message data is available for processing.

CSECTs

Specify string values used to filter the CSECTs to be included in or excluded from compare processing. If this field is blank all CSECTs will be included for comparison.

Multiple string arguments can be entered. Use the comma character as a delimiter between the strings. Strings can contain the * and % wildcard characters.

To specify a filter containing lowercase characters, use a character string in the format `c'string'`. Filters can also be specified as hexadecimal strings in the format `x'hex-digits'`.

The following is an example of a filter that would include or exclude from processing Language Environment and COBOL runtime CSECTs from a load module containing an LE-enabled COBOL program:

```
CEE*,IGZ*
```

Exclude

Specify / to exclude CSECTs with names that match the specified CSECT filters from being compared. If this option is not selected the filters are used to include only those CSECTs with matching names for comparison.

Load module criteria

Selecting one or more of these options determines which load module properties are compared and reported. By deselecting some of the options, you exclude associated information from comparison. In this way, only differences of interest to you are shown; others are hidden.

Size

Specify / to include the load module size in the comparison.

Entry point address

Specify / to include the load module entry point address in the comparison.

Linkage editor/Binder:

Specify / to include the version of the linkage editor or binder used to prepare the load module in the comparison.

Link date and time:

Specify / to include the load module link (bind) date and time in the comparison.

AMode/RMode:

Specify / to include the AMODE and RMODE of the load module in the comparison.

AC:

Specify / to include the load module authorization code in the comparison.

Link attributes

Specify / to include the load module link attributes in the comparison.

CSECT criteria

Selecting one or more of these options determines which CSECT properties are compared and reported. By deselecting some of the options, you exclude associated information from comparison. In this way, only

differences of interest to you are shown; others are hidden. These options are used in conjunction with the Compare level option. If CSECT has not been selected, these options are ignored.

Size

Specify / to include the CSECT size in the comparison.

Address

Specify / to include the CSECT address in the comparison.

Compiler:

Specify / to include the version of the language compilers used to compile the CSECT in the comparison.

Date:

Specify / to include the date of the CSECT compile in the comparison.

AMode/RMode:

Specify / to include the AMODE and RMODE of the CSECT in the comparison.

IDR ZAP data:

Specify / to include AMSPZAP IDR data in the comparison. Note that the IDR ZAP data constitutes separate records to be compared, but as it is associated with the CSECT, the IDR ZAP data should be seen as an extension of the CSECT data.

Text

Specify / to include the CSECT content in the comparison. Note that the CSECT content is compared and then reported as a set of separate 32-byte records in "memory dump" format (hexadecimal and character), but as it is associated with the CSECT, the CSECT content should be seen as an extension of the CSECT data. If you select this option, the wide listing option is set to accommodate the dump format that is required for comparison.

Compile Options

Specify / to activate comparison of CSECT compiler options.

Program Attributes

Specify / to activate comparison of program language attributes.

Processing Options

Clear print data set

Specify / to clear the print data set before use. This option has no effect if print output from File Manager is not directed to a data set. See [Setting your Print Processing Options on page 403](#) for more information about controlling the print data set.

Listing Options

Wide listing

Specify / to generate a wide listing. Wide listing is easier to analyze as the corresponding data in the "New" and "Old" records are vertically aligned and the width of the record does not exceed the maximum record length supported by the printer.

Highlight changes

Specify / to highlight any differences between "Old" and "New" records. For record comparisons and wide formatted comparisons, the differences are indicated with a change bar (|) beneath the altered bytes. For narrow formatted comparisons, the fields that have changed are indicated by placing an asterisk (*) to the left of the field name.

Show changed fields only

Specify / to report only changed fields (for a narrow-formatted report).

YY/MM/DD (default: YYYY.DDD)

Specify / to show dates in YY/MM/DD format. Otherwise, YYYY.DDD is used.

Number of differences to report

The number of differences after which the Compare Utility stops processing the data sets.

Parent panels

The Compare Utility: "New" panel.

Child panels

- None.

Equivalent functions

- [DSM \(Data Set Compare\) on page 1388](#)

Related tasks and examples

- [Comparing data sets on page 381](#)

Compare Utility: Options panel

The Compare Utility - Options panel ([Figure 199: Compare Utility: Load module options panel on page 769](#)) is used to specify the way in which the comparison is processed and the type of listing produced.

Panel and field definitions

Figure 200. Compare Utility : Options panel

Process	Options	Help
File Manager		
Compare Utility : Options		
Compare Options:		
Compare type	Synchronization	Listing type
<u>2</u> 1. Record	<u>4</u> 1. One-to-one	<u>2</u> 1. Summary
2. Formatted	2. Read-ahead	2. Delta
	3. Keyed	3. Matching
MQ Processing	4. Read-ahead	4. Long
- Include descriptors	Keyed	5. None
		Long Report
		Enter "/" to exclude
		- Inserted
		- Deleted
		- Changed
		- Matched
Processing Options:		
Enter "/" to select option		
- Edit template mapping		
<u>/</u> Clear print data set		
- Create result data sets		
<u>/</u> Ignore record length mismatch		
- Left justify numeric fields		
- Sort before compare		
ISPF Packing		
<u>2</u> 1. Unpack if packed		
2. None		
3. Skip		
Listing Options:		
Enter "/" to select option		
<u>/</u> Wide listing		
- Show hex chars		
<u>/</u> Highlight changes		
- Show field attributes		
- Show changed fields only		
- Always show SELECTed fields		
- Suppress fields Inserted/Deleted		
Number of differences to report <u>ALL</u>		
Template Reporting Options:		
Enter "/" to select option		
- Show template layouts		
- Show template criteria		
- Show mapped fields		
<u>/</u> Show unmapped fields		
- Show array elements		
- Show start/end as hex offset		
- Show length in hex		
<u>/</u> Show field statistics		
Command ===>		
F1=Help	F2=Split	F3=Exit
F9=Swap	F10=Actions	F12=Cancel
	F4=CRetriev	F7=Backward
	F8=Forward	

Compare Options

Compare Type

Choose either Record comparison or Formatted comparison.

1. Record

When the record comparison option is selected, pairs of records (determined by the record selection criteria and synchronization method) are compared byte by byte. For the records to match, the corresponding bytes in each record must be the same and either the record lengths are equal or the pad option has been specified and the trailing bytes equal the pad character.

To use record identification and selection criteria to filter the records to be compared, specify a copybook or template for either the "Old" or the "New" data set or both.



Note: To perform a "record" comparison restricted to certain columns in the records, use dynamic templates to define the areas in the records to be compared using data type AN.

2. Formatted

When the formatted comparison option is selected, mapped pairs of fields (from each pair of records selected by the record selection criteria and synchronization method) are compared, according to the format defined for each field. For the records to match, every pair of mapped fields must match.

To specify field mapping, you must specify a copybook or template for both the "Old" and the "New" data sets. Optionally, you can also use the copybooks or templates to specify record identification and selection criteria to filter the records to be compared.

When this option is selected, pressing Enter displays the Formatted Comparison Options panel, in which you can specify additional comparison options. The display of this panel is "delayed" if read-ahead or keyed synchronization is requested, because the sub-option panels for synchronization are displayed first.

Figure 201. Formatted Comparison Options panel

```

Process  Options  Help
-----  -
F        Formatted Comparison Options
C
Specify additional options for formatted comparison.

  Ignore leading blanks in character fields . . . -
  Ignore trailing blanks in character fields . . . -
  Match reformatted character fields . . . . . -
  Ignore case in character fields . . . . . -

Press ENTER to perform formatted comparison.
Press EXIT or CANCEL to return to the options panel.
P Command ==>
  F1=Help      F2=Split    F3=Exit     F7=Backward
  F8=Forward   F9=Swap     F12=Cancel

Batch execution          Highlight changes
                          Show field attributes

Command ==>
F1=Help    F2=Split  F3=Exit   F4=CRetrieve
F7=Backward F8=Forward F9=Swap   F10=Actions
F12=Cancel

```

Panel fields:

Ignore leading blanks in character fields

Select this option if you want leading blanks to be ignored when character comparisons are performed. This option is ignored if you also select the Match reformatted character fields option, because that option also causes leading blanks to be ignored.

Ignore trailing blanks in character fields

Select this option if you want trailing blanks to be ignored when character comparisons are performed. This option is ignored if you also select the Match reformatted character fields option because that option also causes trailing blanks to be ignored.

Match reformatted character fields

Select this option if you want character fields to use a reformatted comparison method. Using this option, character fields match as if leading and trailing blanks were stripped, and all sequences of intermediate blanks were compressed to a single blank. The ignore leading and trailing blanks options are ignored if you select this option.

Ignore case in character fields

Select this option if you want character fields to match regardless of the case of the data being compared. Using this option character fields match as if all the alphabetic characters were converted to upper case.

Synchronization

1. One-to-one

The compare sets are assumed to contain records in a corresponding sequence.

2. Read-ahead

The compare sets are assumed to contain records in *roughly* corresponding sequences.

When this option is selected, pressing Enter displays an additional panel in which you can specify the Read-ahead synchronization limit and the Read-ahead synchronization length.

Figure 202. Read-ahead Synchronization Limit panel

```

Process  Options  Help
-----  -
F      |----- Read-ahead Synchronization Options -----|
C      |Specify additional options for read-ahead synchronization.|
      |
      |  Read-ahead synchronization limit . . . . . 100
      |  Read-ahead synchronization length . . . . . 1
      |
      |Press ENTER to perform read-ahead comparison.
      |Press EXIT or CANCEL to return to the options panel.
      |Command ==> _____|
P      |F1=Help      F2=Split    F3=Exit     F7=Backward
      |F8=Forward   F9=Swap     F12=Cancel
      |
      |  Edit template mapping      Wide listing
      |  Clear print data set      Show hex chars
      | / Create result data sets / Highlight changes
      |                          Show field attributes
      | ISPF Packing              Show changed fields only
      | 1 1. Unpack if packed     Always show SELECTed fields
      | 2. None
      |Command ==>
      |F1=Help      F2=Split    F3=Exit     F4=CRetriev  F7=Backward
      |F8=Forward   F9=Swap     F10=Actions F12=Cancel

```

Panel fields:

Read-ahead synchronization limit

Range: 1–999. Specifies the number of records to read ahead in each compare set.

Read-ahead synchronization length

Range: 1–99. Specifies the number of records that must match during read-ahead processing for synchronization to occur.

When non-matching records are found by the compare utility and read-ahead synchronization was specified, File Manager attempts to resynchronize the data by looking ahead in each of the data sets. The read-ahead length is the minimum number of matching records that must be found to recognize a resynchronization point. If insufficient matching records are found, read-ahead processing continues.

3. Keyed

The compare sets are assumed to be sequenced by a key, which consists of one or more segments of the record (up to sixteen).

When this option is selected, pressing Enter displays the Keyed Synchronization Settings panel, in which you must specify at least one key segment (and up to sixteen key segments). Any existing key segment information, such as that drawn

from an intrinsically keyed data set or from key sequences specified in the "Old" or "New" templates, or both, is displayed in the panel. You can edit or modify these details.

Figure 203. Keyed Synchronization Settings panel - no key segment information

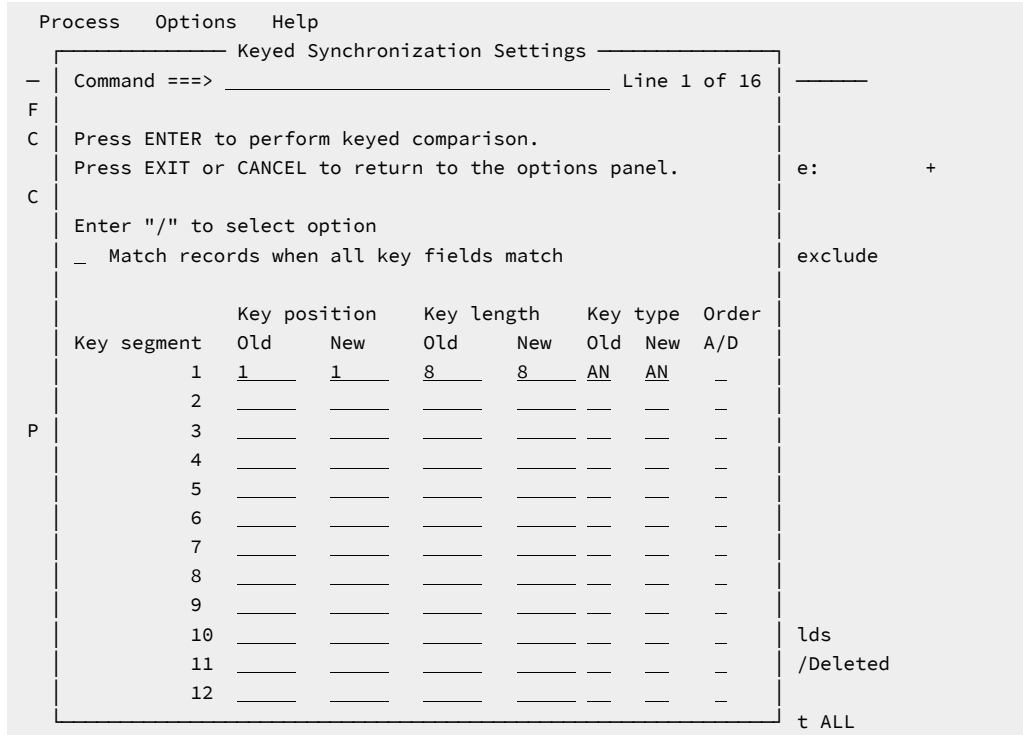

Panel fields:

Match records when all key fields match

Enter / to match records when all the key fields match.

Key position - Old

Range: 1-32760. Specifies the position of a key segment in the "Old" compare set records for keyed synchronization.

Key position - New

Range: 1-32760. Specifies the position of a key segment in the "New" compare set records for keyed synchronization.

Key length - Old

Range: 1-32760. Specifies the length of a key segment in the "Old" compare set records for keyed synchronization.

Key length - New

Range: 1-32760. Specifies the length of a key segment in the "New" compare set records for keyed synchronization. Defaults to the old key length. If it is specified and the length is different from the old

length, the shorter key is padded with hex zeros in alphanumeric fields; or the shorter key is padded with the pad character (normally a blank) in alphanumeric fields if the system pad option is on, before comparisons are performed.

Key type - Old

Specifies the type of a key segment in the “Old” compare set records for keyed synchronization. The data type of the key segment must be one of the following data types:

AN

Alphanumeric

CH

Character (same as alphanumeric)

BI

Binary

PD

Packed decimal

FP

Internal floating point

ZD

Zoned decimal

Default: **AN**.

Key type - New

Specifies the type of a key segment in the “New” compare set records for keyed synchronization. For the types that are supported, see [Key type - Old on page 779](#). If you do not provide the type, the default is the old type.



Note: If either old or new is a numeric key type, a numeric comparison is performed and a key field is considered in error if it cannot be converted for numeric comparison.

Order (A/D)

Default: **A**. Specify **A** for ascending. Specify **D** for descending.

4. Read-ahead Keyed

This option is similar to Read-ahead except the fact that instead of record matching, key field matching is performed when synchronizing records. As a result, it can detect changes to records that match according to key field data but differ according to record comparison. Therefore, both the [Figure 202: Read-ahead Synchronization Limit panel on page 777](#) and the [Figure 203: Keyed Synchronization Settings panel - no key segment information on page 778](#) will be displayed when this option is selected. The order field that is described in [Figure 203: Keyed Synchronization Settings panel - no key segment information on page 778](#) will be protected because it is ignored for Read-ahead Keyed.

Listing type

1. Summary

Generates a summary listing only.

2. Delta

Generates a delta listing containing all deleted and inserted records, and a summary.

3. Matching

Generates a listing containing only matching records, and a summary. Matching records are only listed once.

4. Long

Generates a listing containing all matching and non-matching records. Matching records are only listed once.

5. None

Suppresses the listing. A message is issued instead to indicate whether or not the data sets matched.

Long Report

Selecting one or more of these options causes those compare result types to be excluded from the report. These options are used in conjunction with the **Long** listing type to tailor the output report. If a listing type other than **Long** has been selected, these options are ignored.

Inserted

When selected, excludes inserted records from the report.

Deleted

When selected, excludes deleted records from the report.

Changed

When selected, excludes changed records from the report.

Matched

When selected, excludes matched records from the report.

Processing Options**Edit template mapping**

Specify / to edit the template mapping before use. This option is only available if a copybook or template was specified for both the “Old” and “New” data sets, and is only valid if a formatted comparison is requested. See [Creating and editing templates on page 173](#) for detailed information about creating and editing templates and [Comparing data sets on page 381](#) for details on using templates during the compare process.

Clear print data set

Specify / to clear the File Manager print data set before use. This option has no effect if File Manager print output is not directed to a data set. See [Setting your Print Processing Options on page 403](#) for more information about controlling the print data set.

Create result data sets

Specify / to create one or more output data sets. These data sets are specified on the Compare Utility: Output Data Sets panel.

Ignore record length mismatch

Enter "/" to ignore length mismatches with the template. If you do not select this option, records that are shorter or longer than the matching structure length in the template are not selected for processing.

Left justify numeric fields

If you specify "/" for this option and you have selected a Compare Type of **Formatted**, numeric fields are shown as left-justified.

Sort before compare

Enter "/" to have File Manager sort both the old and new data sets before compare processing starts. This option is only valid if the Record Synchronization option is set to either Keyed or Read-ahead Keyed. The data sets are sorted based on the keys defined in the Keyed Synchronization Settings panel.

A sort request is ignored if the old or new data set has any of the following characteristics:

- RECFM=U
- VSAM linear file
- VSAM file with maximum record length greater than 32K
- QSAM spanned file with a record length greater than 32K
- The template indicates that the file has segmented records
- PDS or PDSE file

A sort request is also ignored when any of the following conditions is true:

- I/O exits are used to process the data sets
- The comparison involves MQ queues
- The comparison involves remote files
- The comparison involves HFS files

Listing Options

Wide listing

Specify / to generate a wide listing. Wide listings are not suitable for printing if the width of the record or the width of the formatted data exceeds the maximum record length supported by the printer, but they can make it easier to analyze as the corresponding data in the "New" and "Old" records are vertically aligned.

Wide listings can accommodate records not exceeding 32K bytes in length. Longer records are truncated, but still marked correctly when changed.

Show hex chars

Specify / to generate a hexadecimal display of the records or formatted fields in addition to the standard character display.



Note: The Compare Utility and DCM function always use the UPDOWN format for hexadecimal display, regardless of the setting of the DUMP option in your Set Print Processing Options (option 0.1).

Highlight changes

Specify / to highlight any differences between "Old" and "New" records. For record comparisons and wide formatted comparisons, the differences are indicated by placing a "change bar" (|) beneath the altered bytes. For narrow formatted comparisons the fields that have changed are indicated by placing an asterisk (*) to the left of the field name.



Note: For altered numeric fields in a wide formatted comparison the change bars always indicate the entire field because the display characters do not necessarily correspond to individual bytes in the data.

Show field attributes

Specify / to show field attributes in formatted comparison reports. For a wide listing, leaving this option unchecked reduces the overall width of the report. For a narrow listing, leaving this option unchecked provides more space in the formatted field area for the field name and data. This option has no effect for record type comparisons.

Show changed fields only

Specify / to report only changed fields if a narrow formatted report. This option has no effect for record type comparisons.

Always show SELECTed fields

Specify / to show SELECTed fields in formatted comparison reports. The option is intended to allow you to ensure that certain fields that you have SELECTed are always printed, regardless of whether they are changed or not. This option has effect only if the **Show changed fields only** option has been selected and only if the SELECTed fields have been mapped.

Suppress Inserted/Deleted fields

Specify / to suppress the field reporting on the inserted and deleted fields when the **Show changed fields only** is selected.

ISPF Packing

Provided that the data set is a sequential, PDS or PDSE file and an I/O exit routine is not used, one of these options can be used to control the comparison behavior when processing data that is in ISPF PACK format.

1. Unpack

If the data set is packed, it is unpacked before any processing or comparison is performed.

2. None

No checking or processing of ISPF packed data occurs. Packed records are processed and compared in packed format. This option is forced if an I/O exit has been used.

3. Skip

If the input data is packed, no processing or comparison occurs.

Template Reporting Options

These options control the template details reported by the Compare utility. If any of the template reporting options are specified, and template information participated in the comparison, a report of the relevant requested information appears after the comparison summary. If none of the template reporting options are specified, or no options relevant to the comparison are specified, no template information is reported.

Show template layouts

Specify / to show template field details in comparison reports. For each template used in the comparison, the template fields are listed with their attributes.

This option has no effect for record type comparisons, because template field information is not used in record type comparisons.

Show template criteria

Specify / to show template identification and selection criteria in comparison reports. For each template used in the comparison, the identification and selection criteria, if any, are listed.

Show mapped fields

Specify / to show how fields in the new data set template are mapped to fields in the old data set template.

This option has no effect for record type comparisons, because template mapping information is not used in record type comparisons.

Show unmapped fields

Specify / to show fields in the old and new data set templates that are not mapped to fields in the other template.

This option has no effect for record type comparisons, because template mapping information is not used in record type comparisons.

Show array elements

Specify / to show all occurrences of array elements in layouts. Array elements are not shown in mappings because mapping at the array element level is not supported.

For COBOL OCCURS DEPENDING ON tables, the maximum occurrences are shown.

For PL/1 REFER arrays, the minimum occurrences are shown.

Show start/end as hex offset

Specify / to show the start and end values as hexadecimal offsets in layouts and mappings.

Show length in hex

Specify / to show the length values as hexadecimal in layouts and mappings.

Show field statistics

Specify / to produce a field statistics report showing the number and percentage of mismatches by field.

Number of differences to report

The number of differences after which the Compare Utility stops processing the data sets.

Parent panels

- Compare Utility: "New" panel

Child panels

- [Compare Utility: Output Data Sets on page 785](#)

Equivalent functions

- [DSM \(Data Set Compare\) on page 1388](#)

Related tasks and examples

- [Comparing data sets on page 381](#)

Compare Utility: Output Data Sets

The Compare Utility: Output Data Sets panel is used to specify the output data sets for containing records identified as inserted, deleted, changed, or matching that result from running the Compare Utility.



Note: You can use the same output definition to write both Inserted and New Changed records to the same output file. You can use the same output definition to write both Deleted and Old Changed records to the same output file.

Panel and field definitions

Figure 204. Compare Utility: Output Data Sets panel

<u>P</u> rocess	<u>O</u> ptions	<u>H</u> elp
File Manager Compare Utility : Output Data Sets		
Output Partitioned, Sequential or VSAM Data Set, or HFS file:		
Inserted Records		
Data set name	_____	+
Member	_____	
Volume	_____	
Disposition. . .	_____ 1. Old or reuse 2. Mod	
Binary mode. . .	Reclen _____	
Deleted Records		
Data set name	_____	+
Member	_____	
Volume	_____	
Disposition. . .	_____ 1. Old or reuse 2. Mod	
Binary mode. . .	Reclen _____	
New Changed Records		
Data set name	_____	+
Member	_____	
Volume	_____	
Disposition. . .	_____ 1. Old or reuse 2. Mod	
Binary mode. . .	Reclen _____	
Old Changed Records		
Data set name	_____	+
Member	_____	
Volume	_____	
Disposition. . .	_____ 1. Old or reuse 2. Mod	
Binary mode. . .	Reclen _____	
New Matched Records		
Data set name	_____	+
Member	_____	
Volume	_____	
Disposition. . .	_____ 1. Old or reuse 2. Mod	
Binary mode. . .	Reclen _____	
Old Matched Records		
Data set name	_____	+
Member	_____	
Volume	_____	
Disposition. . .	_____ 1. Old or reuse 2. Mod	
Binary mode. . .	Reclen _____	
Command ==> _____		
F1=Help	F2=Split	F3=Exit
F9=Swap	F10=Actions	F12=Cancel
F4=Expand	F7=Backward	F8=Forward

Data set name

Specify a sequential, partitioned or VSAM data set, or HFS file. You can specify a generic data set name to select from a list.

Member name

Specify for a partitioned data set. Enter a blank or a pattern for a member selection list.

Volume

Specify a volume serial number if the data set is not cataloged.

Disposition:**Old or Reuse**

Copies from the beginning of the existing data set.

Mod

Appends the input records to the end of the data set. MOD is invalid for a member of a partitioned data set.

Binary mode

Data in an HFS file is processed without record delimiters (in binary mode). If the option is *not* selected, the data is assumed to be text and is processed as a collection of records delimited by EBCDIC New Line (X'15'), Carriage Return (X'25'), Line Feed (X'0D'), or their combinations.

Reclen

The logical record length used to deblock data into fixed records if **Binary mode** has been selected. The default record length is 80.

Parent panels

[Compare Utility: Options panel on page 773](#)

Child panels

- None.

Equivalent functions

- None.

Related tasks and examples

- [Comparing data sets on page 381](#)

Compiler Language Selection panel

Panel and field definitions

Figure 205. Compiler Language Selection

Process	Options	Help
File Manager		
Compiler Language Selection		
Language Selection:		
Specify Default Compiler		
<u>1</u>	1. COBOL	Use the COBOL compiler
	2. PL/I	Use the PL/I compiler
	3. Auto detect	Determine which compiler to use
	4. HLASM	Use the HLASM compiler
Processing Options:		
Enter "/" to select option		
<input type="checkbox"/>	Override compiler options for template update	
<input type="checkbox"/>	Preserve copybook library	
<input type="checkbox"/>	Show copybook name with record type field name	
<input type="checkbox"/>	Suppress boundary field errors	
Command ==>		
F1=Help	F2=Split	F3=Exit
F9=Swap	F10=Actions	F12=Cancel
	F4=CRetriev	F7=Backward
	F8=Forward	

Language Selection

The language used for compiling a copybook to create a template.

COBOL

Use the COBOL compiler. This is the default.

PL/I

Use the PL/I compiler.

Auto detect

Analyze the source to determine whether the language of the source is COBOL or PL/I to use the appropriate compiler



Note: Selecting Auto detect may increase processing time of your copybooks.

HLASM

Use the HLASM compiler.

Processing Options

Override compiler options for template update

When selected, overrides the compiler options found in the template being updated with the current compiler options.

Foreground processing always overrides the compiler options for older templates that do not contain compiler options.

You should select this option for batch template update of older templates to generate compiler options in the JCL.

Preserve copybook library

Ensures that, if a copybook still exists in the library that it was previously found in and that library is in the list that the update is using, then that version of the copybook is used.

If you do not select this option, or the copybook no longer exists in the library it was previously found in, or that library is not in the list the update is using, then the utility searches the libraries in the order they are listed and uses the first version of the copybook that it finds.

Show copybook name with record type field name

Select this option to make the copybook name for a record layout visible during template edit and for an edit, view or browse session where a copybook or template is being used.



Note: For the editor session where the layout name is specified it is prefixed with the name of the associated copybook. This may cause the layout name to be truncated, depending on its length.

Suppress boundary field errors

Select this option to suppress in SNGL display format the display or printing of fields that start beyond the current record boundary.

Parent panels

- [Set Processing Options panel on page 1029](#)
- [Set Language and Compiler Specifications \(option 0.5\) on page 1021](#)

Child panels

- None.

Equivalent functions

- None.

Related tasks and examples

- [Template types and structure on page 173](#)
- [Overriding Compiler Options on page 206](#)

Copy From panel

You use the Copy From panel to specify the data set from which you want to copy records, the number of records to be copied, whether or not a template is to be used and various other processing options.

Panel and field definitions

Figure 206. Copy Utility: "From" panel

Process	Options	Help
File Manager		
Copy Utility		
From Partitioned, Sequential or VSAM Data Set, or HFS file:		
Data set/path name . . .	'FMNUSER.EXPORT'	+
Member	_____	(Blank or pattern for member list)
Volume serial	_____	(If not cataloged)
Start key	_____	key or slot
Skip count	_____	Include _____ Repeat skip _____
Copy count	ALL	number of records to be copied
From Copybook or Template:		
Data set name	'FMNUSER.DATA'	
Member	TEMPA	(Blank or pattern for member)
Processing Options:		
Copybook/template	Enter "/" to select option	
2 1. Above	— Batch execution	— Advanced member selection
2. None	— Use proc _____	— Skip member name list
3. Create dynamic	— Ignore length mismatch	— REXX member selection: P
— Edit template	— JCL Source format	— Directory integrity
— Type (1,2,S)	— MQ Include descriptor	— Report PDS record counts
Export/Import	— MQ Get destructive	— Binary mode, reclen _____
— 1. XML 2. CSV 3. CSV Import		
Command ==>		
F1=Help	F2=Split	F3=Exit
F9=Swap	F10=Actions	F12=Cancel
	F4=Expand	F7=Backward
		F8=Forward

From data set/file: Data set/path name

Specify the data set to be copied. Can be a fully-qualified data set name or a pattern, an HFS file or directory, a WebSphere® MQ queue name, or a CICS® resource.

For information about specifying a WebSphere® MQ queue name, see [Specifying an MQ manager or queue on page 48](#).

For information about specifying a CICS® resource, see [Specifying a CICS resource on page 48](#).

The data set name may include a member name or name pattern in parenthesis. If the member is specified here, the associated **Member** field must be empty.

When you specify an HFS file or directory, you must enter a full path name. If the path name is longer than the displayed entry field, press the Expand function key (F4) to display a pop-up window in which you can enter a longer name.

From Data Set: Member

If you specified the name of a partitioned data set (PDS) without including a member name or name pattern in parenthesis in the **Data set name** field, then you can use this field to specify the member name or a member name pattern.

Volume serial

Serial number of the volume which contains the data set to be copied. Required for data sets which are not cataloged.

Start key

Specifies the start position for the records to be copied (VSAM data sets only). Copying starts either at the first record with a key or slot number greater than or equal to the specified value in the Start key field, or after skipping the number of records specified in the Skip count field. If the key contains lowercase characters, blanks, or commas, enclose it in quotation marks. Keys may also be in hexadecimal format (e.g. X'0102').

The Start key and Skip count fields are mutually exclusive.

Skip count

Number of logical records to be skipped from the beginning of the file. By default processing begins with the first record in the file.

Range: 0-99999999. Default: 0.

Include

Represents the number of physical records that to be included in a repeating sample from a data set. Both **Include** and **Repeat Skip** fields must have non-zero values for sampling to take effect.

Range: 0-9999999. Default: 0.

Repeat skip

Represents the number of physical records to be skipped in a repeating sample from a data set. Both **Include** and **Repeat Skip** fields must have non-zero values for sampling to take effect.

Range: 0-9999999. Default: 0.

Copy count

Specify the number of logical records to be copied.

Range: 1-99999999, ALL. Default: ALL.

From Copybook or Template: Data set name

Data set name of the template or copybook to be used to select and format the data to be copied. This field is ignored when the Copybook/template usage field is set to **2. None**.



Note: In the case of a copybook, this can be the name of a CA-Panvalet library, or a library accessed using the Library Management System Exit.

From Copybook or Template: Member

If you specified the name of a partitioned data set (PDS) or CA-Panvalet or other external library in the **Data set name** field, then use this field to specify the member name or member name pattern. This field is ignored when the Copybook/template usage field is set to **2. None**.

Copybook/template usage

Indicates if you want to use a template to format and select your data.

1. Above

Use the template specified on the panel (or compile the specified copybook into a template, and use that).

2. None

No logical view is to be used by the function.

3. Create dynamic

Create a dynamic template.

Edit template

Indicates that you want to edit the template before use. You edit the template when you need to change format, selection, data create attributes, and reformatting information for output copy templates.

Type (1,2,S)

The type of editing you want to perform.

You can specify one of the following values:

1

Edit the Record Identification Criteria by field first

2

Edit the Record Selection Criteria by field first

S

Edit the source definition for a template using the advanced copybook selection facility.

This option is ignored when editing a dynamic template.

Export/Import

Indicates whether the data is to be exported or imported.

(blank)

No export nor import operation during the copy.

1. XML

Export the data in XML format.

2. CSV

Export the data in CSV (comma-separated values) format.

3. CSV Import

Import the CSV data set.



Note: A template or copybook is required to perform an export or import operation.

Batch Execution

Allows you to edit the JCL to run the function in batch.

Use proc

Allows you to specify a procedure (containing REXX or DFSORT statements or both) to run in conjunction with the Copy action.

This option has two fields. To select the option, enter "/" in the field to the left of **Use proc**. With this selected, you can then specify which procedure to use in the field to the right of the field label (the proc name field). In the name field you can perform either of these actions:

- Enter a temporary procedure for one-time use, by entering a single asterisk (*). File Manager displays an Edit panel that you can use to create a new procedure.
- Specify the name of the member containing the procedure you want to use. The member must belong to the PDS allocated to ddname FMNEXEC. You can enter any of the following:
 - The name of the member.
 - A member name pattern (other than a single *) to list all matching members. You can then select the required member by entering an **S** in the **Sel** field. A member name pattern can consist of any characters that are valid in a member name and the following two special pattern characters:

asterisk (*)

Represents any number of characters. As many asterisks as required can appear anywhere in a member name. For example, if you enter `*d*`, a list of all members in the data set whose name contains "d" is displayed.

percent sign (%)

A place-holding character representing a single character. As many percent symbols as necessary can appear anywhere in a member name. For example, if you enter `%%%%`, a list of all members in the data set whose name is four characters in length is displayed.

Ignore length mismatch

Indicates that you want to ignore length mismatches with the template. If you do not specify this, records that are shorter than the matching structure length in the template are not selected for processing. If you select **Ignore length mismatches**, then "from" fields that span the record boundary in the input data set record have their corresponding fields on the output record initialized, with the exception of alphanumeric fields where a partial copy is done for the portion of the field that exists on the input record.

JCL Source format

Indicates the file or PDS(E) members being copied contain JCL, the syntax of which is to be maintained during the copy process. You can only use this option if you have selected the **Use proc** option.



Note: Use of this option may affect the copy performance due to the processing overhead involved in verifying the syntax of the JCL.

MQ Include descriptor

If this is selected (with the / character), the message descriptor data returned by the GET MQ API is added as a prefix to the record data, allowing this data to be examined in conjunction with the message data.

Otherwise only the message data is available for processing.

MQ Get destructive

If this is selected (with the / character), the input messages queue (if an MQ queue is specified) is opened in SHARE mode and the MQ API GET destructively reads each message.

Otherwise the queue is opened in BROWSE mode and messages are not removed from the queue. This is only effective for the DSC (Copy) function.

Use I/O exit

Allows you to specify a user I/O exit for compressed or encrypted data sets.

This option has two fields. To select the option, enter "/" in the field to the left of **Use I/O exit**. With this selected, you can then specify which exit to use in the field to the right of the field label.



Note:

1. The field only displays if File Manager is installed with the option **USEIOX=ENABLE**, and the **Exit enabled** field (in the Set System Processing Options panel) is set to YES. If a default is specified with either of those options, it is displayed in the field to the right of **Use I/O exit**.
2. I/O exits can only be used to process the data sets that you are using. They cannot be used to process the copybooks or templates that you are using to format the data sets.

Advanced member selection

Enter "/" to specify a range of members to be selected rather than a specific or generic member name.

Skip select member panel

Enter "/" to run without showing the member selection list. This option is ignored if errors are found whilst copying (for example, duplicate member names when renaming members).

REXX member selection

Enter "/" to use a REXX procedure to determine if a member should be copied.

If this option is selected, then the **Use Proc:** option must be selected, a REXX procedure must be supplied and you can (optionally) specify the default action to be applied in the event the nominated procedure fails to determine if a member in the input data set should be copied.

The default action is determined by entering a **P** (PROCESS MEMBER) or **D** (DROP MEMBER) in the adjacent field. If no default is provided, P is assumed.

Directory integrity

Forces an override of the default PDS(E) member processing method which allows for faster PDS directory access.

This option has significant performance impact. When selected, the members are processed in a way which allows concurrent directory updates as File Manager accesses the members using current directory information.

When not selected, the member processing is performed faster, but may be affected by PDS(E) directory updates, possibly causing I/O errors if the data set is updated concurrently.

Report PDS record counts

The count of records for copied PDS(E) members and sequential/VSAM data sets is printed in the processing listing in batch. Copy progress counts are displayed on screen while processing in online mode.



Note: This option affects PDS(E) processing ONLY. For sequential/VSAM data sets, the record counts are always provided. When the option is selected, it prevents the use of IEBCOPY for PDS(E) processing, which may affect the copy performance.

Binary mode

When processing an HFS file, allows you to specify binary mode (selected) or text mode (unselected).

reclen

When processing an HFS file and the **Binary mode** option is selected, records are derived based on the fixed record length specified. The default is 80.

Can be in the range: 1–32760

Parent panels

[Utility Functions menu panel on page 1077](#)

Child panels

- [Copy To panel on page 796](#) (the Copy From data set and template, if specified, was fully qualified)
- [Data Set Selection panel on page 829](#) (a pattern has been entered in the Data set name field)
- [Member Selection panel on page 946](#)(a pattern or a blank has been entered in the Member field)
- [Record Type Selection panel on page 998](#) (Edit Template is selected and the specified template was based on a copybook with more than one record type).
- [Field Selection/Edit panel on page 891](#) (Edit Template is selected and the specified template was based on a copybook with only one record type).
- [Dynamic Template panel on page 845](#) (Create Dynamic option is selected or Edit Template is selected and the specified template was created dynamically).
- [Personal Data Set List panel on page 966](#) (Current® Data Set List option selected from the Process drop-down menu, or REFL fastpath command entered).
- [Personal Data Set Lists panel on page 968](#) (Personal Data Set Lists option selected from the Process drop-down menu, or REFD fastpath command entered).

Equivalent functions

[DSC \(Data Set Copy\) on page 1302](#)

Related tasks and examples

- [Copying data sets on page 341](#)
- [Supplying a procedure when using a File Manager panel on page 530](#)
- [Selecting a range of PDS\(E\) members on page 70](#)

Copy To panel

Use the Copy To panel to specify the data set to which you want the data to be written.

This panel comes in different versions, depending on whether you have specified a template in the Copy From panel and whether the output is to be exported to an external format such as XML or CSV.

Panel and field definitions

Figure 207. Copy Utility: “To” panel (no copybook or template specified in “From” panel)

Process	Options	Help
Copy from USERID.FMDATA(DATA1)		
To Partitioned, Sequential or VSAM Data Set, or HFS file:		
Data set name	FMDATA	+
Member	DATA2	
Volume serial	_____	
Processing Options:		
Disposition	Execution "/" options	ISPF Packing
<u>1</u> 1. Old or Reuse	— Replace members	<u>1</u> 1. Asis
2. Mod	— Binary mode, reclen _____	2. Pack
Stats Option		3. Unpack
<u>1</u> 1. Off		4. None
2. Force		5. Skip
Command ==>		
F1=Help	F2=Split	F3=Exit
F9=Swap	F10=Actions	F12=Cancel
	F4=Expand	F7=Backward
		F8=Forward

Copy from

Lists the data set, HFS file (directory), WebSphere® MQ queue name, or a CICS® resource from which you are copying data.

To data set/file: Data set/path name

Can be a fully-qualified data set name or a pattern, an HFS file or directory, a WebSphere® MQ queue name, or a CICS® resource.

For information about specifying a WebSphere® MQ queue name, see [Specifying an MQ manager or queue on page 48](#).

For information about specifying a CICS® resource, see [Specifying a CICS resource on page 48](#).

The data set name may include a member name or name pattern in parenthesis. If the member is specified here, the associated **Member** field must be empty.

When you specify an HFS file or directory, you must enter a full path name. If the path name is longer than the displayed entry field, press the Expand function key (F4) to display a pop-up window in which you can enter a longer name.

To Data Set: Member

If you specified the name of a partitioned data set (PDS) without including a member name or name pattern in parenthesis in the **Data set name** field, then you can use this field to specify the member name or a member name pattern.

Volume serial

Serial number of the volume which is to contain the copied data set. Required for data sets which are not cataloged.

Disposition

The To data set status:

Old or Reuse

Writes copied records into the output data set, starting from the beginning of the set and replacing any existing records.

Mod

Appends the input records to the end of the data set unless the data set is a VSAM KSDS data set. In this case, the records are positioned in the data set using the key value in the input record. MOD is invalid for a member of a partitioned data set.

Replace members

Replace like-named members in an output partitioned data set.

Binary mode

When processing an HFS file, select this option to specify binary mode. In binary mode, data in an HFS file is processed without record delimiters. **reclen** specifies the logical record length used to deblock data into fixed records. Enter a value between 0 and 32760 (default: 80).

Clear this option to specify text mode. In text mode, the data is processed as a collection of records delimited by one or more of the following EBCDIC characters, depending on the file format: newline (X'15'), carriage return (X'25'), line feed (X'0D').

Stats Option

Determines whether ISPF statistics (if present) for the PDS members being processed are updated:

Blank

Update ISPF statistics.

1 Off

Do not update ISPF statistics.

2 Force

Always update or create ISPF statistics.

Use I/O exit

Allows you to specify a user I/O exit for compressed or encrypted data sets.

This option has two fields. To select the option, enter "/" in the field to the left of **Use I/O exit**. With this selected, you can then specify which exit to use in the field to the right of the field label.



Note:



1. The field only displays if File Manager is installed with the option **USEIOX=ENABLE**, and the **Exit enabled** field (in the Set System Processing Options panel) is set to YES. If a default is specified with either of those options, it is displayed in the field to the right of **Use I/O exit**.
2. I/O exits can only be used to process the data sets that you are using. They cannot be used to process the copybook or template that you are using to format the data set.

ISPF Packing

Provided that the output data set is a sequential file or a PDS or PDSE, an I/O exit routine is not used, and the DISP is set to OLD, one of these options can be used to control the copy behavior when processing data that is in ISPF PACK format.

1. Asis

If the input data set is packed, it is unpacked before any processing. The output is written in packed format only when the input is packed.

2. Pack

If the input data set is packed, it is unpacked before processing. The output is always written in packed format.

3. Unpack

If the input data set is packed, it is unpacked before processing. The output is always written in unpacked format.

4. None

No checking or processing of ISPF packed data occurs. This option is forced if an I/O exit has been used.

5. Skip

If the input data is packed, no processing or copying occurs.

Template fields for output data set

When you have specified a template in the Copy From panel, the Copy To panel contains additional fields, so that you can choose to specify a template for the output data set.

Figure 208. Copy Utility: "To" panel (copybook or template specified in Copy From panel)

Process	Options	Help
Copy from FMNUSER.EXPORT		Top of data
To Partitioned, Sequential or VSAM Data Set, or HFS file:		
Data set/path name . . .	'FMNUSER.DATX'	+
Member name (or mask) . .	_____	(Blank or pattern for member list)
Volume serial	_____	(If not cataloged)
To Copybook/Template From: FMNUSER.DATA(TEMPA)		
Data set name	_____	
Member	_____	(Blank or pattern for member list)
Processing Options:		
Copybook/template usage	Disposition	Enter "/" to select option
2 1. Above	1 1. Old or Reuse	- Replace members
2. None	2. Mod	- Edit template mapping
3. Create dynamic	Stats Option	- Edit template source
ISPF Packing	1 1. Off	- Binary mode, reclen _____
1 1. Asis	2. Force	
2. Pack	Optimize Scrambling	
3. Unpack	- 1. Off	
4. None	2. On	
5. Skip	3. Max	
Command ==>		
F1=Help	F2=Split	F3=Exit
F9=Swap	F10=Actions	F12=Cancel
	F4=CRetriev	F7=Backward
		F8=Forward

Copybook/Template From

Lists the copybook or template specified in the Copy From panel, if applicable.

To Copybook or Template: Data set name

Data set name of the template or copybook to be used when mapping fields from the From Copybook or Template. This template does not affect the record selection or field format of the copied data. The field is ignored when the Copybook/template usage field is set to **2. None**.



Note: In the case of a copybook, this can be the name of a CA-Panvalet library, or a library accessed using the Library Management System Exit.

To Copybook or Template: Member

If you specified the name of a partitioned data set (PDS) or CA-Panvalet or other external library in the **Data set name** field, then use this field to specify the member name or member name pattern. This field is ignored when the Copybook/template usage field is set to **2. None**.

Edit template mapping

Specifies that you want to change the mapping of input fields to output fields or the data creation patterns for new fields.

Edit template source

Specifies that you want to edit the copybook used to generate the template.

Optimize Scrambling

This option specifies the method used to perform random scrambling or repeatable scrambling as defined in the **To** template.



Note: 1, 2, and 3 use different repeatable scrambling algorithms. Repeatable results can only be obtained by using the same optimization option.

Blank

This defaults to the setting of the OPSCRAM keyword in the installation options module.

1 Off

No optimization is performed.

2 On

This option is designed to improve performance when scrambling large amounts of data where the Repeat or Random option has been specified for various fields.

3 Max

This option is designed to provide the maximum performance improvement.



Note: If Repeat or Random has been specified for a field and a value list is not provided then duplicate alphanumeric characters within a field will yield the same scrambled character.

Fields for Export/Import options: XML

If you selected **1. XML** as the Export/Import option on the Copy From panel, the Copy To panel contains additional fields that allow you to customize how the data is written to XML.

Figure 209. Copy Utility: "To" panel (XML export mode specified in Copy From panel)

Process	Options	Help
Copy from FMNUSER.FMDATA		
To Partitioned, Sequential or VSAM Data Set, or HFS file:		
Data set/path name	. . 'FMN.FMDATA.XML'	+
Member name (or mask)	. _____	(Blank or pattern for member list)
Volume serial _____	(If not cataloged)
Processing Options:		
Disposition	Execution "/" options	Non-print. characters
<u>1</u> 1. Old or Reuse	- Replace members	<u>2</u> 1. Asis
2. Mod	- Binary mode, reclen	2. Hex
ISPF Packing	- Include fillers	3. Replace with . _____
<u>1</u> 1. Asis	- Include redefines	4. Skip
2. Pack	- Convert to Unicode	Special characters
3. Unpack	- Split output line	<u>1</u> 1. Escape
4. None		2. CData
5. Skip	Stats Option	3. Hex
Export/Import	<u>1</u> 1. Off	4. Replace with * _____
<u>1</u> 1. XML	2. Force	Invalid data
	Indent step <u>1</u>	<u>1</u> 1. Hex
		2. Replace with * _____
		3. Skip
Command ==>		
F1=Help	F2=Split	F3=Exit
F9=Swap	F10=Actions	F12=Cancel
	F4=Expand	F7=Backward
		F8=Forward

Export/Import

Specifies that the output is to be written in XML format.

Execution "/" options

Replace members

Replace like-named members in an output partitioned data set.

Binary mode

When processing an HFS file, select this option to specify binary mode. In binary mode, data in an HFS file is processed without record delimiters. **reclen** specifies the logical record length used to deblock data into fixed records. Enter a value between 0 and 32760 (default: 80).

Clear this option to specify text mode. In text mode, the data is processed as a collection of records delimited by one or more of the following EBCDIC characters, depending on the file format: newline (X'15'), carriage return (X'25'), line feed (X'0D').

Include fillers

Fillers are unnamed items that are defined in the input template (COBOL copybook or PL/I include). Select this option to include fillers in the output.

Convert to Unicode

Indicates whether the output is to be converted to Unicode, or not.

Split output line

Indicates whether the output lines resulting from processing an input record are to be spanned contiguously over multiple output records. If so, the output records will not match output lines. If

not, each output line must fit (as the only line) into a single output record, otherwise File Manager truncates the output, ends processing, and reports an error.

Indent step

Defines the number of blanks used to indent each level of XML tag nesting (each nested level in the template, COBOL copybook, or PL/I include causes an increase in indentation by the specified number of blanks). Valid range: 0–9 (default:1).

Non-print. characters

Indicates how non-printable characters are to be represented in the output.

1. Asis

Non-printable characters appear unchanged in the output.

2. Hex

A value with one or more non-printable characters is substituted by its hexadecimal representation.

3. Replace with *replacing-character*

Each non-printable character is substituted with a *replacing character*, or each substring of non-printable characters is converted to its hexadecimal representation and surrounded by nested <HEX> and </HEX> tags. The set of allowable replacing characters is limited to printable characters with the exception of special characters.

You can specify the replacing character in one of the following forms:

char

Each non-printable character is replaced with a character, such as "?". Default character: "." (dot).

C'char

Each non-printable character is replaced with a character without case translation.

X'cc'

Each non-printable character is replaced with a character defined by its hexadecimal value.

HEX

If you specify HEX instead of a replacing character, each substring of consecutive special characters is replaced by its hexadecimal representation, tagged by <HEX> and </HEX>, and nested into the content of the element. In other words, each string of consecutive special characters is represented by:

```
<HEX>hex-representation-of-nonprintable-char-string</HEX>
```

nested in the content of the element.

4. Skip

Value is skipped if it contains any non-printable characters.

Special characters

Indicates how special characters are to be represented in XML output.

1. Escape

Special characters are converted into escaped strings:

```
"&gt;" for ">"
"&lt;" for "<"
"&apos;" for "'"
"&quot;" for "\""
"&amp;" for "&"
```

2. CDATA

The string containing special characters is left unchanged. It is enclosed in the CDATA section.

3. Hex

A value with one or more special characters is substituted with its hexadecimal representation.

4. Replace with *replacing-character*

Each special character is substituted with a *replacing character*, or each substring of special characters is converted to its hexadecimal representation and surrounded by nested `<HEX >` and `</HEX >` tags. If a replacing character is specified or defaulted, each special character is substituted with the replacing character. The set of allowable replacing characters is limited to printable characters with the exception of special characters.

You can specify the replacing character in one of the following forms:

char

Each special character is replaced with a character, such as "?". Default character: "_" (underscore).

C'char'

Each special character is replaced with a character without case translation.

X'cc'

Each special character is replaced with a character defined by its hexadecimal value.

HEX

If you specify HEX instead of a replacing character, each substring of consecutive special characters is replaced by its hexadecimal representation, tagged by `<HEX>`

and </HEX>, and nested into the content of the element. In other words, each string of consecutive special characters is represented by:

```
<HEX>hex-representation-of-special-char-string</HEX>
```

nested in the content of the element.

Invalid data

Indicates how invalid data is to be represented in the output.

1. Hex

Any invalid value is substituted by its hexadecimal representation.

2. Replace with *replacing character*

Any invalid value is replaced with a string of *replacing characters* for the length of the value. The set of allowable characters is limited to printable characters with the exception of special characters.

You can use:

char

The value is replaced with a string of characters, such as "?". Default character: "*" (asterisk).

C'char'

The value is replaced with a string of characters without case translation.

X'cc'

The value is replaced with a string of characters, each character being defined by its hexadecimal value.

3. Skip

Any invalid value is skipped.

Fields for Export/Import options: CSV

If you selected **2. CSV** as the Export/Import option on the Copy From panel, the Copy To panel contains additional fields that allow you to customize how the data is written to CSV.

Figure 210. Copy Utility: "To" panel (CSV export mode specified in Copy From panel)

Process	Options	Help
Copy from FMNUSER.FMDATA		
To Partitioned, Sequential or VSAM Data Set, or HFS file:		
Data set/path name	. . 'FMN.FMDATA.CSV'	+
Member name (or mask)	. _____	(Blank or pattern for member list)
Volume serial _____	(If not cataloged)
Processing Options:		
Disposition	CSV options	Output Options
<u>1</u> 1. Old or Reuse	- Include fillers	/ <u> </u> Replace members
2. Mod	- Include redefines	- Binary mode, reclen <u>10</u>
ISPF Packing	- Include headings	Invalid data
<u>4</u> 1. Asis	- Include leading blanks	<u>1</u> 1. Hex
2. Pack	- Include trailing blanks	2. Replace with * _____
3. Unpack	- Leading zeros	3. Skip
4. None	- Quoted values	Stats
5. Skip	- Single quotes	<u>1</u> 1. Off
	- CSV delimiter	2. Force
	- ASIS encapsulation	
Command ==>		
F1=Help	F2=Split	F3=Exit
F9=Swap	F10=Actions	F12=Cancel
	F4=Expand	F7=Backward
		F8=Forward

CSV options

Include fillers

Fillers are unnamed items that are defined in the input template (COBOL copybook or PL/I include). Select this option to include fillers in the output.

Include redefines

Indicates whether redefinitions of data items that are specified in the input template (COBOL copybook or PL/I include) are to be included in the output or ignored.

Include headings

Select this option to include field names as headings in the first line of CSV output.

Include leading blanks

Select this option to preserve leading blanks in field values.

Include trailing blanks

Select this option to preserve trailing blanks in field values.

Leading zeros

Select this option to format all numeric fields with leading zeros.

Quoted values

Select this option to wrap the output field value in quotation marks as indicated by the **Single quotes** option. If this option is not selected, automatic encapsulation occurs when the field value contains:

- A delimiter.
- A quote for the first character.



Note: To suppress automatic encapsulation, select the ASIS encapsulation option.

Single quotes

Select this option to use single quotation marks instead of double quotation marks for quoted values.

CSV delimiter

Use this field to specify an alternate character to delimit fields in the output file. The default character is a comma.

ASIS encapsulation

Select this option to suppress automatic encapsulation. Automatic encapsulation occurs when the Quoted values option is not selected and the field value contains:

- A delimiter.
- A quote for the first character.

Replace members

Replace like-named members in an output partitioned data set.

Binary mode

When processing an HFS file, select this option to specify binary mode. In binary mode, data in an HFS file is processed without record delimiters. **reclen** specifies the logical record length used to deblock data into fixed records. Enter a value between 0 and 32760 (default: 80).

Clear this option to specify text mode. In text mode, the data is processed as a collection of records delimited by one or more of the following EBCDIC characters, depending on the file format: newline (X'15'), carriage return (X'25'), line feed (X'0D').

Invalid data

Indicates how invalid data is to be represented in the output.

1. Hex

Any invalid value is substituted by its hexadecimal representation.

2. Replace with *replacing character*

Any invalid value is replaced with a string of *replacing characters* for the length of the value. The set of allowable characters is limited to printable characters with the exception of special characters.

You can use:

char

The value is replaced with a string of characters, such as "?". Default character:

"*" (asterisk).

C'char'

The value is replaced with a string of characters without case translation.

X'cc'

The value is replaced with a string of characters, each character being defined by its hexadecimal value.

3. Skip

Any invalid value is skipped.

Fields for Export/Import options: CSV Import

If you selected **3. CSV Import** as the Export/Import option on the Copy From panel, the Copy To panel contains additional fields that allow you to customize how the data is written to CSV.

Figure 211. Copy Utility: "To" panel (CSV import mode specified in Copy From panel)

```

Process  Options  Help
-----
Copy from FMNUSER.FMDATA
To Partitioned, Sequential or VSAM Data Set, or HFS file:
Data set/path name . . 'FMN.FMDATA.CSV' +
Member name (or mask) . _____ (Blank or pattern for member list)
Volume serial . . . . . _____ (If not cataloged)
Processing Options:
Disposition          CSV options          Output Options
 1 1. Old or Reuse   - Headings           / Replace members
 2 2. Mod           - DBCS               - Binary mode, reflen 60
ISPF Packing         - Single quotes      Stats
 4 1. Asis         -> CSV delimiter     1 1. Off
 2 2. Pack         - Fillers            2 2. Force
 3 3. Unpack       - Redefines
 4 4. None
 5 5. Skip
Command ==>
F1=Help      F2=Split   F3=Exit    F4=Expand  F7=Backward F8=Forward
F9=Swap      F10=Actions F12=Cancel
    
```

CSV Options

Headings

Select this option if the CSV data set to be imported includes headings.

DBCS

Select this option if the CSV data set to be imported includes double-byte data (DBCS characters wrapped in shift-in (x'0E') and shift-out (x'0F') characters.

Single quotes

Select this option if the CSV data set to be imported uses single quote encapsulation instead of double quote.

CSV delimiter

Use this field to specify an alternate delimiter value to the comma "," character .

Fillers

Select this option if the CSV data set to be imported includes filler fields.

Refines

Select this option if the CSV data set to be imported includes redefines fields.

Parent panels

- [Copy From panel on page 789](#)

Child panels

- [Copy From panel on page 789](#) (the Copy To data set and template, if specified, was fully qualified)
- [Data Set Selection panel on page 829](#) (a pattern has been entered in the Data set name field)
- [Member Selection panel on page 946](#) (a pattern or a blank has been entered in the Member field)
- [Record Type Selection panel on page 998](#) (Edit Template is selected and the specified template was based on a copybook with more than one record type).
- [Field Selection/Edit panel on page 891](#) (Edit Template is selected and the specified template was based on a copybook with only one record type).
- [Dynamic Template panel on page 845](#) (Create Dynamic option is selected or Edit Template is selected and the specified template was created dynamically).
- [Personal Data Set List panel on page 966](#) (Current® Data Set List option selected from the Process drop-down menu, or REFL fastpath command entered).
- [Personal Data Set Lists panel on page 968](#) (Personal Data Set Lists option selected from the Process drop-down menu, or REFD fastpath command entered).

Equivalent functions

[DSC \(Data Set Copy\) on page 1302](#)

Related tasks and examples

- [Copying data sets on page 341](#)
- [Supplying a procedure when using a File Manager panel on page 530](#)

Copybook and Template Utility functions panel

Panel and field definitions

Figure 212. Copybook and Template Utility functions panel

Process	Options	Help
File Manager	Copybook and Template Utility functions	
1 Workbench	Create, edit or update single templates	
2 Print	View or print copybooks or templates	
3 Build	Compile copybook(s) into template(s)	
4 Update	Update template(s)	
5 Import	Import template(s)	
6 Export	Export template(s)	
7 Repository	Repository utilities menu	
8 List	Template list	
Command ==>		
F1=Help	F2=Split	F3=Exit
F9=Swap	F10=Actions	F12=Cancel
	F4=CRetriev	F7=Backward
		F8=Forward

Parent panels

- [Primary Option Menu panel on page 970](#)

Child panels

- [Template Workbench panel on page 1072](#)
- [Copybook View and Print: Entry panel on page 814](#)
- [Template Build Utility panel on page 1056](#)
- [Template Update Utility panel on page 1066](#)
- [Template Import Utility panel on page 1062](#)
- [Template Export Utility panel on page 1058](#)
- [Template repository utilities on page 193](#)
- [Template List Entry panel on page 275](#)
- [Template Member List panel on page 1064](#)

Related tasks and examples

Copybook Selection panel

Panel and field definitions

Figure 213. Copybook Selection panel

Process	Options	Help
File Manager		
Copybook Selection		
Cmd	R	Member
***	****	Top of data
---		MID1
---		COPYCONC
---		COPYMM
---		FLMLDATE
---		FMNCPY1
***	****	End of data
Command ==>		
F1=Help	F2=Split	F3=Exit
F8=Down	F9=Swap	F12=Cancel
		F4=CRetrieve
		F6=LibList
		F7=Up
		Scroll HALF

Cmd

Prefix command field. Allows you to edit, view, copy, insert or delete members. Available commands are:

E

Create (if necessary) the template and edit it.

A

Identifies the record after which data is to be moved or copied.

B

Identifies the record before which data is to be moved or copied.

C

Copy one record.

Cn

Copy *n* records.

CC

Copy block of records. Marks the start and end of the block.

D

Delete one record.

Dn

Delete *n* records.

DD

Delete block of records. Marks the start and end of the block.

I

Insert one empty record.

In

Insert *n* empty records.

M

Move one record.

Mn

Move *n* records.

MM

Move block of records. Marks the start and end of the block.

R

Repeat record once.

Rn

Repeat record *n* times.

RR

Repeat block of records. Marks the start and end of the block.

RRn

Repeat block of records *n* times. Marks the start and end of the block.

S

Edit the member. (Restricted to members stored in a PDS or PDSE.)

U

Update and edit the template.

V

View the member.

X

Displays the Redefines / Range Specifications panel.

R

This column contains the value "R" if redefines or range parameters have been specified for the corresponding copybook member.

Member

Copybook member name field. If a mask is provided as a member name, the Member Selection panel is displayed, allowing one or more members to be selected for inclusion in the process list at the current position.



Note: All members must use the same language, either COBOL or PL/1. If you specify a member that consists of an entire program, from which File Manager is to extract the copybook information, you should only specify one member. Mixing a program member with other copybook members might cause compilation errors.

Lib

The sequence number of the library data set containing the member, as specified on the Library List panel.

01

Flag field (Y) to specify that File Manager should insert a 01-level definition into the template at the beginning of the copybook details provided in the member.

Field name

01-level name of up to 35 bytes to be inserted when the 01 field contains a "Y". If a member is flagged as requiring a 01-level definition and no 01-level name field is supplied, one is generated.

You can use the following primary commands on this panel:

- CANCEL
- END
- LIBLIST
- LOCATE
- UPDATE
- EDIT

Parent panels

- [Library List panel on page 923](#)

Child panels

- [Member Selection panel on page 946](#)
- [Template Save pop-up panel on page 1070](#)
- [Redefines / Range Specifications panel on page 1000](#)

Related tasks and examples

- [Advanced copybook selection on page 208](#)

Copybook View and Print: Entry panel

The Copybook View and Print: Entry panel is used to specify the template definition that you want to view or print. These field definitions can be stored in:

- a copybook
- a template that was based on a copybook (not Db2® templates)
- a dynamic template
- an IMS™ view
- an IMS™ criteria set

Panel and field definitions

Figure 214. Copybook View and Print Utility panel

```

Process  Options  Help
-----
File Manager          Copybook View and Print

Copybook or Template:
  Data set name . . . . . -----
  Member . . . . . ----- Blank or pattern for member list

Processing Options:
  View/Print Option          Enter "/" to select option
  1. View                    - Batch Execution
  2. Print                    / Show array elements
                              - Show start/end as hex offset
                              - Show length in hex
                              - Show template criteria

Command ==> -----
F1=Help      F2=Split    F3=Exit     F4=CRetrie v  F7=Backward  F8=Forward
F9=Swap      F10=Action s  F12=Cancel
  
```

Copybook or Template

The name of copybook, template (non Db2®), IMS™ view or IMS™ criteria set that you want to view or print, which is specified using:

Data set name

The name of the sequential or partitioned data set that contains the copybooks, templates, IMS™ views or IMS™ criteria sets that you want to view or print. Can be a fully-qualified data set name or a pattern. The name may include a member name or name pattern in parenthesis. If the member is specified here, the associated **Member** field must be empty.



Note: A copybook must be a member of a partitioned data set. Templates, IMS™ views and IMS™ criteria sets can be in a sequential data set.

Member

If you specified the name of a partitioned data set (PDS) without including a member name or name pattern in parenthesis in the **Data set name** field, then you can use this field to specify the member name or a member name pattern.

Processing options

You can specify whether to view or print the layout and also request batch or foreground execution. The options are described below:

View/Print Option

This option is ignored for batch execution.

1. View

Displays the report on a scrollable panel.

2. Print

Prints the report to the current print data set.

Batch execution

Runs the function in batch. The **Set Batch Job card Information** panel can be used to tailor the default JOB card that File Manager uses to generate JCL.

Show array elements

Shows all occurrences of array elements.

For COBOL OCCURS DEPENDING ON arrays, the maximum occurrences are shown. For PL/1 REFER arrays, the minimum occurrences are shown.

Show start/end as hex offset

Shows start and end values as hexadecimal offsets.

Show length in hex

Shows length values as hexadecimal.

Show template criteria

Shows any identification and selection criteria contained in the template.

If a copybook is being viewed or printed, this option has no effect.

Parent panels

- [Utility Functions menu panel on page 1077](#)
- [Copybook and Template Utility functions panel on page 809](#)

Child panels

- [Copybook View and Print: View panel on page 816](#)

Equivalent functions

- None.

Related tasks and examples

- [Copybook View and Print Utility on page 260](#)

Copybook View and Print: View panel

The Copybook View and Print: View panel displays the field information stored in a selected template or copybook.

Panel and field definitions

Figure 215. Copybook View and Print: View panel

Process	Options	Help				
File Manager	USERID.COPYBOOK(COPY0102)		Line 1 of 18			
1 Print Layout						
Ref	Field Name	Picture	Type	Start	End	Length
**** Top of data ****						
1 1	REC-TYPE01		AN	1	80	80
2 2	REC-TYPE	XX	AN	1	2	2
3 2	NAME	X(20)	AN	3	22	20
4 2	EMPLOYEE-NO	9(4)	BI	23	24	2
5 2	AGE	9(4)	BI	25	26	2
6 2	SALARY	9(7)	PD	27	30	4
7 2	MONTH OCCURS 12 TIMES	9(8)	BI	31	34	4
8 2	FILLER	XX	AN	79	80	2
1 1	REC-TYPE02		AN	1	80	80
2 2	REC-TYPE	XX	AN	1	2	2
3 2	NAME	X(20)	AN	3	22	20
4 2	JOB-TITLE	X(14)	AN	23	36	14
Command ==>				Scroll 0001		
F1=Help	F2=Split	F3=Exit	F4=CRetriev	F5=RFind	F7=Up	
F8=Down	F9=Swap	F12=Cancel				

This panel displays the layout for the copybook or template you referenced via the entry panel. You can print the contents of the display to the current print data set.



Note: The panel shown in [Figure 215: Copybook View and Print: View panel on page 816](#) shows a template derived dynamically from a copybook, in which case, criteria expressions cannot be present.



However, if the **Show template criteria** option on the Copybook View and Print entry panel has been selected, for a precompiled template criteria expressions may be shown on this panel.

Field reference

Shows the field reference number assigned by File Manager to the field name. Field reference numbers are assigned to all fields in a record, and are used to identify fields in identification and selection criteria expressions and in primary commands. For IMS™ templates, views and criteria sets, the reference is suffixed with a K to flag key fields.

Field name

Shows the level number and field name of the field. Various other attributes, such as redefines, array sizes, and depending on references, are also displayed as part of the name. Non-zero offset values are displayed for Level 1 fields. For IMS™ templates, views and criteria sets, the Level 1 field name includes the segment reference.

Picture

Shows the picture clause for COBOL and for PL/I shows the length and scale (if non zero) for binary and packed fields. Also shows the bit length for bit fields.

Type

Shows the data type of the field:

AN

Alphanumeric (includes alphabetic, group items, edited PL/I numeric picture fields, and edited COBOL numeric picture fields where not all elements of the picture clause are supported).

AX

Alphanumeric displayed in long hexadecimal.

BI

Binary

BT

Bit

FE

Floating point (external)

FP

Floating point (internal)

G/DB

Graphic/DBCS

PD

Packed decimal (internal decimal)

VB

Varying bit

VC

Varying character

VG/VD

Varying graphic/DBCS

ZC

Z Character

ZA

Zoned Alphanumeric (COBOL external edited). COBOL edited picture definitions that do not fit the ZE definition.

ZD

Zoned Decimal (external decimal)

ZE

Zoned Edited (COBOL external edited). Supports COBOL picture edit characters `+ - . 9`

ZG/Z2

Varying graphic/DBCS null terminated

Start

Shows the start column of the field. For variable located fields, the start location is based on the maximum length of the record.

End

Shows the end column of the field.

Length

Shows the length of the field. For a Level 01 field, if the record is variable length, the length shown is the maximum record length.

Example

Available commands

1 or P

Prints the displayed report to the print data set.

FIND

Finds the next occurrence of a character string in the data being displayed, starting at the top of the displayed page or starting at the cursor position (if the cursor is within the data portion of the display). The cursor is

placed at the beginning of the found string. Automatic scrolling is performed, if necessary, to bring the string into view. See [FIND/FX primary command on page 1157](#) for more details about this command and its syntax.

Offset

Repositions the field start locations by the value specified. The length of the Level 01 field is adjusted by the offset and the remaining fields within the layout have the offset added to their start location.



Note: Using the OFFSET commands for IMS™ data set members invalidates key field references, as these cannot be validated in the File Manager Base component. Key field references remain as they were derived in the originating template, view or criteria set.

Figure 216. Syntax

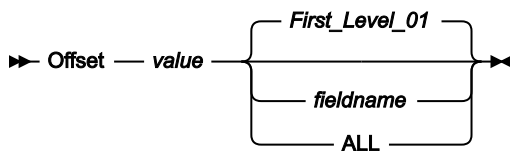

value

The length of Level 01 fields in the report and subsequent fields within the layout is adjusted by the value provided, which must be in the range -32760 to 32760. If no field identifier is supplied and ALL is not used, the value is applied to the first Level 01 field in the template.

ALL

Where the report contains multiple record structures, this keyword applies the corresponding *value* to all Level 01 fields within the report.



Note: You can specify a value for ALL and then override this value for individual layouts by providing subsequent *value* and *fieldname* combinations.

fieldname

The name of the Level 01 field to which *value* is to be applied. The default is the first Level 01 field in the report.

RESet

This command is used to reset any field highlighted by the FIND command.

Parent panels

- [Copybook View and Print: Entry panel on page 814](#)

Child panels

- None.

Equivalent functions

- None.

Related tasks and examples

- [Copybook View and Print Utility on page 260](#)

Create panel

Panel and field definitions

Figure 217. Create panel

Process	Options	Help
File Manager Create		
To Data set:		
Data set/path name	. . 'FMN.FMDATA'	_____
Member name (or mask)	:	_____
Volume serial	_____
Allocation Options:		
<u>1</u>	1. Allocate using the attributes of	_____
	'FMNUSER.DATA'	
	2. Specify allocation attributes	
Processing Options:		
ISPF Packing		Enter anything to select option
<u>1</u>	1. None	_ Binary mode, reclen _____
	2. Pack	
Command ==> _____		
F1=Help	F2=Split	F3=Exit F4=CRetriev F7=Backward F8=Forward
F9=Swap	F10=Actions	F12=Cancel

Data set/path name

Can be a fully-qualified data set name or a pattern, an HFS file or directory, a WebSphere® MQ queue name, or a CICS® resource.

For information about specifying a WebSphere® MQ queue name, see [Specifying an MQ manager or queue on page 48](#).

For information about specifying a CICS® resource, see [Specifying a CICS resource on page 48](#).

The data set name may include a member name or name pattern in parenthesis. If the member is specified here, the associated **Member** field must be empty.

When you specify an HFS file or directory, you must enter a full path name. If the path name is longer than the displayed entry field, press the Expand function key (F4) to display a pop-up window in which you can enter a longer name.

The **Allocation Options** are only required when the "To" data set does not exist.

The **Binary mode** and **reclen** parameters are only relevant for an HFS file.

Parent panels

Child panels

- [Allocate panel on page 737](#)
- [Allocate \(Two\) panel on page 739](#)
- [Allocate \(Three\) panel on page 744](#)

Equivalent functions

- None.

Related tasks and examples

- [Creating, replacing, and adding data using existing data on page 333](#)

Create Tape Data panel

Panel and field definitions

Figure 218. Create Tape Data panel

<u>P</u> rocess	<u>O</u> ptions	<u>H</u> elp
File Manager		Create Tape Data
Tapes: No tapes allocated		
Input:		
DDNAME to use . _____		enter new name, or select one from above
Tape mode _		optional recording mode or density code
Output:		
Records _____		number of records
Record length . <u>50</u>		
Fillchar _____		char or hex value, AN, BIN, or RAND
Sequence field position . _____		if sequence field desired
Sequence field length . . <u>8</u>		length from 1 to 9
Sequence field increment . <u>10</u>		increment value
Record format . _____		F,FB, V,VB,VS,VBS, D,DB,DS,DBS, or U
Block size . . _____		required for blocked output
Command ==>		
F1=Help	F2=Split	F3=Exit
F9=Swap	F10=Actions	F12=Cancel
	F4=CRetriev	F7=Backward
		F8=Forward

Tapes

List of tapes currently allocated.

DDNAME to use

Specify the DDNAME used to allocate a tape unit. File Manager displays the DDNAME and VOLSER of an allocated tape unit, if any.

If the DDNAME specified is not allocated, File Manager prompts for allocation information.

Records

Number of logical records to be written. Range: 0-99999999

Record length

Length of the records to be written. Range: 1-9999999, depending on the output file characteristics.

Fill char

To fill each byte of each record with data, specify one of the following:

char

A character such as 0 to be written in each byte.

X'cc'

A binary character, such as X'04' to be written in each byte.

AN

To write alphanumeric characters (A to Z, 0 to 9).

AX

Alphanumeric displayed in long hexadecimal.

BIN

To write binary characters (X'00' to x'FF').

RAND

To write random binary characters (X'00' to x'FF').

Default: blank character

Sequence field position

Position (starting with 1) of the sequence field within the output block or record. If omitted, there is no sequence field. Key position + key length - 1 must be less than or equal to the record length.

Range: 1 to n where

$$n \leq \text{record length} - \text{key length} + 1$$

Default: No key

Sequence field length

Length of the sequence field. $\text{key position} + \text{key length} - 1$ must be less than or equal to the record length.

Range: 1-9

Default: 8

Sequence field increment

Increment value used to increase the number in the sequence field.

Range: Any positive numeric value fitting into the sequence field.

Default: 10

Specify one of the following:

U

undefined

F

fixed

FB

fixed blocked

V

variable

VB

variable blocked

VS

variable spanned

VBS

variable blocked spanned

D

ASCII variable length

DB

ASCII variable blocked

DS

ASCII variable spanned

DBS

ASCII variable blocked spanned

The actual block size for record format F and FB, otherwise the maximum block size. For record format FB or VB a block size is required, otherwise it is optional.

Range: 1-9999999 for F,FB,U records, 9-65535 for V,VB records

Parent panels

[Tape Specific Functions panel on page 1047](#)

Child panels

- None.

Equivalent functions

- [BT \(Create Tape File\) on page 1250](#)

Related tasks and examples

- [Create Tape Data \(option 4.7\) on page 469](#)

Data Create Utility panel

You can use the Data Create Utility panel to create and initialize sequential data sets, VSAM data sets, and PDS data sets and members.

Panel and field definitions

Figure 219. Data Create Utility panel

<u>P</u> rocess	<u>O</u> ptions	<u>H</u> elp
File Manager	Data Create Utility	Top of data
Output Partitioned, Sequential or VSAM Data Set, or HFS file:		
Data set/path name	<u>/u/testonly/xxx.txt</u>	+
Member	<u>*</u>	(Blank or pattern for member list)
Volume serial	<u> </u>	(If not cataloged)
Record length	<u>90</u>	Optional record length for RECFM V
Records	<u> </u>	Number of records
Fillchar	<u> </u>	Char or hex value, AN, BIN, or RAND
Sequence field position	<u> </u>	If sequence field desired
Sequence field length	<u>8</u>	Length from 1 to 9
Sequence field increment	<u>10</u>	Increment value
Like data set	<u> </u>	
Copybook or Template:		
Data set name	<u>'FMNUSER.TEMPLATE'</u>	
Member	<u> </u>	(Blank or pattern for member list)
Processing Options:		
Disposition	Copybook or template	Enter "/" to select option
<u>2</u> 1. Old/Reuse	<u>1</u> 1. Above	- Edit template _ Type (1,2,S)
2. Mod	2. Previous	- Batch execution
ISPF Packing	3. None	- Binary mode, reclen <u> </u>
<u>1</u> 1. None	4. Create dynamic	
2. Pack		
Command '==>		
F1=Help	F2=Split	F3=Exit
F9=Swap	F10=Actions	F12=Cancel
	F4=Expand	F7=Backward
		F8=Forward

Data set/path name

Can be a fully-qualified data set name or a pattern, or a HFS file or directory. The data set name may include a member name or name pattern in parenthesis. If the member is specified here, the associated **Member** field must be empty.

When you specify an HFS file or directory, you must enter a full path name. If the path name is longer than the displayed entry field, press the Expand function key (F4) to display a pop-up window in which you can enter a longer name.



Note: This can be the name of a new or existing data set. If it is a new data set, you are asked to allocate the data set when you process the panel.

Member

If you specified the name of a partitioned data set (PDS) without including a member name or name pattern in parenthesis in the **Data set name** field, then you can use this field to specify the member name or a member name pattern.

Volume serial

Serial number of the volume which is to contain the copied data set. Required for data sets which are not cataloged.

Record length

The length of the records to be written. For variable record formats, the value specified is used when it is less than the maximum record size. Otherwise, the maximum record size is used and user input is ignored. For fixed record formats, the value is set to the data set record length and user input is ignored. For undefined record formats, the value is set to the block length and user input is ignored.

Records

The number of records to be written to the output data set.

Fillchar

Determines how each byte of each record is to be filled. You can enter:

char

Writes the character *char* in each byte. Alphabetic characters are translated to upper case.

C'char'

Writes the character *char* in each byte without case translation.

X'cc'

Writes *X'cc'* in each byte.

AN

Fills the record with consecutive characters (A to Z, 0 to 9)

BIN

Fills the record with consecutive binary characters (X'00' to X'FF')

RAND

Fills the record with random binary characters (X'00' to X'FF')

Sequence field position

The position (starting with 1) of the sequence field within the output block or record. If omitted, there is no sequence field.

This field is ignored if a template or copybook is used for data creation.



Note:

1. This differs from the Key position field on the Allocation panel, which measures the position as an offset value. That is, if the Allocation panel defines the Key position as 10, then the field begins in column 11.
2. **Key position** and **Key length** define a unique sequencing field located anywhere in the record, and not necessarily related to the key of a KSDS VSAM data set, as they can be used with any type of data sets.

Sequence field length

The length of the sequence field. The default is 8. The value of [**Key position** + **Key length** - 1] must be less than or equal to the record length.

This field is ignored if a template or copybook is used for data creation.

Sequence field increment

The increment value used to increase the number in the sequence field. The default is 10.

This field is ignored if a template or copybook is used for data creation.

Copybook or Template

Data set name and Member name of the template or copybook to be used to format your data.



Note: In the case of a copybook, this can be the name of a CA-Panvalet library, or a library accessed using the Library Management System Exit.

Disposition

Sets the output data set status:

Old/Reuse

Writes records into the output data set, starting from the beginning of the set and replacing any existing records.

Mod

Appends the records to the end of the output data set.

Like data set

Name of the data set to be used as the model for the output allocation.

File Manager uses the TSO prefix (as defined for your user ID) used as the high-level qualifier for any name that is not enclosed in quotation marks.

If copying data sets, "=" denotes the current input data set.

The model data set must reside on a DASD volume, be cataloged, and SMS must be active.

Copybook or template

Determines whether or not a copybook or template is to be used to format your data.

Above

File Manager uses the template specified on the panel. (If you specified a copybook, File Manager compiles it into a template before use.)

Previous

File Manager uses the last template you used to process this data set. If you have not previously used a template for this data set, File Manager displays a message and processing continues without a template.

None

File Manager does not use a template and therefore does not perform data creation at field level.

Create dynamic

File Manager creates a dynamic template. You can now define fields and field creation attributes.

Edit template

Allows you to edit the template you have requested for processing.

Type (1,2,S)

The type of editing you want to perform.

You can specify one of the following values:

1

Edit the Record Identification Criteria by field first

2

Edit the Record Selection Criteria by field first

S

Edit the source definition for a template using the advanced copybook selection facility.

This option is ignored when editing a dynamic template.

Batch execution

Allows you to edit the JCL to run the function in batch.

Use I/O exit

Allows you to specify a user I/O exit for compressed or encrypted data sets.

This option has two fields. To select the option, enter “/” in the field to the left of Use I/O exit. With this selected, you can then specify which exit to use in the field to the right of the field label.



Note:

1. The field only displays if File Manager is installed with the option **USEIOX=ENABLE**, and the **Exit enabled** field (in the Set System Processing Options panel) is set to YES. If a default is specified with either of those options, it is displayed in the field to the right of Use I/O exit.
2. An I/O exit can only be used to process the data set in which you are creating records. It cannot be used to process the copybook or template that you are using to format the data set.

Binary mode

When processing an HFS file, allows you to specify binary mode (selected) or text mode (unselected).

reclen

When processing an HFS file and the **Binary mode** option is selected, records are derived based on the fixed record length specified. The default is 80.

Can be in the range: 1–32760

ISPF Packing

Determines whether or not the output records are created in ISPF PACK format.

1 None

The output data set is written without ISPF packing.

2 Pack

Parent panels

- [Utility Functions menu panel on page 1077](#)

Child panels

- [Data Set Selection panel on page 829](#)
- [Member Selection panel on page 946](#)
- [Dynamic Template panel on page 845](#)
- [Field Selection/Edit panel on page 891](#)

- [Personal Data Set List panel on page 966](#) (Current® Data Set List option selected from the Process drop-down menu, or REFL fastpath command entered).
- [Personal Data Set Lists panel on page 968](#) (Personal Data Set Lists option selected from the Process drop-down menu, or REFD fastpath command entered).

Equivalent functions

- [DSG \(Data Set Generate\) on page 1372](#)

Related tasks and examples

- [Creating data sets and records on page 328](#)

Data Set Selection panel

The Data Set Selection panel lists all data sets that match the data set name pattern provided on a process Entry panel, for example, on the View Entry panel. From this panel, you can select a data set for processing.

The panel can be called from a number of different locations (see "Parent panels" below). On some occasions, the panel title is modified to reflect its current usage. For example, when called from the Copy Utility From panel, the title reads "Copy From Data Set Selection".

Panel and field definitions

Figure 220. Data Set Selection panel

<u>P</u> rocess	<u>O</u> ptions	<u>H</u> elp			
File Manager		Data Set Selection	Row 00001 of 00006		
Data Set Selection for FMNUSER.FMDATA.KSD*					
Data Set Name	Type	Volume	Created		
DTORNEY.FMDATA.KSD*	*	*	*		
— FMNUSER.FMDATA.KSDS	KSDS		2007.242		
— FMNUSER.FMDATA.KSDS.DATA	DATA	D\$US57	2007.242		
— FMNUSER.FMDATA.KSDS.INDEX	INDEX	D\$US57	2007.242		
— FMNUSER.FMDATA.KSDS2	KSDS		2008.352		
— FMNUSER.FMDATA.KSDS2.DATA	DATA	D\$US59	2008.352		
— FMNUSER.FMDATA.KSDS2.INDEX	INDEX	D\$US59	2008.352		
**** End of data ****					
Command ==>				Scroll PAGE	
F1=Help	F2=Split	F3=Exit	F4=CRetriev	F5=RFind	F7=Backward
F8=Forward	F9=Swap	F10=Left	F11=Right	F12=Cancel	

Data Set Selection for

Indicates the pattern used on the Entry panel.

(Select field)

Where you can enter **s** to select your data set. While you can enter the **s** in more than one field, only the first selected data set is processed.

Data Set Name

Lists the data sets that match your pattern.

Type

Lists the data set type for each data set displayed.

Volume

Lists the volume on which the data set is stored.

Created

Lists the creation data for each data set, in the format yyyy.ddd where ddd is the day number within the year (not the date). For example, 2003.036 is February 05, 2003.

Parent panels

- [AFP Print Browse panel on page 730](#)
- [Allocate panel on page 737](#)
- [Browse Entry panel on page 751](#)
- [Copy From panel on page 789](#)
- [Copy To panel on page 796](#)
- [Data Create Utility panel on page 824](#)
- [Compare Utility: "Old" and "New" panels on page 764](#)
- [Edit Entry panel on page 862](#)
- [Find/Change Utility panel on page 901](#)
- [Load Module Information panel on page 927](#)
- [Print Utility panel on page 977](#)
- [Template Workbench panel on page 1072](#)

Child panels

- The display panel that would normally result from your starting Entry panel.

Related tasks and examples

- [Specifying a data set and a member name on page 42](#)
- [Manipulating your view of selection lists on page 62](#)

Date/Time Attributes panel

This panel is used to define a field that contains date and time values. The panel lists the date and time field's formatting, data create or modify, and data scrambling attributes.

You can define the format in which the date and time data is stored, if necessary override the data type for the field, and modify the format used to display the date and time. You can also specify data create and field scrambling options.

Panel and field definitions

Figure 221. Date/Time Attributes panel

Process	Options	Help
File Manager		
Date/Time Attributes		
Command ==>		
Fixed Attributes:		
Field name	CHAR-DDMMYYYY	
Type	AN	
Start	10	
Length	8	
Internal Attributes:		
Format	DDMMYYYY	+
Type	—	
Output Attributes:		
Format	DD/MM/YYYY	+
Create/Modify Attributes:		
Base Date	20/10/2014	+
	(Use = for current date/time)	
Day Adjustment	_____	
Month Adjustment	_____	
Year Adjustment	_____	
Scrambling Options:		
Enter "/" to select option		
Random Range Start	_____	+
End	_____	+
F1=Help F2=Split F3=Exit F4=Expand F5=RFind F7=Up F8=Down		
F9=Swap F10=Left F11=Right F12=Cancel		

Internal attributes

Used to define how the date and time value is stored in the field.

Format

Specifies the format in which a date and time value is stored in the field. The format value can be a string containing picture characters supported by the Language Environment® date and time callable services. For example if an 8 byte, external decimal field is used to store a date in the form of a 4 digit year value followed by a 2 digit month value followed by a 2 digit day value you would specify the format string as:

```
YYYYMMDD
```

You can also enter one of the following formats supported by File Manager:

CENTSECS

Time of day in hundredths of seconds

CBLDATE

COBOL date (the number of days since 31 December 1600)

CYYDDD

Julian date with C as the century indicator (0 = 1900s, 1 = 2000s)

LILDATE

Lilian date (the number of days since 14 October 1582)

LILTIME

Date and time stored as the number of seconds since 00:00:00 14 October 1582.

MICSECS

Time of day in millionths of seconds.

MILLSECS

Time of day in thousandths of seconds.

STCK

Date and time stored as a TOD clock value.

STCKE

Date and time stored as an extended TOD clock value.

Type

Specifies a data type that overrides the data type defined in the field attributes. This is used when the field data type is not appropriate for the processing of the date and time value. For example if an alphanumeric field is used to store microsecond time values **BI** (binary) can be entered in the Type field to ensure File Manager performs valid processing of the time values.

Output attributes

Used to define how the date and time value is displayed.

Format

Specifies the format used to display the date and time values for this field. You enter the format as a string containing picture characters supported by the Language Environment® date and time callable services. For example to display a date value as a string showing a 3 character day-of-week, a 3 character month, 2 digits for the day of the month, and 4 digits for the year you could specify the format string as:

```
Www Mmm DD, YYYY
```

When File Manager displays a date and time field in formatted mode, the output width for the field is set to the length of the specified output format.

Create/Modify Attributes

These define the field-specific attributes used by the data create and data copy functions when creating test data for records containing this field.

Base Date

Specifies a date value to be used when creating new data for this field. You enter a date value in the output format defined for this field. You can enter an = to retrieve the current date in the output format.

If you leave this field blank the date at the time the data is created should be used to populate the field.

Day Adjustment

Specifies a value to increment or decrement the day value in the base date. The value should consist of integers optionally preceded by the plus (+) or minus (-) character. The plus character indicates the day value should be incremented. The minus character indicates the day value should be decremented. If a plus or minus character is not specified a plus is assumed.

The increment or decrement value is applied to the day value stored in the field for the previous record. For example, a value of -1 indicates that each subsequent record should have a date value one day earlier than the date value stored in the previous record.

Month Adjustment

Specifies a value to increment or decrement the month value in the base date. The value should consist of integers optionally preceded by the plus (+) or minus (-) character. The plus character indicates the month value should be incremented. The minus character indicates the month value should be decremented. If a plus or minus character is not specified a plus is assumed.

The increment or decrement value is applied to the month value stored in the field for the previous record. For example, a value of +1 indicates that each subsequent record should have a date value one month later than the date value stored in the previous record.

Year Adjustment

Specifies a value to increment or decrement the year value in the base date. The value should consist of integers optionally preceded by the plus (+) or minus (-) character. The plus character indicates the year value should be incremented. The minus character indicates the year value should be decremented. If a plus or minus character is not specified a plus is assumed.

The increment or decrement value is applied to the year value stored in the field for the previous record. For example, a value of -1 indicates that each subsequent record should have a date value one year earlier than the date value stored in the previous record.

Scrambling Options

These options control field scrambling used during copy, import, or export functions to produce test data.

Random

If this option is selected File Manager performs random scrambling when copying values into this date and time field. For random scrambling the same input value will produce different output values on subsequent invocations.

If this option is not selected and range Start and End values are specified File Manager performs repeatable scrambling for this date and time field. Repeatable scrambling means the same input value will produce the same output value on subsequent invocations.

For both random and repeatable scrambling, the Start and End values define the range of acceptable date and time values that File Manager can store in this field.

Start

Specifies a date and time value that is the start of a range of scrambled values that can be stored in this field when copying data into this data set. You enter the date and time value in the output format defined for this field. You can enter an = to retrieve the current date in the output format.

End

Specifies a date and time value that is the end of a range of scrambled values that can be stored in this field when copying data into this data set. You enter the date and time value in the output format defined for this field. You can enter an = to retrieve the current date in the output format.

Delete Entry panel

The Delete Entry panel is used to delete catalog entries from the IDCAMS catalog system.

Panel and field definitions

Figure 222. Delete Entry panel

```

Process  Options  Help
-----
File Manager                Delete Entry

Data Set:
  Data set name . . 'USERID.TESTCATS.ESDS1'
  Catalog ID . . . . 'CATALOG.UCATAPC'

  Volume serial(s) . MV8W28

Delete Options:
  Erase . . . . . _
  Purge . . . . . N
  Scratch . . . . . Y

Command ==>
F1=Help      F2=Split    F3=Exit     F4=CRetriev F6=List     F7=Up
F8=Down     F9=Swap    F10=Actions F12=Cancel
    
```

The following options are available:

Erase

Specify Y if the space occupied by the data set is to be overwritten with binary zeros when the data set is deleted; specify N if the space is not to be overwritten; or leave blank to use the erase option set when the catalog entry was defined or last altered.

Purge

Specify Y to delete the entry regardless of the retention period specified, otherwise specify N.

Scratch

Specify Y if the data set is to be removed from the VTOC of the volume on which it resides, otherwise specify N.

This parameter is not applicable to entries which do not have a VTOC entry.

Parent panels

- [Catalog Services panel on page 756](#)
- [Catalog Services Data Set List panel on page 759](#)

Child panels

- [Catalog Services panel on page 756](#)
- [Catalog Services Data Set List panel on page 759](#)

Equivalent functions

- None

Related tasks and examples

- [Deleting a catalog entry on page 430](#)

Disk Volume Details panel

Panel and field definitions

Figure 223. Disk Volume Details panel

Process	Options	Help			
File Manager		Disk Volume Details			
Basic Information:		Disk Geometry:			
Volser	D\$US00	Cylinders	10017		
Address	E903	Tracks/cylinder . . .	15		
Device type	3390-9	Tracks total	150255		
Volstate	PRIV/RSDNT	Bytes/track	58786		
		Total capacity	8423 MB		
VTOC Information:		Space Information:			
Start/end	00000.01-00007.14	Tracks used	120725		
Size tracks	119	% used	80		
% used	11	Tracks free	29530		
Indexed	YES	Max tracks free	1246		
Data Sets:		Cylinders free	1835		
Total	615	Max cylinders free . . .	82		
VSAM	30	DSCBs free	5282		
Non-VSAM	585	Storage Group Information:			
SMS Information:		Storage Group type . .	POOL		
SMS managed	YES	AUTO migrate	YES		
Storage group	PRIMARY	AUTO backup	YES		
		AUTO dump	NO		
		MIGR high	85		
		MIGR low	02		
Command ==>					
F1=Help	F2=Split	F3=Exit	F4=CRetriev	F7=Backward	F8=Forward
F9=Swap	F10=Actions	F12=Cancel			

Parent panels

- [Volume Summary/Selection panel on page 1097](#)

Child panels

- None

Equivalent functions

- None

Related tasks and examples

- [Displaying a Volume Table of Contents \(VTOC\) on page 432](#)

Disk/VSAM Data Functions panel

Panel and field definitions

Figure 224. Disk/VSAM Data Functions panel

Process	Options	Help
File Manager		Disk/VSAM Data Functions
1 Disk browse		Browse disk track data
2 Disk edit		Edit disk track data
3 Disk print		Print disk track data
4 Disk scan		Scan disk track data
5 Disk EOF		Write disk EOF record
6 Disk extents		Show single data set extents
7 VSAM update		Browse and update VSAM records or control intervals
8 Data In Virtual		Browse a VSAM data in virtual data set
Command ==>		
F1=Help	F2=Split	F3=Exit
F9=Swap	F10=Actions	F12=Cancel
	F4=CRetrieve	F7=Backward
		F8=Forward

Parent panels

[Primary Option Menu panel on page 970](#)

Child panels

- "Disk Browse panel"
- "Disk Track Edit panel"
- "Disk Print panel"
- "Disk Record Scan panel"
- "Write EOF Record panel"
- "Data Set Extents panel"
- "VSAM Update panel"
- "Data in Virtual Browse panel"

Related tasks and examples

- [Disk/VSAM Data Functions on page 477](#)

Display VTOC panel

The Display VTOC panel is the entry panel for the Work with VTOC utility. In this panel, you can specify a data set name or name pattern, and the disk volume or volumes with which you want to work.

Panel and field definitions

Figure 225. Work with VTOC panel

```

  Process  Options  Help
  -----
File Manager                Display VTOC

  blank Display data set list      P Print data set list
  V Display VTOC list              PV Print VTOC list
                                   PC Print VTOC and data set list

Enter one or both of the parameters below:
Data set name . . 'SYATES.UNITTEST.RFM0189.ESDS4.AIX1'
Volume serial . . D$US03 Volume status ALL Unit *
Device type . . . * SMS SG *

Processing Options:
Enter "/" to select option
- Batch execution
/ YY/MM/DD date format (default: YYYY.DDD)
/ Limited information for VTOC list
- Processing limit 0

Command ==> V
F1=Help      F2=Split      F3=Exit      F4=CRetrieve  F7=Backward  F8=Forward
F9=Swap      F10=Actions  F12=Cancel
  
```

Data set name

Can be a fully-qualified data set name or a pattern. The data set name is not a required parameter. When no data set name has been entered, File Manager uses default generic data set name of ** which eventually resolves to 'userid.**' limiting the selected data sets to the files with names starting with the current userid.

Volume serial

A fully qualified or generic volume serial number.

In a generic volume use the percent % sign to represent a single character, and an asterisk * to represent any number of characters within one qualifier. Two asterisks ** represent any number of characters within any number of qualifiers.

Volume status

A fully-qualified volume status string (can be abbreviated). Can be one of the following values:

- PRIVATE (also includes PRIV/RSDNT)
- RESIDENT
- PUBLIC
- STORAGE
- ALL (default)

Unit

A fully-qualified or generic device address (unit). In a generic name, use the percent sign (%) to represent a single character, and an asterisk (*) to represent any number characters within one qualifier.

Device type

A fully-qualified or generic device type (DEVTYPE). In a generic name, use the percent sign (%) to represent a single character, and an asterisk (*) to represent any number characters within one qualifier. For example, to list only volumes on 3390 devices, specify `3390`.

SMS SG

A fully-qualified or generic SMS storage group name. In a generic name, use the percent sign (%) to represent a single character, and an asterisk (*) to represent any number characters within one qualifier.

In an SMS environment, the reserved name, `NONSMS` selects a non-SMS controlled volume.

Batch execution

Generates JCL to run the function in batch and then displays the JCL for editing. Use Set Batch Job Card Information (option 0.4) to tailor the default JOB card that File Manager uses to generate the JCL. See [Set batch job card information \(option 0.4\) on page 82](#).

YY/MM/DD date format (default: YYYY.DDD)

Uses the YY/MM/DD date format instead of the default format of YYYY.DDD.

Limited information for VTOC list

If this option is selected, when you choose to display a VTOC list ("V" on the command line), File Manager does not collect data set statistics for the volumes processed and "N/A" is shown for the data set statistics on the Disk Volume Details panel. Select this option for better performance.

Processing limit

If this option is selected, the number of data sets selected for VTOC processing is limited to the number specified. The default of 0 allows for no limit on the number of data sets selected.

Parent panels

- [Utility Functions menu panel on page 1077](#)
- [Volume Summary/Selection panel on page 1097](#)

Child panels

- [Display VTOC Data Set List panel on page 843](#)
- [Volume Summary/Selection panel on page 1097](#)

Related tasks and examples

- [Displaying a Volume Table of Contents \(VTOC\) on page 432](#)
- [Display VTOC Batch Sort Options panel on page 840](#)

Display VTOC Batch Sort Options panel

The Display VTOC Batch Sort Options panel displays the sort options available when the **Batch execution** option or **PV** line command have been selected from the Display VTOC panel.

Panel and field definitions

Figure 226. Display VTOC Batch Sort Options panel

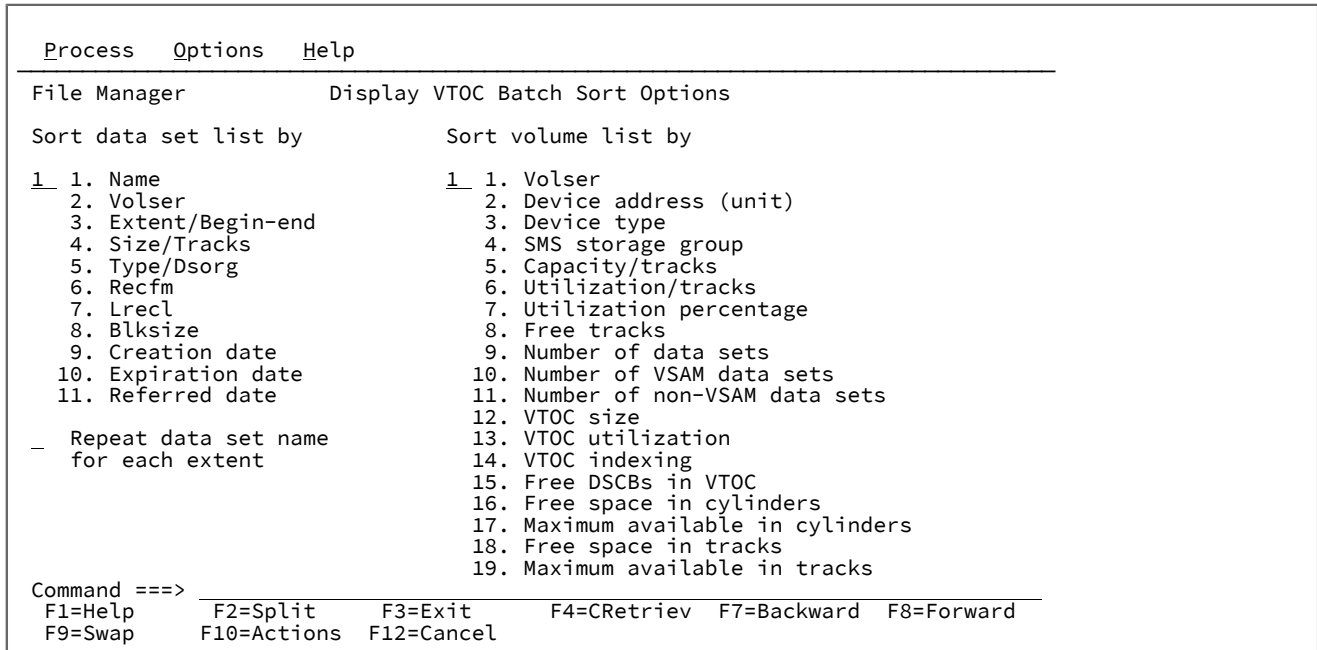

Sort data set list by

Specifies the sequence of the data sets in the Display VTOC Data Set List panel. Can be:

Name

Default. Sorted by data set name

Volser

Sorted by volume serial

Extent/Begin-end

Sorted by extent

Size/Tracks

Sorted by data set size

Type/Dsorg

Sorted by DSORG

Recfm

Sorted by RECFM

Lrecl

Sorted by LRECL

Blksize

Sorted by BLKSIZE

Creation date

Sorted by creation date

Expiration date

Sorted by expiration date

Referred date

Sorted by last referred date

Where an option other than Name is selected, the list is sorted first by the selected option and then by name.

Sort volume list by

Sorts the disks in a volume summary list. Can be:

Volser

Sorted by volume serial

Device address (unit)

Sorted by device address (unit)

Device type

Sorted by device type

SMS storage group

Sorted by SMS storage group

Capacity/tracks

Sorted by disk capacity

Utilization/tracks

Sorted by tracks used

Utilization percentage

Sorted by percentage utilization

Free tracks

Sorted by tracks available

Number of data sets

Sorted by number of data sets

Number of VSAM data sets

Sorted by number of VSAM data sets

Number of non-VSAM data sets

Sorted by number of non-VSAM data sets

VTOC size

Sorted by VTOC size

VTOC utilization

Sorted by VTOC utilization in %

VTOC indexing

Sorted by VTOC indexing

Free DSCBs in VTOC

Sorted by VTOC free DSCB

Free space in cylinders

Sorted by cylinders available

Maximum available in cylinders

Sorted by maximum free space in cylinders

Free space in tracks

Sorted by tracks available

Maximum available in tracks

Sorted by maximum free space in tracks

The option takes effect only when the V (Display VTOC list), PV (Print VTOC list), or PC (Print VTOC and data set list) commands are executed.

Repeat data set name for each extent

Uses an alternate format for displaying or printing the data set name for multi-extent data sets. The default format suppresses the data set name on the second and subsequent extents. When you select this option, the data set name appears for each extent.

Parent panels

- [Display VTOC panel on page 837](#)

Child panels

None.

Related tasks and examples

- [Displaying a Volume Table of Contents \(VTOC\) on page 432](#)

Display VTOC Data Set List panel

The Display VTOC Data Set List panel shows the list of VTOC entries that match the information entered on the Display VTOC panel.

Panel and field definitions

Figure 227. Display VTOC Data Set List panel

Process	Options	Help				
File Manager		Display VTOC Data Set List	Row 00001 of 00055			
Unit *	DSN	'PAM.V99R1M0.S*'				
DevType *	VOLSTATE	ALL	SMS SG *			
Volumes 10	Data sets	27	VSAM 0	non-VSAM 27		
VOLSER *	Trks used	3752	Free N/A	Utilized N/A		
	Data Set Name		Seq	Volume	Begin	CYL-HD ±
	PAM.V99R1M0.S*		*	*		
	PAM.V99R1M0.SPAMCLIB		1	D\$FM08	32	14
	PAM.V99R1M0.SPAMDBRM		1	D\$FM09	8802	4
	PAM.V99R1M0.SPAMEXEC		1	D\$FM10	1060	0
	PAM.V99R1M0.SPAMMAC1		1	D\$FM00	7885	1
	PAM.V99R1M0.SPAMMENU		1	D\$FM19	172	13
	PAM.V99R1M0.SPAMMJPN		1	D\$FM09	9025	8
	PAM.V99R1M0.SPAMMKOR		1	D\$FM03	6363	10
	PAM.V99R1M0.SPAMMODA		1	D\$FM02	2881	0
	PAM.V99R1M0.SPAMMODA		2	D\$FM02	109	0
	PAM.V99R1M0.SPAMMODA		3	D\$FM02	109	10
	PAM.V99R1M0.SPAMMODA		4	D\$FM02	110	5
	PAM.V99R1M0.SPAMMODA		5	D\$FM02	111	0
Command	====>		Scroll PAGE			
F1=Help	F2=Split	F3=Exit	F4=CRetriev	F5=RFind	F6=Process	
F7=Up	F8=Down	F9=Swap	F10=Left	F11=Right	F12=Cancel	

Example

Available commands

You can use the following primary command on this panel:

FIND

Finds the next occurrence of a character string in the Data Set Name area. Allows for a string argument which might contain the * and % wildcard characters. The FIND argument is matched against the data set names using the default system match rules for such wildcard characters.

You can also use the following line commands in the prefix command area:

ALTER (A)

Invokes the Catalog Services Alter function which lets you change some data set attributes, such as expiration date and data set name (this functionality is only available for cataloged data sets).

BROWSE (B)

Invokes Browse (option 1).

CATALOG (CA)

Catalogs the data set (if not already cataloged).

COPY (C)

Copies the selected entry. Invokes the Copy Utility (3.3) with the *“from”* data set prefilled to the selected data set. If the input data set is cataloged, the volume information is not prefilled.

DELETE (D)

Deletes the data set, and uncatalogs it if cataloged.

EDIT (E)

Invokes Edit (option 2).

EXTENTS (EX)

Displays a pop-up panel showing the data set extents.

INFO (I)

Displays detailed information about the selected data set.

MEMBER (M)

If entered for a library data set entry, displays a member list.

PRINT (P)

Invokes Print Utility (option 3.2).

RENAME (REN)

This is a synonym for Alter with non-VSAM data sets and it works identically. For VSAM data sets it invokes a separate VSAM Entry Rename panel.

UNCAT (U)

Uncatalogs the data set (if cataloged).

Caution: uncataloging an SMS-managed data set might leave the data set in an unusable state.

VIEW (V)

Invokes AFP Print Browse (option 3.7).

Parent panels

- [Display VTOC panel on page 837](#)

Child panels

- None.

Value entered**Resultant value****AND**

AND

&

AND

OR

OR

|

OR

**Note:** Abbreviations are accepted. For example, overwrite `AND` with `&` and it is changed to `OR`.

(

Left Parenthesis - Parentheses must only be used on lines containing expressions. They are used to group record selection criteria. The number of left parentheses must match the number of right parentheses.

Start

An editable field in which you can enter or edit a field's starting column number. This must be between 1 and the record length or, if you specify a `+` sign optionally followed by an offset number (default zero), the start location is calculated as:

```
(previous field start) + (previous field length) + offset
```

For example, `+0` starts at the next contiguous location and `+4` starts 4 bytes past the next contiguous location.

Length

An editable field in which you can enter or edit the length of a field. For most fields, this can be from 1 to the maximum length dictated by the record but the Start value plus the Length of the field should not exceed the record length. Restrictions apply for some field types:

If the Type is:**then Length must be:****BI**

2, 4 or 8

FE

> 6 and < 24. The precision is the length minus 6. The scale is the precision minus 1. Graphic and DBCS strings must be an even number of bytes.

FP

4 or 8

PD

between 1 and 16

ZD

between 1 and 32

Type

An editable field in which you can enter or edit the data type of a field. This must be one of:

AN

Alphanumeric

AX

Alphanumeric displayed in long hexadecimal.

B

Binary

BI

Binary

BT

Bit string

C

Alphanumeric

DB

DBCS string

FE

Floating point (external)

FP

Floating point (internal)

G

Graphic string

P

Packed decimal

PD

Packed decimal

VB

Varying bit

VC

Varying character

VD

Varying DBCS

VG

Varying graphic

Z2

Null-terminated varying-length(VARYINGZ) DBCS string

ZA

Unsupported zoned decimal edited

ZC

Varying character null terminated

ZD

Zoned decimal

ZG

Varying graphic null terminated

Field Name

An editable field in which you can enter or edit the field names in your dynamic template. The name can consist of any characters, including spaces, up to a maximum of 35.

If the Start, Length and Type fields are filled in but the Field Name is left blank, a name is generated in the form `@@DTnn` where *nn* is the field number. The name is generated either on exit or when you perform a template edit. Existing field names taking the form `@@DTnn` are regenerated to ensure *nn* always reflects the current field number.



Note: If you are running a screen width of 115 or greater, the Field Name field can be displayed at the same time as the Start, Length and Type fields. However, at any width less than this, you need to toggle the display between Field Name and Start, Length and Type. The default is to display Start, Length and Type. To toggle the display, ensure that your cursor is not in a Value field and press the Right function key (F10) or Left function key (F11).

Op

Operator - used to create record selection expressions. Valid operators are:

=, EQ

True if the terms are equal (numerically or when padded)

\=, \=, /=, NE

True if the terms are not equal (inverse of =)

>, GT

Greater than

<, LT

Less than

><, <>

Greater than or less than (same as not equal)

>=, GE

Greater than or equal to

\<, \<

Not less than

<=, LE

Less than or equal to

\>, \>

Not greater than

==

True if terms are strictly equal (identical)

\==, \==, /==

True if the terms are NOT strictly equal (inverse of ==)

>>

Strictly greater than

<<

Strictly less than

>>=

Strictly greater than or equal to

\<<, \<<

Strictly NOT less than

<<=

Strictly less than or equal to

ACO

Contains all of the values specified. Matching case sensitive. The negative form is XCO.

ACU

Contains all of the values specified. Matching not case sensitive. The negative form is XCU.

CO

Contains one of the values specified. The negative form is -CO.

CU

Contains one of the values specified. Matching not case sensitive. The negative form is -NC.

NC

Numeric contains - a number is one of the values. The negative form is -NC.

NN

(Same as -NU.) Field does not contain a valid numeric for the field type. The positive form is NU.

NR

Not in range - field < value1 or field > value2. The positive form is RG.

NU

Field contains a valid numeric for the field type:

Field type

Test for being valid numeric

BI, FE, FP, PD, and ZD

Checked against the field definition

Other

Recognized as numeric if the display value or character value the field contains is a valid number. The valid number can contain anything that is valid for a floating-point external or decimal number. For example:

```
-1234.55  
+3.4621E+10
```

The negative form is -NU.

RG

Range - value1 >= field <= value2. The negative form is NR.

XCO

Does not contain all of the values. Matching case sensitive. The positive form is ACO.

XCU

Does not contain all of the values specified. Matching case sensitive. The positive form is ACU.

-CO

Does not contain one of the values specified. The positive form is CO.

-CU

Does not contain any of the values specified. Matching not case sensitive. The positive form is CU.

-NC

Does not contain the specified number(s). The positive form is NC.

-NU

(Same as NN.) Field does not contain a valid numeric for the field type. The positive form is NU.

VER

Verify this field is composed only of characters specified in the **Value** column.

Value

Use this field to provide a character or numeric constant to be used for comparison in the expression. If the operator supports more than one value (for example, RG, CO) then use comma delimiters to provide separate values.

You can use up to 255 characters in this field, and use the Left and Right primary commands or function keys to scroll within the field.

When specifying values, the following rules apply:

Hexadecimal strings

A hexadecimal string must be in the form 'hhhhh'h'x or x'hhhhh'. The value enclosed in quotation marks must be an even number of characters and contain valid hexadecimal characters.
(0123456789ABCDEF).

Binary strings

A binary string must be in the form 'nnnnn'n'b or b'nnnnn'. The value enclosed in quotation marks must be a combination of 0 and 1s.

Numeric Operands

The value(s) specified for a numeric field type must be a valid number. Quoted values are not accepted.

Character strings

For non-numeric types the value is automatically enclosed in quotation marks if you do not specify them. When specifying more than one value for operations other than RG and NR you must provide quotation marks for all the comma delimited values

Date strings

A date string must be in the form `d'xxxxxxx'`. The string must be specified in the output format defined for the field.

The following is an example of a date value:

```
d'Jan 01, 2014'
```

where the output format is:

```
Mmm DD, YYYY
```

Time strings

A time string must be in the form `t'xxxxxxx'`. The string must be specified in the output format defined for the field.

The following is an example of a time value:

```
t'15:30:00.000'
```

where the output format is:

```
HH:MI:SS.999
```

**Note:**

1. Date and time strings cannot be used with contains operators.
2. When used with range operators requiring two values the second value should be quoted, for example, `d'Jan 01, 2014', 'Dec 01, 2014'`
3. Use `d'='` or `t'='` to retrieve the current date or time value in the output format.

)

Right Parenthesis - Parentheses must only be used on lines containing expressions. They are used to group record selection criteria. The number of left parentheses must match the number of right parentheses.

Parent panels

- [Browse panel on page 746](#)
- [Browse Entry panel on page 751](#)
- [Editor panel on page 853](#)
- [Edit Entry panel on page 862](#)
- [Compare Utility: "Old" and "New" panels on page 764](#)
- [Copy From panel on page 789](#)

- [Copy To panel on page 796](#)
- [Data Create Utility panel on page 824](#)
- [Find/Change Utility panel on page 901](#)
- [Print Utility panel on page 977](#)
- [Template Workbench panel on page 1072](#)

Child panels

- The display panel that would normally result from your starting Entry panel.

Equivalent functions

- None.

Related tasks and examples

- [Creating dynamic templates on page 214](#)

Editor panel

You use the Editor panel to display a selected data set or data set member, scroll through the records and find and change specific information within the records. You can also use this panel to insert or delete new records, join or split existing records and copy or repeat records within the data set.

The Editor panel displays different fields, depending upon the type of data set shown and whether or not a template has been used.

Panel and field definitions

Figure 229. Editor panel showing text file

```

Process  Options  Help
-----
Edit          FMN.V14R1M20.SFMNSAM1(FMNCDATA)          Rec 33 of 40
          Col 1          Insert length 80          Format CHAR
          -----1-----2-----3-----4-----5-----6-----7-
***** **** Top of data ****
000001      01 REC-TYPE01.
000002      03 REC-TYPE          PIC XX.
000003      03 NAME          PIC X(20).
000004      03 EMPLOYEE-NO    PIC 9(4) BINARY.
000005      03 AGE          PIC 9(4) BINARY.
000006      03 SALARY        PIC 9(7) PACKED-DECIMAL.
000007      03 MONTH
000008          PIC 9(8) BINARY OCCURS 12 TIMES.
000009      03 FILLER          PIC XX.
***** **** End of data ****

Command ==>
F1=Help      F2=Zoom      F3=Exit      F4=CRetrieve  F5=RFind      F6=RChange
F7=Up        F8=Down      F9=Swap      F10=Left     F11=Right    F12=Cancel

```

Title

The Title identifies the function (Edit) and the data set being used. For a PDS or PDSE member, the data set name includes the member name. Record number information, or short messages, appear to the right.

Col

The Col field shows the column number of the column that is currently at the far left of the data area. You can scroll to a specific column (left or right) by typing a new value. The default value for this field is 1.

Insert length

The Insert length field specifies the initial length of inserted records. The possible range of values is from 1 to 9999999, depending on the data set characteristics. The default value is the maximum record length as defined in the catalog. When a User I/O exit is being used, the insert length value is adjusted to the maximum length accepted by the exit for the data set being edited.

Scale

The Scale shows the columns of the data area.

Prefix area (line numbers)

Area (if displayed) displaying the record number of each line in the data set. This area also doubles as the prefix command entry area.

You can use the following prefix commands when editing:

A

Identifies the record after which data is to be moved or copied.

A "K" can be appended to the A to indicate that the source is to be used with multiple destinations. The last destination must not contain the K append so that File Manager knows the command set is complete. No part of the command set is executed until the command set is complete.

B

Identifies the record before which data is to be moved or copied.

A "K" can be appended to the B to indicate that the source is to be used with multiple destinations. The last destination must not contain the K append so that File Manager knows the command set is complete. No part of the command set is executed until the command set is complete.

BND

(Available only in CHAR, HEX and LHEX display formats.) Displays a bounds line on the following line, indicating the columns searched by the CHANGE, FIND, and EXCLUDE commands. To change the bounds, type a < on the bounds line to define the left bound and a > to define the right bound. To remove the bounds line from the display, use the D prefix command or the RESET SPECIAL primary command.

C

Copy one record.

Cn

Copy *n* records.

CC

Copy block of records. Mark start and end of block.

COLs

Displays the column identification line (CHAR, HEX, and LHEX display formats only).

D

Delete one record.

Dn

Delete *n* records.

DD

Delete block of records. Mark start and end of block.

F

Display the first record of a block of excluded records.

FC

Changes the display format to CHAR.

FH

Changes the display format to HEX.

FL

Changes the display format to LHEX.

FS

Changes the display format to SNGL.

FT

Changes the display format to TABL.

Fn

Display the first *n* records of a block of excluded records.

I

Insert one empty record.

If the display format is CHAR, HEX or LHEX, then the entire record is initialized to blanks.

If the display format is TABL, then the record is initialized according to the record structure of the current record type:

- Numeric fields are initialized to zero.
- Alphanumeric fields are initialized to blanks.
- If the record type contains a variable-length array, then the record is initialized with the minimum number of array elements, and the array size field (or fields, for multi-dimensional arrays) is initialized accordingly.

In

Insert n empty records.

L

Display the last record of a block of excluded records.

Ln

Display the last n records of a block of excluded records.

LC

Translate all uppercase characters in a record contents to lower case (see **Caution** in LCC).

LCn

Translate all uppercase characters in n records to lower case (see **Caution** in LCC).

LCC

Translate all uppercase characters in a block of records to lower case. Mark start and end of block.



CAUTION: The LC commands (LC, LCn, LCC) affect all characters in a record, not just characters in those fields with an alphanumeric or character data type. This means that numeric data, such as binary data or packed decimal data, can be corrupted by using these commands.

M

Move one record.

Mn

Move n records.

MM

Move block of records. Mark start and end of the block.

O

The O (overlay) command indicates the target when you want to merge lines. Overlay is used in conjunction with move and copy commands.

A "*K*" can be appended to the *O* to indicate that the source is to be used with multiple destinations. The last destination must not contain the *K* append so that File Manager knows the command set is complete. No part of the command set is executed until the command set is complete.

O

Overlay one record.

On

Overlay *n* records.

OO

Overlay block of records. Mark start and end of the block.

P

Identifies the record preceding which data is to be moved or copied. This is synonymous with the *B* prefix command.

R or "

Repeat one record.

Rn or "n

Repeat *n* records.

RF

Perform a refresh of the record. (Shared files only.)

RFn

Perform a refresh of *n* records. (Shared files only.)

RFF

Perform a refresh of a block of records. Mark start and end of the block. (Shared files only.)

RR or ""

Repeat block of records. Mark start and end of the block.

RRn or ""n

Repeat block of records *n* times. Mark start and end of block.

SV

Perform a save of the record. (Shared files only.)

SVn

Perform a save of *n* records. (Shared files only.)

SVV

Perform a save of a block of records. Mark start and end of the block. (Shared files only.)

UC

Translate all lowercase characters in a record to upper case (see **Caution** in UCC).

UCn

Translate all lowercase characters in *n* records to upper case (see **Caution** in UCC).

UCC

Translate all lower case characters in a block of records to upper case. Mark start and end of block.



CAUTION: The UC commands (UC, UC*n*, UCC) affect all characters in a record, not just characters in those fields with an alphanumeric or character data type. This means that numeric data, such as binary data or packed decimal data, can be corrupted by using these commands.

V

(Available only when you are using a template.) Display currently suppressed records of the record type indicated by the shadow line. Records of other record types are suppressed from display.

X

Exclude record from display. If the display of excluded record shadow lines is enabled (see [SHADOW primary command on page 1220](#)), a shadow line is shown indicating how many records are being excluded at this position. To show an excluded record, use the F or LA prefix command.

Xn

Exclude *n* records from display. If the display of excluded record shadow lines is enabled (see [SHADOW primary command on page 1220](#)), a shadow line is shown indicating how many records are being excluded at this position.

XX

Exclude block of records from display. Mark start and end of block. If the display of excluded record shadow lines is enabled (see [SHADOW primary command on page 1220](#)), a shadow line is shown indicating how many records are being excluded at this position.

.xxxx

Label a line. The label, *xxxx*, is a string of 1 to 4 alphabetic characters, that does not start with the character "Z" (labels starting with "Z" are system labels). Labels can be assigned to any data line. Labels cannot be assigned to the bounds line or to shadow lines.

)

Shift record right one position.⁷)*n*Shift record right *n* positions.⁷

))

Shift block of records right one position. Mark start and end of block.⁷))*n*Shift block of records right *n* positions. Mark start and end of the block.⁷

(

Shift record left one position.⁸(*n*Shift record left *n* positions.⁷

((

Shift block of records left one position. Mark start and end of block.⁷((*n*Shift block of records left *n* positions. Mark start and end of block.⁷

/

Position record at the top of the screen.

Data Area

The Data Area shows the data in the selected display format. For a description of the different display formats, see [Selecting a display format on page 105](#).

Command

The Command line is a field in which you can enter Primary Commands, such as CHANGE.

Scroll

The Scroll field defines the current scroll amount. You can type a new value.

When a VSAM data set is displayed, additional fields can be seen.

7. The shift occurs only for that part of the record within the current bounds limit. See [Setting bounds on page 154](#) for a detailed explanation.

8. The shift occurs only for that part of the record within the current bounds limit. See [Setting bounds on page 154](#) for a detailed explanation.

Figure 230. Edit panel showing VSAM data set

```

Edit          FMN.REQ77.RRDS                      Rec 0
Type RRDS                                         Format CHAR
Col 1_____ Insert length 4089
-----+-----1-----+-----2-----+-----3-----+-----4-----+-----5-----+-----6-----+-----7-
*****      **** Top of data      ****
000001 xxxxxxxyy orig 1
    
```

Type

The type of VSAM data set, for example, RRDS. IAM files are also indicated.

When a data set is displayed in TABL format with a template, the column headings show the field names defined in the template.

Figure 231. PDSE member in TABL format

```

Edit          FMN.V14R1M20.SFMNSAM1(FMNCDATA)      Rec 13 of 40
                                           Format TABL
REC-TYPE NAME          EMPLOYEE-NO    AGE    SALARY    MONTH(1)
#2        #3          #4        #5        #6        #7
AN 1:2    AN 3:20      BI 23:2 BI 25:2 PD 27:4 BI 31:4
<>        <-----+-----1-----+-----> <----+> <----+> <-----+-----> <-----+----->
*****      **** Top of data      ****
000001 01          GRAHAM JONES          5512    94    68000    7
    
```

When a data set is displayed in SNGL format with a template, the field and record number of the current record is shown.

Figure 232. PDSE data set in SNGL format

```

Edit          FMN.V14R1M20.SFMNSAM1(FMNCDATA)      Rec 13 of 40
Current type is REC-TYPE01
                                           Format SNGL
Top Line is 1 of 32 in Record 3
Ref Field  Picture Typ Start  Len  Data
2 REC-TYPE          XX    AN    1    2    01
3 NAME            X(20)  AN    3   20  Graham Jones
4 EMPLOYEE-NO      9(4)   BI    23   2   5512
5 AGE              9(4)   BI    25   2    94
6 SALARY           9(7)   PD    27   4  68000
    
```

Example

Available commands

- [APPEND and APPENDX primary commands on page 1119](#)
- [BOTTOM primary command on page 1122](#)
- [BOUNDS primary command on page 1123](#)
- [CANCEL primary command on page 1124](#)
- [CAPS primary command on page 1124](#)
- [CASE primary command on page 1125](#)
- [CE \(Change Error\) primary command on page 1126](#)
- [CEDIT primary command on page 1128](#)
- [CHANGE/CX primary command on page 1129](#)
- [COPY primary command on page 1138](#)

- CREATE, CREATEX primary commands on page 1141
- DEDIT primary command on page 1142
- DELETE (records) primary command on page 1144
- DOWN primary command on page 1146
- END primary command on page 1148
- EXCLUDE/XX primary command on page 1148
- EXIT primary command on page 1153
- FE (Find Error) primary command on page 1154
- FILE primary command on page 1157
- FIND/FX primary command on page 1157
- FORMAT primary command on page 1170
- HEX primary command on page 1172
- JOIN primary command on page 1176
- JUST primary command on page 1177
- LEFT primary command on page 1178
- LOCATE primary command on page 1182
- NEXT primary command on page 1191
- NEXTREC primary command on page 1192
- OFFSET primary command on page 1193
- PIC primary command on page 1197
- PREVREC primary command on page 1199
- PREFIX primary command on page 1197
- PREVIOUS primary command on page 1198
- PROFILE primary command on page 1200
- RD primary command on page 1201
- RDF primary command on page 1203
- RECOVER primary command on page 1204
- RECSTATS primary command on page 1205
- REFS primary command on page 1206
- REPLACE, REPLACEX primary commands on page 1207
- RP primary command on page 1214
- RECLLEN primary command on page 1204
- RESET primary command on page 1208
- RFIND primary command on page 1211
- RIGHT primary command on page 1212
- SAVE primary command on page 1215
- SAVEAS primary command (templates) on page 1216
- SHADOW primary command on page 1220
- SHOW (REC) primary command on page 1222
- SLOC primary command on page 1224
- SORT primary command on page 1224
- SPLT primary command on page 1227

- [SPLTJOIN primary command on page 1228](#)
- [STR primary command on page 1228](#)
- [TEDIT primary command on page 1231](#)
- [TOP primary command on page 1232](#)
- [TVIEW primary command on page 1233](#)
- [TYPE primary command on page 1233](#)
- [UP primary command on page 1234](#)
- [VIEW primary command on page 1237](#)
- [ZOOM primary command on page 1239](#)

Parent panels

- [Browse Entry panel on page 751](#)

Child panels

- [Template Workbench panel on page 1072](#) (to invoke the panel, enter the TVIEW primary command).
- [Record Type Selection panel on page 998](#) (to invoke the panel, enter the TEDIT primary command - panel displays when template contains more than one record type).
- [Field Selection/Edit panel on page 891](#) (to invoke the panel, enter the TEDIT primary command - panel displays when using a copybook template with only one record type).
- [Dynamic Template panel on page 845](#) (to invoke the panel, enter the TEDIT primary command - panel displays when using a dynamic template).
- [Record Selection Criteria panel on page 991](#) (to invoke the panel, enter the CEDIT primary command).
- [Record Identification Criteria panel on page 982](#) (to invoke the panel, enter the CEDIT ID primary command).

Equivalent functions

- [DSE \(Data Set Edit\) on page 1342](#)
- [DSEB \(Data Set Edit Batch\) – batch only on page 1351](#)
- [DSU \(Data Set Update\) – batch only on page 1462](#)

Related tasks and examples

- [Viewing and changing data sets on page 87](#)

Edit Entry panel

You use the Edit Entry panel to select a data set for editing in the Edit panel.

The Edit Entry panel is the same as the View Entry panel, with two more options, **Inplace edit** and **Create audit trail**. For an explanation of the fields in this panel, see the field definitions in [View Entry panel on page 1092](#).

Panel and field definitions

Figure 233. Edit Entry panel

Process	Options	Help
File Manager		
Edit Entry Panel		
Input Partitioned, Sequential or VSAM Data Set, or HFS file:		
Data set/path name	'FMNUSER.EXPORT'	+
Member	_____	Blank or pattern for member list
Volume serial	_____	If not cataloged
Start position	_____	+
Record limit	_____	Record Sampling _____
Inplace edit	_____	(Prevent inserts and deletes)
Copybook or Template:		
Data set name	_____	
Member	_____	Blank or pattern for member list
Processing Options:		
Copybook/template	Start position type	Enter "/" to select option
<u>1</u> 1. Above	1. Key	— Edit template Type (1,2,S)
2. Previous	2. RBA	— Include only selected records
3. None	3. Record number	— Binary mode, reclen _____
4. Create dynamic	4. Formatted key	— Create audit trail
		— Use I/O exit
Command ==>		
F1=Help	F2=Split	F3=Exit
F9=Swap	F10=Actions	F12=Cancel
	F4=Expand	F7=Backward
		F8=Forward

Inplace edit

If you select this option, the edit session does not allow you to insert or delete records.

If you deselect this option, then for QSAM, VSAM ESDS and VSAM RRDS data sets that are larger than the available virtual storage, or when using this in conjunction with a start position or record limit, File Manager uses an auxiliary file in order to allow rewriting of the data set.

Inplace edit is implied when using any of the following:

- A segmented record type data set, as indicated by your chosen template, with selection criteria specified in the template.
- A segmented record type data set, as indicated by your chosen template, and the data set is fixed blocked QSAM or VSAM RRDS.
- Record sampling,
- A record limit of "MEMORY", or
- A VSAM data set defined as NOREUSE
- Include only selected records.

Create audit trail

Determines if File Manager generates an audit report of all successful modifications to data made during an Edit session.

The display of this option depends on whether SAF-rule controlled is in effect. See [SAF-rule controlled auditing on page 85](#).

The ability to change this option depends on the installation options (in the FMN0POPT macro).

When your system administrator has enforced audit logging, the **Create audit trail** option in this panel is ignored.

When your system administrator has not enforced audit logging, you can set this option on or off for any particular editing task. Type a "/" in the option entry field to generate audit reporting for the current Edit session.

For more information about setting the Audit Trail options, refer to the *File Manager for z/OS Customization Guide* or see your systems administrator.

Parent panels

- [Primary Option Menu panel on page 970](#)

Child panels

Depending upon the options selected in the Edit Entry panel, the next panel displayed can be:

- [Editor panel on page 853](#)
- [Data Set Selection panel on page 829](#) (a pattern has been entered in the Data set name field)
- [Member Selection panel on page 946](#) (a pattern or a blank has been entered in the Member field)
- [Record Type Selection panel on page 998](#) (Edit Template is selected and the specified template was based on a copybook with more than one record type).
- [Field Selection/Edit panel on page 891](#) (Edit Template is selected and the specified template was based on a copybook with only one record type).
- [Dynamic Template panel on page 845](#) (Create Dynamic option is selected or Edit Template is selected and the specified template was created dynamically).
- [Personal Data Set List panel on page 966](#) (Current® Data Set List option selected from the Process drop-down menu, or REFL fastpath command entered).
- [Personal Data Set Lists panel on page 968](#) (Personal Data Set Lists option selected from the Process drop-down menu, or REFD fastpath command entered).

Equivalent functions

- [DSC \(Data Set Copy\) on page 1302](#)

Related tasks and examples

- [Browse Entry panel on page 751](#)
- [Copying data sets on page 341](#)
- [Supplying a procedure when using a File Manager panel on page 530](#)

Edit Personal Data Set List panel

The Edit Personal Data Set List panel displays the contents of a data set list and allows you to edit it by changing or deleting existing entries or adding more entries.

Panel and field definitions

Figure 234. Edit Personal Data Set List panel

Process	Options	Help
File Manager	Edit Personal Data Set List JLLIST1	Row 1 to 4 of 30
Enter EXIT command to save changes, CANCEL command to exit without saving.		
I=Insert a list entry R=Repeat a list entry D=Delete a list entry		
Partitioned, Sequential, VSAM Data Set, or HFS file		
/ Copybook or Template / Entry Description		Member Volume
'FMNUSER.DATA'		DATA1
'FMN.V14R1M20.SFMNSAM1'		FMNCCPY
'FMNUSER.DATA'		DATA5
'FMN.V14R1M20.SFMNSAM1'		
DESCRIP OF DATA5		
'FMNUSER.DATA'		DATA4
'FMN.V14R1M20.SFMNSAM1'		FMNCCPY
Command ==>		
F1=Help	F2=Split	F3=Exit
F9=Swap	F10=Actions	F12=Cancel
	F4=Expand	F7=Backward
		F8=Forward

①

Line command entry field. Valid values are:

I

Insert a list entry

R

Repeat a list entry

D

Delete a list entry

②

Data set name

③

Member name

④

Volume serial number

⑤

Data set name of copybook or template

6

Member name of copybook or template

7

Description line for entry

Parent panels

- [Personal Data Set List panel on page 966](#)
- [Personal Data Set Lists panel on page 968](#)

Child panels

- None.

Equivalent functions

- None.

Related tasks and examples

- [Working with data set lists on page 320](#)

Edit/View - Copy panel

The Edit/View - Copy panel allows you to specify details about the data you want to copy into a data set.

File Manager displays this panel when you enter the COPY primary command in a browse or edit session but without specifying the data set or member of a partitioned data set from which the data is to be copied.

Panel and field definitions

Figure 235. Edit/View - Copy panel

```

  Process  Options  Help
  _____
File Manager                      Edit/View - Copy

From Data set:
Data set/path name . . 'JHELVON.TEST.DATA' _____ +
Member name (or mask) . : _____
Volume serial . . . . . : _____

Line Numbers (Blank for entire member or data set)
First line . . . . . : _____
Last line . . . . . : _____

Press Enter key to copy, enter End command to cancel copy.

Processing Options:
Enter anything to select option
_ Binary mode, reclen _____

Command ==>
F1=Help      F2=Split    F3=Exit     F4=Expand   F7=Backward F8=Forward
F9=Swap      F10=Actions F12=Cancel

```

Data set/path name

Can be a fully-qualified data set name or a pattern, or a HFS file or directory. The data set name may include a member name or name pattern in parenthesis. If the member is specified here, the associated **Member name (or mask)** field must be empty.

When you specify an HFS file or directory, you must enter a full path name. If the path name is longer than the displayed entry field, press the Expand function key (F4) to display a pop-up window in which you can enter a longer name.

Member name (or mask)

If you specified the name of a partitioned data set (PDS) without including a member name or name pattern in parenthesis in the **Data set name** field, then you can use this field to specify the member name or a member name pattern.

Volume serial

Serial number of the volume which contains the data set. Required for data sets which are not cataloged.

First line

The number of the first line in the source file from which you want to copy data.

Last line

The number of the last line in the source file from which you want to copy data.

Binary mode

When processing an HFS file, allows you to specify binary mode (selected) or text mode (unselected).

reclen

When processing an HFS file and the **Binary mode** option is selected, records are derived based on the fixed record length specified. The default is 80.

Can be in the range: 1–32760

Parent panels

- [Browse Entry panel on page 751](#)
- [Editor panel on page 853](#)

Related tasks and examples

- [Copying data from another data set on page 169](#)

Editor Options panel

The editor options control various options used to format the display or print of data when viewing, editing, or printing.



Note: The editor options are displayed on 3 panels ("Editor Options (1 of 3)" through to "Editor Options (3 of 3)").

To navigate from one panel to the next, press F11 (NxtPage) or F10 (PrvPage).



For simplicity, the contents of all 3 panels are shown together in [Figure 236: Editor Options panel on page 869](#).

Panel and field definitions

Figure 236. Editor Options panel

```

Process  Options  Help
-----
File Manager                Editor Options (all 3 panels combined)

Related command if applicable, shown in ()
Initial Display
1 1. Previous
  2. Table
  3. Single
  4. Character
  5. Hex
  6. LHex

Miscellaneous:      Enter "/" to select option
/ Recognize and interpret ISPF packed data
_ CAPS initially ON - translate changed data to uppercase (CAPS)

Maximum virtual storage allowed for Edit and View  0_____

Related command if applicable, shown in ()
Grouping and Hiding options:      Enter "/" to select option
Expose (do not group) records of types:      (SHOW)
/ Not selected / Suppressed / Length error
See shadow lines (deselect to hide) for groups of: (SHADOW)
/ Not selected / Suppressed / Excluded

Multi-line display format options: (TABL/CHAR/HEX/LHEX)
/ Display prefix area (PREFIX on/off)
_ Display prefix area on the right (PREFIX RIGHT)
A Prefix area width (A,6,7,8,9) (PREFIX _)
_ Display record length (RECL on/off)
_ Display record length on the right (RECL RIGHT)
A Record length width (A,3,4,5,6) (RECL _)
_ Display RBA and Length when browsing VSAM (RBALEN on/off)

Related command if applicable, shown in ()
Formatted display options:
/ Field reference number (REF) / Field type and length values (TYPE)
_ Picture clause (PIC) _ Start location (SLOC)
_ Structure (STR) _ Left justify numeric fields (JUST)
/ Redefined fields (RDF) / CCSID (CCSID)

Command ==>
F1=Help      F2=Split      F3=Exit      F7=Backward  F8=Forward  F9=Swap
F10=PrvPage  F11=NxtPage  F12=Cancel

```

Initial Display

1. Previous

At the start of an editor session, the display format field (**Format**) on the View or Edit panel is pre-filled with the value specified in the previous editor session. This is default.

2. Table

At the start of an editor session, the View or Edit panel is displayed in TABL display format.

For data that has not been formatted with a template, the View or Edit panel is displayed in CHAR display format.

3. Single

At the start of an editor session, the View or Edit panel is displayed in SNGL display format.

For data that has not been formatted with a template, the View or Edit panel is displayed in CHAR display format.

4. Character

At the start of an editor session, the View or Edit panel is displayed in CHAR display format.

5. Hex

At the start of an editor session, the View or Edit panel is displayed in HEX display format.

6. LHex

At the start of an editor session, the View or Edit panel is displayed in LHEX display format.

Recognize and interpret ISPF packed data

When this option is selected, File Manager checks the data in the data set or member being edited (or viewed) to determine if it has been written with the ISPF PACK option. If it had, File Manager then unpacks the data to allow it to be edited or viewed in the normal fashion. If the data set is too large to be contained in memory, File Manager cannot edit or view the data set in unpacked form, but instead provides the data set in its packed form. If this option is deselected, File Manager does not check the data and edit or view operates on the record data in its "as is" state.



Note: This option allows you to work with packed data in PDS or PDSE data sets. File Manager does not support working with packed data in VSAM data sets.

CAPS initially ON - translate changed data to uppercase (CAPS)

Translates data entered in input fields into uppercase.

Maximum virtual storage allowed for Edit and View

The maximum number of kilobytes of storage that the editor can use when reading in data. If the initial read of the data would require more storage than this value, other editing techniques (for example, using an auxiliary file, or an inplace edit) are substituted instead.

The amount of storage that the editor uses to hold records is at least

$$(\text{Number of records} * (112 + \text{record length}))$$

To allow edit to use as much storage as is available, set the value to 0.

The default is 0, unless otherwise set in FMN0POPI during customization. As the editor typically obtains storage in 512KB blocks, if this number is greater than zero, the actual usage may be adjusted to a minimum of 512 or rounded up to the next 512.

Expose (do not group) records of types:**Not selected**

Exposes or shows not-selected records. Selecting this option has the same effect as if the SHOW NOT ON command has been entered. If a SHOW command is entered during a File Manager session, it resets this option for the session.

Suppressed

Exposes or shows suppressed records. Selecting this option has the same effect as if the SHOW SUP ON command has been entered. If a SHOW command is entered during a File Manager session, it resets this option for the session.

Length error

If a record matches the record identification criteria for a record type in the template, but the record length is outside the valid range for the record type, then match the record with that type anyway.

If no record identification criteria are defined, and the length of a record does not fall within the valid range of any record type in the template, then match the record with the first record type in the template anyway.

In Edit, display =LGTH in the record prefix area.

If you do not select this option, then records whose length do not match a record type in the template are not selected, even if they match the record identification criteria for a record type.

There is no equivalent primary command for this option.

See shadow lines (deselect to hide) for groups of:**Not selected**

Show shadow lines for not-selected records. Equivalent to the SHADOW NOT ON primary command.

For a definition of not-selected records, see [Filtering record display using templates on page 309](#).

Suppressed

Show shadow lines for suppressed records. Equivalent to the SHADOW SUP ON primary command.

For a definition of suppressed records, see [Filtering record display using templates on page 309](#).

Excluded

(Edit only.) Show shadow lines for excluded records (records that you have excluded from display using the X prefix command or the EXCLUDE primary command). Equivalent to the SHADOW EX ON primary command.

Multi-line display format options: (TABL/CHAR/HEX/LHEX)

Display prefix area

(Edit only.) Display the prefix area. Equivalent to the PREFIX ON or PREFIX OFF primary commands.

Display prefix area on the right

Place the prefix area (if it is displayed; see **Display prefix area**, above) on the right of the Edit panel. Otherwise, place the prefix area on the left. Equivalent to the PREFIX RIGHT primary command.

Prefix area width (A,6,7,8,9)

Sets the length of the prefix area displayed in the editor session. The prefix length can be from 6 to 9, or you can set it to A to automatically adjust the prefix area length as required in order to display the record numbers (when applicable) for your data set. A is the default value. You can also control the display and positioning of the prefix area with the PREFIX primary command.

Display record length

Turns on the display of record lengths in multiple line formats (TABL,CHAR,HEX,LHEX). If the **Display record length on the right** option is not selected, displays the record length on the left side of the panel. Enter any character to enable the display, or remove or overtype with a blank to disable. You can also control the display of the record length with the RECLLEN primary command.

This option also controls whether the record length is printed when printing TABL and SNGL formatted records.

Display record length on the right

Displays the record length area in the File Manager Edit data display on the right side of the panel. If this option is not selected and **Display record length** is selected, the record length area is on the left side of the panel. This option is only effective when either the **Display record length** option is selected, or when you issue the RECLLEN ON command during an editor session. You can also control the display and positioning of the record length area with the RECLLEN primary command.

Record length width (A,3,4,5,6)

In multiple line formats (TABL,CHAR,HEX,LHEX), sets the width of the record length area displayed in the editor session. You can set the record length width from 3 to 6, or you can set it to A to automatically adjust the record length area width as required in order to display the record lengths for your data set. A is the default value. You can also control the display and positioning of the record length area with the RECLLEN primary command.

Display RBA and Length when browsing VSAM

When you browse a VSAM file, the leftmost side of the multiline displays contain the RBA and the length of the record being displayed.

If you deselect this option, File Manager does not display this information, allowing more of the record data to be displayed on each panel.

Formatted display options:

Field reference number (REF)

Changes the session default to show the field reference (for example, #2) next to each field, in SNGL display or print format. In an editor session, this display can also be turned on or off temporarily, by using the REFS command.

Field type and length values (TYPE)

Changes the session default to show the field data type and length next to each field, in SNGL display or print format. In an editor session, this display can also be turned on or off temporarily, by using the TYPE command.

Picture clause (PIC)

Changes the session default to show the Picture clause when in SNGL display or print mode. Also shows the length and scale (if non zero) for binary and packed fields and the bit length for bit fields. In an editor session, this display can also be turned on or off temporarily, by using the PIC command.

Start location (SLOC)

Changes the session default to show the start location of each field, when in SNGL display or print mode. In an editor session, this display can also be turned on or off temporarily, by using the SLOC command.

Structure (STR)

Changes the session default to show the full structure of the template when using SNGL display or print mode. In an editor session, this display can also be turned on or off temporarily, by using the STR command.

Left justify numeric fields (JUST)

Changes the session default to show numeric fields as left justified, when using SNGL display or print mode. In an editor session, this display can also be turned on or off temporarily, by using the JUST command.

Redefined fields (RDF)

Changes the session default to show the redefined information as part of the field name, when in SNGL display or print mode and display or print the redefined fields when in SNGL or TABL display or print mode. In an editor session, this display can also be turned on or off temporarily, by using the RDF command.

CCSID (CCSID)

Change the session default to display the CCSID assigned to each field, if applicable, when in SNGL display or print mode. In an editor session, this display can also be turned on or off temporarily, by using the CCSID command.

Parent panels

- [Set Processing Options panel on page 1029](#)

Child panels

- None.

Equivalent functions

- None.

Related tasks and examples

- [Printing from File Manager on page 402](#)
- [Viewing and changing packed data on page 95](#)
- [Setting the initial display format on page 105](#)

Erase Tape panel

Panel and field definitions

Figure 237. Erase Tape panel

<u>P</u> rocess	<u>O</u> ptions	<u>H</u> elp
File Manager		Erase Tape
Tapes: No tapes allocated		
Output:		
DDNAME to use . _____	enter new name, or select one from above	
Tape mode . . . __	optional recording mode or density code	
Command ==> -----		
F1=Help	F2=Split	F3=Exit
F9=Swap	F10=Actions	F12=Cancel
	F4=CRetriev	F7=Backward
		F8=Forward

Parent panels

- [Tape Specific Functions panel on page 1047](#)

Child panels**Related tasks and examples**

Exported Stacked Volume Copy panel

Panel and field definitions

Figure 238. Exported Stacked Volume Copy panel

<u>P</u> rocess	<u>O</u> ptions	<u>H</u> elp
File Manager		
Exported Stacked Volume Copy		
Tapes: No tapes allocated		
Input:		
DDNAME to use . _____		enter new name, or select one from above
Logical vol(s) _____		enter logical volume(s) to be copied
Output:		
DDNAME to use . _____		enter new name, or select one from above
Tape mode . . . ____		optional recording mode or density code
Command ==>		
F1=Help	F2=Split	F3=Exit
F9=Swap	F10=Actions	F12=Cancel
		F4=CRetrieval F7=Backward F8=Forward

Parent panels

[Tape Specific Functions panel on page 1047](#)

Child panels**Related tasks and examples**

Exported Stacked Volume List panel

Panel and field definitions

Figure 239. Exported Stacked Volume List panel

Process	Options	Help
File Manager	Exported Stacked Volume List	
Tapes: No tapes allocated		
Input:		
DDNAME to use . _____	enter new name, or select one from above	
Type of listing <u>SHORT</u>	enter LONG to list logical volume details	
Logical vols(s) _____	For LONG, enter logical volume(s) to be listed	
	or	
Logical start . 0_____	enter logical start volume	
Logical end . . 0_____	enter logical end volume	
Command ==> -----		
F1=Help	F2=Split	F3=Exit
F9=Swap	F10=Actions	F12=Cancel
	F4=CRetriev	F7=Backward
		F8=Forward

Parent panels

[Tape Specific Functions panel on page 1047](#)

Child panels

Related tasks and examples

Field Attributes panel - alphanumeric fields

This panel lists a field's formatting and data create attributes. You can modify the width of a field for TABL formatting, leading zero suppression for numeric fields. You can also specify data create attributes. The panel comes in two versions, one for alphanumeric fields and one for numeric fields. This section describes the alphanumeric field version.

Panel and field definitions

Figure 240. Field Attributes panel - alphanumeric fields

Process	Options	Help
File Manager		Field Attributes
Fixed Attributes:		
Field name	CONTRACTOR	
Type	AN	
Start	7	
Length	40	
Use Attributes:		
Heading	_____	
Output width	_____	
CCSID	_____	
Create Attributes:		
Filler	_____	
Action	__	
Start character	_	
Pattern	_____	
Repeat user pattern	_____	YES or NO
Scrambling Options:		
Scramble Type	Enter "/" to select option	
1. Random	Value	Column In _____ Out _____
2. Repeatable Dsn	_____	
3. Translate	_____	
4. Exit	Col	Command
5. ODPD	1	pro=eml, mtd=repeatable, wheninv=pre, flddef1=(name=em +
Command ==>	_____	
F1=Help	F2=Split	F3=Exit F4=CRetriev F7=Backward F8=Forward
F9=Swap	F10=Actions	F12=Cancel

When the selected field is alphanumeric, the **Field Attributes** panel has these fields:

Fixed attributes

Shows the fixed attributes of the field, such as field name, type, and length, and the starting position, relative to zero, of the field within the record.

These attributes are determined by copybook definitions or by the user-defined attributes in a dynamic template.

Use attributes

Used to specify certain display (or print) attributes used by edit, view, and print functions. For alphanumeric fields, here are the available use attributes:

Heading

The alternative heading that replaces the field name on displays and reports.

Output width

Number of character positions that used by edit, view, compare, and print functions to show this field in TABL display or print format. For alphanumeric fields, this value can range from 6 to either 30 or the field width + 10 (whichever is the greater).

The default output width is the maximum of the number of characters that are needed to show the field heading (or field name, if no heading is specified), and the number of characters that are needed to show the value of the field.

CCSID

Specifies the CCSID to be associated with this field.

Length Field

Shows only for a segmented template and alphanumeric fields whose length does not exceed 4.

Each layout can have one field that is flagged as a length field. File Manager calculates the segment length based on the value that is in the field.

You can enter one of the following values:

blank

This field is not a length field.

1

The field value is the segment length.

2

The field value, plus the length of the field, is the segment length.

If a length field is not provided, the segment length is taken to be the 01 field length.

Create attributes

These attributes define the field-specific attributes that are used by the data create functions when they create test data for records that contain this field.

Filler

Specifies a value that is to be placed in each byte of the field before any other operation in the construction of the field. Can be one of:

char

A character such as `0` to be written in each byte.

X'cc'

A hexadecimal value, such as `X'FF'` to be written in each byte.

Default value is blank.

Action

Specifies how the contents of the field are to be varied for each record. Can be one of:

FX

The contents of the field are to remain fixed.

RA

The contents of the field are to be generated from characters that are selected at random from the specified pattern. A different set of characters is selected for each record.

RO

The contents of the field are to be rolled. The pattern that you specify is shifted left 1 byte for each record until the first non-blank character of the pattern is in the first byte of the field. Then, the pattern is shifted right 1 byte for each output record until it returns to its original position in the field. RO can be used only with a user-supplied pattern, not with an IBM®-supplied pattern.

The pattern must start with a blank, or the result is the same as FX. The roll occurs only within the length of the pattern.

RP

The contents of the field are to be rippled. The pattern that you specify is shifted left 1 byte for each record and the truncated character is appended to the right-hand end of the pattern.

SL

The contents of the field are to be shifted left for each record. The pattern that you specify is shifted left one character and filled to the right with a space. When all characters in the pattern are shifted out, the original pattern is restored and the process is repeated.

SR

The contents of the field are to be shifted right for each record. The pattern that you specify is shifted right one character and filled to the left with a space. When all characters in the pattern are shifted out, the original pattern is restored and the process is repeated.

TL

The contents of the field are to be truncated on the left for each record. The pattern that you specify is left truncated (the leftmost character is replaced with a space) one character at a time until all characters in the pattern are truncated. Then, the original pattern is restored and the process is repeated.

TR

The contents of the field are to be truncated on the right for each record. The pattern that you specify is right truncated (the rightmost character is replaced with a space) one character at a time until all characters in the pattern are truncated. Then, the original pattern is restored and the process is repeated.

WV

The contents of the field are to be waved. The pattern that you specify is shifted left 1 byte for each record until the first non-blank character of the pattern is in the first byte of the field. Then, the original pattern is restored and the process repeated. WV can be used only with a user-supplied pattern, not with an IBM®-supplied pattern.

The pattern must start with a blank, or the result is the same as FX. The roll occurs only within the length of the pattern.

Start character

Sets the starting character to be used when you specify an IBM®-supplied pattern (AL, AN, or CO) or a user-supplied pattern (except for RO, WV, and FX). The specified character must be one of the characters in the IBM®-supplied pattern or user-supplied pattern.

Default: First character in IBM®-supplied pattern or user-supplied pattern.

Pattern

Specifies the pattern to be used when data is generated for this field. You can specify either an IBM®-supplied pattern indicator or a user-supplied pattern. The user-supplied pattern can be either a character string or a hexadecimal string. A character string must be enclosed in quotation marks, while a hexadecimal string must be enclosed in quotation marks and be preceded by an X. The hexadecimal string must contain an even number of valid hexadecimal characters. Here are the IBM®-supplied patterns that you can specify:

AL

Alphabetic - characters A-Z, inclusive.

AN

Alphanumeric - characters A-Z, 0-9 inclusive.

AX

Alphanumeric displayed in long hexadecimal.

CO

Collating sequence - all printable characters in the range X'40' - X'F9'.

If you provide a user-supplied pattern that is longer than the field, for actions other than RA and RP the pattern is first truncated on the right to fit the receiving field before the specified action is performed. For the RA action, characters are randomly selected from the entire user-supplied pattern. For the RP action, the entire pattern is rippled for each record before it is truncated to fit the receiving field. If you provide a user-supplied pattern that is shorter than the field, you can specify that you want the pattern to be repeated to fill the field.

Default: None

Repeat user pattern

Specify YES if the user-supplied pattern is shorter than this field and you want the pattern to be repeated as many times as necessary to fill the field. By default, File Manager uses the fill character to pad the receiving field when the user-supplied pattern is shorter than the field. This option has no effect when the RA action is specified.



Note: IBM®-supplied patterns are always repeated in a field, as necessary.

Default: NO

Scrambling Options

These options control the scrambling of the field that is used during a copy function to produce test data.

Scramble Type

Specify one of the following values:

Blank

No scrambling is performed. Value or range specifications are saved but ignored for the associated function.

1 (Random)

Performs random scrambling. The same input value produces different output values on subsequent invocations.

2 (Repeatable)

Performs repeatable scrambling. The same input value produces the same output value on subsequent invocations.

3 (Translate)

Performs translation. The value data set is searched to find a matching input value. If a match is found, then the output value is taken from the output column of the matching record.

4 (Exit)

Starts a scrambling user exit. File Manager displays a panel where you can specify the user exit name and user exit parameters and options.

5 (ODPP)

Performs data scrambling by using the ODPP command that is specified in the adjacent command field. This is the Optim™ Data Privacy Provider command input area. The **Col** field is the left column position, which can be used to position to the error column when a syntax error occurs. Refer to the ODPP Syntax Guide for the command syntax. The ODPP **Command** is a scrollable field. Use the F10 and F11 keys to scroll left and right. Use the F4 key to expand the command into a separate

window. This option is only available if File Manager was customized to access ODP, and the environment is successfully initialized. For more information, see the *File Manager for z/OS Customization Guide*.

Value

Select this option to provide values for the output field. The associated fields (**Column In**, **Out**, and **Dsn**), with the **Scramble Type**, determine the output value.

Column In

Defines the start location of the input field value on the value data set, and is used when the translate process is run during a copy operation to match the input field with a value on the value data set. The length of the field is set to the length of the input field that is mapped to this field during the copy process.



Note: This value is only required when you select the scramble type, **Translate**.

(Column) Out

Defines the start location of the output field value on the value data set, and is used as follows during a copy operation:

- For scramble type, **Translate**: If an input field value is matched on the value data set, then the corresponding output value is used.
- For scramble types, **Random** or **Repeatable**: The input value is used to randomly or repeatedly select an output value from the value data set.

The length of the field is the current field length as displayed on this panel.



Note: This value is required when you select the scramble type, **Translate**. If you select **Random** or **Repeatable**, and also select **Value**, then the start location defaults to 1 if a value data set name (**Dsn**) is provided.

Dsn

Defines the value data set. It can be any cataloged sequential, partitioned, or VSAM data set containing data that is used to determine the output field value during a copy process.

When you specify the data set name, the following rules apply:

- In a generic data set name, use the percent sign (%) to represent a single character, and an asterisk (*) to represent any number of characters within one qualifier. Two asterisks (**) represent any number of characters within any number of qualifiers.
- The TSO prefix (as defined for your user ID) is used as the high-level qualifier for any name that is not enclosed in quotation marks.

- For performance reasons, qualify the data set name as much as you can.
- If the data set is partitioned, then you can provide a member name in the form *dsn(member)*. If you do not provide a member name, or you provide a generic member name, then a member selection list is displayed for you to select a member.

Parent panels

Child panels

Related tasks and examples

[Setting the Data Create Attributes in your template on page 333](#)

Field Attributes panel - numeric field

This panel lists a field's formatting and data create attributes. You can modify the width of a field for TABL formatting, leading zero suppression for numeric fields. You can also specify data create attributes. The panel comes in two flavors, one for alphanumeric fields and one for numeric fields; this section describes the numeric field version.

Panel and field definitions

Figure 241. Field Attributes panel - Numeric Field

Process	Options	Help
File Manager		Field Attributes
Fixed Attributes:		
Field name	SERIAL-NO	
Type	ZD	
Start	47	
Length	6	
Use Attributes:		
Heading	_____	
Output width	_____	
Leading zeros	NO	YES or NO
Create Attributes:		
Start value	_____	
End value	_____	
Increment	_____	
Cycle	_____	
Scrambling Options:		
Scramble Type	Values	
1. Random	1. Range	Min _____ Max _____
2. Repeatable	2. Value	Column In _____ Out _____
3. Translate	Dsn	_____
4. Exit	Col	Command _____
5. ODPP	1	pro=eml, mtd=repeatable, wheninv=pre, flddef1=(name=em +
Command ==> -----		
F1=Help	F2=Split	F3=Exit
F9=Swap	F10=Actions	F12=Cancel
		F4=CRetrieval F7=Backward F8=Forward

When the selected field is numeric, some fields differ to those displayed when the selected field is alphanumeric. Where the fields are different, the following definitions apply:

Use attributes

Used to specify certain display (or print) attributes used by edit, view, and print functions. For numeric fields, the available use attributes are:

Heading

The alternate heading that replaces the field name on displays and reports.

Output width

Number of character positions used by edit, view, and print functions to show this field in TABL display or print format. For numeric fields, from 6 to 30 (including a sign character and decimal point).

The default output width is the maximum of the number of characters needed to show the field heading (or field name, if no heading is specified), and the number of characters needed to show the value of the field.

Leading zeros

Specifies whether leading zeros are to be shown when this field is displayed or printed in SNGL or TABL display or print format. Specify YES if you want leading zeros shown. Specify NO if you want leading zeros replaced with blanks.

Default: NO

Length Field

Only shows for a segmented template and alphanumeric fields whose length does not exceed 4.

Each layout can have one field flagged as a length field. This tells File Manager to calculate the segment length based upon the value contained in the field.

You can enter one of the following values:

blank

This is not a length field.

1

The field value is the segment length.

2

The field value, plus the length of the field, is the segment length.

If a length field is not provided, the segment length is taken to be the 01 field length.

Create attributes

These define the field-specific attributes used by the data create functions when creating test data for records containing this field.



Note: The mantissa consists of an optional sign (+ or -) followed by 1 to 16 digits. The mantissa can also contain a decimal point. The exponent consists of the letter E, an optional sign (+ or 0), and 1 or 2 digits.

Start value

Specifies the initial value you want a field to contain, before being adjusted by the increment you specify.

The value must be a number that, when converted to the appropriate numeric data type, the field can hold, and, for a field with decimal places, must not specify more decimal integers than the number of decimal places in the field definition. If you specify a negative number, the sign is honored, even if the field is unsigned.

If the field is a floating-point field, the start value can be specified as a floating-point number consisting of a mantissa and an exponent (such as -1.14579E01).

Default: 0

End value

Specifies the maximum value (if the increment is a positive number) or minimum value (if the increment is a negative number) you want a field to contain.

The value must be a number that, when converted to the appropriate numeric data type, the field can hold, and, for a field with decimal places, must not specify more decimal integers than the number of decimal places in the field definition. If you specify a negative number, the sign is honored, even if the field is unsigned.

If the field is a floating-point field, the end value can be specified as a floating-point number consisting of a mantissa and an exponent (such as -01.14579E01).

Default: The largest positive or negative number the field can contain.

Increment

Specifies a positive or negative number by which you want the value in the field adjusted for each record (or cycle of records).

The increment must itself be a number that, when converted to the appropriate numeric data type, the field can hold, and, for a field with decimal places, must not specify more decimal integers than the number of decimal places in the field definition.

If the field is a floating-point field, the increment can be specified as a floating-point number consisting of a mantissa and an exponent (such as -1.14579E01).

For the first record (or cycle of records), the field is set to the start value you specify. For each subsequent record (or cycle of records), the increment is added to the value in the field. This

process continues as long as the calculated value in the field does not exceed the specified end value.

Default: 0

Cycle

Specifies the number of output records that are to be generated before the increment value is applied to the field value. For example, if you specify a field start value of 100, an increment value of 10, and a cycle value of 3, the field in the first 3 records contains 100, 110 in the next 3 records, 120 in the next 3 records, and so on.

If the cycle is 0, the value in the field is always set to the start value.

Scrambling Options

These options control field scrambling used during copy, import, or export functions to produce test data.

Scramble Type

Specify one of the following values:

Blank

No scrambling is performed. Value or range specifications are saved but ignored for the associated function.

1 (Random)

Performs random scrambling. The same input value produces different output values on subsequent invocations.

2 (Repeatable)

Performs repeatable scrambling. The same input value produces the same output value on subsequent invocations.

3 (Translate)

Performs translation. The value data set is searched to find a matching input value. If a match is found, then the output value is taken from the output column of the matching record.

4 (Exit)

Starts a scrambling user exit. File Manager displays a panel where you can specify the user exit name and user exit parameters and options.

5 (ODPP)

Performs data scrambling by using the ODPP command that is specified in the adjacent command field. This is the Optim™ Data Privacy Provider command input area. The **Col** field is the left column position, which can be used to position to the error column when a syntax error occurs. Refer to the ODPP Syntax Guide for the command syntax. The ODPP **Command** is a scrollable field. Use the F10 and F11

keys to scroll left and right. Use the F4 key to expand the command into a separate window. This option is only available if File Manager was customized to access ODP, and the environment is successfully initialized. For more information, see the *File Manager for z/OS Customization Guide*.



Note: For numeric fields, setting **Leading zeros** to YES causes leading zeros to be scrambled when random or repeatable scrambling (**Value** option blank) has been requested.

For example:

- With **Leading zeros** set to YES, 00123 may produce 56872 (zeros changed).
- With **Leading zeros** set to NO, 00123 may produce 00343 (zeros unchanged).

For repeatable scrambling, setting **Leading zeros** to YES guarantees a unique result.

Values

For numeric fields, you can provide these options to control the output for the selected scramble type:

Blank

File Manager determines the output value by performing either random or repeatable scrambling on the input value as determined by the scramble type.

1 (Range)

A range of values. You must provide a minimum and a maximum value that is valid for the field. During the copy operation, the scramble value generated is a number in the range provided. The minimum value must be less than the maximum value. The values provided must be between -2GB and +2GB.

2 (Value)

You provide values for the output field. The associated fields (**Column In**, **Out**, and **Dsn**), in conjunction with the scramble type, determine the output value.

Min

Minimum value. Must be less than the maximum value and greater than or equal to -2GB. When option 1 (Range) is selected, you must specify a value in this field.

Max

Maximum value. Must be greater than the minimum value and less than or equal to 2GB. When option 1 (Range) is selected, you must specify a value in this field.

Column In

Defines the start location of the input field value on the value data set, and is used when the translate process is run during a copy operation to match the input field with a value on the value data set. The length of the field is set to the length of the input field that is mapped to this field during the copy process.



Note: This value is only required when you select the scramble type, **Translate**.

(Column) Out

Defines the start location of the output field value on the value data set, and is used as follows during a copy operation:

- For scramble type, **Translate**: If an input field value is matched on the value data set, then the corresponding output value is used.
- For scramble types, **Random** or **Repeatable**: The input value is used to randomly or repeatably select an output value from the value data set.

The length of the field is the current field length as displayed on this panel.



Note: This value is required when you select the scramble type, **Translate**. If you select **Random** or **Repeatable**, and also select **Value**, then the start location defaults to 1 if a value data set name (**Dsn**) has been provided.

Dsn

Defines the value data set. It can be any cataloged sequential, partitioned or VSAM data set containing data that is used to determine the output field value during a copy process.

If the **Translate** scramble type is selected, then the data set must contain the input and output values in the locations provided in the input and output columns.

If the **Random** or **Repeatable** scramble type is selected, then the data set must contain the output value in the locations provided in the output column.



Note: This field is required when you select the **Translate** scramble type. If you select **Random** or **Repeatable**, and also select **Value**, then you can optionally provide a data set name. If you leave this field blank having selected **Value**, you are prompted to enter the value list to be stored in the template.

When specifying the data set name, the following rules apply:

- In a generic data set name, use the percent sign (%) to represent a single character, and an asterisk (*) to represent any number of characters within one qualifier. Two asterisks (**) represent any number of characters within any number of qualifiers.
- The TSO prefix (as defined for your user ID) is used as the high-level qualifier for any name that is not enclosed in quotation marks.
- For performance reasons, you should qualify the data set name as much as you can.
- If the data set is partitioned, then you can provide a member name in the form *dsn(member)*. If you do not provide a member name, or you provide a generic member name, then a member selection list is displayed for you to select a member.

Parent panels

Child panels

Related tasks and examples

[Setting the Data Create Attributes in your template on page 333](#)

Field Mapping panel

The Field Mapping panel describes the current relationship between receiving fields in the “To” (or “New”) template or copybook to sending fields in the “From” (or “OLD”) template or copybook. File Manager generates corresponding mappings based upon field names if you have issued the GM (Generate corresponding map) command prior to editing the mapping relationship; or the GE command (Generate and edit mapping).

This panel is displayed when “edit template” has been requested from the “To” panel of the Copy Utility, the Options panel of the Compare Utility or the Map To panel of the Template Workbench, and the “To” or “New” template or copybook contains only one record type, or when the E or S command is issued on the Record Type Mapping panel.



Note: If called from the Compare Utility, the panel displays all labels with “New” instead of “To” and “Old” instead of “From”.

Panel and field definitions

Figure 242. The Field Mapping panel

Process		Options		Help			
File Manager		Field Mapping		Line 1 of 7			
To	USERID.TEMPLATE (FMNCCPY2)						
From	USERID.TEMPLATE (COPYTST1)						
Cmd	Lv	To Field Name	Type	Len	Lv From Field Name	Type	Len
		**** Top of data ****					
---	1	NEW-TYPE01	AN	84	1 REC-TYPE01	AN	80
---	2	REC-TYPE	AN	2	2 REC-TYPE	AN	2
---	2	NAME	AN	20	2 NAME	AN	20
---	2	SERIAL-NO	BI	4			
---	2	AGE	BI	2	2 AGE	BI	2
---	2	SALARY	PD	4	2 SALARY	PD	4
---	2	MONTH	BI	4	2 MONTH	BI	4
		**** End of data ****					
Command ==>						Scroll PAGE	
F1=Help	F2=Split	F3=Exit	F4=CRetriev	F5=RFind	F6=Describe		
F7=Up	F8=Down	F9=Swap	F12=Cancel				

TO (or NEW) *template/copybook*

The name of the copybook or template that contains the record descriptions for the “To” or “New” data set.

FROM (or OLD) *template/copybook*

The name of the copybook or template that contains the record descriptions for the “From” or “Old” data set.

(To or New) Lev, Field Name, Type and Len

Shows the level number, field name, type and length of the fields in the “To” or “New” template.

(From or Old) Lev, Field Name, Type and Len

Shows the level number, field name, type and length of the fields in the “From” or “Old” template that have been mapped to the “To” or “New” field.

Cmd

Prefix command area - used to enter a template editor prefix command. Enter **S** to change the field mapping or **E** to edit the new field attributes.

Parent panels

Child panels

Related tasks and examples

Field Selection/Edit panel

The Field Selection/Edit panel is primarily used to edit copybook templates. You can also edit some properties of dynamic templates within this panel, such as the record selection criteria, field sequencing and field selection. (You cannot modify the Field Name, Start, Length or Type fields; those fields can only be modified in the Dynamic Template panel.)

When you edit a template for segmented data, File Manager displays the Field Selection/Edit panel with an additional line identified by "**O Rid**" showing the related ID expression (if any).

You can use the Field Selection/Edit panel ([Figure 243: Field Selection/Edit panel on page 892](#)) to:

- Select which fields are displayed (when viewing or editing) or printed.
- Change the sequence in which fields are displayed or printed.
- Provide field headings that File Manager uses in place of the copybook or dynamic template field names, when displaying or printing.
- Begin editing field attributes
- Specify record identification criteria for the record type
- Specify record selection criteria for the record type
- Select fields to be included in a multi-segment key, and specify the order in which they are to be used in a keyed synchronization comparison.
- Display a subsequent panel from which you can choose which level-01 items to edit related ID criteria for an owning level-01.

Panel and field definitions

Figure 243. Field Selection/Edit panel

```

Process  Options  Help
-----
File Manager                Field Selection/Edit                Line 1 of 10

----- Criteria - Enter 1 or 2 to specify expression by field -----
1 Id : #2='02'
2 Sel:
Offset 0
Cmd Seq SHE Key Ref Field Name          Picture  Type  Start Length
-----
          1 1 REC-TYPE01                    AN       1     80
          2 2 REC-TYPE                    XX       AN     1     2
          3 2 NAME                        X(20)    AN     3     20
          4 2 EMPLOYEE-NO                  9(4)     BI     23     2
          5 2 AGE                          9(4)     BI     25     2
          6 2 SALARY                       9(7)     PD     27     4
          7 2 MONTH OCCURS 12 TIMES        9(8)     BI     31     4
          8 2 FILLER                        XX       AN     79     2
          **** End of data ****

Command ==>
F1=Help      F2=Split    F3=Exit     F4=Expand   F5=RFind    F6=RunTemp
F7=Up        F8=Down     F9=Swap     F10=Left    F11=Right   F12=Cancel
    
```

Figure 244. Field Selection/Edit panel - alternative format for a template for segmented data

```

Process  Options  Help
-----
File Manager                Field Selection/Edit                Line 1 of 6

---Criteria - Enter 0 - Related ID expression, 1 or 2 - expression by field---
0 Rid: SEG(HEADER-01):#5: TYPEREC  ='01'
1 Id :
2 Sel:
Offset 0
Cmd Seq SHE Ref Field Name          Picture  Type  Start Length
-----
          1 1 DETAIL-0101                    AN       1     30
          2 2 SUBTYPE-FIELD                  AN       1     9
          3 3 SUBTYPECONST                  X(7)     AN     1     7
          4 3 TYPEREC                        X(2)     AN     8     2
          5 2 DETAILTEXT01                  AN       10    21
          6 3 DETAIL01-01                  X(21)    AN     10    21
          **** End of data ****

Command ==>
F1=Help      F2=Split    F3=Exit     F4=Expand   F5=RFind    F6=RunTemp
F7=Up        F8=Down     F9=Swap     F10=Left    F11=Right   F12=Cancel
    
```

0 Rid

Used to specify the related ID expression. This line only appears on the Field Selection/Edit panel when you are editing a template for segmented data (which you indicate by selecting the **Template for segmented data** processing option on the previous panel (Record Type Selection).

1 Id

Used to specify the Record identification criteria that File Manager should use to identify this record type. In the absence of record identification criteria, File Manager uses the record length to identify record type.

For fixed-length records (as defined by the record definition in the template, not the data set attributes), the length of the record read must exactly match the length of the corresponding record definition in the template. For variable-length records, the length of the record read must be equal to or greater than the minimum length and equal to or less than maximum length of the corresponding record definition in the template.

If File Manager cannot match the length of a record to one of the record definitions in the template, the record is not selected for processing. If the length of a record matches more than one record definition in the template, and no explicit record identification criteria is specified, File Manager uses the first matching record type in the template. Therefore, if the record length of each different record type in the file is not unique, you should use this field to specify some unique identification criteria.

Enter 1 to display the Record Identification Criteria panel and specify the criteria by field or type a free form REXX expression in the adjacent field. You can scroll to the right or left within the field, using the Right (F11) or Left (F10) function keys, or you can expand the field, using the Expand function key (F4).

Specifying criteria by field or by free form REXX expression is mutually exclusive. If you select option 1 and enter criteria by field, any free form REXX expression entered in the adjacent field is replaced by the new criteria. You cannot manually edit this expression. To restore the ability to create a freeform REXX expression for record identification, you would need to clear any criteria entered in the Record Identification Criteria panel.

2 Sel

Used to specify the Record selection criteria that File Manager should use to select records for processing. You can use this field to limit the records of a given record type that you want to process. If you do not provide any record selection criteria, all records of this record type are selected for processing (if the record type itself has been selected for processing).

Enter 2 to display the Record Selection Criteria panel and specify the criteria by field or type a free form REXX expression in the adjacent field. You can scroll to the right or left within the field, using the Right (F11) or Left (F10) function keys, or you can expand the field, using the Expand function key (F4).

Specifying criteria by field or by free form expression is mutually exclusive. If you select option 2 and enter criteria by field, any free form REXX expression entered in the adjacent field is replaced by the new criteria. You cannot manually edit this expression. To restore the ability to create a freeform REXX expression for record selection, you would need to clear any criteria entered in the Record Selection Criteria panel.

Offset

Offset field - used to enter an offset value. An offset value is a negative or positive integer, between -32760 and +32760, that is added to the record length of the Level 01 field and to the starting position of all fields within the record type, shifting the layout left or right in relation to the records being processed. An offset value of 0 removes a previously supplied offset.

Enter "/" to OR with related ID

By default, identification criteria are ANDed with related ID criteria if both are specified. Select this option to OR the identification criteria with any specified related ID criteria.

CCSID

The CCSID to be associated with all alphanumeric fields in the record unless the field has a CCSID associated with it. If this field is changed those alphanumeric fields in the record which have the same CCSID will have the CCSID associated with it changed.

Cmd

Prefix command area - used to enter a template editor prefix command.

Seq

Sequence field - used to order fields for display in File Manager editor sessions and printing data via the File Manager Print utility. The default display/print order is "selected fields in field reference order".

SHE

Select/Hold/Edit field - shows the field status:

S

The field has been selected for processing.

H

The field has been selected to be held on the edit display.

E

The field has been previously edited to add information such as data create, field headings, and scrambling options.

Ref

Field reference - shows the field reference number assigned by File Manager to the field name. Field reference numbers are assigned to all fields in a record, and are used to identify fields in identification or selection criteria expressions.

Key

Key segment sequence. Shows the key segment sequence numbers used to define a multi-segment key field for data set comparison. The display of the Key column can be toggled on or off using the KEYFLDS command.

Field Name

Shows the level number and field name of the field, together with other attributes such as redefines, array sizes and depending on references. If the field is an array, the dimensions are shown in brackets after the field name. If the field has been selected for processing, the field name is highlighted.

Picture

Shows the picture clause for COBOL and for PL/I. Shows the length and scale (if non zero) for binary and packed fields. Also shows the bit length for bit fields.

Type

An editable field in which you can enter or edit the data type of a field. This must be one of:

AN

Alphanumeric

AX

Alphanumeric displayed in long hexadecimal.

BI

Binary

BT

Bit string

DB

DBCS string

DT

Data/Type

FE

Floating point (external)

FP

Floating point (internal)

G

Graphic string

PD

Packed decimal

VB

Varying bit

VC

Varying character

VD

Varying DBCS

VG

Varying graphic

Z2

Null-terminated varying-length(VARYINGZ) DBCS string

ZA

Unsupported zoned decimal edited

ZC

Varying character null terminated

ZD

Zoned decimal

ZE

Zoned decimal edited

ZG

Varying graphic null terminated

Start

Shows the start column of the field. For variable located fields the start location is based on the maximum length of the record.

Length

Shows the length of the field. For a level-01 field, if the record is variable length, the length shown is the maximum record length.

Example

Available commands

The prefix commands that can be entered in the Cmd field are:

E

Displays the Field Attributes panel for this field. You can use the Field Attributes panel to specify the following:

- For a numeric field, whether you want leading zero suppression when the field is displayed on the screen or printed using the SNGL or TABL display or print formats.
- When you use the template to help generate test data, what data pattern File Manager should use for the field.

H

Set Hold status for a single field, if the field is already in Hold status the Hold status is removed.

In TABL display format, held fields always appear as the leftmost fields on the screen (in the order that you held them when editing the template). Held fields take priority, as far as the left-to-right display is concerned, over other fields.

In SNGL display format, held fields always appear as the topmost fields on the screen (in the order that you held them when editing the template). Held fields take priority, as far as the top-to-bottom display is concerned, over other fields.

Hn

Set Hold status for n fields, if any of the fields are already in Hold status, the Hold status is removed.

HH

Select a block of fields to have the Hold status set. If any of the fields are already in Hold status, the Hold status is removed. Use the HH prefix command to mark the start and end of the block of fields.

S

Select a single field for processing or, if the field is already selected for processing, deselect it. If you select multiple fields for processing using the S prefix command, the fields are displayed in the order they appear in the template.

Sn

Select n fields for processing or, if any of the fields are already selected for processing, deselect them.

S*

Select all fields from the current field to the end of the list for processing or, if any of the fields are already selected for processing, deselect them. If you want to exclude just a few fields, you can use S* to explicitly select all the fields in a fresh template, then use S to deselect the fields you want to exclude.

SS

Select a block of fields for processing or, if any of the fields are already selected for processing, deselect them. Use the SS prefix command to mark the start and end of the block of fields.

X

Toggle between a display type of AN (character) and AX (long hexadecimal). This command has no effect on non-alphanumeric fields.

Xn

Perform the X command against all fields from the current field for n fields.

X*

Perform the X command against all fields from the current field to the end of the list.

XX

Perform the X command against a block of fields. Use the XX prefix command to mark the start and end of the block of fields.

The primary commands that are available on this panel are:

- [DESCRIBE primary command on page 1145](#)
- [FIND/FX primary command on page 1157](#)
- [RESET primary command on page 1208](#)
- [RUNTEMP primary command on page 1215](#)
- [SAVE primary command on page 1215](#)
- [SAVEAS primary command \(templates\) on page 1216](#)

- [SELECT primary command on page 1218](#)
- [LPRINT primary command on page 1232](#)
- [LZERO primary command on page 1190](#)

Parent panels

Child panels

Related tasks and examples

Field Selection List panel

The Field Selection List panel provides a list of fields in the current template. This panel is entered if no field is identified when the FMAP command is entered.

Panel and field definitions

Figure 245. Field Selection List panel

```

- Command ==> _____ Field Selection List _____ Scroll CSR
E
C   Field Name           Start      Length
C   *
R   1 FMAPV001           1          292
   2 KEYDATA             1           8
   2 len                 9           2
   2 VARYING01           11          50
   2 DATA01             61          40
   2 DATA02            101          30
   2 DATA03            131          20
   2 DATA04            151          90
   3 DATA41            151          40
   3 DATA42            191          30
   3 DATA43            221          20
   2 len                 241          2
   2 VARYING02           243          50
   **** End of data ****

F1=Help      F2=Split    F3=Exit     F4=CRetriev
F5=RFind     F7=Backward F8=Forward  F9=Swap

-----
ec 1 of 6
Scroll CSR
Format SNGL
of 30
length 292

**CCCCC**

bbqqqqqbbbb

cc
F6=RChange
12=Cancel
    
```

Field Name

The fields in the current template.

Start

The start column of the field.

Length

The length of the field.

Parent panels

- `<xref href="editpan.dita#editpan"/>`
- `<xref href="viewpan.dita#viewpan"/>`

File Selection panel

The File Selection panel provides a list of HFS directory entries, from which you can select the files to be included in your current process. This panel is displayed when you have specified a HFS directory on an Entry panel.



Note: The title of the File Selection panel shown in [Figure 246: File Selection panel on page 899](#) includes the word, “View”, indicating that it was invoked from the View Entry panel. The title varies according to which Entry panel invokes the File Selection panel.

Panel and field definitions

Figure 246. File Selection panel

Process		Options		Help		
File Manager		View File Selection				
PATH /u/acook						
Name	Prompt	Typ	Size	Created	Changed	ID
*	*	*	*	*	*	*
.		Dir	8192	2009/05/01	2009/05/01	10:21:05 ZUSER
..		Dir	8192	2009/05/01	2009/05/01	10:15:46 ZUSER
.profile		File	55	2009/05/01	2004/10/13	09:40:45 ZUSER
.sh_history		File	941	2009/05/01	2007/05/02	11:29:02 ZUSER
acook.settings		File	677	2009/05/01	2004/10/13	09:52:09 ZUSER
sdsds		File	0	2009/05/01	2006/08/23	10:32:48 ZUSER
**** End of data ****						
Command ==>						Scroll PAGE
F1=Help	F2=Split	F3=Exit	F4=CRetriev	F5=RFind	F7=Backward	
F8=Forward	F9=Swap	F10=Left	F11=Right	F12=Cancel		

(Selection field)

Selection field. Entering an “S” results in one of the following:

- A single file is selected and returned to the calling routine. (Subsequent selections are ignored.)
- Toggling of the selected value in the Prompt field (Size column is used).
- Selects a file to be processed by the function that invoked the list.
- Displays the list of entries on the next level (when directory selected).

Name

An HFS object name. If the full name is not displayed, position the cursor at the name and press Enter to display a pop-up window showing the full name.

If the Copy From panel invoked the File Selection panel, the pop-up window also allows you to change the target name.

Prompt

A dynamic area that displays the last action that occurred for the listed file. It can have the following values:

Browsed

File was browsed

Edited

File was edited

Printed

File was printed

Nocopy

File was not copied

Copied

File was copied

Repl

File (member) was replaced

Norepl

File (member) was not replaced

Error

Error occurred when processing file

Invname

Copy to a PDS library: file name cannot be transformed to a member name

Invtype

HFS object not serviced by File Manager

Notauth

You are not authorized to access the file

Invrecl

Record size is greater than the allowable maximum (text mode)

Typ

The HFS object type:

Dir

Directory

Char

Character special file

File

Standard HFS file

FIFO

Pipe or FIFO special file

Syml

Symbolic link

Sckt

Socket file

Size

The object size in bytes. For large files, kilobytes (K), megabytes (M), or gigabytes (G) are used.

Created

The date the HFS object was created in YYYY/MM/DD format.

Changed

The date and time the HFS object was last changed in YYYY/MM/DD-HH:mm:SS format.

ID

Owner ID.

Parent panels

- [Browse Entry panel on page 751](#)
- [Edit Entry panel on page 862](#)
- [Copy From panel on page 789](#)
- [Copy To panel on page 796](#)
- [Print Utility panel on page 977](#)
- [Compare Utility: "Old" and "New" panels on page 764](#)

Child panels

The display panel that would normally result from the initiating Entry panel.

Related tasks and examples

- [Using UNIX System Services and the Hierarchical File System on page 497](#)
- [Manipulating your view of selection lists on page 62](#)

Find/Change Utility panel

The Find/Change Utility allows you to search for or change a string in a PDS, a VSAM data set, or a sequential data set by entering a FIND or CHANGE command on the Command line. You can also search for strings in HFS files.

Panel and field definitions

Figure 247. Find/Change Utility panel

```

Process  Options  Help
-----
File Manager          Find/Change Utility
Command ==>>> _____ Scroll CSR
Input Partitioned, Sequential or VSAM Data Set, or HFS file:
Data set/path name 'FMNUSER.DATA' _____ +
Member . . . . . * _____ (Blank - selection, pattern - process list)
Volume serial . . . _____ (If not cataloged)
Record count . . ALL _____ (Number of records to be searched)
- Additional options
Listing data set . SRCHFOR.LIST _____

Enter "/" to select option
- JCL Source format _____ Immediate change   Listing Option   ISPF Packing
- Use REXX proc _____ Batch execution   1 1. Long       1 1. Asis
- REXX no update _____ Directory integrity Stats Option   2. Summary     2. Pack
- Advanced member selection _____ Memory          3. Unpack
- Binary mode, reclen _____ CAPS initially on 2. Force       2 1. Off       4. None
5. Skip

Process List:
Sel Name  Prompt  Alias-of Size Created  Changed  ID
- M100    Selected
- M1000   Selected
- M10000  Selected
- M10001  Selected
- M10007  Selected
- M10008  Selected

Command ==>>> _____ Scroll PAGE
F1=Help   F2=Split  F3=Exit   F4=CRetriev F5=Refresh  F7=Up
F8=Down   F9=Swap   F12=Cancel
    
```

Data set/path name

Can be a fully-qualified data set name or a pattern, an HFS file or directory, a WebSphere® MQ queue name, or a CICS® resource.

For information about specifying a WebSphere® MQ queue name, see [Specifying an MQ manager or queue on page 48](#).

For information about specifying a CICS® resource, see [Specifying a CICS resource on page 48](#).

The name may include a member name or name pattern in parenthesis. If the member is specified here, the associated **Member** field must be empty.

When you specify an HFS file or directory, you must enter a full path name. If the path name is longer than the displayed entry field, press the Expand function key to display a pop-up window in which you can enter a longer name.

Member

If you specified the name of a partitioned data set (PDS) without including a member name or name pattern in parenthesis in the **Data set name** field, then you can use this field to specify the member name or a member name pattern.

Volume serial

Serial number of the volume which contains the data set. Required for data sets which are not cataloged.

Record count

Number of logical records to be searched for FIND/CHANGE/FINDNOT commands. For a PDS, the number of logical records to be searched per member.

Range = 1 - 99,999,999; default = ALL.

Additional options

Collapses or expands the following section of the Find/Change Utility panel.

When a minus sign ("-") is shown, position the cursor on the minus sign and press Enter to expand the following section of the panel.

When a plus sign ("+") is shown, position the cursor on the plus sign and press Enter to collapse the following section of the panel.

Listing data set

Specifies the data set where File Manager find/change results are to be stored. Use the default name or enter a sequential data set name.

Default: 'userid.SRCHFOR.LIST'

JCL source format

Indicates that the data set contains JCL and that the JCL syntax is to be preserved.

If not successful at maintaining the number and size of records, File Manager attempts to rewrite the file:

- More errors are possible in this case. For example, a PDS(E) may run out of room.
- If a logical line is changed and requires more physical records, the file is rewritten. The data in columns 73–80 for new physical records is copied from the last related original physical record.

The file must be non-VSAM and have a fixed record length of 80.

When using the **JCL source format** option, the columns searched are set to 3 through 71, unless the statement is not a JCL statement. A statement is considered to be a JCL statement if it begins with the strings `"/*` or `"/"`. If the statement does not begin with either of these strings, it is not considered to be a JCL statement in which case any column range specified on the FIND (or CHANGE, respectively) command or preset using the BOUNDS command is honored. If no column range has been specified, the full record is searched.

Use REXX proc

You can use this option to perform either of these actions

- Enter a temporary REXX procedure for one-time use by entering a single asterisk (*). File Manager displays an Edit panel, in which you can create a new REXX procedure.
- Specify the name of the member containing the REXX procedure you want to use, The member must belong to the PDS allocated to ddname FMNEXEC. You can enter any of the following:

- The name of the member.
- A member name pattern (other than a single *) to list all matching members. You can then select the required member by entering an `s` in the **Sel** field. A member name pattern can consist of any characters that are valid in a member name and the following two special pattern characters:

asterisk (*)

Represents any number of characters. As many asterisks as required can appear anywhere in a member name. For example, if you enter `*d*`, a list of all members in the data set whose name contains "d" is displayed.

percent sign (%)

A place-holding character representing a single character. As many percent symbols as necessary can appear anywhere in a member name. For example, if you enter `****`, a list of all members in the data set whose name is four characters in length is displayed.



Note: If you select this option but leave the **Use REXX proc** member entry field blank, File Manager displays a member name list. You can then select the required member by entering `s` in the **Sel** field.

(Also, see [Supplying a procedure when using a File Manager panel on page 530.](#))

REXX no update

Allows you to specify that you intend no updates to the FCH data set while executing the utility. This option is valid only when a REXX procedure has been specified and is ignored otherwise. If selected, it forces the allocation of the data set as input only. All updates to the data are ignored.

Advanced member selection

Enter "/" to specify a range of members to be selected rather than a specific or generic member name.

Binary mode

When processing an HFS file, allows you to specify binary mode (selected) or text mode (unselected).

reclen

When processing an HFS file and the Binary mode option is selected, records are derived based on the fixed record length specified. The default is 80. Can be in the range: 1–32760.

Use I/O exit

Allows you to specify a user I/O exit for compressed or encrypted data sets.

This option has two fields. To select the option, enter "/" in the field to the left of Use I/O exit. With this selected, you can then specify which exit to use in the field to the right of the field label.



Note:



1. The field only displays if File Manager is installed with the option **USEIOX=ENABLE**, and the **Exit enabled** field (in the Set System Processing Options panel) is set to YES. If a default is specified with either of those options, it is displayed in the field to the right of Use I/O exit.
2. An I/O exit can only be used to process the data set in which you are creating records. It cannot be used to process the copybook or template that you are using to format the data set.

Immediate change

When you use the CHANGE command, the input data set is updated immediately (without displaying the changes in the listing data set).

Batch execution

Creates JCL to reflect the command entered. The JCL is presented in an Edit session which you can edit before submitting.

Batch execution restricts the member selection to the pattern specified in the member field. Batch execution does not produce a pop-up selection panel for member selection. If you leave the member field blank, an asterisk (*) is substituted in the JCL generated. For more information, see [FCH \(Find/Change\) on page 1503](#).

Directory integrity

Forces an override of the default PDS(E) member processing method which allows for faster PDS directory access.

This option has significant performance impact. When selected, the members are processed in a way which allows concurrent directory updates as File Manager accesses the members using current directory information.

When not selected, the member processing is performed faster, but may be affected by PDS(E) directory updates, possibly causing I/O errors if the data set is updated concurrently.

Memory

Enter / to perform a change in memory. The following changes occur:

1. Opens the data set or member for input and reads all the records into memory.
2. Supports record length changes when the search and replace strings are different lengths and the resultant length is less than or equal to the maximum logical record length of a variable length data set.
3. Opens for output and writes all the records loaded back to the data set when a change is made.



Note:

1. This option is ignored for VSAM files.
2. This option can be used to avoid the restrictions associated with opening the data set in UPDATE mode.



3. The function is terminated if there is insufficient memory to load the entire member or data set into memory. A larger region size may be required.
4. For compressed data sets, the change is always performed in memory.
5. Memory processing performs slower than update in place.

CAPS initially on

Converts the data entered into input fields to uppercase characters. Do not select this option if you want to enter lowercase characters or mixed case data. This option also affects the processing of **CHANGE** arguments.

Listing Option

Determines the format of the output report.

1 Long

A full report, including each record found or changed.

2 Summary

A summary report providing totals for records processed and strings found and changed.

Stats Option

Determines whether ISPF statistics (if present) for the PDS members being processed are updated:

Blank

Update ISPF statistics.

1 Off

Do not update ISPF statistics.

2 Force

Always update or create ISPF statistics.

ISPF Packing

Provided that the data set is a sequential, PDS or PDSE file and an I/O exit routine is not used, one of these options can be used to control the utility's behavior when processing data that is in ISPF PACK format.

1. Asis

If the data set is packed, it is unpacked before any processing. The data set is rewritten in packed format only when it was packed initially.

2. Pack

If the data set is packed, it is unpacked before processing. The data set is always rewritten in unpacked format.

3. Unpack

If the data set is packed, it is unpacked before processing. The data set is always rewritten in packed format.

4. None

No checking or processing of ISPF packed data occurs. The FIND and CHANGE commands operate on the packed data. This option is forced if an I/O exit has been used.

5. Skip

If the data is packed, no processing occurs.

Example

Available commands

- [BOUNDS primary command on page 1123](#)
- [CAPS primary command on page 1124](#)
- [CHANGE/CX primary command on page 1129](#)
- [FIND/FX primary command on page 1157](#)
- [FINDNOT primary command on page 1168](#)
- [LOCATE primary command on page 1182](#)
- [REFRESH primary command on page 1205](#)
- [RESET primary command on page 1208](#)
- [SELECT primary command on page 1218](#)
- [SORT primary command on page 1224](#)
- [VCONTEXT primary command on page 1235](#)

Parent panels

- [Utility Functions menu panel on page 1077](#)

Equivalent functions

- [FCH \(Find/Change\) on page 1503](#)

Related tasks and examples

- [Finding and changing data in multiple PDS members on page 368](#)
- [Selecting a range of PDS\(E\) members on page 70](#)

FMAP Copybook or Template panel

This panel is entered if no template information is provided with the FMAP command.

Panel and field definitions

Figure 248. FMAP Copybook or Template panel

FMAP Copybook or Template

-
-

Command ==> _____

Provide the data set and member name of the copybook or template to be used to display the selected field.

Data set name 'USERABC.TEMPLATE' _____

Member . . . _____

F1=Help
F9=Swap

F2=Split
F12=Cancel

F3=Exit

F7=Backward

F8=Forward

Data set name

Data set name of the template or copybook to be used to format your data.

Member

Member name of the template or copybook to be used to format your data.

From (or Old) Field Mapping panel

The From Field Mapping panel (or Old Field Mapping panel) provides a list of fields in the "From" or "Old" copybook or template that can be mapped to the selected field in the "To" copybook or template. If called from within the Copy Utility or the Template Workbench and the field does not qualify as a sending field for the selected TO field, the prefix command area is protected (see [Field mapping rules on page 259](#)).

This panel is displayed when the E prefix command is entered against a field on the Field Mapping panel.



Note: If called from the Compare Data Utility, the panel displays all labels with “New” instead of “To” and “Old” instead of “From”.

Panel and field definitions

Figure 249. The From Field Mapping panel

Process	Options	Help			
File Manager From Field Mapping					
To	template/copybook	: FMNUSER.TEMPLATE(FMNCCPY1)			
From	template/copybook	: FMN.SFMNSAM1(FMNCCPY)			
To field	: #4 EMPLOYEE-NO			
From field	: #5 EMPLOYEE-NO			
Corresponding(Y/N)	: N (Auto map for group items).			
Sel	Ref Lvl	From Field Typ Start Length			
		**** Top of data ****			
----	D --	Delete "From field"			
----	1 1	REC-TYPE01	AN	1	80
----	2 2	REC-TYPE	AN	1	2
----	3 2	REC-ID	AN	1	2
----	4 2	NAME	AN	3	20
----	5 2	EMPLOYEE-NO	BI	23	2
----	6 2	AGE	BI	25	2
----	7 2	SALARY	PD	27	4
----	8 2	MONTH(12)	BI	31	4
----	9 2	FILLER	AN	79	2
Command ==>			Scroll PAGE		
F1=Help	F2=Split	F3=Exit	F4=CRetriev	F7=Up	F8=Down
F9=Swap	F12=Cancel				

To (or New) template/copybook

The name of the copybook or template that contains the record descriptions for the "New" data set.

From (or Old) template/copybook

The name of the copybook or template that contains the record descriptions for the "Old" data set.

To (or New) field

Field reference number and name of selected "New" field

From (or Old) field

Field reference number and name of selected "Old" field

Corresponding

Used to specify whether File Manager should automatically map subordinate elementary fields when the “To” or “New” and “From” or “Old” fields are group fields. Specify Y if you want each elementary field in the “From” or “Old” group field mapped to a field in the “To” or “New” group field with the same name. Specify N if you only want the “From” or “Old” field mapped to the “To” or “New” field as though both fields were elementary fields.

Sel

Select field - used to select the “From” or “Old” field you want to map to the “To” or “New” field. You can select the field by entering s in this field.

Ref

From field reference - shows the field reference number assigned by File Manager to the field name in the "From" or "Old" template.

Lev and Field Name

Shows the level number and field name of fields in the "From" or "Old" template that can be validly mapped to the "To" or "New" field. If the selected "To" or "New" field is a level-01 field, only level-01 fields in the "From" or "Old" template are listed. For a "To" or "New" field other than a level-01 field, only those "From" or "Old" fields that can validly be moved to the selected "To" or "New" field are listed for selection.

Type

Shows the data type of the "From" or "Old" field.

Start

Shows the start column of the "From" or "Old" field.

Length

Shows the length of the "From" or "Old" field. For a level-01 field, if the record is variable length, the length shown is the maximum record length.

Delete "from field" (or Delete "old field")

Select this entry if you want to clear the "From" or "Old" field that is currently selected for mapping to the "To" or "New" field.

Example

Available commands

- [FIND/FX primary command on page 1157](#)
- [CHANGE/CX primary command on page 1129](#)
- [BOUNDS primary command on page 1123](#)
- [CAPS primary command on page 1124](#)
- [LOCATE primary command on page 1182](#)

Parent panels

Child panels

Related tasks and examples

GDG Entry Detail panel

Panel and field definitions

Figure 250. GDG Entry Detail panel

```

Process  Options  Help
-----
File Manager          GDG Entry Detail          Line 1 of 4
Command ==> -----
GDG Catalog Entry:
  Data set name . 'DTORNEY.GDG'
  Catalog ID   . . 'CATALOG.USER3.SYSPLEXD'

GDG BASE Attributes:
  Creation date . 2015.246
  Limit . . 255          Maximum number of generations
  Scratch . N          Empty . N          FIFO Y
  Extended N          Purge . N

GDG Associations:
  Related NONVSAM 'DTORNEY.GDG.G0001V00'
                  'DTORNEY.GDG.G0002V00'
                  'DTORNEY.GDG.G0003V00'
                  'DTORNEY.GDG.G0004V00'
                  **** End of data ****

F1=Help      F2=Split      F3=Exit      F4=CRetrieve  F7=Backward  F8=Forward
F9=Swap      F10=Actions   F12=Cancel

```

Parent panels

- [Catalog Services Data Set List panel on page 759](#)
- [Display VTOC Data Set List panel on page 843](#)

Child panels

Related tasks and examples

History Selection panel

The History Selection panel (or Generation Member List panel) provides a list of generations for a selected member in a PDSE that is defined to support member generations.

The panel is displayed when you enter the History command in the prefix area on a Member Selection panel.

Panel and field definitions

Figure 251. Generation Member List panel

Process	Options	Help
File Manager	Generation Member List	Row 00001 of 00004
Compare option <u>1</u> 1. ISPF 2. SuperC 3. File Manager		
DSNAME FMN.PH11137.PDSEV2F		
Name	Prompt	Rel Gen Size Created Changed ID
*	*	* * * * *
-----MEM1		0 0 2 2019/02/15 2019/02/15 09:43:05 HGRAMPA
-----MEM1		-1 3 3 2019/02/15 2019/02/15 09:24:38 HGRAMPA
-----MEM1		-2 2 2 2019/02/15 2019/02/15 09:22:09 HGRAMPA
-----MEM1		-3 1 1 2019/02/15 2019/02/15 09:21:13 HGRAMPA
**** End of data ****		
Command ==>		Scroll PAGE
F1=Help	F2=Split	F3=Exit F4=CRetriev F5=RFind F7=Backward
F8=Forward	F9=Swap	F10=Left F11=Right F12=Cancel

Compare option

Specify the comparison utility to be used for the Compare prefix commands (CC, CN, CP, and CS):

1. ISPF Edit compare, using the ISPF VIEW service. This is the default option.
2. SuperC compare.
3. File Manager Compare function (DSM).



Notes:

1. Option 3, File Manager is the default option for comparing unformatted records such as program objects.
2. For option 1. ISPF and option 2. SuperC, member generations are copied to a temporary data set to perform the comparison.

The fields displayed for the member list vary depending on the type of data set being displayed:

- PDSEs with formatted records
- PDSEs with unformatted records (such as program objects)

The common fields displayed (for either type) are:

(prefix area)

You can enter commands in the prefix area before each row in the member list. For details of the supported commands, see [Prefix commands on page 643](#).

Name

The name of the member.

Where generation information is displayed:

- Current members (generation 0) are highlighted in white.
- Member generations are blue.
- Orphaned member generations (without a generation 0) are red.

Where alias information is displayed:

- Primary members are highlighted in white.
- Aliases are blue.

Prompt

A dynamic area that displays the last action that occurred for the listed member.

Rel

This is the relative generation number of the member generation. The relative generation is either 0 or a negative number. The current member always has a relative generation = 0, with the most recent generation created having a relative generation of -1, then -2, and so on. The maximum number of generations is defined by the MAXGENS parameter when the PDSE version 2 data set is created.

Gen

This is the absolute generation number of the member generation. The absolute generation is either 0 or a positive number. The current member always has an absolute generation = 0. The absolute generation number is 1 for the first generation and incremented by 1 for each new generation.

For data sets with formatted records, the following fields are displayed for members stored with ISPF statistics, otherwise they are left blank:

Size

The current number of statements in the member.

Created

The date the member was created, in YYYY/MM/DD format.

Changed

The date and time, in YYYY/MM/DD HH:mm:SS format, on which the member was last changed.

ID

The User ID of the person who last created or changed the member.

INIT

The initial number of records in the member.

MOD

The current number of records in the member

VV.MM

The version and modification level of the member.



Note: Modifying the current member will update the ISPF statistics (if saved) for the current member but will not affect the ISPF statistics on the member generations.

For data sets with unformatted records, the following fields are displayed:

Size

The hexadecimal value for the load module size.

AC

Authorization code.

AM

AMODE binder value.

RM

RMODE binder value.

Attributes

Attribute values determined by binder:

RF

The module is refreshable.

RN

The module is reenterable.

RU

The module is reusable.

OV

The module has overlay structures.

NX

The module is not executable.

OL

The module is loadable.

SC

The module is scatter format.

TS

The module has test attribute.

TTR

The TTR of the first block of text.

For PDSEs the TTR field is a token that simulates the track and record location of the member, also known as Member Locator Token (MLT).

EPA

Entry point address associated with the member name or alias name.

SSI

SSI information word.

Example**Available commands**

The following primary commands are available:

- [BOTTOM primary command on page 1122](#)
- [DELETE \(records\) primary command on page 1144](#)
- [DOWN primary command on page 1146](#)
- [FIND/FX primary command on page 1157](#)
- [HEX primary command on page 1172](#)
- [LEFT primary command on page 1178](#)
- [LOCATE primary command on page 1182](#)
- [REFRESH primary command on page 1205](#)
- [RESET primary command on page 1208](#)
- [RFIND primary command on page 1211](#)
- [RIGHT primary command on page 1212](#)
- [SORT primary command on page 1224](#)
- [TAILOR primary command on page 1230](#)
- [TOP primary command on page 1232](#)
- [UP primary command on page 1234](#)

Parent panels

- [Member Selection panel on page 946](#)

Child panels

- None.

Related tasks and examples

- [Specifying a data set and a member name on page 42](#)
- [Selecting a range of PDS\(E\) members on page 70](#)
- [Manipulating your view of selection lists on page 62](#)

IAM KSDS Define panel

You can use the IAM ESDS Define or IAM KSDS Define panel to specify the allocation attributes for IAM data sets. There are two versions of this panel, one for each supported IAM data set type (ESDS and KSDS).

Panel and field definitions

Figure 252. IAM KSDS Define panel

```

Process  Options  Help
-----
File Manager                IAM KSDS Define

NONVSAM Catalog Entry:
  Data set name . . 'USERID.NEWD33'
  Catalog ID . . . .
                                     More:      +

VSAM Associations:
  VSAM data type . . KSDS      Expiration date . _____
  Dataset Owner id . $IAM_____

IAM Override information (if any)
-----
VSAM Cluster Attributes:
  Key length . . . . _____  Key offset . . . . _____
  CI size . . . . . _____  size of the data control intervals
  Buffer space . . . . _____  buffer space to be allocated at open time
  Shr cross region . -

VSAM Data Allocation:
Press ENTER to define the catalog entry or EXIT to cancel
Command ==>
F1=Help      F2=Split    F3=Exit     F4=CRetriev F7=Up       F8=Down
F9=Swap      F10=Actions F12=Cancel
    
```

NONVSAM Catalog Entry - Data set name

The name of the catalog entry, from one to 44 characters. For DEFINE and ALTER commands, enter the new name.

NONVSAM Catalog Entry - Catalog ID

Name of a catalog that contains the entry. Default: System catalog search order.

Dataset Owner id

Specify the ownerid of the data set. Note that IAM files are required to have either an OWNER of \$IAM, or the word \$IAM somewhere within the data set name. If this is not the case, the define process may create a VSAM cluster instead of a IAM data set.

IAM Override information

This allows you to enter any parameters for the CREATE override statement when defining a IAM file. This is an optional field. Any information entered here is appended to a CREATE statement generated internally by File Manager.

VSAM Associations, Cluster Attributes, and so on

For general information about defining data sets, see the *DFSMS Using Data Sets* manual appropriate for your operating system. For specific information about valid field values, use the field-level Help (put your cursor in the field and press F1).

Parent panels

[Allocate panel on page 737](#)

Child panels

- None.

Equivalent functions

- None.

Related tasks and examples

[Allocating a new data set on page 332](#)

IAM Entry Details panel

The Catalog Services: IAM Entry Detail panel is used to display the parameters of a selected IAM data set, allowing you to review or modify them.

Panel and field definitions

Figure 253. Example: Catalog Services parameters for an IAM entry (first panel)

```

Process  Options  Help
-----
File Manager          IAM Entry Detail          Line 1 of 32

IAM NONVSAM Entry details:
Catalog Id . . . . 'CATALOG.UCATAPC'
Data set name . . 'FMNUSER.TESTMV.IAM.ESDS'
VSAM data type . . ESDS          (KSDS or ESDS)
Creation date . . 2001.331      Expiration date . (NONE)
SMS managed . . . Y          Data class . . . . *UNKNOWN
Storage class . . BASE      Management class . STANDARD
Last backup date . 0000.000.0000

IAM details from IAMPRINT:
IAM100 IAM FILE ANALYSIS - DSN=FMNUSER.TESTMV.IAM.ESDS
-----
FILE FORMAT -- = ENHANCED - FILE STATUS ----- = LOADED
RECORD SIZE -- = 27990 - FREESPACE - CI% ----- = 0
CI SIZE ----- = 32768 - FREESPACE - CA% ----- = 0
BLOCK SIZE --- = 32760 - EXTENDED PE ----- = 8635 BLOCK
BLOCK FACTOR - = 1 - REQUESTED OVERFLOW ---- = 0 RECS

Command ==>> ----- Scroll CSR
F1=Help      F2=Split    F3=Exit     F4=CRetriev F7=Up      F8=Down
F9=Swap      F10=Actions F11=Stats   F12=Cancel

```

Figure 254. Example: Catalog Services parameters for an IAM entry (continued)

```

Process  Options  Help
-----
File Manager          IAM Entry Detail          Line 8 of 32

IAM NONVSAM Entry details:
Catalog Id . . . . 'CATALOG.UCATAPC'
Data set name . . 'FMNUSER.TESTMV.IAM.ESDS'
VSAM data type . . ESDS          (KSDS or ESDS)
Creation date . . 2001.331      Expiration date . (NONE)
SMS managed . . . Y          Data class . . . . *UNKNOWN
Storage class . . BASE      Management class . STANDARD
Last backup date . 0000.000.0000

IAM details from IAMPRINT:
VAR OVERFLOW - = NO - EXTENDED OVERFLOW ----- = 0 BLOCK
FILE TYPE ---- = ESDS - EXTENDED ALLOCATED ---- = 8641 BLOCK
DEVICE TYPE -- = 3390 - EXTENDED AVAILABLE ---- = 0 BLOCK
VOLUME COUNT - = 5 - SPACE USED ----- = 8850 TRACK
VOLSER ----- = MVS4W5 - SPACE ALLOCATED ----- = 3240 TRACK
VOLSER ----- = MVS4W4 - SPACE ALLOCATED ----- = 1635 TRACK
VOLSER ----- = MVS4WA - SPACE ALLOCATED ----- = 1965 TRACK

Command ==>> ----- Scroll CSR
F1=Help      F2=Split    F3=Exit     F4=CRetriev F7=Up      F8=Down
F9=Swap      F10=Actions F11=Stats   F12=Cancel

```

Figure 255. Example: Catalog Services parameters for an IAM entry (continued)

```

Process  Options  Help
-----  -
File Manager          IAM Entry Detail          Line 15 of 32
IAM NONVSAM Entry details:
Catalog Id . . . . 'CATALOG.UCATAPC'
Data set name . . 'FMNUSER.TESTMV.IAM.ESDS'
VSAM data type . . ESDS          (KSDS or ESDS)
Creation date . . 2001.331      Expiration date . (NONE)
SMS managed . . . Y          Data class . . . *UNKNOWN
Storage class . . BASE        Management class . STANDARD
Last backup date . 0000.000.0000

IAM details from IAMPRINT:

VOLSER ----- = MVS4WB - SPACE ALLOCATED ----- = 1005 TRACK
VOLSER ----- = MVS4WB - SPACE ALLOCATED ----- = 1005 TRACK
TOTAL EXTENTS = 55 - TOTAL SPACE ALLOCATED - = 8850 TRACK
PRIMARY SPACE = 67 - SECONDARY SPACE ----- = 67 CYL
MULTIVOLUME -- = SECONDARY - MAX SECONDARY ----- = 67 CYL
RELEASE ----- = NO - SHARE OPTIONS ----- = 2
DATA COMPRESS = ENABLED - INDEX COMPRESS ----- = NO

Command ==>> ----- Scroll CSR
F1=Help      F2=Split    F3=Exit     F4=CRetrie  F7=Up      F8=Down
F9=Swap      F10=Action  F11=Stats   F12=Cancel

```

Figure 256. Example: Catalog Services parameters for an IAM entry (continued)

```

Process  Options  Help
-----  -
File Manager          IAM Entry Detail          Line 22 of 32
IAM NONVSAM Entry details:
Catalog Id . . . . 'CATALOG.UCATAPC'
Data set name . . 'FMNUSER.TESTMV.IAM.ESDS'
VSAM data type . . ESDS          (KSDS or ESDS)
Creation date . . 2001.331      Expiration date . (NONE)
SMS managed . . . Y          Data class . . . *UNKNOWN
Storage class . . BASE        Management class . STANDARD
Last backup date . 0000.000.0000

IAM details from IAMPRINT:

TOTAL RECORDS = 110173 - INSERTS ----- = 102173
UPDATES ----- = 0 - DELETES ----- = 0
HIGH USED RBA =3610148864 - HIGH ALLOCATED RBA ---- = 289926000
FILE DEFINED  = 2001.331 - 11/27/2001 - 2:07 PM - = 14:07:39
FILE LOADED -- = 2001.331 - 11/27/2001 - 2:07 PM - = 14:07:41
LAST UPDATED - = 2001.331 - 11/27/2001 - 2:12 PM - = 14:12:33
STORAGE REQUIRED FOR PRIME INDEX ----- = 824

Command ==>> ----- Scroll CSR
F1=Help      F2=Split    F3=Exit     F4=CRetrie  F7=Up      F8=Down
F9=Swap      F10=Action  F11=Stats   F12=Cancel

```

Figure 257. Example: Catalog Services parameters for an IAM entry (continued)

```

Process  Options  Help
-----
File Manager          IAM Entry Detail          Line 29 of 32
IAM NONVSAM Entry details:
Catalog Id . . . . 'CATALOG.UCATAPC'
Data set name . . 'FMNUSER.TESTMV.IAM.ESDS'
VSAM data type . . ESDS          (KSDS or ESDS)
Creation date . . 2001.331      Expiration date . (NONE)
SMS managed . . . Y          Data class . . . *UNKNOWN
Storage class . . BASE        Management class . STANDARD
Last backup date . 0000.000.0000

IAM details from IAMPRINT:

      NUMBER OF IAM DATA BLOCKS ----- =          208
      EXTENDED HIGH ALLOCATED RBN ----- =          8849
      -----

**** End of data ****

Command ==> ----- Scroll CSR
F1=Help      F2=Split    F3=Exit     F4=CRetriev F7=Up      F8=Down
F9=Swap      F10=Actions F11=Stats   F12=Cancel

```

For more information about the fields in this panel, refer to your IAM documentation or press F1 in any field.

Parent panels

- [Catalog Services Data Set List panel on page 759](#)

Child panels

- None.

Equivalent functions

- None.

Related tasks and examples

- [IAM Entry Detail display on page 425](#)

Initialize Tape panel

Panel and field definitions

Figure 258. Initialize Tape panel

Process	Options	Help
File Manager		Initialize Tape
Tapes: No tapes allocated		
Output:		
DDNAME to use . _____		enter new name, or select one from above
Tape mode	___	optional recording mode or density code
Volume serial . _____		volume identifier or blank for NL tape
Data set name . _____		
ASCII format . <u>NO</u>		YES or NO
Scale percent . <u>0</u>		optional scale percentage or 0 for all
Command ==> -----		
F1=Help	F2=Split	F3=Exit
F9=Swap	F10=Actions	F12=Cancel
	F4=CRetrieve	F7=Backward
		F8=Forward

Parent panels

[Tape Specific Functions panel on page 1047](#)

Child panels

Related tasks and examples

Key positioning panel

Panel and field definitions

Figure 259. Key positioning panel

Process	Options	Help
Key Positioning		Line 1 of 2
Data set: FMN.RFM0740.HOGN.KSDS		
Field	Data	
M-KEY		0
Command ==> -----		
F1=Help	F2=Split	F3=Exit
F8=Down	F9=Swap	F12=Cancel
	F4=CRetrieve	F5=RFind
		F7=Up
		Scroll PAGE

Formatted key positioning allows you to change the current key location using the template provided. All field values that are required to map the key area are displayed using SNGL format.

To control the appearance of the SNGL display, these SNGL display primary commands are available:

- HEX
- PIC
- RDF
- REF
- SLOC
- STR

To scroll the key display, use these commands:

- BOTtom
- DOWN
- TOP
- UP

To search the display area, use these commands:

- Find
- Locate

01 Layout Selection List panel

Panel and field definitions

Figure 260. 01 Layout Selection List panel

Process	Options	Help
01 Layout Selection List		
F		
I		
	Field Name	S Length
	*	*
	M-KEY-GROUP	S 12
	M-ACCOUNT-CODING-STRUCTURE	S 57
	M-ORIGINAL-ACT-INFO	S 20
	M-CLOSED-ACT-INFO	S 18
	M-STATEMENT-FIELDS	S 29
	M-FLOAT-FIELDS	S 75
C	M-POSTING-FIELDS	S 110
	M-YTD-AGG-FIELDS	S 56
	M-STMT-DEFINITION	S 26
P	M-AVG-BAL-HISTORY	S 184
	M-ACCOUNT-DEMOGRAPHICS	S 63
	M-CHARGES-DUE	S 22
	M-SERVICE-CHARGE-HISTORY	S 98
	M-ACT-TRANSFER-DATA	S 22
	M-OD-RET-CK-DAILY-CHGS	S 18
	M-AGG-FIELDS	S 240
	Command ==>	Scroll PAGE
	F1=Help	F2=Split F3=Exit F4=CRetrieve
	F5=RFind	F7=Backward F8=Forward F9=Swap
Command ==>		
	F1=Help	F2=Split F3=Exit F4=Expand F7=Backward F8=Forward
	F9=Swap	F10=Left F11=Right F12=Cancel

This panel is entered to select a layout to be used by the calling command. Use the prefix command S or / to select the layout to be used.

The columns displayed are as follows:

Field Name

The 01 field names in the current template.

S

Whether the layout is currently selected for processing.

Length

The length of the associated layout.

Library List panel

The Library List panel is used to specify the data sets in which multiple copybook members can be found. Up to 12 data set libraries can be specified.

Panel and field definitions

Figure 261. Library List panel

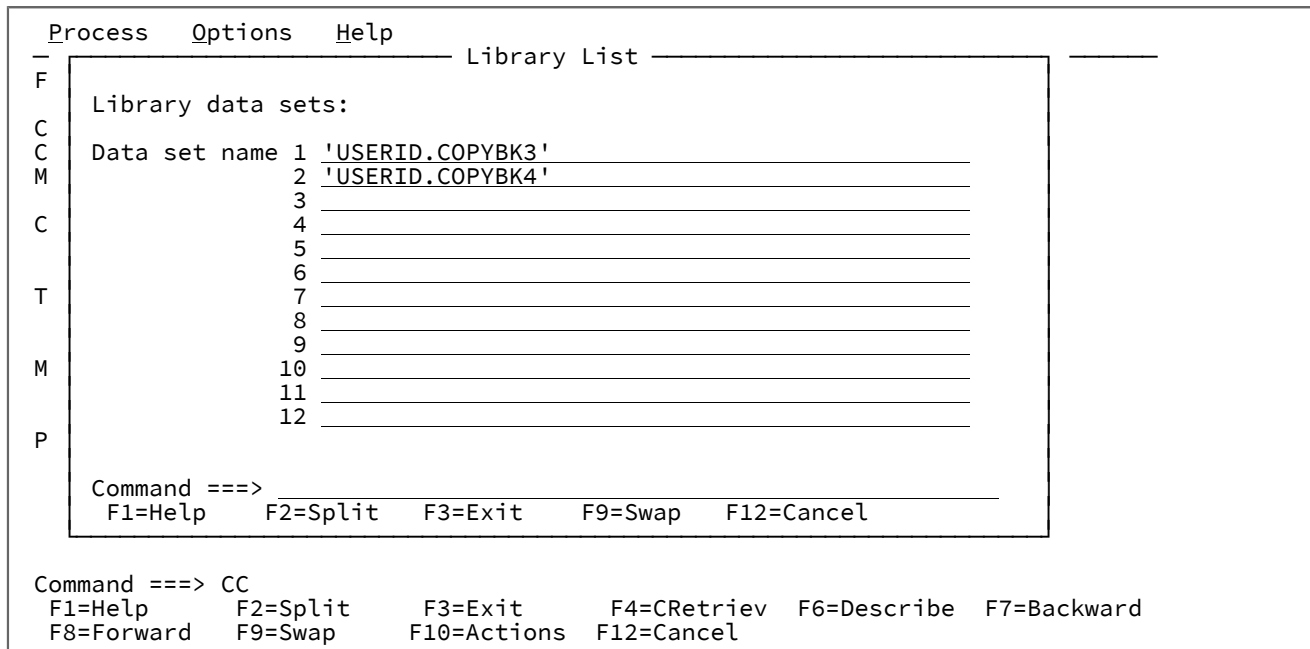

Data set name

The name of the SYSLIB data sets in which your copybooks reside. The first entry is populated with the copybook name specified on the Template Workbench panel. Any libraries previously identified are also displayed. Up to 11 additional SYSLIB data sets can be specified (total of 12 SYSLIB data sets). Up to 12 data set libraries can be specified. The data sets may be PDSs, PDSEs, CA-Panvalet libraries, or other library management system libraries. You can specify multiple PDSs, PDSEs, CA-Panvalet and other library management system libraries but they must be either all PDSs or PDSEs, or all CA-Panvalet, or all the same library management system libraries. You cannot mix library types.

All copybooks to be included in a template must be of the same language, that is, all COBOL or all PL/1.

Library members may not be packed by ISPF.

Parent panels

- [Template Workbench panel on page 1072](#)

Child panels

- [Copybook Selection panel on page 810](#)

Related tasks and examples

Load Module Compare - entry panel

Panel and field definitions

Figure 262. Load Module Compare: Entry panel

Process	Options	Help
File Manager		
Load Module Compare		
"Old" Partitioned Data Set:		
Data set name	'FMN.RFM0411.COPY'	
Member	RFM0411	Blank or pattern for member list
Volume serial		If not cataloged
"New" Partitioned Data Set:		
Data set name	'FMNUSER.TEMPLATE'	
Member	EXPORT1	Blank or pattern for member list
Volume serial		If not cataloged
Processing Options:		
Enter "/" to select option		
<input type="checkbox"/> Batch execution		<input type="checkbox"/> Advanced member selection
		<input type="checkbox"/> Skip member name list
Command ==>		
F1=Help	F2=Split	F3=Exit
F9=Swap	F10=Actions	F12=Cancel
	F4=CRetrieV	F7=Backward
		F8=Forward

"Old" Partitioned Data Set:

You can use this group of fields to specify the "Old" load module to be compared. It contains:

Data set name

Specify the data set being a load module library (PDS). The data set name may include a member name or name pattern in parenthesis. If the member is specified here, the associated **Member** field must be blank.

Member

If you specified the name of a data set (PDS) without including a member name or name pattern in parenthesis in the **Data Set name** field, then you can use this field to specify the member name or a member name pattern.

Volume

Specify a volume serial number if the data set is not cataloged.

"New" Partitioned Data Set:

You can use this group of fields to specify the "New" load module to be compared. It contains:

Data set name

Specify the data set being a load module library (PDS). The data set name may include a member name or name pattern in parenthesis. If the member is specified here, the associated **Member** field must be blank.

Member

If you specified the name of a data set (PDS) without including a member name or name pattern in parenthesis in the **Data Set name** field, then you can use this field to specify the member name or a member name pattern.

Volume

Specify a volume serial number if the data set is not cataloged.



Note: Specification of the "New" load module depends on the specification of the "Old" load module. If the "Old" load module specifies one member, the "New" load module must point to one member. If the "Old" load module specifies a member name pattern, the "New" load module must use the same pattern or "*".

Processing Options

The processing options enable you to specify additional processing parameters. The options are:

Batch execution

Enter "/" to edit the JCL to run the function in batch.

Advanced member selection

Enter "/" to specify a range of members to be selected rather than a specific or generic member name.

Skip member name list

Enter "/" to run without showing the member selection list.

Parent panels

- [Load module utility functions panel on page 940](#)

Child panels

- [Compare Utility: Load module options panel on page 768](#)

Equivalent functions

- [CLM \(Compare Load Module\) on page 1274](#)
- [DSM \(Data Set Compare\) on page 1388](#)

Related tasks and examples

- [Comparing data sets on page 381](#)

Load Module Information panel

Panel and field definitions

Figure 263. View Load Module: Information panel

Process	Options	Help							
File Manager	Load Module Information	Row 00001 of 00001							
Load Library	FMN.LOAD								
Load Module	EXITINVO								
Linked on LINKED ON 2007.186 AT 17:16:02 by PROGRAM BINDER 5695-PMB V1R7									
EPA 000000 Size 0000138 TTR 00341A SSI AC 00 AM 31 RM ANY									
Attributes RN RU									
ADDRESS	CSECT	NAME	TYPE	SIZE	Class	AMODE	RMODE	DATE	COMPILER 1
<----->	*	<----->	*	<----->	*	<----->	*	<----->	*
0000000	EXITINVO	SD	SD	0000138	B_TEXT	31	ANY	2007.186	HIGH-LEVEL ASSE
**** End of data ****									
Command ==>									
F1=Help	F2=Split	F3=Exit	F4=CRetriev	F5=RFind	Scroll PAGE				
F8=Forward	F9=Swap	F10=Left	F11=Right	F12=Cancel	F7=Backward				

Load Library

The name of the load library for the load module.

Load Module

The name of the load module.

Linked on *date at time by program number*

The date and time the load module was link edited (bound) and the program number of the linkage editor or binder that was used.

EPA

Entry point address of the load module.

Size

The length (in hexadecimal) of the load module.

TTR

The address of the member in Track and Record (TTR) format.

SSI

The system status index (SSI) of the load module.

AC

The authorization code (AC) of the load module.

AM

The addressing mode (AMODE) of the load module.

RM

The residency mode (RMODE) of the load module.

Attributes

One or more of the following load module attributes:

RF

The module is refreshable.

RN

The module is reenterable.

RU

The module is reusable.

OV

The module has overlay structures.

NX

The module is not executable.

OL

The module is loadable.

SC

The module is scatter format.

TS

The module has test attribute.

CSECT name

The section symbol. This column can contain the following special values:

- **PRIVATE** - indicates that the CSECT is unnamed (private).
- **PSEUDOR** - indicates that the module contains definition statements for pseudo registers.
- **(BLANK)** - indicates that the common section (CM) is unnamed.

Type

The section symbol type:

CM

A common section definition

SD

A section definition

PC

A private section definition

LD

A label definition

Address

The offset (hexadecimal) of the symbol in the load module.

Size

The length (hexadecimal) of the section.

Class

The class name of the section.

A/RMODE

The AMODE/RMODE of the CSECT.

Date

The date of the first compilation (if available).

Compiler 1

The short name or number of the first compiler (if available).

Compiler 2

A short name or the program number of the second compiler (if available).

Date 2

The date of the second compilation.

User data

The data that is provided by users. For example, identification, comments.

Line commands:

You can enter the following commands in the prefix area of the data display:

A

View programming language related attributes that are used by this section.

D

Disassembles this section.

I

Lists the user data that is associated with the `IDENTIFY` statement at bind time.

O

Views the compile options for this section.

S

Views the text for this section.

Z

Views the ZAP data associated with this section.

Load Module Compiler Options panel

This panel shows all the compiler options that are associated with a section name. Each option starts on a new line.

Figure 264. View Load Module: Compiler Options panel

Process	Options	Help
File Manager	LOAD MODULE COMPILER OPTIONS	Row 00001 of 00051
Section Name	SFMSAM1CATE1	
Class	B_TEXT	
COMPILER OPTIONS - Enterpr. PL/I for z/OS V3R6		
<-----10-----2-----3-----4-----5-----6-----7----->		
ARCH(5)		
BACKREG(5)		
BIFPREC(15)		
CHECK(NOCONFORMANCE NOSTORAGE)		
CMPAT(V2)		
CODEPAGE(01140)		
NOCOMMON		
NOCOMPACT		
CSECT		
CSECTCUT(4)		
CURRENCY('\$')		
NODBCS		
Command ==>		
F1=Help	F2=Split	F3=Exit
F9=Swap	F10=Left	F11=Right
F4=Expand	F5=RFind	F7=Up
F12=Cancel		F8=Down

Load Module Disassembly panel

Panel and field definitions

Figure 265. View Load Module: Disassembly panel

Process	Options	Help
File Manager	LOAD MODULE DISASSEMBLY	Row 00001 of 00109
Section Name	SFMSAM1CATE1	
Class	B_TEXT	
LOCATION	OFFSET	HEX
00000000	0	F2F0 F1F3 F0F9
00000006	6	F0F2 F1F2 F0F6
0000000C	C	F3F8 F0F3 F0F6
00000012	12	F0F0 002C 0908
00000018	18	0505 5B00 079E
0000001E	1E	0000 0474 6408
00000024	24	1F1F 0F0F 2461
0000002A	2A	2109 0180 006C
00000030	30	3600 2302 0FC4
00000036	36	0000 0000 0000
0000003C	3C	0000 0000 0000
00000042	42	0000 0000 0000
00000048	48	47F0 F024
Command ==>		
F1=Help	F2=Split	F3=Exit
F9=Swap	F10=Left	F11=Right
F4=Expand	F5=RFind	F7=Up
F12=Cancel		F8=Down

Disassembly of the text data for a given section.

Location

The absolute address of the instruction within the load module

Offset

The relative address of the instruction within the section

Hex

The hexadecimal representation of the instruction

Label

The first 8 bytes of the section name is used for the first label.

Code

Disassembled instructions.

Load Module Identify panel

This panel shows all the user data that is associated with a section name. The user data for each identify statement is shown on separate lines.

Figure 266. View Load Module: Identify panel

```

Process  Options  Help
-----
File Manager          LOAD MODULE IDENTIFY          Row 00001 of 00001

Section Name  BPX1GTH
Class        B_TEXT

User data
<-----10-----2-----3-----4-----5-----6-----7-----> -
RSI12150072
****  END OF DATA  ****

Command ==>
F1=Help  F2=Split  F3=Exit  F4=Expand  F5=RFind  F7=Up      Scroll PAGE
F9=Swap  F10=Left  F11=Right  F12=Cancel  F8=Down

```

Load Module Text panel

Panel and field definitions

Figure 267. View Load Module: Text panel

Process		Options		Help		
File Manager		LOAD MODULE TEXT		Row 00001 of 00020		
Section Name	EXITINVO					
Class	B_TEXT					
LOCATION	OFFSET	-----HEX-----			-----CHAR-----	
00000000	0	90ECD00C	18CF58B1	000058BB	00004110	°Ö).Öi£ i] . .
00000010	10	B0AC50D1	0004501D	000818D1	D503B00C	^Ð&J .&. ..JN.^.
00000020	20	C1304720	C03E58F0	B00C89F0	000247FF	A.ä.{.i0^.i0 .ä.
00000030	30	C02E47F0	C08047F0	C0FE47F0	C08A0700	{.ä0{0ä0{Üä0{ú.
00000040	40	4510C074	00300000	C5E7C9E3	C9D5E5D6	ä.{É . EXITINVO
00000050	50	406040C3	81939385	8440A689	A38840C9	- Called with I
00000060	60	95A58193	89844086	A49583A3	89969540	nvalid function
00000070	70	83968485	0A23D203	B050C134	47F0C0FE	code.K.^&A.ä0{U
00000080	80	D21FB0F4	C11047F0	C0FEBF4F	B0144780	K.^4A.ä0{Ú× ^.ä0
00000090	90	C0FE5850	B0105860	B03495C1	50004740	{Üi&^.i-^nA& ä
000000A0	A0	C0B295E9	50004720	C0CA92C1	600047F0	{¥nZ& ä.{kA- ä0
000000B0	B0	C0E89581	50004740	C0E295A9	50004720	{Yna& ä {Snz& ä.
000000C0	C0	C0E29281	600047F0	C0E895F0	50004740	{Ska- ä0{Yn0& ä
Command ==>					Scroll	PAGE
F1=Help	F2=Split	F3=Exit	F4=Expand	F5=RFind	F7=Up	F8=Down
F9=Swap	F10=Left	F11=Right	F12=Cancel			

Dump format of the class data for a given section.

Location

The absolute address of this data within the load module

Offset

The relative address of this data within the section

Hex

The hexadecimal representation of the data

Char

The character representation of the data

Load Module ZAP panel

This panel shows all the ZAP ID and ZAP dates that are associated with the section name.

Figure 268. View Load Module: ZAP panel

```

Process  Options  Help
-----
File Manager          LOAD MODULE ZAP INFORMATION          Row 00001 of 00003

Section Name  FMNSAF
Class        B_TEXT

ID           DATE
<-----> <-----10----->
PI53019     2016/04/29
PI53020     2016/04/29
PI53021     2016/04/29
****  END OF DATA  ****

Command ==>
F1=Help    F2=Split  F3=Exit   F4=Expand  F5=RFind   F7=Up     Scroll PAGE
F9=Swap    F10=Left  F11=Right F12=Cancel F8=Down

```

Load Module Program Attributes panel

The Load Module Program Attributes panel shows all of the program language attributes that are used for the code in the selected section name.

Figure 269. View Load Module: Program Attributes panel

```

Process  Options  Help
-----
File Manager          Load Module Program Attributes          Row 00001 of 00003

Section Name  CBLA2EC1
Class        C_CODE
Program Attributes - Enterpr.COBOl for z/OS V6R2
<-----10-----2-----3-----4-----5-----6-----7-----8-----9-----+
-100-----1-----2----->

Statistics -
  Number of data items: 91
  Number of statements: 148

Data Division -
  QSAM

Environment Division -
  FILE STATUS clause

Procedure Division -
  ADD
  CONTINUE
  DISPLAY
  EXIT
  GOBACK
  IF
  END-IF
  INSPECT
  MOVE
  OPEN
  PERFORM
  END-PERFORM
  READ
  STOP
  SUBTRACT
  WRITE
  Reference modification used

Other -
  COPY statement
  Hexadecimal literal
  **** End of data ****

Command ==> _____ Scroll PAGE
F1=Help  F2=Split  F3=Exit  F4=Expand  F5=RFind  F7=Up    F8=Down
F9=Swap  F10=Left  F11=Right  F12=Cancel

```

Parent panels

Child panels

Related tasks and examples

- [Manipulating your view of selection lists on page 62](#)

Load Module Information - Selection panel

Panel and field definitions

Figure 270. View Load Module: selection panel

Process	Options	Help
File Manager	Load Module Information	
Input:		
Data set name	'FMN.LOAD'	
Member . . .	(Blank or pattern for member list)	
Volume serial	If not cataloged	
CSECTs . . .	+ -	
Processing Options:		
Order CSECTs by	Enter "/" to select option	Report options
<u>1</u> 1. Address	- Batch execution	- Summary
2. Name	- Date format	- Compiler options
Output to	/ Exclude Labels	- Identify
<u>1</u> 1. Display	- Clear print data set	- Text
2. Printer	- Advanced member selection	- Zap
3. XML	- Skip member name list	- Attributes
	- Member selection criteria	
Command ==> -----		
F1=Help	F2=Split	F3=Exit
F9=Swap	F10=Actions	F12=Cancel
	F4=CRetriev	F7=Backward
		F8=Forward

Data set name

Specify the data set being a load module library. The data set name may include a member name or name pattern in parenthesis. If the member is specified here, the associated **Member** field must be blank.

Member

If you specified the name of a data set without including a member name or name pattern in parenthesis in the **Data set name** field, then you can use this field to specify the member name or a member name pattern.

For a member selection list, enter a blank or a pattern.

To select all members, enter an asterisk (*).



Note: For batch execution, blank selects all members and a pattern selects all matching members.

Volume serial

Serial number of the volume containing the data set. Required for data sets which are not cataloged.

CSECTs

Specify string values used to filter the CSECTs to be included in or excluded from display or printing. If this field is blank all CSECTs will be included.

Multiple string arguments can be entered. Use the comma character as a delimiter between the strings. Strings can contain the * and % wildcard characters.

To specify a filter containing lowercase characters, use a character string in the format `c'string'`. Filters can also be specified as hexadecimal strings in the format `x'hex-digits'`.

The following is an example of a filter that would include or exclude from processing Language Environment and COBOL runtime CSECTs from a load module containing an LE-enabled COBOL program:

```
CEE*,IGZ*
```

Exclude

Specify / to exclude CSECTs with names that match the specified CSECT filters from being processed. If this option is not selected the filters are used to include only those CSECTs with matching names for processing.

Order CSECTs by

Use this option to specify the order in which you want the symbols listed.

Address (default)

Sorts the display by the offset (hexadecimal) of the symbol in the load module.

Name

Sorts the display by symbol name.

Output to

Use this option to specify where you want the output to go.

Display

Displays the output to the terminal.

Printer

Prints the output to the printer. The printed output is created according to the print options you have specified.

XML

Prints the output to the printer in XML format. The printed output is created according to the report options that you specified.

Batch Execution

Enter / to edit the JCL to run the function in batch.

Date Format

Enter / to request dates to be formatted according to the mask that you supply in the adjacent field. *YYYY.DDD* is the default. You can enter a value that defines the format that is used to display the date/time for the mask. The format is specified as a string that contains picture characters that are supported by the Language Environment® date callable services. If the mask contains blanks, enclose it in quotation marks.

Example mask	Result
YY/MM/DD	16/04/20
MM/DD/YYYY	04/20/2022
DD/MM/YYYY	20/04/2022
'Www Mmm DD, YYYY'	Wed Apr 20, 2022

Exclude Labels

Enter / to suppress labels for control sections. Some compilers, for example C/C++, generate many labels that you might want to exclude from the display or report. You can suppress these labels by using this option.

Clear print data set

Enter / to clear the print data set before producing the report. This option is only relevant for Printer and XML options when your print settings output is set to data set. The default is to append the report to any existing report on the print data set.

Advanced member selection

Enter / to specify a range of members to be selected rather than a specific or generic member name.

Skip member name list

Enter / to run without showing the member selection list.

Member selection criteria

Enter / to display the **Load Module - Member Selection Criteria** panel. Use this panel to enter search values to identify the load modules to be selected for display or reporting.

Values can be entered to find matches on strings in the compiler names, compiler options, and CSECT names for CSECTs in load modules.

Report options

Report options determine what details you can see on a printed report. Use with the Printer and XML options. It does not affect the Display option.

Summary

Enter / to produce a Load Module summary report that suppresses all control section information. This option is useful if you want to know date and time only when a bind took place.



Note: If you select this option, all other report options are ignored.

Compiler options

Enter / to report compiler options if they can be determined for a control section.

Identify

Enter / to report the data that resulted from the `IDENTIFY` statement for control sections.

Text

Enter / to report the text data in dump format for each control section in the load module.

Zap

Enter / to report the ZAP data for control sections.

Attributes

Enter / to report program language attributes, if available, for a control section.

Parent panels

Child panels

- [Load Module - Member Selection Criteria panel on page 938](#)

Related tasks and examples

Load Module - Member Selection Criteria panel

Use the Load Module - Member Selection Criteria panel to specify search filters to limit the load modules that are selected for processing.

Panel and field definitions

Figure 271. Load Module Search Filters: entry panel

Process	Options	Help
File Manager	Load Module - Member Selection Criteria	
Library:	'FM3887.COBOL.V620.LOAD'	
Compiler:		ALL
Names/IDs	COBOL, PL/I	+ -
Options	. ARCH(8),ARCH(9)	+ -
CSECT:		
Names	. .	+ /
Command ==>	-----	
F1=Help	F2=Split	F3=Exit
F9=Swap	F10=Actions	F12=Cancel
	F4=CRetriev	F7=Backward
	F8=Forward	

Compiler Names/IDs

Specify strings that will be used to find matching names or product IDs (PIDs) of the compilers used to create CSECTs in the load module.

Multiple string arguments can be entered. Use the comma character as a delimiter between the strings.

When multiple search strings are specified, by default any string that is found in a compiler name is treated as a match for the load module. If you need all of the search strings to be found to constitute a match, select the **ALL** option that corresponds to the compiler **Names/IDs** field.

To specify a filter containing lowercase characters, use a character string in the format `c'string'`. Filters can also be specified as hexadecimal strings in the format `x'hex-digits'`.

The following is an example of using a PID as a search string to select load modules containing CSECTs created with the OS/VS COBOL compiler:

```
5740CB1
```

Compiler Options

Specify strings that will be used to search for a match in the set of compiler options used to create CSECTs in the load module.

Multiple string arguments can be entered. Use the comma character as a delimiter between the strings.

When multiple search strings are specified, by default any string that is found in a set of compiler options is treated as a match for the load module. If you need all of the search strings to be found to constitute a match, select the **ALL** option that corresponds to the compiler **Compiler Options** field.

To specify a filter containing lowercase characters, use a character string in the format `c'string'`. Filters can also be specified as hexadecimal strings in the format `x'hex-digits'`.

The following is an example of search strings used to select load modules containing CSECTs created with either of the compiler options `ARCH` or `TUNE`:

```
ARCH, TUNE
```

CSECT Names

Specify strings that will be used to search for a match in the CSECT names in the load module.

Multiple string arguments can be entered. Use the comma character as a delimiter between the strings. Strings can contain the `*` and `%` wildcard characters.

To specify a filter containing lowercase characters, use a character string in the format `c'string'`. Filters can also be specified as hexadecimal strings in the format `x'hex-digits'`.

When multiple search strings are specified, by default any string that is found in a CSECT name is treated as a match for the load module. If you need all of the search strings to be found to constitute a match, select the **ALL** option that corresponds to the compiler **CSECT Names** field.

The following is an example of search strings used to select load modules containing the CSECT `IGZEBST` or any CSECTs whose name begins with `ILBO`:

```
IGZEBST, ILBO*
```

Processing Options (Match ALL)

Compiler filters

Enter `/` to require all the entered compiler name search strings to be found in a load module to constitute a match. When this option is not selected, if any of the compiler name search strings is found in a load module it is deemed a match.

Compiler Option filters

Enter `/` to require all the entered compiler option search strings to be found in a load module to constitute a match. When this option is not selected, if any of the compiler option search strings is found in a load module it is deemed a match.

CSECT name filters

Enter / to require all the entered CSECT name search strings to be found in a load module to constitute a match. When this option is not selected, if any of the CSECT name search strings is found in a load module it is deemed a match.



Note: If search arguments are specified for more than one filter category (compiler names, compiler options, CSECT names) a load module will only be selected for processing if there is a match for each category.

Parent panels

- [Load Module Information - Selection panel on page 935](#)

Child panels

Related tasks and examples

Load module utility functions panel

The Load module utility functions panel allows you to display either the Load Module Information panel, or the Load Module Compare panel.

Panel and field definitions

Figure 272. Load module utility functions panel

<u>P</u> rocess	<u>O</u> ptions	<u>H</u> elp
File Manager		Load module utility functions
1 View		View load module information
2 Compare		Compare load modules
Command ==>		
F1=Help	F2=Split	F3=Exit
F9=Swap	F10=Actions	F12=Cancel
	F4=CRetriev	F7=Backward
		F8=Forward

1 View

Displays the Load Module Information panel.

2 Compare

Displays the Load Module Compare panel.

Parent panels

- [Utility Functions menu panel on page 1077](#)

Child panels

- [Load Module Information panel on page 927](#)
- [Load Module Compare - entry panel on page 924](#)

Related tasks and examples

- [Comparing load modules on page 400](#)

Map To panel

The Map To panel is used to select or create a copybook or template that can be used as the “To” template in a copy action or the “New” template in a compare action. The templates stores your manually-edited field mappings. The panel can be accessed by entering either the MC or MT commands on the Template Workbench.

Panel and field definitions

Figure 273. The Map To panel

```

  Process  Options  Help
  -----
Map from FMN.SFMNSAM1(FMNCCPY)

CC Create template from copybook      EM Edit mapping
CM Create template from model         U Update template from copybook
GM Generate corresponding map         GE Generate and edit mapping

To Copybook:
  Data set name . 'FMNUSER.COPYBOOK' -----
  Member . . . . FMNCCPY

To Template:
  Data set name . 'FMNUSER.TEMPLATE' -----
  Member . . . . FMNCCPY

Model Template:
  Data set name . -----
  Member . . . . -----

Command ==> -----
F1=Help      F2=Split      F3=Exit      F4=CRetriev  F6=Describe  F7=Backward
F8=Forward   F9=Swap        F10=Actions  F12=Cancel

```

Map from

The name of the copybook or template that contains the record descriptions for the “From” data set.

Map from commands

The Map from commands that you can use are listed at the top of the panel. You can position the cursor on the required command and press Enter or you can type them on the Command Line and press Enter.



Note: The RT and RC commands are only displayed and available when this panel is displayed by invoking one of the supported File Manager copy functions in advance-function mode. The command



is not available when the Template Workbench is displayed using the AF function or a File Manager function other than a copy function.

These commands are:

CC

The CC command is used to create a template from a copybook. You can edit the template before running a function with it. You can also save the template for later use.

You must specify the PDS member name of the copybook you want to use. The copybook you specify is validated by compiling it. File Manager includes the copybook in a shell program, and invokes the compiler to syntax-check the copybook, and to produce an ADATA file. If the compilation completes without errors, the information in the ADATA file is processed to create a template. If the compilation completes with errors, a pop-up menu is displayed. From the pop-up menu you can choose to:

- View the compilation listing.
- Abort the template creation process.
- Retry the compilation.

Before you select this option, you should first view the compilation listing and correct any errors in the copybook. While you are viewing the compilation listing, you can use the split screen facility to swap to another session and use your editor to correct the errors in the copybook.

- Ignore the errors and proceed with creating the template.

This option is only available if File Manager is able to create a template. Some compilation errors, such as warnings, might have no effect on the creation of the template. If you are unsure, you should view the compilation listing. If the compilation error is too severe, File Manager cannot create a template.

If File Manager is able to create a template and you provide the name of a sequential data set or PDS member in which the template is to be saved, File Manager saves it for you to use later with other functions. If you do not provide a template name, the template is kept in storage until the end of the current function. You can still use other Template Workbench commands to work with the template, but it is not automatically saved. However, if, at any time before the end of the current function, you decide to save the template you can specify a template name and save it using the SAVE command.

CM

The CM command is used to create a new template by copying an existing template.

You must provide the data set name or PDS member name of the existing template. If you provide the name of a data set or PDS member in which the new template is to be saved, File Manager

saves it for you to use later with other functions. If you do not provide a template name, the template is kept in storage until the end of the current function. You can still use other Template Workbench commands to work with the template, but it is not saved for later use. If, at any time before the end of the current function, you decide to save the template you can specify a template name and save it using the SAVE command.

EM

The EM command is used to edit field mapping specifications in an existing template.

Field mapping allows you to change the layout of records when copying from one data set to another. The template you edit can be either a permanent one previously saved in a data set or PDS member, or a temporary one created for the current function. You can create a temporary template by using the CC command. (You can also create a temporary template by using either the GE, or the GM command, but you should only use these commands if you want File Manager to perform automatic mapping of fields with corresponding names.) Alternatively, you can let File Manager automatically create one for you. To do this, specify the member name of a COBOL copybook, but do not specify a template data set name or member name. Then, when you issue the EM command, File Manager automatically creates a temporary template.

When you edit field mapping in a template, a series of panels is displayed on which you can specify the following information:

- For a file containing multiple record types, which record types you want to map.
- Which fields in the “From” data set record descriptions map to which fields in the “To” data set record descriptions.

GE

The GE command is used to automatically generate field mapping specifications using the GM command, and then invoke the EM command so you can review and, if necessary, modify the mapping. See the descriptions of these commands for details of how the mapping is done.

GM

The GM command is used to automatically generate field mapping specifications in an existing template.

Field mapping allows you to change the layout of records when copying from one data set to another and to specify which fields are included when comparing data sets. The template can be either a permanent one previously saved in a data set or PDS member, or a temporary one created for the current function.

You can create a temporary template by using the CC command. Alternatively, you can let File Manager automatically create one for you. To do this, specify the member name of a COBOL copybook, but do not specify a template data set name or member name. Then, when you issue the GM command, File Manager automatically creates a temporary template.

When you issue the GM command, File Manager automatically maps record types and fields in the "From" template to record types and fields in the "To" template, as follows:

- Record types (COBOL level-01 data items) are firstly paired by name. Each record type in the "From" template is paired with a record type with the same name in the "To" template, if one exists.
- Once all record types with matching names have been paired, any unpaired record types are paired by position in the template. For example, if the first record type in the "From" template is unpaired, and the first record type in the "To" template is unpaired, the two record types are paired. Checking then continues with the second record type in each template, and so on. Pairing stops when there are no more record types in either the "From" or "To" template.
- Once record types have been paired, fields in the paired record types are mapped using much the same rules as the COBOL MOVE CORRESPONDING statement. A field in a "From" record type is mapped to a field in a "To" record type if both fields have the same name and, in the case of a field that is an elementary field in a group field, the respective group fields have the same names.

RC

The RC command is used to run the current function using a temporary template created from a copybook.

The temporary template cannot be edited before the function is run, and is not saved. Use the CC command if you want to edit or save the template.

You must specify the PDS member name of the copybook you want to use, and the data set name or PDS member name of the template you want to update. The copybook you specify is validated by compiling it. For a description of this process, and information about what you can do if errors occur, see the description of the CC command.

This command is only available when the Template Workbench is displayed by invoking one of the supported File Manager copy functions in advance-function mode. The command is not available when the Template Workbench is displayed using the AF function or a File Manager function other than a copy function.

RT

The RT command is used to run the current function with an existing template.

The template can be either a permanent one previously saved in a data set or PDS member, or a temporary one created for the current function using the CC command.

This command is only available when the Template Workbench is displayed by invoking one of the supported File Manager copy functions in advance-function mode. The command is not

available when the Template Workbench is displayed using the AF function or a File Manager function other than a copy function.

U

The U command is used to update an existing template from a copybook.

You should use this function when you have made minor changes to the copybook, and you want these changes reflected in the template you previously created from the copybook. If you have made significant changes to the copybook, the update process might not produce the results you expect, so you should instead use the CC command to recreate the template.

Minor changes that the update process supports include:

- Changing field names without changing field data types
- Changing field data types without changing field names
- Changing the order of fields in a record
- Deleting unreferenced fields
- Inserting new fields
- Changing record length
- Changing the number of occurrences of fields in an array (table)

Major changes that might cause the update process to produce unwanted results include:

- Changing field names and field data types
- Changing field names and the order of fields in a record

You must specify the PDS member name of the copybook you want to use, and the data set name or PDS member name of the template you want to update. The copybook you specify is validated by compiling it. For a description of this process, and information about what you can do if errors occur, see the description of the CC command.

To Copybook

The name (data set and member) of the copybook that contains the record descriptions for the “To” data set.

To Template

The name (data set and, if required, member) of an existing template you want to run with or edit, or a new template you want to create. This template contains the record descriptions and field mappings for the “To” data set.

Model Template

The name (data set and, if required, member) of an existing template you want to use as a model for creating a new template.

Parent panels

Child panels

Related tasks and examples

Member Selection panel

The Member Selection panel provides a list of PDS or PDSE members, from which you can select members to be included in your current process.

This panel is displayed when you have specified a PDS or PDSE on an Entry panel and either left the Member field blank or entered a member name pattern. It is also displayed for directory lists produced by CA-Panvalet and other library management systems.

Panel and field definitions

Figure 274. Member Selection panel

Process	Options	Help							
File Manager		Edit Member Selection		Row 00004 of 00416					
DSNAME	CARLAND.FMN.ADCU	Name	Prompt	Alias-of	Lib	Size	Created	Changed	→
	*	*	*	*	*		*	*	
_____	ABCDEF					41	2010/08/02	2010/08/02 11:01:01	
_____	ABEND0C7								
_____	ACTFX								
_____	ACTFXS								
_____	ACTFXSC								
_____	ACTFXU								
_____	ACTFXUC								
_____	ALIAS								
_____	AMASPZAP					10	2010/08/02	2010/08/02 10:59:08	
_____	AMBLIST					10	2003/04/01	2009/12/23 16:55:59	
_____	APARDEF								
_____	ASMADOP					17	2003/01/22	2003/01/22 14:23:01	
_____	ASMCOPPO					31	2001/07/06	2002/10/21 16:03:26	
_____	ASMDASM					13	2002/04/04	2004/04/13 14:56:23	
_____	ASMDECK					17	1999/06/24	2006/01/12 14:39:18	
Command ==>								Scroll PAGE	
F1=Help	F2=Split	F3=Exit	F4=CRetriev	F5=RFind	F7=Backward				
F8=Forward	F9=Swap	F10=Left	F11=Right	F12=Cancel					

The fields displayed vary depending on the directory list being displayed. There are four types of display:

- PDSs with formatted records
- PDSs with unformatted records (such as loadlibs)
- CA-Panvalet directory lists
- Other library management system library directory lists

The common fields displayed (for all displays) are described below, followed by the specific fields for each type. Other library management system library directory lists are determined by the customer-provided interface and are not listed here.

(Prefix area)

Area in which you can enter one of the following prefix commands:

Browse

Browse the member.

Copy

Copy the member and any related aliases.

Delete

Delete the member and any related aliases.

For data sets that support member generations, the following additional options are displayed in a confirmation panel:

1. Delete the member and all generations.
2. Delete the member and recover the most recent generation to become the current member.

Edit

For member lists restricted to showing only templates, IMS™ views, or extract criteria, the corresponding template, view, or criteria edit is invoked. For all other member lists, it edits the member. View is substituted for members managed by other library systems.

G

Synonym for the RESET prefix command.

History

Display history information for data sets with member generations. Where the command is entered for an alias, the generations are displayed for the primary member.

This command is available only for version 2 PDSEs with MAXGENS greater than zero.

Jcl

Generate the link-edit JCL for the load module. This command is only active for loadlib member lists.

Move

Move the member and any related aliases.

Print

Invoke the File Manager Print utility to print the member.

REName

Rename the member.

For PDSEs that support generations, all member generations will also be renamed.

RESet

Invoke the File Manager Reset ISPF Statistics function to reset or delete the ISPF statistics for the member.

Select /

Select a member. Depending on the function from which this panel has been invoked, results in one of these actions:

- A single member being selected and returned to the calling routine. (Note: subsequent selections are ignored)
- Toggling of the selected value in the prompt field.
- Selection of a member to be processed by the function that invoked the member list.



Note: This command is not valid when the panel is displayed as the result of the MEMBER prefix command.

SUbit

Submits the member to the JES internal reader.

Update

This command is only active for member lists restricted to showing base templates only and invokes the source definition edit/update process for a selected template.

View

View the member if the member is not a load module. If the member is a load module, the load module CSECT information is displayed.

Name

The name of the member.

Prompt

A dynamic area that displays the last action that occurred for the listed member.

Alias-of

Displayed for PDS directories and shows the alias names. If a broken alias is encountered, "*no-alias*" is displayed.

Lib

The relative number of the library (as listed on the Library List panel). This column only appears if more than one library directory has been processed.

ID

The User ID of the person who last created or changed the member.

For data sets with formatted records, the following fields are displayed for members stored with ISPF statistics, otherwise they are left blank:

Size

The current number of statements in the member.

Created

The date the member was created, in YYYY/MM/DD format.

Changed

The date and time, in YYYY/MM/DD HH:mm:SS format, on which the member was last changed.

ID

The User ID of the person who last created or changed the member.

INIT

The initial number of records in the member.

MOD

The current number of records in the member

VV.MM

The version and modification level of the member.



Note: Modifying the current member will update the ISPF statistics (if they are saved) for the current member but will not affect the ISPF statistics on the member generations.

For data sets with unformatted records, the following fields are displayed:

Size

The hexadecimal value for the load module size.

AC

Authorization code.

AM

AMODE binder value.

RM

RMODE binder value.

Attributes

Attribute values determined by binder:

RF

The module is refreshable.

RN

The module is reenterable.

RU

The module is reusable.

OV

The module has overlay structures.

NX

The module is not executable.

OL

The module is loadable.

SC

The module is scatter format.

TS

The module has test attribute.

TTR

The TTR of the first block of text.

For PDSEs the TTR field is a token that simulates the track and record location of the member, also known as Member Locator Token (MLT).

EPA

Entry point address associated with the member name or alias name.

SSI

SSI information word.

Columns for CA-Panvalet members:

Lvl

The member level.

Stat

The member status (such as T-TEST, P-PROD and so on).

User

User code.

Accessed

Last access date.

Changed

Last changed date.

Size

Number of statements.

Blks

Number of blocks.



Note: Some utilities (within ISPF, z/OS®, or third-party products) do not update the statistics kept for the Size, Created, Changed, and ID fields. If one of these utilities has recently changed the member, those fields are blank.

Example**Available commands**

The following primary commands are available:

- [BOTTOM primary command on page 1122](#)
- [DOWN primary command on page 1146](#)
- [FIND/FX primary command on page 1157](#)
- [HEX primary command on page 1172](#)
- [HISTORY primary command on page 1174](#)
- [LEFT primary command on page 1178](#)
- [LOCATE primary command on page 1182](#)
- [REFRESH primary command on page 1205](#)
- [RESET primary command on page 1208](#)
- [RFIND primary command on page 1211](#)
- [RIGHT primary command on page 1212](#)
- [SORT primary command on page 1224](#)
- [TAILOR primary command on page 1230](#)
- [TOP primary command on page 1232](#)
- [UP primary command on page 1234](#)

Parent panels

- [Browse Entry panel on page 751](#)
- [Edit Entry panel on page 862](#)
- [Data Create Utility panel on page 824](#)
- [Copy From panel on page 789](#)
- [Copy To panel on page 796](#)
- [Print Utility panel on page 977](#)
- [Find/Change Utility panel on page 901](#)

- [AFP Print Browse panel on page 730](#)
- [Load Module Information panel on page 927](#)
- [Compare Utility: "Old" and "New" panels on page 764](#)
- [Template Workbench panel on page 1072](#)
- [Template Build Utility panel on page 1056](#)

Child panels

- The display panel that would normally result from your starting Entry panel.

Related tasks and examples

- [Specifying a data set and a member name on page 42](#)
- [Selecting a range of PDS\(E\) members on page 70](#)
- [Manipulating your view of selection lists on page 62](#)

Memory Browse panel

The Memory Browse panel displays your user storage in dump format.

Panel and field definitions

Figure 275. Memory Browse panel

Process	Options	Help	
File Manager		Memory Browse	
Browse address	00000000_		Search limit *_____
Location	Offset	-----Hex-----	
00000000	0	040C0000	81342410 00000000 00000000
00000010	10	00FCD208	00000000 070C2000 8138692A
00000020	20	078D2000	80CDF22E 040CE000 80FEEE6E
00000030	30	078D1000	9854146C 070E0000 00000000
00000040	40	00000000	00000000 00000000 00FCD208
00000050	50	00000000	00000000 040C0000 8132FEA8
00000060	60	040C0000	80FFA080 00080000 9F56E888
00000070	70	00080000	9F56F948 040C0000 81331700
00000080	80	00000000	00001005 00020078 00040016
00000090	90	7F7DD001	00000000 00000000 00000000
000000A0	A0	00000000	0133E308 00000000 00000000
000000B0	B0	00000000	00000000 000102FD 0232B3A8
000000C0	C0	28000000	00000000 00000000 00000000
			-----Char-----
			...a.....
			.K.....a...
		2...\....>
			...q.%.....
		K.
		a..y
		Yh
		9....a...
		
			"}.....
		T.....
		y
		
Command ==>	-----		Scroll PAGE_
F1=Help	F2=Split	F3=Exit	F4=CRetriev F5=RFind F7=Up
F8=Down	F9=Swap	F10=Previous	F11=Next F12=Cancel

Browse address

Starting address of the data you want to browse.

Search limit

Limits the search to a specified number of bytes. You enter a hexadecimal number or * (the default). By default the entire storage is scanned, in pieces of 64KB each.

Location

Shows the hexadecimal location of the bytes displayed.

Offset

Shows the offset of the 16 bytes displayed relative to the selected address for Location.

Hex

Displays the hexadecimal representation of the storage data.

Char

Displays the storage data in character format.

The following primary commands are available on this panel:

- BACK - this command is unique to the Memory Browse panel.
- CLIPBOARD - this command is unique to the Memory Browse panel.
- FIND - see [FIND/FX primary command on page 1157](#)
- NEXTPAGE - this command is unique to the Memory Browse panel.

The BACK primary command restores the previous browse address. It returns you to offset zero of the current browse address or, if the offset is zero, it restores the browse address saved in the previous position of the pointer chain.

The CLIPBOARD primary command displays the data currently saved on the clipboard using the PUT command in an Edit session (see [Copying data to and from a clipboard on page 167](#)).

The length of the clipboard data is stored beginning with offset X'C'; the data itself is stored beginning with offset X'10'.



Note: The CLIPBOARD primary command only displays data saved on the clipboard if Memory Browse is invoked from an Edit session (during which you have saved data to the clipboard using the PUT command).

The NEXT primary command sets a new browse address and saves the current browse address. Either place the cursor onto a pointer value visible on the screen, or enter the new address into the **Browse address** field, then enter `NEXT` (or use a corresponding function key). To go forward to a previously saved address, check that your cursor is not on a data field, then enter `NEXT` (or use a corresponding function key). File Manager saves up to 64 browse addresses in a chain.

Use the scroll commands to move the display window over the user storage. For details, see [Scrolling to see data on page 117](#).

Parent panels

Child panels

Related tasks and examples

Non-VSAM Allocate panel

This panel is used to define a catalog entry for a non-VSAM file type. It allocates the data set as it creates the catalog definition.

Panel and field definitions

Figure 276.

<u>P</u> rocess	<u>O</u> ptions	<u>H</u> elp
File Manager		
Non-VSAM Allocate		
Non-VSAM Data Set:		
Data set name . . .	'USERID.TESTCATS.DATA2'	More: +
Specify volume serial, SMS class names, or leave blank for defaults:		
Device type . . .	_____	generic unit or device address
Volume serial . . .	_____	
Data class . . .	_____	leave blank for default
Storage class . . .	_____	leave blank for default
Management class	_____	leave blank for default
Space Requirements:		
Space unit . . .	<u>CYL</u>	BLKS, TRKS, CYLS, KB, or MB
Primary units . . .	<u>1</u>	quantity of above units
Secondary units . . .	<u>5</u>	quantity of above units
Directory blocks	<u>0</u>	leave blank for SMS default
Record format . . .	<u>VB</u>	if new format: U,F,V, or D, with B,S,A,M
Record length . . .	<u>8000</u>	
Block size . . .	<u>27998</u>	physical output block size
Data set type . . .	<u>LIBRARY</u>	LIBRARY, PDS, BASIC, EXTR, EXTP or LARGE
Data set version	-	for data set name type
Max. generations	_____	maximum member generations for PDS/E V2
Allocate EAS . . .	<u>OPT</u>	blank, NO or OPT
Release unused . . .	<u>NO</u>	enter YES to free unused space, else NO
Expiration date . . .	_____	yyyy.ddd, blank for default
Command ==>		
F1=Help	F2=Split	F3=Exit
F9=Swap	F10=Actions	F12=Cancel
	F4=CRetriev	F7=Backward
		F8=Forward

The fields in this panel are identical to those in the [Allocate \(Two\) panel on page 739](#).

Parent panels

- [Catalog Services panel on page 756](#)
- [Catalog Services Data Set List panel on page 759](#)

Child panels

- [Catalog Services panel on page 756](#)
- [Catalog Services Data Set List panel on page 759](#)

Related tasks and examples

- [Defining a new Catalog Entry on page 426](#)

Non-VSAM Association Information panel

Panel and field definitions

Figure 277. Non-VSAM Association Information panel

Process	Options	Help
File Manager		Non-VSAM Association Information
NONVSAM Catalog Entry:		
Data set name	'SYATES.UNITTEST.RFM0189.NVSAM1'	
Catalog ID	'CATALOG.UCATAPC'	
		More:
NONVSAM Associations:		
Alias	'SYATES.UNITTEST.RFM0189.NVSAM1.ALIAS1'	
Alias	'SYATES.UNITTEST.RFM0189.NVSAM1.ALIAS2'	
Alias	'SYATES.UNITTEST.RFM0189.NVSAM1.ALIAS3'	
Alias	'SYATES.UNITTEST.RFM0189.NVSAM1.ALIAS4'	
Alias	'SYATES.UNITTEST.RFM0189.NVSAM1.ALIAS5'	
Alias	'SYATES.UNITTEST.RFM0189.NVSAM1.ALIAS6'	
	**** End of data ****	
Command ==>		
F1=Help	F2=Split	F3=Exit
F8=Down	F9=Swap	F10=Actions
		F4=CRetriev
		F6=Info
		F7=Up
		F12=Cancel

Parent panels

Child panels

Related tasks and examples

Non-VSAM Define panel

This panel is used to define a catalog entry for a non-VSAM file type. It does not allocate the data set.

Panel and field definitions

Figure 278. Non-VSAM Define panel

Process	Options	Help
File Manager Non-VSAM Define		
NONVSAM Catalog Entry:		
Data set name . . .	'USERID.TESTCATS.DATA2'	
Catalog ID	'CATALOG.SYSPLEXD.USER'	
NONVSAM Data Allocation:		
Expiration date .	(NONE)	
Volume serial(s) .	D\$US23	
Device type(s) . .	3390	
Command ==>		
F1=Help	F2=Split	F3=Exit
F9=Swap	F10=Actions	F12=Cancel
	F4=CRetriev	F7=Up
		F8=Down

Data set name

The name of the catalog entry, from one to 44 characters. For DEFINE and ALTER commands, enter the new name.

Catalog ID

Name of a catalog that contains the entry. Default: System catalog search order.

Expiration date

Expiration date in the form YY.DDD or YYYY.DDD, where (YY)YY denotes the year and DDD denotes the number of the day from 1 to 366.

Leave it blank if an expiration date is not desired.

Volume serial(s)

Serial number of a DASD or tape volume to contain the non-VSAM data set.

Device type(s)

Specifies the device type of one or more volumes containing the data set. Enter an IBM® device type or a generic device name that is supported by your system.

Parent panels

- [Catalog Services panel on page 756](#)
- [Catalog Services Data Set List panel on page 759](#)

Child panels

- [Catalog Services panel on page 756](#)
- [Catalog Services Data Set List panel on page 759](#)

Related tasks and examples

- [Defining a new Catalog Entry on page 426](#)

Non-VSAM Entry Detail panel

When you invoke the alter, define, or information service or line command for a non-VSAM catalog entry, detailed catalog information is displayed for the selected entry. For most fields you can view a description of the field by placing the cursor on the field and pressing F1 (Help).

Panel and field definitions

Figure 279.

<u>P</u> rocess	<u>O</u> ptions	<u>H</u> elp
File Manager		
Non-VSAM Entry Detail		
Catalog Entry:		
Data set name . . .	'SYATES.COMPARE'	
Catalog ID	'CATALOG.USER3.SYSPLEXD'	
Additional information available with Extents(F11) and ASSocs(F6) commands.		
General Data:		
SMS managed	Y	Current Allocations:
Management class . . .	PRIMARY	Allocated tracks . . .
Storage class	PRIMARY	Allocated extents . .
Volume serial	D\$US24	Maximum dir blocks .
Device type	3390	
Data class	**None**	Current Utilization:
Organization	PO	KB used
Record format	FB	Tracks used
Record length	80	% Utilized
Block size	27920	Number of members .
1st extent trks . . .	5	
Secondary trks . . .	19	
Data set name type	PDS	
Last backup date . . .	0000.000.0000	
Creation date	2002/02/27 (058)	
Expiration date . . .	***None***	
Referenced date . . .	2005/09/09 (252)	
Change indicator . . .	YES	
Extended Attributes:		
Data attributes	Extended . . N	Compressed N
	Striped . . N	Stripe count . . . -
Associations:		
GDG base		
Alias		
Command ==>		
F1=Help	F2=Split	F3=Exit
F7=Up	F8=Down	F9=Swap
	F4=CRetrieval	F5=Volumes
	F10=Actions	F6=Assocs
	F11=Extents	F12=Cancel

Parent panels

Child panels

Related tasks and examples

- [Non-VSAM Extent Information panel on page 958](#)

Non-VSAM Extent Information panel

The Non-VSAM Extent Information panel displays the extents of a disk data set.

To display the Non-VSAM Extent Information panel, enter the EX line command on the Data Set List panel.

To locate specific data, use the LOCATE primary command.

Panel and field definitions

Figure 280.

<u>Process</u>	<u>Options</u>	<u>Help</u>
File Manager	Non-VSAM Extent Information	Line 1 of 430
Data set name: GREGCZ.X1KVSM06.FILLE1		
Total volumes: 10 Extents: 430 Tracks: 430		
	Begin - ABSOLUTE - End	Begin - RELATIVE - End
Ext Trks	Cyl-hd Rn...n Cyl-hd Rn...n	Cyl-hd Rn.....n Cyl-hd Rn.....n
VOLSER: D\$ST04(1) Extents: 43 Tracks: 43 -----		
1	1 550 4 8254 550 4 8254	0 0 1 0 0 1
2	1 550 6 8256 550 6 8256	0 1 2 0 1 2
3	1 550 7 8257 550 7 8257	0 2 3 0 2 3
...		
43	1 553 2 8297 553 2 8297	2 12 43 2 12 43
VOLSER: D\$ST01(2) Extents: 43 Tracks: 43 -----		
44	1 550 6 8256 550 6 8256	2 13 44 2 13 44
45	1 550 8 8258 550 8 8258	2 14 45 2 14 45
46	1 550 9 8259 550 9 8259	3 0 46 3 0 46
...		
387	1 552 2 8282 552 2 8282	25 11 387 25 11 387
VOLSER: D\$ST05(10) Extents: 43 Tracks: 43 -----		
388	1 900 5 13505 900 5 13505	25 12 388 25 12 388
389	1 900 7 13507 900 7 13507	25 13 389 25 13 389
390	1 900 8 13508 900 8 13508	25 14 390 25 14 390
...		
428	1 903 1 13546 903 1 13546	28 7 428 28 7 428
429	1 903 2 13547 903 2 13547	28 8 429 28 8 429
430	1 903 3 13548 903 3 13548	28 9 430 28 9 430
***** End of data *****		
Command ==>		Scroll <u>CSR</u>
F1=Help	F2=Split F3=Exit	F4=CRetriev F7=Backward F8=Forward
F9=Swap	F10=Actions F12=Cancel	

Parent panels

- [Catalog Services Data Set List panel on page 759](#)

Child panels

Related tasks and examples

OAM Functions panel

Panel and field definitions

Figure 281. OAM Functions panel

<u>P</u> rocess	<u>O</u> ptions	<u>H</u> elp
File Manager		OAM Functions
1 Directory		Display or print object directory
2 Browse		Browse object
3 Print		Print object
4 Update		Update object
5 Erase		Erase object
6 Copy		Copy object
Command ==>		
F1=Help	F2=Split	F3=Exit
F9=Swap	F10=Actions	F12=Cancel
	F4=CRetrieve	F7=Backward
		F8=Forward

Parent panels

[Primary Option Menu panel on page 970](#)

Child panels

- "Object Directory List panel"
- "Object Browse panel"
- "Object Print panel"
- "Object Update panel"
- "Object Erase panel"
- "Object Copy Functions panel"

Related tasks and examples

- [OAM Functions on page 490](#)

Path Entry Detail panel

Panel and field definitions

Figure 282. Path Entry Detail panel

Process	Options	Help
File Manager	Path Entry Detail	
PATH Catalog Entry:		
Data set name	. . 'SYATES.UNITTEST.RFM0189.ESDS3.PATH1'	
Catalog ID 'CATALOG.UCATAPC'	
PATH Associations:		
Creation date	. . 2003.351	Expiration date. . (NONE)
AIX :		
Data component	.	
Index component	.	
Cluster 'SYATES.UNITTEST.RFM0189.ESDS3'		
Data component	. 'SYATES.UNITTEST.RFM0189.ESDS3.DATA'	
Index component	.	
Command ==>		
F1=Help	F2=Split	F3=Exit
F9=Swap	F10=Actions	F12=Cancel
F4=CRetrieval	F7=Backward	F8=Forward

Parent panels

Child panels

Related tasks and examples

PDSE Workbench Entry panel

The PDSE Workbench Entry panel provides the initial input fields to specify the list of members for PDSE Workbench.



Note: When PDSE Workbench is invoked from the PWB function with at least one parameter, the PDSE Workbench Entry panel is bypassed and the PDSE Workbench Member List panel is displayed.

Panel and field definitions

Figure 283. PDSE Workbench Entry Panel

Process	Options	Help
File Manager	PDSE Workbench Entry Panel	
Data set name	. 'FMN.PH11137.PDSEV2F'	
Member *	Generation limit

Data set name

Specify a fully qualified or generic data set name of either a PDS or PDSE.

- Specify a generic data set name to select a data set from the selection list for processing by the PDSE Workbench.
- Leave the data set name blank to select from the history of up to 50 of the previous data sets used by the PDSE Workbench.

Member name

Specify a member name or member name pattern to display in the member list. Leave blank to display all members.

Generation limit

Defines the maximum number of generations to be displayed for each member. Specify a value in the range 0 to 2000000000 or leave the field blank to indicate no limit. This field is ignored for data sets that do not support member generations.

Parent panels

- [Utility Functions menu panel on page 1077](#)
- [Utility Functions menu panel from ISPF 3.4 on page 1079](#)

Child panels

- [PDSE Workbench Member List panel on page 961](#)

Related tasks and examples

- [Specifying a data set and a member name on page 42](#)

PDSE Workbench Member List panel

The PDSE Workbench panel displays a list of members for a PDS or PDSE. For PDSE data sets defined to support member generations, the member list can include member generations.

The first area of the panel displays the input fields, such as the data set name and member pattern. The remainder of the panel is a table of matching members, with columns that are appropriate to whether the members are formatted or unformatted.

You can use the HIDE primary command to toggle the display of the input fields. Hiding the input fields maximizes the size of the member list.

Panel and field definitions

Figure 284. PDSE Workbench Member List panel

Process Options Help									
File Manager					PDSE Workbench Member List				
Data set name . 'FMN.PH11137.PDSEV2F'									
Member *					Generation limit _____				
Compare option <u>1</u> 1. ISPF 2. SuperC 3. File Manager									
Name	Prompt	Rel	Gen	Size	Created	Changed	ID		
*	*				*	*	*	*	*
MEM1		0	0	2	2019/02/15	2019/02/15	09:43:05	HGRAMPA	
MEM1		-1	3	3	2019/02/15	2019/02/15	09:24:38	HGRAMPA	
MEM1		-2	2	2	2019/02/15	2019/02/15	09:22:09	HGRAMPA	
MEM1		-3	1	1	2019/02/15	2019/02/15	09:21:13	HGRAMPA	
MEM2TST		0	0	2	2019/02/15	2019/02/15	09:26:09	HGRAMPA	
MEM3TEST		0	0	1	2019/02/15	2019/02/15	09:27:49	HGRAMPA	
MEM3TEST		-1	2	1	2019/02/15	2019/02/15	09:27:49	HGRAMPA	
MEM3TEST		-2	1	1	2019/02/15	2019/02/15	09:27:49	HGRAMPA	
MEM4		-1	5	1	2019/02/15	2019/02/15	09:31:30	HGRAMPA	
MEM4		-2	4						

Input fields

Data set name

Specify a fully qualified or generic data set name of either a PDS or PDSE.

- Specify a generic data set name to select a data set from the selection list for processing by the PDSE Workbench.
- Leave the data set name blank to select from the history of up to 50 of the previous data sets used by the PDSE Workbench.

Member name

Specify a member name or member name pattern to display in the member list. Leave blank to display all members.

Generation limit

Defines the maximum number of generations to be displayed for each member. Specify a value in the range 0 to 2000000000 or leave the field blank to indicate no limit. This field is ignored for data sets that do not support member generations.

Compare option

Specify the compare utility to be used with a compare prefix command (CC, CN, CP, or CS):

1. ISPF Edit compare, using the ISPF VIEW service. This is the default option.
2. SuperC compare.
3. File Manager Compare function (DSM).



Notes:



1. For the ISPF and SuperC compare utilities, where member generations are selected, the member generations will be copied to a temporary data set to perform the comparison.
2. To compare unformatted records such as Program Objects, where the compare option specifies ISPF Edit compare, the File Manager Compare function (DSM) will be used.

Column descriptions

(prefix area)

You can enter commands in the prefix area before each row in the member list. For details of the supported commands, see [Prefix commands on page 643](#).

Name

The name of the member.

Where generation information is displayed:

- Current members (generation 0) are highlighted in white.
- Member generations are blue.
- Orphaned member generations (without a generation 0) are red.

Where alias information is displayed:

- Primary members are highlighted in white.
- Aliases are blue.

Prompt

A dynamic area that displays the last action that occurred for the listed member.

For PDSEs that are defined to support member generations and have a non-zero generation limit, the following fields are displayed:

Rel

This is the relative generation number of the member generation. The relative generation is either 0 or a negative number. The current member always has a relative generation = 0, with the most recent generation created having a relative generation of -1, then -2, and so on. The maximum number of generations is defined by the MAXGENS parameter when the PDSE version 2 data set is created.

Gen

This is the absolute generation number of the member generation. The absolute generation is either 0 or a positive number. The current member always has an absolute generation = 0. The absolute generation number is 1 for the first generation and incremented by 1 for each new generation.



Note: When displaying generation information, aliases are not shown in the member list.

For all other data sets and for PDSEs that are defined to support member generations and have a non-zero generation limit, the following fields are displayed:

Alias-of

For an alias this field displays the primary member name.

For data sets with formatted records, the following fields are displayed for members stored with ISPF statistics, otherwise they are left blank:

Size

The current number of statements in the member.

Created

The date the member was created, in YYYY/MM/DD format.

Changed

The date and time, in YYYY/MM/DD HH:mm:SS format, on which the member was last changed.

ID

The User ID of the person who last created or changed the member.

INIT

The initial number of records in the member.

MOD

The current number of records in the member

VV.MM

The version and modification level of the member.



Note: Modifying the current member will update the ISPF statistics (if saved) for the current member but will not affect the ISPF statistics on the member generations.

For data sets with unformatted records, the following fields are displayed:

Size

The hexadecimal value for the load module size.

AC

Authorization code.

AM

AMODE binder value.

RM

RMODE binder value.

Attributes

Attribute values determined by binder:

RF

The module is refreshable.

RN

The module is reenterable.

RU

The module is reusable.

OV

The module has overlay structures.

NX

The module is not executable.

OL

The module is loadable.

SC

The module is scatter format.

TS

The module has test attribute.

TTR

The TTR of the first block of text.

For PDSEs the TTR field is a token that simulates the track and record location of the member, also known as Member Locator Token (MLT).

EPA

Entry point address associated with the member name or alias name.

SSI

SSI information word.

Available commands

The following primary commands are available:

- [BOTTOM primary command on page 1122](#)
- [DELETE \(records\) primary command on page 1144](#)

- [DOWN primary command on page 1146](#)
- [FIND/FX primary command on page 1157](#)
- [HEX primary command on page 1172](#)
- [HIDE primary command on page 1173](#)
- [LEFT primary command on page 1178](#)
- [LOCATE primary command on page 1182](#)
- [REFRESH primary command on page 1205](#)
- [RESET primary command on page 1208](#)
- [RFIND primary command on page 1211](#)
- [RIGHT primary command on page 1212](#)
- [SORT primary command on page 1224](#)
- [TAILOR primary command on page 1230](#)
- [TOP primary command on page 1232](#)
- [UP primary command on page 1234](#)

Parent panels

- [Utility Functions menu panel on page 1077](#)
- [Utility Functions menu panel from ISPF 3.4 on page 1079](#)

Child panels

Related tasks and examples

- [Specifying a data set and a member name on page 42](#)
- [Selecting a range of PDS\(E\) members on page 70](#)
- [Manipulating your view of selection lists on page 62](#)

Personal Data Set List panel

The Personal Data Set List panel displays the contents of a data set list. You can edit the list by typing in new details, by overtyping the existing information, or by entering the E line command to display the Edit Personal Data Set List panel which provides more edit options.

You can display an alternative form of this panel with the LISTVIEW primary command that shows a third line for each entry where you can view or enter a description for the entry.

Panel and field definitions

Figure 285. Personal Data Set List panel

```

  Process  Options  Help
  _____
File Manager                Personal Data Set List

Enter a list action or select a data set entry to retrieve
Action: S=Save A=Save As D=Delete this list E=Extended Edit N=New list
Action Name Description Created Referenced
- ① JLLIST1 ② ③05/07/18 ④05/07/22 12:35
More: +
Select Partitioned, Sequential, VSAM Data Set, or HFS file Member Volume
/ Copybook or Template
. 'FMNUSER.DATA' ⑤ DATA1 ⑥ ⑦
'FMN.V14R1M20.SFMNSAM1' ⑧ FMNCCPY ⑨
. 'FMNUSER.DATA' DATA5
'FMN.V14R1M20.SFMNSAM1'
. 'FMNUSER.DATA' DATA4
'FMN.V14R1M20.SFMNSAM1' FMNCCPY
.
.
Command ==>
F1=Help F2=Split F3=Exit F4=Expand F7=Backward F8=Forward
F9=Swap F10=Actions F12=Cancel

```

①

Line command entry field. Valid values are:

S

Save. Saves any changes made to the personal data set list.

A

Save As. Saves current list entries to a new list.

D

Delete. Deletes the list.

E

Extended Edit. Invokes the personal data set list edit dialog.

N

New. Create a new list.

②

Name of this data set list

③

Date this data set list originally created

④

Date and time this data set list referenced

⑤

Data set name

6

Member name

7

Volume serial number

8

Data set name of copybook or template

9

Member name of copybook or template

Example

Available commands

The following primary commands are available on this panel:

- LISTVIEW

Parent panels

- [Personal Data Set Lists panel on page 968](#)

Child panels

- [Edit Personal Data Set List panel on page 865](#)

Equivalent functions

- None.

Related tasks and examples

- [Working with data set lists on page 320](#)

Personal Data Set Lists panel

The Personal Data Set Lists panel displays a list of all your data set lists, including the reference list, REFLIST, which is maintained by File Manager.

Panel and field definitions

Figure 286. Personal Data Set Lists panel

Process	Options	Help			
File Manager	Personal Data Set Lists	Row 1 to 3 of 3			
Active: JLLIST1					
Action: O=Open A=Save As D=Delete E=Edit N=New list					
Name	Description	Created	Referenced		
REFLIST	Last 30 referenced data sets	-----	-----		
JLLIST1		05/07/18	05/07/22 09:24		
JLLIST2		05/07/21	05/07/21 16:43		
***** Bottom of data *****					
Command ==>					
F1=Help	F2=Split	F3=Exit	F4=CRetriev	F7=Backward	F8=Forward
F9=Swap	F10=Actions	F12=Cancel			

Command entry field

Line command entry field. Valid values are:

O

Open. Opens the data set list.

A

Save As. Displays a save confirmation panel where you can enter the name you want to call the data set list and, optionally, a list description.

D

Delete. Deletes the data set list.

E

Edit. Displays the Edit Personal Data Set List panel.

N

New. Displays a new Personal Data Set List panel with empty entries.

Name

Name of the data set list

Description

Description of the data set list.

Created

Date this data set list originally created

Referenced

Date and time this data set list referenced

Child panels

- [Personal Data Set Lists panel on page 968](#)

Equivalent functions

- None.

Related tasks and examples

- [Working with data set lists on page 320](#)

Primary Option Menu panel

The Primary Option Menu panel is the starting point for all File Manager operations.

Panel and field definitions

Figure 287. File Manager Primary Option Menu panel

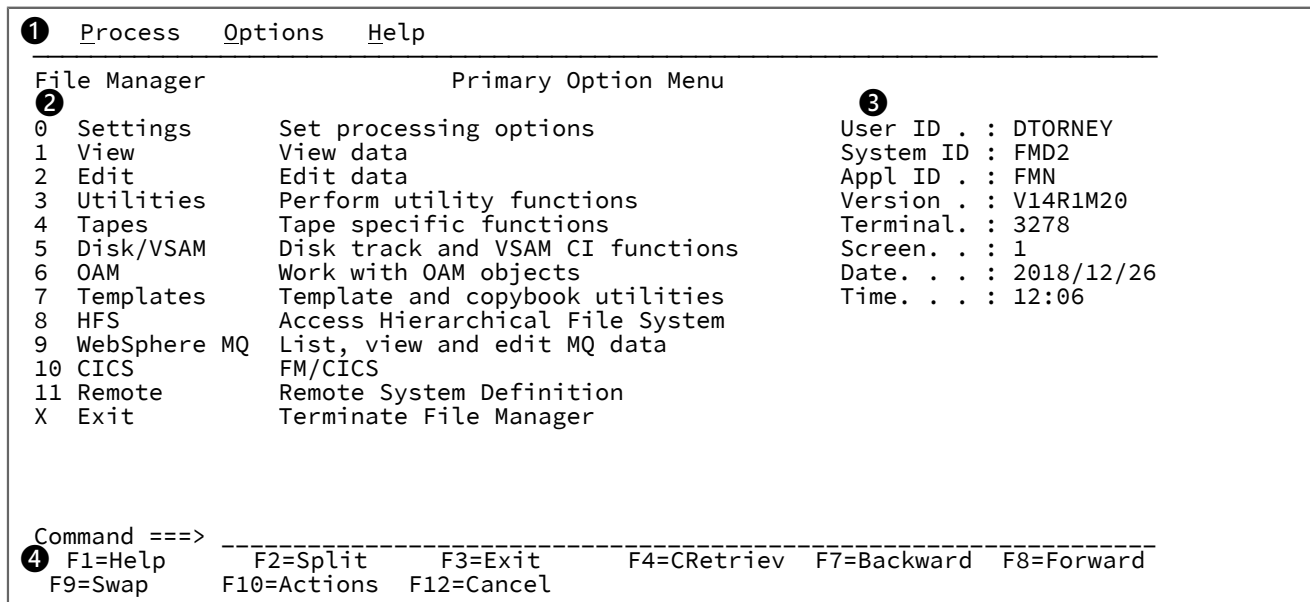

or

Panel and field definitions

Figure 288. File Manager Primary Option Menu when invoked via the FMNR line command from an ISPF 3.4 data set list

```

  Process  Options  Help
-----
File Manager                Primary Option Menu

0 Settings      Set processing options      User ID . . : DTORNEY
1 View          View data                   System ID  : FMD2
2 Edit          Edit data                   Appl ID   : FMN
3 Utilities     Perform utility functions   Version . . : V14R1M20
X Exit          Terminate File Manager      Terminal. : 3278
                                           Screen. . : 1
                                           Date. . . : 2019/01/28
                                           Time. . . : 12:32

Command ==> -----
④ F1=Help      F2=Split   F3=Exit    F4=CRetriev F7=Backward F8=Forward
  F9=Swap      F10=Actions F12=Cancel

```

① Action Bar

The Action Bar contains a number of pull-down menus. These menus are available throughout File Manager.

Process

The Process pull-down menu lists the processes available on your current panel. These options may change, depending upon which panel is being viewed.

```

  Process  Options  Help
-----
_ 1. Exit File Manager  Primary Option Menu
0 Settings      Set processing options
:

```

Options

The Options pull-down menu lists the choices available from the Set Processing Options panel, as well as providing access to the ISPF Settings panel.

Process	Options	Help
File Man		
0 Setti	1. Print settings	
1 View	2. System settings	
2 Edit	3. Tape processing options	
3 Utili	4. Job card specifications	
4 Tapes	5. Compiler language selection	
5 Disk/	6. COBOL compiler specifications	
6 OAM	7. PL/I compiler specifications	
2006/08/03	8. Edit/Browse options	
7 Templ	9. VSAM Edit sharing options	
8 HFS	10. ISPF settings	
9 WebSphere MQ	List, view and edit MQ data	
10 CICS	FM/CICS	
11 Remote	Remote System Definition	
X Exit	Terminate File Manager	
Command ==>		
F1=Help	F2=Split	F3=Exit
F8=Forward	F9=Swap	F10=Actions
		F4=CRetriev
		F7=Backward
		F12=Cancel

User ID . . : FMNUSER
System ID : FMD2
Appl ID . . : FMN
Version . . : 7.1.0
Terminal . . : 3278
Screen . . . : 1
Date :
Time : 11:18

See [Compare Utility: Options panel on page 773](#) for details about options 1 to 8. See the *ISPF User's Guide Volume 1* for details about the ISPF Settings panel.

Help

The Help pull-down menu lists the various ways in which you can enter the Tutorial Help system, as well as providing access to more File Manager information.

Process	Options	Help
File Manager		
0 Settings	S	1. Help for help...
1 View	B	2. Extended help...
2 Edit	E	3. Keys help...
3 Utilities	P	4. Help index...
4 Tapes	T	5. Tutorial...
5 Disk/VSAM	D	6. About...
6 OAM	W	7. News about File Manager...
:		

1. Help for help

Displays the Help panel for the Tutorial Help system.

2. Extended help

Displays the Tutorial Help panel associated with the current File Manager panel (equivalent to pressing F1 from the File Manager panel). When on the Primary Options menu, this is the Tutorial Help Table of Contents panel.

3. Keys help

Displays a panel that provides help for the Function Keys that are active on the current File Manager panel.

4. Help index

Displays the Help Index.

5. Tutorial

Displays the Tutorial Help Table of Contents panel.

6. About

Displays the File Manager version and release information in a pop-up window.

7. News about File Manager

Displays a panels providing general information about the current File Manager version/release.

② Primary Options

Lists the Primary Options available within File Manager. Selecting an option displays an Entry panel or a Menu panel for the associated function.

③ Status Area

Displays your session information.

④ Function Keys

Lists the Function Keys that are active within the current panel.

Parent panels

ISPF Primary Options Menu - see "Chapter 1. Primary Options Menu" in the *ISPF User's Guide Volume I*.

Child panels

- [Set Processing Options panel on page 1029](#)
- [Browse Entry panel on page 751](#)
- [Edit Entry panel on page 862](#)
- [Utility Functions menu panel on page 1077](#)
- [Tape Specific Functions panel on page 1047](#)
- [Disk/VSAM Data Functions panel on page 836](#)
- [OAM Functions panel on page 959](#)
- [Copybook and Template Utility functions panel on page 809](#)
- [Access Hierarchical File System panel on page 725](#)
- [WebSphere MQ Functions panel on page 1108](#)
- "Primary Option Menu panels" in the *File Manager User's Guide and Reference for CICS*

Equivalent functions

- None.

Related tasks and examples

[Starting and exiting File Manager on page 36](#)

Print Audit Trail panel

Panel and field definitions

Figure 289. The Print Audit Trail panel

```

Process  Options  Utilities  Help
-----
File Manager                Print Audit Trail

Audit Trail:
Data set name . . . -----
Description . . . -----

Processing Options:
Enter "/" to select option          Formatted display options
- Formatted print                    2 1. Hex Format
- Print only changed fields          2 2. Non-display Hex
- Keep data set after printing      / Highlight changes
- Browse report                     / Show key fields
- Batch execution

Command ==> -----
F1=Help      F2=Split      F3=Exit      F4=CRetriev  F7=Backward  F8=Forward
F9=Swap      F10=Actions  F12=Cancel
    
```

Formatted print

Displays report entries in formatted character representation, rather than hexadecimal format.

Print only changed fields

Limits the amount of printed lines.

Keep data set after printing

Whether to keep or delete the data set after it is printed.

Browse report

The audit trail report is displayed immediately.



Note: The contents of the audit trail report are transferred to a SYSOUT class as specified by the **PRINTOUT** print option on the Set Print Processing Options panel. (For details about setting this option, see [Setting your Print Processing Options on page 403](#).) To browse the audit trail report, set the **PRINTOUT** print option to SYSOUT=c.

Batch execution

To generate JCL for printing the audit trail report using a batch job. For command syntax, see [AUD \(Print audit trail report\) on page 1245](#).

Hex Format

To produce an UPDOWN hexadecimal display below the standard field display.

Non-display Hex

To produce an UPDOWN hexadecimal display below the standard field display only for fields that contain non-displayable \ characters.

Highlight changes

Highlight the changed fields. An asterisk is placed to left of the before data to indicate the field has been changed.

Show key fields

To display key fields even when **Print only changed fields** is selected. A "K" is printed to the left of key field names. For a KSDS data set, a key field is any elementary field that intersects or is contained in the key area.

Parent panels**Child panels****Related tasks and examples****Print Options panel****Panel and field definitions**

Figure 290. Print options panel

```

Process  Options  Help
-----
File Manager                Print Options
Press ENTER to proceed.
Formatted print options:
  / Field reference number      / Field type and length values
  / Picture clause              / Start location
  / Structure                   / Left justify numeric fields
  / Redefined fields            / Print record length

Other print options:
  / Ignore record length mismatch

Command ==> _____
F1=Help      F2=Split    F3=Exit     F4=Resize
F5=Ex-help   F6=Keyshelp F7=PrvPage  F8=NxtPage

```

Formatted print options:**Field reference number (REF)**

Changes the session default to show the field reference (for example, #2) next to each field, in SNGL display or print format. In an editor session, this display can also be turned on or off temporarily, by using the REFS command.

Field type and length values (TYPE)

Changes the session default to show the field data type and length next to each field, in SNGL display or print format. In an editor session, this display can also be turned on or off temporarily, by using the TYPE command.

Picture clause (PIC)

Changes the session default to show the Picture clause when in SNGL display or print mode. Also shows the length and scale (if non zero) for binary and packed fields and the bit length for bit fields. In an editor session, this display can also be turned on or off temporarily, by using the PIC command.

Start location (SLOC)

Changes the session default to show the start location of each field, when in SNGL display or print mode. In an editor session, this display can also be turned on or off temporarily, by using the SLOC command.

Structure (STR)

Changes the session default to show the full structure of the template when using SNGL display or print mode. In an editor session, this display can also be turned on or off temporarily, by using the STR command.

Left justify numeric fields (JUST)

Changes the session default to show numeric fields as left justified, when using SNGL display or print mode. In an editor session, this display can also be turned on or off temporarily, by using the JUST command.

Redefined fields (RDF)

Changes the session default to show the redefined information as part of the field name, when in SNGL display or print mode and display or print the redefined fields when in SNGL or TABL display or print mode. In an editor session, this display can also be turned on or off temporarily, by using the RDF command.

Print record length

Turns on or off the display of record lengths in TABL and SNGL formats. In an editor session, this display can also be turned on or off temporarily, by using the RECLLEN command.

Ignore record length mismatch

Records failing the selection process because of length mismatch with template layouts) are considered selected for processing if they meet other selection criteria.

Parent panels

- [Print Utility panel on page 977](#)

Child panels

Related tasks and examples

Print Utility panel

The Print Utility lets you print sequential, partitioned data set members, VSAM files, or HFS files in a selected format.

Panel and field definitions

Figure 291. Print Utility panel

Process	Options	Help
File Manager		
Print Utility		
Input Partitioned, Sequential or VSAM Data Set, or HFS file:		
Data set/path name . . .	'FMNUSER.EXPORT'	+
Member	* _____	(Blank or pattern for member list)
Volume serial	_____	(If not cataloged)
Start key	_____	key or slot
Skip count	_____	Include _____ Repeat skip _____
Print count	ALL _____	number of records to be printed
Copybook or Template:		
Data set name	_____	
Member	_____	(Blank or pattern for member list)
Processing Options:		
Print Option	Copybook/template/access	Enter "/" to select option
<u>1</u> 1. Char	<u>3</u> 1. Above	- Edit template _ Type (1,2,S)
2. Hex	2. Previous	- Batch execution
3. Sngl	3. None	/ Use proc _____
4. Tabl	4. Physical Blk/CI Access	- REXX member selection: <u>p</u>
ISPF Packing	5. Create dynamic	- Advanced member selection
<u>1</u> 1. Unpack	MQ Processing	- Additional print options
2. None	- Include Descriptors	- Binary mode, reclen _____
3. Skip		
Command ==>>>		
F1=Help	F2=Split	F3=Exit
F9=Swap	F10=Actions	F12=Cancel
F4=Expand	F7=Backward	F8=Forward

Data set/path name

Can be a fully-qualified data set name or a pattern, an HFS file or directory, a WebSphere® MQ queue name, or a CICS® resource.

For information about specifying a WebSphere® MQ queue name, see [Specifying an MQ manager or queue on page 48](#).

For information about specifying a CICS® resource, see [Specifying a CICS resource on page 48](#).

The data set name may include a member name or name pattern in parenthesis. If the member is specified here, the associated **Member** field must be empty.

When you specify an HFS file or directory, you must enter a full path name. If the path name is longer than the displayed entry field, press the Expand function key (F4) to display a pop-up window in which you can enter a longer name.

Member

If you specified the name of a partitioned data set (PDS) without including a member name or name pattern in parenthesis in the **Data set name** field, then you can use this field to specify the member name or a member name pattern.

Volume

Specify a volume serial number if the data set is not cataloged.

Start key

The starting key or slot location for a VSAM file

Skip count

The number of records to be skipped before processing begins

Include

Represents the number of physical records that to be included in a repeating sample from a data set. Both **Include** and **Repeat Skip** fields must have non-zero values for sampling to take effect.

Range: 0-9999999. Default: 0.

Repeat skip

Represents the number of physical records to be skipped in a repeating sample from a data set. Both **Include** and **Repeat Skip** fields must have non-zero values for sampling to take effect.

Range: 0-9999999. Default: 0.

Print count

The number of records to be printed

Copybook or Template: Data set name and Member

These fields identify either a copybook or a template to be used to select records and format the print output. If a copybook is specified, it is compiled to create a temporary template that can optionally be saved if edit was requested.

Print Option

The format of the printed output:

CHAR

Records are printed in character format.

HEX

Records are printed in hexadecimal format. The DUMP processing option on the Set Processing Options panel determines how HEX data is printed. See [Set Processing Options panel on page 1029](#).

SNGL

Single record format (one field on each line of the display). The left-hand side of the printout contains the field or header names. The right-hand side contains the field values formatted according to the field type. A template is required for this option.

In this print format, additional field information (redefined fields, field reference number, field type and length values, picture clause, start location, structure) can be printed depending on the editor options. Numeric fields can be left-justified depending on the options.

TABL

Tabular format (fields printed across the display). The records are displayed in columns with field or heading names as column headers and the data formatted according to the field types. In this format, the display might be truncated depending on the current print width. A template is required for this option.

Copybook/template/access

Use this option to specify if you want to use a template, or how records are to be printed.

Above

File Manager uses the template specified on the panel. (If you specified a copybook, then File Manager compiles the copybook into a template before use.)

Previous

File Manager uses the last template you used to process this data set. If you have not previously used a template for this data set, a message is displayed and processing continues without using a template.

None

File Manager does not use a template. SNGL and TABL print formats are not available.

Physical Blk/CI Access

Records are printed by physical block (non-VSAM) or by control interval (VSAM).

Create dynamic

File Manager creates a dynamic template. You can now define fields and field creation attributes.

MQ processing**Include Descriptors**

If this is selected (with the / character), the message descriptor data returned by the GET MQ API is added as a prefix to the record data, allowing this data to be examined in conjunction with the message data.

Otherwise only the message data is available for processing.

Edit template

File Manager opens the template you have specified for editing, before processing the panel.



Note: For details about using templates, see [Creating and editing templates on page 173](#).

Type (1,2,S)

The type of editing you want to perform.

You can specify one of the following values:

1

Edit the Record Identification Criteria by field first

2

Edit the Record Selection Criteria by field first

S

Edit the source definition for a template using the advanced copybook selection facility.

This option is ignored when editing a dynamic template.

Batch execution

File Manager generates JCL to run the function in batch and then displays the JCL for editing. Use Set Batch Job Card Information (option 0.4) to tailor the default JOB card that File Manager uses to generate the JCL. See [Set batch job card information \(option 0.4\) on page 82](#).

Use proc

Use this option to specify a procedure to search and change the data, rather than using the Find and Change commands. When you select the option, you can perform either of these actions

- Choose to create a temporary procedure for one-time use by entering a single asterisk (*). File Manager displays an Edit panel, in which you can create the procedure.
- Specify the name of the member containing the procedure you want to use, The member must belong to the PDS allocated to ddname FMNEXEC. You can enter any of the following:
 - The name of the member.
 - A member name pattern (other than a single *) to list all matching members. You can then select the required member by entering an **s** in the **Sel** field. A member name pattern can consist of any characters that are valid in a member name and the following two special pattern characters:

asterisk (*)

Represents any number of characters. As many asterisks as required can appear anywhere in a member name. For example, if you enter ***d***, a list of all members in the data set whose name contains "d" is displayed.

percent sign (%)

A place-holding character representing a single character. As many percent symbols as necessary can appear anywhere in a member name. For example, if you enter %%%%, a list of all members in the data set whose name is four characters in length is displayed.



Note: If you select this option but leave the **Use proc** member entry field blank, File Manager displays a member name list. You can then select the required member by entering `s` in the **Sel** field.

(Also, see [Supplying a procedure when using a File Manager panel on page 530.](#))

REXX member selection

Enter `/` to use a REXX procedure to determine if a member should be copied.

If this option is selected, the **Use Proc** option must also be selected and a REXX procedure supplied. You can optionally specify the default action to be applied in the event that the nominated procedure fails to determine if a member in the input data set should be copied. The default action is determined by entering a `P` (PROCESS MEMBER) or `D` (DROP MEMBER) in the adjacent field. If no default is provided, `P` is assumed.

Advanced member selection

Enter `/` to specify a range of members to be selected rather than a specific or generic member name.

ISPF Packing

Provided that the data set is a sequential, PDS or PDSE file and an I/O exit routine is not used, one of these options can be used to control the print behavior when processing data that is in ISPF PACK format.

1. Unpack

If the data set is packed, it is unpacked before printing.

2. None

No checking or processing of ISPF packed data occurs. Packed records are processed and printed in packed format. This option is forced if an I/O exit has been used.

3. Skip

If the input data is packed, no processing or printing occurs.

Additional print options

Displays the Print Options panel allowing you to specify additional print options.

Binary mode

When processing an HFS file, allows you to specify binary mode (selected) or text mode (unselected).

reclen

When processing an HFS file and the **Binary mode** option is selected, records are derived based on the fixed record length specified. The default is 80.

Can be in the range: 1–32760

Child panels

- [Print Options panel on page 975](#)
- [Personal Data Set List panel on page 966](#) (Current@ Data Set List option selected from the Process drop-down menu, or REFL fastpath command entered).
- [Personal Data Set Lists panel on page 968](#) (Personal Data Set Lists option selected from the Process drop-down menu, or REFD fastpath command entered).

Equivalent functions

Related tasks and examples

- [Selecting a range of PDS\(E\) members on page 70](#)

Record Identification Criteria panel

The Record Identification Criteria panel is used to set record identification criteria in copybook templates, using the "by field" method (see [Selecting records with templates on page 284](#)).

Panel and field definitions

Figure 292. Record Identification Criteria panel

```

Process  Options  Help
-----
File Manager          Record Identification Criteria          Line 1 of 7
Cmd Con ( Field Name                               Op Value                                     )
  <-> - <----+-----1-----+-----2-----+-----3-----> <-> <----+-----1-----+-----2-----+-----
*** **** Top of data ****
____ AND  _ REC-TYPE01
____ AND  _ REC-TYPE
____ AND  _ NAME
____ AND  _ EMPLOYEE-NO
____ AND  _ AGE
____ AND  _ SALARY
____ AND  _ FILLER
*** **** End of data ****

Command ==>> _____ Scroll PAGE
F1=Help      F2=Split    F3=Exit     F4=CRetriev F5=RFind    F6=RunTemp
F7=Up        F8=Down     F9=Swap     F10=Left    F11=Right   F12=Cancel
    
```

Cmd

Prefix command area - used to enter a template editor prefix command.

Con

Connectors - used to specify the AND/OR connectors. These are only relevant to lines containing record selection expressions. The default value is **AND**. You can overtype the connectors with any of the following values:

Value entered**Resultant value****AND**

AND

&

AND

OR

OR

|

OR



Note: Abbreviations are accepted. For example, if you overtype `AND` with `O`, it is changed to `OR`.

(

Left Parenthesis - Parentheses must only be used on lines containing expressions. They are used to group record selection criteria. The number of left parentheses must match the number of right parentheses.

Field Name

A non-editable field that displays the field names defined in the original copybook.

Use the STR primary command to toggle the displaying of the structure (level information) in the **Field Name** area of the display. The current setting is remembered for future sessions.



Note: If you are running a screen width of 115 or greater, the Field Name field can be displayed at the same time as the Start, Length, and Type fields. However, at any width less than this, you need to toggle the display between Field Name and Start, Length and Type. The default display is Field Name. To toggle the display, ensure that your cursor is not in a Value field and press the Right function key (F10) or Left function key (F11).

Start

A non-editable field that displays the starting location of the fields, as defined in the original copybook.

Length

A non-editable field that displays the length of the fields, as defined in the original copybook.

Type

A non-editable field that displays the data type of the fields, as defined in the original copybook.

Op

Operator - used to create record identification expressions. Valid operators are:

=, EQ

True if the terms are equal (numerically or when padded)

\=, \=, /=, NE

True if the terms are not equal (inverse of =)

>, GT

Greater than

<, LT

Less than

><, <>

Greater than or less than (same as not equal)

>=, GE

Greater than or equal to

\<, \<

Not less than

<=, LE

Less than or equal to

\>, \>

Not greater than

==

True if terms are strictly equal (identical)

\==, \==, /==

True if the terms are NOT strictly equal (inverse of ==)

>>

Strictly greater than

<<

Strictly less than

>>=

Strictly greater than or equal to

\<<, \<<

Strictly NOT less than

<<=

Strictly less than or equal to

ACO

Contains all of the values specified. Matching case sensitive. The negative form is XCO.

ACU

Contains all of the values specified. Matching not case sensitive. The negative form is XCU.

CO

Contains one of the values specified. The negative form is -CO.

CU

Contains one of the values specified. Matching not case sensitive. The negative form is -NC.

NC

Numeric contains - a number is one of the values. The negative form is -NC.

NN

(Same as -NU.) Field does not contain a valid numeric for the field type. The positive form is NU.

NR

Not in range - field < value1 or field > value2. The positive form is RG.

NU

Field contains a valid numeric for the field type:

Field type**Test for being valid numeric****BI, FE, FP, PD, and ZD**

Checked against the field definition

Other

Recognized as numeric if the display value or character value the field contains is a valid number. The valid number can contain anything that is valid for a floating-point external or decimal number. For example:

```
-1234.55
+3.4621E+10
```

The negative form is -NU.

RG

Range - value1 >= field <= value2. The negative form is NR.

XCO

Does not contain all of the values. Matching case sensitive. The positive form is ACO.

XCU

Does not contain all of the values specified. Matching case sensitive. The positive form is ACU.

-CO

Does not contain one of the values specified. The positive form is CO.

-CU

Does not contain any of the values specified. Matching not case sensitive. The positive form is CU.

-NC

Does not contain the specified number(s). The positive form is NC.

-NU

(Same as NN.) Field does not contain a valid numeric for the field type. The positive form is NU.

VER

Verify this field is composed only of characters specified in the **Value** column.

Value

Use this field to provide a character or numeric constant to be used for comparison in the expression. If the operator supports more than one value (for example, RG, CO) then use comma delimiters to provide separate values. When specifying values, the following rules apply:

Hexadecimal strings

A hexadecimal string must be in the form 'hhhhh'h'. The value enclosed in quotation marks must be an even number of characters and contain valid hexadecimal characters. (0123456789ABCDEF).

Binary strings

A binary string must be in the form 'nnnnn'b. The value enclosed in quotation marks must be a combination of 0 and 1s.

Numeric Operands

The values specified for a numeric field type must be a valid number. Quoted values are not accepted.

Character strings

For non-numeric types the value is automatically enclosed in quotation marks if you do not specify them. When specifying more than one value for operations other than RG and NR you must provide quotation marks for all the comma delimited values

Date strings

A date string must be in the form d'xxxxxxx'. The string must be specified in the output format defined for the field.

The following is an example of a date value:

```
d'Jan 01, 2014'
```

where the output format is:

```
Mmm DD, YYYY
```

Time strings

A time string must be in the form `t'xxxxxxx'`. The string must be specified in the output format defined for the field.

The following is an example of a time value:

```
t'15:30:00.000'
```

where the output format is:

```
HH:MI:SS.999
```



Note:

1. Date and time strings cannot be used with contains operators.
2. When used with range operators requiring two values the second value should be quoted, for example, `d'Jan 01, 2014', 'Dec 01, 2014'`
3. Use `d'='` or `t'='` to retrieve the current date or time value in the output format.

)

Right Parenthesis - Parentheses must only be used on lines containing expressions. They are used to group record identification criteria. The number of left parentheses must match the number of right parentheses.

Subscripts for dimensioned fields

For dimensioned fields you can optionally enter a subscript in the value area. The subscript must precede the actual value and must be enclosed in parentheses. You can enter one of the following:

(ANY)

This is the default if you do not enter a subscript and it indicates that at least one of the dimensioned fields must satisfy the criteria for the associated condition to be true.

(ALL)

This indicates that all of the dimensioned fields must satisfy the criteria for the associated condition to be true.

(nn)

Use this form to refer to a single element of the array that must satisfy the associated condition. You must enter a valid subscript for the field referenced.

Parent panels

- [Field Selection/Edit panel on page 891](#)

Related tasks and examples

- [Selecting records with templates on page 284](#)

Record Sampling panel

The Record Sampling panel is used to specify a *repeating sample* pattern that will limit the number of records presented in an editor session.

In a repeating sample:

1. The **Starting position** is set first, and always applies to the physical records, before any template processing is applied.
2. If a template is in use, the template selection criteria then filters the data set and the **Initial skip field** is used to determine the number of selected records to skip.
3. Records are then read from the data set and template processing (if a template is used) occurs on them. Records are included in the Edit session until the number of selected records (if not using a template, the number of physical records) matches the **Include selected records** field value.
4. After the above number of selected records have been included, the number of selected records in this field will then be skipped. (If not using a template this is physical records) They are not presented in any form in the editor session.
5. Steps 3 and 4 are then repeated until either the end of the data set, or the total number of selected records has been included as specified (in the Total selected record limit field) (if using a template), or the total number of physical records as specified has been read, or File Manager can contain no more records in virtual storage.

Panel and field definitions

Figure 293. Record Sampling panel, when no template is used

<u>P</u> rocess	<u>O</u> ptions	<u>H</u> elp
File Manager		Record Sampling
Positioning:		
Starting position	_____	
Start position type . . .	-	1. Key 2. RBA 3. Record number 4. Formatted key
Sampling:		
Include physical records	_____	
Skip physical records	_____	
Total physical record limit	_____	
Command ==>>>		
F1=Help	F2=Split	F3=Exit
F9=Swap	F10=Actions	F12=Cancel
	F4=CRetriev	F7=Backward
		F8=Forward

Starting position

This represents the physical record number to set the starting point of the editor session. The default is record 1, meaning the top of the data set. A value entered in the **Start position** field on the View Entry or Edit Entry panel, is carried through to this panel when it is opened.

Start position type

Determines how File Manager interprets the value provided in the **Starting position** field. If the **Start position type** is not specified, File Manager assumes that the value is a record number.



Note: The available selections below are changed so that only those valid for the selected file type appear.

1. KEY

Only valid when the data set is a VSAM KSDS, VSAM AIX®, or VSAM PATH.

2. RBA

Only valid when the data set is a VSAM KSDS, VSAM AIX®, or VSAM ESDS.

3. Record Number

Default. Valid for any type of supported data set.

4. Formatted key

Only valid when the data set is a VSAM KSDS, VSAM AIX®, or VSAM PATH and when a template is provided. This displays the formatted Key Positioning panel.



Note: For templates with more than one layout, a 01 selection list is displayed first.

Include physical records

This represents the number of physical records that is to be included in a repeating sample from the data set. When this field is used, both this field and the **Skip physical records** fields must have nonzero values.

Skip physical records

This represents the number of physical records that is to be skipped in a repeating sample from the data set. The **Include physical records** field must have a nonzero value for this field to have any meaning.

Total physical record limit

This represents the total number of physical records that will be read from the data set. If the **Include physical records** and **Skip physical records** fields are used, only the included records are counted in this total. The editor session will contain records from the data set up to the end of the data set, or the total number of physical records as specified in this field has been read, or File Manager can contain no more records in virtual storage, whichever occurs first.

Figure 294. Record Sampling panel, when a template is used

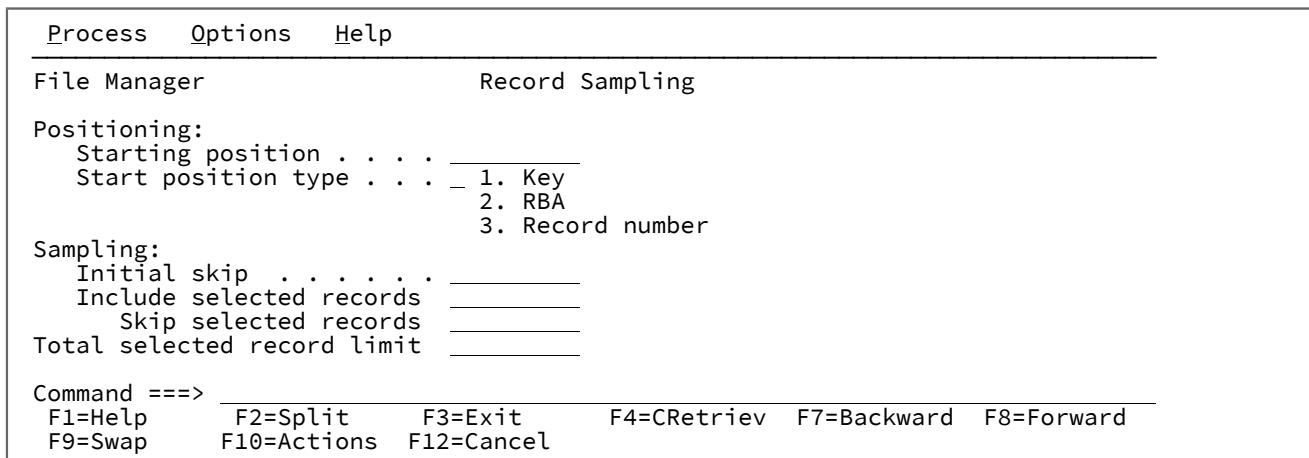

Initial skip

This field is only available when processing with a template. This represents the number of records regarded as selected by the template processing that will initially be skipped. These records are not presented in any form in the editor session.

Include selected records

This represents the number of selected records that are included in a repeating sample from the data set. When this field is used, both this field and the **Skip selected records** fields must have nonzero values.

Skip selected records

This represents the number of selected records that are skipped in a repeating sample from the data set. The **Include selected records** field must have a nonzero value for this field to have any meaning.

Parent panels

- [Browse Entry panel on page 751](#)
- [Edit Entry panel on page 862](#)
- [View panel on page 1083](#)

Child panels

- [Browse panel on page 746](#)
- [Editor panel on page 853](#)

Related tasks and examples

- [Starting and ending editor sessions on page 89](#)

Record Selection Criteria panel

The Record Selection Criteria panel is used to set record selection criteria in copybook templates, using the "by field" method (see [Selecting records with templates on page 284](#)).

Panel and field definitions

Figure 295. Record Selection Criteria panel

Process	Options	Help
File Manager	Record Selection Criteria	Line 1 of 6
Cmd	Con (Field Name
<->	-	<-----1-----2-----3----->
***	****	Top of data ****
		REC-TYPE01
___	AND	REC-TYPE
___	AND	NAME
___	AND	EMPLOYEE-NO
___	AND	AGE
___	AND	SALARY
___	AND	FILLER
***	****	End of data ****
Command	==>	
F1=Help	F2=Split	F3=Exit
F7=Up	F8=Down	F9=Swap
		F4=CRetriev
		F10=Left
		F5=RFind
		F11=Right
		F6=RunTemp
		F12=Cancel
		Scroll PAGE

Cmd

Prefix command area - used to enter a template editor prefix command.

Con

Connectors - used to specify the AND/OR connectors. These are only relevant to lines containing record selection expressions. The default value is **AND**. You can overtype the connectors with any of the following values:

Value entered

Resultant value

AND

AND

&

AND

OR

OR

|

OR



Note: Abbreviations are accepted. For example, if you overtype `AND` with `O`, it is changed to `OR`.

(

Left Parenthesis - Parentheses must only be used on lines containing expressions. They are used to group record selection criteria. The number of left parentheses must match the number of right parentheses.

Field Name

A non-editable field that displays the field names defined in the original copybook.

Use the STR primary command to toggle the displaying of the structure (level information) in the **Field Name** area of the display. The current setting is remembered for future sessions.



Note: If you are running a screen width of 115 or greater, the Field Name field can be displayed at the same time as the Start, Length and Type fields. However, at any width less than this, you need to toggle the display between Field Name and Start, Length and Type. The default display is Field Name. To toggle the display, ensure that your cursor is not in a Value field and press the Right function key (F10) or Left function key (F11).

Op

Operator - used to create record selection expressions. Valid operators are:

=, EQ

True if the terms are equal (numerically or when padded)

\=, !=, /=, NE

True if the terms are not equal (inverse of =)

>, GT

Greater than

<, LT

Less than

><, <>

Greater than or less than (same as not equal)

>=, GE

Greater than or equal to

\<, -<

Not less than

<=, LE

Less than or equal to

\>, ->

Not greater than

==

True if terms are strictly equal (identical)

\==, -==, /==

True if the terms are NOT strictly equal (inverse of ==)

>>

Strictly greater than

<<

Strictly less than

>>=

Strictly greater than or equal to

\<<, -<<

Strictly NOT less than

<<=

Strictly less than or equal to

ACO

Contains all of the values specified. Matching case sensitive. The negative form is XCO.

ACU

Contains all of the values specified. Matching not case sensitive. The negative form is XCU.

CO

Contains one of the values specified. The negative form is -CO.

CU

Contains one of the values specified. Matching not case sensitive. The negative form is -NC.

NC

Numeric contains - a number is one of the values. The negative form is -NC.

NN

(Same as -NU.) Field does not contain a valid numeric for the field type. The positive form is NU.

NR

Not in range - field < value1 or field > value2. The positive form is RG.

NU

Field contains a valid numeric for the field type:

Field type**Test for being valid numeric****BI, FE, FP, PD, and ZD**

Checked against the field definition

Other

Recognized as numeric if the display value or character value the field contains is a valid number. The valid number can contain anything that is valid for a floating-point external or decimal number. For example:

```
-1234.55
+3.4621E+10
```

The negative form is -NU.

RG

Range - value1 >= field <= value2. The negative form is NR.

XCO

Does not contain all of the values. Matching case sensitive. The positive form is ACO.

XCU

Does not contain all of the values specified. Matching case sensitive. The positive form is ACU.

-CO

Does not contain one of the values specified. The positive form is CO.

-CU

Does not contain any of the values specified. Matching not case sensitive. The positive form is CU.

-NC

Does not contain the specified number(s). The positive form is NC.

-NU

(Same as NN.) Field does not contain a valid numeric for the field type. The positive form is NU.

VER

Verify this field is composed only of characters specified in the **Value** column.

Value

Use this field to provide a character or numeric constant to be used for comparison in the expression. If the operator supports more than one value (for example, RG, CO) then use comma delimiters to provide separate values. When specifying values, the following rules apply:

Hexadecimal strings

A hexadecimal string must be in the form 'hhhhh'h'. The value enclosed in quotation marks must be an even number of characters and contain valid hexadecimal characters. (0123456789ABCDEF).

Binary strings

A binary string must be in the form 'nnnnn'b. The value enclosed in quotation marks must be a combination of 0 and 1s.

Numeric Operands

The value(s) specified for a numeric field type must be a valid number. Quoted values are not accepted.

Character strings

For non-numeric types the value is automatically enclosed in quotation marks if you do not specify them. When specifying more than one value for operations other than RG and NR you must provide quotation marks for all the comma delimited values.

Date strings

A date string must be in the form d'xxxxxxx'. The string must be specified in the output format defined for the field.

The following is an example of a date value:

```
d'Jan 01, 2014'
```

where the output format is:

```
Mmm DD, YYYY
```

Time strings

A time string must be in the form t'xxxxxxx'. The string must be specified in the output format defined for the field.

The following is an example of a time value:

```
t'15:30:00.000'
```

where the output format is:

```
HH:MI:SS.999
```

**Note:**



1. Date and time strings cannot be used with contains operators.
2. When used with range operators requiring two values the second value should be quoted, for example, `d'Jan 01, 2014', 'Dec 01, 2014'`
3. Use `d'='` or `t'='` to retrieve the current date or time value in the output format.

)

Right Parenthesis - Parentheses must only be used on lines containing expressions. They are used to group record selection criteria. The number of left parentheses must match the number of right parentheses.

Subscripts for dimensioned fields

For dimensioned fields you can optionally enter a subscript in the value area. The subscript must precede the actual value and must be enclosed in parentheses. You can enter one of the following:

(ANY)

This is the default if you do not enter a subscript and it indicates that at least one of the dimensioned fields must satisfy the criteria for the associated condition to be true.

(ALL)

This indicates that all of the dimensioned fields must satisfy the criteria for the associated condition to be true.

(nn)

Use this form to refer to a single element of the array that must satisfy the associated condition. You must enter a valid subscript for the field referenced.

Parent panels

- [Field Selection/Edit panel on page 891](#)

Related tasks and examples

- [Selecting records with templates on page 284](#)

Record Type Mapping panel

This panel is used to specify which record type, in a copybook or template that contains multiple records types, is to be mapped to the records in a "From" or "Old" template. It is displayed when "edit template" has been requested from the "To" panel of the Copy Utility, the "New" panel of the Compare Data Utility or the Map To panel of the Template Workbench, and the "To" or "New" template or copybook contains multiple record types.



Note: If called from the Compare Data Utility, the panel displays all labels with “New” instead of “To” and “Old” instead of “From”.

Panel and field definitions

Figure 296. The Record Type Mapping panel

<u>P</u> rocess	<u>O</u> ptions	<u>H</u> elp
File Manager	Record Type Mapping	Line 1 of 2
To	USERID.TEMPLATE(FMNCCPY2)	
From	USERID.TEMPLATE(COPYTST1)	
Cmd	To Field Name	Len
****	Top of data	****
	NEW-TYPE01	84
	NEW-TYPE02	100
****	End of data	****
	From Field Name	Len
	REC-TYPE01	80
Command ==>	----- Scroll PAGE	
F1=Help	F2=Split	F3=Exit
F7=Up	F8=Down	F9=Swap
	F4=CRetriev	F5=RFind
	F6=Describe	F12=Cancel

TO (or NEW) *template/copybook*

The name of the copybook or template that contains the record descriptions for the “To” or “New” data set.

FROM (or OLD) *template/copybook*

The name of the copybook or template that contains the record descriptions for the “From” or “Old” data set.

(To or New) Field name

Shows the field name and length of the level-01 fields in the “To” or “New” template.

(From or Old) Field name

Shows the field name and length of the level-01 fields in the “From” or “Old” template that have been mapped to the “To” or “New” level-01 fields.

Cmd

Prefix command area - used to enter a template editor prefix command. Enter **S** or **E** to edit the field mapping.

Parent panels

Child panels

Related tasks and examples

Record Type Selection panel

The Record Type Selection panel is used when creating or editing templates generated from copybooks that contain more than one record type, or one or more segment types. It is used to select a specific record type for editing or display. It is also used to specify that the record type definitions are to be applied to segmented data records.

Panel and field definitions

Figure 297. Record Type Selection panel

```

Process  Options  Help
-----
File Manager                Record Type Selection                Line 1 of 2
Processing Option: /  Template for segmented data
Cmd SIE Field Name                Prompt  CCSID:  Offset  Length
      **** Top of data  ****
  ___ SI  DEPT                                0      25
  ___ SI  EMPLOYEE                            0      30
      **** End of data  ****

Command ==>
F1=Help      F2=Split    F3=Exit     F4=CRetrie v  F5=RFind     F6=RunTemp
F7=Up        F8=Down     F9=Swap     F12=Cancel
    
```

Template for segmented data

If selected (by typing a "/"), the template can be used to access data sets containing segmented data. The template must contain Record Identification Criteria for each Record Type. Each segment in the data set is treated as a logical record within the function, using the Record Type definition.

Default setting is unselected.

CCSID

The CCSID to be associated with all alphanumeric fields in the template unless the field is in a record which has a CCSID associated with it. If this field is changed those alphanumeric fields in records which do not have an associated CCSID and have the same CCSID will have the CCSID associated with it changed.

Cmd

Prefix command area - used to enter a template editor prefix command. You can type prefix commands in multiple Cmd fields and then execute all the commands in one action, by pressing Enter. Line commands available on this panel are:

S

Toggles the selection of a segment layout for processing.

When a segment type is deselected, its field selection criteria are still used to determine whether all segments in the physical record are extracted.

E

Display the Field Selection/Edit panel, so that you can edit field selection and expression criteria.

SIE

Select/Identification/Expression column.

S

Indicates that the record type has been selected for processing.

I

Indicates that a record identification expression has been defined for the record type.

E

Indicates that a record selection expression has been defined for the record type.

Field name

Shows the field name of the record type (level-01 name).

Prompt

Indicates when the record type has been edited within the current session.

Offset

Displays the current offset for each record type. You can overwrite the value in this column to change the offset for each record type, or you can enter the OFFSET primary command to change the offset value for one or more record types.

Length

Shows the length of the record. If the record is variable length, this field shows the maximum record length.

Example**Available commands**

The following primary commands are available on this panel.

The primary commands that are available on this panel are:

- DESCRIBE primary command on page 1145
- FIND/FX primary command on page 1157
- RESET primary command on page 1208
- RUNTEMP primary command on page 1215
- SAVE primary command on page 1215
- SAVEAS primary command (templates) on page 1216
- SELECT primary command on page 1218
- LPRINT primary command on page 1232
- LZERO primary command on page 1190

Parent panels

Child panels

Related tasks and examples

Redefines / Range Specifications panel

File Manager displays the Redefines / Range Specifications panel when you enter the X line command in the prefix command field (**Cmd**) against a copybook on the Copybook Selection panel.

Panel and field definitions

Figure 298. Redefines / Range Specifications panel

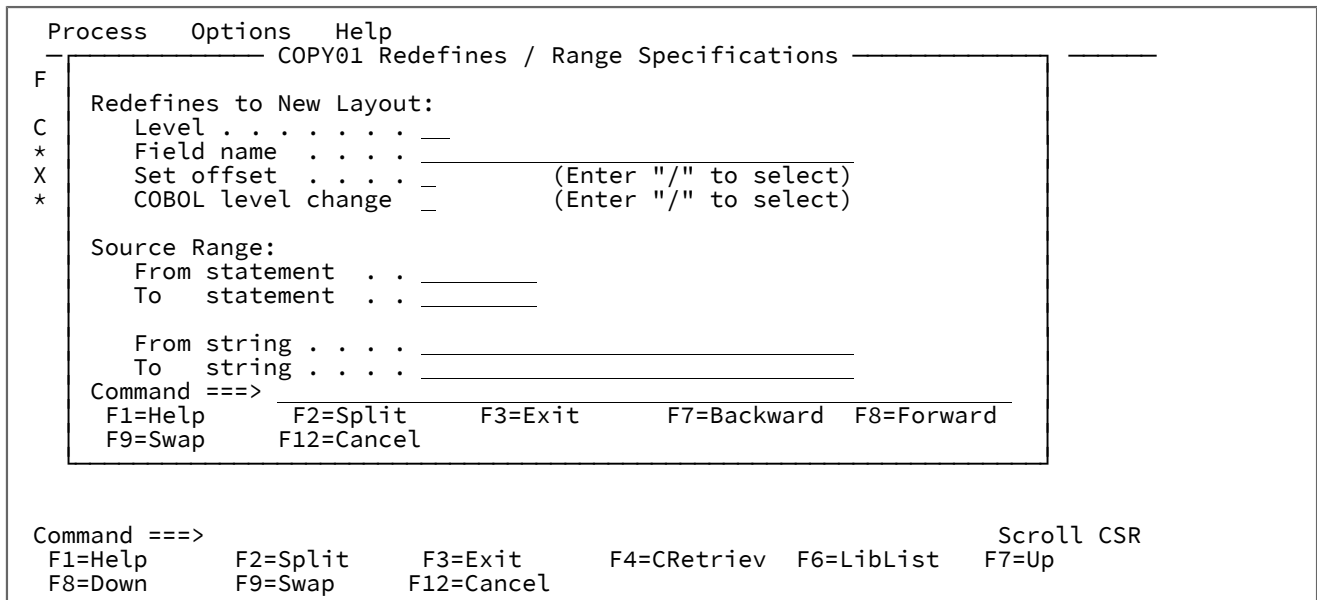

Redefines to New Layout

Use the following fields to direct File Manager to generate multiple record layouts for a source that contains many record definitions within one level-1 structure:

Level

Source level value used to identify REDEFINES or UNION-level clauses that are to generate new record layouts. This value is used when you have a structure that has defined multiple layouts using COBOL REDEFINES or PL/I unions. File Manager creates a separate record layout for each REDEFINES clause at the given level. After the first matching REDEFINES is found, File Manager creates new layouts for the latter and subsequent REDEFINES clauses for the same level and start location. Header and trailing data items are included in each record layout.

Field name

Specifies the target field name of a REDEFINES clause or the field name with a UNION clause that is used to identify the REDEFINES or UNION statements that are to be used to direct File Manager to create new layouts. This is an alternative way of identifying REDEFINES and UNION statements that require new layouts to be generated. If you specify both **Level** and **Field Name** values, File Manager checks both when generating new layouts.

Set offset

When selected (by typing a "/"), File Manager adjusts the offset value for each layout so that the starting location is the REDEFINES or UNION field start location. Use this option when your record layouts do not include the header data items in the structure. You can only specify this option in conjunction with the previous fields.

COBOL level change

When selected (by typing a "/"), it changes the way the level **Level** value (specified above) is processed. Every occurrence of the specified level value is changed to 01 before the compile step, regardless of whether the data item has a REDEFINES clause or not.

This is a COBOL only option and should be used with care as it can alter a structure from its intended programmable form.

Source Range

Specify the following fields to direct File Manager to extract a subset of the copybook to be compiled into the template:

From statement

Start source line number. This tells File Manager the starting statement for extract. If not specified, the default start location is statement 1.

To statement

End source line number. This tells File Manager the ending statement for extract. If not specified, the default end location is the last source statement.

From string

File Manager searches each source statement for the specified string and the first statement with a matching string starts the extract process. If you specify a "from statement", then the first

statement that matches either the **From statement** value or contains the **From string** value begins the extract.

To string

File Manager searches each source statement for the specified string and the first statement with a matching string ends the extract process. If you specify a "to statement", then the first statement that matches either the **To statement** value or contains the **To string** value ends the extract.

Parent panels

[Copybook Selection panel on page 810](#)

Child panels

Related tasks and examples

- [Advanced copybook selection on page 208](#)

Related ID expression panel

You use the Related ID expression panel to specify a related ID expression for a layout in a segmented template.

Panel and field definitions

Figure 299. Related ID expression panel

```

Process  Options  Help
-----
File Manager      Related Id expression for DETAIL-0101                Line 1 of 7
-----
----- Criteria - Enter 0 to specify related ID expression by field -----
0 Rid: #5='01'
Offset 0
Enter "/" to OR with related ID
Cmd Seq SHE Ref  Field Name      Picture  Type Start Length
-----
1 1 1 HEADER-01      AN       1      20
2 2 2 ALLGROUP      AN       1      20
3 3 3 TYPE-FIELD    AN       1       8
4 4 4 TYPECONST    X(6)    AN       1       6
5 5 4 TYPERC      X(2)    AN       7       2
6 6 3 HEADERTEXT    AN       9      12
7 7 4 HEAD01-TEXT  X(12)   AN       9      12
-----
**** End of data ****

Command ==>
F1=Help      F2=Split      F3=Exit      F4=Expand    F5=RFind     F6=RunTemp
F7=Up        F8=Down       F9=Swap      F10=Left     F11=Right    F12=Cancel
    
```

0 Rid

Used to specify the related ID expression.

Offset

Offset field - used to enter an offset value. An offset value is a negative or positive integer, between -32760 and +32760, that is added to the record length of the Level 01 field and to the starting position of all fields within the record type, shifting the layout left or right in relation to the records being processed. An offset value of 0 removes a previously supplied offset.

Enter "/" to OR with related ID

By default, identification criteria are ANDed with related ID criteria if both are specified. Select this option to OR the identification criteria with any specified related ID criteria.

Cmd

Prefix command area - used to enter a template editor prefix command.

Seq

Sequence field - used to order fields for display in File Manager editor sessions and printing data via the File Manager Print utility. The default display/print order is "selected fields in field reference order".

SHE

Select/Hold/Create field - shows the field status:

S

The field has been selected for processing.

H

The field has been selected to be held on the edit display.

E

The field has been previously edited to add information such as data create, field headings, and scrambling options.

Ref

Field reference - shows the field reference number assigned by File Manager to the field name. Field reference numbers are assigned to all fields in a record, and are used to identify fields in identification or selection criteria expressions.

Key

Key segment sequence. Shows the key segment sequence numbers used to define a multi-segment key field for data set comparison. The display of the Key column can be toggled on or off using the KEYFLDS command.

Field Name

Shows the level number and field name of the field, together with other attributes such as redefines, array sizes and depending on references. If the field is an array, the dimensions are shown in brackets after the field name. If the field has been selected for processing, the field name is highlighted.

Picture

Shows the picture clause for COBOL and for PL/I. Shows the length and scale (if non zero) for binary and packed fields. Also shows the bit length for bit fields.

Type

An editable field in which you can enter or edit the data type of a field. This must be one of:

AN

Alphanumeric

AX

Alphanumeric displayed in long hexadecimal.

BI

Binary

BT

Bit string

DB

DBCS string

DT

Data/Type

FE

Floating point (external)

FP

Floating point (internal)

G

Graphic string

PD

Packed decimal

VB

Varying bit

VC

Varying character

VD

Varying DBCS

VG

Varying graphic

Z2

Null-terminated varying-length(VARYINGZ) DBCS string

ZA

Unsupported zoned decimal edited

ZC

Varying character null terminated

ZD

Zoned decimal

ZE

Zoned decimal edited

ZG

Varying graphic null terminated

Start

Shows the start column of the field. For variable located fields the start location is based on the maximum length of the record.

Length

Shows the length of the field. For a level-01 field, if the record is variable length, the length shown is the maximum record length.

Example**Available commands**

The prefix commands that can be entered in the Cmd field are:

E

Displays the Field Attributes panel for this field. You can use the Field Attributes panel to specify the following:

- For a numeric field, whether you want leading zero suppression when the field is displayed on the screen or printed using the SNGL or TABL display or print formats.
- When you use the template to help generate test data, what data pattern File Manager should use for the field.

H

Set Hold status for a single field, if the field is already in Hold status the Hold status is removed.

In TABL display format, held fields always appear as the leftmost fields on the screen (in the order that you held them when editing the template). Held fields take priority, as far as the left-to-right display is concerned, over other fields.

In SNGL display format, held fields always appear as the topmost fields on the screen (in the order that you held them when editing the template). Held fields take priority, as far as the top-to-bottom display is concerned, over other fields.

Hn

Set Hold status for *n* fields, if any of the fields are already in Hold status, the Hold status is removed.

HH

Select a block of fields to have the Hold status set. If any of the fields are already in Hold status, the Hold status is removed. Use the HH prefix command to mark the start and end of the block of fields.

S

Select a single field for processing or, if the field is already selected for processing, deselect it. If you select multiple fields for processing using the S prefix command, the fields are displayed in the order they appear in the template.

Sn

Select *n* fields for processing or, if any of the fields are already selected for processing, deselect them.

S*

Select all fields from the current field to the end of the list for processing or, if any of the fields are already selected for processing, deselect them. If you want to exclude just a few fields, you can use S* to explicitly select all the fields in a fresh template, then use S to deselect the fields you want to exclude.

SS

Select a block of fields for processing or, if any of the fields are already selected for processing, deselect them. Use the SS prefix command to mark the start and end of the block of fields.

X

Toggle between a display type of AN (character) and AX (long hexadecimal). This command has no effect on non-alphanumeric fields.

Xn

Perform the X command against all fields from the current field for *n* fields.

X*

Perform the X command against all fields from the current field to the end of the list.

XX

Perform the X command against a block of fields. Use the XX prefix command to mark the start and end of the block of fields.

The primary commands that are available on this panel are:

- [DESCRIBE primary command on page 1145](#)
- [FIND/FX primary command on page 1157](#)
- [RESET primary command on page 1208](#)
- [RUNTEMP primary command on page 1215](#)
- [SAVE primary command on page 1215](#)
- [SAVEAS primary command \(templates\) on page 1216](#)
- [SELECT primary command on page 1218](#)
- [LPRINT primary command on page 1232](#)
- [LZERO primary command on page 1190](#)

Parent panels

- [RID Selection panel on page 1007](#)

Child panels

Related tasks and examples

- [Editing related ID criteria on page 233](#)

RID Selection panel

After you have selected a layout within a template for segmented data for which you want to specify related ID criteria, the RID Selection panel lists all the other level-01 layouts in the template. You then use the RID Selection panel to select a specific layout to use for specifying ID criteria.

Panel and field definitions

Figure 300. RID Selection panel

Process	Options	Help
File Manager	RID Selection for DETAIL-0101	Line 1 of 8
E against layouts to specify related id criteria		
Cmd	SIE	Field Name
		Prompt
		Offset
		Length
		**** Top of data ****
___	S	HEADER-01
___	S	HEADER-02
___	S	HEADER-03
___	S	DETAIL-0102
___	S	DETAIL-0103
___	S	DETAIL-0201
___	S	DETAIL-0202
___	S	DETAIL-0203
		**** End of data ****
Command ==>		
F1=Help	F2=Split	F3=Exit
F7=Up	F8=Down	F9=Swap
	F4=CRetriev	F5=RFind
	F12=Cancel	Scroll CSR
		F6=RunTemp

Cmd

Prefix command area - used to enter a template editor prefix command. You can type prefix commands in multiple Cmd fields and then execute all the commands in one action, by pressing Enter. Line commands available on this panel are:

S

Toggles the selection of a segment layout for processing.

When a segment type is deselected, its field selection criteria are still used to determine whether all segments in the physical record are extracted.

E

Display the Related ID expression panel, so that you can edit related ID expression criteria.

SIE

Select/Identification/Expression column.

S

Indicates that the layout has been selected for processing.

I

Indicates that the layout has an identification expression.

E

Indicates that the layout has a selection expression.

Field name

Shows the field name of the related ID (level-01 name).

Prompt

Indicates when the related ID has been edited within the current session.

Offset

Displays the current offset for each related ID. You can overtype the value in this column to change the offset for each related ID, or you can enter the OFFSET primary command to change the offset value for one or more related IDs.

Length

Shows the length of the related ID. If the related ID is variable length, this field shows the maximum length.

Example**Available commands**

The primary commands that are available on this panel are:

- [DESCRIBE primary command on page 1145](#)
- [FIND/FX primary command on page 1157](#)
- [RESET primary command on page 1208](#)
- [RUNTEMP primary command on page 1215](#)
- [SAVE primary command on page 1215](#)
- [SAVEAS primary command \(templates\) on page 1216](#)
- [SELECT primary command on page 1218](#)
- [LPRINT primary command on page 1232](#)
- [LZERO primary command on page 1190](#)

Parent panels

- [Field Selection/Edit panel on page 891](#)

Child panels

- [Related ID expression panel on page 1002](#)

Related tasks and examples

- [Editing related ID criteria on page 233](#)

Remote System Definition panel

This panel is used to modify or create a remote system definition which will be used to connect to a remote system.

Panel and field definitions

Figure 301. Remote System Definition panel

Process	Options	Help
File Manager		Remote System Definition
Name . . .	TESTLP3	
Description	Development LPAR	
Port . . .	2825	
Address . .	pthfmd1	+
User . . .	TESTER3	
Password .		
New Password .		
Command ==>		
F1=Help	F2=Split	F3=Exit
F9=Swap	F10=Left	F11=Right
	F4=Expand	F7=Backward
	F12=Cancel	F8=Forward

Name

This is a 1 to 8 character name that you will provide to be used to identify the remote system when specifying data set names within File Manager. The data set name will be in the form:

RM:Name:Data set name

Description

The description of the remote system.

Port

Port number which will be used to connect to remote system server.

Address

The host TCPIP address of the remote system.

User

The userID that will be used for the remote system logon.

Password

The password to be used for the remote system logon.

New Password

Optional - to set a new password for the remote system logon. If used, the existing password must also be set.

Remote System Definition List panel

This panel shows all your current remote system definitions. Standard scrolling applies and you can sort all of the columns. Use the help key to obtain a full description of all primary commands supported for navigation.

Panel and field definitions

Figure 302. Remote System Definition List panel

<u>P</u> rocess	<u>O</u> ptions	<u>H</u> elp
File Manager	Remote System Definition List	Row 00001 of 00002
<u>N</u> ame	<u>D</u> escription	<u>U</u> ser
_____	*_____*	*_____*
- FMD1	Testing LPAR	FMTEST2
- TESTLP3	Development LPAR	TESTER3
- ****	End of data	****
Command ==>		Scroll <u>C</u> SR
F1=Help	F2=Split	F3=Exit
F8=Forward	F9=Swap	F10=Left
	F4=CRetriev	F5=RFind
	F11=Right	F12=Cancel
		F7=Backward

Name

This is a 1 to 8 character name that you will provide to be used to identify the remote system when specifying data set names within File Manager. The data set name will be in the form:

RM:Name:Data set name

Description

The description of the remote system.

User

The userID that will be used for the remote system logon.

Port

Port number which will be used to connect to remote system server.

Address

The host TCPIP address of the remote system.

Prefix commands:

You can enter the following commands in the prefix area of the data display:

S or /

Will select a connection for a selection list or will edit the connection when editing the remote system credentials.

D

Will delete the remote system definition.

E

Will edit a remote system definition.

I

Will insert a new remote system definition.

Replace panel

Panel and field definitions

Figure 303. Replace panel

<u>P</u> rocess	<u>O</u> ptions	<u>H</u> elp
File Manager		Replace
To Data set:		
Data set/path name . .	'FMN.FMDATA'	
Member name (or mask) .	_____	
Volume serial	_____	
Allocation Options:		
<u>1</u> 1. Allocate using the attributes of	'FMNUSER.DATA'	
2. Specify allocation attributes		
Processing Options:		
ISPF Packing	Enter anything to select option	
<u>1</u> 1. None	_ Binary mode, reclen _____	
2. Pack		
Command ==> -----		
F1=Help	F2=Split	F3=Exit
F9=Swap	F10=Actions	F12=Cancel
	F4=CRetriev	F7=Backward
		F8=Forward

The **Allocation Options** are only required when the "To" data set does not exist.

The **Binary mode** and **reclen** parameters are only relevant for an HFS file.

Parent panels

Child panels

- [Allocate panel on page 737](#)
- [Allocate \(Two\) panel on page 739](#)
- [Allocate \(Three\) panel on page 744](#)

Equivalent functions

- None.

Related tasks and examples

- [Creating, replacing, and adding data using existing data on page 333](#)

Saveas panel

Panel and field definitions

Figure 304. Saveas panel

Process	Options	Help
File Manager		Saveas
To Data set:		
Data set/path name	. . 'FMN.FMDATA'	
Member name (or mask)	. . _____	
Volume serial _____	
Allocation Options:		
<u>1</u>	1. Allocate using the attributes of	
	'FMNUSER.DATA'	
	2. Specify allocation attributes	
Processing Options:		
ISPF Packing		Enter anything to select option
<u>1</u>	1. None	_ Binary mode, reclen _____
	2. Pack	
Command ==> -----		
F1=Help	F2=Split	F3=Exit
F9=Swap	F10=Actions	F12=Cancel
	F4=CRetrieve	F7=Backward
		F8=Forward

The **Allocation Options** are only required when the "To" data set does not exist.

The **Binary mode** and **reclen** parameters are only relevant for an HFS file.

Parent panels

Child panels

- [Allocate panel on page 737](#)
- [Allocate \(Two\) panel on page 739](#)
- [Allocate \(Three\) panel on page 744](#)

Equivalent functions

- None.

Related tasks and examples

- [Creating, replacing, and adding data using existing data on page 333](#)

Scramble Exit Specification panel

The Scramble Exit Specification panel allows you to provide the name of a scramble exit, a constant to be passed to the exit, and to specify whether numeric fields are to be formatted before the value is passed to the exit.

Panel and field definitions

Figure 305. Scramble Exit Specification panel

Process	Options	Help
File Manager	Scramble Exit Specification	
Fixed Attributes:		
Field name	SERIAL-NO	
Type	ZD	
Start	47	
Length	6	
Scramble Exit:		
Program name	_____	
Optional constant	_____	+
Scramble Exit Processing Options:		
Format Option		
1. None		
2. Format		
3. Leading Zeros		
Command ==>		
F1=Help	F2=Split	F3=Exit
F4=Expand	F7=Backward	F8=Forward
F9=Swap	F10=Left	F11=Right
	F12=Cancel	

Program name

A 1 to 8 character valid load module member name that identifies the scramble exit invoked during a copy operation for this output field. The exit must be in the form of a load module, in any load library available to File Manager at the time of the copy process, either by a STEPLIB DD statement, or in LINKLIST, or LPALIST.

Optional constant

A constant value that is passed to the exit for each call type. To enter a hexadecimal value, press F4 or enter the EXPAND command with the cursor positioned in this field and use the command HEX ON from the expand window.

Format Option

This option is only displayed for numeric fields and allows you to request File Manager to pass the value specified in **Optional constant** to the exit in one of the following forms:

1. None

Field value passed to the exit in the internal format.

2. Format

Field value passed to the exit as displayed numeric with leading zeros suppressed.

3. Leading Zeros

Field value passed to the exit as displayed numeric with leading zeros.

Parent panels

- [Field Attributes panel - alphanumeric fields on page 876](#)
- [Field Attributes panel - numeric field on page 883](#)

Related tasks and examples

- [Scrambling data on page 350](#)

Sequential Data to Tape panel

Panel and field definitions

Figure 306. Sequential Data to Tape panel

<u>P</u> rocess	<u>O</u> ptions	<u>H</u> elp
File Manager		Sequential Data to Tape
Tapes: No tapes allocated		
Input:		
Data set name .	_____	
Member	_____	if partitioned
Volume serial .	_____	if not cataloged
Unit	_____	for tape data sets
Skip count . .	_____	number of records to be skipped
Punch count . .	ALL _____	number of cards to be punched
Output:		
DDNAME to use .	_____	enter new name, or select one from above
Tape mode . . .	___	optional recording mode or density code
Record format .	___	F,FB, V,VB,VS,VBS, D,DB,DS,DBS, or U
Block size . .	_____	required for blocked output
Command ==>		
F1=Help	F2=Split	F3=Exit
F9=Swap	F10=Actions	F12=Cancel
F4=CRetrieiv	F7=Backward	F8=Forward

Parent panels

[Tape Specific Functions panel on page 1047](#)

Child panels

Related tasks and examples

Set Batch Job Card Information panel (option 0.4)

Panel and field definitions

Figure 307. Set Batch Job Card Information

Process	Options	Help			
File Manager	Set Batch Job Card Information				
Set processing options as desired and enter EXIT (F3) to save your changes.					
Batch Submission Job Statement Information:					

Command ==>					
F1=Help	F2=Split	F3=Exit	F4=CRetrie	F6=Reset	F7=Backward
F8=Forward	F9=Swap	F10=Actions	F12=Cancel		

Batch Submission Job Statement Information

Batch job card information to be used for generating batch job submission JCL.

If any of these lines are non-blank, then all the non-blank lines are assumed to define a JCL job card and are copied as is into generated JCL. If all these lines are blank, then the JCL generation process generates a basic job card using information from system variables.

Parent panels

- [Set Processing Options panel on page 1029](#)

Child panels

- None.

Equivalent functions

- [SET \(Set Processing Options\) on page 1550](#)

Related tasks and examples

- [Setting your default processing options on page 78](#)

Set COBOL Processing Options panel (option 0.5.2)

The COBOL Processing Options control various options used by the COBOL compiler to generate templates from your COBOL copybooks.

Panel and field definitions

Figure 308. Set COBOL Processing Options

Process	Options	Help
File Manager Set COBOL Processing Options		
Additional SYSLIB data sets:		
1.	-----	
2.	-----	
3.	-----	
4.	-----	
5.	-----	
6.	-----	
7.	-----	
8.	-----	
9.	-----	
10	-----	
COBOL Replacing Options:		
	From string	To string
1.	-----	by-----
2.	-----	by-----
3.	-----	by-----
4.	-----	by-----
5.	-----	by-----
COBOL Compiler Options:		
Enter "/" to select option		
	<input type="checkbox"/> DBCS	<input type="checkbox"/> Decimal-point is comma
	<input type="checkbox"/> Arith(extend)	<input type="checkbox"/> Mixed case field names
Additional options -----		
Maximum Return Code to be accepted from compiler 04 (0-99)		
Command ==>		
F1=Help	F2=Split	F3=Exit
F9=Swap	F10=Actions	F12=Cancel
	F4=CRetriev	F7=Backward
		F8=Forward

Additional SYSLIB data sets

A concatenation of up to 10 SYSLIB data sets may be entered, these data sets are searched in the order specified for COPY members for the compilation.



Note: CA-Panvalet libraries cannot be specified as additional SYSLIB sets. Further, if a CA-Panvalet Library is the main copybook library, then no additional SYSLIB data sets may be specified.

COBOL Replacing Options

"From" and "To" pseudo-text character strings for the REPLACE compiler-directing statement.

COBOL Compiler Options

Compiler options to be used when compiling a COBOL copybook into a template:

DBCS

Instructs File Manager to use the DBCS compiler option.

Decimal-point is comma

Uses the "Decimal-point is comma" SPECIAL-NAMES paragraph when compiling COBOL copybooks.

Arith(extend)

Uses the Arith(extend) COBOL compile option when compiling COBOL copybooks.

Mixed case field names

Retains the original case of the field name as coded in the COBOL copybook.

Additional options

Additional COBOL compiler options which are added via the CBL statement when a COBOL compile is run to build or update a template. These options are validated during the compile process. To avoid compile errors ensure that the syntax is correct and that any additional data sets required by these options are allocated before invoking FMN.

Maximum Return Code

Sets the maximum warning/error code accepted from the compiler, when compiling a copybook. Any code higher than specified causes File Manager to display a pop-up panel, in which you can review the compilation and decide about future processing.

Parent panels

- [Set Processing Options panel on page 1029](#)
- [Set Language and Compiler Specifications \(option 0.5\) on page 1021](#)

Child panels

- None.

Equivalent functions

- None.

Related tasks and examples

- [Printing from File Manager on page 402](#)
- [Data description support on page 180](#)
- [Setting your COBOL processing options on page 202](#)

Set DBCS Format panel

The Set DBCS Format option is used to define where DBCS format, mixed format, and EBCDIC format fields are within an input record.

Panel and field definitions

Figure 309. Set DBCS Format panel

Process	Options	Help
File Manager	Set DBCS Format	
Enter the format definitions (start column, end column, type) in ascending order. Enter RESET to discard the current definitions. Enter LIST to print the current definitions.		
Current Format definition:		
1,*	EB	
Command ==>		
F1=Help	F2=Split	F3=Exit
F9=Swap	F10=Actions	F12=Cancel
F4=CRetriev	F7=Backward	F8=Forward

Format definition

Defines the start, end, and type of input fields in this order separated by commas. Up to 32 field definitions may be entered in ascending order.

Valid ranges are:

start

1-9999

end

1-9999 or * for end of record

type

EB = EBCDIC

DB = DBCS

MI = mixed

Parent panels

- [Utility Functions menu panel on page 1077](#)

Child panels

- None.

Equivalent functions

- None.

Related tasks and examples

- [Printing DBCS data on page 410](#)

Set HLASM Processing Options panel (option 0.5.3)

The HLASM Processing Options panel controls various options used by the HLASM compiler to generate templates from your HLASM copybooks.

Panel and field definitions

Figure 310. Set HLASM Processing Options

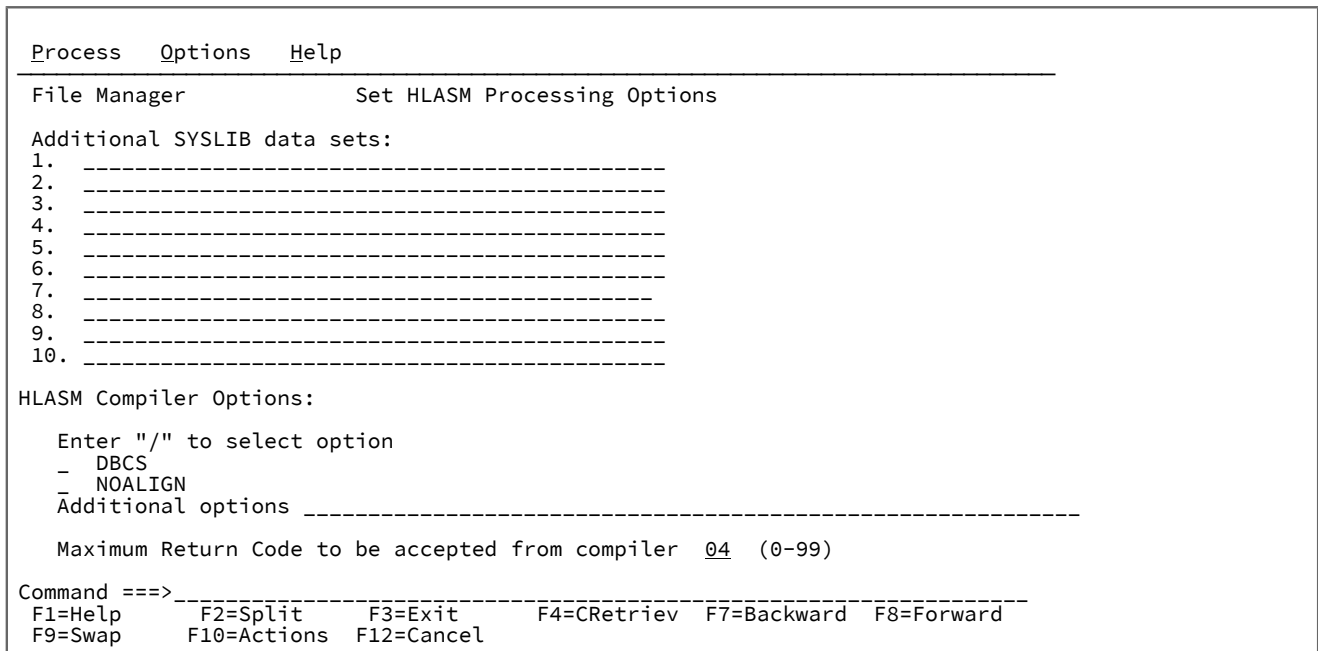

Additional SYSLIB data sets

A concatenation of up to 10 SYSLIB data sets may be entered, these data sets are searched in the order specified for COPY or INCLUDE members for the compilation.

HLASM Compiler Options for Copybooks

Compiler options to be used when compiling a HLASM copybook into a template:

DBCS

If selected, use the DBCS compiler option.

NOALIGN

If selected, use the NOALIGN compiler option.

Additional options

Additional HLASM compiler options which are added via the *PROCESS statement when the assembler is run to build or update a template. These options are validated during the assembly process. To avoid assembly errors please ensure the syntax is correct.

Parent panels

- [Set Processing Options panel on page 1029](#)
- [Set Language and Compiler Specifications \(option 0.5\) on page 1021](#)

Child panels

- None.

Equivalent functions

- [Printing from File Manager on page 402](#)
- [Setting your HLASM processing options on page 204](#)

Set Language and Compiler Specifications (option 0.5)

The Language and Compiler Specifications menu panel is displayed when option 5 is selected from the Settings menu.

The Compiler panels allow you to view and modify selected File Manager parameters relating to the compiler to be used when generating templates together with compiler options to be specified.

Panel and field definitions

Figure 311. Set Language and Compiler Specifications

Process	Options	Help
File Manager		Set language and compiler specifications
1	LANG	Compiler language selection
2	COBOL	COBOL compiler specifications
3	HLASM	HLASM compiler specifications
4	PL/I	PL/I compiler specifications
Command ==>		
F1=Help	F2=Split	F3=Exit
F9=Swap	F10=Actions	F12=Cancel
	F4=CRetriev	F6=Reset
	F7=Backward	F8=Forward

The following topics are presented in sequence by pressing **Enter** or may be selected by number:

1 LANG

Displays the compiler language selection panel.

2 COBOL

Displays the COBOL compiler specifications panel.

3 HLASM

Displays the HLASM compiler specifications panel.

4 PL/I

Displays the PL/I compiler specifications panel.

Parent panels

- [Set Processing Options panel on page 1029](#)

Child panels

- [Compiler Language Selection panel on page 788](#)
- [Set COBOL Processing Options panel \(option 0.5.2\) on page 1016](#)
- [Set PL/I Processing Options panel \(option 0.5.4\) on page 1024](#)
- [Set HLASM Processing Options panel \(option 0.5.3\) on page 1020](#)

Equivalent functions

- None.

Set Output Data Set Allocation Options panel

Panel and field definitions

Figure 312. Set Output Data Set Allocation Options panel

<u>P</u> rocess	<u>O</u> ptions	<u>H</u> elp					
File Manager		Set Output Data Set Allocation Options					
Data set	Space Units	Primary Quantity	Secondary Quantity	Management Class	Storage Class	Data Class	Device Type
Audit Log	CYL 16	8					SYSALLDA
Print	CYL 64	32					SYSALLDA
Trace	CYL 64	32					SYSALLDA
Command ===>							
F1=Help	F2=Split	F3=Exit	F4=CRetriev	F6=Reset	F7=Backward		
F8=Forward	F9=Swap	F10=Actions	F12=Cancel				

Space Units

Defines the unit of primary and secondary space to be allocated.

BLK

Block of average size.

KB

Kilobyte, a kilobyte is 1024 bytes.

MB

Megabyte, a megabyte is 1048576 bytes.

TRK

Track of a direct access storage device (DASD).

CYL

Cylinder of a DASD.

Primary Quantity

Amount of DASD space to be used for primary space allocation. The range depends on the space unit specified and the DASD device type.

Secondary Quantity

Amount of DASD space to be used for secondary space allocation. The range depends on the space unit specified and the DASD device type.

Management Class

Name of a management class defined in your Storage Management System (SMS) installation. Do not enter a value on a system without SMS.

Storage Class

Name of a storage class defined in your Storage Management System (SMS) installation. Do not enter a value on a system without SMS.

Data Class

Name of a data class defined in your Storage Management System (SMS) installation. Do not enter a value on a system without SMS.

Device Type

Specifies the device type of the volume to contain the data set. Enter an IBM® device type or a generic device name that is supported by your system.

Parent panels

- [Set Processing Options panel on page 1029](#)

Child panels

- None.

Equivalent functions

- None.

Set PL/I Processing Options panel (option 0.5.4)

The PL/I Processing Options panel controls various options used by the PL/I compiler to generate templates from your PL/I copybooks.

Panel and field definitions

Figure 313. Set PL/I Processing Options

```

Process  Options  Help
-----
File Manager          Set PL/I Processing Options

Additional SYSLIB data sets:
1. -----
2. -----
3. -----
4. -----
5. -----
6. -----
7. -----
8. -----
9. -----
10. -----

PL/I Compiler Options for Copybooks:

Enter "/" to select option
- GRAPHIC                - UNALIGNED
- 63 bit binary          - 31 digit decimal
Additional options -----
Maximum Return Code to be accepted from compiler 04 (0-99)

Command ==>-----
F1=Help   F2=Split   F3=Exit   F4=CRetriev F7=Backward F8=Forward
F9=Swap   F10=Actions  F12=Cancel
    
```

Additional SYSLIB data sets

A concatenation of up to 10 SYSLIB data sets may be entered, these data sets are searched in the order specified for COPY members for the compilation.

PL/I Compiler Options for Copybooks

Compiler options to be used when compiling a PL/I copybook into a template:

GRAPHIC

If selected, use the GRAPHIC compiler option. Otherwise, use NOGRAPHIC.

63 bit binary

If selected, use the LIMITS(FIXEDBIN(63)) compiler option. Otherwise, use LIMITS(FIXEDBIN(31)).

UNALIGNED

If selected, use the `DEFAULT RANGE(*) UNALIGNED;` language statement to change the default alignment.

31 digit decimal

If selected, use the `LIMITS(FIXEDDEC(31))` compiler option. Otherwise, use `LIMITS(FIXEDDEC(15))`.

Additional options

Additional PL/I compiler options which are added via the `*PROCESS` statement when a PL/I compile is run to build or update template. These options are validated during the compile process. To avoid compile errors please ensure the syntax is correct and that any additional data sets required by these options are allocated prior to invoking File Manager.

Maximum Return Code

Sets the maximum warning/error code accepted from the compiler, when compiling a copybook. Any code higher than specified causes File Manager to display a pop-up panel, in which you can review the compilation and decide about future processing.

Parent panels

- [Set Processing Options panel on page 1029](#)
- [Set Language and Compiler Specifications \(option 0.5\) on page 1021](#)

Child panels

- None.

Equivalent functions

- None.

Related tasks and examples

- [Printing from File Manager on page 402](#)
- [Setting your PL/I processing options on page 205](#)
- [Data description support on page 180](#)

Set Print Processing Options panel (option 0.1)

The Set Print Processing Options panel is used to set the general printing options for File Manager.

Panel and field definitions

Figure 314. Set Print Processing Options

Process	Options	Help
File Manager	Set Print Processing Options	
Print Options:		
Output destination	Record length	Enter "/" to select option
<u>1</u> 1. SYSPRINT	<u>2</u> 1. 80	Page skip
2. Terminal	2. 132	/ Wide print
3. Data set		/ Translate non-printable chars
4. REXX		/ Uppercase message text
		/ Data prefix
		/ Header page
Data set DISP	Dump format	
<u>2</u> 1. OLD	<u>1</u> 1. Updown	
2. MOD	2. Across	
Data set name . . .	JHELVON.FMN.LIST	
Output class . . .	A	
Lines per page . . .	50	
Record limits . . .	(1,*) (n,m) n=begin column, m=end column	
Command ==>		
F1=Help	F2=Split	F3=Exit
F4=CRetrieval	F6=Reset	F7=Backward
F8=Forward	F9=Swap	F10=Actions
F12=Cancel		

Output destination

Specifies where print output is sent, except for batch execution.

SYSPRINT

Send print output to the current SYSPRINT allocation.

Terminal

Send print output to the TSO terminal.

Data set

Output is accumulated in the print data set specified in the **Data set name** field. This data set can be browsed using the PB command, or sent for printing to the JES spool queue with class specified in the **Output class** field using the PRINT command while browsing.

REXX

Send output to a REXX stem variable. Each line corresponds to a variable named FILEM.*nnn*. FILEM.0 contains the line count.

When you use the PRINT primary command in Print Browse (option 3.9), or if you specify batch execution in a File Manager panel, then print output is always sent to a SYSOUT class.

Record length

Specifies the line length of print output.

80

The line length of print output is 80 characters, suitable for a terminal.

132

The line length of print output is 132 characters, suitable for a printer.



Note: Record length is not applicable when:

- The data is printed in TABL format, or
- You specify the wide format for the compare output listing

In either of the above cases, when data is printed the line length is determined from the number and size of fields printed. If this length is greater than the record length specified for the data set, the print line is truncated. The maximum print line length is 32760.

Data set DISP

Specifies the disposition of a print data set.

OLD

The print data set is cleared before each print operation, and print output is written from the beginning of the data set.

MOD

Default setting. Print output is appended to the existing print data set.

Dump format

Specifies the format of hexadecimal print output (for example, when you use Tape Print with **Print format** set to HEX). For an example of each format, see [Selecting a display format on page 105](#).

Updown

The two digits making up the hexadecimal representation of each EBCDIC character are displayed vertically directly under that character.

Across

The hexadecimal digits are displayed as 2 groups of 4 full words resulting in 32 hexadecimal digits followed by the EBCDIC character display to the right of the hexadecimal display.

Page skip

If selected, print output from each function begins on a new page.

Wide print

Applies to new print output data sets (online) or for SYSPRINT allocation (in batch).

If this setting is selected, File Manager uses the maximum record length/blocksize of 32756/32760 and record format of VBA. If this setting is not selected, File Manager uses the record length/blocksize of 133/137 and record format of VBA.



Note: This setting only applies when the output data set is newly allocated during execution. It is ignored for pre-allocated print output data sets.

Translate non-printable chars

Specifies how File Manager should translate non-printable characters.

If selected, non-printable characters are translated to blanks using a translate table.

If not selected, no translation is performed. Use PRTRTRANS=OFF to support special print chains. This may make printing faster.

For instructions on altering the print translate table, see the *File Manager for z/OS Customization Guide*.

Uppercase message text

All message text is translated to uppercase.

Data prefix

If selected, when data is printed in CHAR print format, record number and length are included in character-format print output.

If not selected, you can specify DATAHDR=NO to left-justify the data in the print output, without header information.

Header page

If selected, a header page (a title page with File Manager on it) is included in the print output.

If you specified the **Output destination** as **2** (Terminal), then the header page is not included in the print output, even if you have selected this option.

Data set name

If you specified the **Output destination** as **3** (Data set), then after you enter the PRINT command while executing the Print Browse (PB) function, File Manager sends print output to this temporary data set.

The default is *userid.FMN.LIST*, unless changed in your File Manager installation.

Output class

The class of the JES spool queue to be used when the PRINT command is issued while browsing the temporary print data set.

Lines per page

Specifies the number of lines printed on each page of print output. You can specify a value from 1 to 999. The default is 60.

Record limits

When data is printed in CHAR or LHEX print format, limits print output for each record (or OAM object).

(1,*)

The entire record (or block) is printed.

(n,m)Print output is limited to the data from columns (bytes) *n* through *m*. An asterisk (*) specified for *m* indicates the end of the record.

Parent panels

- [Set Processing Options panel on page 1029](#)

Child panels

- None.

Equivalent functions

- [SET \(Set Processing Options\) on page 1550](#)

Related tasks and examples

- [Printing from File Manager on page 402](#)
- Printing

Set Processing Options panel

Lists the processing options available within FMN. Selecting an option displays the relevant Set Processing Options panel.

Panel and field definitions

Figure 315. Set Processing Options Menu panel

<u>P</u> rocess	<u>O</u> ptions	<u>H</u> elp
File Manager		Set Processing Options
1	Print	Print settings
2	System	System settings
3	Tape	Tape processing options
4	Batch	Job card specifications
5	Compiler	Language and compiler specifications
6	EDIT	Editor options
7	Sharing	VSAM Edit sharing options
8	Temporary	Temporary Data Set Allocations
9	Output	Output Data Set Allocations
10	Trace	Trace options
Command ==>		
F1=Help	F2=Split	F3=Exit
F9=Swap	F10=Actions	F12=Cancel
	F4=CRetriev	F7=Backward
		F8=Forward

1 Print

Displays the Set Print Processing Options panel

2 System

Displays the Set System Processing Options panel

3 Tape

Displays the Set Tape Processing Options panel

4 Batch

Displays the Batch Job Card Information panel

5 Compiler

Displays the Language and compiler specifications panel

6 EDIT

Displays the Editor Options panel

7 Sharing

Displays the VSAM Edit Sharing Options panel

8 Temporary

Displays the Set Temporary Data Set Allocation Options panel (option 0.8)

9 Output

Displays the Set Output Data Set Allocation Options panel

10 Trace

Displays the Set Trace Options panel

Parent panels

- [Primary Option Menu panel on page 970](#)

Child panels

- [Set Print Processing Options panel \(option 0.1\) on page 1025](#)
- [Set System Processing Options panel \(option 0.2\) on page 1031](#)
- [Set Tape Processing Options panel \(option 0.3\) on page 1034](#)
- [Set Batch Job Card Information panel \(option 0.4\) on page 1015](#)
- [Set Language and Compiler Specifications \(option 0.5\) on page 1021](#)
- [Editor Options panel on page 868](#)
- [VSAM Edit Sharing Options panel on page 1101](#)
- [Set Output Data Set Allocation Options panel on page 1022](#)
- [Set Temporary Data Set Allocation Options panel on page 1036](#)
-

Equivalent functions

- [SET \(Set Processing Options\) on page 1550](#)

Related tasks and examples

- [Setting your default processing options on page 78](#)

Set System Processing Options panel (option 0.2)

Panel and field definitions

Figure 316. Set System Processing Options panel

<u>Process</u>	<u>Options</u>	<u>Help</u>
File Manager Set System Processing Options		
Set processing options as desired and enter EXIT (F3) to save your changes.		
Enter RESET to restore installation defaults.		
Data Presentation and Conversion Options:		
PAD . .	<u>OFF</u>	OFF, ON, character or hex value
NOTRUNC		No truncation if PAD selected
CYLHD . .	<u>ABSOLUTE</u>	ABSOLUTE or RELATIVE
EOD . .		Tape input delimiter, 1-8 bytes
CCSID . .	<u>00037</u>	Default CCSID
Editor choice for viewing output data, members:		
Use File Manager editor _		
User I/O Exit Specification:		
Exit enabled	NO	Disabled by installation options
Default exit		N/A
Command ==>		
F1=Help	F2=Split	F3=Exit
F4=CRetriev	F6=Reset	F7=Backward
F8=Forward	F9=Swap	F10=Actions
F12=Cancel		

PAD

Specifies whether records are padded or truncated while being copied.

OFF

Records are not padded with blanks or a specified character, except where required by the output record format. If the output records are fixed format, they are padded with nulls ('00'x), as required to match the output record length. Variable and undefined format outputs are not padded.

Output records are always truncated if they exceed the maximum record length (for fixed or variable) or maximum block length (for undefined formats). However, trailing blanks that fit within the maximum length are not stripped from the record.

ON

Records are modified, depending on the output record format. For fixed-format output, input records that do not fit are truncated or padded with blanks. For variable or undefined output,

trailing blanks are stripped from the input record. (For reasonable results, do not try to deblock and pad in one run.)

c

The value used for padding records. This can be a single character or a hexadecimal value. For example, you can enter an `x` followed by two hexadecimal characters enclosed in quotation marks (X'00'). In addition, for variable or undefined output, a trailing series of the specified character is stripped from the input record. Essentially, this option has the same effect as PAD=ON except that the specified character *c* is used for padding or truncation instead of blanks.

To specify a lowercase pad character, for example "i", either use `c'i'` or the hexadecimal characters `x'89'`.

NOTRUNC

Specifies that, if the PAD option has been selected, no truncation is performed when copying or writing records to a variable-length data set.

NO

Truncation performed.

YES

No truncation performed.

CYLHD

Defines the way you specify the location of a disk data set in disk functions.

ABSOLUTE

File Manager interprets cylinder-head and track-number values as actual physical addresses.

RELATIVE

File Manager interprets cylinder-head and track-number values as relative to the start of the data set.

EOD

End-of-data delimiter for tape input.

delimiter

A 1- to 8-character delimiter. For character data, enclose the string in quotation marks if it contains blanks, commas, or lowercase letters. For hexadecimal data, enter an `x` followed by the string enclosed in quotation marks (for example, X'04').

For some Tape Specific Functions (option 4), you specify the number of files to process in a **Files** field. If you specify `EOD` in the **Files** field, then files are processed until the first record that begins with the EOD delimiter. However, there is no default EOD delimiter for tape input. So, if you want to specify `EOD` in the **Files** field, then you must first specify an EOD delimiter on this options panel; otherwise, File Manager issues an error.

CCSID

Specifies the CCSID to be used as the default CCSID when File Manager is run in batch.

Use File Manager editor

This option controls which editor is invoked when viewing or browsing a member from a member selection panel or when viewing generated output. Select this option to invoke the File Manager editor. If the option is not selected, the ISPF Browse, View or Edit facility is invoked when available.

Exit enabled

This field shows whether or not the installation options allow for a user override of the File Manager I/O exit options in the editor panels, or when using the batch or online panels for these functions: Data Set Copy (DSC), Data Set Compare (DSM), Data Set Edit in Batch (DSEB), Data Set Generate (DSG), Data Set Print (DSP), Data Set Update (DSU) and Find/Change Utility (FCH). If the USEIOX installation option was set to DISABLE, this field is protected and cannot be changed by a user. If the USEIOX installation option was set to ENABLE, the field can be edited and users can choose whether or not to allow user I/O exit overrides within their invocation of File Manager.

NO - Disabled by installation options

The USEIOX installation option was set to DISABLE, therefore, you cannot specify a user I/O exit override.

NO - YES or NO

The USEIOX installation option was set to ENABLE, therefore, you are able to specify a user I/O exit override. However, by setting the field to NO, you are choosing not to allow this in your invocation of File Manager.

YES

The USEIOX installation option was set to ENABLE, and you are choosing to allow a user I/O exit override in your invocation of File Manager.

Default exit

When the USEIOX installation option is enabled, you can use this field to specify the file that contains the default exit program. If the USEIOX installation option is set to DISABLE, this field is protected and cannot be changed.

Parent panels

- [Set Processing Options panel on page 1029](#)

Child panels

- None.

Equivalent functions

- [SET \(Set Processing Options\) on page 1550](#)

Related tasks and examples

- [Setting your default processing options on page 78](#)
- [Specifying a data set and a member name on page 42](#)

Set Tape Processing Options panel (option 0.3)

Panel and field definitions

Figure 317. Set Tape Processing Options

<u>P</u> rocess	<u>O</u> ptions	<u>H</u> elp
File Manager		
Set Tape Processing Options		
Set processing options as desired and enter EXIT (F3) to save your changes.		
Enter RESET to restore installation defaults.		
Tape Processing Options:		
TAPELBL	SL_	SL, AL or AL4, tape label option
ASCII	. NO_	NO, IN (YES), OUT, or BOTH
Command ==>-----		
F1=Help	F2=Split	F3=Exit
F4=CRetriev	F6=Reset	F7=Backward
F8=Forward	F9=Swap	F10=Actions
F12=Cancel		

TAPELBL

Specifies the type of labels that are created:

AL

ANSI Version 3 labels are created. ("Version 3" refers to ANSI X3.27–1978, ISO 1001–1979, and FIPS 79 standards.)

AL4

ANSI Version 4 labels are created. ("Version 4" refers to ANSI X3.27–1987 level 4 and ISO 1001–1986(E) standards.)

SL

EBCDIC labels are created.

For detailed information about ANSI tape labels, see z/OS DFSMS: Using Magnetic Tapes.

This parameter only affects Initialize Tape (option 4.12).

ASCII

Specifies requirements for translation of tape data between ASCII and EBCDIC.

BOTH

Translates tape input from ASCII format to EBCDIC format, and translates tape output from EBCDIC format to ASCII format.

IN

Translates tape input from ASCII format to EBCDIC format.

NO

Does not translate data. This is the default.

OUT

Translates tape output from EBCDIC format to ASCII format.

This processing option applies to all tape input and output functions except:

- Initialize Tape
- Tape Browse
- Tape Label Display
- Tape to Labeled Tape
- Tape to Tape Compare
- Tape Update

For Tape Label Display, ASCII translation is automatically performed when needed. For Initialize Tape and Tape Browse, you can specify ASCII input or output when invoking the function. For the other functions, translation is not supported by File Manager.

Parent panels

- [Set Processing Options panel on page 1029](#)

Child panels

- None.

Equivalent functions

- [SET \(Set Processing Options\) on page 1550](#)

Related tasks and examples

- [Setting your default processing options on page 78](#)

Set Temporary Data Set Allocation Options panel

Panel and field definitions

Figure 318. Set Temporary Data Set Allocation Options panel

Process	Options	Help
File Manager	Set Temporary Data Set Allocation Options	
Set processing options as desired and enter EXIT (F3) to save your changes. Enter RESET to restore installation defaults.		
Temporary data set allocation defaults:		
Unit	SYSALLDA	leave blank for default
Data class	_____	leave blank for default
Storage class	_____	leave blank for default
Management class	_____	leave blank for default
Default High Level Qualifiers:		
Temporary Data Sets	_____	HLQ (opt. &USER/&PREFIX)
Auxiliary Data Set Allocation Defaults:		
High Level Qualifier	_____	leave blank for default
Data class	_____	leave blank for default
Storage class	_____	leave blank for default
Management class	_____	leave blank for default
Model Data Set Name	_____	
Auxiliary Data Set Name		
Command ==>		
F1=Help	F2=Split	F3=Exit
F4=CRetrie v	F6=Reset	F7=Backward
F8=Forward	F9=Swap	F10=Actions
F12=Cancel		

Temporary data set allocation defaults

Unit

Can be one of these:

- A 3-digit hexadecimal device number.
- A 4-digit hexadecimal device number prefixed with a slash (/).
- Device type (generic name).
- Group name (installation-defined symbolic name).

Data class

Name of a data class defined in your Storage Management System (SMS) installation. Do not enter a value on a system without SMS.

Storage class

Name of a storage class defined in your Storage Management System (SMS) installation. Do not enter a value on a system without SMS.

Management class

Name of a management class defined in your Storage Management System (SMS) installation. Do not enter a value on a system without SMS.

Default High Level Qualifiers

Temporary Data Sets

Can be any multi-level qualifier, which is used by File Manager as the high-level qualifier (HLQ) in names of created data sets. You can use these symbols as part of the HLQ:

&USER

Represents the user ID.

&PREFIX

Represents the TSO prefix.

The default is none (unless changed in your File Manager installation).

Auxiliary Data Set Allocation Defaults

High Level Qualifier

Can be any multi-level qualifier, which is used by File Manager as the high-level qualifier (HLQ) in names of created data sets. You can use these symbols as part of the HLQ:

&USER

Represents the user ID.

&PREFIX

Represents the TSO prefix.

The default is none (unless changed in your File Manager installation).

Data class

Name of a data class defined in your Storage Management System (SMS) installation. Do not enter a value on a system without SMS.

Storage class

Name of a storage class defined in your Storage Management System (SMS) installation. Do not enter a value on a system without SMS.

Management class

Name of a management class defined in your Storage Management System (SMS) installation. Do not enter a value on a system without SMS.

Model Data Set Name

A data set name to be used as the model file for defining the auxiliary data set for a full function edit session. The TSO prefix (as defined for your user ID) is used as the high-level qualifier for any name that is not enclosed in quotation marks.

A model data set is used to override the value of the **VOLUMES** parameter for the auxiliary data set definition. The model file must be a VSAM cluster. It should be defined as a RRDS or VRRDS depending on the attributes of the data set being edited. You can provide both RRDS and VRRDS

models by specifying a model data set name that does not exist and represents a prefix for the data set name that will be used.

The model data set that File Manager uses is the name you provided suffixed with “.RRDS” for fixed and “.VRRDS” for variable length records.

Auxiliary Data Set Name

A data set name to be used as the auxiliary file for a full function edit session. The TSO prefix (as defined for your user ID) is used as the high-level qualifier for any name that is not enclosed in quotation marks.

The auxiliary file must be a REUSEable RRDS file, whose record length definitions must be compatible with the file being edited.

If this field is left blank, a RRDS file is automatically defined for the edit session and subsequently deleted.

It should be defined as a RRDS or VRRDS depending on the attributes of the data set being edited.

You can provide both RRDS and VRRDS data sets by specifying a data set name that does not exist and represents a prefix for the data set name that will be used.

The auxiliary data set that File Manager uses is the name you provided suffixed with “.RRDS” for fixed and “.VRRDS” for variable length records.

Parent panels

- [Set Processing Options panel on page 1029](#)

Child panels

- None.

Equivalent functions

- None.

Set Trace options panel

The Set Trace options panel allows you to view and modify parameters that control the Trace output produced by File Manager when it is run in debug mode.

Panel and field definitions

Figure 319. Set Trace options panel

Process	Options	Help
File Manager	Set Trace options	
Trace Options:		
Trace destination		
3	1. FMNTRC	
	2. Terminal	
	3. Data set	
Data set name	JHELVON.FMN.TRACE	
Output class	. A	
Trace limit	. 500	
Command ==>		
F1=Help	F2=Split	F3=Exit
F4=CRetriev	F6=Reset	F7=Backward
F8=Forward	F9=Swap	F10=Actions
F12=Cancel		

Trace destination

Specifies where debug trace File Manager output is to be sent:

FMNTRC

Send trace output to the current FMNTRC allocation.

Terminal

Send trace output to the terminal.

Data set

Send trace output to the temporary data set specified by the **Data set name** field.

Data set name

The temporary trace data set where File Manager trace output is directed when the Data set trace destination is specified.

Output class

The class of the JES spool queue to be used when the PRINT command is issued when browsing the temporary trace data set.

Trace limit

When run in debug mode, File Manager writes the Trace output to a buffer (as for normal debug mode), but the buffer is only written to the Trace destination, if File Manager abnormally terminates.

This field specifies the number of Trace statements that are retained in the buffer. If you specify a value of zero, background debug mode is turned off.

Parent panels

[Set Processing Options panel on page 1029](#)

Child panels

None.

Related tasks and examples

Tape Browse panel

The Tape Browse panel is used to specify the tape or tapes to be browsed, the number of files to be viewed and the starting position and display format to be used when browsing tape contents.

Panel and field definitions

Figure 320. Tape Browse panel

```

  Process  Options  Help
  -----
File Manager                Tape Browse
Tapes:  No tapes allocated

Input:
  DDNAME to use . _____   enter new name, or select one from above
  Files . . . . . 1           number of files or EOV
  Initial BSF . . YES        NO to start from current tape position
  ASCII data . . NO         YES to translate ASCII data for display

Command ==> -----
F1=Help      F2=Split    F3=Exit     F4=CRetriev F7=Backward F8=Forward
F9=Swap      F10=Actions F12=Cancel

```

Tapes:

Lists the tapes currently allocated.

Parent panels

[Tape Specific Functions panel on page 1047](#)

Child panels

Related tasks and examples

Tape Data Copy Functions panel

Panel and field definitions

Figure 321. Tape Data Copy Functions panel

Process	Options	Help
File Manager		Tape Data Copy Functions
1	Tape to tape	Copy tape volume to tape volume
2	Tape reformat	Copy and reformat single tape file
3	Multifile	Copy multivolume and multiple tape files
4	To VSAM	Copy from tape to VSAM data set
5	To QSAM	Copy from tape to QSAM data set
6	From VSAM	Copy from VSAM data set to tape
7	From QSAM	Copy from QSAM data set to tape
8	ESV	Copy Exported Stacked Volume
Command ==>		
F1=Help	F2=Split	F3=Exit
F9=Swap	F10=Actions	F12=Cancel
		F4=CRetriev
		F7=Backward
		F8=Forward

Parent panels

[Tape Specific Functions panel on page 1047](#)

Child panels

- [Tape to Tape panel on page 1050](#)
- [Tape to Tape Reblocked panel on page 1052](#)
- [Tape to Labeled Tape panel on page 1050](#)
- [Tape to VSAM panel on page 1054](#)
- [Tape to QSAM panel on page 1053](#)
- [VSAM to Tape panel on page 1107](#)
- [Sequential Data to Tape panel on page 1015](#)
- [Exported Stacked Volume Copy panel on page 875](#)

Related tasks and examples

[Tape Label Display panel](#)

Panel and field definitions

Figure 322. Tape Label Display panel

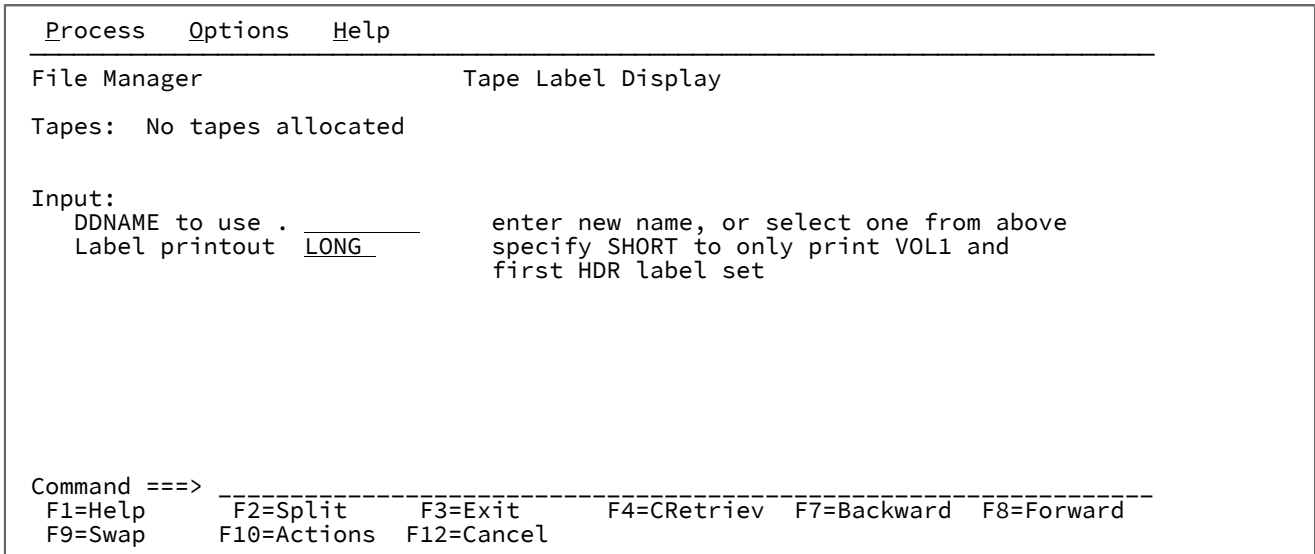

Parent panels

[Tape Specific Functions panel on page 1047](#)

Child panels

Related tasks and examples

Tape Map panel

Panel and field definitions

Figure 323. Tape Map panel

<u>P</u> rocess	<u>O</u> ptions	<u>H</u> elp
File Manager		Tape Map
Tapes: No tapes allocated		
Input:		
DDNAME to use . _____		enter new name, or select one from above
Print Options:		
Files <u>1</u>		number of tape files, EOV, or EOD
Blocks <u>1</u>		number of blocks
Print format . <u>HEX</u>		CHAR or HEX
Command ==> _____		
F1=Help	F2=Split	F3=Exit
F9=Swap	F10=Actions	F12=Cancel
	F4=CRetrieval	F7=Backward
		F8=Forward

Parent panels

[Tape Specific Functions panel on page 1047](#)

Child panels

Related tasks and examples

Tape Positioning Functions panel

Panel and field definitions

Figure 324. Tape Positioning Functions panel

Process	Options	Help
File Manager		Tape Positioning Functions
1	BSF	Backspace file
2	FSF	Forward space file
3	BSR	Backspace record
4	FSR	Forward space record
5	REW	Rewind
6	RUN	Rewind and unload

Command ==> -----
F1=Help F2=Split F3=Exit F4=CRetriev F7=Backward F8=Forward
F9=Swap F10=Actions F12=Cancel

Parent panels

[Tape Specific Functions panel on page 1047](#)

Child panels

Related tasks and examples

Tape Print panel

Panel and field definitions

Figure 325. Tape Print panel

Process	Options	Help
File Manager		Tape Print
Tapes: No tapes allocated		
Input:		
DDNAME to use . _____	enter new name, or select one from above	
Print Options:		
Print format . <u>CHAR</u>	CHAR or HEX	
Record format . <u>U</u>	F,FB, V,VB,VS,VBS, D,DB,DS,DBS, or U	
Record length . <u>50</u>	if deblocking desired, fixed format only	
Records <u>ALL</u>	limit number of records to be printed	
Files <u>1</u>	number of tape files, EOY, or EOD	
Command ==> _____		
F1=Help	F2=Split	F3=Exit
F9=Swap	F10=Actions	F12=Cancel
	F4=CRetriev	F7=Backward
		F8=Forward

Parent panels

[Tape Specific Functions panel on page 1047](#)

Child panels

Related tasks and examples

Tape Record Load panel

Panel and field definitions

Figure 326. Tape Record Load panel

```

  Process  Options  Help
  -----
File Manager                Tape Record Load

Tapes:  No tapes allocated

Input:
  DDNAME to use . _____  enter new name, or select one from above

Output:
  DDNAME to use . _____  enter new name, or select one from above
  Tape mode . . . __         optional recording mode or density code

Command ==> _____
  F1=Help      F2=Split    F3=Exit      F4=CRetrieve  F7=Backward  F8=Forward
  F9=Swap      F10=Actions  F12=Cancel

```

Parent panels

[Tape Specific Functions panel on page 1047](#)

Child panels

Related tasks and examples

Tape Record Scan panel

Panel and field definitions

Figure 327. Tape Record Scan panel

Process	Options	Help
File Manager		Tape Record Scan
Tapes: No tapes allocated		
Input:		
DDNAME to use . _____		enter new name, or select one from above
Record format . <u>U</u>		F,FB, V,VB,VS,VBS, D,DB,DS,DBS, or U
Record length . <u>50</u>		if deblocking desired, fixed format only
Scan Options:		
Pattern scan . <u>NO</u>		YES or NO
Scan position . <u>1</u>		byte position within record to start at
Scan argument . _____		or ALL to list all scan hits in the file
Number of hits <u>1</u>		limit number of records to be scanned
Records <u>ALL</u>		
Command ==> -----		
F1=Help	F2=Split	F3=Exit
F9=Swap	F10=Actions	F12=Cancel
	F4=CRetriev	F7=Backward
		F8=Forward

Parent panels

[Tape Specific Functions panel on page 1047](#)

Child panels

Related tasks and examples

Tape Specific Functions panel

The Tape Specific Functions panel is a menu panel that allows you to select the various tape-specific functions.

Panel and field definitions

Figure 328. Tape Specific Functions panel

Process	Options	Help
File Manager		Tape Specific Functions
1 Browse		Browse tape data
2 Copy		Copy tape data
3 Update		Copy and update tape data
4 Alter		Copy and alter tape data
5 Print		Print tape data
6 Contents		Summarize tape contents
7 Create		Create tape data
8 Summary		Print label summary
9 Compare		Compare two tapes
10 Scan		Scan tape data
11 Tape marks		Write tape marks
12 Initialize		Initialize a tape
13 Erase		Erase tape data
14 ESV list		List Exported Stacked Volume
15 Control		Position a tape
Command ==>		
F1=Help	F2=Split	F3=Exit
F9=Swap	F10=Actions	F12=Cancel
	F4=CRetrieval	F7=Backward
		F8=Forward

1 Browse

Displays the Tape Browse panel, in which you can specify the tape records to be displayed for browsing.

2 Copy

Displays the Tape Data Copy Functions panel, which is another menu panel listing the various copy functions available for tape data.

3 Update

Displays the Tape Update panel, in which you can specify the tape records to be updated.

4 Alter

Displays the Tape Record Load panel, in which you can specify the tape records to be altered.

5 Print

Displays the Tape Print panel, in which you can specify the tape records to be printed.

6 Contents

Displays the Tape Map panel, in which you can specify the tape records to be included in a summary.

7 Create

Displays the Create Tape Data panel, in which you can specify details of the records to be created on a tape.

8 Summary

Displays the Tape Label Display panel, in which you can specify the tape labels and tape label summary to be printed.

9 Compare

Displays the Tape to Tape Compare panel, in which you can specify the tapes to be compared.

10 Scan

Displays the Tape Record Scan panel, in which you can specify the search conditions to be used when scanning the nominated tape.

11 Tape marks

Displays the Write Tape Mark panel, in which you can specify the number of Tape Marks to be written at the current position in the tape.

12 Initialize

Displays the Initialize Tape panel, in which you can start the process of initializing a labeled or unlabeled tape.

13 Erase

Displays the Erase Tape panel, in which you can specify the tape from which data is to be erased.

14 ESV list

Displays the Exported Stacked Volume List panel, in which you can specify an Exported Stacked Volume and a number of listing options for which a Table of Contents is to be printed.

15 Control

Displays the Tape Positioning Functions panel, which is another menu panel listing the various tape positioning functions available for tape data.

Parent panels

[Primary Option Menu panel on page 970](#)

Child panels

- [Tape Browse panel on page 1040](#)
- [Tape Data Copy Functions panel on page 1040](#)
- [Tape Update panel on page 1055](#)
- [Tape Record Load panel on page 1045](#)
- [Tape Print panel on page 1044](#)
- [Tape Map panel on page 1042](#)
- [Create Tape Data panel on page 821](#)
- [Tape Label Display panel on page 1041](#)
- [Tape to Tape Compare panel on page 1051](#)
- [Tape Record Scan panel on page 1046](#)
- [Write Tape Mark panel on page 1117](#)
- [Initialize Tape panel on page 920](#)
- [Erase Tape panel on page 874](#)
- [Exported Stacked Volume List panel on page 875](#)
- [Tape Positioning Functions panel on page 1043](#)

Related tasks and examples

Tape to Labeled Tape panel

Panel and field definitions

Figure 329. Tape to Labeled Tape panel

<u>P</u> rocess	<u>O</u> ptions	<u>H</u> elp
File Manager		Tape to Labeled Tape
Tapes: No tapes allocated		
Input:		
DDNAME to use . _____		enter new name, or select one from above
Type of tape . <u>SL</u> _____		SL or MIXED (mixture of SL and NL files)
Output:		
DDNAME to use . _____		enter new name, or select one from above
Tape mode . . . _____		optional recording mode or density code
Files <u>ALL</u> _____		number of files to be copied or ALL
New Volser(s) . _____		or * or blank
Command ==> -----		
F1=Help	F2=Split	F3=Exit
F9=Swap	F10=Actions	F12=Cancel
	F4=CRetrieve	F7=Backward
		F8=Forward

Parent panels

[Tape Specific Functions panel on page 1047](#)

Child panels

Related tasks and examples

Tape to Tape panel

Panel and field definitions

Figure 330. Tape to Tape panel

Process	Options	Help
File Manager		Tape to Tape
Tapes: No tapes allocated		
Input:		
DDNAME to use . _____		enter new name, or select one from above
Output:		
DDNAME to use . _____		enter new name, or select one from above
Tape mode _		optional recording mode or density code
Files <u>1</u>		number of tape files, EOY, EOT, or EOD
Command ==> -----		
F1=Help	F2=Split	F3=Exit
F9=Swap	F10=Actions	F12=Cancel
	F4=CRetrieve	F7=Backward
		F8=Forward

Parent panels

[Tape Specific Functions panel on page 1047](#)

Child panels**Related tasks and examples**

Tape to Tape Compare panel

Panel and field definitions

Figure 331. Tape to Tape Compare panel

<u>P</u> rocess	<u>O</u> ptions	<u>H</u> elp
File Manager		Tape to Tape Compare
Tapes: No tapes allocated		
Input:		
DDNAME to use . _____	enter new name, or select one from above	
DDNAME to use . _____	enter new name, or select one from above	
Files <u>1</u> _____	number of tape files, EOV, or EOD	
Command ==> -----		
F1=Help	F2=Split	F3=Exit
F9=Swap	F10=Actions	F12=Cancel
	F4=CRetrieve	F7=Backward
		F8=Forward

Parent panels

[Tape Specific Functions panel on page 1047](#)

Child panels

Related tasks and examples

Tape to Tape Reblocked panel

Panel and field definitions

Figure 332. Tape to Tape Reblocked panel

Process	Options	Help
File Manager		Tape to Tape Reblocked
Tapes: No tapes allocated		
Input:		
DDNAME to use . _____		enter new name, or select one from above
Record format . <u>U</u> _____		F,FB, V,VB,VS,VBS, D,DB,DS,DBS, or U
Record length . <u>50</u> _____		if deblocking desired, fixed format only
Output:		
DDNAME to use . _____		enter new name, or select one from above
Tape mode . . . _____		optional recording mode or density code
Record format . _____		F,FB, V,VB,VS,VBS, D,DB,DS,DBS, or U
Block size . . . _____		required for blocked output
Command ==> -----		
F1=Help	F2=Split	F3=Exit
F9=Swap	F10=Actions	F12=Cancel
	F4=CRetrieve	F7=Backward
		F8=Forward

Parent panels

[Tape Specific Functions panel on page 1047](#)

Child panels

Related tasks and examples

Tape to QSAM panel

Panel and field definitions

Figure 333. Tape to QSAM panel

Process	Options	Help
<hr/>		
File Manager	Tape to Sequential Data	
Tapes: No tapes allocated		
Input:		
DDNAME to use .	_____	enter new name, or select one from above
Record format .	<u>U</u> _____	F,FB, V,VB,VS,VBS, D,DB,DS,DBS, or U
Record length .	<u>50</u> _____	if deblocking desired, fixed format only
Skip count . . .	_____	number of records to be skipped
Copy count . . .	<u>ALL</u> _____	number of records to be copied
Files	<u>1</u> _____	number of tape files, EOVS, or EOD
Output:		
Data set name .	_____	
Member	_____	if partitioned
Volume serial .	_____	if not cataloged
Unit	_____	for tape data sets
Disposition . .	<u>CAT</u> _____	OLD, MOD, NEW, or CAT (for NEW,CATLG)
Record format .	<u>FB</u> _____	if new format: U,F,V, or D, with B,S,A,M
Block size . .	_____	physical output block size
Command ==>		
F1=Help	F2=Split	F3=Exit
F9=Swap	F10=Actions	F12=Cancel
	F4=CRetriev	F7=Backward
		F8=Forward

Parent panels

[Tape Specific Functions panel on page 1047](#)

Child panels

Related tasks and examples

Tape to VSAM panel

Panel and field definitions

Figure 334. Tape to VSAM panel

Process	Options	Help
File Manager		Tape to VSAM
Tapes: No tapes allocated		
Input:		
DDNAME to use .	_____	enter new name, or select one from above
Record format .	<u>U</u> _____	F,FB, V,VB,VS,VBS, D,DB,DS,DBS, or U
Record length .	<u>50</u> _____	if deblocking desired, fixed format only
Skip count . . .	_____	number of records to be skipped
Copy count . . .	<u>ALL</u> _____	number of records to be copied
Files	<u>1</u> _____	number of tape files, EOY, or EOD
Output:		
Data set name .	_____	
Reuse	<u>NO</u> _____	YES or NO
Command ==>		
F1=Help	F2=Split	F3=Exit
F9=Swap	F10=Actions	F12=Cancel
	F4=CRetrieval	F7=Backward
		F8=Forward

Parent panels

[Tape Specific Functions panel on page 1047](#)

Child panels

Related tasks and examples

Tape Update panel

Panel and field definitions

Figure 335. Tape Update panel

Process	Options	Help
File Manager		Tape Update
Tapes: No tapes allocated		
Input:		
DDNAME to use . _____		enter new name, or select one from above
Output:		
DDNAME to use . _____		enter new name, or select one from above
Tape mode _-		optional recording mode or density code
Files <u>1</u>		number of files or EOV
Command ==> _____		
F1=Help	F2=Split	F3=Exit
F9=Swap	F10=Actions	F12=Cancel
	F4=CRetrieval	F7=Backward
		F8=Forward

Parent panels

[Tape Specific Functions panel on page 1047](#)

Child panels

Related tasks and examples

Template Build Utility panel

Panel and field definitions

Figure 336. Template Build Utility panel

Process	Options	Help
File Manager	Template Build Utility	
Copybook:		
Data set name .	_____	
Member	_____	Blank or pattern for member list
Template:		
Data set name .	_____	
Member mask . .	_____	
Processing Options:		
Enter "/" to select option		
-	Batch execution	
-	Replace existing templates	
-	Advanced member selection	
-	Skip member list	
Command ==> _____		
F1=Help	F2=Split	F3=Exit
F9=Swap	F10=Actions	F12=Cancel
F4=CRetriev	F7=Backward	F8=Forward

Data set name (Copybook)

Must be a PDS(E) except for vendor-managed library systems such as Panvalet, CA/Librarian, and so on.

Member (Copybook)

You can enter a member name or pattern or leave blank.

Data set name (Template)

Must be a PDS or PDSE identifying where the templates will be stored.

Member mask

Name of a member of a partitioned data set. If you leave the member name blank, or specify a member name pattern, File Manager displays a member name list. You can then select the required member by entering S in the Select field for the appropriate member.

Batch execution

Enter "/" to edit the JCL to run the function in batch.

Replace existing templates

Enter "/" to replace like named members in the output partitioned data set.

Advanced member selection

Enter "/" to specify a range of members to be selected, rather than a specific or generic member name. If you specify this option, the copybook member name is ignored.

Skip member name list

Enter "/" to run without showing the member selection list. This option is ignored if errors are found whilst processing (for example, duplicate output member names when an output member mask has been used).

Parent panels

- [Copybook and Template Utility functions panel on page 809](#)

Child panels

- [Member Selection panel on page 946](#)

Related tasks and examples

- [Creating corresponding templates from selected copybooks on page 217](#)

Template Export Utility panel

The Template Export Utility panel provides a means of exporting templates to external XML templates.

Panel and field definitions

Figure 337. Template Export Utility entry panel

```

Process  Options  Help
-----
File Manager          Template Export Utility
Command ==>> _____

Template:
Data set name . 'FMN.IMP.EXAMPLE'
Member . . . . _____ (Blank or pattern for member list)
Filter . . . . _____

Export Data set:
Data set name . 'FMN.XML.EXAMPLE'
Member mask . . _____

Processing Options:
Enter "/" to select option          Enter "/" to select option
- Batch execution                    - Replace members
- Advanced member selection          - Copybook and criteria only
- Skip member list                   - Stats On
    
```

(Template) Data set name (required)

A fully qualified or generic data set name that is used to identify the data set where the template(s) to be exported reside

Member

You can enter a member name, or pattern, or leave blank. If you select advanced member selection, then this name constitutes the first name on the member range panel.

Filter

Enter up to 4 member names or patterns that are used as a filter for the template selection list that is displayed. The filter name is created as a copybook name for File Manager Base component and IMS™ templates. For IMS™ views and criteria it is treated as an originating template. Any other type of template is skipped if a filter is specified.

(Export Data set) Data set name (Required)

A fully qualified or generic data set name that is used to identify the XML template data set where the exported XML templates are stored.

Member mask

This is a rename mask and allows the exported templates to be stored under an alternative name.

Specify a pattern to rename members in the output partitioned data set based on the member names in the input partitioned data set. A member name pattern can consist of any characters that are valid in a member name and two special pattern characters: the asterisk (*) and the percent sign (%).

*

A place-holding character that means multiple characters with no change. Only one asterisk should appear in the mask. Any subsequent asterisk characters are treated as percent signs. For example, if you enter `ABC*` the renamed members all begin with "ABC" followed by the remainder of the old member name.

%

A place-holding character that means a single character with no change. As many percent symbols as necessary may appear anywhere in a member name. For example, if you enter `%%%A*M` the first three characters of the renamed members remain unchanged, the fourth character is replaced with the letter "A", and the remainder of the old member name are unchanged.

Batch execution

Allows you to edit batch JCL to run the function in batch.

Advanced member selection

Allows you to specify a range of members to be selected, rather than a specific or generic member name.

Skip member list

Runs without showing the member selection list. This option bypasses the member list panel and processes all the qualifying members.

Replace members

Replaces like-named members in an output partitioned data set.

Copybook and criteria only

Restrict the output XML to only the copybook and criteria tags.

Stats On

Always update or create ISPF statistics for exported members.

Figure 338. Template Member Selection export member list

Process	Options	Help					
File Manager	Template Member Selection	Row 00001 of 00002					
Command ==>		Scroll CSR					
Input data set FMN.IMP.EXAMPLE							
Export data set FMN.XML.EXAMPLE							
Name	Prompt	Type	Created	Updated	Lang	Ver	Descr
*	*	*	*	*	*	*	*
CONVT1		DB2	2012/09/19	2012/09/19 11:40:56	NONE	3	
DJ1E		IMS	2012/09/19	2012/09/19 10:44:11	COBOL	3	
**** End of data ****							

Sel

Prefix area. You can enter the following prefix commands:

B

Performs an ISPF BROWSE command against the member. The member is displayed using the ISPF Browse panel, not the File Manager Browse panel.

E

Invoke template editing.

S

Select for template update.

U

Invoke the template source definition edit and update process for the template.

Name

Name of the member.

Prompt

Status values relevant to the action being performed.

Created

The date the template was created.

Updated

For templates, this is the last changed date. For IMS™ views and extract criteria, this is the last time this was updated from its originating template

Lang

The original language of the copybooks from which the fields in the template were derived.

Ver

The version or level of the template.

Description

(To view, scroll right with the Right function key, F11.) The first line of the description that can be entered using the DESCRIBE command during template editing.

Figure 339. Scrolling right on the member list

<u>P</u> rocess	<u>O</u> ptions	<u>H</u> elp			
File Manager	Template Member Selection	Row 00001 of 00002			
Command ==>		Scroll CSR			
Input data set	FMN.IMP.EXAMPLE				
Export data set	FMN.XML.EXAMPLE				
-	<u>N</u> ame	<u>SS</u> ID	<u>O</u> wner	<u>O</u> bject name	<u>DBD</u> data set
	*	*	*	*	*
	CONVT1	DFB2	DSN8810	EMP	
	DJ1E				FMIMS.XTEST.DBDLIB(DJ1E)
****	End of data	****			

SSID

Subsystem ID for Db2® template

Owner Db2®

Object owner for Db2® template

Object name

Db2® object name for Db2® template

DBD data set

DBD data set name for IMS™ template, view or criteria set

Figure 340. Scrolling further right on the member list

```

Process  Options  Help
-----  -
File Manager          Template Member Selection          Row 00001 of 00002
Command ==> _____          Scroll CSR

Input data set FMN.IMP.EXAMPLE
Export data set FMN.XML.EXAMPLE

-      Name      Template data set (Views and Criteria)
  *      *
  _____
  CONV1
  DJ1E
  **** End of data ****
    
```

Template data set

Originating template data set for IMS™ view or criteria set.

Template Import Utility panel

The Template Import Utility panel provides a means of importing external XML templates.

Panel and field definitions

Figure 341. Template Import Utility entry panel

```

Process  Options  Help
-----  -
File Manager          Template Import Utility
Command ==> _____

XML Input:
  Data set name . 'FMN.XML.EXAMPLE'
  Member . . . . _____ (Blank or pattern for member list)

Import Template:
  Data set name . 'FMN.IMP.EXAMPLE'
  Member mask . . _____

Processing Options:
  Enter "/" to select option          Enter "/" to select option
  - Batch execution                    - Replace - No update
  - Advanced member selection          - Skip member list
    
```

(XML Input) Data set name (Required)

A fully qualified or generic data set name that is used to identify the XML input data set.

Member

You can enter a member name, or pattern, or leave blank. If you select advanced member selection, then this name constitutes the first name on the member range panel.

(Import Template) Data set name (Required)

A fully qualified or generic data set name that is used to identify the template data set where the imported templates is stored.

Member mask

This is a rename mask and allows the exported templates to be stored under an alternative name.

Specify a pattern to rename members in the output partitioned data set based on the member names in the input partitioned data set. A member name pattern can consist of any characters that are valid in a member name and two special pattern characters: the asterisk (*) and the percent sign (%).

*

A place-holding character that means multiple characters with no change. Only one asterisk should appear in the mask. Any subsequent asterisk characters are treated as percent signs. For example, if you enter `ABC*` the renamed members all begin with "ABC" followed by the remainder of the old member name.

%

A place-holding character that means a single character with no change. As many percent symbols as necessary may appear anywhere in a member name. For example, if you enter `%%%A*` the first three characters of the renamed members remain unchanged, the fourth character is replaced with the letter "A", and the remainder of the old member name are unchanged.

Batch execution

Allows you to edit batch JCL to run the function in batch.

Advanced member selection

Allows you to specify a range of members to be selected, rather than a specific or generic member name.

Replace - No update

Replaces like-named members in an output partitioned data set. If this option is not selected and the member exists, it is updated with the XML template information.

Skip member list

Runs without showing the member selection list. This option bypasses the member list panel and processes all the qualifying members.

Template List Entry panel

The Template List entry panel is displayed when the primary menu option **7.8** is selected or the ISPF site command is issued without a data set name.

Panel and field definitions

Figure 342. Template List entry panel

<u>P</u> rocess	<u>O</u> ptions	<u>H</u> elp
File Manager		
Command ==> _____		
Template List Entry Panel		
Data set name . PH33060.TEMPLATE.PDSEV2		
Member *	_____	Generation limit _____

Data set name

Specify a fully qualified or generic data set name of either a PDS or PDSE.

- Specify a generic data set name to select a data set from the selection list for processing by the PDSE Workbench.
- Leave the data set name blank to select from the history of up to 50 of the previous data sets used by the PDSE Workbench.

Member name

Specify a member name or member name pattern to display in the member list. Leave blank to display all members.

Generation limit

Defines the maximum number of generations to be displayed for each member. Specify a value in the range 0 to 2000000000 or leave the field blank to indicate no limit. This field is ignored for data sets that do not support member generations.

Parent panels

- [Copybook and Template Utility functions panel on page 809](#)

Template Member List panel

The Template Member List panel is displayed when a valid partitioned data set is provided via the entry panel or the alternate methods of Template List invocation.

Panel and field definitions

Figure 343. Template Member List panel

Process	Options	Help							
File Manager		Template Member List	Row 00001 of 00108						
Command ==>			Scroll CSR						
Data set name .	TEMPLATE.PDSEV2								
Member *	Generation limit								
Compare option 1	1. ISPF 2. SuperC 3. File Manager								
Name	Prompt	Rel	Gen	Type	Created	Updated	Lock	LZ	_
*	*			*	*	*	*	*	
ARRAY		0	0	BASE	2018/01/08	2020/01/09 10:24:23			
ASCII		0	0	DYN	2013/09/18	2013/09/18 09:18:32			
AZNOSEG		0	0	BASE	2005/03/19	2017/07/28 14:26:01			
AZOFF		0	0	BASE	2005/03/19	2014/11/14 09:10:20			
A61D		0	0	IMS	2018/06/05	2020/01/08 14:48:38			
BNPP		0	0	BASE	2013/08/07	2013/08/07 10:12:13			
BNPPRX		0	0	BASE	2013/08/07	2013/09/11 14:32:22			
CCSID930		0	0	DYN	2018/08/01	2018/08/01 13:59:39			
CISH#3		0	0	IMS	2005/07/18	2016/11/30 14:03:11			
CM1T072		0	0	DYN	2015/10/26	2015/10/26 15:49:12			
COBOLNAT		0	0	BASE	2018/06/08	2018/06/08 11:57:02			
COPYSYSL		0	0	BASE	2014/01/30	2014/02/27 11:03:14			

Customizing and sorting columns

See [Customizing and sorting columns on page 276](#).

Field descriptions

See [Field descriptions on page 277](#).

Available commands

The following primary commands are available:

- [BOTTOM primary command on page 1122](#)
- [DELETE \(members\) primary command on page 1143](#)
- [DOWN primary command on page 1146](#)
- [FIND/RFIND primary command on page 1161](#)
- [HEX primary command on page 1172](#)
- [HIDE primary command on page 1173](#)
- [LEFT primary command on page 1178](#)
- [LOCATE primary command on page 1184](#)
- [REFRESH primary command on page 1205](#)
- [RESET primary command on page 1210](#)
- [RFIND primary command on page 1211](#)
- [RIGHT primary command on page 1212](#)
- [SORT primary command on page 1226](#)
- [TAILOR primary command on page 1230](#)
- [TOP primary command on page 1232](#)
- [UP primary command on page 1234](#)

Prefix commands

See [Prefix commands on page 278](#).

Column descriptions

See [Column descriptions on page 280](#)

Parent panels

- [Copybook and Template Utility functions panel on page 809](#)
- [Utility Functions menu panel from ISPF 3.4 on page 1079](#)

Child panels

Related tasks and examples

- [Specifying a data set and a member name on page 42](#)
- [Selecting a range of PDS\(E\) members on page 70](#)
- [Manipulating your view of selection lists on page 62](#)

Template Update Utility panel

There are two forms of the Template Update Utility panel, the entry panel (shown in [Figure 344: Template Update Utility - entry panel on page 1067](#)) and the member list panel (shown in [Figure 345: Template Update Utility - member list on page 1069](#)).

The member list panel is displayed after you have specified the required details on the entry panel and pressed Enter.

Panel and field definitions

Figure 344. Template Update Utility - entry panel

Process	Options	Help
File Manager	Template Update Utility	Top of data
Template:		
Data set name .	_____	
Member	_____	Blank or pattern for member list
Copybook filter	_____	_____
Output Template:		
Data set name .	_____	
Member mask . .	_____	
Processing Options:		
Enter "/" to select option		Enter "/" to select option
_ Batch execution		_ Replace members
_ Advanced member selection		_ Use library data sets
_ Skip member list		_ Check mode - no update
_ Preserve copybook library		
Library data sets:		
Data set name 1	_____	
2	_____	
3	_____	
4	_____	
5	_____	
6	_____	
7	_____	
8	_____	
9	_____	
10	_____	
11	_____	
12	_____	
Command ==>		
F1=Help	F2=Split	F3=Exit
F9=Swap	F10=Actions	F12=Cancel
	F4=CRetriev	F7=Backward
	F8=Forward	

Template

Data set name

Data set name. Must be a PDS(E).

Member

You can enter a member name, or pattern, or leave blank. If you select advanced member selection, then this name constitutes the first name on the member range panel.

Copybook filter

Up to 4 member names or patterns used as a filter so that only templates referencing those copybooks, or copybooks that match the patterns, are selected for processing.

Output Template

This is an optional data set and can be used to provide an alternative data set for the resultant updated templates.

Data set name

Must be a PDS or PDSE identifying where the update templates are to be stored.

Member mask

This is a rename mask and allows the updated templates to be stored under an alternative name.

Specify a pattern to rename members in the output partitioned data set based on the member names in the input partitioned data set. A member name pattern can consist of any characters that are valid in a member name and two special pattern characters: the asterisk (*) and the percent sign (%).

A place-holding character that means multiple characters with no change. Only one asterisk should appear in the mask. Any subsequent asterisk characters are treated as percent signs.

For example, if you enter:

```
ABC*
```

the renamed members will all begin with ABC followed by the remainder of the old member name.

%

A place-holding character that means a single character with no change. As many percent symbols as necessary may appear anywhere in a member name.

For example, if you enter:

```
%%%A*
```

the first 3 characters of the renamed members remain unchanged, the fourth character is replaced with the letter "A", and the remainder of the old member name are unchanged.

Processing Options

Batch execution

Allows you to edit batch JCL to run the function in batch.

Replace members

Replaces like-named members in an output partitioned data set.

Advanced member selection

Allows you to specify a range of members to be selected, rather than a specific or generic member name.

Use library data sets

Uses the library data sets specified on the entry panel.

Skip member list

Runs without showing the member selection list. This option bypasses the member list panel and processes all the qualifying members. If an error (like a duplicate output name) results from the specified parameters, then the member list panel is displayed with the errors highlighted.

Preserve copybook library

Ensures that, if a copybook still exists in the library that it was previously found in and that library is in the list that the update is using, then that version of the copybook is used.

If you do not select this option, or the copybook no longer exists in the library it was previously found in, or that library is not in the list the update is using, then the utility searches the libraries in the order they are listed and uses the first version of the copybook that it finds.

Check mode - no update

Runs the function without saving the resulting members. Normally used to check for errors.

Library data sets

These fields are only used when the **Use library data sets** option is selected. If selected, the copybook library names referenced in the template are changed to copybook library names specified in these fields. The new library data sets are used to locate and compile the copybooks during the update process, so you need to ensure that all the copybooks referenced in all the templates selected are available in the libraries you specify to avoid update errors occurring.

Figure 345. Template Update Utility - member list

<u>P</u> rocess	<u>O</u> ptions	<u>H</u> elp				
File Manager	Template Update Utility		Row 1 of 104			
Input data set 'FMN.RFM0047.TEMPLATE'						
Update data set 'FMN.RFM0047.TEMPLATE'						
Sel	Name	Prompt	Created	Updated	Lang	Ver
—	ABEND		2004/02/11	2004/02/11 09:09:15	COBOL	1
—	BIGCHAR		2004/07/14	2006/06/28 16:12:31	COBOL	1
—	BIGCOPY		2003/12/17	2003/12/17 14:39:16	COBOL	1
—	BIGCOP2		2004/02/11	2004/02/11 10:12:10	COBOL	1
—	BIGKSDS		2001/08/10	2001/08/16 13:54:23	COBOL	1
—	BUGGY		2004/06/24	2004/06/25 10:56:12	COBOL	1
—	CJM01A		2004/06/15	2004/06/15 12:59:06	COBOL	1
—	CNOTFND		2006/07/18	2006/07/18 13:59:25	COBOL	1
—	COMPERR		2006/06/09	2006/06/22 09:45:08	COBOL	1
—	COPYTST		2006/01/10	2006/07/07 08:28:28	COBOL	1
—	COPY01		2006/02/28	2006/07/26 23:31:29	COBOL	1
—	COPY0102		2005/05/03	2006/07/26 23:31:32	COBOL	1
—	CRITERR		2006/07/18	2006/07/18 15:08:00	COBOL	1
Command ==>						Scroll CSR
F1=Help	F2=Split	F3=Exit	F4=Expand	F5=RFind	F7=Up	F8=Down
F9=Swap	F10=Left	F11=Right	F12=Cancel			

Sel

Prefix area. You can enter the following prefix commands:

B

Performs an ISPF BROWSE command against the member. The member is displayed using the ISPF Browse panel, not the File Manager Browse panel.

E

Invoke File Manager Base component template editing.

S

Select for template update.

U

Invoke the template source definition edit and update process for the template.

Name

Name of the member.

Prompt

Status values relevant to the action being performed.

Created

The date the template was created.

Updated

For templates, this is the last changed date. For IMS™ views and extract criteria, this is the last time this was updated from its originating template

Lang

The original language of the copybooks from which the fields in the template were derived.

Ver

The version or level of the template.

Description

(To view, scroll right with the Right function key, F11.) The first line of the description that can be entered using the DESCRIBE command during template editing.

Parent panels

- [Copybook and Template Utility functions panel on page 809](#)

Child panels

- None.

Related tasks and examples

- [Updating one or more templates on page 224](#)

Template Save pop-up panel

The Template Save panel allows you to save a temporary template. It is only displayed when you have created a new copybook or dynamic template and then exit from the template editing panels.

Panel and field definitions

Figure 346. Template Save pop-up panel

```

----- Template Save -----
-
F
C  To discard changes to your template, press PF12/Cancel.
   To use changes without saving, press PF6/RunTemp.
   To save changes, type a data set and member name below, then press
   PF3/Exit.
   Data set name  -----
   Member . . .  -----

C  Command ==> -----
   F1=Help      F2=Split      F3=Exit      F6=RunTemp   F7=Backward
   F8=Forward    F9=Swap      F12=Cancel

```

Data set name

The name of an existing data set, into which you want to save your template. Can be a fully-qualified data set name or a pattern. The name may include a member name or name pattern in parenthesis. If the member is specified here, the associated **Member** field must be empty.

Member

The name of a new member to be created in the existing data set, which will contain your new template definitions. If you specify an existing member name, the existing member is replaced by your new template. If you specified the name of a partitioned data set (PDS) without including a member name or name pattern in parenthesis in the **Data set name** field, then you can use this field to specify the member name or a member name pattern.

Parent panels

- [Record Type Selection panel on page 998](#) (when saving a copybook template with two or more record types)
- [Figure 243: Field Selection/Edit panel on page 892](#) (when saving a copybook template with one record type)
- [Dynamic Template panel on page 845](#) (when saving a dynamic template)

Child panels

- None.

Equivalent functions

- None.

Related tasks and examples

- [Specifying or updating the source definition for a copybook template on page 207](#)
- [Creating dynamic templates on page 214](#)

Template Workbench panel

The Template Workbench is a central area from which you can create, edit and maintain your templates. It can be accessed from the File Manager Primary Options menu (Option **7. Templates**), or by issuing the **TView** primary command on either the View or the Edit panel.

Panel and field definitions

Figure 347. The Template Workbench panel from the Primary Options Menu

```

Process  Options  Help
-----
File Manager          Template Workbench
CC Create template from copybook      E Edit field/record in template
CM Create template from model         U Update template from copybook
MC Map from copybook                  MT Map from template

Copybook:
  Data set name . COPYBK3 _____
  Member . . . . _____
Template:
  Data set name . 'USERID.TEMPLATE' _____
  Member . . . . COPY01 _____
Model Template:
  Data set name . TEMPLATE _____
  Member . . . . TUTDYN _____

Processing Options:
Enter "/" to select option
/_ Advanced copybook selection

Command ==> -----
F1=Help      F2=Split    F3=Exit     F4=CRetriev F6=Describe F7=Backward
F8=Forward   F9=Swap     F10=Actions F12=Cancel
    
```



Note: If the Template Workbench is accessed from an editor session, two additional options (**RC - Run using copybook** and **RT Run using template**) appear on the panel.

Figure 348. The Template Workbench panel from an editor session

```

Process  Options  Help
-----
File Manager          Template Workbench
RC Run using copybook      RT Run using template
CC Create template from copybook  E Edit field/record in template
CM Create template from model    U Update template from copybook
MC Map from copybook          MT Map from template

Copybook:
  Data set name . 'FMNUSER.COPYBOOK' -----
  Member . . . . COPY01____

Template:
  Data set name . 'FMNUSER.TEMPLATE' -----
  Member . . . . TEMP0102

Model Template:
  Data set name . -----
  Member . . . . -----

Processing Options:
  Enter "/" to select option
  / Advanced copybook selection
Command ==>> -----
F1=Help      F2=Split    F3=Exit      F4=CRetriev  F5=RT        F6=Describe
F7=Backward  F8=Forward   F9=Swap      F10=Actions  F12=Cancel

```

Template Workbench commands

The workbench commands that you can use are listed at the top of the panel. You can position the cursor on the required command and press Enter or you can type them on the Command Line and press Enter. These are:

RC

The RC command is used to run the current function using a temporary template created from a copybook. The temporary template cannot be edited before the function is run, and is not saved. Use the CC command if you want to edit or save the template.

You must specify the PDS member name of the copybook you want to use, and the data set name or PDS member name of the template you want to update. The copybook you specify is validated by compiling it. For a description of this process, and information about what you can do if errors occur, see the description of the CC command. This command is only available when the workbench has been invoked from an editor session using the TEdit or TView commands.

RT

The RT command is used to run the current function with an existing template. The template can be either a permanent one previously saved in a data set or PDS member, or a temporary one created for the current function using the CC command. This command is only available when the workbench has been invoked from an editor session using the TEdit or TView commands.

CC

The CC command is used to create a template from a copybook. You can edit the template before running a function with it. You can also save the template for later use.

You must specify the PDS member name of the copybook you want to use. The copybook you specify is validated by compiling it. File Manager includes the copybook in a shell program, and invokes the compiler to syntax-check the copybook, and to produce an ADATA file. If the compilation completes without errors, the information in the ADATA file is processed to create a template. If the compilation completes with errors, a pop-up menu is displayed. From the pop-up menu you can choose to:

- View the compilation listing.
- Abort the template creation process.
- Retry the compilation. Before you select this option, you should view the compilation listing and correct any errors in the copybook. While you are viewing the compilation listing, you can use the split screen facility to swap to another session and use your editor to correct the errors in the copybook.

If File Manager is able to create a template and you provide the name of a sequential data set or PDS member in which the template is to be saved, File Manager saves it for you to use later with other functions. If you do not provide a template name, the template is kept in storage until the end of the current function. You can still use other Template Workbench commands to work with the template, but it is not automatically saved. However, if, at any time before the end of the current function, you decide to save the template, you can specify a template name and save it using the SAVE command.

CM

The CM command is used to create a new template by copying an existing template. You must provide the data set name or PDS member name of the existing template. If you provide the name of a data set or PDS member in which the new template is to be saved, File Manager saves it for you to use later with other functions. If you do not provide a template name, the template is kept in storage until the end of the current function. You can still use other Template Workbench commands to work with the template, but it is not saved for later use. If, at any time before the end of the current function, you decide to save the template, you can specify a template name and save it using the SAVE command.

E

The E command is used to edit an existing template. The template can be either a permanent one previously saved in a data set or PDS member, or a temporary one created for the current function. You can create a temporary template by using the CC command. Alternatively, you can let File Manager automatically create one for you. To do this, specify the member name of a COBOL copybook, but do not specify a template data set name or member name. Then, when you issue the E command, File Manager automatically creates a temporary template.

When you edit a template, a series of panels is displayed on which you can specify the following information:

- For a file containing multiple record types, which record types you want to be selected for processing.
- For a file containing multiple record types, what criteria File Manager should use to identify each record type.
- If you only want to process certain records, such as those containing specified values, what criteria File Manager should use to select those records.
- If you don't want to process all fields within a record, which fields you do want to process.
- What headings you want to use for fields when they are displayed on the screen or printed using the SNGL or TABL display or print formats.
- For numeric fields, whether you want leading zero suppression when they are displayed on the screen or printed using the SNGL or TABL display or print formats.
- When you use the template to help generate test data, what data patterns File Manager should use for each field.

MC

The MC command is used to map the records and fields in one COBOL copybook to the records and fields in another copybook or in a template. You can use the MC command when you want to copy all records in one data set to another data set, and you want to reorganize the fields in the "From" data set before they are copied to the "To" data set. Do not use the MC command if you want to select which records in the "From" data set you want to copy. Instead, you should first create a template, edit it to specify the record selection criteria, and then use the MT command to do the field mapping.

You must specify the PDS member name of the COBOL copybook you want to use. This copybook describes the contents of the "From" data set. The copybook you specify is validated by compiling it with the COBOL compiler. For a description of this process, and information about what you can do if errors occur, see the description of the CC command.

If File Manager is able to create a template from the copybook, another panel is displayed where you specify the name of a COBOL copybook or the name of a template that describes the contents of the "To" data set. From this panel you can specify how you want the fields in the "From" data set mapped to the "To" data set.

MT

The MT command is used to map the records and fields in one template to the records and fields in another template or in a COBOL copybook. You can use the MT command when you want to copy all or selected records in one data set to another data set, and you want to reorganize the fields in the "From" data set before they are copied to the "To" data set.

The template can be either a permanent one previously saved in a data set or PDS member, or a temporary one created for the current function using the CC command. This template describes the contents of the "From" data set, and the record selection criteria for the records you want to

copy. If you want to use a previously saved template, you must specify the data set name (and member name, if required) of the template.

When you use the MT command, another panel is displayed where you specify the name of a template or the name of a COBOL copybook that describes the contents of the "To" data set. From this panel, you can specify how you want the fields in the "From" data set mapped to the "To" data set.

U

The U command is used to update an existing template from a copybook. You should use this function when you have made minor changes to the copybook, and you want these changes reflected in the template you previously created from the copybook. If you have made significant changes to the copybook, the update process might not produce the results you expect, so you should instead use the CC command to recreate the template. Minor changes that the update process supports include:

- Changing field names without changing field data types
- Changing field data types without changing field names
- Changing the order of fields in a record
- Deleting unreferenced fields
- Inserting new fields
- Changing record length
- Changing the number of occurrences of fields in an array (table)

Major changes that might cause the update process to produce unwanted results include:

- Changing field names and field data types
- Changing field names and the order of fields in a record

Copybook

The name (data set and member) of the copybook that contains the record description of your data.

Template

The name (data set and, if required, member) of an existing template you want to run with or edit, or a new template you want to create.

Model Template

The name (data set and, if required, member) of an existing template you want to use as a model for creating a new template.

Advanced copybook selection

When selected, specifies that you want to:

- Use one or more copybooks to create your template
- Be able to specify how these copybooks are interpreted by File Manager

This option applies to the CC and U commands and is provided to enable a template to be generated from more than one copybook which may be located in one or more libraries. If this option is selected, a number of panels may be displayed.

Parent panels

- [Copybook and Template Utility functions panel on page 809](#)
- [Browse panel on page 746](#) (by issuing the TVIEW command)
- [Editor panel on page 853](#) (by issuing the TVIEW command)

Child panels

- [Library List panel on page 923](#)
- [Map To panel on page 941](#)
- [Record Type Selection panel on page 998](#)
- [Field Selection/Edit panel on page 891](#)

Related tasks and examples

Utility Functions menu panel

Lists the utility functions available within File Manager. Selecting an option displays the relevant utility Entry panel.

Panel and field definitions

Figure 349. Utility Functions menu panel

<u>P</u> rocess	<u>O</u> ptions	<u>H</u> elp
File Manager		Utility Functions
0	DBCS	Set DBCS data format for print
1	Create	Create data
2	Print	Print data
3	Copy	Copy data
4	Dslist	Catalog services
5	VTOC	Work with VTOC
6	Find/Change	Search for and change data
7	AFP	Browse AFP data
8	Storage	Browse user storage
9	Printdsn	Browse File Manager print data set
10	Loadlib	View load module information
11	Compare	Compare data
12	Audit trail	Print audit trail report
13	Copybook	View and Print
14	Websphere MQ	List Websphere MQ managers and queues
15	Workbench	PDSE Workbench
Command ==>		
F1=Help	F2=Split	F3=Exit
F9=Swap	F10=Actions	F12=Cancel
	F4=CRetriev	F7=Backward
		F8=Forward

0 DBCS

Displays the Set DBCS Format panel

1 Create

Displays the Data Create Utility panel

2 Print

Displays the Print Utility panel

3 Copy

Displays the Copy Utility panel

4 Dslist

Displays the Catalog Services panel

5 VTOC

Displays the Display VTOC panel

6 Find/Change

Displays the Find/Change Utility panel

7 AFP

Displays the AFP Print Browse panel

8 Storage

Displays the Memory Browse panel

9 Printdsn

Displays print output in full-screen mode

10 Loadlib

Displays the Load Module Information panel

11 Compare

Displays the Compare Utility panel

12 Audit trail

Displays the Print Audit Trail panel

13 Copybook

Displays the Copybook View and Print panel

14 WebSphere MQ

Displays the Websphere MQ Managers panel

15 Workbench

Displays the member list for a PDS or PDSE.

Parent panels

- [Primary Option Menu panel on page 970](#)

Child panels

- Set DBCS Format panel
- Data Create Utility panel
- Print Utility panel
- Copy Utility panel
- Catalog Services panel
- Display VTOC panel
- Find/Change Utility panel
- AFP Print Browse panel
- Memory Browse panel
- Print Browse panel
- Compare Utility panel
- Print Audit Trail panel
- Copybook View and Print panel
- MQ Manager Selection List panel
- PDSE Workbench Entry panel
- PDSE Workbench Member List panel

Equivalent functions

- None.

Related tasks and examples

See the "Related tasks" section for each child panel.

Utility Functions menu panel from ISPF 3.4

This panel is produced when the line command `FMNR` was issued against a data set from ISPF 3.4 and option 3 is selected from the File Manager Primary Options Menu. Selecting an option displays the relevant utility Entry panel with the primary data set name that is populated with the corresponding name on the ISPF 3.4 list.

Panel and field definitions

Figure 350. Utility Functions Menu from ISPF 3.4

<u>P</u> rocess	<u>O</u> ptions	<u>H</u> elp
File Manager		Utility Functions
1 Create		Create data
2 Print		Print data
3 Copy		Copy data
4 Dslist		Catalog services
5 Find/Change		Search for and change data
6 View Load		View Load module
7 Compare Load		Compare Load module
8 Compare		Compare data
9 Copybook		View and Print
10 PDSE Workbench		Member functions
11 List		Template List
Command ==>		
F1=Help	F2=Split	F3=Exit
F9=Swap	F10=Actions	F12=Cancel
	F4=CRetrieval	F7=Backward
		F8=Forward

1 Create

Displays the Data Create Utility panel.

2 Print

Displays the Print Utility panel.

3 Copy

Displays the Copy Utility panel.

4 Dslist

Displays the Catalog Services panel.

5 Find/Change

Displays the Find/Change Utility panel.

6 View Load

Displays the View load module Utility panel.

7 Compare load

Displays the Compare Load Module Utility panel.

8 Compare

Displays the Compare Utility panel.

9 Copybook

Displays the Copybook View and Print panel.

10 PDSE Workbench

Displays the member list for a PDS or PDSE.

11 Template List

Displays the template member list.

Value List Edit panel

This panel allows you to to create and edit value lists to be used in field scrambling.

Panel and field definitions

Figure 351. Value List Edit panel

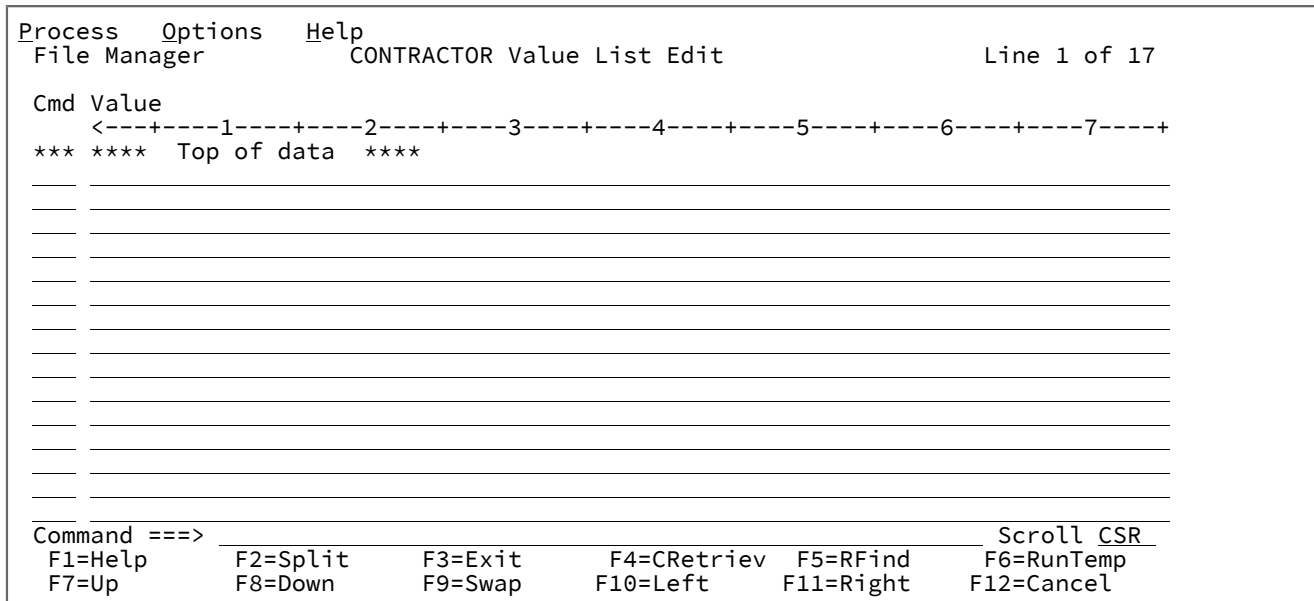

Cmd

Prefix command field. Allows you to copy, insert, move, repeat or delete lines. Available commands are:

- A**
Identifies the line after which data is to be moved or copied.
- B**
Identifies the line before which data is to be moved or copied.
- C**
Copy one line.
- Cn**
Copy *n* lines.
- CC**
Copy block of lines. Marks the start and end of the block.
- D**
Delete one line.

Dn

Delete *n* lines.

DD

Delete block of lines. Marks the start and end of the block.

I

Insert one empty line.

In

Insert *n* empty lines.

M

Move one line.

Mn

Move *n* lines.

MM

Move block of lines. Marks the start and end of the block.

R

Repeat line once.

Rn

Repeat line *n* times.

RR

Repeat block of lines. Marks the start and end of the block.

RRn

Repeat block of lines *n* times. Marks the start and end of the block.

Value

A value that can be used when field scrambling is in effect.

Parent panels

- [Field Attributes panel - alphanumeric fields on page 876](#)
- [Field Attributes panel - numeric field on page 883](#)

Related tasks and examples

- [Specifying and editing a value list on page 249](#)
- [Scrambling data on page 350](#)

View panel

You use the View panel to display a selected data set or data set member, scroll through the records and find and, if necessary, temporarily change specific information within the records. You can also use this panel to temporarily insert or delete new records, join or split existing records and copy or repeat records within the data set.

The View panel displays different fields, depending upon the type of data set shown and whether or not a template has been used.

Panel and field definitions

Figure 352. View panel showing text file

Process	Options	Help
View	FMN.V14R1M20.SFMNSAM1(FMNCDATA)	Rec 33 of 40
Col 1	Insert length 80	Format CHAR
-----+-----1-----+-----2-----+-----3-----+-----4-----+-----5-----+-----6-----+-----7-		
*****	****	Top of data ****
000001	01	REC-TYPE01.
000002	03	REC-TYPE PIC XX.
000003	03	NAME PIC X(20).
000004	03	EMPLOYEE-NO PIC 9(4) BINARY.
000005	03	AGE PIC 9(4) BINARY.
000006	03	SALARY PIC 9(7) PACKED-DECIMAL.
000007	03	MONTH PIC 9(8) BINARY OCCURS 12 TIMES.
000008		
000009	03	FILLER PIC XX.
*****	****	End of data ****
Command ==>		
F1=Help	F2=Zoom	F3=Exit
F7=Up	F8=Down	F9=Swap
	F4=CRetriev	F5=RFind
	F10=Left	F11=Right
		F6=RChange
		F12=Cancel
		Scroll CSR

Title

The Title identifies the function (Edit) and the data set being used. For a PDS or PDSE member, the data set name includes the member name. Record number information, or short messages, appear to the right.

Col

The Col field shows the column number of the column that is currently at the far left of the data area. You can scroll to a specific column (left or right) by typing a new value. The default value for this field is 1.

Insert length

The Insert length field specifies the initial length of inserted records. The possible range of values is from 1 to 9999999, depending on the data set characteristics. The default value is the maximum record length as defined in the catalog. When a User I/O exit is being used, the insert length value is adjusted to the maximum length accepted by the exit for the data set being edited.

Scale

The Scale shows the columns of the data area.

Prefix area (line numbers)

Area (if displayed) displaying the record number of each line in the data set. This area also doubles as the prefix command entry area.

You can use the following prefix commands when editing:

A

Identifies the record after which data is to be moved or copied.

A "K" can be appended to the A to indicate that the source is to be used with multiple destinations. The last destination must not contain the K append so that File Manager knows the command set is complete. No part of the command set is executed until the command set is complete.

B

Identifies the record before which data is to be moved or copied.

A "K" can be appended to the B to indicate that the source is to be used with multiple destinations. The last destination must not contain the K append so that File Manager knows the command set is complete. No part of the command set is executed until the command set is complete.

BND

(Available only in CHAR, HEX and LHEX display formats.) Displays a bounds line on the following line, indicating the columns searched by the CHANGE, FIND, and EXCLUDE commands. To change the bounds, type a < on the bounds line to define the left bound and a > to define the right bound. To remove the bounds line from the display, use the D prefix command or the RESET SPECIAL primary command.

C

Copy one record.

Cn

Copy *n* records.

CC

Copy block of records. Mark start and end of block.

COLS

Displays the column identification line (CHAR, HEX, and LHEX display formats only).

D

Delete one record.

Dn

Delete *n* records.

DD

Delete block of records. Mark start and end of block.

F

Display the first record of a block of excluded records.

Fn

Display the first n records of a block of excluded records.

I

Insert one empty record.

If the display format is CHAR, HEX or LHEX, then the entire record is initialized to blanks.

If the display format is TABL, then the record is initialized according to the record structure of the current record type:

- Numeric fields are initialized to zero.
- Alphanumeric fields are initialized to blanks.
- If the record type contains a variable-length array, then the record is initialized with the minimum number of array elements, and the array size field (or fields, for multi-dimensional arrays) is initialized accordingly.

In

Insert n empty records.

L

Display the last record of a block of excluded records.

Ln

Display the last n records of a block of excluded records.

LC

Translate all uppercase characters in a record contents to lower case (see **Caution** in LCC).

LCn

Translate all uppercase characters in n records to lower case (see **Caution** in LCC).

LCC

Translate all uppercase characters in a block of records to lower case. Mark start and end of block.



CAUTION: The LC commands (LC, LCn, LCC) affect all characters in a record, not just characters in those fields with an alphanumeric or character data type. This means that



numeric data, such as binary data or packed decimal data, can be corrupted by using these commands.

M

Move one record.

Mn

Move *n* records.

MM

Move block of records. Mark start and end of the block.

O

Overlay one record.

O

The O (overlay) command indicates the target when you want to merge lines. Overlay is used in conjunction with move and copy commands.

A "K" can be appended to the O to indicate that the source is to be used with multiple destinations. The last destination must not contain the K append so that File Manager knows the command set is complete. No part of the command set is executed until the command set is complete.

On

Overlay *n* records.

OO

Overlay block of records. Mark start and end of the block.

P

Identifies the record preceding which data is to be moved or copied. This is synonymous with the B prefix command.

R or "

Repeat one record.

Rn or "n

Repeat *n* records.

RF

Perform a refresh of the record. (Shared files only.)

RFn

Perform a refresh of *n* records. (Shared files only.)

RFF

Perform a refresh of a block of records. Mark start and end of the block. (Shared files only.)

RR or ""

Repeat block of records. Mark start and end of the block.

RR*n* or ""*n*

Repeat block of records *n* times. Mark start and end of block.

SV

Perform a save of the record. (Shared files only.)

SV*n*

Perform a save of *n* records. (Shared files only.)

SVV

Perform a save of a block of records. Mark start and end of the block. (Shared files only.)

UC

Translate all lowercase characters in a record to upper case (see **Caution** in UCC).

UC*n*

Translate all lowercase characters in *n* records to upper case (see **Caution** in UCC).

UCC

Translate all lower case characters in a block of records to upper case. Mark start and end of block.



CAUTION: The UC commands (UC, UC*n*, UCC) affect all characters in a record, not just characters in those fields with an alphanumeric or character data type. This means that numeric data, such as binary data or packed decimal data, can be corrupted by using these commands.

V

(Available only when you are using a template.) Display currently suppressed records of the record type indicated by the shadow line. Records of other record types are suppressed from display.

X

Exclude record from display. If the display of excluded record shadow lines is enabled (see [SHADOW primary command on page 1220](#)), a shadow line is shown indicating how many records are being excluded at this position. To show an excluded record, use the F or LA prefix command.

Xn

Exclude n records from display. If the display of excluded record shadow lines is enabled (see [SHADOW primary command on page 1220](#)), a shadow line is shown indicating how many records are being excluded at this position.

XX

Exclude block of records from display. Mark start and end of block. If the display of excluded record shadow lines is enabled (see [SHADOW primary command on page 1220](#)), a shadow line is shown indicating how many records are being excluded at this position.

.xxxx

Label a line. The label, xxxx, is a string of 1 to 4 alphabetic characters, that does not start with the character "Z" (labels starting with "Z" are system labels). Labels can be assigned to any data line. Labels cannot be assigned to the bounds line or to shadow lines.

)

Shift record right one position.⁹

)n

Shift record right n positions.⁹

))

Shift block of records right one position. Mark start and end of block.⁹

))n

Shift block of records right n positions. Mark start and end of the block.⁹

(

Shift record left one position.⁹

(n

Shift record left n positions.⁹

((

Shift block of records left one position. Mark start and end of block.⁹

((n

Shift block of records left n positions. Mark start and end of block.⁹

./

Position record at the top of the screen.

9. The shift occurs only for that part of the record within the current bounds limit. See [Setting bounds on page 154](#) for a detailed explanation.

Data Area

The Data Area shows the data in the selected display format. For a description of the different display formats, see [Selecting a display format on page 105](#).

Command

The Command line is a field in which you can enter Primary Commands, such as CHANGE.

Scroll

The Scroll field defines the current scroll amount. You can type a new value.

When a VSAM data set is displayed, additional fields can be seen.

Figure 353. Edit panel showing VSAM data set

```

Edit          FMN.REQ77.RRDS                      Rec 0
              Type RRDS                          Format CHAR
              Col 1          Insert length 4089
-----1-----2-----3-----4-----5-----6-----7-
*****      **** Top of data      ****
000001 xxxxxxxyy orig 1

```

Type

The type of VSAM data set, for example, RRDS. IAM files are also indicated.

When a data set is displayed in TABL format with a template, the column headings show the field names defined in the template.

Figure 354. PDSE member in TABL format

```

Edit          FMN.V14R1M20.SFMNSAM1(FMNCDATA)    Rec 13 of 40
              Format TABL
REC-TYPE NAME          EMPLOYEE-NO    AGE    SALARY    MONTH(1)
#2      #3              #4            #5      #6          #7
AN 1:2  AN 3:20        BI 23:2    BI 25:2  PD 27:4    BI 31:4
<>      <-----1----->      <---->  <---->  <----->  <----->
*****      **** Top of data      ****
000001 01      GRAHAM JONES          5512    94      68000    7

```

When a data set is displayed in SNGL format with a template, the field and record number of the current record is shown.

Figure 355. PDSE data set in SNGL format

```

Edit          FMN.V14R1M20.SFMNSAM1(FMNCDATA)    Rec 13 of 40
Current type is REC-TYPE01                          Format SNGL
Top Line is 1    of 32    in Record 3
Ref Field  Picture Typ Start  Len  Data
2 REC-TYPE          XX    AN    1    2    01
3 NAME      X(20)   AN    3   20  Graham Jones
4 EMPLOYEE-NO          9(4)  BI    23    2    5512
5 AGE       9(4)    BI    25    2    94
6 SALARY    9(7)    PD    27    4   68000

```

Example

Available commands

- APPEND and APPENDX primary commands on page 1119
- BOTTOM primary command on page 1122
- BOUNDS primary command on page 1123
- CANCEL primary command on page 1124
- CAPS primary command on page 1124
- CASE primary command on page 1125
- CE (Change Error) primary command on page 1126
- CEDIT primary command on page 1128
- CHANGE/CX primary command on page 1129
- COPY primary command on page 1138
- CREATE, CREATEX primary commands on page 1141
- DEDIT primary command on page 1142
- DELETE (records) primary command on page 1144
- DOWN primary command on page 1146
- END primary command on page 1148
- EXCLUDE/XX primary command on page 1148
- EXIT primary command on page 1153
- FE (Find Error) primary command on page 1154
- FILE primary command on page 1157
- FIND/FX primary command on page 1157
- FORMAT primary command on page 1170
- HEX primary command on page 1172
- JOIN primary command on page 1176
- JUST primary command on page 1177
- LEFT primary command on page 1178
- LOCATE primary command on page 1182
- NEXT primary command on page 1191
- NEXTREC primary command on page 1192
- OFFSET primary command on page 1193
- PIC primary command on page 1197
- PREVREC primary command on page 1199
- PREFIX primary command on page 1197
- PREVIOUS primary command on page 1198
- PROFILE primary command on page 1200
- RD primary command on page 1201
- RDF primary command on page 1203
- RECOVER primary command on page 1204
- RECSTATS primary command on page 1205
- REFS primary command on page 1206
- REPLACE, REPLACEX primary commands on page 1207

- [RP primary command on page 1214](#)
- [RECLLEN primary command on page 1204](#)
- [RESET primary command on page 1208](#)
- [RFIND primary command on page 1211](#)
- [RIGHT primary command on page 1212](#)
- [SAVE primary command on page 1215](#)
- [SAVEAS primary command \(templates\) on page 1216](#)
- [SHADOW primary command on page 1220](#)
- [SHOW \(REC\) primary command on page 1222](#)
- [SLOC primary command on page 1224](#)
- [SORT primary command on page 1224](#)
- [SPLT primary command on page 1227](#)
- [SPLTJOIN primary command on page 1228](#)
- [STR primary command on page 1228](#)
- [TEDIT primary command on page 1231](#)
- [TOP primary command on page 1232](#)
- [TVIEW primary command on page 1233](#)
- [TYPE primary command on page 1233](#)
- [UP primary command on page 1234](#)
- [VIEW primary command on page 1237](#)
- [ZOOM primary command on page 1239](#)

Parent panels

- [View Entry panel on page 1092](#)

Child panels

- [Template Workbench panel on page 1072](#) (to invoke the panel, enter the TVIEW primary command).
- [Record Type Selection panel on page 998](#) (to invoke the panel, enter the TEDIT primary command - panel displays when template contains more than one record type).
- [Field Selection/Edit panel on page 891](#) (to invoke the panel, enter the TEDIT primary command - panel displays when using a copybook template with only one record type).
- [Dynamic Template panel on page 845](#) (to invoke the panel, enter the TEDIT primary command - panel displays when using a dynamic template).
- [Record Selection Criteria panel on page 991](#) (to invoke the panel, enter the CEDIT primary command).
- [Record Identification Criteria panel on page 982](#) (to invoke the panel, enter the CEDIT ID primary command).

Equivalent functions

- [DSV \(Data Set View\) on page 1480](#)

Related tasks and examples

- [Viewing and changing data sets on page 87](#)

View Entry panel

You use the View Entry panel to select a data set for viewing in the View panel.

Panel and field definitions

Figure 356. View Entry panel

<u>P</u> rocess	<u>O</u> ptions	<u>H</u> elp
File Manager		
View Entry Panel		
Input Partitioned, Sequential or VSAM Data Set, or HFS file:		
Data set/path name	'MACHIND.SEQIM'	+
Member	_____	Blank or pattern for member list
Volume serial	_____	If not cataloged
Start position	_____	+
Record limit	_____	Record sampling _
Copybook or Template:		
Data set name	'FMN.TEMPLATE'	
Member	TEST01	Blank or pattern for member list
Processing Options:		
Copybook/template	Start position type	Enter "/" to select option
3 1. Above	1. Key	– Edit template _ Type (1,2,S)
2. Previous	2. RBA	– Include only selected records
3. None	3. Record number	– Binary mode, reclen _____
4. Create dynamic	4. Formatted key	
Command ==>		
F1=Help	F2=Split	F3=Exit
F9=Swap	F10=Left	F11=Right
		F4=Expand
		F7=Backward
		F8=Forward
		F12=Cancel

Data set/path name

Can be a fully-qualified data set name or a pattern, an HFS file or directory, a WebSphere® MQ queue name, or a CICS® resource.

For information about specifying a WebSphere® MQ queue name, see [Specifying an MQ manager or queue on page 48](#).

For information about specifying a CICS® resource, see [Specifying a CICS resource on page 48](#).

The data set name may include a member name or name pattern in parenthesis. If the member is specified here, the associated **Member** field must be empty.

When you specify an HFS file or directory, you must enter a full path name. If the path name is longer than the displayed entry field, press the Expand function key (F4) to display a pop-up window in which you can enter a longer name.

Member

If you specified the name of a partitioned data set (PDS) without including a member name or name pattern in parenthesis in the **Data set name** field, then you can use this field to specify the member name or a member name pattern.

Volume serial

Serial number of the volume which contains the data set. Required for data sets which are not cataloged.

Start position

Initial starting position for the data set to be viewed. The initial display is positioned at the specified record.

The default is the top of the data set. You can enter a negative record to indicate the number of records before the end of file. For example, to see just the last record on the file, enter -1 as the start point.

The format of the start position field is either numeric or character, depending upon the type of start position selected. For VSAM KSDS Key values, if the value you enter contains leading, embedded or trailing blanks, commas or quotation marks, it must be enclosed in quotation marks. You may also enter a hexadecimal string enclosed in quotation marks and preceded by X or x, for example, `x'c1c2'`. The maximum number of characters, including any required characters, is 250.

When your cursor is in this field, you can use the LEFT/RIGHT commands to scroll within the field (function keys F10/F11). You can also use the EXPAND function (F4), to open the key field in a window.



Note: The Erase EOF key only works on the displayed part of the key. When the key being displayed is larger than the field area on the screen, you must either scroll or expand the field to erase the unseen portions.

For all other data set formats, a valid unsigned number must be entered.

To specify a starting position as the number of records before the end of file, enter a negative record number. For example, to see just the last record on the file, enter a start position of -1.

If you specify a starting position, you should also specify the **Start position type** in the Processing Options. If you do not, File Manager assumes that the value provided in the Starting position field is a record number.

VSAM - KSDS: Key value

If the key is not matched, the record with a key greater than the value given is specified. If the key value is greater than the last record in the data set, the initial position is the "End of data" marker.

VSAM - ESDS: RBA (Relative Byte Address) Value

If the RBA is not matched, the record with a RBA greater than the value given is specified. If the RBA value is greater than that of the last record in the data set, the initial position is the "End of data" marker.

VSAM - RRDS: Slot value

If the slot number is greater than the last used slot in the data set, the initial position is the "End of data" marker.

QSAM: Record Number

If the Record Number is greater than that of the last record in the data set, the initial position is the "End of data" marker.

HFS

As for QSAM.

Record limit

This field restricts the number of records retrieved from a data set (from the start point or top) resulting in an edit or view of a portion of the data set. You can use the keyword "MEMORY" as a record limit to restrict the number of records retrieved to as many as will fit comfortably in the available virtual storage.

The default start position is the top of the data set.

Record Sampling

Indicates whether you want record sampling to be performed on the data set. If you select this option, File Manager displays the Record Sampling panel.

Copybook or Template

Data set name and Member name of the template or copybook to be used to format your data.



Note: In the case of a copybook, this can be the name of a CA-Panvalet library, or a library accessed using the Library Management System Exit.

Copybook/template usage

Indicates if you want to use a template for a logical view of the data.

1

Use the template specified on the panel (or compile the specified copybook into a template, and use that).

2

Use the last template associated with the data set.

3

No logical view is to be used by the function.

4

Create a dynamic template.

Start position type

Determines how File Manager interprets the value provided in the Starting position field. If the Start position type is not specified, File Manager assumes that the value is a Record Number.

1. KEY

Only valid when the data set is a VSAM KSDS, VSAM AIX® or VSAM PATH.

2. RBA

Only valid when the data set is a VSAM KSDS, VSAM AIX® or VSAM ESDS.

3. Record Number

Default. Valid for any type of supported data set.

4. Formatted key

Only valid when the data set is a VSAM KSDS, VSAM AIX®, or VSAM PATH and when a template is provided. This displays the formatted key positioning panel.



Note: For templates with more than one layout, a 01 selection list is displayed first.

Edit template

Indicates if you want to edit the template before use. You edit the template when you need to change format, selection, data create attributes, and reformatting information for output copy templates.

Specify one of the following values:

blank

Invoke the current function without editing the template.

/

Edit the specified template. F3 will return to the entry panel and clear this option.

A

Always edit the specified template. When the template edit session is completed, F3 will invoke the current function. F12 will cancel the template edit session and return to the entry panel.

R

Edit the template and use the RUNTEMP command (F6) to invoke the current function. Exiting the function will re-edit the template. From the template edit session:

- Press F6 to rerun the function.
- Press F3 to save changes and return to the entry panel.
- Press F12 to discard changes and return to the entry panel.

Type (1,2,S)

The type of editing you want to perform.

You can specify one of the following values:

1

Edit the Record Identification Criteria by field first

2

Edit the Record Selection Criteria by field first

S

Edit the source definition for a template using the advanced copybook selection facility.

This option is ignored when editing a dynamic template.

Include only selected records

When the editor session is either in-storage (a record limit of "MEMORY" is used, or record limit is omitted and a record limit of "MEMORY" is implied by means of this option) or when you have selected **Record Sampling**, only the records selected by template processing are included in the editor session.

This option does not alter the operation of editing or viewing if a template is not used.

Binary mode

When processing an HFS file, allows you to specify binary mode (selected) or text mode (unselected).

reclen

When processing an HFS file and the **Binary mode** option is selected, records are derived based on the fixed record length specified. The default is 80.

Can be in the range: 1–32760

Use I/O exit

Allows you to specify a user I/O exit for compressed or encrypted data sets.

This option has two fields. To select the option, enter "/" in the field to the left of Use I/O exit. With this selected, you can then specify which exit to use in the field to the right of the field label.



Note:

1. The fields only display if File Manager is installed with the option **USEIOX=ENABLE**, and the **Exit enabled** field (in the Set System Processing Options panel) is set to YES. If a default is specified with either of those options, it is displayed in the field to the right of Use I/O exit.
2. I/O exits can only be used to process the data sets that you are using. They cannot be used to process the copybook or template that you are using to format the data set.

Parent panels

- [Primary Option Menu panel on page 970](#)

Child panels

Depending upon the options selected in the View Entry panel, the next panel displayed can be:

- [Editor panel on page 853](#)
- [Data Set Selection panel on page 829](#) (a pattern has been entered in the Data set name field)
- [Member Selection panel on page 946](#)(a pattern or a blank has been entered in the Member field)
- [Record Type Selection panel on page 998](#) (Edit Template is selected and the specified template was based on a copybook with more than one record type).
- [Field Selection/Edit panel on page 891](#) (Edit Template is selected and the specified template was based on a copybook with only one record type).
- [Dynamic Template panel on page 845](#) (Create Dynamic option is selected or Edit Template is selected and the specified template was created dynamically).
- [Record Sampling panel on page 988](#) (Record Sampling option selected)
- [Personal Data Set List panel on page 966](#) (Current® Data Set List option selected from the Process drop-down menu, or REFL fastpath command entered).
- [Personal Data Set Lists panel on page 968](#) (Personal Data Set Lists option selected from the Process drop-down menu, or REFD fastpath command entered).

Equivalent functions

- [DSV \(Data Set View\) on page 1480](#)

Related tasks and examples

- [Supplying a procedure when using a File Manager panel on page 530](#)
- [Starting an editor session without using templates on page 89](#)

Volume Summary/Selection panel

Lists volumes which are currently online. To find a specific volume in the list, you can scroll forward and backward through the list, or you can use the LOCATE command. To select a volume, or multiple volumes, enter S in the Select field(s) for the volume(s), and press Enter. You can also select all volumes by entering ALL on the command line and pressing Enter. You can deselect any selected volume by overtyping the S in its Select field.

Panel and field definitions

Figure 357. Volume Summary/Selection panel

Process	Options	Help	
File Manager			
Unit *	DSN	Volume Summary/Selection	
DevType *	VOLSTATE	ALL	SMS SG *
Volumes 5	Data sets 7	VSAM 3	non-VSAM 4
VOLSER D\$US5*	Trks used N/A	Free N/A	Utilized N/A
VOLSER UNIT Dtype SMS-SG	Total	Used	%Used Free trk Tot DSN VSAM nVSA ±
D\$US5* * * *			
- D\$US51 E801 3390	PRIMARY	150255 128750	86 21505 1 1
- D\$US53 E81C 3390	PRIMARY	150255 142702	95 7553 1 1
- D\$US55 E929 3390	PRIMARY	150255 141320	94 8935 1 1
- D\$US57 EA52 3390	PRIMARY	150255 127706	85 22549 2 2
- D\$US58 EA55 3390	PRIMARY	150255 131406	87 18849 2 1 1
**** End of data ****			
Command ==>>			
F1=Help	F2=Split	F3=Exit	F4=CRetriev F5=RFind F6=Process
F7=Up	F8=Down	F9=Swap	F10=Left F11=Right F12=Cancel

Sel

Selection field in which you can enter one of the following line commands:

S

Selects a volume. Displays the Display VTOC Data Set List panel.

I

Displays detailed volume information on the Disk Volume Details panel.

Parent panels

- [Display VTOC panel on page 837](#)

Related tasks and examples

- [Displaying a Volume Table of Contents \(VTOC\) on page 432](#)
- [Manipulating your view of selection lists on page 62](#)

VSAM Association Information panel

Panel and field definitions

Figure 358. VSAM Association Information panel

Process	Options	Help
File Manager		VSAM Association Information
VSAM Catalog Entry:		
Data set name . . .	'SYATES.UNITTEST.RFM0189.KSDS8'	
Catalog ID	'CATALOG.SYSPLEXD.USER'	
VSAM Associations:		
Path	'SYATES.UNITTEST.RFM0189.KSDS8.PATH1'	
Path	'SYATES.UNITTEST.RFM0189.KSDS8.PATH2'	
AIX	'SYATES.UNITTEST.RFM0189.KSDS8.AIX1'	
Data component . .	'SYATES.UNITTEST.RFM0189.KSDS8.AIX1.DATA'	
Index component . .	'SYATES.UNITTEST.RFM0189.KSDS8.AIX1.INDEX'	
Path	'SYATES.UNITTEST.RFM0189.KSDS8.AIX1PTH1'	
Path	'SYATES.UNITTEST.RFM0189.KSDS8.AIX1PTH2'	
AIX	'SYATES.UNITTEST.RFM0189.KSDS8.AIX2'	
Data component . .	'SYATES.UNITTEST.RFM0189.KSDS8.AIX2.DATA'	
Index component . .	'SYATES.UNITTEST.RFM0189.KSDS8.AIX2.INDEX'	
Path	'SYATES.UNITTEST.RFM0189.KSDS8.AIX2PTH1'	
Path	'SYATES.UNITTEST.RFM0189.KSDS8.AIX2PTH2'	
**** End of data ****		
Command ==>		
F1=Help	F2=Split	F3=Exit
F8=Down	F9=Swap	F10=Actions
		F4=CRetriev
		F6=Info
		F7=Up
		F12=Cancel

Parent panels

Child panels

Related tasks and examples

VSAM Define panel

You can use the VSAM Define panel to specify the allocation attributes for a VSAM data set. This panel has five variations, one for each VSAM data type supported by File Manager (KSDS, ESDS, RRDS, VRRDS, LDS). For general information about defining data sets, see the *DFSMS Using Data Sets* manual appropriate for your operating system. For specific information about valid field values, use the field-level Help (put your cursor in the field and press F1).

Panel and field definitions

Figure 359. VSAM Define panel for KSDS

Process	Options	Help
File Manager		
		VSAM Define
VSAM Catalog Entry:		
Data set name	. . 'USERID.NEWDS'	_____
Catalog ID	_____
Basic Information:		
VSAM data type	. . KSDS	Expiration date . (NONE)
Allocate EAS	Blank, NO or OPT
Data	_____
Index	_____
VSAM Cluster Attributes:		
Key length	Key offset
CI size	size of the data control intervals
Buffer space	buffer space to be allocated at open time
Shr cross region	cross system Reuse
Recovery	Spanned Erase
Writecheck	BWO NO LOG NONE
Logstreamid	. . . USERID.ABC	_____
VSAM Data Allocation:		
Allocation unit CYL	REC, KB, MB, TRK, or CYL
Space primary 1	secondary 0
Reclsize average 4089	maximum 4089
Freespace % CI 0	% CA 0
Volume serial(s)	. . . MV8W31	_____
VSAM Index Allocation:		
CI size 1024	size of the index control intervals
Allocation unit TRK	REC, KB, MB, TRK, or CYL
Space primary 1	Secondary 0
Volume serial(s)	. . . MV8W31	_____
SMS Definitions:		
Data class *UNKNOWN	
Storage class BASE	
Management class STANDARD	
Command ==>		
F1=Help	F2=Split	F3=Exit
F9=Swap	F10=Actions	F12=Cancel
	F4=CRetrieve	F7=Up
		F8=Down

Parent panels

[Allocate panel on page 737](#)

Child panels

- None.

Equivalent functions

- None.

Related tasks and examples

[Allocating a new data set on page 332](#)

VSAM Edit Sharing Options panel

The VSAM Edit Sharing Options panel presents options which apply only when editing VSAM files that are potentially being shared by other users.

This is the case for the File Manager Base component when a KSDS SHAREOPTIONS 3 or SHAREOPTIONS 4 file is edited. It is also the case when a (non-KSDS) SHAREOPTIONS 3 or SHAREOPTIONS 4 file can not be allocated to the TSO session as DISP=OLD. Instead, the file is allocated DISP=SHR to allow access to the file and the edit continues with the restriction of inplace editing mode. Alternatively, this could be a CICS® file accessed through the File Manager CICS® product. In either of the above cases, these sharing options become active. These options are designed to provide improved useability for those files that are in such a shared environment.

Panel and field definitions

Figure 360. VSAM Edit Sharing Options panel

Process	Options	Help
File Manager	VSAM Edit Sharing Options	
These options apply only when editing VSAM files that are being shared.		
Autosave frequency _____		
Options for the CHANGE ALL command		
SAVE before starting	_____	Enter ON or OFF.
Change all autosave frequency	_____	
Auto retry for change all	_____	Enter ON or OFF.
Command ==>		
F1=Help	F2=Split	F3=Exit
F9=Swap	F10=Actions	F12=Cancel
	F4=CRetrieval	F7=Backward
		F8=Forward

Autosave frequency

For shared files, issue a AUTOSAVE command after a given number of changes. Set this value to 0 if you do not want an AUTOSAVE command to be issued.

SAVE before starting

When operating on a shared file, during a CHANGE command with the ALL operand, this option determines if a SAVE is issued before commencing the change.

Setting this ON ensures that any updates made to the file so far are saved. During the CHANGE ALL process, when using AUTORTRY (and a CHGASAVE value), the change process may need to refresh records as it goes (due to concurrent updates by other users). That refresh may discard other updates that had been made in this edit session to records on the file. To issue a SAVE before the CHANGE commences, and therefore ensure the state of the records that have been updated, leave the setting at ON.

Change all autosave frequency

This option applies specifically to the operation of the CHANGE command when used with the ALL parameter. Similar to the AUTOSAVE option above, it provides the ability to save records after a given number of changes.

If used, the changes are counted at the record level. That is, if a record is changed (regardless of how many times the CHANGE command changed that record), it is counted as one change. When the number of records changed reaches the number set in this option, a SAVE command is issued and the CHANGE command continues.

Auto retry for change all

This option applies specifically to the operation of the CHANGE command when used with the ALL parameter. This option controls the action taken when a SAVE command is issued during operation of the CHANGE command and another user has updated a record while the change was running. If this option is set ON, the CHANGE command refreshes (that is, it rereads) the record that this occurred on and attempts to reapply the change.

If this option is OFF, each time File Manager detects that the record was updated before the CHANGE command saved the record, File Manager displays a popup window that gives you the choice of updating the record anyway, refreshing the record and reapplying the update, or aborting the CHANGE command.

Parent panels

[Set Processing Options panel on page 1029](#)

Child panels

- None.

Equivalent functions

- None.

Related tasks and examples

- [Working with File Manager and shared files on page 132](#)
- [VSAM edit sharing options \(option 0.7\) on page 83](#)

VSAM Entry Detail panel

The Catalog Services: VSAM Entry Detail panel is used to display the parameters of a selected VSAM data set, allowing you to review or modify them. The information displayed varies according to the type of entry.

Panel and field definitions

Figure 361. VSAM Entry Detail panel (Example showing KSDS data set)

Process	Options	Help
File Manager	VSAM Entry Detail	Top of data
VSAM Catalog Entry:		
Data set name	. . 'SYATES.UNITTEST.RFM0189.CLUSTER.KSDS1'	
Catalog ID 'CATALOG.USER3.SYSPLEXD'	
Additional information available with Stats(F11) and ASsocs(F6) commands.		
Basic Information:		
VSAM data type	. . KSDS	KSDS, ESDS, RRDS, VRRDS or LDS
Creation date	. . 2003/12/17 (351)	
Expiration date	. . ***None***	
Last modified date	. . ***None***	
Data component	. . 'SYATES.UNITTEST.RFM0189.DATA.KSDS1.DATA'	
Index component	. . 'SYATES.UNITTEST.RFM0189.INDEX.KSDS1.INDEX'	
VSAM Associations:		
Path	
AIX	
Data component	
Index component	
Path	
SMS Definitions:		
SMS managed	. . . Y	Backup/Logging:
Data class	. . . *UNKNOWN	BWO . . .
Storage class	. . PRIMARY	Log . . .
Management class	. . PRIMARY	Logstreamid
Last backup date	. . 0000.000.0000	
VSAM Cluster Attributes:		
CI size 20480	size of the data control intervals
Buffer space	. . . 41984	buffer space to be allocated at open time
Share options	Cross region . 1	Cross systems 3
Process options	Reuse N	Recovery . . . Y
	Spanned N	Erase N
	Extended . . . N	Extended addr N
	Compressed . . N	Writecheck . . N
VSAM Data Allocation:		
Allocation unit	. . CYL	REC, KB, MB, TRK, or CYL
Space Primary . . 1	Secondary . 0
Record size	. . Average . . 4089	Maximum . . 4089
Free space	. . % of CI . . 0	% of CA . . 0
Number of volumes 1	Tracks allocated . 15
Volume serial(s)	. . D\$US01	
Device type(s)	. . 3390-3	
VSAM Key Definition:		
Key length 64	Key offset . . 0
VSAM Index Allocation:		
CI size 1024	size of the index control intervals
Allocation unit	. . TRK	REC, KB, MB, TRK, or CYL
Space Primary . . 1	Secondary . 0
Number of volumes 1	Tracks allocated . 1
Volume serial(s)	. . D\$US01	
Device type(s)	. . 3390-3	
Command ==>		
F1=Help	F2=Split	F3=Exit
F7=Up	F8=Down	F9=Swap
	F4=CRetriev	F5=Volumes
	F10=Actions	F11=Stats
		F6=Assocs
		F12=Cancel

Parameters for a VSAM entry

These panels show catalog information such as:

- The VSAM data set type
- The creation date
- The expiration date
- The date and time last modified
- VSAM associations (cluster, AIX®, and path)
- The SMS attributes
- Backup/Logging options
- The control interval size
- The buffer space to be allocated at open time
- The share options
- Reuse (Y or N)
- Recovery (Y or N)
- Spanned (Y or N)
- Erase (Y or N)
- Extended (Y or N)
- Extended addressed (Y or N)
- Compressed (Y or N)
- The space unit for allocation
- The number of units for primary and secondary allocation
- The average and maximum record size
- Free space, as a percentage of the control interval and control area
- Total volumes and tracks allocated for data and index components
- Up to five volume serials and device types
- The key length
- The position of the key within the record (starting with 1)
- Whether the key must be unique (Y or N)
- Up to five key ranges (specified as hexadecimal numbers)



Note: For most of these parameters, you can use the Help function key (F1) to obtain an explanation about the parameter.

Parameters for a path

If you select a path, you can see:

- The creation date
- The expiration date
- The associated alternate index
- The associated cluster

Parameters for a non-VSAM entry

If you select a non-VSAM entry, you can see:

- The creation date
- The expiration date listed in the catalog
- Up to five volume serials and device types
- The SMS attributes



Note: If you change the expiration date for a non-VSAM entry with Catalog Services, this change does not affect the expiration date in the disk VTOC or tape header. Only the catalog entry is changed.

If the data set is a GDG (generation data group) member or has aliases, you can also see:

- The GDG base
- The alias or aliases

Parameters for a GDG base

If you select a GDG base, you can see:

- The creation date
- The expiration date
- The maximum number of GDG members
- The names of the first five GDG members

Parameters for an OAM object collection

If you select an OAM object collection, you can see:

- The creation date
- The expiration date
- The SMS attributes
- The directory token

Parameters for an alias

If you select an alias, you can see the user catalog or data set to which the alias points.

Parent panels

- [Catalog Services Data Set List panel on page 759](#)

Child panels

- None.

Equivalent functions

- None.

Related tasks and examples

- [Managing catalog entries on page 415](#)

VSAM Entry Rename panel

Panel and field definitions

Figure 362. VSAM Entry Rename panel

```

Process  Options  Help
-----
File Manager                VSAM Entry Rename

VSAM Catalog Entry:
Data set name . . 'DTORNEY.FMDATA.KSDS'
Catalog ID . . . 'CATALOG.USER3.SYSPLEXD'

Additional information available with Stats(F11) and ASsocs(F6) commands.

Basic Information:
VSAM data type . . KSDS          KSDS, ESDS, RRDS, VRRDS or LDS
Data component . . 'DTORNEY.FMDATA.KSDS.DATA'
Index component . 'DTORNEY.FMDATA.KSDS.INDEX'

To Rename a VSAM entity, type the new Data set name above and press ENTER.
The component names of a VSAM CLUSTER will be adjusted automatically based
on the newly entered data set name as outlined in the Help (F1).
If finer degree of control over the component names is required then the ALTER
command may be used to adjust component names manually.

Command ==>
F1=Help      F2=Split    F3=Exit     F4=CRetriev F5=Volumes  F6=Assocs
F7=Up        F8=Down     F9=Swap     F10=Actions F11=Stats   F12=Cancel
    
```

Parent panels

[Catalog Services Data Set List panel on page 759](#) [Display VTOC Data Set List panel on page 843](#)

Child panels

Related tasks and examples

[Managing catalog entries on page 415](#)

VSAM Statistics and Extent Detail panel

The VSAM Statistics and Extent Detail panel displays the extents of a disk data set.

To display the VSAM Statistics and Extent Detail panel, press the Stats function key (F11) on the VSAM Entry Detail panel.

To locate specific data, use the LOCATE primary command.

Panel and field definitions

Process	Options	Help
File Manager	VSAM Statistics and Extent Detail	
VSAM Catalog Entry:		
Data set name . 'GREGCZ.VSTRIP2B.RRDS01'		
Catalog ID . . 'CATALOG.USER1.SYSPLEXD'		
More:		
VSAM Statistics:		
Component	----- Records -----	----- Splits -----
-----	---Total--- -Deleted-- -Inserted- -Updated--	-----CI-----CA-----
Data	3300 0 3300 0	0 0
Data Extents:		
Total volumes: 25 (15 used, 10 candidates) Extents: 15 Tracks: 1650		
Ext Volume	---Begin-end--- Reltrk,-----	----- Kilobytes -----
num serial	Cyl-hd Cyl-hd numtrks	Low-alloc High-alloc High-used
1	D\$ST13(1) Extents: 1 Tracks: 110	59400
	--"--- 68 0 75 4 1020,110	0 59399 59400
2	D\$ST0C(2) Extents: 1 Tracks: 110	59400
	--"--- 68 0 75 4 1020,110	0 59399 0
3	D\$ST07(3) Extents: 1 Tracks: 110	59400
	--"--- 801 11 809 0 12026,110	0 59399 0
4	D\$ST14(4) Extents: 1 Tracks: 110	59400
	--"--- 68 0 75 4 1020,110	0 59399 0
5	D\$ST02(5) Extents: 1 Tracks: 110	59400
	--"--- 618 10 625 14 9280,110	0 59399 0
6	D\$ST06(6) Extents: 1 Tracks: 110	59400
	--"--- 761 14 769 3 11429,110	0 59399 0
7	D\$ST11(7) Extents: 1 Tracks: 110	59400
	--"--- 68 2 75 6 1022,110	0 59399 0
8	D\$ST18(8) Extents: 1 Tracks: 110	59400
	--"--- 68 1 75 5 1021,110	0 59399 0
9	D\$ST08(9) Extents: 1 Tracks: 110	59400
	--"--- 713 2 720 6 10697,110	0 59399 0
10	D\$ST0B(10) Extents: 1 Tracks: 110	59400
	--"--- 68 1 75 5 1021,110	0 59399 0
11	D\$ST04(11) Extents: 1 Tracks: 110	59400
	--"--- 763 0 770 4 11445,110	0 59399 0
12	D\$ST0A(12) Extents: 1 Tracks: 110	59400
	--"--- 763 2 770 6 11447,110	0 59399 0
13	D\$ST09(13) Extents: 1 Tracks: 110	59400
	--"--- 763 1 770 5 11446,110	0 59399 0
14	D\$ST03(14) Extents: 1 Tracks: 110	59400
	--"--- 761 14 769 3 11429,110	0 59399 0
15	D\$ST01(15) Extents: 1 Tracks: 110	59400
	--"--- 619 12 627 1 9297,110	0 59399 0
	*(16) (candidate)	
	*(17) (candidate)	
	*(18) (candidate)	
	*(19) (candidate)	
	*(20) (candidate)	
:		
Command ==>		
F1=Help	F2=Split	F3=Exit F4=CRetrieval F6=Process F7=Up
F8=Down	F9=Swap	F10=Actions F11=Info F12=Cancel

Parent panels

- [VSAM Entry Detail panel on page 1102](#)

Child panels

Related tasks and examples

VSAM to Tape panel

Panel and field definitions

Figure 363. VSAM to Tape panel

Process	Options	Help
<hr/>		
File Manager	VSAM to Tape	
Tapes: No tapes allocated		
Input:		
Data set name .	_____	
Start key . . .	_____	key or slot
Skip count . .	_____	number of records to be skipped
Copy count . .	ALL _____	number of records to be copied
Output:		
DDNAME to use .	_____	enter new name, or select one from above
Tape mode . . .	___	optional recording mode or density code
Record format .	___	F,FB, V,VB,VS,VBS, D,DB,DS,DBS, or U
Block size . .	_____	required for blocked output
Command ==> _____		
F1=Help	F2=Split	F3=Exit
F9=Swap	F10=Actions	F12=Cancel
	F4=CRetrie v	F7=Backward
		F8=Forward

Parent panels

[Tape Specific Functions panel on page 1047](#)

Child panels

Related tasks and examples

WebSphere® MQ Functions panel

You use this panel to select a WebSphere® MQ function.

Panel and field definitions

Figure 364.

Process	Options	Help
<hr/>		
File Manager	Websphere MQ Functions	
1 List	List Managers and queues.	
2 View	View a WMQ queue.	
3 Edit	Edit a WMQ queue.	
Command ==> _____		
F1=Help	F2=Split	F3=Exit
F9=Swap	F10=Actions	F12=Cancel
	F4=CRetrie v	F7=Backward
		F8=Forward

The functions you can select are:

1 List

Displays the Websphere MQ Managers panel.

2 View

Displays the Websphere MQ Queue Editor Entry panel.

3 Edit

As for **2 View**.

Parent panels

- [Primary Option Menu panel on page 970](#)

Child panels

- [WebSphere MQ Managers panel on page 1109](#)
- [WebSphere MQ Queue Editor Entry panel on page 1112](#)

Related tasks and examples

- [Working with WebSphere MQ on page 439](#)

WebSphere® MQ Managers panel

This panel is used to select an item from a list.

You can use it, for example, to select an WebSphere® MQ queue name that you want to view.

Panel and field definitions

Figure 365.

<u>P</u> rocess	<u>O</u> ptions	<u>H</u> elp	
File Manager	WebSphere MQ Managers	Row 0001 of 0004	
SSID	↓ Name	Active Code Reason	
<----->	<----->	<-----> <-----> <-----10-----2----->	
— CSQ1	CSQ1MSTR	Active	2 MQRC_Q_MGR_NOT_AVAILABLE
— CSQ2	CSQ2MSTR	Active	2 MQRC_Q_MGR_NOT_AVAILABLE
— CSQ3	CSQ3MSTR	Active	2 MQRC_Q_MGR_NOT_AVAILABLE
— CSQ4	CSQ4MSTR	Active	2 MQRC_Q_MGR_NOT_AVAILABLE
— MQ62	MQ62MSTR	Active	2 MQRC_Q_MGR_NOT_AVAILABLE
— MQ72	MQ72MSTR	Active	0 MQRC_NONE
****	End of data	****	
Command ==>			Scroll PAGE
F1=Help	F2=Split	F3=Exit	F4=CRetriev
F8=Forward	F9=Swap	F10=Left	F11=Right
			F5=RFind F7=Backward
			F12=Cancel

Parent panels

- [WebSphere MQ Functions panel on page 1108](#)

Child panels

- (with I prefix command)
- [WebSphere MQ Queue List panel on page 1116](#) (with S prefix command)

Related tasks and examples

- [Working with WebSphere MQ on page 439](#)

WebSphere® MQ Managers Information panel

This panel provides the attributes of the queue manager that are typically displayed as a result of the DISPLAY QMGR ALL command, including a terse description of the attribute.

Panel and field definitions

Figure 366.

Process	Options	Help
File Manager	Websphere MQ Manager Information	
Queue Manager:		
Manager name	MQ72	
Description	IBM WebSphere MQ for z/OS - V7	
Basic Information:		
Last altered date	2009-08-01	Time . 06.33.19
Platform	MVS	CPI Level 100
Command level	700	
Queue and namelist names:		
Command queue	SYSTEM.COMMAND.INPUT	
Dead letter queue		
Default XMIT queue		
Repository name		
Repository namelist		
SSL Key Repository		
SSL CRL Namelist		
SSL CRL Namelist		
Security related:		
SSL Renegotiate	0	SSL Server subtasks . . . 0
Maximums:		
Priority	9	Message Length 104857600
Open Handles	256	Uncommitted messages . . 10000
Channels	200	Out cluster channels . . 999999999
Cluster exit data len . . 100		Active channels 200
TCPIP Channels	200	LU62 channels 200
Events:		
Authorization events	DISABLED	Local events DISABLED
Remote events	DISABLED	Command events DISABLED
Start/Stop events	ENABLED	Config events DISABLED
Inhibit events	DISABLED	Channel events DISABLED
Performance events	DISABLED	SSL events DISABLED
Bridge events	DISABLED	
Other:		
Syncpoint available	AVAILABLE	Expiry scan interval . . . OFF
Queue sharing group		Trigger interval 999999999
Channel autodef exit		Cluster workload exit . . .
Cluster exit data		
Cluster put behaviour	LOCAL	Shared queue mgr name . . USE
Intra group queueing	DISABLED	Intra group authority . . DEF
Intra queue agent		IP Address version IPV4
Accounting collection	ON	Q monitor collection . . . OFF
Channel collection	OFF	Auto cluster collect . . QMGR
Trace route record	MSG	Activity record
Adapter subtasks	9	Dispatchers 5
TCPIP Keepalive used	NO	TCPIP Task name TCPIP
TCPIP Stack usage	SINGLE	TCPIP Max port number . . 0
TCPIP Min port number	0	LU62 Generic name
LU62 outbound name		LU62 APPCPM suffix
:		
Command ==>		Scroll PAGE
F1=Help	F2=Split	F3=Exit
F12=Cancel	F7=Backward	F8=Forward
		F9=Swap

Each field on the panel has an associated field help panel containing text extracted from the Websphere MQ library, which remains the authoritative reference for all things MQ.

Parent panels

- [WebSphere MQ Managers panel on page 1109](#)

Child panels

- None.

Related tasks and examples

- [Working with WebSphere MQ on page 439](#)

WebSphere® MQ Queue Editor Entry panel

This panel is used to select an item from a list.

You can use it, for example, to select an WebSphere® MQ queue name that you want to view.

Panel and field definitions

Figure 367.

```

  Process  Options  Help
  _____
File Manager                Websphere MQ Queue Editor Entry

Websphere MQ Queue:
  Queue name . . . . D3.CSQ2.ANYQ
  SSID . . . . . CSQ2
Include descriptors . - (Message header information)
Copybook or Template:
  Data set name . . _____
  Member . . . . . (Blank or pattern for member list)
Processing Options:
Copybook/template          Enter "/" to select option
 3 1. Above                - Edit template   Type (1,2,S)
   2. Previous             - Include only selected records
   3. None                  - Create audit trail
   4. Create dynamic

Command ==>
F1=Help      F2=Split    F3=Exit     F4=Expand   F7=Backward F8=Forward
F9=Swap      F10=Left    F11=Right   F12=Cancel
  
```

Queue name

The name of the WebSphere® MQ queue you want to view.

For a generic queue name, use the percent % sign to represent a single character, and an asterisk * to represent any number of characters within the name.

When a name containing generic characters is used, a selection list of matching WebSphere® MQ queues (on the associated WebSphere® MQ queue manager) is presented.

SSID

The name of the WebSphere® MQ queue manager for the WebSphere® MQ queue you want to view.

Include descriptors

When you select this option (with the / character), the message descriptor data returned by the GET MQ API is pre-pended to the record data, allowing these fields to be examined in conjunction with the message data.

If this option is not selected, only the message data is presented for viewing.

Data set name

A fully-qualified or generic data set name for the template describing the message or header contents of the queue you want to view.

Member

Name of a member of a partitioned data set for the template describing the message or header contents of the queue you want to view.

Copybook/template usage

Indicates if you want to use a template for a logical view of the data.

1

Use the template specified on the panel (or compile the specified copybook into a template, and use that).

2

Use the last template associated with the data set.

3

No logical view is to be used by the function.

4

Create a dynamic template.

Edit template

Indicates if you want to edit the template before use. You edit the template when you need to change format, selection, data create attributes, and reformatting information for output copy templates.

Type (1,2,S)

The type of editing you want to perform.

You can specify one of the following values:

1

Edit the Record Identification Criteria by field first

2

Edit the Record Selection Criteria by field first

S

Edit the source definition for a template using the advanced copybook selection facility.

This option is ignored when editing a dynamic template.

Include only selected records

When using a template, only the records selected by template processing are included in the View session.

This option does not alter the operation of view if a template is not used.

Create audit trail

Determines if File Manager generates an audit report of all successful modifications to data made during an Edit session.

The display of this option depends on whether SAF-rule controlled is in effect. See [SAF-rule controlled auditing on page 85](#).

The ability to change this option depends on the installation options (in the FMN0POPT macro).

When your system administrator has enforced audit logging, the **Create audit trail** option in this panel is ignored.

When your system administrator has not enforced audit logging, you can set this option on or off for any particular editing task. Type a "/" in the option entry field to generate audit reporting for the current Edit session.

For more information about setting the Audit Trail options, refer to the *File Manager for z/OS Customization Guide* or see your systems administrator.

Parent panels

- [WebSphere MQ Queue List panel on page 1116](#)

Child panels

- [View panel on page 1083](#)

Related tasks and examples

- [Working with WebSphere MQ on page 439](#)

WebSphere® MQ Queue Information panel

This panel provides the attributes of the queue that are typically displayed as a result of the DISPLAY QLOCAL ALL command, including a terse description of the attribute.

Panel and field definitions

Figure 368.

Process	Options	Help
File Manager	Websphere MQ Queue Information	
Queue:		
Queue name	FMN.RFM0713.NEWQUEUE	
Description	RFM0713 TEST QUEUE FOR DATA CREATE TEST	
Basic Information:		
Last altered date	2009-07-28	Time . 09.04.36
Creation date	2009-07-20	Time . 09.30.48
Queue and namelist names:		
Backout requeue name		
Cluster namelist		
Cluster manager		
Initiation queue		
Transmission queue		
Queue manager name		
Remote name		
Remote manager		
Maximums:		
Depth	999999999	Message Length 4194304
Cluster:		
Name		
Available date		Available time
Queue type		Put behaviour QMGR
Workload priority	0	Workload rank 0
Defaults:		
Message binding	OPEN	Put response
Priority	0	Persistence NO
Read Ahead	NO	Share option EXCL
Type	PREDEFINED	Get ENABLED
Trigger:		
Triggers active		Data
Depth	1	Threshold message pri . 0
Type	FIRST	
Other:		
Accounting enabled	QMGR	Current depth 0
Backout threshold	0	Monitoring QMGR
Sharing group		Usage NORMAL
Harden backout		Index type NONE
Input handles	0	Output handles 0
Delivary sequence	PRIORITY	Reliability level NORMAL
TPIPE names		
Process		Property control COMPAT
Put enabled	ENABLED	Queue depth High 80
Queue depth low	40	High depth events DISABLED
Low depth events	DISABLED	Max depth events ENABLED
Service interval	999999999	Queue type
Retention interval	999999999	Share
Collect stats		Storage class DEFAULT
Target		Target type
Command ==>		Scroll PAGE
F1=Help	F2=Split	F3=Exit
F12=Cancel	F7=Backward	F8=Forward
	F9=Swap	

Parent panels

- [WebSphere MQ Queue List panel on page 1116](#)

Child panels

- None.

Related tasks and examples

- [Working with WebSphere MQ on page 439](#)

WebSphere® MQ Queue List panel

This panel is used to select an item from a list.

You can use it, for example, to select an WebSphere® MQ queue name that you want to view.

Panel and field definitions

Figure 369.

```

Process  Options  Help
-----
File Manager                Websphere MQ Queue List CSQ2      Row 0001 of 0109

Queue                        ↓ Descr
<---+-----10---+-----2---+-----3---> <---+-----10---+-----2---+-----3---+-----4--->
- CICS01.INITQ                CKTI initiation queue
- COOL                        Coolest queue ever
- CSQ1.XMIT.QUEUE            Transmission queue for CSQ1
- CSQ2.DEAD.QUEUE           CSQ2 dead-letter queue
- CSQ2.DEFXMIT.QUEUE        CSQ2 default transmission queue
- CSQ3.XMIT.QUEUE            Transmission queue for CSQ3
- CSQ4IVPG.TRIGGER          WebSphere MQ IVP INITIATION QUEUE
- CSQ4IVP1.TRIGGER          WebSphere MQ IVP INITIATION QUEUE
- D3.CSQ2.ANYQ
- FMN.TEST.NOGET            RFM0037 GET NOT ENABLED
- FMN.TEST005               RFM0037 MQ SERIES TEST Q 1
- FMN.TEST006               RFM0037 MQ SERIES TEST Q 1
- FMN.TEST007               RFM0037 MQ SERIES TEST Q 1
- FMN.TEST008               RFM0037 MQ SERIES TEST Q 1
- FMN.TEST009               RFM0037 MQ SERIES TEST Q 1
Command ==>
F1=Help      F2=Split    F3=Exit     F4=CRetrie v  F5=RFind     Scroll PAGE
F8=Forward   F9=Swap     F10=Left    F11=Right    F12=Cancel   F7=Backward
    
```

You can enter any of these prefix commands in the prefix area against a listed queue:

A

Add queue. Provide a way to issue a queue definition.

D

Delete queue. Provide a way to issue a delete for the queue.

E

Edit queue. Start the edit dialog with this queue as the source.

I

Information. Provide a way to view queue information in one panel.

R

Reset queue. Provide a way to discard all current messages on a queue.

V

View queue. Provide a way to display the contents of the queue.

Parent panels

- [WebSphere MQ Managers panel on page 1109](#)

Child panels

- [WebSphere MQ Queue Editor Entry panel on page 1112](#) (with E prefix command)
- [WebSphere MQ Queue Information panel on page 1114](#) (with I prefix command)

Related tasks and examples

- [Working with WebSphere MQ on page 439](#)

Write Tape Mark panel**Panel and field definitions**

Figure 370. Write Tape Mark panel

<u>P</u> rocess	<u>O</u> ptions	<u>H</u> elp
File Manager		Write Tape Mark
Tapes: No tapes allocated		
Output:		
DDNAME to use . _____	enter new name, or select one from above	
Tape mode . . . _	optional recording mode or density code	
Tape marks . . <u>1</u>	number of tape marks to be written	
Command ==> -----		
F1=Help	F2=Split	F3=Exit
F9=Swap	F10=Actions	F12=Cancel
	F4=CRetriev	F7=Backward
		F8=Forward

Parent panels

[Tape Specific Functions panel on page 1047](#)

Child panels**Related tasks and examples**

Chapter 20. Primary commands

This chapter describes the syntax, parameters and operation of the primary commands that can be used in various File Manager panels. Within each command description, the panels and functions in which the command is available are listed. Where a command has differing functionality on different panels, an explanation of how the command operates in each context is provided.

Primary commands are entered on the Command line of a panel. Some primary commands have equivalent function keys and, where applicable, the default settings for these keys are listed. However, because keylists can be customized through ISPF, your function key settings may differ from those described in this document.

Where the syntax allows you to specify more than one operand, you can use either a blank or a comma as a separator between each operand.

For example, both of the following commands are correct:

```
SORT col1 col2
SORT col1, col2
```

ABOUT primary command

The ABOUT command displays the current File Manager version number and the PTF number of the File Manager Base component in a window. The popup also shows the copyright information and any notes that are shipped with the product.

Syntax

▶▶ ABOUT ▶▶

Availability

Available on all panels

Related tasks and examples

[Checking your File Manager version on page 37](#)

AMSMMSG primary command

The AMSMSG primary command displays the IDCAMS messages, if any, associated with the current task.



Note: You can also invoke the AMSMSG primary command by selecting “AMS message” from the Process pull-down menu.

Syntax

▶▶ AMSMSG ▶▶

Availability

- AIX Association Information panel on page 733
- AIX Entry Detail panel on page 734
- Catalog Services Data Set List panel on page 759
- GDG Entry Detail panel on page 910
- Non-VSAM Association Information panel on page 955
- Non-VSAM Entry Detail panel on page 957
- Path Entry Detail panel on page 959
- VSAM Association Information panel on page 1098
- VSAM Define panel on page 1099
- VSAM Entry Detail panel on page 1102

Related tasks and examples

- Working with a list of catalog entries on page 418
- Viewing your Catalog Entry Details on page 422
- Defining a new Catalog Entry on page 426
- Changing an existing Catalog Entry on page 429
- Deleting a catalog entry on page 430

APPEND and APPENDX primary commands

The APPEND and APPENDX primary commands append to another data set from specified lines of the data in the current editor session.

Syntax

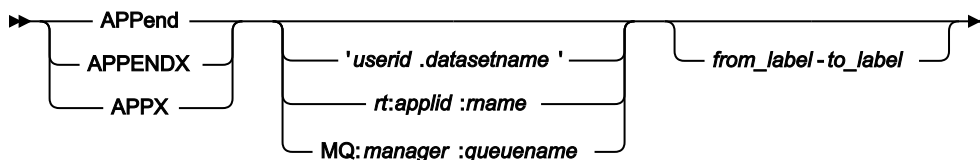

userid.datasetname

Name of fully-qualified data set to which lines of the data are to be appended.

rt:applid:rname

You can specify a CICS® resource in place of a data set name, where:

rt

Resource type. Valid values are:

FI

For a CICS® file.

TD

For a Transient Data Queue.

TS

For a Temporary Storage Queue.

applid

The VTAM® applid of the CICS® system.

rname

The name of the resource.

MQ:manager.queueName

You can specify a MQ queue, where:

manager

The MQ manager to be used. If you specify a generic name, File Manager displays a list of matching managers to select from.

queueName

The queue to be used. If you specify a generic name, File Manager displays a list of matching queues to select from.

from_label

Label indicating first line to be appended to the member or data set.

to_label

Label indicating last line to be appended to the member or data set.

Availability

- [Browse Entry panel on page 751](#)
- [Editor panel on page 853](#)

Related tasks and examples

- [Managing data sets on page 320](#)

ASSOCS primary command

The ASSOCS primary command displays the Association Information panel for the current data type.

Syntax

▶ ASsocs ▶

Availability

- [AIX Entry Detail panel on page 734](#)
- [Non-VSAM Entry Detail panel on page 957](#)
- [VSAM Entry Detail panel on page 1102](#)

Related tasks and examples

- [Viewing association information on page 423](#)

AUTORTRY primary command

The AUTORTRY primary command alters the current setting of the **Auto retry for CHANGE ALL** option.

This setting is usually set by means of the VSAM Edit sharing options from the options menu or options pulldown.

Syntax

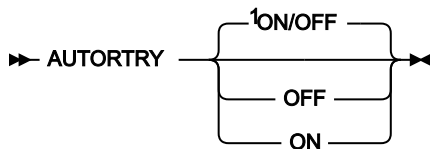

Notes:

- ¹ If no parameter is specified: if the current setting is ON, acts as if OFF as been specified; if the current setting is OFF, acts as if ON has been specified.

OFF

Disables the **Auto retry for CHANGE ALL** option.

ON

Enables the **Auto retry for CHANGE ALL** option.

Availability

- [Editor panel on page 853](#)

Related tasks and examples

- [Working with File Manager and shared files on page 132](#)

AUTOSAVE primary command

The AUTOSAVE primary command alters the current setting of the **Autosave frequency** option.

This setting is usually set via the VSAM Edit sharing options from the options menu or options pulldown.

Syntax

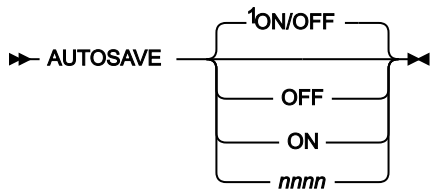

Notes:

¹ If no parameter is specified: if the current setting is ON (a value exists), acts as if OFF as been specified; if the current setting is OFF, acts as if ON has been specified.

OFF

Saves the value of the current **Autosave frequency** and then sets the frequency to zero, disabling the feature.

ON

Makes the previously used **Autosave frequency** (or the value 1 if no previous **Autosave frequency** value exists) the current **Autosave frequency**, enabling the feature.

nnnnn

Sets the current **Autosave frequency** to *nnnnn*. To disable the feature, specify the value 0. *nnnnn* can be in the range 0–999999.

Availability

- [Editor panel on page 853](#)

Related tasks and examples

- [Working with File Manager and shared files on page 132](#)

BOTTOM primary command

The BOTTOM primary command scrolls to the last page of data. You can use any abbreviation of the BOTTOM command, e.g. BOT or B.

Syntax

➔ Bottom ➔

Availability

Available on all panels when the panel information cannot be seen within one screen. In particular, it is used in the following panels, to allow you to view data:

- [Browse panel on page 746](#)
- [Editor panel on page 853](#)
- [WebSphere MQ Managers panel on page 1109](#)
- [WebSphere MQ Queue List panel on page 1116](#)
- [Template Member List panel on page 1064](#)

Related tasks and examples

- [Scrolling to see data on page 117](#)
- [Working with WebSphere MQ on page 439](#)

BOUNDS primary command

The BOUNDS primary command limits the columns searched by the CHANGE, FIND, and EXCLUDE commands. This command is only available in CHAR, HEX or LHEX display formats. It is not available at all when using a segmented record template.

Syntax

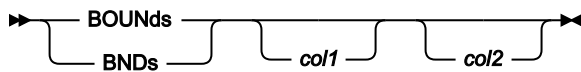

col1

The first column to be included in the range of columns to be searched. Must be greater than or equal to 1, and less than or equal to the maximum record length.

col2

The last column to be included in the range of columns to be searched. If specified, it must be greater than or equal *col1* and less than or equal to the maximum record length. When specified, all columns in the range defined by *col1* to *col2* are searched, inclusively. If not specified, it is assumed to be equal to *col1*, giving a range of one column to be searched.



Note: If neither *col1* nor *col2* are specified, the range is assumed to be from Column 1 to the end of the record. That is, issuing the BOUNDS command with no parameters resets the boundaries to the full record length.

If this command is used in the Find/Change utility and the **JCL source format** option has been selected, the columns searched are set to 3 through 71, unless the statement is not a JCL statement. A statement is considered to be a JCL statement if it begins with the strings `/*` or `//`. If the statement does not begin with either of these strings, it is not considered to be a JCL statement in which case any column range specified is honored.

Availability

- [Editor panel on page 853](#)

Related tasks and examples

- [Limiting the effect of editing changes on page 154](#)
- [Editing records within data sets on page 161](#)

CANCEL primary command

The CANCEL primary command (F12) quits the current panel without saving any changes to the data. In an Edit session, if you have entered changes to your data, you are asked to confirm that you want to discard those changes.



Note: Changes to data are only processed when you press Enter or issue a command. If you overwrite some data but do not press Enter or issue any other command before you attempt to CANCEL, you are not prompted to confirm the CANCEL action as the data change has not yet been flagged.

QUIT is a synonym for CANCEL.

If the function you were working in was a list in which multiple entries were selected, CANCELing from one of the selected entries halts the processing of other selections from that list.

Syntax

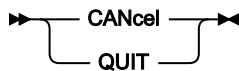

Availability

- Available on all panels.

Related tasks and examples

- [Ending an editor session on page 98](#)

CAPS primary command

The CAPS or CAPS ON commands instruct File Manager to convert fields or records to uppercase, when a subsequent data change takes place. The change affects either the field in which the change is entered or the entire record, depending upon the current display format:

- In CHAR, HEX or LHEX display format, the entire record is translated to uppercase.
- In SNGL or TABL display format, only the current field is translated to uppercase.

Any CAPS command overrides any previously entered CASE command, and any CASE command overrides any previously entered CAPS command.

Syntax**ON**

Turns the "convert to uppercase" feature on. Equivalent to issuing the CAPS command without parameters or to issuing the CASE UPPER command.

OFF

Turns the "convert to uppercase" feature off, so that subsequent changes to data do not cause the record or field to be translated to uppercase. Equivalent to the CASE or CASE MIXED commands.

Availability

- [Editor panel on page 853](#)

Related tasks and examples

- [Changing the case of data on page 147](#)

CASE primary command

The CASE command determines whether, when a subsequent data change takes place, fields or records are translated to uppercase (CASE UPPER), or they are left unchanged (CASE MIXED).

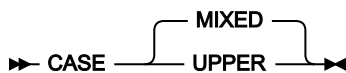
Syntax**UPPER**

Translates all new records from lowercase to uppercase, and translates all data in changed records from lowercase to uppercase, regardless of how the records are changed. When the data is displayed in CHAR, HEX, or LHEX mode CASE UPPER affects all changed records, including records displayed on the screen which were changed before the CASE UPPER command is entered.

MIXED

Turns the "convert to uppercase" feature off, so that subsequent changes to data do not cause the record or field to be translated to uppercase. Equivalent to issuing the CASE command without a parameter or to issuing the CAPS OFF command.

Availability

- [Editor panel on page 853](#)

Related tasks and examples

- [Changing the case of data on page 147](#)

CCSID primary command

In an editor session, the CCSID command toggles on and off the display of the CCSID assigned to each field, if applicable, when using SNGL display format.

Syntax

➤ CCSID ➤

Availability

- [Browse panel on page 746](#)
- [Editor panel on page 853](#)

Related tasks and examples

- [Selecting a display format on page 105](#)

CE (Change Error) primary command

The CE (Change Error) primary command allows you to change numeric fields flagged as being in error (all asterisks in the field display) to a specific numeric value.

The find argument for the CE command is assumed to be a numeric field in error.

The CE command is only valid in SNGL or TABL display formats, when in edit or view.

For details on limiting the columns, fields or records searched by the CE command, see [Limiting the effect of editing changes on page 154](#).

Syntax

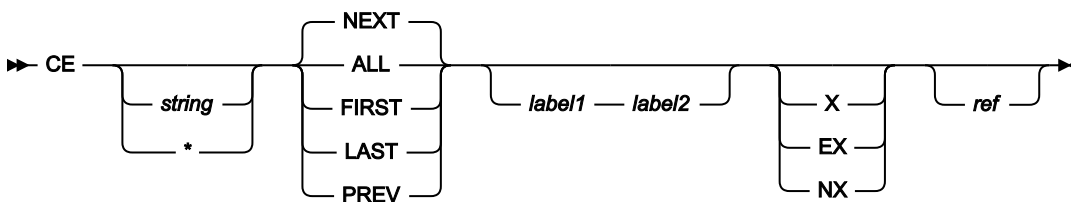

string

A numeric value used to replace the invalid numeric value.

*** (asterisk)**

When used in place of the replacement string, uses the replacement string specified on the previous CE or CHANGE command as the replacement string. CE with no parameters, following a CE or CHANGE with a replacement string, acts the same as `CE *`.

ALL

Searches forwards from the top of data. Same as FIRST except that ALL also displays the total number of invalid numeric fields in the records searched.



Note: Suppressed or not-selected records that are hidden from display or represented by shadow lines are not searched, even when you specify ALL.

FIRST

Searches from the top of data for the first occurrence of an invalid numeric field.

LAST

Searches backwards from the bottom of the data for the last occurrence of an invalid numeric field.

NEXT

Searches forwards from the cursor position (if the cursor is within the data portion of the screen), or from the beginning of the topmost record displayed on the screen, for the next occurrence of an invalid numeric field.

If the next occurrence of the string is in an excluded record and you do not limit the search to not-excluded records, only the first excluded record containing the string is shown.

PREV

Searches backwards from the cursor position (if the cursor is within the data portion of the screen), or from the beginning of the topmost record displayed on the screen, for the next occurrence of an invalid numeric field.

label1

Label identifying the start of a range of records. The label must start with a period (.) followed by one to four alphabetic characters (no numeric or special characters). Labels starting with the letter "Z" indicate an editor-assigned label.

label2

Label identifying the end of a range of records. The label must start with a period (.) followed by one to four alphabetic characters (no numeric or special characters). Labels starting with the letter "Z" indicate an editor-assigned label.

EX

Excluded records only.

NX

Not-excluded records only.

X

Same as EX.

ref

A field reference, specifying the field to be included in the search. For example: #3.

Availability

- [Editor panel on page 853](#)

Related tasks and examples

- [Changing invalid numeric fields in your data on page 153](#)

CEDIT primary command

The CEDIT command displays the template editing panel that is appropriate for the current template type. It is synonymous with the DEDIT command.

Syntax

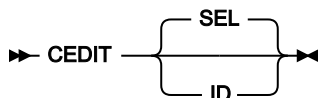

SEL

Default. Displays the Record Selection Criteria panel or the Dynamic Template panel, as appropriate for the current template.

If you are currently using a dynamic template, the CEDIT or CEDIT SEL (or DEDIT) command displays the Dynamic Template panel, where you can select and edit the existing fields in the template, create new fields and enter record selection criteria by field, before returning to viewing the data set with the updated template.

If you are using a template that was generated from a copybook, the CEDIT or CEDIT SEL (or DEDIT) command displays the Record Selection Criteria panel, where you can enter criteria by field, before returning to viewing the data set with the updated template.

ID

Displays the Record Identification Criteria panel for the currently selected Record Type in a copybook template.

If the copybook contains multiple record types and no record type selection has yet been defined, this is the first record type described in the copybook.

If the current template is dynamic, this parameter is invalid.

If you are not using a template, the CEDIT, CEDIT SEL or CEDIT ID (or DEDIT) command displays the Dynamic Template panel, where you can create and select fields in a new dynamic template and enter record selection criteria by fields.

Availability

- [Viewing and changing data sets on page 87](#)

Related tasks and examples

- [Creating dynamic templates on page 214](#)
- [Editing a template on page 218](#)

CHANGE/CX primary command

The CHANGE command finds and replaces occurrences of a string or value. It can be entered in an Edit session or when using the Find/Change Utility, by using any abbreviation of the command (for example, C, CH, CHG).

For date and time fields that are displayed using the output format defined in the template, File Manager searches the displayed values for *string1* and if found replaces *string1* with *string2* in the displayed value.

The CX command displays an Extended Command Entry panel, in which you can enter long arguments that may not otherwise fit within the Command line (see [Handling long strings in CHANGE on page 152](#)).



Note:

1. When you enter the CHANGE primary command in the Editor without specifying any parameters, File Manager displays the Extended Command Entry pop-up panel to allow you to enter arguments.
2. If you use the CNot version of the command, then a string is matched if it does not match according to the matching criteria described in this section.

Syntax

CHANGE primary command in the Editor

In an Edit session, the CHANGE primary command finds and replaces one or more occurrences of a character string within the currently displayed data set or data set member. In SNGL or TABL display format, you can also use the CHANGE command to find and replace a numeric value in numeric fields.



Note: When you enter the CHANGE primary command in the Editor without specifying any parameters, File Manager displays the Extended Command Entry pop-up panel to allow you to enter arguments.

Figure 371. Syntax in the Editor

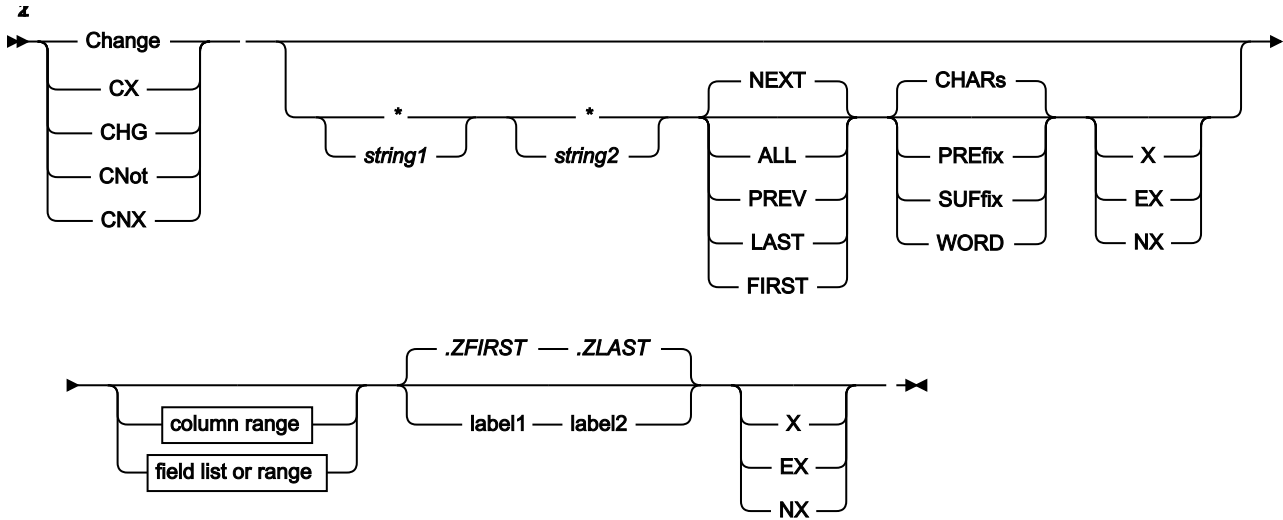

column range (all display formats)

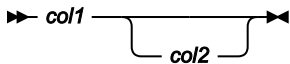

field list or range (SNGL or TABL display format)

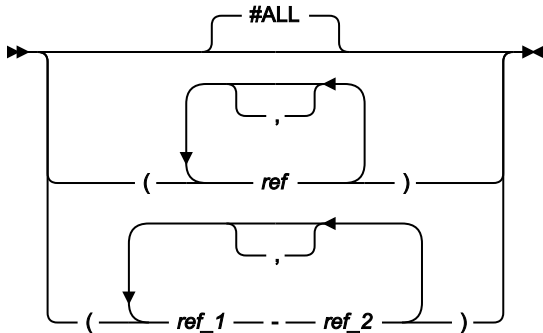

Notes:

¹ You can specify parameters in any order.

² If none of these parameters (X, EX or NX) is specified, then both excluded and not-excluded records are searched.

CHANGE primary command in the Find/Change Utility

In the FCH utility, the CHANGE primary command finds and replaces all occurrences of the specified string in the selected members or data set.

Figure 372. Syntax in the Find/Change Utility

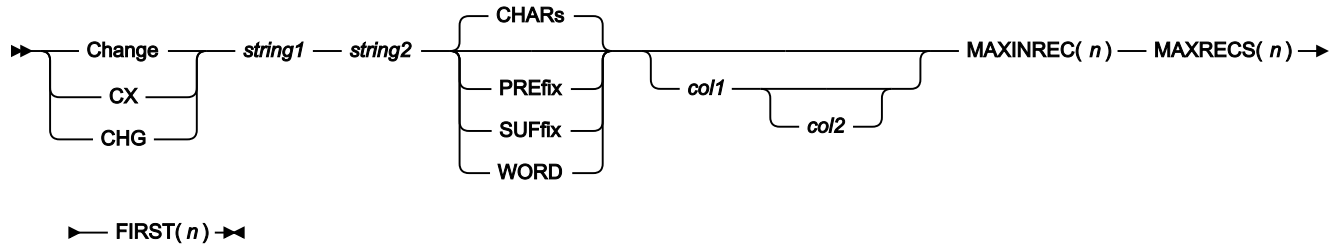

Change, CX

The CHANGE command or any of its abbreviations is entered on the Command line, together with the desired parameters. To find and replace long strings that do not fit on the Command line, enter the CHANGE primary command (or one of its abbreviations, such as C) with no parameters, or enter the CX command on the Command line with no parameters. This displays the Extended Command Entry panel, in which you can enter long strings and the CHANGE command parameters.

* (asterisk)

When used in place of the search string, uses the search string specified on the previous CHANGE command as the search string.

When used in place of the replacement string, uses the replacement string specified on the previous CHANGE command as the replacement string.

The position of the * is important for CHANGE. If it is positioned before a string, it indicates the previous search argument; that is, it is treated as the first string. If a string is found prior to the *, then it is treated as the second string (the change argument), taking the change argument from the previous CHANGE command. To use both the previous search string and the previous change string, specify `CHANGE * *`.

string1

The string you want to search for, which must be no more than 100 characters long. The string can be:

- A character string not starting or ending with a quotation mark and not containing any embedded blanks or commas. The case of the string is ignored. Uppercase and lowercase representations of the same character match. For example, the following command changes the strings `black`, `Black`, and `BLACK`:

```
CHANGE black white
```

- A character string enclosed in quotation marks. The string can contain blanks and commas. The case of the string is ignored. For example, `'Exact string'` matches `'exact string'`. The string can be a null string (`' '`). If `string1` is a null string, then `string2` is inserted at the current column position.
- C followed by a character string enclosed in quotation marks (`C'Frog'`), or a character string enclosed in quotation marks followed by `c` (`'Frog'C`). The string can contain blanks and commas. The string must match exactly (including case). For example, `C'Exact string'` does not match `C'exact string'`. The

string can be a null string (`''`). If *string1* is a null string, then *string2* is inserted at the current column position.

- A DBCS string or a mixed DBCS and non-DBCS string. A shift-out (X'OE') as the first character, or a shift-in (X'OF') as the last character, are discarded as part of the search string.
- P preceded or followed by a picture string enclosed in single or double quotation marks to describe a type of string to be found rather than the exact characters. It can contain blanks, alphabetic and numeric characters which represent themselves, or any of the special characters listed here, each of which represents a class of characters:

=

Any character.

@

Alphabetic characters.

#

Numeric characters.

\$

Special characters.

& notsym;

Non-blank characters.

.

Invalid characters.

-

Non-numeric characters.

<

Lowercase alphabets.

>

Uppercase alphabets.

When this notation is used, numeric, bit and Unicode fields (for SNGL and TABL display formats) are excluded from the search process.

- X followed by a hexadecimal string enclosed in quotation marks (X'C1C2'), or a hexadecimal string enclosed in quotation marks followed by `x` ('C1C2X').
- A numeric value (only when, in SNGL or TABL display format, you limit the search by specifying field references, and only when the field being searched is a numeric field). For details, see [Searching numeric fields on page 126](#).

string2

The string that you want to use to replace *string1*, which must be no more than 100 characters long. The string can be:

- A character string not starting or ending with a quotation mark and not containing any embedded blanks or commas. If CAPS ON or CASE UPPER is in effect, then *string2* is translated to uppercase.
- A character string enclosed in quotation marks. The string can contain blanks and commas. If CAPS ON or CASE UPPER is in effect, then *string2* is translated to uppercase. The string can be a null string (`' '`).
- C followed by a character string enclosed in quotation marks (C'Frog'), or a character string enclosed in quotation marks followed by c ('Frog'C). The string can contain blanks and commas. Case is respected and retained. The string can be a null string (`c''`).
- A DBCS or a mixed DBCS and non-DBCS string. The shift-out (X'0E') and shift-in (X'0F') at the start and end of the string are adjusted in such a way that the integrity of the DBCS data is not compromised.
- P preceded or followed by a picture string enclosed in single or double quotation marks to describe the change to be made. You can change characters from uppercase to lowercase or from lowercase to uppercase, or leave the field the same using these string special characters.

=

Any character.

<

Lowercase alphabets.

>

Uppercase alphabets.

Examples of picture strings used with the CHANGE command:

```
c p'. ' x'00'
```

Change next invalid character to hex x'00'.

```
c p'###' 100
```

Change next 3-digit number to 100.

```
c all 73 80 p'=' " "
```

Put blanks in columns 73 to 80.

```
c all p'-' 1 10 "0"
```

Change all non-numeric characters in columns 1 to 10 into the char "0".

```
c p'<' p'>'
```

Change any lowercase to uppercase.

```
c p'a>' p'=<'
```

Change char a, any uppercase to char a, lowercase.

```
c p'>' 'r'
```

Change any uppercase to "not sign" (note: "not sign" has no special meaning in a "to" string).

```
c p'<#' p'>='
```

Change any lowercase, any number to uppercase, the number found.

When this notation is used, numeric, bit and Unicode fields (for SNGL and TABL display formats) are excluded from the search process.

- X followed by a hexadecimal string enclosed in quotation marks (X'C1C2'), or a hexadecimal string enclosed in quotation marks followed by x ('C1C2'X). Case is respected and retained (the hexadecimal values are used exactly as specified).
- A numeric value (SNGL and TABL display formats only).

col1

The first column to be included in the range of columns to be searched. Must be greater than or equal to 1, and less than or equal to the maximum record length. When column ranges are specified and the data is displayed in SNGL or TABL formats, the search is performed in the order that the data occurs, which may not be the order in which the fields are displayed.

When column ranges are specified in SNGL or TABL display format, then a string comparison is performed, even for numeric fields.



Note: When you use the CHANGE primary command in the Find/Change Utility, if the **JCL Source format** option is selected, the columns searched are set to 3 through 71, unless the statement is not a JCL statement. A statement is considered to be a JCL statement if it begins with the strings "/"* or "/"". If the statement does not begin with either of these strings, it is not considered to be a JCL statement in which case any column range specified on the FIND (or CHANGE, respectively) command or preset using the BOUNDS command is honored. If no column range has been specified, the full record is searched.

ALL

(Applies in the Editor only.) Causes the search to begin at the top of the data and find and replace all occurrences of the string.



Note:



1. Suppressed or not-selected records that are hidden from display or represented by shadow lines are not processed by the CHANGE command, even when the ALL parameter is specified.
2. The ALL parameter is not recursive when used with the CHANGE command. That is, applying the command CHANGE ALL 'SS' 'RS' to the string 'SSS' results in 'RSS', not in 'RRS'.

FIRST

(Applies in the Editor only.) Searches from the top of data for the first occurrence of *string*.

LAST

(Applies in the Editor only.) Searches backwards from the bottom of data for the last occurrence of *string*.

NEXT

(Applies in the Editor only.) Causes the search to begin at the cursor location (if the cursor is within the data portion of the screen) or the beginning of the first record displayed, and searches ahead to find the next occurrence of the string. If the next occurrence of the string is in an excluded record and you do not limit the search to not-excluded records, only the first excluded record containing the string is shown.

PREV

(Applies in the Editor only.) Searches backwards from the cursor position (if the cursor is within the data portion of the screen), or from the beginning of the topmost record displayed on the screen, for the next occurrence of *string*.

CHARS

Matches the search string anywhere in the data.

PREFIX

Matches the search string wherever it appears as a prefix in the data. To be a prefix, the matched text must be preceded by a non-alphanumeric character or be the start of a line or field, and must be followed by an alphanumeric character.

SUFFIX

Matches the search string wherever it appears as a suffix in the data. To be a suffix, the matched text must be preceded by an alphanumeric character, and must be followed by a non-alphanumeric character or be the end of a line or field.

WORD

Matches the search string wherever it appears as a word in the data. To be a word, the matched text must be preceded by a non-alphanumeric character or be the start of a line or field, and must be followed by a non-alphanumeric character or be the end of a line or field.

col2

The last column to be included in the range of columns to be searched. Must be greater than or equal to *col1* and less than or equal to the maximum record length. If not specified, the string is matched with data starting in the *col1* location for the length of the string.

#ALL

Each field is searched according to its template attributes.

ref

(Applies in the Editor only.) A field reference, specifying the field to be included in the search, for example: #3. When the field is an item in an array, you must specify a subscript in parentheses to identify the occurrence that you want to change, for example: #5(3). If your field is part of a multi-dimensional array, you must specify a subscript for each dimension in the array, for example: #7(2,3).

Multiple field references must either be enclosed in parentheses, or separated with commas but without any intervening spaces. For details, see [Limiting the search to specified fields on page 156](#).

In SNGL or TABL display format, if you specify field references or do not specify a field reference or column range, when searching a numeric field, the search string is interpreted as a numeric value, and a numeric comparison is performed. When searching a character field, a string comparison is performed. That is, the search is performed based on the File Manager template attributes. For details, see [Searching numeric fields on page 126](#).

ref_1

The first field reference of a range of fields. It cannot be subscripted. If the *ref_1* field reference value is less than the lowest displayed field reference value, the lowest displayed field reference value is used.

ref_2

The last field reference of a range of fields. It cannot be subscripted. If the *ref_2* field reference value is greater than the highest displayed field reference value, the highest displayed field reference value is used.

The *ref_1* and *ref_2* field reference values must be separated by a hyphen (-). Spaces are permitted between the hyphen and the field reference values.

If *ref_1* is a higher value than *ref_2*, the search process reverses the operands.

EX

(Applies in the Editor only.) Excluded records only.

label1

(Applies in the Editor only.) Label identifying the start of a range of records. The label must start with a period (.) followed by one to four alphabetic characters (no numeric or special characters). Labels starting with the letter "Z" indicate an editor-assigned label.

label2

(Applies in the Editor only.) Label identifying the end of a range of records. The label must start with a period (.) followed by one to four alphabetic characters (no numeric or special characters). Labels starting with the letter "Z" indicate an editor-assigned label.

NX

(Applies in the Editor only.) not-excluded records only.

X

(Applies in the Editor only.) Same as EX.

MAXINREC(*n*)

(Applies in the FCH Utility only.) The MAXINREC parameter allows you to specify the maximum number of **changes** that can be made within a **single record**.

MAXRECS(*n*)

(Applies in the FCH Utility only.) The MAXRECS parameter allows you to specify the maximum number of **records** that can be changed within a **single data set or PDS member**.

FIRST(*n*)

(Applies in the FCH Utility only.) The FIRST parameter allows you to specify the maximum number of **total changes** that can be performed within a **single data set or PDS member**.

Availability

- [Editor panel on page 853](#)
- [Find/Change Utility panel on page 901](#)

Related tasks and examples

- [Finding and replacing strings on page 149](#)
- [Finding and changing data in multiple PDS members on page 368](#)
- [Handling long strings in CHANGE on page 152](#)
- [Using File Manager functions in batch jobs on page 508](#)
- [Working with files or members containing JCL on page 378](#)

CHGASAVE primary command

The CHGASAVE primary command alters the current setting of the **CHANGE ALL autosave frequency** option.

This setting is usually set by means of the VSAM Edit sharing options from the options menu or options pulldown.

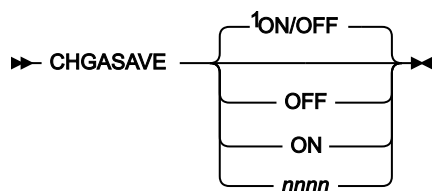
Syntax

Notes:

¹ If no parameter is specified: if the current setting is ON (a value exists), acts as if OFF as been specified; if the current setting is OFF, acts as if ON has been specified.

OFF

Saves the value of the current **CHANGE ALL autosave frequency** and then sets the frequency to zero, disabling the feature.

ON

Makes the previously used **CHANGE ALL autosave frequency** (or the value 1 if no previous **CHANGE ALL autosave frequency** value exists) the current **CHANGE ALL autosave frequency**, enabling the feature.

nnnnnn

Sets the current **CHANGE ALL autosave frequency** to *nnnnnn*. To disable the feature, specify the value 0. *nnnnnn* can be in the range 0–999999.

Availability

- [Editor panel on page 853](#)

Related tasks and examples

- [Working with File Manager and shared files on page 132](#)

COPY primary command

The COPY command copies one or more lines of data from a data set or member of a partitioned data set (PDS) into the member or data set currently being edited or viewed. Use the A (after) or B (before) line commands or the AFTER or BEFORE keyword along with a label, to specify where the data is to be copied.

You can optionally specify the data set details from which the data is to be copied. If you do not specify these details, File Manager displays the Edit/View - Copy panel where you can enter the data set details from which the data is to be copied.

Syntax

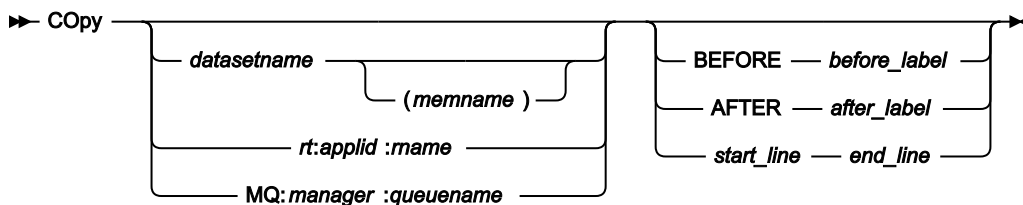

datasetname

Name of data set from which data is to be copied. The default High Level Qualifier (HLQ) is used. Typically, the default is the TSO PREFIX for your user ID.

memname

Name of member from which data is to be copied.

rt.applid.rname

You can specify a CICS® resource in place of a data set name, where:

rt

Resource type. Valid values are:

FI

For a CICS® file.

TD

For a Transient Data Queue.

TS

For a Temporary Storage Queue.

applid

The VTAM® applid of the CICS® system.

rname

The name of the resource.

MQ:manager.queueName

You can specify a MQ queue, where:

manager

The MQ manager to be used. If you specify a generic name, File Manager displays a list of matching managers to select from.

queueName

The queue to be used. If you specify a generic name, File Manager displays a list of matching queues to select from.

before_label

Label identifying the start of a range of records from which data is to be copied. The label must start with a period (.) followed by one to four alphabetic characters (no numeric or special characters). Labels starting with the letter "Z" indicate an editor-assigned label.

after_label

Label identifying the end of a range of records from which data is to be copied. The label must start with a period (.) followed by one to four alphabetic characters (no numeric or special characters). Labels starting with the letter "Z" indicate an editor-assigned label.

start_line

Number identifying the line number of the first line of data in the data set or member from which data is to be copied.

end_line

Number identifying the line number of the last line of data in the data set or member from which data is to be copied.

Availability

- [Browse Entry panel on page 751](#)
- [Editor panel on page 853](#)

Related tasks and examples

- [Copying data from another data set on page 169](#)

CUT primary command

The CUT command copies one or more lines of data from the current edit or view session into a clipboard for later retrieval by the PASTE command.

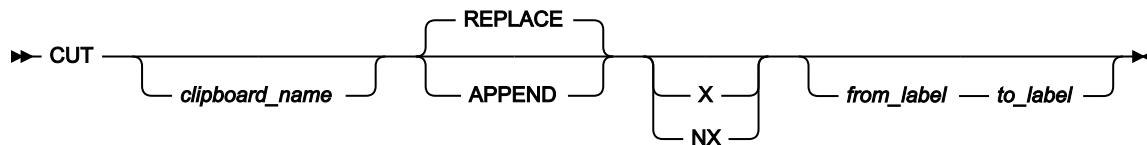
Syntax**clipname**

Name of a clipboard to which data is to be copied. The default High Level Qualifier (HLQ) is used. Typically, the default is the TSO PREFIX for your user ID.

APPEND

Copied data is added to the existing contents of the clipboard.

REPLACE

Copied data replaces the existing contents of the clipboard.

NX

Copy only not-excluded records.

X

Copy only excluded records.

from_label

Label identifying the start of a range of records from which data is to be copied to the clipboard. The label must start with a period (.) followed by one to four alphabetic characters (no numeric or special characters). Labels starting with the letter "Z" indicate an editor-assigned label.

to_label

Label identifying the end of a range of records from which data is to be copied to the clipboard. The label must start with a period (.) followed by one to four alphabetic characters (no numeric or special characters). Labels starting with the letter "Z" indicate an editor-assigned label.

Availability

- [Browse Entry panel on page 751](#)
- [Editor panel on page 853](#)

Related tasks and examples

- [Copying data to and from a clipboard on page 167](#)

CREATE, CREATEX primary commands

The CREATE and CREATEX primary commands create another member or data set from specified lines of the data in the current editor session.

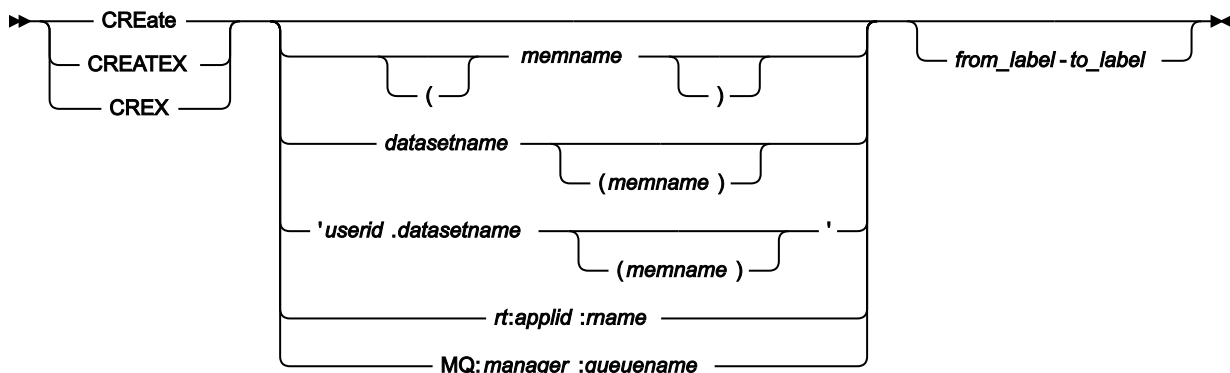
Syntax**memname**

Name of member to be created.

datasetname

Name of data set to be created. The default High Level Qualifier (HLQ) is used. Typically, the default is the TSO PREFIX for your user ID.

userid.datasetname

Name of fully-qualified data set to be created.

rt:applid:rname

You can specify a CICS® Transient Data Queue or CICS® Temporary Storage Queue in place of a data set name, where:

rt

Resource type. Valid values are:

TD

For a Transient Data Queue.

TS

For a Temporary Storage Queue.

applid

The VTAM® applid of the CICS® system.

rname

The name of the resource.

MQ:manager.queueName

You can specify a MQ queue, where:

manager

The MQ manager to be used. If you specify a generic name, File Manager displays a list of matching managers to select from.

queueName

The queue to be used. If you specify a generic name, File Manager displays a list of matching queues to select from.

from_label

Label indicating first line to be copied into the new member or data set.

to_label

Label indicating last line to be copied into the new member or data set.

Availability

- [Browse Entry panel on page 751](#)
- [Editor panel on page 853](#)

Related tasks and examples

- [Managing data sets on page 320](#)

DEDIT primary command

The DEDIT command displays the template editing panel that is appropriate for the current template type. It is synonymous with the CEDIT SEL command.

Syntax

►► DEdit ◄◄

If you are currently using a dynamic template, the DEDIT (or CEDIT or CEDIT SEL) command displays the Dynamic Template panel, where you can select and edit the existing fields in the template, create new fields and enter record selection criteria by field, before returning to viewing the data set with the updated template.

If you are using a template that was generated from a copybook, the DEDIT (or CEDIT or CEDIT SEL) command displays the Record Selection Criteria panel, where you can enter criteria by field, before returning to viewing the data set with the updated template.

If you are not using a template, the DEDIT command displays the Dynamic Template panel, where you can create and select fields in a new dynamic template and enter record selection criteria by fields.

You can abbreviate the command DEDIT to DE.

Availability

- [Viewing and changing data sets on page 87](#)

Related tasks and examples

- [Creating dynamic templates on page 214](#)
- [Editing a template on page 218](#)

DELETE (members) primary command

In the PDSE Workbench Member List, Template Member List, and History Selection panels, the DELETE command deletes members including member generations.

Syntax

►► DELete ◄◄

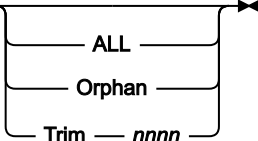

ALL

Delete all members that match the member name filter, and any related aliases. Aliases are not deleted unless the primary member name also matches the member name filter.

Orphan

Delete all orphaned members that match the member name filter. Orphan members are member generations without a current member. A current member is generation 0.

Trim

Retain up to the number of generations specified by *nnnn*. All other member generations that match the member name filter are deleted. This also applies to orphaned member generations and member generations that are not displayed because they exceed the generation limit.

nnnn must be in the range 0 to 2000000000.

If no keywords are entered the DELETE command displays a pop-up panel to allow the required option to be selected.

Availability

- [PDSE Workbench Member List panel on page 961](#)
- [History Selection panel on page 911](#)
- [Template Member List panel on page 1064](#)

Related tasks and examples

DELETE (records) primary command

When editing a data set or data set member, the DELETE primary command deletes records.

Syntax

Figure 373. Syntax (CHAR, HEX, LHEX or TABL display format)

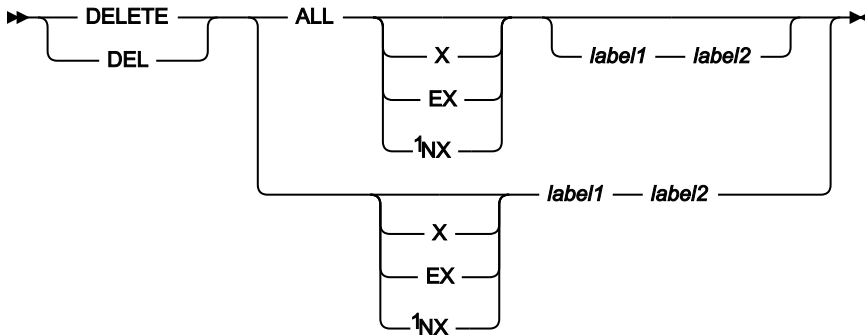

Notes:

¹ If none of these parameters (X, EX or NX) is specified, then the DELETE command applies to both excluded and not-excluded records.

In SNGL display format, DELETE deletes the current record.

Figure 374. Syntax (SNGL display format)



ALL

Causes the DELETE command to delete all records (or all excluded or not-excluded records) within the specified range of records (or within the entire data set, if you do not specify a range).

If you do not specify the ALL parameter, then the DELETE command deletes only the first record (or only the first excluded or not-excluded record) within the specified range.



Note: Suppressed or not-selected records that are hidden from display or represented by shadow lines are not affected by the DELETE command, even when the ALL parameter is specified.

EX

Excluded records only.

label1

Label identifying the start of a range of records. The label must start with a period (.) followed by one to four alphabetic characters (no numeric or special characters). Labels starting with the letter "Z" indicate an editor-assigned label.

label2

Label identifying the end of a range of records. The label must start with a period (.) followed by one to four alphabetic characters (no numeric or special characters). Labels starting with the letter "Z" indicate an editor-assigned label.

NX

Not-excluded records only.

X

Same as EX.

Availability

- [Editor panel on page 853](#)

Related tasks and examples

- [Deleting records on page 162](#)

DESCRIBE primary command

Shows information about a template, including the member name of the source copybook, the name of the template data set (and member name, if a PDS), and the description of the template. You can update the description text.

Syntax

►► DEScribe ◀◀

Availability

- [Record Type Selection panel on page 998](#)
- [Field Selection/Edit panel on page 891](#)

Related tasks and examples

DOWN primary command

The DOWN primary command scrolls down (forward) through your data. The amount (number of lines) scrolled is determined by either an optional parameter or, if no parameter is entered, by the amount indicated in the **Scroll field**.

Syntax

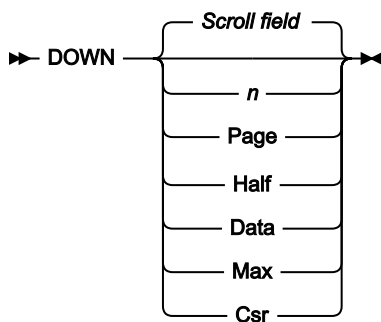

nnnn

Scroll down *nnnn* lines.

Csr

Scroll down to the cursor position.

Data

Scroll down one line less than a page of data.

Half

Scroll down half a page of data.

Max

Scroll to bottom of file. This has the same effect as the BOTTOM command.

Page

Scroll down one page of data.

Scroll field

Scroll down by the amount indicated in the **Scroll field**. This is the default if no parameter is used.

Availability

Available on all panels when the panel information cannot be seen within one screen. In particular, it is used in the following panels, to allow you to view data:

- [Browse panel on page 746](#)
- [Editor panel on page 853](#)
- [WebSphere MQ Managers panel on page 1109](#)
- [WebSphere MQ Queue List panel on page 1116](#)
- [Template Member List panel on page 1064](#)

Related tasks and examples

- [Scrolling to see data on page 117](#)
- [Working with WebSphere MQ on page 439](#)

DX primary command

The DX command converts a decimal value to its equivalent hexadecimal value.

Syntax

▶▶ DX — *decimal_value* ▶▶

Availability

This command can be entered on any File Manager panel.

Related tasks and examples

[Using hexadecimal values in File Manager on page 73](#)

EDIT primary command

The EDIT primary command edits the template built from the specified copybooks. If changes have been made, a compile and update is performed.

Syntax

▶▶ EDIT ▶▶

Availability

- [Copybook Selection panel on page 810](#)

Related tasks and examples

- [Advanced copybook selection on page 208](#)

END primary command

The END primary command exits from the current panel and stores any editing changes made to data in memory and any changes made to panel values (such as the names of data sets or selected options) in your ISPF profile. Where exiting the current panel completes the editing of a data set, the END command also saves the changes to file. For example, using the END command in the Edit panel saves any changes to file; using END on a “nested” template editing panel, such as the Field Attributes panel, stores changes in memory (these changes are not written to file until you end the entire template editing session).

In an Edit session, the END command is synonymous with the EXIT and FILE commands.

Syntax

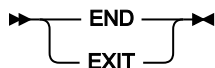

Availability

Available on all panels.

Related tasks and examples

- [Ending an editor session on page 98](#)

EXCLUDE/XX primary command

The EXCLUDE primary command excludes records from display in an editor session. (Not available in SNGL display format.)

The XX command displays an Extended Command Entry panel, in which you can enter long arguments that may not otherwise fit within the Command line.

EXCLUDE commands are cumulative; each successive EXCLUDE command increases the number of records already excluded.

To “unexclude” (redisplay) excluded records, use the RESET EXCLUDED primary command (see [RESET primary command on page 1208](#)) or the F or LA prefix commands (see [Editor panel on page 853](#)). If you used a search string to exclude the records then, when you unexclude the records, the search string is highlighted; to remove this highlighting, enter the RESET FIND command.



Note: When you enter the EXCLUDE primary command in the Editor without specifying any parameters, File Manager displays the Extended Command Entry pop-up panel to allow you to enter arguments.

Syntax

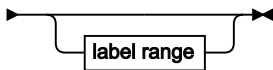
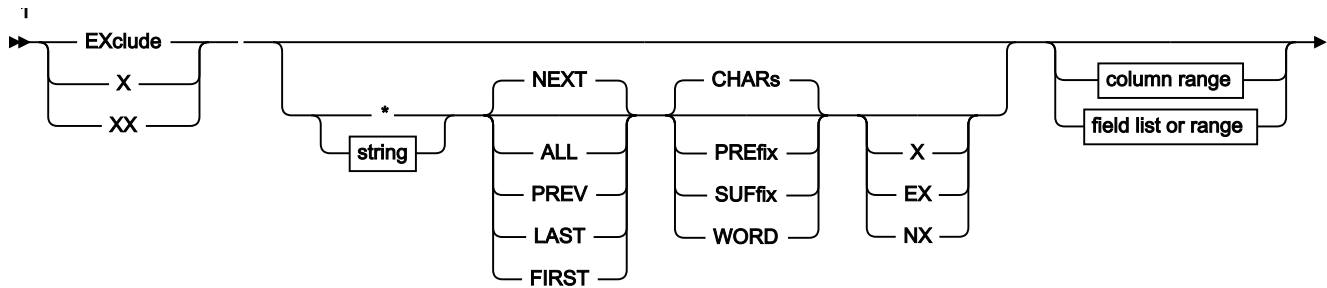

column range (all display formats)

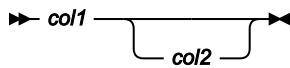

field list or range (SNGL or TABL display format)

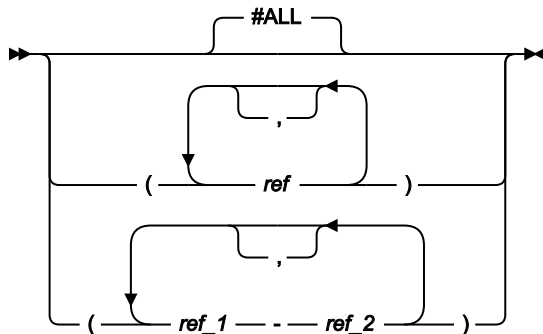

label range (Edit only)

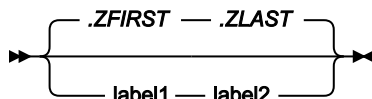

Notes:

¹ You can specify parameters in any order.

* (asterisk)

Uses the search string specified on the previous EXCLUDE command as the search string.

string

The search string you want to search for. Records containing this string, within the limits imposed by the other EXCLUDE command parameters, are excluded. The string can be:

- A character string not starting or ending with a quotation mark and not containing any embedded blanks or commas. The case of the string is ignored. Uppercase and lowercase representations of the same character match. For example, `Mixed` matches `MIXED`.
- A character string enclosed in quotation marks. The string can contain blanks and commas. The case of the string is ignored. For example, `'Exact string'` matches `'exact string'`.
- C followed by a character string enclosed in quotation marks (`C'Frog'`), or a character string enclosed in quotation marks followed by `c` (`'Frog'C`). The string can contain blanks and commas. The string must match exactly (including case). For example, `C'Exact string'` does not match `C'exact string'`.
- P preceded or followed by a picture string enclosed in single or double quotation marks to describe a type of string to be found rather than the exact characters. It can contain blanks, alphabetic and numeric characters which represent themselves, or any of the special characters listed here, each of which represents a class of characters:

=

Any character.

@

Alphabetic characters.

#

Numeric characters.

\$

Special characters.

& notsym;

Non-blank characters.

.

Invalid characters.

-

Non-numeric characters.

<

Lowercase alphabetic.

>

Uppercase alphabetic.

Examples of picture strings used with the EXCLUDE command:

```
ex p'. ' 73 80
```

Exclude invalid characters in columns 73 to 80.

```
ex p'###'
```

Exclude 3-digit number (for example, 101 but not 99).

```
ex '@1'p 1
```

Exclude label a1,b1,c1, (and so on) in column 1.

```
ex p'<'
```

Exclude the next lowercase alphabetic character.

```
ex p'~' 72
```

Exclude the next non-blank character in column 72.

When this notation is used, numeric, bit and Unicode fields (for SNGL and TABL display formats) are excluded from the search process.

- X followed by a hexadecimal string enclosed in quotation marks (X'C1C2'), or a hexadecimal string enclosed in quotation marks followed by x ('C1C2'X).
- A numeric value (only when, in SNGL or TABL display format, you limit the search by specifying field references, and only when the field being searched is a numeric field). For details, see [Searching numeric fields on page 126](#).

ALL

Searches all records from the top of data to the bottom.



Note:

1. The EXCLUDE command does not affect suppressed or not-selected records that are hidden from display or represented by shadow lines, even when you specify the ALL parameter.
2. The command EXCLUDE ALL (with no other parameters) excludes all displayed records.

FIRST

Searches from the top of data for the first occurrence of *string*.

LAST

Searches backwards from the bottom of data for the last occurrence of *string*.

NEXT

Searches forwards from the cursor position (if the cursor is within the data portion of the screen), or from the beginning of the topmost record displayed on the screen, for the next occurrence of *string* in a record that is not already excluded.

PREV

Searches backwards from the cursor position (if the cursor is within the data portion of the screen), or from the beginning of the topmost record displayed on the screen, for the next occurrence of *string*.

PREFIX

Matches the search string wherever it appears as a prefix in the data. To be a prefix, the matched text must be preceded by a non-alphanumeric character or be the start of a line or field, and must be followed by an alphanumeric character.

SUFFIX

Matches the search string wherever it appears as a suffix in the data. To be a suffix, the matched text must be preceded by an alphanumeric character, and must be followed by a non-alphanumeric character or be the end of a line or field.

WORD

Matches the search string wherever it appears as a word in the data. To be a word, the matched text must be preceded by a non-alphanumeric character or be the start of a line or field, and must be followed by a non-alphanumeric character or be the end of a line or field.

col1

The first column to be included in the range of columns to be searched. Must be greater than or equal to 1, and less than or equal to the maximum record length. When column ranges are specified and the data is displayed in SNGL or TABL formats, the search is performed in the order that the data occurs, which may not be the order in which the fields are displayed.

When column ranges are specified in SNGL or TABL display format, then a string comparison is performed, even for numeric fields.

col2

The last column to be included in the range of columns to be searched. Must be greater than or equal to *col1* and less than or equal to the maximum record length. If not specified, the string is matched with data starting in the *col1* location for the length of the string.

#ALL

Each field is searched according to its template attributes.

ref

A field reference, specifying the field to be included in the search, for example: #3. When the field is an item in an array, you must specify a subscript in parentheses to identify the occurrence that you want to use, for example: #5(3). If your field is part of a multi-dimensional array, you must specify a subscript for each dimension in the array, for example: #7(2,3).

Multiple field references must either be enclosed in parentheses, or separated with commas but without any intervening spaces. For details, see [Limiting the search to specified fields on page 156](#).

In SNGL or TABL display format, if you specify field references or do not specify a field reference or column range, when searching a numeric field, the search string is interpreted as a numeric value, and a numeric comparison is performed. When searching a character field, a string comparison is performed. That is, the search is performed based on the File Manager template attributes. For details, see [Searching numeric fields on page 126](#).

ref_1

The first field reference of a range of fields. It cannot be subscripted. If the *ref_1* field reference value is less than the lowest displayed field reference value, the lowest displayed field reference value is used.

ref_2

The last field reference of a range of fields. It cannot be subscripted. If the *ref_2* field reference value is greater than the highest displayed field reference value, the highest displayed field reference value is used.

The *ref_1* and *ref_2* field reference values must be separated by a hyphen (-). Spaces are permitted between the hyphen and the field reference values.

If *ref_1* is a higher value than *ref_2*, the search process reverses the operands.

label1

Label identifying the start of a range of records. The label must start with a period (.) followed by one to four alphabetic characters (no numeric or special characters). Labels starting with the letter “Z” indicate an editor-assigned label.

label2

Label identifying the end of a range of records. The label must start with a period (.) followed by one to four alphabetic characters (no numeric or special characters). Labels starting with the letter “Z” indicate an editor-assigned label.

Availability

- [Browse panel on page 746](#)
- [Editor panel on page 853](#)

Results

Related tasks and examples

- [Limiting the effect of editing changes on page 154](#)

EXIT primary command

The EXIT primary command is synonymous with the END command. See [END primary command on page 1148](#) for details.

EXPAND primary command

The EXPAND primary command displays a panel for inputting or viewing long data. You can use this command from any File Manager panel that has a scrollable input or display field (you must position the cursor on the scrollable field).

Syntax

►► EXPAND ◄◄

Availability

- Any File Manager panel with a scrollable input or display field.

Related tasks and examples

- [Scrollable input and display fields for long names on page 122](#)

EXTENT primary command

The EXTENT primary command displays the Non-VSAM Extent Information panel showing extent details for a non-VSAM data set.

Syntax

►► EXTENT ◄◄

Availability

- [Non-VSAM Entry Detail panel on page 957](#)
- [Non-VSAM Extent Information panel on page 958](#)

Related tasks and examples

- [Displaying extent details for non-VSAM data sets on page 424](#)

FE (Find Error) primary command

The FE (Find Error) primary command finds the next "field in error". (SNGL and TABL display format only.)

- Numeric fields whose contents cannot be formatted as a valid numeric value
- Fields that run over the record length

File Manager positions the cursor at the beginning of the field and, if necessary, automatically scrolls the data to bring the field into view.

To move the cursor to the next field in error, either enter the FE command again, or press the RFind function key (F5).

For details on limiting the columns, fields or records searched by the FE command, see [Limiting the effect of editing changes on page 154](#).

Syntax



ALL

Searches forwards from the top of data. Same as FIRST except that ALL also displays the total number of fields in error in the records searched.



Note: Suppressed or not-selected records that are hidden from display or represented by shadow lines are not searched, even when you specify ALL.

FIRST

Searches from the top of data for the first occurrence of an invalid value.

LAST

Searches backwards from the bottom of the data for the last occurrence of an invalid value.

NEXT

Searches forwards from the cursor position (if the cursor is within the data portion of the screen), or from the beginning of the topmost record displayed on the screen, for the next occurrence of an invalid value.

PREV

Searches backwards from the cursor position (if the cursor is within the data portion of the screen), or from the beginning of the topmost record displayed on the screen, for the next occurrence of an invalid value.

label1

Label identifying the start of a range of records. The label must start with a period (.) followed by one to four alphabetic characters (no numeric or special characters). Labels starting with the letter “Z” indicate an editor-assigned label.

label2

Label identifying the end of a range of records. The label must start with a period (.) followed by one to four alphabetic characters (no numeric or special characters). Labels starting with the letter “Z” indicate an editor-assigned label.

EX

Excluded records only.

NX

Not-excluded records only.

X

Same as EX.

ref

A field reference, specifying the field to be included in the search. For example: #3.

Availability

- [Browse panel on page 746](#)
- [Editor panel on page 853](#)

Related tasks and examples

- [Finding and correcting errors in your data on page 128](#)

FKEY primary command

You use the FKEY primary command to specify a starting position when browsing, viewing, or editing a KSDS using a layout from the currently loaded template. The FKEY primary command positions to the record containing, or beginning with, the specified keyvalue. This is similar to the ability provided by the Key field on the editor entry panels.

Syntax

► FKEY — *layout_name* ◄

layout_name

If you leave this blank, the layout of the current record is used, or the current key segment layout for segmented editing. If the current record is the top or end of data, then the current layout for the editor is used. You can also specify a value which is used as a filter to select a layout name. If the value does not match any existing layouts or matches more than one layout, then a list is displayed from which you can select the required layout.

Examples

Formatted key showing all current 01s in a selection list:

```
FKEY *
```

Formatted key using default layout:

```
FKEY
```

Formatted key showing all layouts beginning with A:

```
FKEY A
```

Formatted key using layout rec-type01:

FKEY rec-type01

Availability

- [Browse panel on page 746](#)
- [Editor panel on page 853](#)
- [View panel on page 1083](#)

FILE primary command

The FILE primary command issues the SAVE command, writing all changes made in panels used within the current editing task, and then returns you to your data set Entry panel. For example, using the FILE command on a “nested” template editing panel, such as the Field Attributes panel, saves all changes made on that panel, and any changes made on other panels used in the current template editing session, then return you to your data set Entry panel.

In an Edit session, the FILE command is synonymous with the END and EXIT commands.

Syntax

►► FILE ◄◄

Availability

Available on all panels.

Related tasks and examples

- [Ending an editor session on page 98](#)

FIND/FX primary command

The FIND command finds occurrences of a string or value.

The FIND command can be entered using any abbreviation of the command (for example, F or FI), or by entering the forward slash ("/") character.

For date and time fields that are displayed using the output format defined in the template, File Manager searches the displayed values for the string specified with the FIND command.

The FX command (only available in View, Edit and the Find/Change Utility) displays an Extended Command Entry panel, in which you can enter long arguments that may not otherwise fit within the Command line (see [Handling long strings in FIND on page 127](#) for more information).

Multiple (& or AND) and (| or OR) operations are evaluated strictly left to right, but AND and OR may not be mixed in the same FIND statement. There is no operator precedence, and parentheses cannot be used to change the order of evaluation.

Syntax

FIND command in View or Edit

In View and Edit, the FIND primary command searches the data for a character string or (SNGL or TABL display format only) a numeric field with a particular numeric value. If the string or numeric value is found, then the FIND command positions the cursor at the beginning of the string or numeric field and, if necessary, automatically scrolls the found data into view.

The FIND command highlights all occurrences of the search string or numeric value in the entire data set. To turn off the highlighting, enter the RESET FIND command.

To find the next occurrence of the same string, press the RFind function key (F5), enter FIND *, or enter the FIND command with no parameters. A message is displayed if the string cannot be found.



Note:

1. When you enter the FIND primary command in the Editor without specifying any parameters, File Manager displays the Extended Command Entry pop-up panel to allow you to enter arguments.
2. FIND * does *not* repeat the previous FIND command with the same parameters. FIND * repeats the previous FIND command with the same string argument, but all other parameters revert to their default values unless specified.
3. If you use the FNot version of the command, then a string is matched if it does not match according to the matching criteria described in this section.

For details on limiting the columns, fields or records searched by the FIND command, see [Limiting the effect of editing changes on page 154](#).

When you are using View or Edit, the syntax of the FIND primary command is:

Figure 375. Syntax in View or Edit

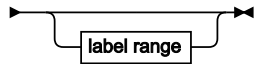
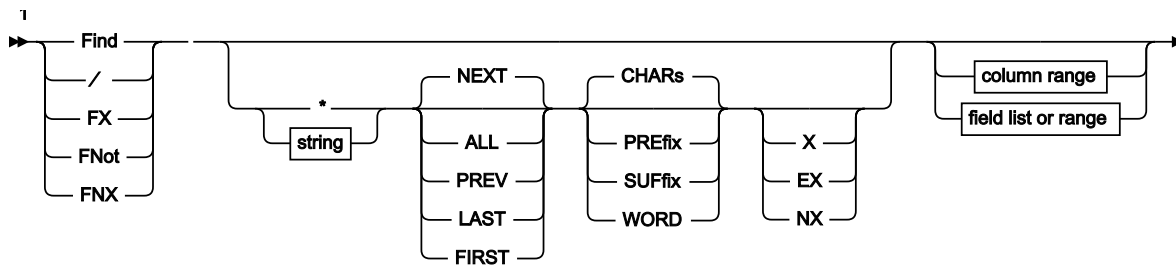

column range (all display formats)

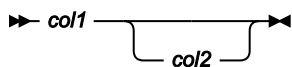

field list or range (SNGL or TABL display format)

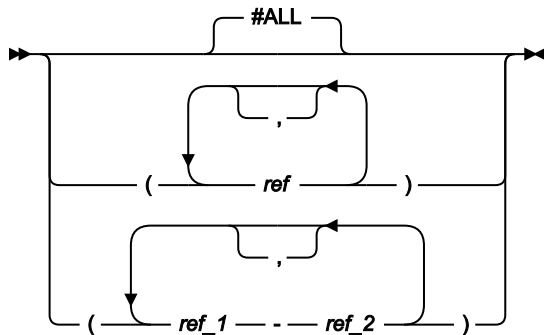

label range (Edit only)



Notes:

¹ You can specify parameters in any order.

FIND command in FCH Utility

In the Find/Change Utility, the FIND command searches contents of the selected data set or data set members. If a matching string is found, the results are displayed on screen in a report showing the member names and record numbers where the string was found, and the list of selected members is reduced to only those containing a match.

When you are using the Find/Change Utility, the syntax of the command is:

Figure 376. Syntax in the Find/Change Utility

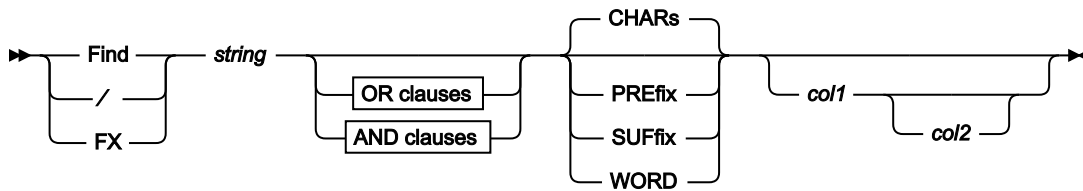

OR clauses

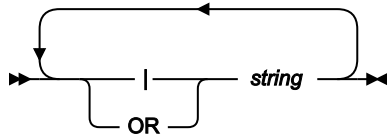

AND clauses

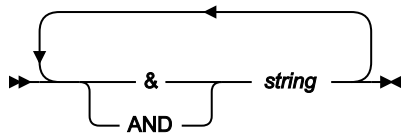

Related topics

[Using File Manager functions in batch jobs on page 508](#)

FIND command in Catalog Services: Data Set List, Display VTOC Data Set List, AFP Browse and Memory Browse

In the Catalog Services: Data Set List or Display VTOC Data Set List panels, the FIND command searches the list of data set names. If an entry name containing a matching string is found, the list is scrolled to display the matching data set at the top position. The Display VTOC Data Set List panel allows for a string argument which may contain the * and % wildcard characters. The FIND argument is matched against the data set names using the default system match rules for such wildcard characters.

In the AFP Browse utility, the FIND primary command finds the next occurrence of a character string in the data you browse. If the character string is found in a data line, it is displayed at the top line and the cursor is positioned at the beginning of the string.

In the Memory Browse utility, the FIND primary command finds the next occurrence of a character string in the data you are browsing. If the character string is found, it is displayed at the top position. The **Location field** indicates the address. To find the next occurrence of the same string, use the RFIND command, or enter the FIND command with no argument. A message is displayed if the string cannot be found.

In the Catalog Services: Data Set List, Display VTOC, AFP Browse and Memory Browse panels, the syntax of the command is:

Figure 377. Syntax

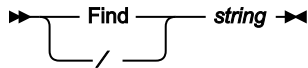

FIND command in member selection panels and the Load Module Information panel

In member selection panels, the FIND command normally finds the next occurrence of a character string in the member names being displayed, starting at the top of the displayed page or starting at the cursor position (if the cursor is within the data portion of the display). In the Load Module Information panel, the same rules apply to the list of entries shown on the display.

File Manager places the cursor at the beginning of the found string. If necessary, automatic scrolling is performed to bring the string into view.

Figure 378. Syntax - member selection and Load Module Information panels

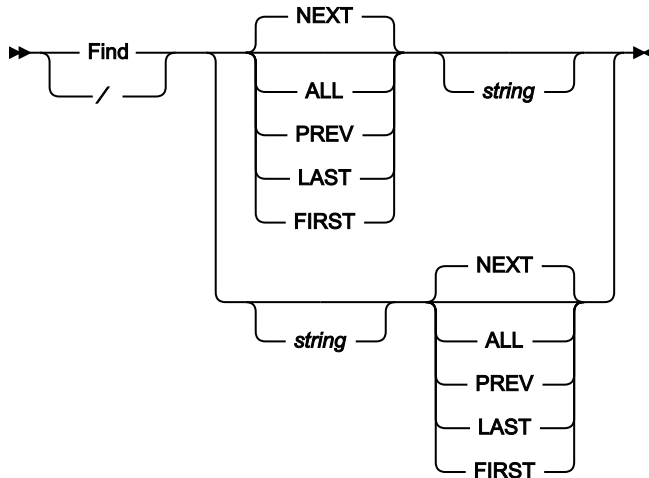

FIND command in selection lists

In selection lists, the FIND command finds the next occurrence of a character string in any column of the selection list being displayed, starting at the top of the displayed page or at the cursor position (if the cursor is within the data portion of the display).

The cursor is placed at the line containing the found string. If necessary, automatic scrolling is performed to bring the string into view.

Figure 379. Syntax - selection lists

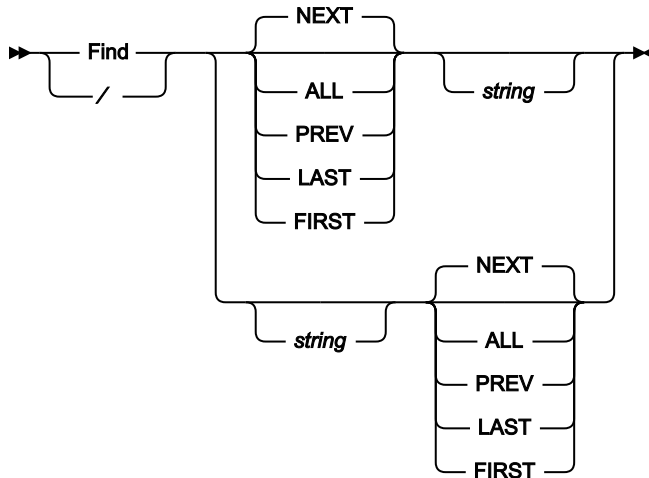

* (asterisk)

Uses the search string specified on the previous FIND command as the search string.

string

Search string, which must be no more than 100 characters long, or when used with a Member Selection List, no more than the width of the member name column. The string can be:

- No more than 100 characters long.
- An empty string, that is, using FIND without specifying a string. The search string specified on the previous FIND, CHANGE, or EXCLUDE command is used as the search string. A FIND ALL with no search string specified performs a RESET FIND, turning off any highlighting from previous FIND, CHANGE, or EXCLUDE commands. Does not apply to member or WebSphere® MQ selection lists.
- A character string not starting or ending with a quotation mark and not containing any embedded blanks or commas. The case of the string is ignored. Uppercase and lowercase representations of the same character match. For example, the following command finds the strings `black`, `Black`, and `BLACK`:

```
FIND black
```

- A character string enclosed in quotation marks. The string can contain blanks and commas. The case of the string is ignored. For example, `'Exact string'` matches `'exact string'`.
- C followed by a character string enclosed in quotation marks (`C'Frog'`), or a character string enclosed in quotation marks followed by `c` (`'Frog'C`). The string can contain blanks and commas. The string must match exactly (including case). For example, `C'Exact string'` does not match `c'exact string'`.
- A DBCS string or a mixed DBCS and non-DBCS string. A shift-out (X'OE') as the first character, or a shift-in (X'OF') as the last character, are discarded as part of the search

string. (Not supported in the Catalog Services List or Display VTOC panels.) Does not apply to member or WebSphere® MQ selection lists.

- P preceded or followed by a picture string enclosed in single or double quotation marks to describe a type of string to be found rather than the exact characters. It can contain blanks, alphabetic and numeric characters which represent themselves, or any of the special characters listed here, each of which represents a class of characters:

=

Any character.

@

Alphabetic characters.

#

Numeric characters.

\$

Special characters.

& notsym;

Non-blank characters.

.

Invalid characters.

-

Non-numeric characters.

<

Lowercase alphabets.

>

Uppercase alphabets.

Examples of picture strings used with the FIND command:

```
find p'.' 73 80
```

Find invalid characters in columns 73 to 80.

```
find p'###'
```

Find 3-digit number (for example, 101 but not 99).

```
find '@1'p 1
```

Find label a1,b1,c1, (and so on) in column 1.

```
find p'<'
```

Find lowercase alphabetic character.

```
find p'-' 72
```

Find non-blank character in column 72.

When this notation is used, numeric, bit and Unicode fields (for SNGL and TABL display formats) are excluded from the search process.

- X followed by a hexadecimal string enclosed in quotation marks (X'C1C2'), or a hexadecimal string enclosed in quotation marks followed by x ('C1C2'X). Does not apply to member selection lists.
- A numeric value (only when, in SNGL or TABL display format, you limit the search by specifying field references, and only when the field being searched is a numeric field). For details, see [Searching numeric fields on page 126](#). Does not apply to member or WebSphere® MQ selection lists.

ALL

Searches forwards from the top of data. Same as FIRST, except that ALL also displays the total number of occurrences of *string* in the records searched.



Note:

1. Suppressed or not-selected records that are hidden from display or represented by shadow lines are not searched, even when you specify ALL.
2. The ALL parameter is recursive when used with the FIND command. That is, applying the command FIND ALL 'SS' to the string 'SSS' finds two occurrences, the first 'SS' and the second 'SS'.
3. A FIND ALL command with no search string specified performs a RESET FIND command, turning off any highlighting from previous FIND, CHANGE, or EXCLUDE commands.

EX

Excluded records only.

FIRST

Searches from the top of data for the first occurrence of *string*.

LAST

Searches backwards from the bottom of data for the last occurrence of *string*.

label1

Label identifying the start of a range of records. The label must start with a period (.) followed by one to four alphabetic characters (no numeric or special characters). Labels starting with the letter "Z" indicate an editor-assigned label.

label2

Label identifying the end of a range of records. The label must start with a period (.) followed by one to four alphabetic characters (no numeric or special characters). Labels starting with the letter "Z" indicate an editor-assigned label.

NEXT

Searches forwards from the cursor position (if the cursor is within the data portion of the screen), or from the beginning of the topmost record displayed on the screen, for the next occurrence of *string*.

NX

Not-excluded records only.

PREV

Searches backwards from the cursor position (if the cursor is within the data portion of the screen), or from the beginning of the topmost record displayed on the screen, for the next occurrence of *string*.

PREFIX

Matches the search string wherever it appears as a prefix in the data. To be a prefix, the matched text must be preceded by a non-alphanumeric character or be the start of a line or field, and must be followed by an alphanumeric character.

SUFFIX

Matches the search string wherever it appears as a suffix in the data. To be a suffix, the matched text must be preceded by an alphanumeric character, and must be followed by a non-alphanumeric character or be the end of a line or field.

WORD

Matches the search string wherever it appears as a word in the data. To be a word, the matched text must be preceded by a non-alphanumeric character or be the start of a line or field, and must be followed by a non-alphanumeric character or be the end of a line or field.

col1

The first column to be included in the range of columns to be searched. Must be greater than or equal to 1, and less than or equal to the maximum record length. When column ranges are specified and the data is displayed in SNGL or TABL formats, the search is performed in the order that the data occurs, which may not be the order in which the fields are displayed.

When column ranges are specified in SNGL or TABL display format, then a string comparison is performed, even for numeric fields.



Note: When you use the FIND primary command in the Find/Change Utility, if the **JCL Source format** option is selected, the columns searched are set to 3 through 71, unless the statement is not a JCL statement. A statement is considered to be a JCL statement



if it begins with the strings `/*` or `//`. If the statement does not begin with either of these strings, it is not considered to be a JCL statement in which case any column range specified on the `FIND` (or `CHANGE`, respectively) command or preset using the `BOUNDS` command is honored. If no column range has been specified, the full record is searched.

col2

The last column to be included in the range of columns to be searched. Must be greater than or equal to *col1* and less than or equal to the maximum record length.

In the Editor, if *col2* is not specified, it defaults to the value of *col1*, creating a search range of one column.

In the FCH Utility, if *col2* is not specified, it defaults to the record length, creating a search range from *col1* to the end of the record.

#ALL

Each field is searched according to its template attributes.

ref

A field reference, specifying the field to be included in the search, for example: `#3`.

When the field is an array, to search all items in the array, simply specify the field reference without a subscript. To search an item in a single-dimension array, specify a subscript in parentheses to identify the occurrence that you want to find; for example: `#5(3)`. If your field is part of a multi-dimensional array, you must specify a subscript for each dimension in the array; for example: `#7(2,3)`.

Multiple field references must either be enclosed in parentheses, or separated with commas but without any intervening spaces. For details, see [Limiting the search to specified fields on page 156](#).

In `SNGL` or `TABL` display format, if you specify field references or do not specify a field reference or column range, when searching a numeric field, the search string is interpreted as a numeric value, and a numeric comparison is performed. When searching a character field, a string comparison is performed. That is, the search is performed based on the File Manager template attributes. For details, see [Searching numeric fields on page 126](#).

ref_1

The first field reference of a range of fields. It cannot be subscripted. If the *ref_1* field reference value is less than the lowest displayed field reference value, the lowest displayed field reference value is used.

ref_2

The last field reference of a range of fields. It cannot be subscripted. If the *ref_2* field reference value is greater than the highest displayed field reference value, the highest displayed field reference value is used.

The *ref_1* and *ref_2* field reference values must be separated by a hyphen (-). Spaces are permitted between the hyphen and the field reference values.

If *ref_1* is a higher value than *ref_2*, the search process reverses the operands.

X

Same as EX.

Availability

- [Browse panel on page 746](#)
- [Editor panel on page 853](#)
- [Find/Change Utility panel on page 901](#)
- [Catalog Services Data Set List panel on page 759](#)
- [Display VTOC panel on page 837](#)
- [AFP Print Browse panel on page 730](#)
- [Memory Browse panel on page 952](#)
- [Field Selection/Edit panel on page 891](#)
- [Member Selection panel on page 946](#)
- [WebSphere MQ Managers panel on page 1109](#)
- [WebSphere MQ Queue List panel on page 1116](#)
- [Template Member List panel on page 1064](#)

Related tasks and examples

- [Finding specific data on page 125](#)
- [Finding and changing data in multiple PDS members on page 368](#)
- [Refining the list of selected members on page 370](#)
- [Specifying multiple arguments for FIND on page 374](#)
- [Working with a list of catalog entries on page 418](#)
- [Displaying a Volume Table of Contents \(VTOC\) on page 432](#)
- [Browsing AFP Print documents on page 437](#)
- [Browsing your user storage on page 437](#)
- [Specifying a data set and a member name on page 42](#)
- [Advanced copybook selection on page 208](#)
- [Working with files or members containing JCL on page 378](#)
- [Working with WebSphere MQ on page 439](#)
- [Working with the Template List on page 271](#)

FINDNOT primary command

The FINDNOT command is used in the FCH Utility to return a list of members of a data set which do NOT contain a specified character string. It can only be used for a PDS or PDS/E data set.

The FINDNOT command can be abbreviated to FINDN or entered as FN. The FNX command displays an Extended Command Entry panel, in which you can enter long arguments that may not otherwise fit within the Command line (see [Handling long strings in FIND](#) on page 127 for more information).



Note: It is not possible to use multiple FINDNOT commands in the input stream for batch processing. Similarly, it is not possible to combine FIND and FINDNOT commands in the batch input stream.

Syntax

Figure 380. Syntax in the Find/Change Utility

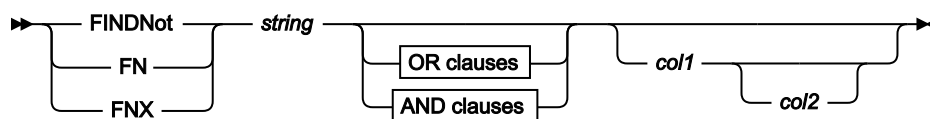

OR clauses

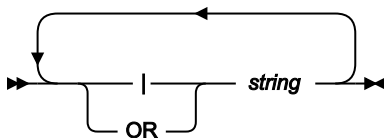

AND clauses

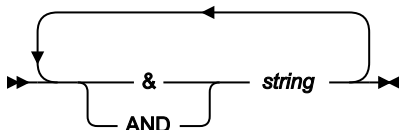

string

Search string. The string must be no more than 100 characters long. The string can be:

- a character string not starting or ending with a quotation mark and not containing any embedded blanks or commas. The case of the string is ignored. Uppercase and lowercase representations of the same character match. For example, Mixed string matches MIXED string.
- a character string enclosed in quotation marks. The string can contain blanks and commas. The case of the string is ignored.
- c followed by a character string enclosed in quotation marks (C'Frog'), or a character string enclosed in quotation marks followed by c ('Frog'C). The string can contain blanks and commas. The string must match exactly (including case).
- x followed by a hexadecimal string enclosed in quotation marks (X'C1C2').

AND and OR clauses

You can specify multiple arguments by using OR-clauses or AND-clauses. If OR-clauses are used, a member is excluded when any of the arguments are found in the member. If AND-clauses are used, a member is excluded only if all of the arguments are found in any line of the member. The maximum number of arguments that can be specified is 16.

In preparing a FINDNOT command in a batch run, you can use more than one line to specify multiple arguments. To indicate that a line is continued, the last item on the line is a blank delimited comma.

col1 and col2

You can limit the columns that are searched by the FINDNOT command by entering a pair of column numbers indicating the first and last columns to be searched. The string is found if it is completely contained within the designated columns. For example, `FINDNOT xxx 1 20` excludes a member if it contains any records with the string "xxx" within columns 1-20.

If columns are not specified, the columns to be searched default to the columns defined by the BOUNDS line. If a single column is specified, the character string must start in the specified column. If the second column specified is larger than the record size, the record size is used.

Availability

- [Find/Change Utility panel on page 901](#)

Related tasks and examples

- [Finding and changing data in multiple PDS members on page 368](#)

FMAP primary command

The FMAP command can be used to edit or view a field in a record using another template. If the field being mapped is shorter than the template mapping a warning message is issued when data is changed and any data which is beyond the end of the mapped field is ignored. The data type of the field being mapped is ignored.

The record containing the field to be mapped must be at the top of the screen or the cursor may be positioned on the record when the FMAP command is issued. The record must be a selected record.

If the field identification parameter is not specified and the cursor is positioned on a field that field is used. Otherwise a Field List Selection panel is displayed.

If the template name is no specified a panel is displayed where this information can be supplied.

Syntax

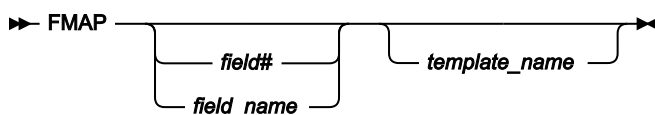

field#

The reference number of the field to be mapped.

field_name

The name of the field to be mapped. The name may be qualified.

template_name

The name of the template to be used to map the field. A partially or fully qualified data set name together with the member name can be specified.

Availability

- [Browse panel on page 746](#)
- [Editor panel on page 853](#)

Related tasks and examples

- [Selecting a display format on page 105](#)

FORMAT primary command

The FORMAT primary command allows you to change the current display format without having to overwrite the FORMAT field. If no format type is supplied, the default depends on the current display format. If you are in SNGL format, the default is TABL format. If you are in TABL format, the default is SNGL format. In other display formats, there is no default and a error message is issued when no parameter is supplied.

The abbreviated forms of the FORMAT primary command (FS, FT, FC, FH, FL) are also available as prefix commands (see [Editor panel on page 853](#)).

Syntax

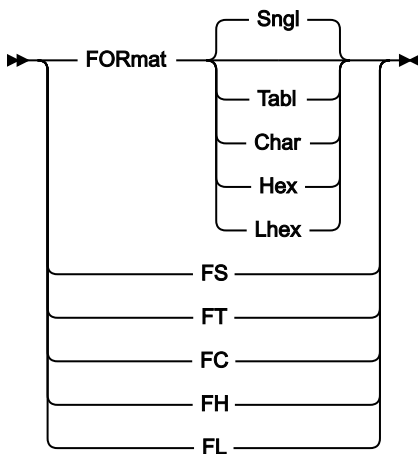

Sngl, FS

Change format to SNGL format. Only available if a template has been used.

Tabl, FT

Change format to TABL format. Only available if a template has been used.

Char, FC

Change format to CHAR format.

Hex, FH

Change format to HEX format.

Lhex, FL

Change format to LHEX format.

Availability

- [Browse panel on page 746](#)
- [Editor panel on page 853](#)

Related tasks and examples

- [Selecting a display format on page 105](#)

FREE primary command

In Browse, View, and Edit, the FREE command removes any scrolling lock on one or more fields. You can set scrolling locks with the HOLD editor primary command or by using the H prefix command in the template editor.

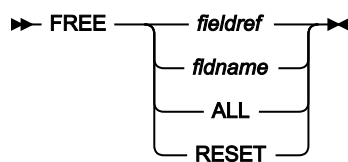
Syntax***fieldref***

A single field reference (for example, #1), a range (for example, #2-#5), or a list of single field references/ ranges separated by spaces (for example, #1 #4 #6-#7). A single field specification is #n; n is a positive integer and cannot exceed the number of fields in the template being processed.

fldname

The name of a field in the template, which is optionally preceded by the pound symbol (#). Use #ALL and #RESET to avoid any syntactical ambiguity with command keywords.

ALL

Removes all scrolling locks.

RESET

Removes all scrolling locks.

Availability

The FREE command is available on most editor panels. In particular, to allow you to modify how the data is displayed, it can be used in the following panels:

- [Browse panel on page 746](#)
- [Editor panel on page 853](#)
- [WebSphere MQ Managers panel on page 1109](#)
- [WebSphere MQ Queue List panel on page 1116](#)

Related tasks and examples

- [HOLD primary command on page 1175](#)
- [ORDER primary command on page 1195](#)
- [TEDIT primary command on page 1231](#)

HEX primary command

In View and Edit, you can use the HEX primary command to set or reset the hexadecimal display in CHAR, HEX, SNGL or TABL display formats. This command is not available in LHEX display format.

In selection lists, you can use the HEX primary command to set or reset the hexadecimal display of the displayed data.

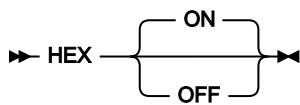
Syntax**(no parameter)**

Toggles the correct hexadecimal-display status. That is, it turns hexadecimal display ON if currently OFF, and turns hexadecimal display OFF if currently ON.

ON

Display the hexadecimal representation of the data vertically (three lines per byte).

OFF

Display the data in character format.

In View and Edit, the effect of issuing the HEX command depends upon the current display format when you issue the command, as follows:

- When the current display format is CHAR or HEX:

HEX ON

Changes the display format to HEX. This is equivalent to entering HEX in the **Format** field.

HEX OFF

Changes the display format to CHAR. This is equivalent to entering CHAR in the **Format** field.

- When the current display format is SNGL or TABL:

HEX ON

Changes the display of each field to show the vertical hexadecimal representation of each field in the two lines immediately below the formatted field.

HEX OFF

Changes the display back to standard SNGL or TABL format, without hexadecimal representations.

Availability

- [Browse panel on page 746](#)
- [Editor panel on page 853](#)
- [WebSphere MQ Managers panel on page 1109](#)
- [WebSphere MQ Queue List panel on page 1116](#)
- [Template Member List panel on page 1064](#)

Related tasks and examples

- [Selecting a display format on page 105](#)
- [Working with WebSphere MQ on page 439](#)

HIDE primary command

In Browse, View, and Edit, the HIDE command removes a field from the data display.

A hidden field can be displayed by using the SHOW editor primary command or by using the S prefix command in the template editor.

In the PDSE Workbench and Template Member List panels, the HIDE command hides all input fields, leaving more space to display the member list. When the input fields are hidden, enter HIDE to show them again.

Syntax

Figure 381. Browse, View, and Edit format

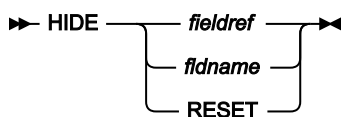

fieldref

A single field reference (for example, #1), a range (for example, #2-#5), or a list of single field references/ ranges separated by spaces (for example, #1 #4 #6-#7). A single field specification is #n; n is a positive integer and cannot exceed the number of fields in the template being processed.

fldname

The name of a field in the template, which is optionally preceded by the pound symbol (#). Use #RESET to avoid any syntactical ambiguity with command keywords.

Figure 382. PDSE Workbench and Template Member List format

▶▶ HIDE ◀◀

Availability

The HIDE command is available on most editor panels and in the PDSE Workbench and Template Member List panels. In particular, to allow you to modify how the data is displayed, it can be used in the following panels:

- [Browse panel on page 746](#)
- [Editor panel on page 853](#)
- [PDSE Workbench Member List panel on page 961](#)
- [Template Member List panel on page 1064](#)
- [WebSphere MQ Managers panel on page 1109](#)
- [WebSphere MQ Queue List panel on page 1116](#)

Related tasks and examples

- [SHOW \(FLD\) primary command on page 1221](#)
- [TEDIT primary command on page 1231](#)

HISTORY primary command

The HISTORY primary command invokes the PDSE Workbench for the current member selection list.

For PDSEs that support member generations, the history for each member is displayed on the workbench.

Syntax**HIDE**

Displays PDSE Workbench with the input fields hidden to maximize the size of the member list.

NOHIDE

Displays the full PDSE Workbench with all input fields displayed.

When neither HIDE nor NOHIDE is specified, the previous PDSE Workbench setting is used. The default for first time users is NOHIDE. When PDSE Workbench is displayed, use the HIDE command to toggle the display of input fields.

Availability

- [Member Selection panel on page 946](#)

Related tasks and examples**HOLD primary command**

In Browse, View and Edit, the HOLD command sets a scrolling lock on one or more fields. In TABL display format, when scrolling left or right, held fields are fixed on the left in the order specified in the template. In non-structured SNGL mode, when scrolling up or down, held fields are fixed at the top in the order specified in the template. You can remove scrolling locks with the FREE editor primary command or by using the H prefix command in the template editor.

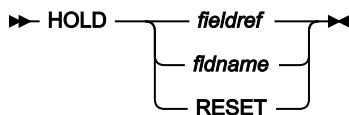
Syntax***fieldref***

A single field reference (for example, #1), a range (for example, #2-#5), or a list of single field references/ranges separated by spaces (for example, #1 #4 #6-#7). A single field specification is #n; n is a positive integer and cannot exceed the number of fields in the template being processed.

fldname

The name of a field in the template, which is optionally preceded by the pound symbol (#). Use #RESET to avoid any syntactical ambiguity with command keywords.

Availability

The HOLD command is available on most editor panels. In particular, to allow you to modify how the data is displayed, it can be used in the following panels:

- [Browse panel on page 746](#)
- [Editor panel on page 853](#)
- [WebSphere MQ Managers panel on page 1109](#)
- [WebSphere MQ Queue List panel on page 1116](#)

Related tasks and examples

- [FREE primary command on page 1171](#)
- [ORDER primary command on page 1195](#)
- [TEDIT primary command on page 1231](#)

INFO primary command

The INFO primary command returns you from the VSAM Extent Detail or Association Information panel, to the catalog Entry Details panel for the current data type.

Syntax

▶▶ Info ▶▶

Availability

- [AIX Association Information panel on page 733](#)
- [Non-VSAM Association Information panel on page 955](#)
- [VSAM Association Information panel on page 1098](#)
- [VSAM Statistics and Extent Detail panel on page 1106](#)

Related tasks and examples

- [Viewing association information on page 423](#)
- [DSI \(Data Set Information\) on page 1386](#)

JOIN primary command

Joins two lines: either the line containing the cursor and the next line (which then overlays the line starting at the cursor position); or the line displayed at the top of the screen with the following line, at the current column position. See [Splitting and joining lines on page 170](#).

Syntax

▶▶ JOIN ▶▶

Availability

- [Editor panel on page 853](#)

Related tasks and examples

- [Splitting and joining lines on page 170](#)

JUST primary command

In an editor session, the JUST command temporarily toggles numeric fields to left or right justified when in SNGL display mode.

Syntax

▶▶ JUST ◀◀



Note: When numeric fields are left justified, a space is allowed on the left for sign characters (+ or -). When the number is unsigned or formatted so that the sign appears to the right of the number, a blank character is used as a placeholder on the left, so that numeric fields align neatly (but 1 character to the right of alpha fields). Fields with an alphanumeric type such as AN or ZA are always fully left aligned, even when they contain numeric characters. These field types are not affected by the JUST command and do not allow the space for the sign character. For example, in the following display, the first field is fully left aligned because it is an alphanumeric field, the second field shows the sign character, and the numbers in the last field are aligned with the numbers in the second field even though the sign character is not displayed:

Typ	Start	Len	Data
AN	26	2	02
ZD	28	4	-654
AN	32	10	John
AN	42	10	Brown
ZD	52	4	1875

Availability

- [Browse panel on page 746](#)
- [Editor panel on page 853](#)

Related tasks and examples

- [Selecting a display format on page 105](#)

KEY primary command

You use the KEY primary command to specify a starting position when browsing, viewing, or editing a KSDS.

The KEY primary command positions to the record containing, or beginning with, the specified keyvalue. This is similar to the ability provided by the **Key** field on the editor entry panels.

Syntax

Figure 383. Syntax

▶▶ KEY — *keyvalue* ▶▶

keyvalue

In a KSDS, File Manager positions to the record containing, or beginning with, this value.

To specify blanks or special characters, enclose the value in quotation marks. For example:

```
KEY '02 A'
```

For undisplayable characters, you can specify the value in hexadecimal. For example:

```
KEY 'F0F240C1'X
```

Availability

- [Browse panel on page 746](#)
- [Editor panel on page 853](#)
- [View panel on page 1083](#)

Related tasks and examples

- [Starting an editor session without using templates on page 89](#)

LEFT primary command

You can use the LEFT primary command in:

- View or Edit
- A WebSphere® MQ selection list

In View or Edit, any display format apart from SNGL, the LEFT primary command scrolls to the left of your data. (This command is not valid in SNGL mode.)

The amount (number of columns) scrolled is determined by either an optional parameter or, if no parameter is entered, by the amount indicated in the **Scroll** field.

Syntax

Figure 384. Syntax in View or Edit

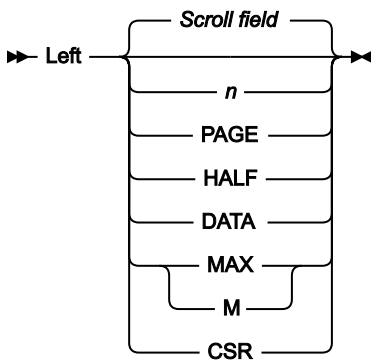

n**In View or Edit**

In CHAR, HEX or LHEX display format, scrolls left *n* columns. In TABL display format, scrolls left *n* fields.

In a WebSphere® MQ selection list

Scrolls left *n* columns.

CSR

Scrolls left to the cursor position.

DATA**In View or Edit**

In TABL display format, acts the same as **PAGE**. In other display formats, scrolls left one column less than a page of data.

In a WebSphere® MQ selection list

Acts the same as **PAGE**.

HALF

Scrolls left half a page of data.

MAX**In View or Edit**

In CHAR, HEX or LHEX display format, scrolls to leftmost column. In TABL display format, scrolls to the leftmost field.

In a WebSphere® MQ selection list

Scrolls to leftmost column.

PAGE

Scrolls left one page of data.

Scroll field

Scrolls left by the amount indicated in the **Scroll field**. This is the default if no parameter is used. Entering a parameter other than MAX in the scroll field changes the scroll field default. If MAX is entered, the scroll field reverts to the previous setting after the command is issued.

Availability

Available on all panels when the panel information cannot be seen within one screen. In particular, it is used in the following panels, to allow you to view data:

- [Browse panel on page 746](#)
- [Editor panel on page 853](#)

- [WebSphere MQ Managers panel on page 1109](#)
- [WebSphere MQ Queue List panel on page 1116](#)
- [Template Member List panel on page 1064](#)

Related tasks and examples

- [Scrolling to see data on page 117](#)
- [Working with WebSphere MQ on page 439](#)

LHEX primary command

In Browse, View and Edit, the LHEX command displays the data for one or more fields in long hexadecimal format. In LHEX format, each character is shown as two hexadecimal characters, which are displayed from left to right. For example, '1' appears as 'F1' in LHEX format. Only character fields are affected.

Syntax

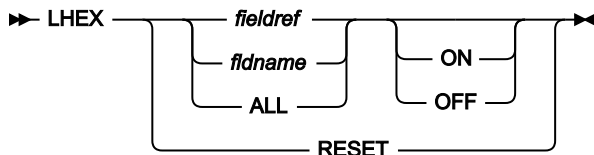

fieldref

A single field reference (for example, #1), a range (for example, #2-#5), or a list of single field references/ ranges separated by spaces (for example, #1 #4 #6-#7). A single field specification is #n; n is a positive integer and cannot exceed the number of fields in the template being processed.

fldname

The name of a field in the template, which is optionally preceded by the pound symbol (#). Use #ALL and #RESET to avoid any syntactical ambiguity with command keywords.

ON|OFF

Indicates whether to turn the LHEX option on or off. Omitting this parameter results in the command acting as a toggle; the field's current LHEX display status is reversed.

RESET

Displays all fields in the default format.

Availability

The LHEX command is available on most editor panels. In particular, to allow you to modify how the data is displayed, it can be used in the following panels:

- [Browse panel on page 746](#)
- [Editor panel on page 853](#)

- [WebSphere MQ Managers panel on page 1109](#)
- [WebSphere MQ Queue List panel on page 1116](#)

Related tasks and examples

- [HEX primary command on page 1172](#)
- [TEDIT primary command on page 1231](#)

LIBLIST primary command

The LIBLIST primary command displays the current library list and allows you to change it if necessary. If you remove a library that has been referenced, then the copybooks referring to that library are revalidated to determine whether they exist in the new library list. If they exist, the library reference is changed to the first library in which they are found. If they are not found, they are flagged as in error.

Syntax

►► LIBLIST ◄◄

Availability

- [Copybook Selection panel on page 810](#)

Related tasks and examples

- [Advanced copybook selection on page 208](#)

LIST primary command

The LIST primary command prints a listing of the current format definitions for the Set DBCS Options.

Syntax

►► LIST ◄◄

Availability

- [Set DBCS Format panel on page 1018](#)

Related tasks and examples

- [Printing DBCS data on page 410](#)

LISTVIEW primary command

On the Personal Data Set List panel the LISTVIEW primary command toggles the format of the display to include (or exclude) an extra (third) line where you can add or view the description for that data set entry.

On the Personal Data Set Lists panel, the LISTVIEW primary command toggles between the standard and extended list format. The extended list format shows the first 6 data set names for each list.

Syntax

▶- LISTVIEW -▶

Availability

- [Personal Data Set List panel on page 966](#)
- [Personal Data Set Lists panel on page 968](#)

Related tasks and examples

- [Working with data set lists on page 320](#)

LOCATE primary command

The LOCATE primary command searches the current context for an occurrence of a specified item (for example, a member, a record, a field or a line).

Syntax

LOCATE command in View or Edit

In an editor session, this command scrolls to the specified record or field within the displayed data set or data set member.

In an editor session, the syntax of this command is:

Figure 385. Syntax in View or Edit

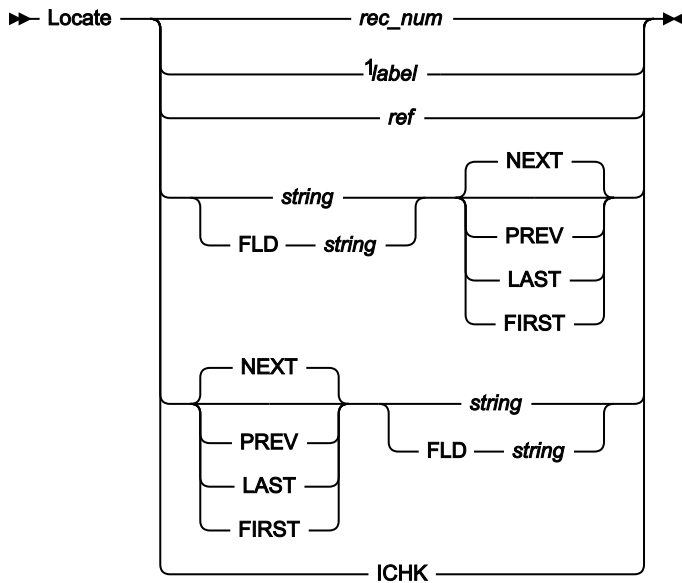

Notes:

¹ Edit only

LOCATE command in the Find/Change Utility

In the Find/Change Utility, this command positions a specified member at the top of the list of members to be processed.

In the Find/Change Utility, the syntax of this command is:

Figure 386. Syntax in the Find/Change Utility

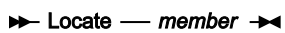

Non-VSAM Extent Information panel

In the Non-VSAM Extent Information panel, use this command to locate specific data.

In the Non-VSAM Extent Information panel, the syntax of this command is:

Figure 387. Syntax in Non-VSAM Extent Information panel

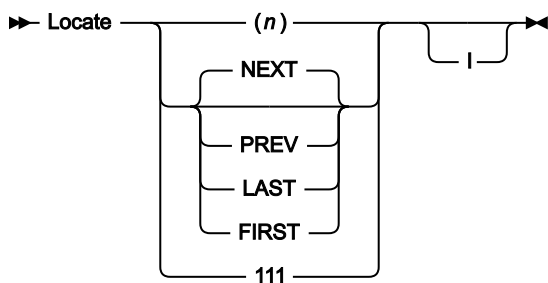

LOCATE command in AFP Browse

In the AFP Browse panel, the LOCATE primary command positions a specified page number at the top of the display.

In the AFP Browse panel, the syntax of this command is:

Figure 388. Syntax in AFP Browse

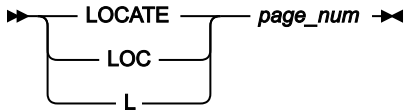

LOCATE command in member selection panels

In member selection panels, the LOCATE command searches the current primary sort order column for a matching string to the string entered with the command. The LOCATE command positions to the top of the display the column value either equal to, or closest value less than or greater than depending on the sort order.

Figure 389. Syntax in Member Selection List

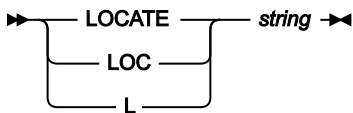

LOCATE command in the Copybook Selection panel

In the Copybook Selection panel, the LOCATE command searches the list of members for a matching string to the string entered with the command and positions the first matching member to the top of the display.

Figure 390. Syntax in the Copybook Selection panel

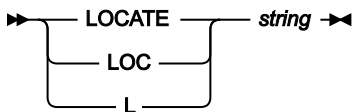

LOCATE command in the Field Selection/Edit panel

In the Field Selection/Edit panel, the LOCATE command searches the displayed template for either a field reference number, or the starting or full characters of a field name.

Figure 391. Syntax in the Field Selection/Edit panel

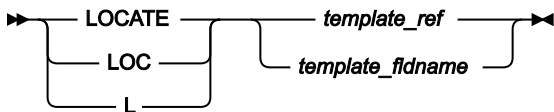

LOCATE command in the Load Module Information panel

In the **Load Module Information Panel**, the LOCATE command locates a specified name (if the result is sorted by name) or address (if the result is sorted by address).

Figure 392. Syntax in the Load Module Information panel

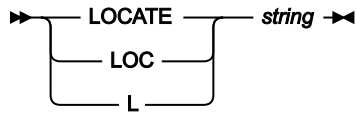

LOCATE command in a WebSphere® MQ selection list

When you are viewing a WebSphere® MQ selection list, the LOCATE command searches the current *held* columns for a matching string to the string entered with the command.

The LOCATE command positions to the top of the display the column value which is equal to the specified string, or contains the specified string.

Figure 393. Syntax in in a WebSphere® MQ selection list

▶▶ LOCATE — *string* ◀◀

rec_num

The number of the record that you want to locate. For example:

```
LOCATE 23
```

locates record number 23.

line_num

The line number of the data set name that you want to locate. For example:

```
LOCATE 23
```

locates the data set name on line 23.

volser

(Extent panels only.) The disk volume in the list that you want to locate. For example:

```
LOCATE D$ST04
```

locates disk volume D\$ST04.

(n)

(Extent panels only.) The *n*th disk volume in the list that you want to locate. For example:

```
LOCATE (7)
```

locates the 7th disk volume in the list.

111

(Extent panels only.) The 111-th extent of the data set. For example:

```
LOCATE 248
```

locates the 248th extent of the data set.

I

(Extent panels only.) Indicates you want to search the index component of VSAM data sets. For example:

```
LOCATE FIRST I
```

locates the first volser of the data set.

page_num

The page number of the data that you want to locate. For example:

```
LOCATE 23
```

scrolls to page 23 of the print data.

label

An existing user-assigned or editor-assigned label, identifying the record that you want to locate. The label must start with a period (.) followed by one to four alphabetic characters (no numeric or special characters). Labels starting with the letter "Z" indicate an editor-assigned label. For example:

```
LOC .HERE
```

locates a record marked with an existing label (.HERE), and

```
L .ZLST
```

locates the last record in the data set.

ref

A field reference, specifying the field that you want to locate, for example:

```
L #3
```

When the field is an item in an array, you must specify a subscript in parentheses to identify the occurrence that you want to locate, for example:

```
L #5(3)
```

If your field is part of a multi-dimensional array, you must specify a subscript for each dimension in the array, for example:

```
L #7(2,3)
```

Available in SNGL or TABL display format only.

string

The name (or part of the name) of the field that you want to locate. This string can occur anywhere in the field name. For example:

```
L SAL
```

or

```
L ARY
```

locates a field named "SALARY".

For member selection list panels, the string syntax must be consistent with the target column for the locate command. For example, for dates the string must contain valid month, day, and year values.

For the Load Module Information panel, the content of the string depends on the sequence in which the information is displayed. You can sort the result by name or by address. To sort by name, the string must be a symbol name. To sort by address, the string must be a valid hex address.

In View or Edit, the LOCATE command is available in SNGL or TABL display format only.

template_ref

A field reference, specifying the field that you want to locate in the template displayed on the Field Selection/Edit panel.

For example, to locate the cursor in the prefix area of the line containing field reference 3, issue the command:

```
L #3
```

template fldname

The full name, or starting characters, of a field displayed on the Field Selection/Edit panel that you want to locate in the template.

For example, to locate the cursor in the prefix area of the line containing the field with the name "SALARY", issue the command:

```
L SALARY
```

or

```
L SAL
```

FLD string

Indicates to File Manager that the string following the FLD keyword is the name or part of the name of the field that you want to locate. This is used to resolve any ambiguity that may exist between field names and other command parameters. For example, if your field name contained the # symbol (e.g. #Items), the command `L #Items` would result in an error, as File Manager is expecting the # symbol to be followed by a numerical field reference number. Using the command `L FLD #Items` resolves this problem.

Available in SNGL or TABL display format only.

NEXT

- For non-extent panels:

Finds the next occurrence of the field name, to the right (TABL display) or down (SNGL display) from the cursor location. Must be used in conjunction with *string* or *FLD string*, in any order. For example:

```
L NEXT SAL
```

or

```
L SAL NEXT
```

Available in SNGL or TABL display format only.

- For extent panels:

Finds the next volser of the data set. For example:

```
L NEXT
```

- For the Load Module Information panel:

Finds the next name or address, depending on the order in which the information is presented. For example, if 0000FACC was recently located,

```
L NEXT
```

positions at the next occurrence of the address 0000FACC.

PREV

- For non-extent panels:

Finds the previous occurrence of the field name, to the left (TABL display) or up (SNGL display) from the cursor location. Must be used in conjunction with *string* or *FLD string*, in any order. For example:

```
L PREV SAL
```

or

```
L SAL PREV
```

Available in SNGL or TABL display format only.

- For extent panels:

Finds the previous volser of the data set. For example:

```
L PREV
```

- For Load Module Information panel:

Finds the previous name or address, depending on the order in which the information is presented. For example, if 0000FACC was recently located,

```
L PREV
```

positions at the previous occurrence of this address.

LAST

- For non-extent panels:

Finds the last occurrence of the field name, regardless of the cursor location. Must be used in conjunction with *string* or FLD *string*, in any order. For example:

```
L LAST SAL
```

or

```
L SAL LAST
```

Available in SNGL or TABL display format only.

- For extent panels:

Finds the last volser of the data set. For example:

```
L LAST
```

- For the Load Module Information panel:

Finds the last name or address, depending on the order in which the information is presented. For example, if 0000FACC was recently located,

```
L LAST
```

positions at the last occurrence of this address.

FIRST

- For non-extent panels:

Finds the first occurrence of the field name, regardless of the cursor location. Must be used in conjunction with *string* or FLD *string*, in any order. For example:

```
L FIRST SAL
```

or

```
L SAL FIRST
```

Available in SNGL or TABL display format only.

- For extent panels:

Finds the first volser of the data set. For example:

L FIRST

- For the Load Module Information panel:

Finds the first name or address, depending on the order in which the information is presented. For example, if 0000FACC was recently located,

L FIRST

positions at the first occurrence of this address.

ICLK

Scrolls to the next record that encountered an integrity check while being saved.

Availability

- [Browse panel on page 746](#)
- [Editor panel on page 853](#)
- [Find/Change Utility panel on page 901](#)
- [Catalog Services Data Set List panel on page 759](#)
- [Display VTOC panel on page 837](#)
- [AFP Print Browse panel on page 730](#)
- [Member Selection panel on page 946](#)
- [Copybook Selection panel on page 810](#)
- [Non-VSAM Extent Information panel on page 958](#)
- [VSAM Statistics and Extent Detail panel on page 1106](#)
- [WebSphere MQ Managers panel on page 1109](#)
- [WebSphere MQ Queue List panel on page 1116](#)
- [Template Member List panel on page 1064](#)

Related tasks and examples

- [Scrolling to see data on page 117](#)
- [Specifying a data set and a member name on page 42](#)
- [Advanced copybook selection on page 208](#)
- [Working with WebSphere MQ on page 439](#)

LZERO primary command

The LZERO primary command toggles the global leading zero setting for the template.

If global leading zeros is set to ON, then the default leading zero setting for applicable numeric fields is YES, and a status indicator **LZERO** appears on the current panel.

If global leading zeros is set to `OFF`, then the default leading zero setting for applicable numeric fields is `NO`, and the status indicator is cleared.

Syntax

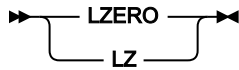

Availability

- [Field Selection/Edit panel on page 891](#)

Related tasks and examples

NEXT primary command

The NEXT primary command moves to the next "visible" record (see Note below) or, if you specify a number, moves forward that number of records.



Note: In this context, "visible" means any selected, not suppressed, or not excluded record, unless those types of records are being shown in the view because of edit settings or entered SHOW commands.



Note: If you specify a number of records greater than the remaining number of records, the `*** End of data ***` line is displayed.

NEXT can be abbreviated to N, NE or NEX.

Syntax

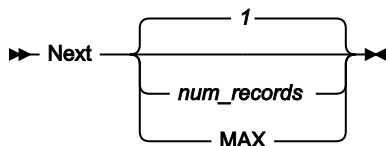

num_records

Scrolls forward the specified number of records. The default is 1 record.

MAX

Scrolls to last record.

Availability

- [Browse panel on page 746](#)
- [Editor panel on page 853](#)

Related tasks and examples

- [Scrolling to see data on page 117](#)
- [Zooming in to see all of a record on page 112](#)

NEXTREC primary command

When viewing segmented data in SNGL display mode, the NEXTREC primary command moves to the first segment of the next "visible" physical record (see Note below) or, if you specify a number, moves forward that number of physical records.



Note: In this context, "visible" means any selected, not suppressed, or not excluded record, unless those types of records are being shown in the view because of edit settings or entered SHOW commands.



Note: If you specify a number of records greater than the remaining number of physical records, the `**** End of data ****` line is displayed.

Syntax

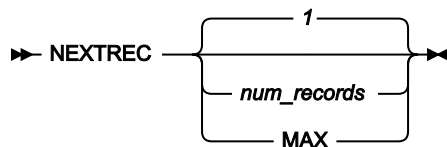

num_records

Scrolls forward the specified number of physical records. The default is 1 physical record.

MAX

Scrolls to first segment of the last physical record.

Availability

- [Browse panel on page 746](#) (SNGL display mode only)
- [Editor panel on page 853](#) (SNGL display mode only)

Related tasks and examples

- [Viewing segmented data on page 314](#)

NRETRIEV primary command

You use the NRETRIEV primary command to retrieve the first data set name (the one most recently used, shown at the top of the list) and associated information from the current data set list. Successive use of NRETRIEV retrieves the details for the next data set in the current data set list,

Syntax

►► NRETRIEV ◄◄

Availability

- [Browse Entry panel on page 751](#)
- [Edit Entry panel on page 862](#)

Related tasks and examples

- [Working with data set lists on page 320](#)

OFFSET primary command

The OFFSET primary command is available for editor sessions that use a template. The command adds a value to the record length of the Level 01 field and to the starting position of all fields within the record type, shifting the layout left or right in relation to the records being processed. An offset value of 0 removes a previously supplied offset.

If a positive offset is applied, some fields might be mapped beyond the length of the record. Data that falls beyond the length of the record is not represented. You cannot edit a field where the data you supply would fall beyond the physical end of the record (whether the record is of fixed or variable length).

A negative offset moves the fields to the left and all fields with a resultant zero or negative start location are removed from the display. The offset is validated to ensure that required fields, such as OCCURS DEPENDING ON target fields or PL/I REFER fields, are not removed. If the first element of a dimensioned field is at a zero or negative start location, that field (all array elements) is removed from the display.

If an OFFSET primary command is applied when an offset has already been supplied in the template, the offset value overwrites the offset value provided in the template.

Syntax

►► Offset — *value* — { *current 01* } { *fieldname* } { ALL } ◄◄

value

The offset value is a negative or positive integer, between -32760 and +32760, that shifts the layout left or right in relation to the records being processed. An offset value of 0 removes a previously supplied offset.

fieldname

The Level 01 field name to which the offset is applied.

The default is the currently displayed Level 01 field.

Current® 01

The currently displayed Level 01 field to which the offset is applied.

ALL

The offset value is applied to all the layouts described in the currently loaded template.

Availability

- [Browse panel on page 746](#)
- [Editor panel on page 853](#)
- [Record Type Selection panel on page 998](#)
- [Copybook View and Print: Entry panel on page 814](#)
- [Copybook View and Print: View panel on page 816](#)

Related tasks and examples

- [Adjusting your view to allow for header information on page 316](#)
- [Specifying offset values on page 288](#)
- [Copybook View and Print Utility on page 260](#)

While OFFSET is not available as a standalone function, the equivalent keywords OFFSETIN and OFFSETOUT are available in the following functions:

- [DSB \(Data Set Browse\) on page 1293](#)
- [DSC \(Data Set Copy\) on page 1302](#)
- [DSE \(Data Set Edit\) on page 1342](#)
- [DSEB \(Data Set Edit Batch\) – batch only on page 1351](#)
- [DSG \(Data Set Generate\) on page 1372](#)
- [DSM \(Data Set Compare\) on page 1388](#) (equivalent keywords are OFFSETOLD and OFFSETNEW).
- [DSP \(Data Set Print\) on page 1438](#)
- [DSU \(Data Set Update\) – batch only on page 1462](#)
- [DSV \(Data Set View\) on page 1480](#)

ORDER primary command

In Browse, View, and Edit, the ORDER command sets the display order for one or more fields in TABL and SNGL display format.

Held fields are ordered in relation to other held fields. Unheld fields are ordered in relation to other unheld fields.

You can also specify a display order by typing a number in the SEQ column using the template editor.

Syntax



fieldref

A single field reference (for example, #1), a range (for example, #2-#5), or a list of single field references/ ranges separated by spaces (for example, #1 #4 #6-#7). A single field specification is #n; n is a positive integer and cannot exceed the number of fields in the template being processed.

fldname

The name of a field in the template, which is optionally preceded by the pound symbol (#). Use #RESET to avoid any syntactical ambiguity with command keywords.

seq

A positive integer that indicates the relative order for the field among other ordered fields.

Availability

The ORDER command is available on most editor panels. In particular, to allow you to modify how the data is displayed, it can be used in the following panels:

- [Browse panel on page 746](#)
- [Editor panel on page 853](#)
- [WebSphere MQ Managers panel on page 1109](#)
- [WebSphere MQ Queue List panel on page 1116](#)

Related tasks and examples

- [FREE primary command on page 1171](#)
- [HOLD primary command on page 1175](#)
- [TEDIT primary command on page 1231](#)

PACK primary command

You can use the PACK primary command in the Edit panel, to convert non-packed data to the ISPF PACK format or to unpack data that is in the ISPF PACK format.

Syntax



ON

Instructs File Manager to write the output file with ISPF PACK format when saving or exiting. ON is the default if no argument is supplied.



Note: If the data is already packed, and the **Recognize and interpret packed data** option is not turned on, issuing this command causes File Manager to “double-pack” the data.

OFF

Instructs File Manager not to use ISPF PACK format when writing the output file. If the data was in ISPF PACK format, this unpacks the data.

Availability

- [Editor panel on page 853](#)

Related tasks and examples

- [Viewing and changing packed data on page 95](#)

PASTE primary command

The PASTE command copies lines of data from a clipboard to the current edit or view session.

Syntax

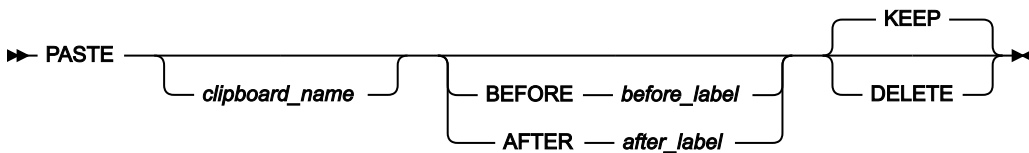

clipname

Name of a clipboard from which data is to be copied. The default High Level Qualifier (HLQ) is used. Typically, the default is the TSO PREFIX for your user ID.

before_label

Label identifying the line in the current edit or view session after which the data from the clipboard is to be copied. The label must start with a period (.) followed by one to four alphabetic characters (no numeric or special characters). Labels starting with the letter “Z” indicate an editor-assigned label.

after_label

Label identifying the line in the current edit or view session before which the data from the clipboard is to be copied. The label must start with a period (.) followed by one to four alphabetic characters (no numeric or special characters). Labels starting with the letter “Z” indicate an editor-assigned label.

KEEP

Copied data from the clipboard remains on the clipboard.

DELETE

Copied data from the clipboard removed from the clipboard.

Availability

- [Browse Entry panel on page 751](#)
- [Editor panel on page 853](#)

Related tasks and examples

- [Copying data to and from a clipboard on page 167](#)

PIC primary command

In an editor session, the PIC command toggles on and off the display of the picture clause information when in SNGL display mode. Also shows the length and scale (if non zero) for binary and packed fields, and the bit length for bit fields.

Syntax

►► PIC ◄◄

Availability

- [Browse panel on page 746](#)
- [Editor panel on page 853](#)

Related tasks and examples

- [Selecting a display format on page 105](#)

PREFIX primary command

The PREFIX primary command sets the position and display state of the prefix area.

Syntax

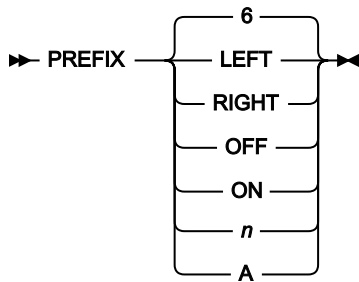

LEFT

Displays the prefix area on the left side.

RIGHT

Displays the prefix area on the right side.

OFF

Does not display the prefix area.

ON

Displays the prefix area at the position last set, with the display width last set.

n

Displays the prefix area at the position last set, with a display width of *n* digits. *n* must be in the range: 6–9.

A

Displays the prefix area at the position last set, with a display width of 6 digits or, if necessary, larger (up to 9 digits) in order to display the whole record number.

Availability

- [Editor panel on page 853](#)

PREVIOUS primary command

The PREVIOUS primary command moves to the previous "visible" record (see Note below) or, if you specify a number, moves back that number of records.



Note: In this context, "visible" means any selected, not suppressed, or not excluded record, unless those types of records are being shown in the view because of edit settings or entered SHOW commands.



Note: If you specify a number of records greater than the number of prior records, the first selected record is displayed.

Syntax

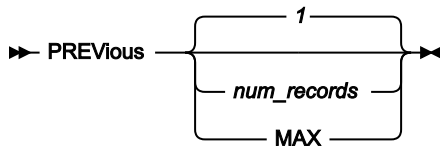

num_records

Scrolls back the specified number of records. The default is 1 record.

MAX

Scrolls to first record.

Availability

- [Browse panel on page 746](#)
- [Editor panel on page 853](#)

Related tasks and examples

- [Scrolling to see data on page 117](#)
- [Zooming in to see all of a record on page 112](#)

PREVREC primary command

When viewing segmented data in SNGL display mode, the PREVREC primary command moves to the first segment of the previous "visible" physical record or, if you specify a number, moves back that number of physical records.



Note: In this context, "visible" means any selected, not suppressed, or not excluded record, unless those types of records are being shown in the view because of edit settings or entered SHOW commands.

Syntax

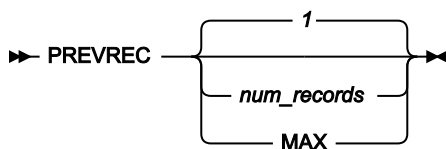

num_records

Scrolls back the specified number of physical records. The default is 1 physical record.

MAX

Scrolls to the beginning of the data set.

Availability

- [Browse panel on page 746](#) (SNGL display mode only)
- [Editor panel on page 853](#) (SNGL display mode only)

Related tasks and examples

- [Viewing segmented data on page 314](#)

PROFILE primary command

The PROFILE primary command displays the current settings in the editor session. It is similar to the ISPF PROFILE command. To remove the output lines, issue the RESET primary command or, if in an edit session, delete the lines.

Syntax

►► PROfile ◄◄

Availability

- [Browse panel on page 746](#)
- [Editor panel on page 853](#)

Related tasks and examples

- [Displaying your current editor options on page 98](#)
- [Editor options \(option 0.6\) on page 82](#)

QUIT primary command

The QUIT command is synonymous with the CANCEL command. See [CANCEL primary command on page 1124](#) for details.

RBALEN primary command

The RBALEN command provides a way to display or not display the RBA and record length information when viewing a VSAM file in a Browse session. The display of this information is initially controlled by the **Show RBA and Length when browsing VSAM** option in the Editor Options panel.

Syntax

►► RBAlen  ◄◄

ON

When you are browsing a VSAM file, the leftmost side of the multiline displays contain the RBA and the length of the record being displayed.

OFF

The RBA and the length of the record being displayed are not displayed, allowing more of the record data to be displayed on the screen.



Note: The RBALEN command is only available when browsing a VSAM file within a Browse session. You can specify either ON or OFF, regardless of the setting of the **Show RBA and Length when browsing VSAM** option in the Editor Options panel. You can issue the command multiple times.

Availability

- [Browse panel on page 746](#)
- [Editor Options panel on page 868](#)

Related tasks and examples

- [Displaying the RBA and record length information on page 99](#)

RCHANGE primary command

The RCHANGE command repeats the previous CHANGE command.

Syntax

► RCHANGE ◀

Availability

- [Editor panel on page 853](#)
- [Find/Change Utility panel on page 901](#)

Related tasks and examples

- [Finding and replacing strings on page 149](#)
- [Finding and changing data in multiple PDS members on page 368](#)
- [Handling long strings in CHANGE on page 152](#)
- [Using File Manager functions in batch jobs on page 508](#)

RD primary command

The RD primary command prints the current record.

Syntax

RD command in Disk Browse, Disk Track Edit and VSAM Update

In these panels, the RD (“Record Dump”) command prints the current record in dump format, with hexadecimal values under the record data.

Figure 394. Syntax - Disk Browse, Disk Track Edit and VSAM Update

▶▶ RD ▶▶

RD command in View and Edit

When you are in the View and Edit panels and you are using SNGL or TABL display format, the RD command is identical to the RP command. For details, see [RP primary command on page 1214](#).

In other display formats, the RD (“Record Dump”) command prints the current record in dump format, with hexadecimal values under the record data.

When issued from the View or Edit panel, additional parameters allow you to print a specified number of records, from the current record to the end of the data, or all displayed records.

Figure 395. Syntax - View and Edit

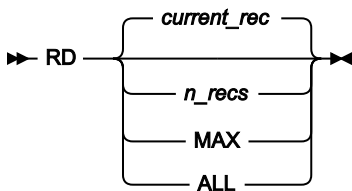

current_rec

The current record is the record in which your cursor is positioned within the data area. If your cursor is not in a record, the current record is the topmost record displayed in the data area.

n_recs

Prints the next *n* displayed records, starting from the current record.

MAX

Prints all remaining displayed records, from the current record to the end of the data set or member.

ALL

Prints all displayed records in the data set or member.



Note: In this context, “*displayed*” records are those records that are currently displayable, given the settings of the Show and Shadow commands. This includes shadow lines, that is, the “*substitute*” records that are displayed in place



of one or more records that are suppressed, excluded or not selected. For the sake of the n count, a shadow line is counted as one record, even if it represents a number of suppressed, excluded or not selected records.

Availability

- [Browse panel on page 746](#)
- [Editor panel on page 853](#)
- Disk Browse panel
- Disk Track Edit panel
- VSAM Update panel

Related tasks and examples

- [Printing a single record on page 411](#)
- [Disk Browse \(option 5.1\) on page 477](#)
- [Disk Track Edit \(option 5.2\) on page 478](#)
- [VSAM Update \(option 5.7\) on page 488](#)
- [Tape Specific Functions on page 445](#)

RDF primary command

In an editor session, this command shows or hides the Redefines information and redefines fields when in SNGL display mode and shows or hides the redefines fields when in TABL display mode.

Syntax

►► RDF ◄◄

RDF

In SNGL display mode, this toggle command shows or hides the redefines definition information, all fields with a REDEFINES clause on them, and all of their children. In TBLB display mode this command shows or hides all fields with a REDEFINES clause on them, and all of their children.

Availability

- [Browse panel on page 746](#)
- [Editor panel on page 853](#)

Related tasks and examples

- [Selecting a display format on page 105](#)

RECLLEN primary command

In multi-line formats (TABL, CHAR, HEX, and LHEX), the RECLLEN primary command sets the position and display state of the RECLLEN area.

Syntax

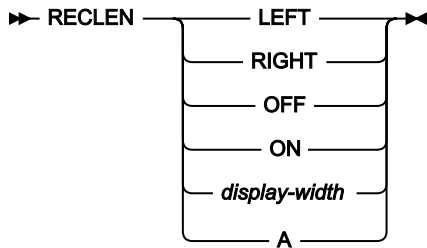

LEFT

In multi-line formats, displays the RECLLEN area on the left side.

RIGHT

In multi-line formats, displays the RECLLEN area on the right side.

OFF

Does not display the RECLLEN area.

ON

In multi-line formats, displays the RECLLEN area at the position last set.

display-width

In multi-line formats, controls the width of the record length display area. Valid values: 3, 4, 5, 6.

A

In multi-line formats, sets the width of the record length display area according to the value of the record lengths.

Availability

- [Browse panel on page 746](#)
- [Editor panel on page 853](#)

RECOVER primary command

The RECOVER primary command restores lines of data that you previously deleted during the current edit session.



Note:



1. During an Auxiliary Edit, the RECOVER command can only restore up to ten previously deleted lines of data.
2. The lines of data are restored at the point following the current top line on the panel. This may not be their original position prior to being deleted from the data set.

Syntax

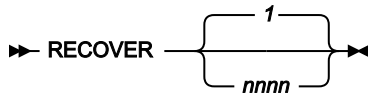

nnnn

Restore *nnnn* lines of data.

Availability

- [Editor panel on page 853](#)

Related tasks and examples

- [Deleting records on page 162](#)
- [Recovering deleted records on page 163](#)

RECSTATS primary command

The RECSTATS primary command lists statistics for the records included in the current editor session.

Syntax

►► RECStats ◄◄

Availability

- [Editor panel on page 853](#)
- [Browse panel on page 746](#)

Related tasks and examples

- [Listing statistics for the current editor session on page 96](#)

REFRESH primary command

In the Catalog Services: Data Set List panel and Display VTOC panel:

- The REFRESH primary command replaces the current list with a new list taken from the catalog or VTOC. The new list incorporates any changes that you have made, and also any changes made by other users since you first displayed the list or last refreshed it.
- You can also invoke REFRESH by pressing the Process function key (F6) to display the Process pull-down menu and selecting "Refresh".

In member selection panels, the REFRESH primary command re-reads the directory and displays the current member list.

In WebSphere® MQ selection lists, the REFRESH primary command re-reads and rebuilds the information required to display the selection list. After the command completes, you are returned to the top and leftmost column of the display (your current position is lost).

Syntax

►► REFRESH ◄◄

Availability

- [Catalog Services Data Set List panel on page 759](#)
- [Display VTOC panel on page 837](#)
- [Member Selection panel on page 946](#)
- [Specifying a data set and a member name on page 42](#)
- [Advanced copybook selection on page 208](#)
- [WebSphere MQ Managers panel on page 1109](#)
- [WebSphere MQ Queue List panel on page 1116](#)

Related tasks and examples

- [Working with a list of catalog entries on page 418](#)
- [Displaying a Volume Table of Contents \(VTOC\) on page 432](#)
- [Working with WebSphere MQ on page 439](#)

REFS primary command

The REFS primary command turns on or off the display of the Field Reference column, when in SNGL display mode.

Syntax

►► REFS ◄◄

REFS

Toggle command that shows or hides the Field Reference column when in SNGL display mode.

Availability

- [Browse panel on page 746](#)
- [Editor panel on page 853](#)

Related tasks and examples

- [Selecting a display format on page 105](#)

REPLACE, REPLACEX primary commands

The REPLACE and REPLACEX primary commands replace another member or data set with specified lines from the data in the current editor session.

Syntax

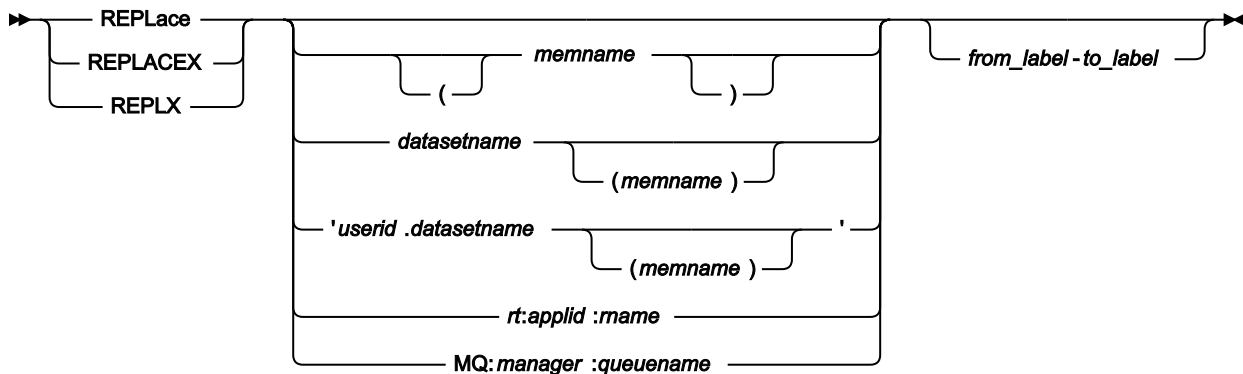

memname

Name of member to be replaced.

datasetname

Name of data set to be replaced. The default High Level Qualifier (HLQ) is used. Typically, the default is the TSO PREFIX for your user ID.

userid.datasetname

Name of fully-qualified data set to be replaced.

rt:applid:rname

You can specify a CICS® Transient Data Queue or CICS® Temporary Storage Queue in place of a data set name, where:

rt

Resource type. Valid values are:

TD

For a Transient Data Queue.

TS

For a Temporary Storage Queue.

applid

The VTAM® applid of the CICS® system.

rname

The name of the resource.

MQ:*manager.queue*name

You can specify a MQ queue, where:

manager

The MQ manager to be used. If you specify a generic name, File Manager displays a list of matching managers to select from.

***queue*name**

The queue to be used. If you specify a generic name, File Manager displays a list of matching queues to select from.

from_label

Label indicating first line to be copied into the member or data set.

to_label

Label indicating last line to be copied into the member or data set.

Availability

- [Browse Entry panel on page 751](#)
- [Editor panel on page 853](#)

Related tasks and examples

- [Managing data sets on page 320](#)

RESET primary command

The RESET command has different functionality, depending upon where it is used.

Syntax

RESET in View or Edit

In the View or Edit panels, the RESET command “cleans up” the displayed data. You use RESET to turn off the highlighting of strings found by the FIND command and, when using a template, to restore the state of the SHOW and SHADOW settings to the defaults as set in the Editor Options panels.

Figure 396. Syntax

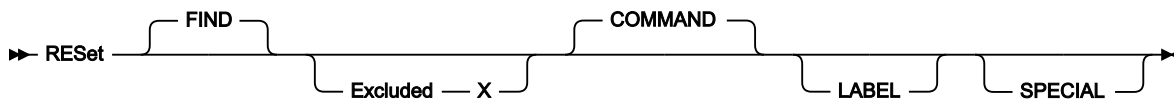
**COMMAND**

Resets all pending prefix commands.

EXCLUDED

“Unexcludes” (redispays) all excluded records.

FIND

Removes highlighting from strings or numeric values found by the FIND command.

LABEL

Removes all labels from labeled lines.

SPECIAL

Removes all special lines, such as the BOUNDS line from the display.

Entering a RESET command without any parameters:

- Resets everything except record labels (equivalent to entering RESET COMMAND EXCLUDED FIND SPECIAL), and
- Groups or ungroups not-selected and suppressed records and hides or displays shadow lines according to the current editor options settings.

RESET in member selection panels

In member selection panels the RESET command resets values entered in the prefix area that have not yet been processed and also in the **Prompt** field. You can specify a member name or a member pattern to limit the scope of the command to matching member names.

Figure 397. Syntax - member selection panels



*

Specifies that all members in the list are to be deselected.

member_name

Specifies that the named member is to be deselected. Can be a member name pattern, so that all members with a matching name are deselected.

RESET in Set DBCS Options

In the Set DBCS Options panel, the RESET primary command resets the format definitions to their default value (1,*,EB).

Figure 398. Syntax (for Set DBCS Options)



RESET in selection lists

In selection lists, the RESET primary command removes all tailorings that affect the selection list.

Figure 399. Syntax (for selection lists)

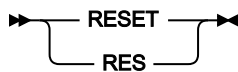

RESET in options panels

In the options panels, the RESET command resets the options displayed on the panel to the default options defined in the File Manager options module.

Figure 400. Syntax (for options panels)



Availability

- [Set Print Processing Options panel \(option 0.1\) on page 1025](#)
- [Set System Processing Options panel \(option 0.2\) on page 1031](#)
- [Set Tape Processing Options panel \(option 0.3\) on page 1034](#)
- [Editor Options panel on page 868](#)
- [VSAM Edit Sharing Options panel on page 1101](#)
- [Set Temporary Data Set Allocation Options panel on page 1036](#)
- [Set Output Data Set Allocation Options panel on page 1022](#)
- [Set Trace options panel on page 1038](#)
- [Set COBOL Processing Options panel \(option 0.5.2\) on page 1016](#)
- [Set HLASM Processing Options panel \(option 0.5.3\) on page 1020](#)
- [Set PL/I Processing Options panel \(option 0.5.4\) on page 1024](#)

Related tasks and examples

- [Setting your default processing options on page 78](#)

RF primary command

(Shared files only.) Refreshes a record element from the file being operated on. It has a slightly different meaning depending on the current display format in use:

- In SNGL display format, only the record currently displayed is refreshed
- In other display formats, such as CHAR, HEX, LHEX, or TABL, all records are refreshed.



Note: Any pending changes to records are discarded during the REFRESH process.

Syntax

► RF ◄

Availability

- [Editor panel on page 853](#)

Related tasks and examples

- [Working with File Manager and shared files on page 132](#)

RFIND primary command

The RFIND primary command repeats the search performed by the previous FIND primary command.

Syntax

► RFIND ◄

When your cursor is positioned in the body of the data, RFIND finds the next instance of *string* down from the cursor position. When your cursor is outside of the data area, RFIND finds the first instance of *string*. If you press the RFIND function key (F5), you can easily move to the each instance of *string*, as your cursor remains in the data area after the command is issued. However, if you type the RFIND command on the Command line, you need to reposition your cursor on the last instance of *string* and then press Enter, in order to find the next instance.

Availability

- [Browse panel on page 746](#)
- [Editor panel on page 853](#)
- [Find/Change Utility panel on page 901](#)
- [Catalog Services Data Set List panel on page 759](#)
- [Display VTOC panel on page 837](#)
- [AFP Print Browse panel on page 730](#)
- [Memory Browse panel on page 952](#)
- [Display VTOC Data Set List panel on page 843](#)
- [Volume Summary/Selection panel on page 1097](#)

- [WebSphere MQ Managers panel on page 1109](#)
- [WebSphere MQ Queue List panel on page 1116](#)

Related tasks and examples

- [Finding specific data on page 125](#)
- [Finding and changing data in multiple PDS members on page 368](#)
- [Working with a list of catalog entries on page 418](#)
- [Displaying a Volume Table of Contents \(VTOC\) on page 432](#)
- [Browsing AFP Print documents on page 437](#)
- [Browsing your user storage on page 437](#)
- [Working with WebSphere MQ on page 439](#)

RIGHT primary command

You can use the RIGHT primary command in:

- View or Edit
- A WebSphere® MQ selection list

In View or Edit, any display format apart from SNGL, the RIGHT primary command scrolls to the right of your data. (This command is not valid in SNGL mode.)

The amount (number of columns) scrolled is determined by either an optional parameter or, if no parameter is entered, by the amount indicated in the **Scroll** field.

Syntax

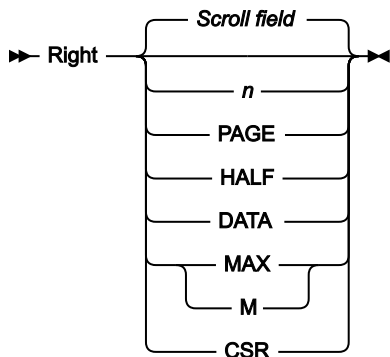

n

In View or Edit

In CHAR, HEX or LHEX display format, scrolls right *n* columns. In TABL display format, scrolls right *n* fields.

In a WebSphere® MQ selection list

Scrolls right n columns.

CSR

Scrolls right to the cursor position.

DATA**In View or Edit**

In TABL display format, acts the same as **PAGE**. In other display formats, scrolls right one column less than a page of data.

In a WebSphere® MQ selection list

Acts the same as **PAGE**.

HALF

Scrolls right half a page of data.

MAX**In View or Edit**

In CHAR, HEX or LHEX display format, scrolls to rightmost column. In TABL display format, scrolls to the rightmost field.

In a WebSphere® MQ selection list

Scrolls to rightmost column.

PAGE

Scrolls right one page of data.

Scroll field

Scrolls right by the amount indicated in the **Scroll field**. This is the default if no parameter is used. Entering a parameter other than MAX in the scroll field changes the scroll field default. If MAX is entered, the scroll field reverts to the previous setting after the command is issued.

Availability

Available on all panels when the panel information cannot be seen within one screen. In particular, it is used in the following panels, to allow you to view data:

- [Browse panel on page 746](#)
- [Editor panel on page 853](#)
- [WebSphere MQ Managers panel on page 1109](#)
- [WebSphere MQ Queue List panel on page 1116](#)

Related tasks and examples

- [Scrolling to see data on page 117](#)
- [Working with WebSphere MQ on page 439](#)

RP primary command

The RP (“Record Print”) command prints the current record. The format of the output from the RP command depends on the display format when you enter the RP command.

Syntax

RP command in Disk Browse, Disk Track Edit or VSAM Update

Figure 401. Syntax - Disk Browse, Disk Track Edit or VSAM Update

▶▶ RP ▶▶

RP command in View or Edit

When issued from the View or Edit panel, additional parameters allow you to print a specified number of records, from the current record to the end of the data, or all displayed records.

Figure 402. Syntax

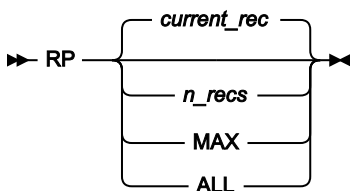

current_rec

The current record is the record in which your cursor is positioned within the data area. If your cursor is not in a record, the current record is the topmost record displayed in the data area.

n_recs

Prints the next *n* displayed records, starting from the current record.

MAX

Prints all remaining displayed records, from the current record to the end of the data set or member.

ALL

Prints all displayed records in the data set or member.



Note: In this context, “*displayed*” records are those records that are currently displayable, given the settings of the Show and Shadow commands. This includes shadow lines, that is, the “*substitute*” records that are displayed in place



of one or more records that are suppressed, excluded or not selected. For the sake of the n count, a shadow line is counted as one record, even if it represents a number of suppressed, excluded or not selected records.

Availability

- [Browse panel on page 746](#)
- [Editor panel on page 853](#)
- Disk Browse panel
- Disk Track Edit panel
- VSAM Update panel

Related tasks and examples

- [Printing a single record on page 411](#)
- [Disk Browse \(option 5.1\) on page 477](#)
- [Disk Track Edit \(option 5.2\) on page 478](#)
- [VSAM Update \(option 5.7\) on page 488](#)
- [Tape Specific Functions on page 445](#)

RUNTEMP primary command

The RUNTEMP primary command runs the current function with the template changes you have made but does not save the changes. This command is only available when running a function that uses a template.

Syntax

▶▶ RUNTEMP ◀◀

Availability

- [Field Selection/Edit panel on page 891](#)

Related tasks and examples

- [Creating a copybook template with the Template Workbench on page 211](#)

SAVE primary command

The SAVE primary command saves any changes made to a data set without ending the Edit session.



Note: This command is not supported when editing a large file using an auxiliary data set. With auxiliary editing, you must save the data by ending the edit session with the END, EXIT or FILE command, and then, if required, re-edit the data set.

Syntax

► SAVE ◄

Availability

- [Editor panel on page 853](#)
- [Dynamic Template panel on page 845](#)
- [Record Identification Criteria panel on page 982](#)
- [Record Selection Criteria panel on page 991](#)
- [Field Selection/Edit panel on page 891](#)

Related tasks and examples

- [Saving changes without ending the Edit session on page 99](#)

SAVEAS primary command (templates)

The SAVEAS primary command (for templates) displays the Save panel, where you can save a template as another name.

Syntax

► SAVEAs ◄

Availability

- [Field Selection/Edit panel on page 891](#)

Related tasks and examples

- [Editing a template on page 218](#)

SAVEAS, SAVEASX primary commands (data)

The SAVEAS and SAVEASX primary commands (for data) save the currently exposed data in the current editor session to another member or data set.

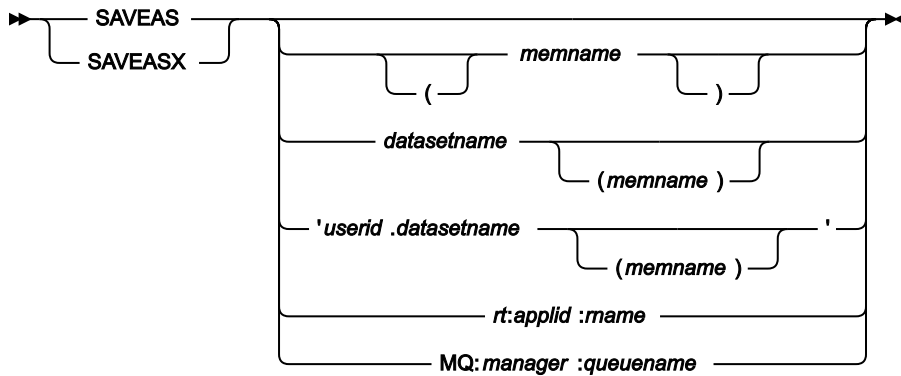
Syntax**memname**

Name of member to be created.

datasetname

Name of data set to be created. The default High Level Qualifier (HLQ) is used. Typically, the default is the TSO PREFIX for your user ID.

userid.datasetname

Name of fully-qualified data set to be created.

rt:applid:rname

You can specify a CICS® Transient Data Queue or CICS® Temporary Storage Queue in place of a data set name, where:

rt

Resource type. Valid values are:

TD

For a Transient Data Queue.

TS

For a Temporary Storage Queue.

applid

The VTAM® applid of the CICS® system.

rname

The name of the resource.

MQ:manager:queuename

You can specify a MQ queue, where:

manager

The MQ manager to be used. If you specify a generic name, File Manager displays a list of matching managers to select from.

queuename

The queue to be used. If you specify a generic name, File Manager displays a list of matching queues to select from.

Availability

- [Browse Entry panel on page 751](#)
- [Editor panel on page 853](#)

Related tasks and examples

- [Managing data sets on page 320](#)

SELECT primary command

The SELECT primary command is used to select members or fields, depending upon where it is used. It can be entered on the following panels:

- Member selection
- Field Selection/Edit

Syntax

SELECT in member selection panels

The SELECT primary command is used to select members listed in member selection panels. It performs the equivalent processing of the S prefix command against member names matching the supplied pattern or member name.

SELECT results in one of the following:

- A single member is selected and returned to the calling routine. (Subsequent selections are ignored.)
- Toggling of the selected value in the **Prompt** field.
- Selects a member to be processed by the function that invoked the member list.

You can clear the selection of members with the RESET command.

Syntax for member selection panels:

Figure 403. Syntax - Member Selection panel

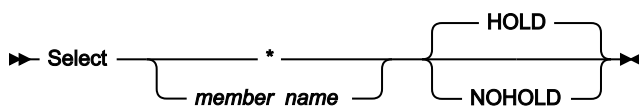

*

Specifies that all members in the list are to be selected.

member_name

Specifies that the named member is to be selected. Can be a member name pattern, to select all members with a matching name.

HOLD

Default. Specifies that after selecting one or all members you wish to pause before processing commences. Whilst in HOLD mode, you can scroll UP and DOWN to view selected members and select or deselect members to refine your list. Pressing Enter causes processing to commence. You can use the LOCATE command whilst in pause mode and processing does not commence until you press Enter again.



Note: For functions where the SELECT command toggles selection, this parameter is ignored and the behaviour is always NOHOLD.

NOHOLD

Specifies that processing is to be run immediately.



Note: For functions where the SELECT command toggles selection, this parameter is ignored and the behaviour is always NOHOLD.

Examples

```
SELECT MBR
```

Selects the single member, MBR.

```
SELECT *
```

Selects all the listed members.

```
SELECT a*
```

Selects all the listed members starting with the letter "A".

```
SELECT *z
```

Selects all the listed members ending with the letter "Z".

SELECT in Field Selection/Edit

In the Field Selection/Edit panel, this command selects or deselects all of the listed fields.

Figure 404. Syntax - Field Selection/Edit panel

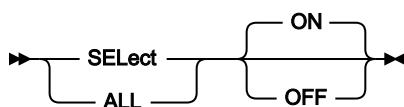

ALL

Denotes all fields.

ON

Select all fields.

OFF

Deselect all fields.

Availability

- [Member Selection panel on page 946](#)
- [Field Selection/Edit panel on page 891](#)

Related tasks and examples

- [Specifying a data set and a member name on page 42](#)
- [Advanced copybook selection on page 208](#)

SHADOW primary command

The SHADOW primary command hides or shows shadow lines. A shadow line is a line that represent a group of records that are not-selected, suppressed, or have been excluded by the EXCLUDE command.

For a description of not-selected and suppressed records, see [Filtering record display using templates on page 309](#).

For information about using the EXCLUDE command, see [EXCLUDE/XX primary command on page 1148](#).

Syntax

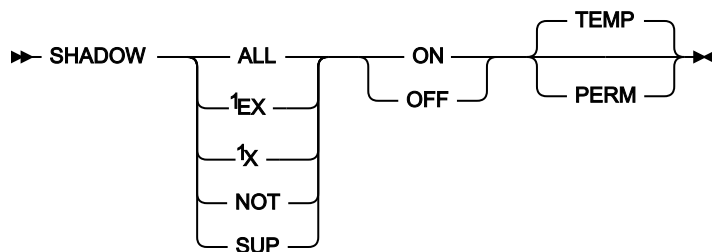

Notes:

¹ Edit only

ALL

Show or hide all types of shadow lines.

EX

Show or hide shadow lines for “excluded” records.

NOT

Where supported, show or hide not-selected records shadow lines.

OFF

Hide the specified types of shadow lines.

ON

Show the specified types of shadow lines.

PERM

The shadow setting is saved in your user profile, and applies to this and future File Manager sessions until changed. Issuing the command changes the equivalent **Show shadow lines...** settings on the Editor Options (option 0.8) panel.

SUP

Where supported, show or hide suppressed records shadow lines.

TEMP

Shadow setting applies to the current Edit session only. This is the default.

X

Same as EX.

Availability

- [Browse panel on page 746](#)
- [Editor panel on page 853](#)

Related tasks and examples

- [Filtering record display using templates on page 309](#)
- [Displaying "suppressed" records on page 309](#)
- [Displaying "not-selected" records on page 311](#)

SHOW (FLD) primary command

In Browse, View, and Edit, the SHOW (FLD) command adds a hidden field to the data display. You can hide a field from display by using the HIDE editor primary command or by using the S prefix command in the template editor.



Note: The SHOW command has two usages; the other usage applies to records, and it is described in section [SHOW \(REC\) primary command on page 1222](#).

Syntax

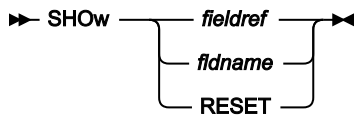

fieldref

A single field reference (for example, #1), a range (for example, #2-#5), or a list of single field references/ranges separated by spaces (for example, #1 #4 #6-#7). A single field specification is #n; n is a positive integer and cannot exceed the number of fields in the template being processed.

fldname

The name of a field in the template, which is optionally preceded by the pound symbol (#). Use #ALL, #NOT, #SUP, and #RESET to avoid any syntactical ambiguity with command keywords.

Availability

The SHOW (FLD) command is available on most editor panels. In particular, to allow you to modify how the data is displayed, it can be used in the following panels:

- [Browse panel on page 746](#)
- [Editor panel on page 853](#)
- [WebSphere MQ Managers panel on page 1109](#)
- [WebSphere MQ Queue List panel on page 1116](#)

Related tasks and examples

- [HIDE primary command on page 1173](#)
- [SHOW \(REC\) primary command on page 1222](#)
- [TEDIT primary command on page 1231](#)

SHOW (REC) primary command

Use the SHOW (REC) command to expose or group *not-selected* and *suppressed* records: for a definition of these terms, see [Filtering record display using templates on page 309](#). Records that have been grouped using the SHOW command can be represented by shadow lines. You can display or hide the shadow lines with the SHADOW command.

The SHOW command lets you see records that, by default, would not be displayed. Using the SHOW command, you can review records that contain erroneous or corrupt data.

When the display format is TABL, only fields from one record type can be displayed at any one time. Because of this, even with SHOW SUP ON, it is not possible to format records that have a different record type than the one currently being

displayed. Instead, each record belonging to another record type is represented by a line (similar to a shadow line) that contains the name of the record type for that record.

If you show not-selected records in SNGL or TABL display format, then File Manager attempts to interpret and format data according to the field definitions for the current record type.



Note: The SHOW command has two usages; the other usage applies to fields, and it is described in section [SHOW \(FLD\) primary command on page 1221](#).

Syntax

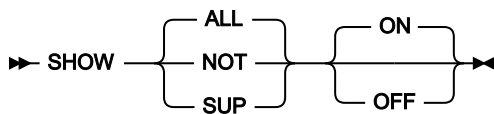

ALL

Show or group both not-selected and suppressed records.

NOT

Show or group not-selected records.

SUP

Show or group suppressed records.

ON

Show the specified types of records in addition to records currently shown.

OFF

Group the specified types of records.

Availability

- [Browse panel on page 746](#)
- [Editor panel on page 853](#)

Related tasks and examples

- [Filtering record display using templates on page 309](#)
- [Displaying "suppressed" records on page 309](#)
- [Displaying "not-selected" records on page 311](#)

SHOWCOB primary command

The SHOWCOB command displays details showing which COBOL compiler is currently being used.

Syntax

► SHOWCOB ◄

Availability

Available on all panels

Related tasks and examples

- [Checking which COBOL compiler you're using on page 39](#)

SLOC primary command

In an editor session, the SLOC command toggles on and off the display of the Start location of each field when in SNGL display mode.

Syntax

► SLOC ◄

Availability

- [Browse panel on page 746](#)
- [Editor panel on page 853](#)

Related tasks and examples

- [Selecting a display format on page 105](#)

SORT primary command

The SORT command changes the order of the data you are viewing.

In an editor session, by default, File Manager sorts data in ascending order. For VTOC data sets and member lists, the default sequence depends on the sort criteria you specify.

Syntax

SORT command in View or Edit

In View and Edit, File Manager sorts the data using a hierarchy of keys starting with the first column or field parameter as the primary key, and subsequent columns or fields as less significant keys. The hierarchy is specified left to right.

If you do not specify any parameters for the SORT primary command, File Manager sorts the data record by record, according to each record's hexadecimal representation.

The sort order is based on EBCDIC (hex) values in the specified columns or fields, therefore, lowercase characters are sorted before uppercase characters.

When you use the SORT primary command, you can optionally specify that only excluded, or only not-excluded, records are sorted.

Figure 405. Syntax: View and Edit

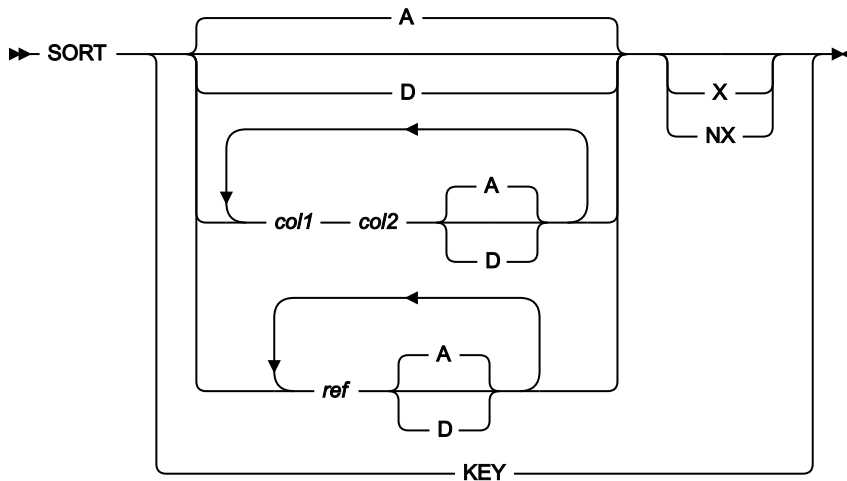

A

Sort data in ascending sequence. This is the default.

D

Sort data in descending sequence.

col1

(CHAR, HEX, or LHEX display formats only.) The first column to be included in the column range to be used as a sort key. Must be greater than or equal to 1, and less than or equal to the maximum record length. You can specify up to five pairs of column range values.

col2

(CHAR, HEX, or LHEX display formats only.) The last column to be included in the column range to be used as a sort key. Must be greater than *col1* and less than or equal to the maximum record length. If *col1* is specified, then *col2* must also be specified.

ref

(TABL and SNGL display format only.) A field reference, specifying the field to be used as the sort key, for example: #3. To sort a TABL display format, you *must* provide at least one field reference.

When the field is an item in an array, you must specify a subscript in parentheses to identify the occurrence that you want to use, for example: #5(3). If your field is part of a multi-dimensional array, you must specify a subscript for each dimension in the array, for example #7(2,3).

You can specify up to 5 field references. Multiple field references must be separated by a blank, for example: #3 #5(3). The first reference specifies the primary (most significant) key, the second reference specifies the secondary (2nd most significant) key, and so on. Sorting proceeds from the most significant key to the least significant key.

SORT does not support fields with varying length or varying starting positions. If one of these fields is specified, an error message is displayed.

NX

Not-excluded records only. Sorts records as if any excluded records did not exist. If you subsequently display excluded records, they may be interspersed with the sorted non-excluded records.

X

Excluded records only. Sorts excluded records as if any not-excluded records did not exist. If you subsequently display non-excluded records, they may be interspersed with the sorted excluded records.

KEY

Sort a KSDS, VRDS, or RRDS VSAM data set into the KEY sequence of the file. Typically you use SORT KEY after performing other sort operations on the data. The SORT KEY function “restores” the records into the original key sequence of the file.

This option only sorts non-excluded records. So `SORT KEY` is the equivalent of `SORT KEY NX` (even though you cannot specify the NX).



Note: When you sort a RRDS file using SORT KEY, File Manager sorts the RRDS into VSAM SLOT sequence. The SLOT number is a unique number that the VSAM access method allocates for each record. If the records of the RRDS file have been re-ordered by moving records via a move (M, Mn, or MM) prefix command or SORT primary command, SORT KEY re-orders the records as they were when the file was opened. However, when you *add* records using insert (I or In), copy (C, Cn, or CC), or repeat (R, Rn, RR, or RRn) prefix commands, the new records do not have a SLOT number assigned as the file is still in memory. In this case, SORT KEY re-orders the new records at the bottom of the file.

SORT command in selection list panels

You can use the SORT command to sort specified column names in a panel showing a selection list.

When more than one column is to be sorted, the sequence in which you specify the columns has no impact on the sequence in which the columns are sorted. The columns are always sorted from left to right.

If you do not specify a sort order (A or D) for a column, the default sort order for that column is used. You can find the default sort order for a column in the Column Settings panel. To display this panel, position the cursor on the filter value for the column and press Enter.

After the SORT command has been entered, the list display is scrolled to the top with the order reflecting the changes after applying the sort to the specified columns.

Figure 406. Syntax: selection list panels

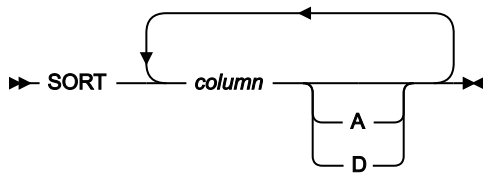

Notes:

¹ You can specify up to 5 columns to be sorted.

column

Column to be sorted.

A

Sort column in ascending order.

D

Sort column in descending order

Availability

- [Browse panel on page 746](#)
- [Editor panel on page 853](#)
- [Display VTOC Data Set List panel on page 843](#)
- [Volume Summary/Selection panel on page 1097](#)
- [Member Selection panel on page 946](#)
- [Template Member List panel on page 1064](#)

Related tasks and examples

- [Sorting the data on page 123](#)
- [Displaying a Volume Table of Contents \(VTOC\) on page 432](#)
- [Specifying a data set and a member name on page 42](#)
- [Advanced copybook selection on page 208](#)

SPLT primary command

Splits a line in two: either the line containing the cursor, at the cursor position, or the top line at the current column position.

Syntax

▶▶ SPLT ◀◀

Availability

- [Editor panel on page 853](#)

Related tasks and examples

- [Splitting and joining lines on page 170](#)

SPLTJOIN primary command

Splits or joins lines, depending on the position of the cursor. If the cursor position in a line or the current column position is after the last non-blank character, a join operation is performed. Otherwise a split operation is performed. SPLTJOIN can be abbreviated to SJ.

Syntax



Availability

- [Editor panel on page 853](#) (only while in CHAR, HEX, or LHEX display formats)

Related tasks and examples

- [Splitting and joining lines on page 170](#)

STR primary command

The STR primary command is available:

In an editor session

The STR command toggles on and off the display of the template structure information (field/element level) for each field when in SNGL display mode.

In template edit

The STR command toggles the displaying of the structure (level information) in the Field Name area of the display. The current setting is remembered for future sessions. This command is not available when processing a dynamic template.

Syntax

▶▶ STR ▶▶

Availability

- [Browse panel on page 746](#)
- [Editor panel on page 853](#)

Related tasks and examples

- [Selecting a display format on page 105](#)

STATS primary command

The STATS primary command displays the VSAM Extent Detail panel.

Syntax

▶▶ Stats ▶▶

Availability

- [AIX Entry Detail panel on page 734](#)
- [VSAM Entry Detail panel on page 1102](#)

Related tasks and examples

- [Statistics for VSAM data sets on page 423](#)

SV primary command

In SNGL display format, the SV primary command saves the changes to the current record without ending the edit session. (Shared files only.)

Syntax

▶▶ SV ▶▶

Availability

- [Editor panel on page 853](#)

Related tasks and examples

- [Working with File Manager and shared files on page 132](#)

TAILOR primary command

The TAILOR command provides a list of columns and their attributes for the current selection list. You can change the attributes in order to customize or limit the display. Changeable attributes include:

The column attributes you can change are:

Order

A numerical value specifying the relative order (left to right) in which the column is displayed.

If you specify a value of 0 for **Order**, the column is suppressed from being displayed.

Sort

Specifies how the data in the column is to be sorted:

A

Sort data in ascending order.

D

Sort data in descending order.

N

Do not sort the data.

Hold

Specifies if the column is to be made non-scrollable:

N

Y

Width

The width of the column.

Filter

Restricts the data displayed in a selection list to data that matches the specified filter string.

You can specify wildcard characters in the filter.

Filtering is performed using a generic trailing match. That is, if the start of the data in the column being filtered matches the filter string, it is considered a match. For example, a filter of `PEA` matches PEA and PEAR, but not APPEAR.

Matching of data to filters is not case-sensitive. For example, a filter of `PEA` matches PEA, PEAR, Pea and pear.

You can specify any of these operators as the first character of the filter:

>

Greater than.

<	Less than.
=	Equal to.
!	Not equal to.

When a column contains a filter parameter, the title is shown in yellow.



Note: You cannot use the TAILOR primary command with the selection list displayed for the TAILOR operation.

Syntax

▶▶ TAILOR ◀◀

Availability

Available for all selection list panels.

Related tasks and examples

- [Working with WebSphere MQ on page 439](#)

TEDIT primary command

The TEDIT command displays different template editing panels, depending upon the type of template currently in use. When you have finished editing the template, you return to viewing the data set.

Syntax

▶▶ TEDIT ◀◀
 └── TE ─┘

If you are using a dynamic template or a copybook template with only one record type that has been identified, the TEDIT command displays the Field Selection/Edit panel, in which you can select fields and specify record selection criteria.

If you are using a copybook template with more than one record type that has been identified, the TEDIT command displays the Record Type Selection panel, in which you can select or edit records by type.

If you are not currently using a template, the TEDIT command acts like the TVIEW command, and shows the Template Workbench main panel, where you can create, select, and optionally edit a template before returning to viewing the data set with the template.

You can abbreviate the command TEDIT to TE.

Availability

- [Browse panel on page 746](#)
- [Editor panel on page 853](#)

Related tasks and examples

- [Editing a template on page 218](#)

TOP primary command

The TOP primary command scrolls to the first page of data. You can abbreviate the command TOP to T.

Syntax

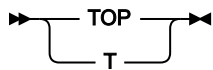

Availability

Available on all panels when the panel information cannot be seen within one screen. In particular, it is used in the following panels, to allow you to view data:

- [Browse panel on page 746](#)
- [Editor panel on page 853](#)
- [WebSphere MQ Managers panel on page 1109](#)
- [WebSphere MQ Queue List panel on page 1116](#)

Related tasks and examples

- [Scrolling to see data on page 117](#)
- [Working with WebSphere MQ on page 439](#)

LPRINT primary command

The TPRINT primary command sends the current template to the output destination specified in your Print Processing Options.

Syntax

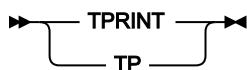

Availability

- [Field Selection/Edit panel on page 891](#)

Related tasks and examples

TVIEW primary command

The TVIEW command shows the Template Workbench, where you can create, select, and optionally edit a template before returning to browsing the data set with the template.

Use the TVIEW command:

- If you are already using a template, but want to switch to using a different template.
- If you are not currently using a template, and want to create or select a template.

You can abbreviate the command TVIEW to TV.

The OFF parameter disables the current view and shows all records.



Note: Issuing the TV command followed by a F3 (Exit) or F12 (Cancel) is synonymous to a TV OFF command. You must issue the RC or RT command to resume edit with a template from the workbench.

Syntax

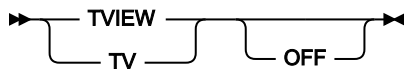

Availability

- [Browse panel on page 746](#)
- [Editor panel on page 853](#)

Related tasks and examples

- [Editing a template on page 218](#)

TYPE primary command

The TYPE primary command turns on or off the display of the Type and Len (field length) columns, when in SNGL display mode.

Syntax

▶ TYPE ▶

TYPE

Toggle command that shows or hides the Type and Len columns when in SNGL display mode.

Availability

- [Browse panel on page 746](#)
- [Editor panel on page 853](#)

Related tasks and examples

- [Selecting a display format on page 105](#)

UP primary command

The UP primary command scrolls up (backward) through your data.

The amount (number of lines) scrolled is determined by either an optional parameter or, if no parameter is entered, by the amount indicated in the **Scroll field**.

Syntax

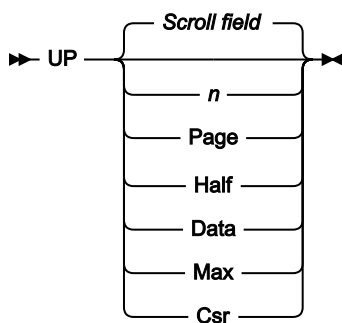

nnnn

Scroll up *nnnn* lines.

Csr

Scroll up to the cursor position.

Data

Scroll up one line less than a page of data.

Half

Scroll up half a page of data.

Max

Scroll to top of file. This has the same effect as the TOP command.

Page

Scroll up one page of data.

Scroll field

Scroll up by the amount indicated in the **Scroll field**. This is the default if no parameter is used.

Availability

Available on all panels when the panel information cannot be seen within one screen. In particular, it is used in the following panels, to allow you to view data:

- [Browse panel on page 746](#)
- [Editor panel on page 853](#)
- [WebSphere MQ Managers panel on page 1109](#)
- [WebSphere MQ Queue List panel on page 1116](#)

Related tasks and examples

- [Scrolling to see data on page 117](#)
- [Working with WebSphere MQ on page 439](#)

UPDATE primary command

The UPDATE primary command compiles the specified copybook and either updates an existing template or creates a new template.

Syntax

►► UPDATE ◄◄

Availability

- [Copybook Selection panel on page 810](#)

Related tasks and examples

- [Advanced copybook selection on page 208](#)

VCONTEXT primary command

The VCONTEXT primary command is used in the FCH Utility panel to change the output display of the search results. When the LIST=LONG option is specified for a FIND, FINDNOT or CHANGE command, the records containing the target string are displayed in the output listing. The VCONTEXT command, which can be entered as VCON, allows the "found" record to be displayed in context by allowing the user to specify the number of records to be displayed before and after the "found" record.

Syntax

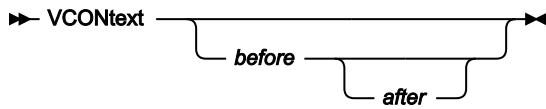

before

Indicates the number of records to be displayed BEFORE the record containing the found string.

after

Indicates the number of records to be displayed AFTER the record containing the found string. If *after* is not specified, it defaults to the same value as *before*.



Note: If neither value is specified, both are reset to zero.

Availability

- [Find/Change Utility panel on page 901](#)

Related tasks and examples

- [Specifying context in the output listing on page 376](#)

VER primary command

The VER command displays the File Manager release and PTF level, and indicates whether or not File Manager is APF-authorized.

If the VER command already exists in the ISPF command table at your site, you can use the LVL synonym to perform the same task.

Syntax

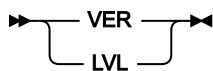

Availability

Available on all panels

Related tasks and examples

- [Checking your File Manager version on page 37](#)
- [VER \(Display Service Level\) on page 1607](#)

VIEW primary command

The VIEW primary command displays currently suppressed records of the record type indicated by the shadow line selected by the cursor. Records of other record types are suppressed from display. To use the VIEW command, type `VIEW` on the Command line, position the cursor on the shadow line of the suppressed records you want to view, then press Enter.

Syntax

Availability

- [Browse panel on page 746](#)
- [Editor panel on page 853](#)

Related tasks and examples

- [Changing display of the record type on page 310](#)

VOLUME primary command

The VOLUME primary command displays volume information for a VSAM or non-VSAM data set. The information is displayed in a pop-up Volume Information panel showing a list of allocated volumes for the selected data set.

Syntax

Availability

- [VSAM Entry Detail panel on page 1102](#)
- [Non-VSAM Entry Detail panel on page 957](#)

Related tasks and examples

- [Displaying volume information on page 424](#)

WIDTH primary command

In Browse, View, and Edit, the WIDTH command sets the display width for one or more fields in TABL display format. You can also specify a display width by specifying a value in the output width field on the field attributes panel in the template editor; use the E prefix command to access the field attributes panel.

Syntax

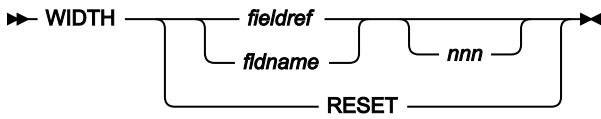

fieldref

A single field reference (for example, #1), a range (for example, #2-#5), or a list of single field references/ ranges separated by spaces (for example, #1 #4 #6-#7). A single field specification is #n; n is a positive integer and cannot exceed the number of fields in the template being processed.

fldname

The name of a field in the template, which is optionally preceded by the pound symbol (#).

nnn

A positive integer that represents the desired display width for the fields. If this parameter is omitted, the display width is reset to the default value. The minimum value of *nnn* is 6. The maximum value of *nnn* depends on the data type:

Table 23. Maximum value of parameter *nnn* for different data types

Data Type	Maximum value of <i>nnn</i>
binary integer	30
binary floating point	35
packed decimal	45
Other data types	If the value of the display length is less than 20, the maximum value of <i>nnn</i> is 30. Otherwise, the maximum value of <i>nnn</i> is the value of the display length plus 10.

Availability

The WIDTH command is available on most editor panels. In particular, to allow you to modify how the data is displayed, it can be used in the following panels:

- [Browse panel on page 746](#)
- [Editor panel on page 853](#)
- [WebSphere MQ Managers panel on page 1109](#)
- [WebSphere MQ Queue List panel on page 1116](#)

Related tasks and examples

- [TEDIT primary command on page 1231](#)

XD primary command

The XD command converts a hexadecimal value to its equivalent decimal value.

Syntax

► XD — *hexadecimal_value* ◄

Availability

Available on all panels.

Results

Related tasks and examples

[Using hexadecimal values in File Manager on page 73](#)

ZOOM primary command

In CHAR, HEX and LHEX display formats, the ZOOM primary command limits the display to just one record, showing you all of the data in the record without having to scroll left or right.

In SNGL and TABL display formats, zooming in shows all fields in the record presented in SNGL display format, rather than only those fields selected by the template.

The ZOOM command zooms in on the record selected by the cursor, or the top record displayed if the cursor is not positioned on a record.

To zoom back out to the display format that was current prior to zooming in, enter the ZOOM command again.

Syntax

► ZOOM ◄

Availability

- [Browse panel on page 746](#)
- [Editor panel on page 853](#)

Related tasks and examples

- [Zooming in to see all of a record on page 112](#)
- [Changing the length of a record on page 171](#)

Chapter 21. Functions

This chapter contains information about the File Manager functions that you can use to perform File Manager tasks. It also contains information about the File Manager-supplied REXX external functions that can be used in REXX procedures and template criteria expressions run within File Manager.

The File Manager functions can be invoked from batch jobs using JCL, within TSO as commands, and from REXX and CLIST procedures. The REXX external functions are only made available to a REXX environment running under the control of a File Manager function.

How to use this reference chapter

This chapter lists the File Manager functions in alphabetical order, followed by the REXX external functions in alphabetical order.

The following subsections are supplied, where relevant, for each function:

Purpose

A short summary of what you can do with the function.

Usage notes

A more detailed explanation of the function.

Options

A more detailed explanation of the function.

Return Codes

Lists the return codes that are specific to the function.

Related functions

Other functions that are related in some way (for example, if the function is for tapes, the list of other tape functions).

Syntax

A syntax diagram, followed by a parameter list. The parameter list describes the parameter, and shows (where appropriate) its maximum value and default value.

If you specify parameters that are not relevant to the function, File Manager ignores them. If you specify the same parameter more than once, File Manager uses the first value that you specify.

Batch example

A listing of a sample batch job.

How to read the syntax diagrams

Function syntax is described using the structure defined below.

- Read the syntax diagrams from left to right, from top to bottom, following the path of the line.

The \blacktriangleright — symbol indicates the beginning of a statement.

The — \blacktriangleright symbol indicates that a statement is continued on the next line.

The \blacktriangleright — symbol indicates that a statement is continued from the previous line.

The — \blacktriangleleft symbol indicates the end of a statement.

- Required items appear on the horizontal line (the main path).

Figure 407.

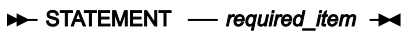

- Optional items appear below the main path.

Figure 408.

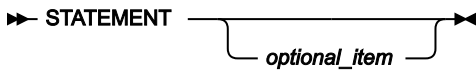

- If a default value is provided for an item (that is, if no parameter is specified, the default is used), the default item appears above the main path.

Figure 409.



- If you can choose from two or more items, they appear vertically, in a stack.

If you *must* choose one of the items, one item of the stack appears on the main path.

Figure 410.

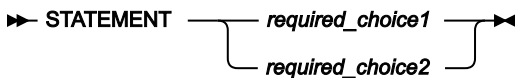

If choosing one of the items is optional, the entire stack appears below the main path.

Figure 411.

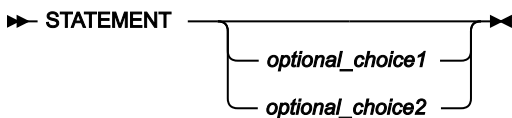

If choosing an item is optional, but when no selection is made, the default is used, the default appears above the line and the remaining optional choices below the line.

Figure 412.

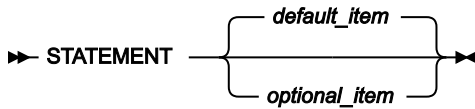

- An arrow returning to the left above the main line indicates an item that can be repeated.

Figure 413.

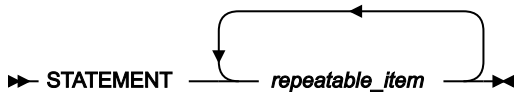

- Keywords (for example, INPUT) appear in uppercase letters. They must be spelled exactly as shown.
- Variables (for example, *nirecs*) appear in lowercase letters. They represent user-supplied names or values.

Related topics

[Using File Manager functions in batch jobs on page 508](#)

General tips about performance when you use File Manager functions

The following tips are provided as a guide to improving performance when using File Manager functions:

• Reading sequential input files with DFSORT

- For the best overall File Manager product performance, it is strongly recommended, for all File Manager installations, that DFSORT be made available to File Manager so that it can use DFSORT I/O technology. For details, see the *File Manager for z/OS Customization Guide*.



Note: It is not necessary for you to have a DFSORT license in order for File Manager to use DFSORT technology.

- DFSORT technology can be used by File Manager in interactive operations such as certain File Manager edit and browse scenarios. It can also be used by File Manager for both interactive and batch executions of the File Manager utilities, Data Set Copy (DSC) and Data Set Print (DSP).
- For the DSC and DSP utilities, File Manager attempts to use DFSORT technology when reading:
 - Sequential (DSORG=PS) data sets.
 - A VSAM file, provided there are FASTPROC (DFSORT) commands in the user PROC. If there is no user PROC, or the PROC contains no FASTPROC statements, File Manager uses its own VSAM I/O.
- For DSC, when File Manager chooses to use DFSORT technology to read an input file, it may also use DFSORT to write the primary output data set.
- Development measurements show that File Manager using DFSORT technology can reduce sequential (DSORG=PS) I/O (EXCPs) by two orders of magnitude. File Manager using DFSORT technology can also significantly reduce CPU utilization, compared to File Manager without access to DFSORT technology. Both I/O and CPU performance gains are greatest in the simplest situations where little or no special File Manager

processing is required. The CPU gains can also be significant when all, or a large portion, of any record reformatting or other work can be done by DFSORT using FASTPROC (DFSORT) commands.

- File Manager can use DFSORT technology even if it needs to process individual records, such as when using a PROC or a template or copybook. However, some things can prevent File Manager from using DFSORT I/O technology on a particular sequential input file:
 - An IO exit is being used on the input data set.
 - The input data set:
 - Is a concatenated data set with unlike attributes.
 - Is an LRECL=X data set.
 - Is a HFS file.
 - Contains records of undefined length (RECFM=U).
 - Is being processed with a template that contains segmented records.

File Manager makes the determination about DFSORT use based on the above conditions and other factors which may affect performance. Note that, under some conditions (with tape data sets), File Manager may not be able to detect unlike data set attributes and still invoke DFSORT for copy processing. Such invocation may fail since DFSORT does not allow for unlike concatenation of data sets. In such cases, you can disable DFSORT with the NOSORT function to allow for successful processing of concatenated datasets with unlike attributes.

- It is possible to directly control DFSORT processing using DFSORT commands in a File Manager PROC. For details, see the documentation on FASTPROC in [Coding DFSORT procedure statements on page 522](#). It can be worth using this feature when very high performance is required. DFSORT can perform operations with high efficiency before File Manager processes the data records, or in some cases without File Manager processing any data records at all. The main “cost” to you, the user, is learning and using another syntax for DFSORT commands.

- **Use the FASTREXX subset of REXX**

If a user PROC is required, it is strongly recommended that, rather than the full REXX language, the FASTREXX subset of REXX is used. File Manager provides a set of external REXX functions designed to allow many common tasks to be performed within the FASTREXX subset. See [Enhancing File Manager processing on page 517](#) for a discussion of FASTREXX, and [External REXX functions on page 1624](#).

- **Template and copybook processing**

Several functions, including BTB, PBK, and many of the Data Set functions (DS*), allow template or copybook processing. When using these functions, consider the following performance-related points:

- File Manager can be most efficient if a template is used instead of a copybook.
- If a copybook must be used, for best performance specify the copybook language explicitly (LANG=COBOL, LANG=PLI, or LANG=HLASM).
- Template expressions should be written, if at all possible, using expressions suitable for File Manager internal processing. For more details, see [Improving performance using internal expression processing on page 295](#).

Also, see “*Performance tips*” for the following functions:

- DSC (Data Set Copy) on page 1302
- DSEB (Data Set Edit Batch) – batch only on page 1351
- DSM (Data Set Compare) on page 1388
- DSP (Data Set Print) on page 1438
- DSU (Data Set Update) – batch only on page 1462
- FCH (Find/Change) on page 1503

File Manager functions

This section describes the File Manager functions that you can use in batch jobs, in TSO, and in REXX and CLIST procedures. For more information about using these functions, see [Introduction to programming with File Manager functions on page 503](#).

AUD (Print audit trail report)

Purpose

Print a formatted or unformatted audit trail report.

Usage Notes

You must specify the name of the audit trail data set from which you want to produce a report. If the audit trail is from FM/IMS or FM/Db2, you must also indicate that.

Options

You can choose between printing an unformatted report or, if the audited function used a template, a report formatted according to the template you used. You can also specify whether or not you want the audit trail data set to be deleted after printing. You can provide a description to help to identify the audit trail report. For FM/Db2, you can specify any non-standard null display character used.

Related functions

None.

Figure 414. Syntax

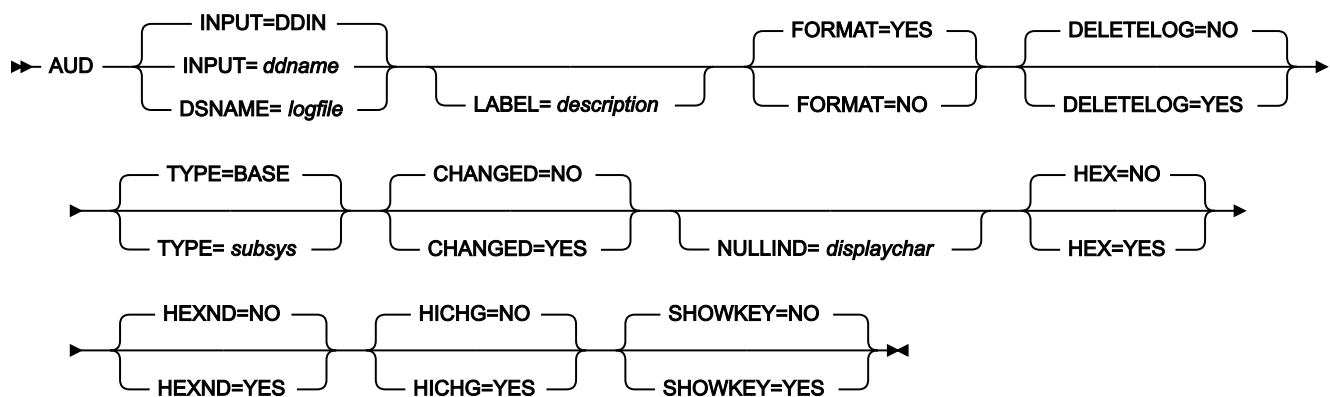

INPUT=ddname

Defines a reference to a DD or TSO ALLOC statement for the input data set or HFS file. The default is DDIN.

DSNAME=logfile

Specifies the name of the audit trail log data set.

LABEL=Description

Optional identification for the audit trail report. Must be within quotation marks if it contains blanks.

FORMAT

Determines the formatting of the audit trail report.

YES

Default. Report is formatted according to the template used in the audited Edit session.

NO

Report is not formatted.

DELETEDLOG

Determines whether or not the audit trail data set is deleted after printing. DELETEDLOG is not allowed for log data sets allocated using a DD statement.

NO

Default. The audit trail data set is not deleted.

YES

The audit trail data set is deleted after the report is printed.

TYPE

Specifies the subsystem used for the audited Edit session. Can be BASE, IMS, DB2, or CICS. BASE is the default.

CHANGED

NO

Default. All fields are reported.

YES

Only fields that are changed are reported.

NULLIND=displaychar

Specifies the null indicator character to be used in an audit trail report for Db2® data.

HEX=YES

Produces an UPDOWN hexadecimal display below the formatted field display when FORMAT=YES. Otherwise no effect.

HEXND=YES

Produces an UPDOWN hexadecimal display below the formatted field display when FORMAT=YES, only for fields that contain non-displayable characters. Otherwise (FORMAT=NO) no effect.

HICHG=YES

Highlights the changed fields. An asterisk is placed to the left of the "before" data to indicate the field has been changed.

SHOWKEY=YES

Displays key fields even when CHANGED=YES has been selected. A "K" is printed to the left of key field names. For a KSDS data set, a key field is any elementary field that intersects, or is contained in, the key area. Note: does not apply to Db2® audit reports.

```
//AUDIT job (acct),'name'
/* Print formatted audit trail report
/*
//FMNBATCH EXEC PGM=FILEMGR
//STEPLIB DD DSN=FMN.SFMNMOD1,DISP=SHR
//SYSPRINT DD SYSOUT=*
//SYSABEND DD SYSOUT=*
//SYSUDUMP DD SYSOUT=*
//SYSIN DD *
$$FILEM AUD ,
$$FILEM DSNAME=USER.FMNLOG.D020816.T070549,
$$FILEM LABEL='my description - BASE',
$$FILEM FORMAT=YES,
$$FILEM DELETEDLOG=NO
/*
//
```

```
//AUDIT job (acct),'name'
/* Print formatted audit trail report
/*
//FMNBATCH EXEC PGM=FILEMGR
//STEPLIB DD DSN=FMN.SFMNMOD1,DISP=SHR
//SYSPRINT DD SYSOUT=*
//SYSABEND DD SYSOUT=*
//SYSUDUMP DD SYSOUT=*
//SYSIN DD *
$$FILEM AUD ,
$$FILEM TYPE=IMS,
$$FILEM DSNAME=USER.IMSAUDIT.D021012.T085732,
$$FILEM LABEL='my description - IMS',
$$FILEM FORMAT=YES,
$$FILEM DELETEDLOG=NO
/*
//
```

```
//AUDIT job (acct),'name'
/* Print formatted audit trail report
/*
//FMNBATCH EXEC PGM=FILEMGR
//STEPLIB DD DSN=FMN.SFMNMOD1,DISP=SHR
//SYSPRINT DD SYSOUT=*
//SYSABEND DD SYSOUT=*
```

```
//SYSUDUMP DD SYSOUT=*
//SYSIN DD *
$$FILEM AUD ,
$$FILEM TYPE=DB2,
$$FILEM DSNAME=USER.FMN2AUD.DBT6.D021012.T141043,
$$FILEM LABEL='my description - DB2',
$$FILEM NULLIND=_,
$$FILEM DELETELOG=NO
/*
//
```

BSF (Backward Space File)

Purpose

Move the tape backward one or more tape files.

Usage notes

A tape file consists of blocks of data delimited by a tape mark. For this function, a tape label set is also considered a file. The tape stops after the specified number of tape marks has been read or the load point has been reached. The tape is positioned immediately before a tape mark or at the load point.

Specify a DDNAME for the tape.

Options

None.

Related functions

BSR

Move the tape backward one or more records

FSF

Move the tape forward one or more files

FSR

Move the tape forward one or more records

REW

Rewind a tape to its load point

RUN

Rewind a tape and unload it

Figure 415. Syntax

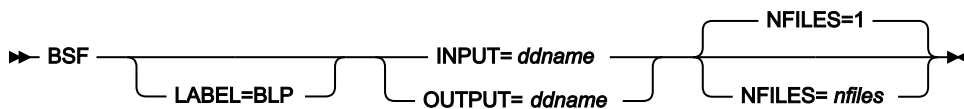

ddname

Refers to a DD or TSO ALLOC statement.

LABEL=BLP

Specifies that bypass label processing is used. This parameter must be specified with the first File Manager function that uses the tape. For BLP processing requirements, see "Customizing the Security Environment" in the *File Manager Customization Guide*.

nfiles

Number of tape files to be spaced backward. The maximum is 99 999; the default is 1.

BSR (Backward Space Record)**Purpose**

Move the tape backward one or more physical records (blocks).

Usage notes

A physical tape record is either a block of data bytes or a tape mark. A tape mark is treated as a special record. For each tape mark crossed, File Manager displays an information message.

Specify a DDNAME for the tape.

Options

None.

Related functions**BSF**

Move the tape backward one or more files

FSR

Move the tape forward one or more records

FSF

Move the tape forward one or more files

REW

Rewind a tape to its load point

RUN

Rewind a tape and unload it

Figure 416. Syntax

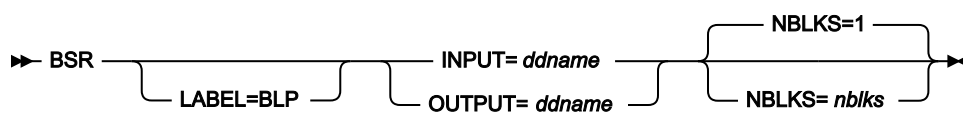

ddname

Refers to a DD or TSO ALLOC statement.

LABEL=BLP

Specifies that bypass label processing is used. This parameter must be specified with the first File Manager function that uses the tape. For BLP processing requirements, see *File Manager Customization Guide* Customizing the Security Environment.

nblks

Number of tape blocks to be spaced backward. The maximum is 99 999 999; the default is 1. A tape mark is considered a block.

BT (Create Tape File)

Purpose

Write test data to a tape file.

Usage notes

Use this function to format a tape or create test data.

Specify a DDNAME for the tape. Also specify the record size and the number of records to be written.

Options

You can specify a fill character or fill pattern, a sequence field, a record format, and a block size.

Related functions

DSG

Write test data to a data set

INT

Initialize a tape

Figure 417. Syntax

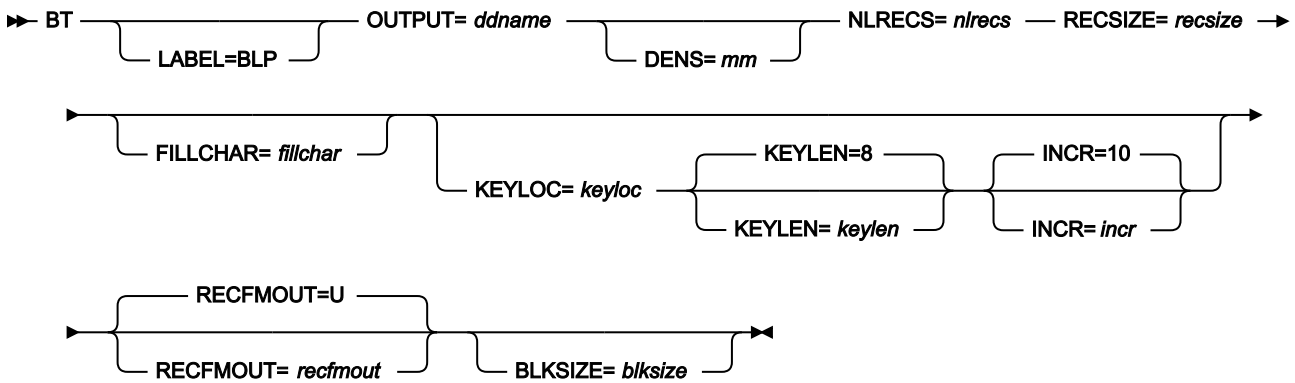

blksize

If *recfmout* contains F, the actual block size; otherwise, the maximum block size. If *recfmout* contains B or S, *blksize* is required; otherwise, it is optional. The maximum is 65 535 (for V), 9 999 (for D), or 9 999 999 (otherwise). If the tape is processed by other utilities or standard access methods, you must also consider the operating system limits.

ddname

Refers to a DD or TSO ALLOC statement. To create a tape file with standard labels, specify AL or SL processing on the DD or TSO ALLOC statement.

fillchar

To fill each byte of each record with data, specify one of the following:

char

A character, such as 0 to be written in each byte

X'cc'

A binary character, such as X'04' to be written in each byte

AN

To write alphanumeric characters (A to Z and 0 to 9)

BIN

To write binary characters (X'00' to X'FF')

RAND

To write random binary characters (X'00' to X'FF')

If you specify AN or BIN, characters are written in a “ripple” pattern. For example, if you specify AN, the first 3 records look like this:

```

ABCDEFGHIJKLMN0PQRSTUVWXYZ0123456789A
BCDEFGHIJKLMN0PQRSTUVWXYZ0123456789AB
CDEFGHIJKLMN0PQRSTUVWXYZ0123456789ABC

```

The default is a blank.

incr

Increment value for the sequence field. The default is 10.

keylen

Length of the sequence field, from 1 to 9. The default is 8.

keyloc

Position (starting with 1) of the sequence field within the output records. If omitted, there is no sequence field.

LABEL=BLP

Specifies that bypass label processing is used. This parameter must be specified with the first File Manager function that uses the tape. For BLP processing requirements, see "Customizing the Security Environment" in the *File Manager for z/OS Customization Guide*.

mm

A 2-byte tape mode as shown in [Tape density and mode values on page 449](#).

nlrecs

Number of logical records to be written. The maximum is 99 999 999.

recfmout

Record format for the output. Each value is a combination of the following letters:

B

Blocked

D

Variable-length ISO/ANSI tape records

F

Fixed length

S

Spanned format

U

Undefined length

V

Variable length

The possible values are: U, F, FB, V, VB, VBS, VS, D, DB, DBS, and DS.

resize

Length of each logical record. The maximum is 9 999 999.

```
//BT JOB (acct), 'name'      Create SL Tape
//*
//FMBAT   PROC
//FMBAT   EXEC PGM=FILEMGR
//STEPLIB DD DSN=FMN.SFMNMOD1,DISP=SHR
//SYSPRINT DD SYSOUT=*
//SYSABEND DD SYSOUT=*
//SYSUDUMP DD SYSOUT=*
//        PEND
//*
//* EXAMPLE BT JOB, SL processing
//* 67 RECORDS ARE WRITTEN TO A TAPE FILE,
//* V RECFM. THE OUTPUT FILE CONTAINS
```



```

/** ALPHANUMERIC CHARACTERS.  THERE IS A
/** SEQUENCE FIELD AT POSITION 1.
/**
/**STP0001      EXEC FMBAT
/**BT1         DD DISP=(NEW,KEEP),UNIT=CART,
/**           VOL=(,RETAIN,,SER=FM0001),
/**           LABEL=(1,SL),
/**           DSN=FMNUSER.BT05.A1V
/**SYSIN       DD *
$$$FILEM BT   OUTPUT=BT1,NLRECS=67,RECSIZE=1024,
$$$FILEM     KEYLOC=1,RECFMOUT=V,FILLCHAR=AN
$$$FILEM E0J
/**
/**
/** 12 RECORDS ARE WRITTEN TO A TAPE FILE,
/** FB RECFM.  THE OUTPUT FILE CONTAINS '*'
/** CHARACTERS.  THERE IS A SEQUENCE FIELD
/** AT POSITION 10.
/**
/**STP0002      EXEC FMBAT
/**BT2         DD DISP=(NEW,KEEP),UNIT=CART,
/**           VOL=(,RETAIN,,SER=FM0001),
/**           LABEL=(2,SL),
/**           DSN=FMNUSER.BT05.A2FB
/**SYSIN       DD *
$$$FILEM BT   OUTPUT=BT2,NLRECS=12,RECSIZE=2048,
$$$FILEM     KEYLOC=10,INCR=100,
$$$FILEM     RECFMOUT=FB,FILLCHAR='*',
$$$FILEM     BLKSIZE=20480
$$$FILEM E0J
/**

```

BTB (Batch Template Build)

Purpose

To produce multiple templates from a PDS of copybooks in batch.

Usage notes

You can select the copybooks from which templates are to be produced by member name selection criteria.

Related functions

BTU

Batch template update

Figure 418. Syntax

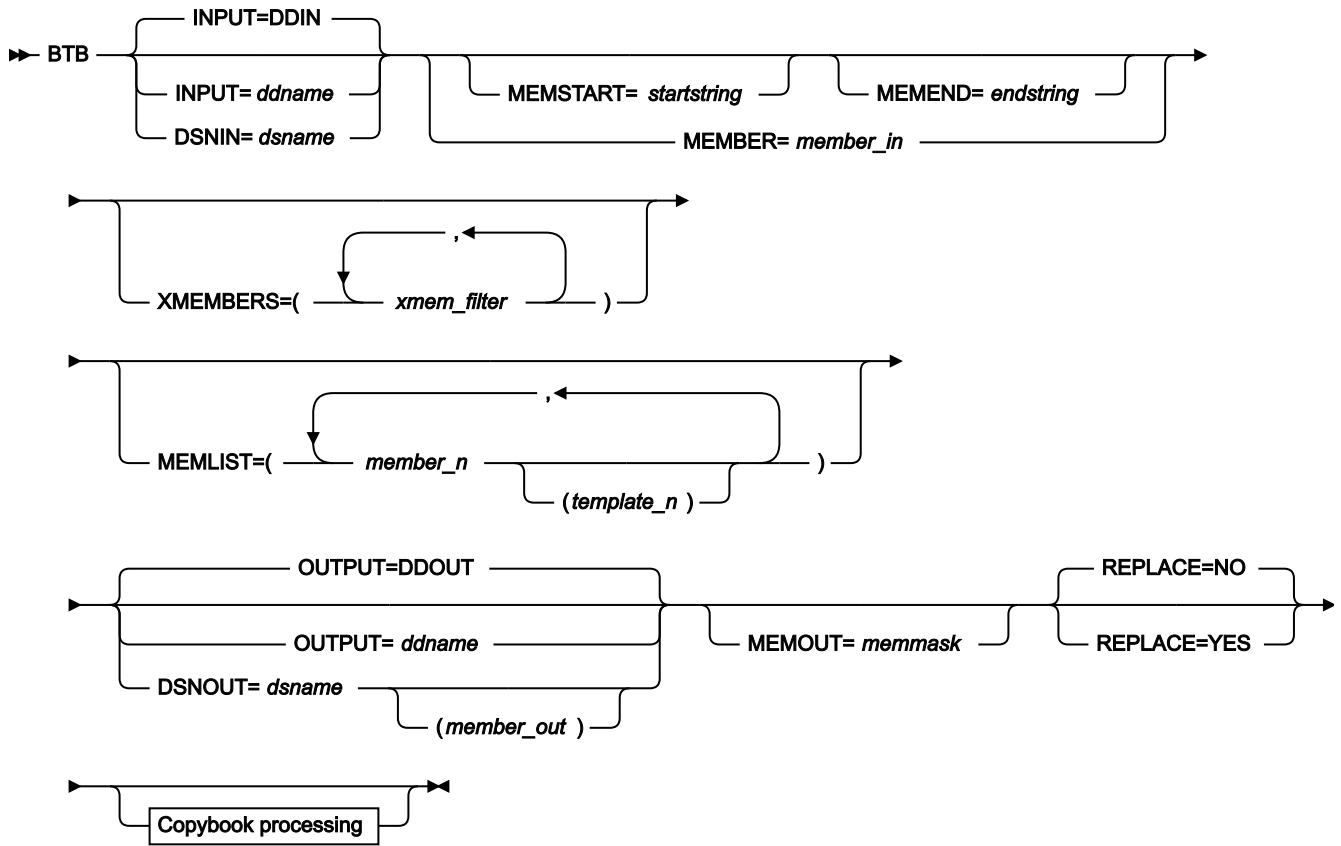

Copybook processing

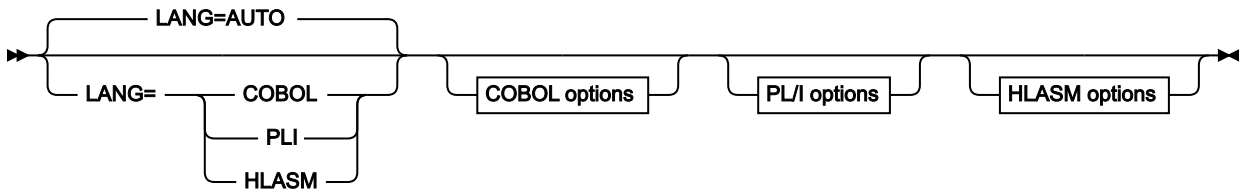

COBOL options

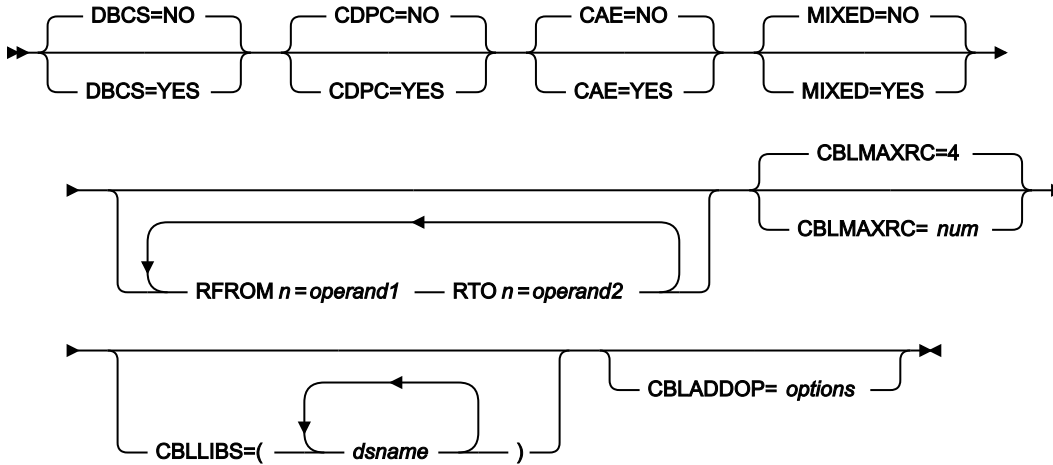

PL/I options

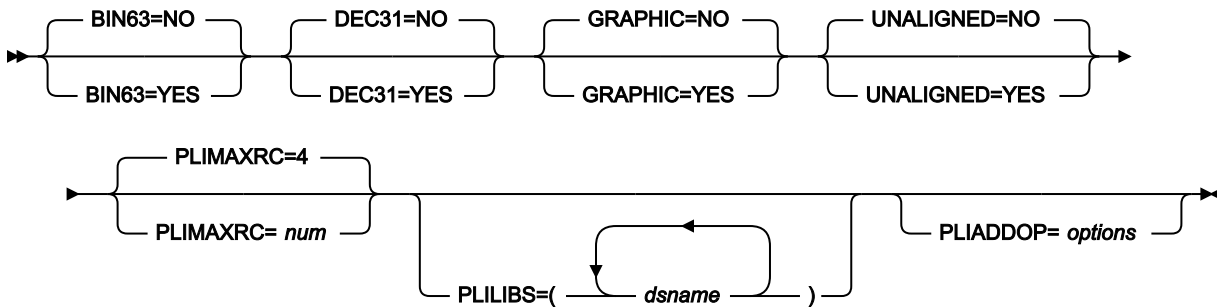

HLASM options

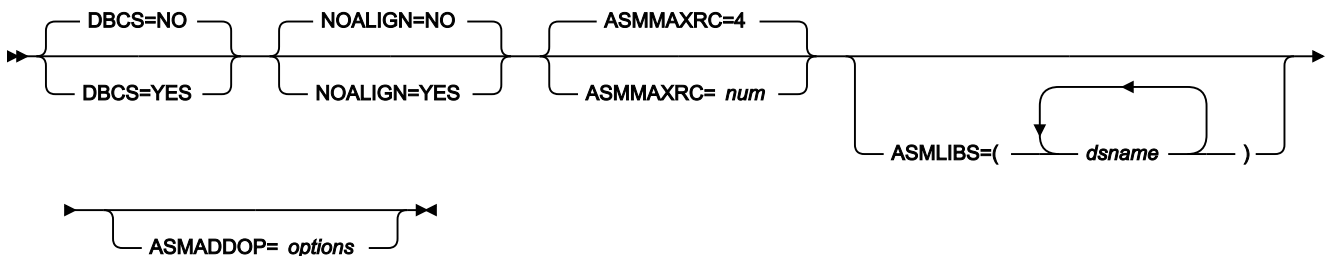

INPUT=ddname

This points to the input DD name which can have one or more associated data sets that must be valid copybook data sets. If Panvalet or Carma data sets are referred to, then they must all be Panvalet or CARMA

data sets. You cannot mix. If you do not specify INPUT or DSN parameters, then the DD DDIN is used as a default DD name for the input data sets.

DSNIN=*dsname*

Data set name where copybooks reside.

MEMBER=*member_in*

The name of a single member in a PDS, or a member name pattern representing one or more members in a PDS to be processed.

A member name pattern can consist of any characters that are valid in a member name and two special pattern characters: the asterisk (*) and the percent symbol (%).

*

represents any number of characters. As many asterisks as required can appear anywhere in a member name pattern. For example, if you enter a member name pattern of *d*, all members in the PDS whose name contains "d" are processed.

%

is a place holding character that means a single character. As many percent symbols as necessary can appear anywhere in a member name pattern. For example, if you enter a member name pattern of %%%%, all members in the PDS whose name is four characters in length are processed.

member_in is ignored if the data set is not a PDS.

MEMSTART=*startstring*

Is used to specify the start of a range of member names to be included. If MEMSTART is specified but MEMEND is omitted, all members of the PDS(E) from the *startstring* value onwards are included. *startstring* can have the same values, including wild cards, as for the *member-in* parameter of the MEMBER keyword.

MEMEND=*endstring*

Is used to specify the end of a range of member names to be included. If MEMEND is specified but MEMSTART is omitted, all members of the PDS(E) up to the *endstring* value onwards are included. *endstring* can have the same values, including wild cards, as for the *member_in* parameter of the MEMBER keyword.

XMEMBERS

Provides a way to exclude from processing library members that would otherwise be selected using the MEMSTART, MEMEND, and MEMBER options.

xmem_filter

A member name filter identifying one or more members that are to be excluded from processing. A filter can be a member name pattern representing multiple members.

To specify a member name filter containing lowercase characters, use a character string in the format `c'string'`. Filter values can also be specified as hexadecimal strings in the format `x'hex-digits'`.

MEMLIST

Allows you to specify a list of member names with optional associated output template names. If you do not specify the associated template name, File Manager uses the copybook name or the name as identified by the MEMOUT mask, *memmask*.

member_n

The name of the member to be processed. Generic name masks are allowed.

template_n

The name of the template after it has been copied to the output data set. If unspecified, the output template is not renamed.

OUTPUT=ddname

Identifies the DD card which points to the template data set in which the templates are stored or replaced. It must refer to a PDS, PDSE, or sequential data set. Concatenated data sets are not supported.

DSNOUT=dsname

Defines the data set name where templates are created. It must be a PDS, PDSE, or sequential data set. You can further describe this data set, as follows:

(*member-out*)

Where DSNOUT=*dsname* specifies a PDS and you want to send the output to a specific member within this data set, this defines the output member name.

MEMOUT=*memmask*

Where a number of input members have been specified, you can specify a member name pattern for the output templates, allowing you to rename your templates as they are created. The member name pattern can consist of any characters that are valid in a member name and two special pattern characters: the asterisk (*) and percent sign (%).

Asterisk (*)

The asterisk is a place-holding character that means multiple characters with no change. Only one asterisk should appear in the mask. Any subsequent asterisk characters are treated as percent signs. For example, if you enter:

```
ABC*
```

The renamed members all begin with ABC followed by the remainder of the old member name.

Percent sign (%)

The percent sign is a place-holding character that means a single character with no change. As many percent symbols as necessary may appear anywhere in a member name. For example, if you enter:

```
%%%A*
```

The 1st 3 characters of the renamed members remain unchanged, the 4th character is replaced with the letter "A" and the remainder of the old member name remains unchanged.

REPLACE

Specifies whether or not File Manager replaces like-named templates in an output partitioned data set.

NO

Like-named templates in the output partitioned data set are not replaced.

YES

Like-named templates in the output partitioned data set are replaced.

Copybook processing

If you specify a copybook (instead of an existing template), File Manager uses these processing options to compile the copybook into a template:

LANG

Determines whether File Manager automatically detects the copybook language or interprets the language as COBOL, PL/I, or HLASM.



Note: The COMPLANG setting in FMN0POPT is the equivalent of the LANG parameter in batch functions.

- If COMPLANG is set it determines the installation default language for online and batch compilation.
- If COMPLANG is not specified then COBOL is the installation default for online compilation and AUTO is the default for batch compilation.
- If a value of COBOL, HLASM, PL/1, or AUTO is specified (in the **Compiler Language Selection** panel or through the LANG parameter in a batch job) it overrides the default language.

AUTO

Automatically detect whether the copybook language is COBOL or PL/I, and invoke the appropriate compiler. If the compilation results in a return code greater than 4, then invoke the compiler for the other language. If the second compilation also results in a return code greater than 4, then retry the first compiler and report the

compilation errors. If File Manager successfully creates a template (despite the compilation errors), then continue processing with the template.

COBOL

Invoke the COBOL compiler to create a template from the copybook. (Do not invoke the PL/I compiler, even if the COBOL compilation results in errors.)

PLI

Invoke the PL/I compiler to create a template from the copybook. (Do not invoke the COBOL compiler, even if the PL/I compilation results in errors.)

HLASM

Invoke the HLASM compiler to create a template from the copybook.

DSINFO

Specifies whether additional data set information for input and output sources should be produced in batch reports for the DSP, DSM, DSC, and FCH commands.

NO

No additional data set information is generated.

YES

Generates data set information including DSORG, RECFM, LRECL, BLKSIZE, and VSAM attributes including average record length, maximum record length, key offset, key length and reuse, for input and output data sets when applicable.

COBOL options

The following options are used to compile a COBOL copybook into a template:

DBCS=YES

Use the DBCS compiler option.

DBCS=NO

Use the NODBCS compiler option.

For details on the effect of the DBCS and NODBCS compiler options, see the *IBM COBOL Programming Guide for OS/390 & VM*.

CDPC=NO

Do not use the COBOL SPECIAL-NAMES paragraph "Decimal-point is comma".

CDPC = YES

Use the COBOL SPECIAL-NAMES paragraph "Decimal-point is comma".

CAE=NO

Do not use the COBOL compile option ARITH(EXTEND).

CAE = YES

Use the COBOL compile option ARITH(EXTEND).

MIXED = NO

Field names stored in the template in uppercase.

MIXED = NO

Field names stored in the template in uppercase.

MIXED = YES

Field names stored in the template in the original case as coded in the COBOL copybook.

RFROM1 RT01 ... RFROM5 RT05

Up to five pairs of "From" and "To" pseudo-text character strings for the COBOL REPLACE compiler-directing statement.

If your COBOL copybooks contain characters that you want to remove or replace with other characters before compiling the copybooks into templates, then use these replacing options.

For example, if your copybooks contain colon characters (:) that you want to remove before compiling, then specify '=====' as *operand1* and '=====' as *operand2*.

For details on specifying "From" and "To" strings for COBOL REPLACE, see the *IBM COBOL Language Reference*.

CBLMAXRC

Sets the maximum acceptable return code for a copybook compile. A return code higher than the specified level causes the function to stop. Default is 4.



Note: The COMPMAXRC parameter is still supported but it is recommended that the CBLMAXRC parameter is used instead. If you do specify the COMPMAXRC parameter, it takes precedence over the language MAXRC.

CBLLIBS

Allows you to specify a list of up to ten data set names to be specified in the SYSLIB concatenation list. These data sets are searched in the order specified for COPY and INCLUDE members for the compilation.

dsname

The name of the data set name to be processed. Generic name masks are not allowed.

CBLADDOP

Additional COBOL compiler options which are included in a CBL statement when compiling COBOL copybooks.

PL/I options

The following options are used to compile a PL/I copybook into a template:

BIN63=YES

Use the LIMITS(FIXEDBIN(63)) compiler option.

BIN63=NO

Use the LIMITS(FIXEDBIN(31)) compiler option.

DEC31=YES

Use the LIMITS(FIXEDDEC(31)) compiler option.

DEC31=NO

Use the LIMITS(FIXEDDEC(15)) compiler option.

GRAPHIC=YES

Use the GRAPHIC compiler option.

GRAPHIC=NO

Use the NOGRAPHIC compiler option.

UNALIGNED=YES

Use the DEFAULT RANGE (*) UNALIGNED, language statement to change the default alignment.

UNALIGNED=NO

Use the PL/I default.

PLIMAXRC

Sets the maximum acceptable return code for a copybook compile. A return code higher than the specified level causes the function to stop. Default is 4.



Note: The COMPMAXRC parameter is still supported but it is recommended that the PLIMAXRC parameter is used instead. If you do specify the COMPMAXRC parameter, it takes precedence over the language MAXRC.

PLILIBS

Allows you to specify a list of up to ten data set names to be specified in the SYSLIB concatenation list. These data sets are searched in the order specified for COPY and INCLUDE members for the compilation.

dsname

The name of the data set name to be processed. Generic name masks are not allowed.

PLIADDOP

Additional PL/I compiler options which are included in a *PROCESS statement when compiling PL/I copybooks.

For details on the effect of these compiler options, see the *IBM VisualAge PL/I for OS/390 Programming Guide*.

HLASM options

The following options are used to compile a HLASM copybook into a template:

DBCS=YES

Use the DBCS compiler option.

DBCS=NO

Use the NODBCS compiler option.

NOALIGN=YES

Use the NOALIGN compiler option.

NOALIGN=NO

Use the ALIGN compiler option.

ASMMAXRC

Sets the maximum acceptable return code for a copybook compile. A return code higher than the specified level causes the function to stop. Default is 4.



Note: The COMPMAXRC parameter is still supported but it is recommended that the ASMMAXRC parameter is used instead. If you do specify the COMPMAXRC parameter, it takes precedence over the language MAXRC.

ASMLIBS

Allows you to specify a list of up to ten data set names to be specified in the SYSLIB concatenation list. These data sets are searched in the order specified for COPY and INCLUDE members for the compilation.

dsname

The name of the data set name to be processed. Generic name masks are not allowed.

ASMADDP

Additional HLASM compiler options which are included in a *PROCESS statement when compiling COPY and MACRO members.

For details on the effect of these compiler options, see the *HLASM V1R6 Programmer's Guide*.

```
//DDIN DD DSN=FMNUSER.COBOL2,DISP=SHR
//      DD DSN=FMNUSER.COBOL,DISP=SHR
//SYSIN DD *
$$$FILEM BTB INPUT=DDIN,
$$$FILEM MEMLIST=(DITTST1,
$$$FILEM          DITTST3,
$$$FILEM          DITTST7,
$$$FILEM          XYZTST1),
$$$FILEM LANG=COBOL,
$$$FILEM COMPMAXRC=08,
$$$FILEM RFROM1===:==,
$$$FILEM RT01====,
$$$FILEM REPLACE=YES,
$$$FILEM DSNOUT=FMNUSER.TEMPLATE.NEW
```

Will produce the following output (if there is more than one input data set):

```
Report 1 Data set list

Data set name          Lib
-----
FMNUSER.COBOL2        1
FMNUSER.COBOL         2

Build report

          Template Build Report
Copybook  Lib Template  Status
DITTST1   1 DITTST1    Replaced
DITTST3   1 DITTST3    Replaced
DITTST7   1 DITTST7    Compile error
XYZTST1   2 XYZTST1    Created

4 members read : Template : 1 Created 2 Replaced 1 Errors
```

The Lib column is displayed only when more than one input data set is found.

BTU (Batch Template Update)**Purpose**

Use this utility to:

- Update one or more templates.
- Create new templates based upon existing templates.

Usage notes

- You can filter the templates selected for processing by providing copybook member names or member masks so that only templates referencing such copybooks are updated.

Related functions

BTB

Batch template build

Figure 419. Syntax

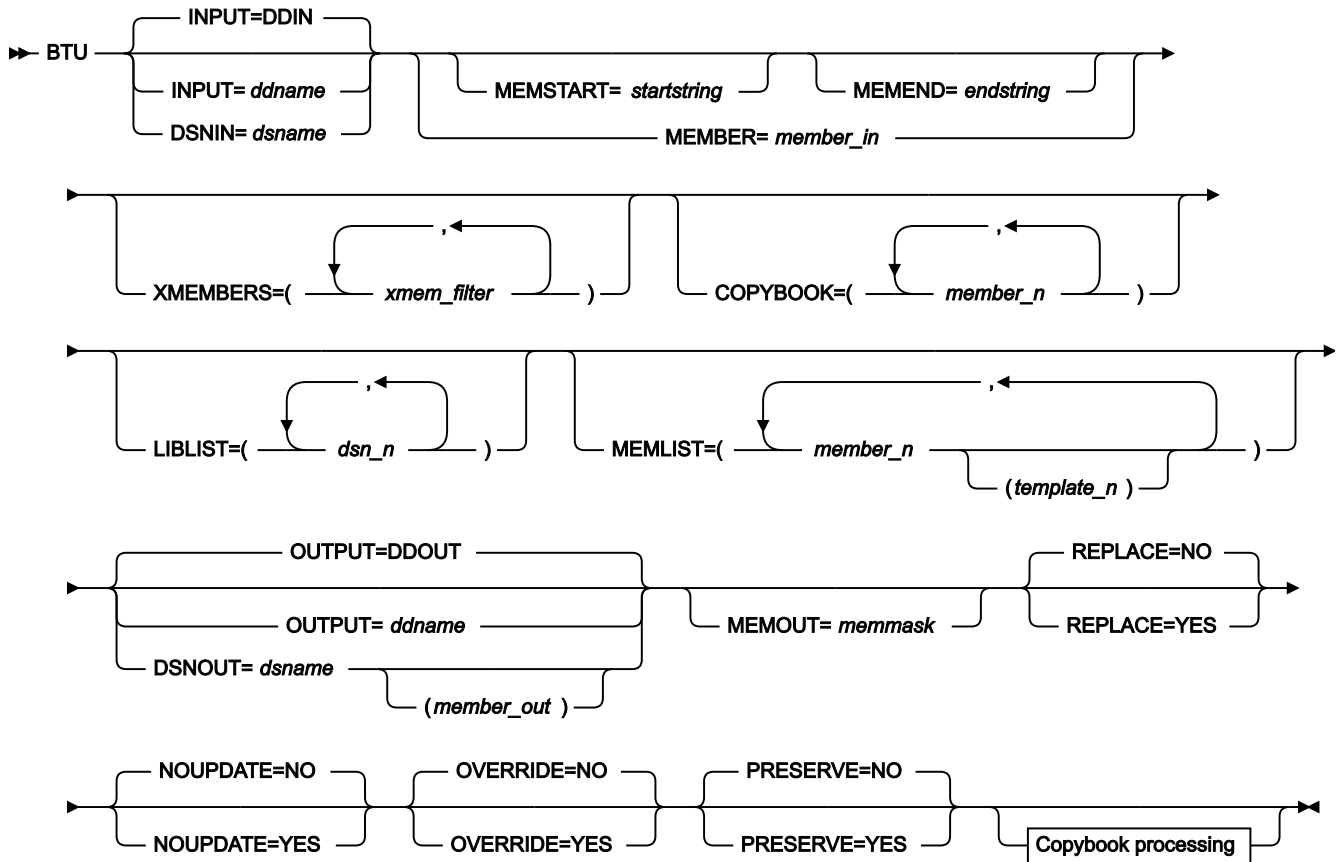

Copybook processing

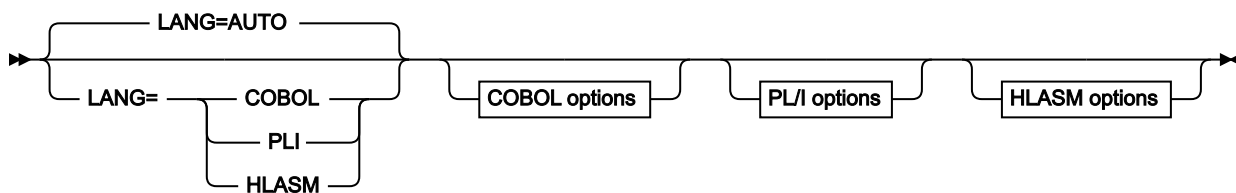

COBOL options

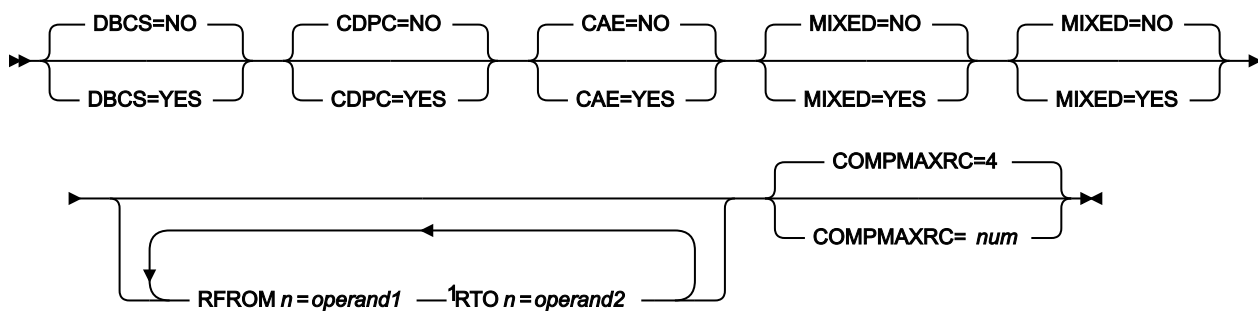

Notes:

¹ *n*= 1 to 5.

PL/I options

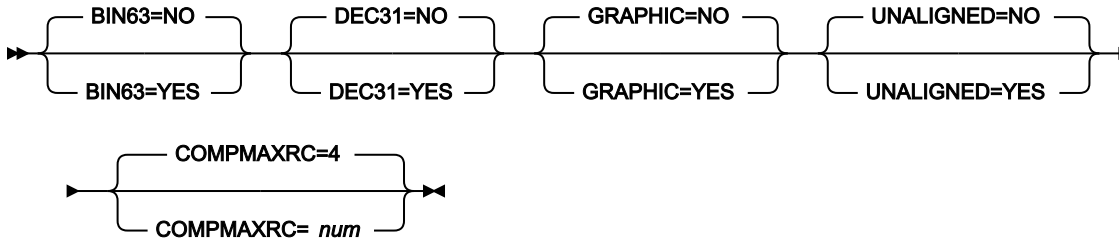

HLASM options

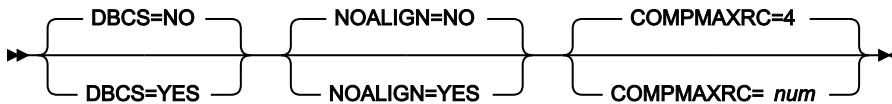

INPUT=ddname

This points to the input DD name which can have one or more associated data sets that must be valid template data sets. If you do not specify INPUT or DSN parameters, then the DD DDIN is used as a default DD name for the input data sets. You can specify concatenated data sets. If an output data set is not provided, the template is updated in the data set from which it originated.

DSNIN=dsname

Data set name where templates reside.

MEMBER=member_in

The name of a single member in a PDS, or a member name pattern representing one or more members in a PDS to be processed.

A member name pattern can consist of any characters that are valid in a member name and two special pattern characters: the asterisk (*) and the percent symbol (%).

*

represents any number of characters. As many asterisks as required can appear anywhere in a member name pattern. For example, if you enter a member name pattern of *d*, all members in the PDS whose name contains "d" are processed.

%

is a place holding character that means a single character. As many percent symbols as necessary can appear anywhere in a member name pattern. For example, if you enter a member name pattern of %%%%, all members in the PDS whose name is four characters in length are processed.

member_in is ignored if the data set is not a PDS.

MEMSTART=*startstring*

Is used to specify the start of a range of member names to be included. If MEMSTART is specified but MEMEND is omitted, all members of the PDS(E) from the *startstring* value onwards are included. *startstring* can have the same values, including wild cards, as for the *member-in* parameter of the MEMBER keyword.

MEMEND=*endstring*

Is used to specify the end of a range of member names to be included. If MEMEND is specified but MEMSTART is omitted, all members of the PDS(E) up to the *endstring* value onwards are included. *endstring* can have the same values, including wild cards, as for the *member_in* parameter of the MEMBER keyword.

XMEMBERS

Provides a way to exclude from processing library members that would otherwise be selected using the MEMSTART, MEMEND, and MEMBER options.

xmem_filter

A member name filter identifying one or more members that are to be excluded from processing. A filter can be a member name pattern representing multiple members.

To specify a member name filter containing lowercase characters, use a character string in the format `c'string'`. Filter values can also be specified as hexadecimal strings in the format `x'hex-digits'`.

COPYBOOK

Allows you to specify a list of member names or patterns used to filter so that only templates referencing those copybooks, or copybooks that match the patterns, are selected for processing.

member_n

The name of the member to be processed. Generic name masks are not allowed.

LIBLIST

Allows you to specify a list of up to twelve data set names used to replace the copybook library lists in the selected templates.

dsn_n

The name of the data set name to be processed. Generic name masks are not allowed.

MEMLIST

Allows you to specify a list of member names with optional associated output template names. If you do not specify the associated template name, File Manager uses the copybook name or the name as identified by the MEMOUT mask, *memmask*.

member_n

The name of the member to be processed. Generic name masks are allowed.

template_n

The name of the template after it has been copied to the output data set. If unspecified, the output template is not renamed.

OUTPUT=ddname

Identifies the DD card which points to the template data set in which the templates are stored or replaced. It must refer to a PDS, PDSE, or sequential data set. Concatenated data sets are not supported.

DSNOUT=dsname

Defines the data set name where templates are created. It must be a PDS, PDSE, or sequential data set. You can further describe this data set, as follows:

(*member-out*)

Where DSNOUT=*dsname* specifies a PDS and you want to send the output to a specific member within this data set, this defines the output member name.

MEMOUT=memmask

Where a number of input members have been specified, you can specify a member name pattern for the output templates, allowing you to rename your templates as they are created. The member name pattern can consist of any characters that are valid in a member name and two special pattern characters: the asterisk (*) and percent sign (%).

Asterisk (*)

The asterisk is a place-holding character that means multiple characters with no change. Only one asterisk should appear in the mask. Any subsequent asterisk characters are treated as percent signs. For example, if you enter:

```
ABC*
```

The renamed members all begin with ABC followed by the remainder of the old member name.

Percent sign (%)

The percent sign is a place-holding character that means a single character with no change. As many percent symbols as necessary may appear anywhere in a member name. For example, if you enter:

```
%%%A*
```

The 1st 3 characters of the renamed members remain unchanged, the 4th character is replaced with the letter "A" and the remainder of the old member name remains unchanged.

REPLACE

Specifies whether or not File Manager replaces like-named templates in an output partitioned data set.

NO

Like-named templates in the output partitioned data set are not replaced.

YES

Like-named templates in the output partitioned data set are replaced.

NOUPDATE

Specifies whether or not File Manager writes back updates to the data set.

NO

Updates are written back to the data set.

YES

Updates are not written back to the data set.

OVERRIDE

Specifies whether or not File Manager overrides any compile options found in the template with the compiler options found specified in the parameter list.

NO

Compile options found in the template are not overwritten with the compiler options found specified in the parameter list.

YES

Compile options found in the template are overwritten with the compiler options found specified in the parameter list.

PRESERVE

Specifies whether or not File Manager uses the current version of the copybook.

NO

File Manager searches for the first version of the copybook.

YES

File Manager uses the current version of the cookbook, provided the copybook still exists in the library it was previously found in, and the library is in the list the update process is using.

File Manager searches for the first version of the copybook in the order the libraries are listed if one of these conditions applies:

- NO has been specified for this option.
- The copybook no longer exists in the library it was previously found in.
- The library is not in the list the update process is using.

Compiler options

If you specify `OVERRIDE=YES`, then the specified compile options shown here override the options found in the template:

LANG

Determines whether File Manager automatically detects the copybook language or interprets the language as COBOL, PL/I, or HLASM.

AUTO

Automatically detect whether the copybook language is COBOL or PL/I, and invoke the appropriate compiler. If the compilation results in a return code greater than 4, then invoke the compiler for the other language. If the second compilation also results in a return code greater than 4, then retry the first compiler and report the compilation errors. If File Manager successfully creates a template (despite the compilation errors), then continue processing with the template.

COBOL

Invoke the COBOL compiler to create a template from the copybook. (Do not invoke the PL/I compiler, even if the COBOL compilation results in errors.)

PLI

Invoke the PL/I compiler to create a template from the copybook. (Do not invoke the COBOL compiler, even if the PL/I compilation results in errors.)

HLASM

Invoke the HLASM compiler to create a template from the copybook.

COBOL options

The following options are used to compile a COBOL copybook into a template:

DBCS=YES

Use the DBCS compiler option.

DBCS=NO

Use the NODBCS compiler option.

For details on the effect of the DBCS and NODBCS compiler options, see the *IBM COBOL Programming Guide for OS/390 & VM*.

CDPC=NO

Do not use the COBOL SPECIAL-NAMES paragraph "Decimal-point is comma".

CDPC = YES

Use the COBOL SPECIAL-NAMES paragraph "Decimal-point is comma".

CAE=NO

Do not use the COBOL compile option ARITH(EXTEND).

CAE = YES

Use the COBOL compile option ARITH(EXTEND).

MIXED = NO

Field names stored in the template in uppercase.

MIXED = NO

Field names stored in the template in uppercase.

MIXED = YES

Field names stored in the template in the original case as coded in the COBOL copybook.

RFROM1 RTO1 ... RFROM5 RTO5

Up to five pairs of “From” and “To” pseudo-text character strings for the COBOL REPLACE compiler-directing statement.

If your COBOL copybooks contain characters that you want to remove or replace with other characters before compiling the copybooks into templates, then use these replacing options.

For example, if your copybooks contain colon characters (:) that you want to remove before compiling, then specify '==:==' as *operand1* and '=====' as *operand2*.

For details on specifying “From” and “To” strings for COBOL REPLACE, see the *IBM COBOL Language Reference*.

COMPMAXRC

Sets the maximum acceptable return code for a copybook compile. A return code higher than the specified level causes the function to stop. Default is 4.

PL/I options

The following options are used to compile a PL/I copybook into a template:

BIN63=YES

Use the LIMITS(FIXEDBIN(63)) compiler option.

BIN63=NO

Use the LIMITS(FIXEDBIN(31)) compiler option.

DEC31=YES

Use the LIMITS(FIXEDDEC(31)) compiler option.

DEC31=NO

Use the LIMITS(FIXEDDEC(15)) compiler option.

GRAPHIC=YES

Use the GRAPHIC compiler option.

GRAPHIC=NO

Use the NOGRAPHIC compiler option.

UNALIGNED=YES

Use the DEFAULT RANGE (*) UNALIGNED, language statement to change the default alignment.

UNALIGNED=NO

Use the PL/I default.

COMPMAXRC

Sets the maximum acceptable return code for a copybook compile. A return code higher than the specified level causes the function to stop. Default is 4.

For details on the effect of these compiler options, see the *IBM VisualAge PL/I for OS/390 Programming Guide*.

HLASM options

The following options are used to compile a HLASM copybook into a template:

DBCS=YES

Use the DBCS compiler option.

DBCS=NO

Use the NODBCS compiler option.

NOALIGN=YES

Use the NOALIGN compiler option.

NOALIGN=NO

Use the ALIGN compiler option.

COMPMAXRC

Sets the maximum acceptable return code for a copybook compile. A return code higher than the specified level causes the function to stop. Default is 4.

For details on the effect of these compiler options, see the *HLASM V1R6 Programmer's Guide*.

```
//DDIN DD DSN=FMUSER.TEMPLAT1,DISP=SHR
// DD DSN=FMUSER.TEMPLAT2,DISP=SHR
//SYSIN DD *
$$FILEM BTU INPUT=DDIN,
$$FILEM MEMLIST=(COPYTST,
$$FILEM COPY01,
$$FILEM COPY0102)
```

Report 1 Data set list (only produced for multiple input data sets).

Data set name	Lib
FMUSER.TEMPLAT1	1
FMUSER.TEMPLAT2	2

Update report

Template Update Report		
Template	Lib New name	Status
COPYTST	1	Updated
COPY01	1	Not replaced
COPY0102	2	Updated

3 members read 2 Updated 0 Not changed 1 Not replaced 0 Errors

Table 24. Batch update status and action

Status	Explanation	Action
Updated	The template was successfully updated.	None
Not Replaced	The template exists in the output data set and the replace option is NO.	Specify replace and rerun if required.
Replaced	The template exists in the output data set and has been successfully updated with replace option YES.	None.
Compile Error	Unable to compile the copybooks associated with the template.	Rerun using option 7.4 in foreground for the failing template and look at the compile listing produced.
Corrupt Template	The internal format of the template is corrupted. This could have occurred because the template has been modified outside of File Manager.	This is an internal error. If the template has not been modified then keep a copy of it and contact you IBM® representative.
SYSLIB not found <i>syslib</i>	The syslib referenced in the template could not be found.	Rerun the update in foreground using option 7.1 which will list the SYSLIBs which you can them modify. Alternatively provide LIBLIST=(dsn1,dsn2...) parameter to identify the current location for the copybooks.
SYSLIB invalid attrs <i>syslib</i>	The syslib referenced in the template has invalid attributes for the language type for this template.	Change the syslib reference using option 7.1 or LIBLIST parameter.
Copybook not found name	The copybook name could not be located in the current libraries.	Provide the data set containing the referenced copybook using either 7.1 or the LIBLIST parameter.
Storage exhausted	File Manager ran out of storage during processing	Increase the region size.
No copybooks in libraries	The library list provided either from the template or override has no copybooks.	Rerun the update in foreground using option 7.1 which will list the SYSLIBs which you can them modify. Alternatively provide LIBLIST=(dsn1,dsn2...)

Table 24. Batch update status and action (continued)

Status	Explanation	Action
		parameter to identify the current location for the copybooks.
Not a valid template	The type of template is not valid for update processing.	This is an internal error that should never occur—contact your IBM® support center.
Duplicate name	The output template name has already been referenced by another template during update.	Correct parameters so that there are no duplicate names being saved.
Not found	The template member referenced could be not be found on the input data set.	Correct the input parameters to point to the right data set or member name.
Save error	The updated template could not be saved	Normally a space problem—check the output data set (or input data set if an output data set was not provided) and increase the size.
Update check successful	Running with <code>NOUPDATE=YES</code> and update would have been done.	None.
Updating of criteria failed	The update was not performed because fields that were previously referenced in criteria could not be found in the current versions of the copybooks.	Rerun the update in foreground using option 7.1 and the U command. This should allow you to correct the expressions that have been invalidated as a result of your copybook changes.

CLM (Compare Load Module)

Purpose

Use the CLM function to:

- Perform a load module comparison. Load module and CSECT information from both the "Old" and "New" versions of the module is extracted and compared. By specifying compare criteria, you can see differences between specific properties of the load modules such as load module size, link date, CSECT name, and compilers used.
- Produce a comparison report, showing information such as where insertions, deletions, or changes have occurred in the "New" load module. The content and structure of the report reflect the comparison options used.

Usage notes

Specify the way in which the comparison is performed, using:

- The compare level
- The compare criteria

Specify the type of output produced and the way in which the output is displayed, using:

- The listing type
- The listing options

You can use Data Set Compare (DSM) instead of CLM to compare load modules, by specifying SYNCH=LMOD.

Return codes

The default return codes from the CLM function have the following modified meanings:

0

The function completed successfully and the compare sets match.

1

The function completed successfully and the compare sets do not match.

2

One of the compare sets was empty, so no comparison was performed.

4

Both of the compare sets were empty, so no comparison was performed.

16

Data set or member in use.

16

Data set or member open error.

16

Data set or member not found.

16

Other input or output error occurred.

16

Member name required and not specified.

16

Insufficient storage available.

16

CLM abended.

16

Other serious error that stops processing occurred.

16

A severe error occurred, causing File Manager to terminate.

Figure 420. Syntax

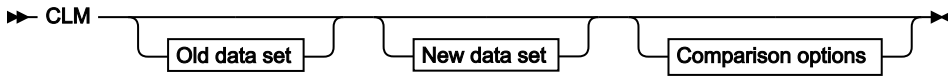

Old data set

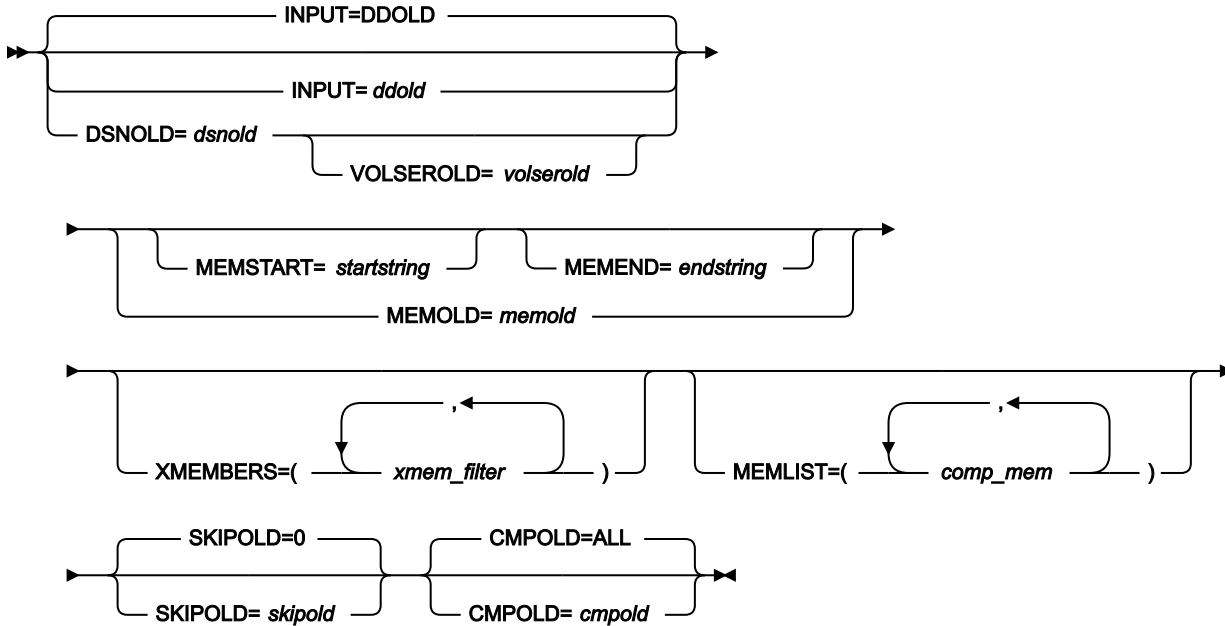

New data set

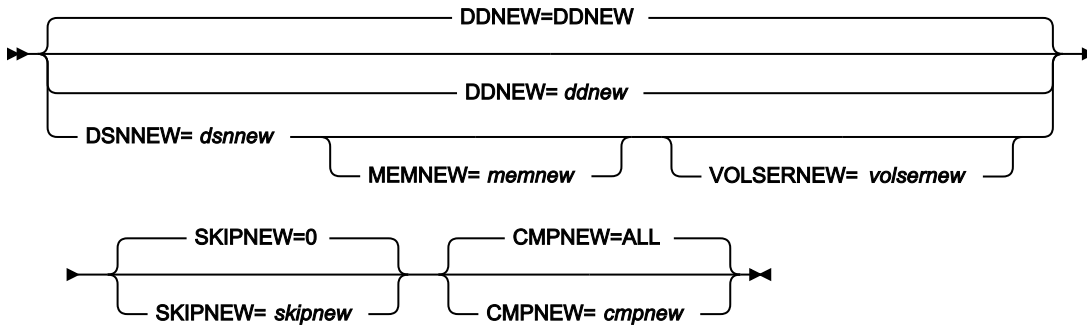

Comparison options

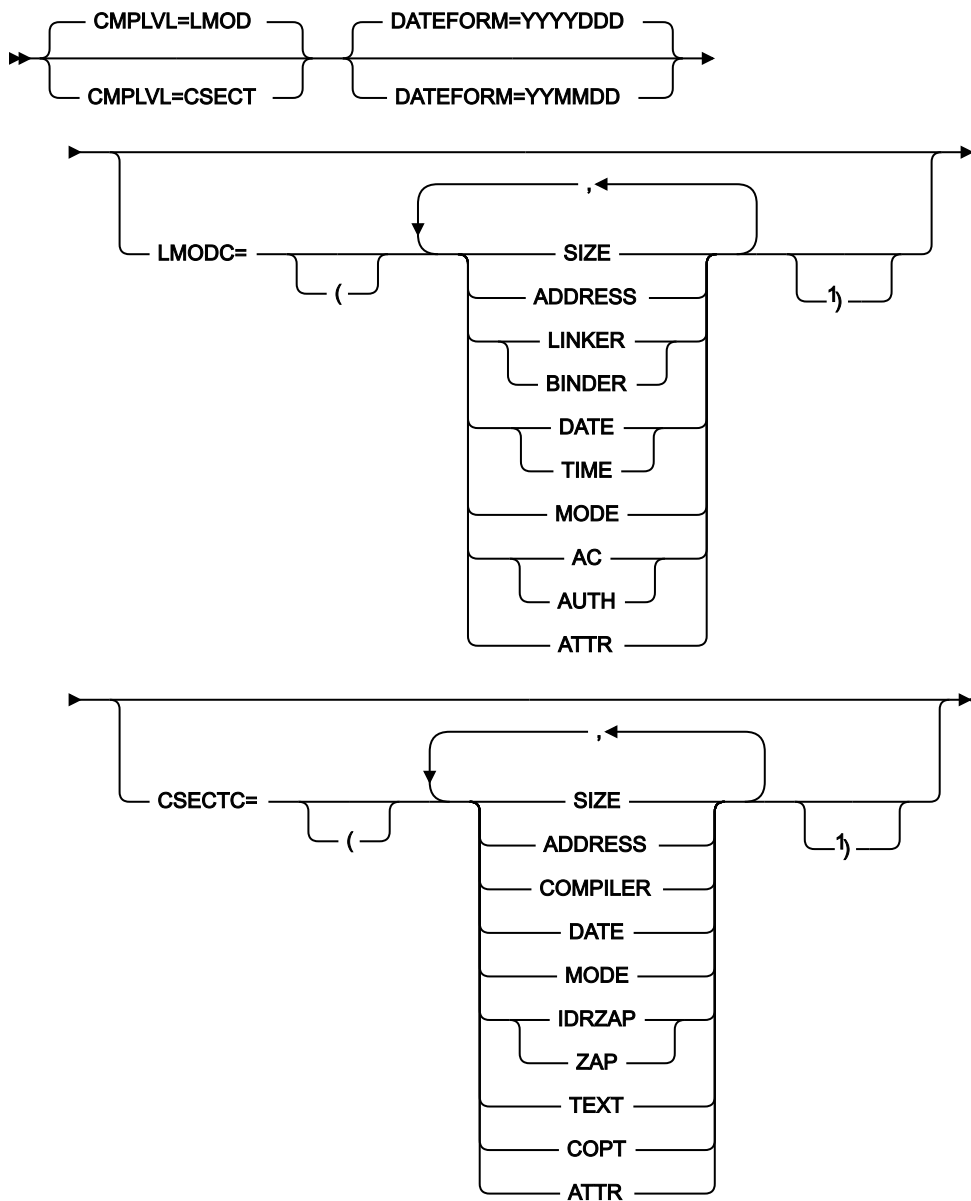

Notes:

¹ Provide closing bracket when opening bracket has been used.

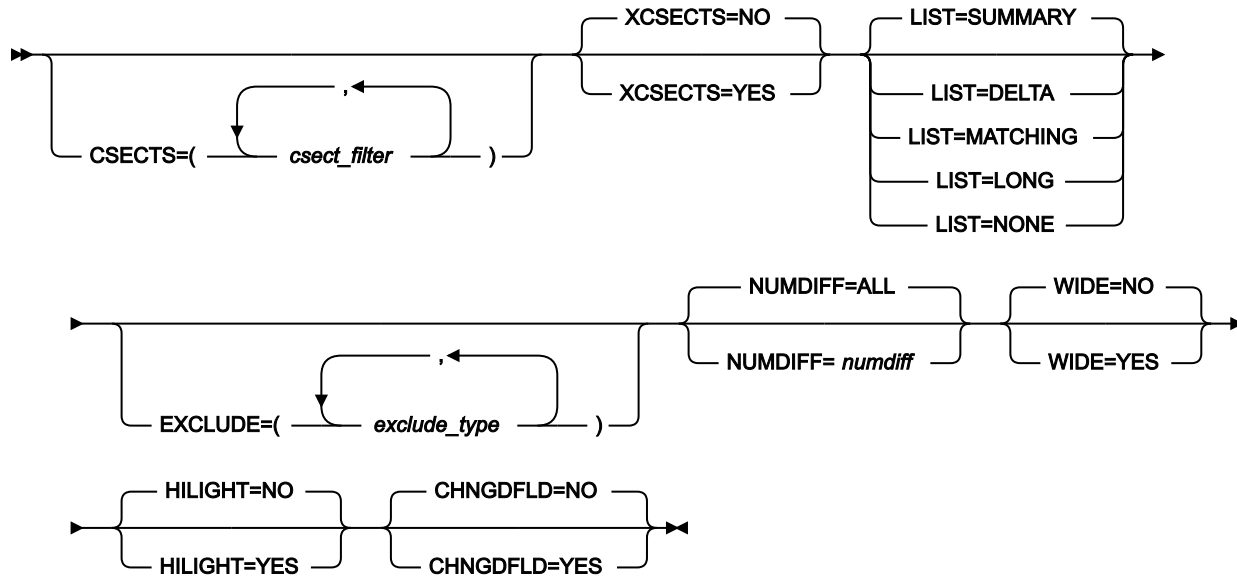

Old data set specifications

The "Old" data set can be specified as follows:

DDOLD=ddold

Defines a reference to a DD or TSO ALLOC statement for the "Old" load library. The default is DDOLD.

DSNOLD=dsnold

Defines the name of the "Old" load library (PDS). If specified, any DD statements provided are not used. The name may include a member name in parenthesis. If the member is specified here, the associated MEMOLD parameter must be empty. To further describe the data set, use the following:

VOLSEROLD=volserold

The VOLUME serial number for a non-cataloged "Old" data set.

MEMOLD=memold

The name of a single member in a PDS, or a member name pattern representing one or more members in a load library. You may specify this parameter, or a member name in the DD statement for *ddname*, or specify a member or members in the MEMLIST parameter, or specify a range of member names with the MEMSTART and MEMEND keywords.

A member name pattern can consist of any characters that are valid in a member name and two special pattern characters: the asterisk (*) and the percent symbol (%).

An * represents any number of characters. As many asterisks as required can appear anywhere in a member name pattern. For example, if you enter a member name pattern of *d*, all members in the PDS whose name contains "d" are processed.

A % is a place-holding character that means a single character. As many percent symbols as necessary can appear anywhere in a member name pattern. For example, if you enter a member name pattern of %%%%, all members in the PDS with a 4-character name are processed.

MEMSTART=*startstring*

Is used to specify the start of a range of member names to be included in the compare. If MEMSTART is specified but MEMEND is omitted, all members of the PDS(E) from the *startstring* value onwards are included. *startstring* can have the same values, including wild cards, as for the *memold* parameter of the MEMOLD keyword.

MEMEND=*endstring*

Is used to specify the end of a range of member names to be included in the compare. If MEMEND is specified but MEMSTART is omitted, all members of the PDS(E) up to the *endstring* value onwards are included. *endstring* can have the same values, including wild cards, as for the *memold* parameter of the MEMOLD keyword.

XMEMBERS

Provides a way to exclude from processing library members that would otherwise be selected using the MEMSTART, MEMEND, and MEMBER options.

xmem_filter

A member name filter identifying one or more members that are to be excluded from processing. A filter can be a member name pattern representing multiple members.

To specify a member name filter containing lowercase characters, use a character string in the format `c'string'`. Filter values can also be specified as hexadecimal strings in the format `x'hex-digits'`.

MEMLIST

Provides a means of selecting members from a load library where no generic name pattern and no member name range has been specified. If the MEMLIST keyword is specified, only those members included in the MEMLIST arguments are compared with the corresponding members in the output data set. Members selected by the MEMBER=*memold* that are not included in the MEMLIST arguments are not compared.

comp_mem

The name of the member to be compared. Generic name masks are not allowed.

SKIPOLD=*skipold*

Number of logical records to be skipped from the beginning of the "Old" data set. The default is 0. Note that the number of logical records describing a load module is equal to the number of CSECTs plus 1 (one record describes the load module itself).

CMPOLD=*cmpold*

Number of records from the "Old" data set to be compared. The maximum number is 99 999 999. If you specify ALL or omit the parameter, all the remaining records are compared. Note that the number of logical records describing a load module is equal to the number of CSECTs plus 1 (one record describes the load module itself).

New data set specifications

The "New" data set can be specified as follows:

DDNEW=*ddnew*

Defines a reference to a DD or TSO ALLOC statement for the "New" load module library. The default is DDNEW.

DSNNEW=*dsnnew*

Defines the name of the "New" load module library (PDS). If specified, any DD statement provided are not used. The name can include a member name in parenthesis. If the member is specified here, the associated MEMNEW parameter must be empty. To further describe the data set, use:

VOLSERNEW=*volsernew*

The VOLUME serial number for a non-cataloged "New" data set.

MEMNEW=*memnew*

The name of a single member in a load library, or a member name pattern representing one or more members in the library. You can specify this parameter, or a member name in the DD statement for *ddname*.

A member name pattern can consist of any characters that are valid in a member name and two special pattern characters: the asterisk (*) and the percent symbol (%).

An * represents any number of characters. As many asterisks as required can appear anywhere in a member name pattern. For example, if you enter a member name pattern of *d*, all members in the library whose name contains "d" are processed.

A % is a place holding character that means a single character. As many percent symbols as necessary can appear anywhere in a member name pattern. For example, if you enter a member name pattern of %%%%, all members in the library with a 4-character name are processed.

Specification of MEMNEW (or a member in DSNNEW) depends on parameters used in MEMOLD (or member used in DSNOLD). If MEMOLD (member in DSNOLD) specifies one member, MEMNEW (member in DSNNEW) must also point to one member. If MEMOLD (member in DSNOLD) contains a member name pattern, specification of MEMNEW (member in DSNNEW) must use the same pattern or an "*".

SKIPNEW=skipnew

Number of logical records to be skipped from the beginning of the 'New' data set. The default is 0. Note that the number of logical records describing a load module is equal to the number of CSECTs plus 1 (one record describes the load module itself).

CMPNEW=cmpnew

Number of records from the "New" data set to be compared. The maximum number is 99 999 999. If you specify ALL or omit the parameter, all the remaining records are compared. Note that the number of logical records describing a load module is equal to the number of CSECTs plus 1 (one record describes the load module itself).

Compare options**CMPVLV**

Determines the level of the load module comparison.

LMOD

Only information on the load module level is extracted and compared. CSECT information (and differences on CSECT level) are ignored. This results in a less detailed comparison.

CSECT

Information on both the load module and CSECT levels is extracted and compared. This results in a detailed comparison.

LMODC

Determines what information at the load module level is to be included in the compare. The criteria correspond with the load module properties; only those specified are compared and displayed. Each of the options below can be specified in any sequence, enclosed in parenthesis:

SIZE

The load module size is compared.

ADDRESS

The entry point address of the load module is compared.

LINKER | BINDER

The version of the linkage editor or the binder used to prepare the load module is compared. LINKER and BINDER are mutually exclusive.

DATE | TIME

The load module link (bind) date and time are compared. DATE and TIME are mutually exclusive.

MODE

The AMODE and RMODE of the load module are compared.

AC | AUTH

The load module authorization code is compared. AC and AUTH are mutually exclusive.

ATTR

The load module link (bind) attributes are compared.

CSECTC

Determines what information at the CSECT level is to be included in the compare. The criteria correspond with the CSECT properties; only those specified are compared and displayed. Each of the options below can be specified in any sequence, enclosed in parenthesis.



Note: If you specify CMPLVL=LMOD, this parameter is ignored.

SIZE

The CSECT size is compared.

ADDRESS

The address of the CSECT is compared.

COMPILER

The versions of the language compilers used to compile the CSECT are compared

DATE

The date of the CSECT compile is compared.

MODE

The AMODE and RMODE of the CSECT are compared.

IDRZAP | ZAP

The AMSPZAP IDR data is compared. The IDR ZAP data is an extension of the CSECT information, but is formatted into separate records. ISRZAP and ZAP are mutually exclusive.

TEXT

The CSECT content is compared. The CSECT content is an extension of the CSECT information, but is formatted into separate, 32-byte records and shown in "memory dump" format (hexadecimal and character).



Note: If you specify TEXT, the listing option is set to `WIDE=YES` to accommodate the dump format comparison.

COPT

The compiler options for each CSECT are compared if they can be determined.

ATTR

If the program language attributes for each CSECT are available, they are compared.

CSECTS

Provides a way to exclude or include CSECTS from comparison. The XCSECTS option identifies whether the filters are used to exclude or include CSECTS.

csect_filter

A CSECT name filter identifying one or more CSECTS to be either included or excluded from comparison. The wildcard characters * and % can be used to define a CSECT name pattern representing multiple CSECTS.

XCSECTS=NO

Use the CSECTS option to identify CSECTS to be *included* for comparison.

XCSECTS=YES

Use the CSECTS option to identify CSECTS to be *excluded* from comparison.

LIST=SUMMARY

Summary listing.

LIST=DELTA

Delta listing.

LIST=MATCHING

Matching listing.

LIST=LONG

Long listing.

LIST=NONE

No listing.

Listing Options

The following option takes effect if the LIST=LONG parameter is specified:

EXCLUDE=exclude_type

The specified compare result types are not reported. *exclude_type* can have the following values:

INSERTED

Excludes inserted records from the report.

DELETED

Excludes deleted records from the report.

CHANGED

Excludes changed records from the report.

MATCHED

Excludes matched records from the report.

The following options take effect if the LIST keyword is not specified (that is, it defaults to SUMMARY) or is set to anything other than NONE:

NUMDIFF=*numdiff*

The number of differences after which the Compare Utility stops processing the data sets.

WIDE=NO

Narrow listing.

WIDE=YES

Wide listing.

HILIGHT=NO

No highlighting of changed fields.

HILIGHT=YES

Highlight changed fields.

CHNGDFLD=NO

Show all fields in the formatted comparison reports.

CHNGDFLD=YES

Show only changed fields in formatted comparison reports. This option has no effect if the 'Wide listing' (WIDE=YES) option has been selected

DATEFORM=YYYYDDD

Reported dates (link and compile dates) shown in YYYY.DDD format.

DATEFORM=YMMDD

Reported dates (link and compile dates) shown in YY/MM/DD format.

A batch example: Comparison of two versions of a module.

```
//CLM JOB (ACCT), 'NAME'  
//* COMPARE LOAD MODULES  
//*  
//FMBAT PROC  
//FMBAT EXEC PGM=FILEMGR  
//STEPLIB DD DSN=FMN.SFMNMOD1,DISP=SHR  
//SYSPRINT DD SYSOUT=*  
//SYSABEND DD SYSOUT=*  
//SYSUDUMP DD SYSOUT=*  
// PEND
```



```

/**
//STPSSEX EXEC FMBAT
//SYSIN DD *
$$FILEM VER
$$FILEM CLM CmplVL=CSECT,
$$FILEM LIST=DELTA,
$$FILEM WIDE=YES,
$$FILEM HILIGHT=YES,
$$FILEM DSNOLD=FMN.PROD1.LOAD(FMNLLOAD),
$$FILEM DSNNEW=FMN.PROD2.LOAD(FMNLLOAD),
$$FILEM LMODC=(SIZE,DATE,ATTR),
$$FILEM CSECTC=(SIZE,ADDR,DATE,ZAP)
$$FILEM EOJ

```

**Note:**

1. Load modules are compared at load module and CSECT level.
2. Load module size, date and time when load module was linked (bound), and link attributes are compared at load module level.
3. CSECT address, size, date of compile and IDR ZAP data are compared at CSECT level.

DEFV (Define VSAM Statements)

Purpose

This function produces IDCAMS define statements for one or more VSAM data sets to an output data set defined to DD FMNDEFV.

Figure 421. Syntax

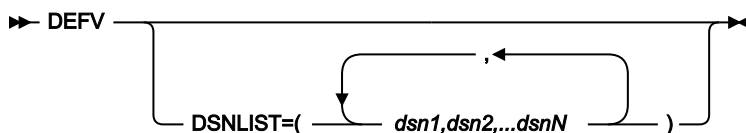

Where,

DSNLIST

Is a list of comma delimited data set names. A fully qualified or generic data set name can be specified. Only VSAM clusters matching the data set names specified are included in the DEFINE statements produced.

In a generic name, use the percent (%) sign to represent a single character, and an asterisk (*) to represent any number of characters within one qualifier. Two asterisks (**) represent any number of characters within any number of qualifiers.

Example 1. Batch job

```

//FMBAT EXEC PGM=FMNMAIN
//FMNDEFV DD SYSOUT=*
//SYSPRINT DD SYSOUT=*
//SYSIN DD *

```

```

$$FILEM DEFV ,
$$FILEM DSNLIST=(FMN.FMDATA.K*,
$$FILEM FMN.FMDATA.ESDS,
$$FILEM userid.FMDATA.**)
```

Example 2. REXX exec for usage with ISPF 3.4

```

/* REXX - VSAM define statements for data set */
ARG DSN
CALL FMNELIBD DEF      /* Remove if not using LIBDEFS */
ADDRESS TSO
  "ALLOC FI(FMNPRINT) DA(*) REUSE"
  "ALLOC FI(FMNDEFV) NEW SP(1,5) TRACKS"
ADDRESS ISPEXEC
  "SELECT CMD(FILEMGR $DEFV DSNLIST=("DSN"))"
  "LMINIT DATAID(DEFID) DDNAME(FMNDEFV) ENQ(SHR)"
  IF RC = 0 THEN DO;
    "VIEW DATAID("DEFID")"
    IF RC > 8 THEN
      "SETMSG MSG("ZERRMSG)"
      "LMFREE DATAID("DEFID")"
  END;
ADDRESS TSO
  "FREE FI(FMNPRINT)"
  "FREE FI(FMNDEFV)"
CALL FMNELIBD DROP    /* Remove if not using LIBDEFS */
EXIT 0;
```

DP (Disk Print)

Purpose

Print physical disk records.

Usage notes

Use this function to print all records from a physical disk extent in character format or one of the two dump formats. Begin and end positions must be specified as a range of tracks.

Options

You can use the various SET processing options to control the print output:

- SET PRINTOUT defines the destination of the print output. If set to PRINTOUT=SYSOUT, you can use the PB (Print Browse) function to browse the accumulated output.
- SET RECLIMIT controls how many bytes of each record are printed.
- SET DATAHDR determines whether header information, such as record number, is printed.
- The format of the print output also depends on the settings of SET PAGESIZE, SET PRINTLEN and SET PRTRTRANS.
- Use SET DUMP to specify the dump format.

Specify a logical record length to deblock the physical records. If it is not a multiple of the physical record size, the remainder is printed as a short record.

Use the LISTONLY keyword to specify how much information you want to print. You can request the home address and all count, key, and data fields of each track, or only count or key fields. The default is to print all key and data fields.

For a CKD disk, use the dump type to specify how much information you want to print. You can request the home address and all count, key, and data fields of each track, or only count or key fields. The default is to print all key and data fields.

Related functions

DRS

Locate data on a disk

DSP

Print records from a data set

Figure 422. Syntax

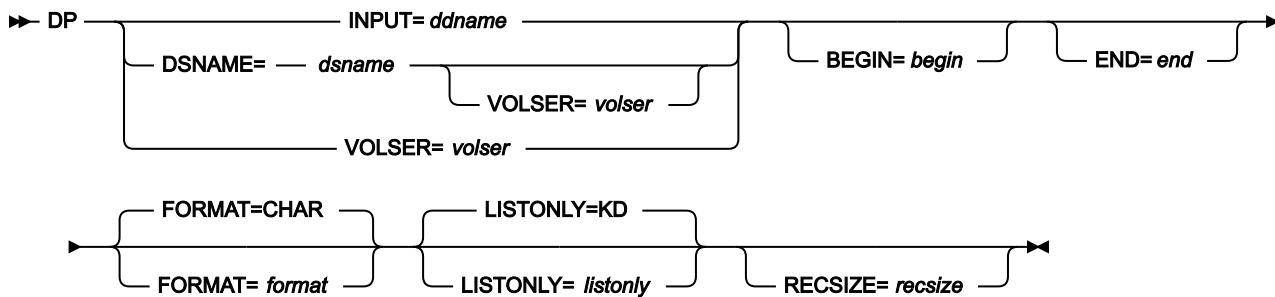

begin

Start position in one of the following forms:

cylhd

Where the last two digits represent the head, and the other digits represent the cylinder (CKD)

Rnnnnnn

To indicate the track number (CKD)

*

The first track of the data set (the default).

Depending on the value of the SET CYLHD processing option, you specify either the absolute disk location or the relative location within the data set.

ddname

Refers to a DD or TSO ALLOC statement.

dsname

Name of a disk data set.

end

End position in one of the following forms:

cylhd

Where the last two digits represent the head, and the other digits represent the cylinder (CKD)

Rnnnnnn

To indicate the track number (CKD)

Nnnnnnnn

The number of tracks (CKD) to be processed

*

The last track of the data set (the default).

Depending on the value of the SET CYLHD processing option, you specify either the absolute disk location or the relative location within the data set.

format

The format of the output:

CHAR

Character format (the default)

HEX

Hexadecimal format.

listonly

For a CKD disk, the information you want printed:

KD

Key and data fields of each record (the default)

CNT

Home address and count fields of each record

CKD

Home address and record 0 fields, followed by the count, key, and data fields

KEY

Only the key fields.

resize

Logical record size to be used to deblock each physical record into logical records. The maximum is 65 535. The physical block size does not need to be a multiple of *resize*. For a CKD disk, only the data field is deblocked.

volser

Volume serial number for a non-cataloged data set.

```
//DP JOB (acct),'name' Disk Print
//*
//FMBAT PROC
//FMBAT EXEC PGM=FILEMGR
//STEPLIB DD DSN=FMN.SFMNMOD1,DISP=SHR
//SYSPRINT DD SYSOUT=*
//SYSABEND DD SYSOUT=*
//SYSUDUMP DD SYSOUT=*
// PEND
//*
//FILEMGR EXEC FMBAT
//DISK DD DSN=FM0.H0GB210.SFMNMOD1,DISP=SHR
//SYSIN DD *
$$FILEM SET CYLHD=RELATIVE
$$FILEM DP INPUT=DISK,BEGIN=R0,END=N10
$$FILEM E0J
/*
```

DRS (Disk Record Scan)

Purpose

Locate data on a disk.

Usage notes

Use this function to locate physical disk records containing data that meet your search criteria. The scan range must be specified as a range of tracks.

You can search for a specific string or for end-of-file records. The search string can contain up to 50 characters and can be:

- A character string. The string cannot contain blanks or commas. Case (uppercase or lowercase) is ignored.
- A character string enclosed in quotation marks. The string can contain blanks and commas and must match exactly (including case).
- A hexadecimal string, for example X'04'.

File Manager prints all matching records in hexadecimal dump format and lists on the terminal the record location and the position of the string.

Options

Specify a record length to deblock the physical records before searching. The search can apply to the key or data part of the record. You can request searching everywhere in the data, from a position you specify, or only at the specified offset.

You can use the various SET processing options to control the print output:

- SET PRINTOUT defines the destination of the print output. If set to PRINTOUT=SYSOUT, you can use the PB (Print Browse) function to browse the accumulated output.
- SET RECLIMIT controls how many bytes of each record are printed.
- The format of the print output also depends on the settings of SET PAGESIZE, SET PRINTLEN, and SET PRTRTRANS.
- Use SET DUMP to specify the dump format.

Related functions

DP

Print physical disk records

FCH

Find or change data

Figure 423. Syntax

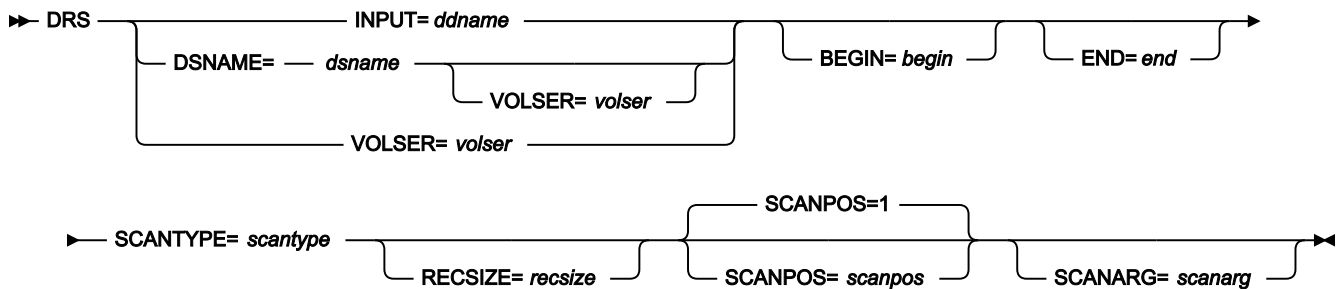

begin

Start position in one of the following forms:

cylhd

Where the last two digits represent the head, and the other digits represent the cylinder (CKD)

Rnnnnnn

To indicate the track number (CKD)

*

The first track of the data set (the default).

Depending on the value of the SET CYLHD processing option, you specify either the absolute disk location or the relative location within the data set.

ddname

Refers to a DD or TSO ALLOC statement.

dsname

Name of a disk data set.

end

End position in one of the following forms:

cylhd

Where the last two digits represent the head, and the other digits represent the cylinder (CKD)

Rnnnnnn

To indicate the track number (CKD)

Nnnnnnn

The number of tracks (CKD) to be processed

*

The last track of the data set (the default).

Depending on the value of the SET CYLHD processing option, you specify either the absolute disk location or the relative location within the data set.

resize

Logical record size to be used to deblock each physical record into logical records. The maximum is 65 535. The physical block size does not need to be a multiple of *resize*.

scanarg

The string to be searched for. The string can contain up to 50 characters and can be:

- A character string. The string cannot contain blanks or commas. Case (uppercase or lowercase) is ignored.
- A character string enclosed in quotation marks. The string *can* contain blanks and commas; the string must match exactly (including case).
- X followed by a hexadecimal string enclosed in quotation marks (X'C1C2'), or a hexadecimal string enclosed in quotation marks followed by \underline{x} ('C1C2'X).

The *scanarg* parameter is required unless *scantype* is E.

scanpos

Offset (byte position) where the search begins within a record. The default is 1.

scantype

One of the following:

D

Scans data fields *only* at the position in the record specified by *scanpos*

DP

Scans data fields *starting* at the position in the record specified by *scanpos*

K

Scans key fields *only* at the position in the record specified by *scanpos* (CKD disks only)

KP

Scans key fields *starting* at the position in the record specified by *scanpos* (CKD only)

E

Scans for end-of-file records.

volser

Volume serial number for a non-cataloged data set.

```
//DRS JOB (acct),'name' Disk Record Scan
//*
//FMBAT PROC
//FMBAT EXEC PGM=FILEMGR
//STEPLIB DD DSN=FMN.SFMNMOD1,DISP=SHR
//SYSPRINT DD SYSOUT=*
//SYSABEND DD SYSOUT=*
//SYSUDUMP DD SYSOUT=*
// PEND
//*
//DELETE EXEC PGM=IEFBR14
//SYSUT2 DD DSN=FMNUSER.TEMP.SEARCH.FILE,
// DISP=(MOD,DELETE),
// UNIT=SYSALLDA,
// SPACE=(TRK,(3,1),RLSE),
// RECFM=FB,LRECL=80,BLKSIZE=24000
//*
//MAKEFILE EXEC PGM=IEBGENER
//SYSIN DD *
/*
//SYSPRINT DD SYSOUT=*
//SYSUT1 DD *
Andrew Apple
Ted Dexter
Grant Smith
Keith Sampson
Graham Prestcott
John Laws
Bill McCork
Liz Childs
/*
//SYSUT2 DD DSN=FMNUSER.TEMP.SEARCH.FILE,
// DISP=(,CATLG),
// UNIT=SYSALLDA,
// SPACE=(TRK,(3,1),RLSE),
// RECFM=FB,LRECL=80,BLKSIZE=24000
//*
//FILEMGR EXEC FMBAT
//SYSPRINT DD SYSOUT=*
//DISK DD DSN=FMNUSER.TEMP.SEARCH.FILE,
// DISP=SHR
//SYSIN DD *
$$$$FILEM DRS INPUT=DISK,BEGIN=*,END=*,
```



```
$$FILEM SCANTYPE=DP,SCANARG=' Laws '  
$$FILEM E0J  
/*
```

DSB (Data Set Browse)

Purpose

The DSB function displays the Data Set Browse or Browse Entry panel, in online mode. This function can be invoked from a REXX program or a TSO clist or entered on an ISPF Command line, but **cannot** be used in batch jobs as it is an interactive function.

Usage notes

When invoked from an ISPF Command line without a parameter, the Data Set Browse Entry panel is displayed in interactive mode and you can specify a valid data set for browsing. If you include a valid data set name as a parameter, then you bypass the Entry panel, and go directly to browsing the specified data set.

When invoked from a REXX procedure or TSO list, you must supply the data set name.

Related functions

DSE

Display Data Set Edit or Edit Entry panel

DSEB

Update disk data set records

DSU

Update disk data set records

Figure 424. Syntax

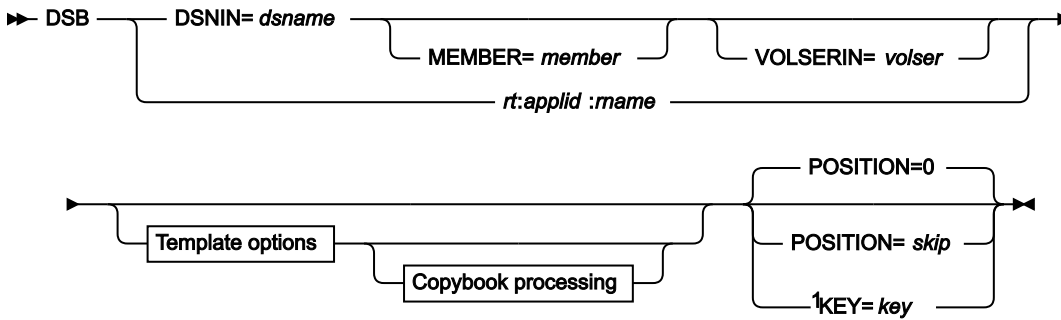

Template options

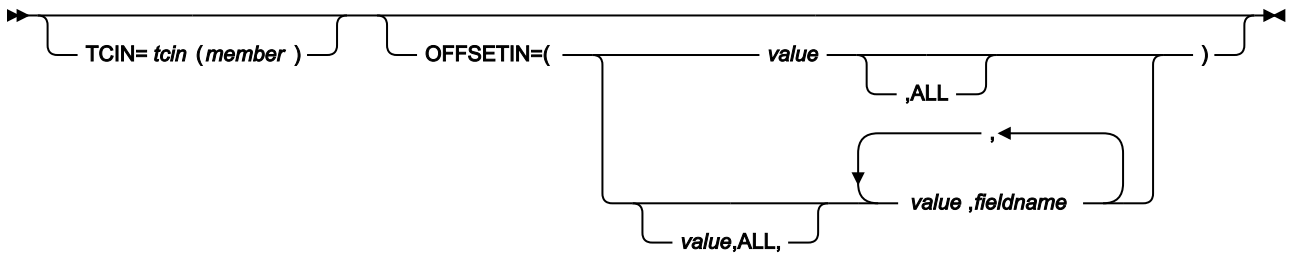

Copybook processing

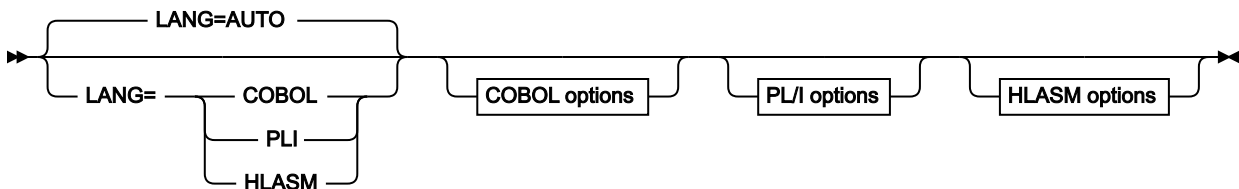

COBOL options

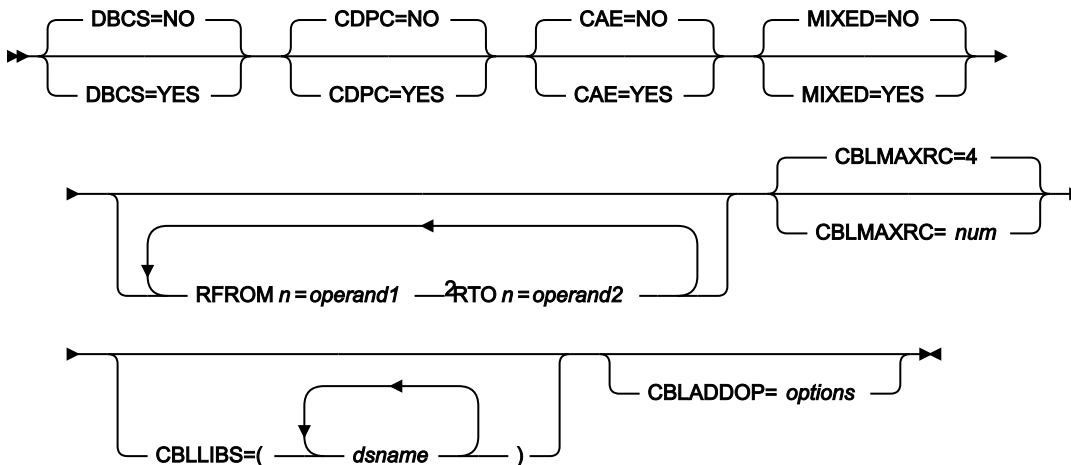

Notes:

¹ VSAM only.

² n= 1 to 5.

PL/I options

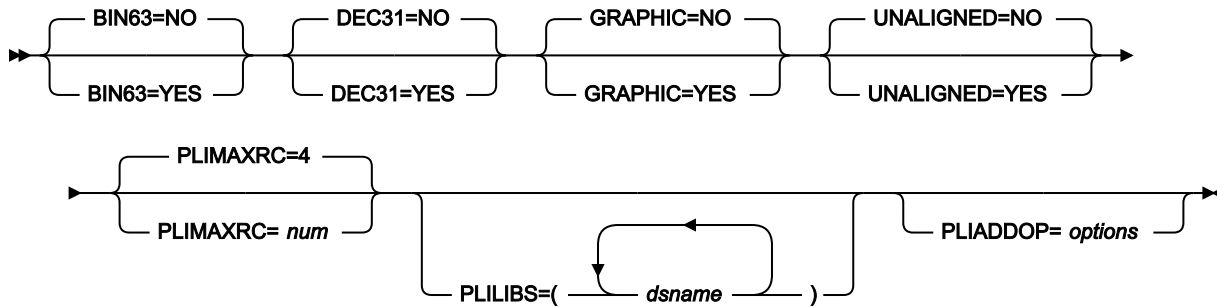

HLASM options

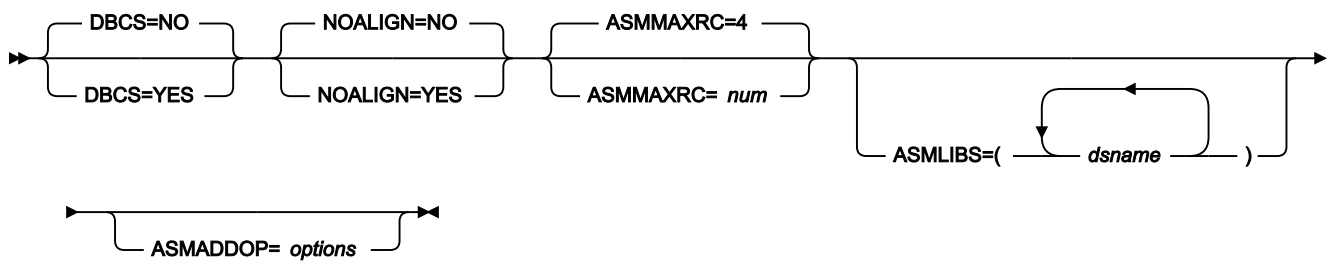
**DSNIN=dsname**

Defines the name of the data set to be browsed. If specified, any DD statement provided are not used. The name can include a member name in parenthesis. If the member is specified here, the associated Member parameter must be empty.

Must be specified when \$DSB is invoked from a REXX procedure or TSO clist.

Can be omitted when DSB is entered on a command line. If specified, you bypass the Entry panel, and go directly to the Data Set Browse panel. When omitted, the Data Set Browse Entry panel is displayed in interactive mode and you can specify a valid data set for browsing.

You can further describe this data set, as follows:

MEMBER=member

The name of a single member in a PDS, or a member name pattern representing one or more members in a PDS. If the data set is a PDS, you must specify this parameter.

A member name pattern can consist of any characters that are valid in a member name and two special pattern characters: the asterisk (*) and the percent symbol (%).

*

represents any number of characters. As many asterisks as required can appear anywhere in a member name pattern. For example, if you enter a member name pattern of *d*, all members in the PDS whose name contains "d" are processed.

%

is a place holding character that means a single character. As many percent symbols as necessary can appear anywhere in a member name pattern. For example, if you enter a member name pattern of `%%%`, all members in the PDS whose name is four characters in length are processed.

`MEMBER=member` is ignored if the data set is not a PDS.

rt:applid:rname

You can specify a CICS® resource in place of a data set name, where:

rt

Resource type. Valid values are:

FI

For a CICS® file.

TD

For a Transient Data Queue.

TS

For a Temporary Storage Queue.

applid

The VTAM® applid of the CICS® system.

rname

The name of the resource.

VOLSERIN=volser

Volume serial number for a non-cataloged data set.

POSITION=skip

Number of logical records to be skipped from the beginning of the data set. The default is 0.

KEY=key (VSAM only)

A key for KSDS records, or a slot number for RRDS records. The maximum key length is 30 characters. The first record with a key or slot value greater than or equal to *key* is the first record copied. If you omit the *key* and *skip* values, browsing begins with the first record in the data set.

If the key contains lowercase characters, blanks, or commas, enclose it in quotation marks. You can also specify a key in hexadecimal format (for example, X'C1C2C3').

TCIN=tcin(member)

PDS and member name of the copybook or template that describes the record structure of your data set.

OFFSETIN

The length of the 01 field in the template and the start locations of the fields within that 01 field are adjusted by the value provided.

value

The offset value, which must be in the range -32760 to 32760, to be applied to the corresponding field identifier. If no field identifier is supplied and ALL is not used, the value is applied to the first Level 01 field in the template.

ALL

Where the template contains multiple record structures, this keyword applies the corresponding *value* to all Level 01 within the template.



Note: You can specify a value for ALL and then override this value for individual layouts by providing subsequent *value* and *fieldname* combinations.

fieldname

The name of the Level 01 field to which *value* is to be applied. The default is the first Level 01 field in the template.

Copybook processing

If you specify a copybook (instead of an existing template), File Manager uses these processing options to compile the copybook into a template:

LANG

Determines whether File Manager automatically detects the copybook language or interprets the language as COBOL, PL/I, or HLASM.



Note: The COMPLANG setting in FMN0POPT is the equivalent of the LANG parameter in batch functions.



- If COMPLANG is set it determines the installation default language for online and batch compilation.
- If COMPLANG is not specified then COBOL is the installation default for online compilation and AUTO is the default for batch compilation.
- If a value of COBOL, HLASM, PL/I, or AUTO is specified (in the **Compiler Language Selection** panel or through the LANG parameter in a batch job) it overrides the default language.

AUTO

Automatically detect whether the copybook language is COBOL or PL/I, and invoke the appropriate compiler. If the compilation results in a return code greater than 4, then invoke the compiler for the other language. If the second compilation also results in a return code greater than 4, then retry the first compiler and report the compilation errors. If File Manager successfully creates a template (despite the compilation errors), then continue processing with the template.

COBOL

Invoke the COBOL compiler to create a template from the copybook. (Do not invoke the PL/I compiler, even if the COBOL compilation results in errors.)

PLI

Invoke the PL/I compiler to create a template from the copybook. (Do not invoke the COBOL compiler, even if the PL/I compilation results in errors.)

HLASM

Invoke the HLASM compiler to create a template from the copybook.

DSINFO

Specifies whether additional data set information for input and output sources should be produced in batch reports for the DSP, DSM, DSC, and FCH commands.

NO

No additional data set information is generated.

YES

Generates data set information including DSORG, RECFM, LRECL, BLKSIZE, and VSAM attributes including average record length, maximum record length, key offset, key length and reuse, for input and output data sets when applicable.

COBOL options

The following options are used to compile a COBOL copybook into a template:

DBCS=YES

Use the DBCS compiler option.

DBCS=NO

Use the NODBCS compiler option.

For details on the effect of the DBCS and NODBCS compiler options, see the *IBM COBOL Programming Guide for OS/390 & VM*.

CDPC=NO

Do not use the COBOL SPECIAL-NAMES paragraph "Decimal-point is comma".

CDPC = YES

Use the COBOL SPECIAL-NAMES paragraph "Decimal-point is comma".

CAE=NO

Do not use the COBOL compile option ARITH(EXTEND).

CAE = YES

Use the COBOL compile option ARITH(EXTEND).

MIXED = NO

Field names stored in the template in uppercase.

MIXED = YES

Field names stored in the template in the original case as coded in the COBOL copybook.

RFROM1 RT01 ... RFROM5 RT05

Up to five pairs of "From" and "To" pseudo-text character strings for the COBOL REPLACE compiler-directing statement.

If your COBOL copybooks contain characters that you want to remove or replace with other characters before compiling the copybooks into templates, then use these replacing options.

For example, if your copybooks contain colon characters (:) that you want to remove before compiling, then specify '==:==' as *operand1* and '====' as *operand2*. This would be specified as:

```
RFROM1==:==,RT01====,
```

For details on specifying "From" and "To" strings for COBOL REPLACE, see the *IBM COBOL Language Reference*.

CBLMAXRC

Sets the maximum acceptable return code for a copybook compile. A return code higher than the specified level causes the function to stop. Default is 4.



Note: The COMPMAXRC parameter is still supported but it is recommended that the CBLMAXRC parameter is used instead. If you do specify the COMPMAXRC parameter, it takes precedence over the language MAXRC.

CBLLIBS

Allows you to specify a list of up to ten data set names to be specified in the SYSLIB concatenation list. These data sets are searched in the order specified for COPY and INCLUDE members for the compilation.

dsname

The name of the data set name to be processed. Generic name masks are not allowed.

CBLADDOP

Additional COBOL compiler options which are included in a CBL statement when compiling COBOL copybooks.

PL/I options

The following options are used to compile a PL/I copybook into a template:

BIN63=YES

Use the LIMITS(FIXEDBIN(63)) compiler option.

BIN63=NO

Use the LIMITS(FIXEDBIN(31)) compiler option.

DEC31=YES

Use the LIMITS(FIXEDDEC(31)) compiler option.

DEC31=NO

Use the LIMITS(FIXEDDEC(15)) compiler option.

GRAPHIC=YES

Use the GRAPHIC compiler option.

GRAPHIC=NO

Use the NOGRAPHIC compiler option.

UNALIGNED=YES

Use the DEFAULT RANGE (*) UNALIGNED, language statement to change the default alignment.

UNALIGNED=NO

Use the PL/I default.

PLIMAXRC

Sets the maximum acceptable return code for a copybook compile. A return code higher than the specified level causes the function to stop. Default is 4.



Note: The COMPMAXRC parameter is still supported but it is recommended that the PLIMAXRC parameter is used instead. If you do specify the COMPMAXRC parameter, it takes precedence over the language MAXRC.

PLILIBS

Allows you to specify a list of up to ten data set names to be specified in the SYSLIB concatenation list. These data sets are searched in the order specified for COPY and INCLUDE members for the compilation.

dsname

The name of the data set name to be processed. Generic name masks are not allowed.

PLIADDOP

Additional PL/I compiler options which are included in a *PROCESS statement when compiling PL/I copybooks.

For details on the effect of these compiler options, see the *IBM VisualAge PL/I for OS/390 Programming Guide*.

HLASM options

The following options are used to compile a HLASM copybook into a template:

DBCS=YES

Use the DBCS compiler option.

DBCS=NO

Use the NODBCS compiler option.

NOALIGN=YES

Use the NOALIGN compiler option.

NOALIGN=NO

Use the ALIGN compiler option.

ASMMAXRC

Sets the maximum acceptable return code for a copybook compile. A return code higher than the specified level causes the function to stop. Default is 4.



Note: The COMPMAXRC parameter is still supported but it is recommended that the ASMMAXRC parameter is used instead. If you do specify the COMPMAXRC parameter, it takes precedence over the language MAXRC.

ASMLIBS

Allows you to specify a list of up to ten data set names to be specified in the SYSLIB concatenation list. These data sets are searched in the order specified for COPY and INCLUDE members for the compilation.

dsname

The name of the data set name to be processed. Generic name masks are not allowed.

ASMADDOP

Additional HLASM compiler options which are included in a *PROCESS statement when compiling COPY and MACRO members.

For details on the effect of these compiler options, see the *HLASM V1R6 Programmer's Guide*.

- [Invoking File Manager panels from outside File Manager on page 39](#)
- [Introduction to programming with File Manager functions on page 503](#)
- [Invoking File Manager panels from REXX procedures or TSO clists on page 507](#)

```
FILEMGR "$DSB DSNIN='FMNUSER.TEST.KSDS1',KEY=000100"
```

```
FILEMGR DSB
```

DSC (Data Set Copy)

Purpose

Use the DSC function to copy data from any supported data set to any other supported data set. The function's performance when copying PDS and PDSE data sets greatly depends on the available storage: larger regions generally result in better performance.

Usage notes

- You can select the records to be copied using:
 - Member name selection criteria
 - Date created selection criteria
 - Date last modified selection criteria
 - User ID selection criteria
 - The start key (VSAM only)

- The skip field
- The copy count field
- A conditional expression defined in the *from* template
- Change data set attributes. File Manager can copy records where the input and output data sets have different record formats, record lengths, or block sizes. The copy process truncates or pads records appropriately. Specify the pad character in the PAD field of the SET function. For details see [SET \(Set Processing Options\) on page 1550](#).
- Copy from field to field. Using both a "From" and a "To" template lets you copy selected fields, change the size and type of fields, and create new fields in the output data set. For details, see [Copying data sets on page 341](#).
- Copy the output using an external format such as XML or CSV. The "From" template defines the traditional format of a data set, but also determines a natural character representation of the data. The result of the generation is an output data set containing a copy of the input data in the external format. For details, see [Generating data in external format - XML representation on page 353](#).
- Copy concatenated data sets with like or unlike attributes. Note that, under some conditions (with tape data sets), File Manager may not be able to detect unlike data set attributes and still invoke DFSORT for processing. Such invocation may fail as DFSORT does not allow for unlike concatenation of data sets. In such cases, you can disable the DFSORT with the NOSORT function to allow for successful processing of concatenated data sets with unlike attributes.
- Change ISPF packed format. File Manager can unpack existing packed members or sequential data sets, or can write members or sequential data sets in ISPF packed format.
- These changes are visible in the printed DSC BATCH processing report:
 - Member names are printed as specified on the CPYMBR list (when used).
 - Whenever a member name, its alias or new name (prompt value) contains unprintable characters, an additional line of output is printed below the regular output containing the hexadecimal values of the respective member names.
 - Whenever a member was located in the input library and appeared on the CPYMBR list but was not selected for processing because of the member mask or advanced member selection criteria, then it is shown in the processing report as "Not selected" (as opposed to "Not found") and be counted in the "not copied" category (as opposed to "in error").
 - For example, with these control cards:

```

$$$FILEM MEMBER=X'5C22',
$$$FILEM CPYMBR=(C'allocplx',
$$$FILEM          x'8289879784a222',
$$$FILEM          autotest,
$$$FILEM          X'84A282')
```

One would see this output:

Member Copy Report			
Member	Newname	Alias	Status
allocplx			Not selected
bigpds			Replaced
X'8289879784A222'			
AUTOTEST			Not found

```
dsb                               Not selected
FMN4688I 0 member(s) copied; 1 replaced; 2 not copied; 1 in error
```

- **Member names containing lowercase or unprintable characters:**
 - Member names specified with the CPYMBR, MEMBER, MEMSTART, MEMEND, or MEMOUT keywords may contain lowercase or unprintable characters.
 - To specify a member name containing lowercase or mixed case characters, use the character literal form of the name surrounded by quotation marks and preceded with character C. For example, C'aBc'.
 - To specify a member name containing unprintable characters, use the hexadecimal literal form of the name surrounded by quotation marks and preceded with character X. For example, X'81C283'. Mask characters (their hexadecimal value) may be included within the string.



Note: File Manager supports the copying of Load Modules, when the following conditions are met:

- Your input and output data sets are PDS or PDSE.
- Your TSO environment is active (and you can use the TSO authorized program services), or you are running File Manager as program-authorized.
- You have not specified a REXX user procedure.
- You have not specified Start key, Skip or Copy counts.
- You are not using templates.
- You do not request member record counts.

Performance tips

- See [General tips about performance when you use File Manager functions on page 1243](#). The comments about File Manager using DFSORT technology when performing sequential file I/O are important to DSC performance.
- When you are using DSC to copy members of a PDS(E):
 - One DSC default is STATS=ON, which causes the ISPF statistics for each copied member to be updated. This can significantly increase I/O (EXCP) and CPU utilization. To improve performance, consider using STATS=OFF.
 - File Manager attempts to use IEBCOPY or an equivalent product to copy members if it can. File Manager using IEBCOPY can significantly reduce I/O and CPU requirements, compared to File Manager not using IEBCOPY. If any File Manager processing of individual records is required, it cannot use IEBCOPY. For example, File Manager cannot use IEBCOPY if:
 - A proc (PROC=) is used.
 - A template or copybook is used.
 - Record counts are requested (RECCOUNTS=YES).
- File Manager does not use IEBCOPY when processing members of a PDS(E) when it detects any member names containing unprintable or lowercase characters since IEBCOPY is not capable of processing such member names. This may negatively affect the performance of the DSC operation.

Options

When you specify the PROC option, you are supplying a DFSORT™ or REXX procedure that controls the selection and formatting used during the copy function. For more information, see the *proc* parameter below.

Return codes

The default return codes from the DSC function have the following modified meanings:

- 1**
No records copied for some of multiple members.
- 2**
No records copied for any of multiple members.
- 2**
No Copy - duplicate records not copied.
- 2**
No Copy - REXX procedure has dropped records which are not subsequently copied.
- 3**
REXX member selection is in effect but the procedure encountered a RETURN DROP, STOP or STOP IMMEDIATE string. This has been treated as a RETURN string with no arguments.

OR
REXX member selection is NOT in effect but the procedure encountered a RETURN DROP MEMBER, RETURN PROCESS MEMBER string. This has been treated as a RETURN string with no arguments.
- 4**
No records copied because no records selected (for single member or data set)
- 4**
No records copied because no members to process
- 4**
No records copied because input empty
- 4**
No records copied because member exists and “no replace” option specified
- 4**
Input data set or member was skipped because it is in ISPF Packed Data format and the “PACK=SKIP” option was specified
- 8**
REXX non-syntax error encountered while processing records

8

Line generated in an external format is greater than output record size.

16

No records copied because input and output physically the same (not applicable to a PDS member)

16

Program Object specified - this is not supported

16

Output data set or member in use

16

Data set or member open error

16

Data set or member not found

16

Other input or output error occurred

16

Insufficient storage available

16

DSC abended

16

Input data appears ISPF packed but is not valid.

16

Other serious error that stops processing occurred



Note: Return codes can be customized during installation. If you receive return codes that do not match those listed above, your site might have customized the return codes for this function. File Manager may also issue the 999 abend, if the return code in batch is equal to or greater than the ABENDCC value. Contact your File Manager systems administrator for details.

Related functions

OS

Backup objects from an OAM database to a data set

OV

Backup objects from an OAM database to a VSAM data set

TS

Copy tape data to a data set

SO

Copy a data set to an object database

ST

Copy a data set to tape

VO

Copy VSAM data to an object database

Figure 425. Syntax

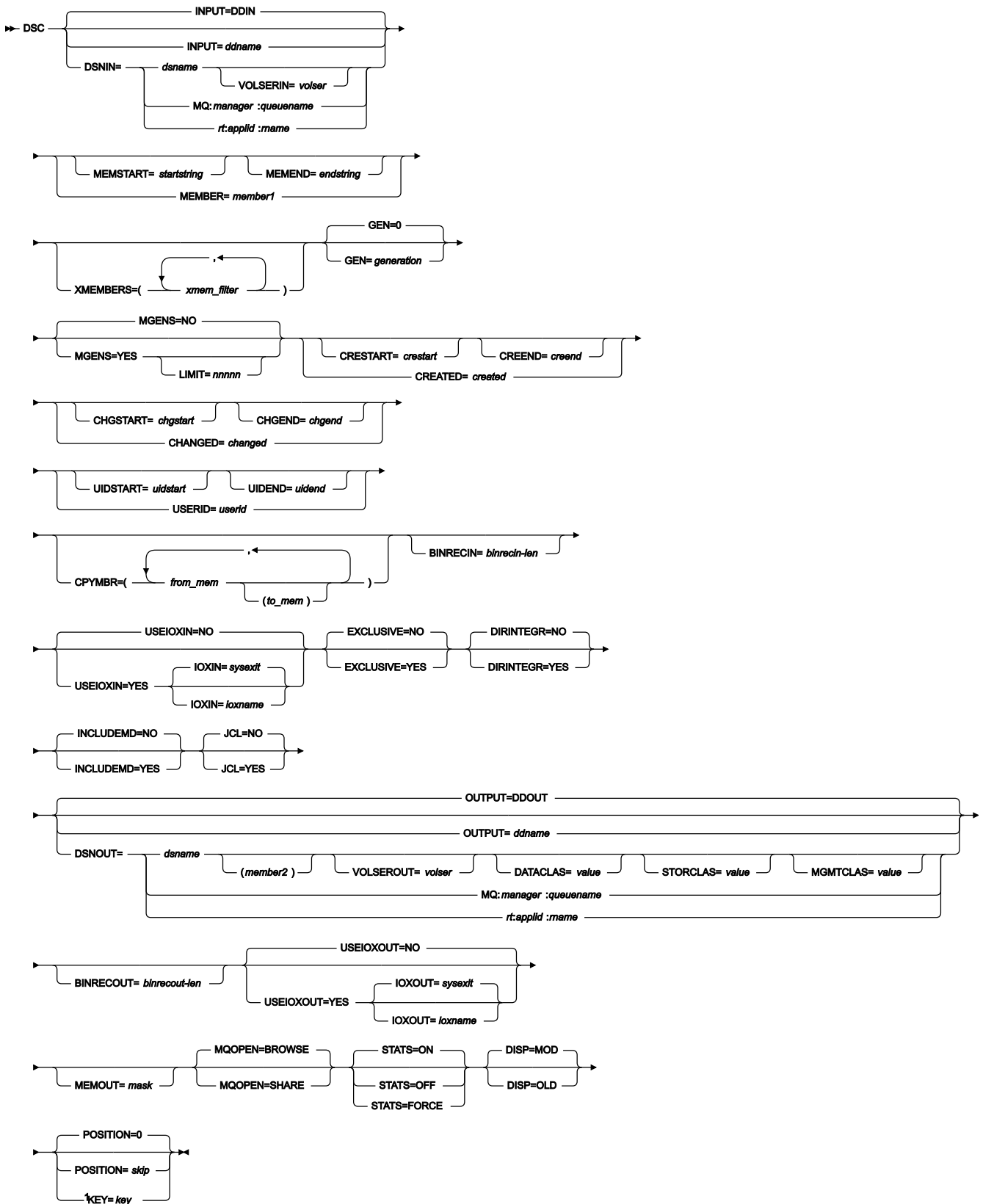

Notes:

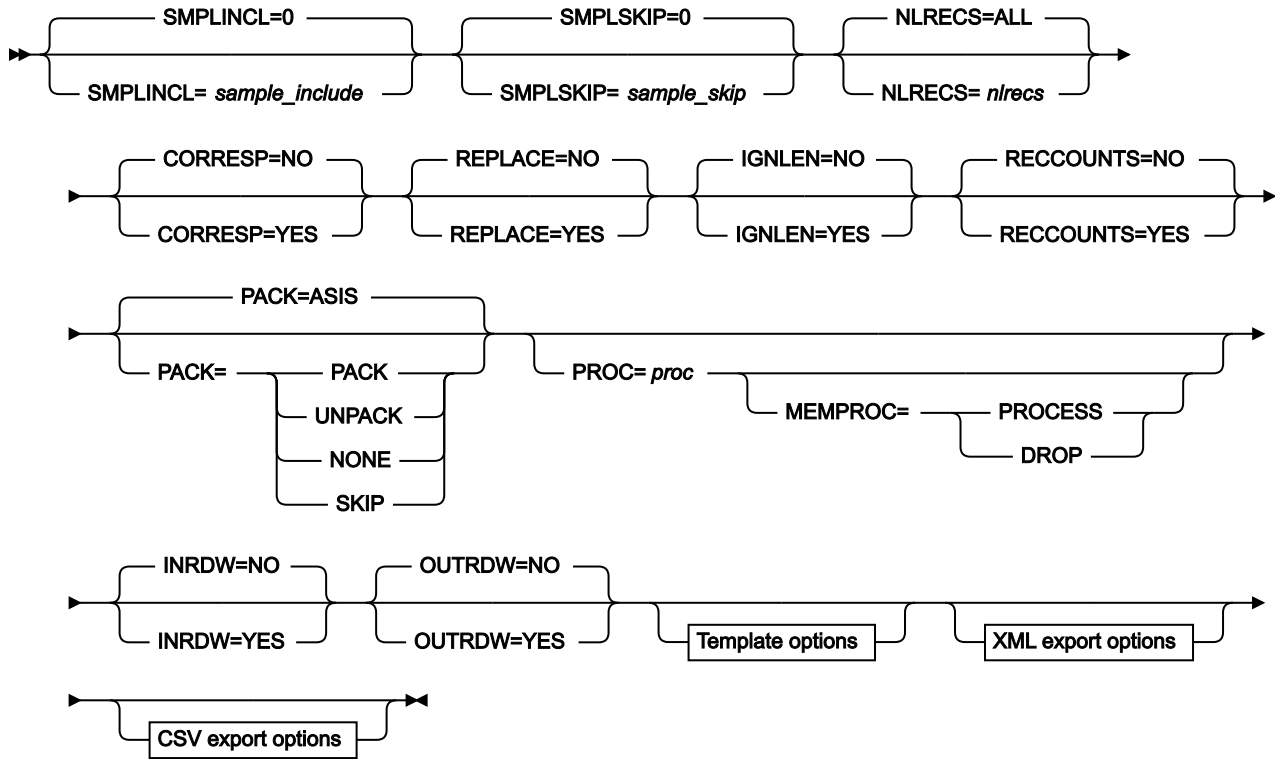

Template options

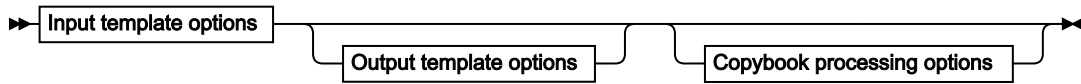

Input template options

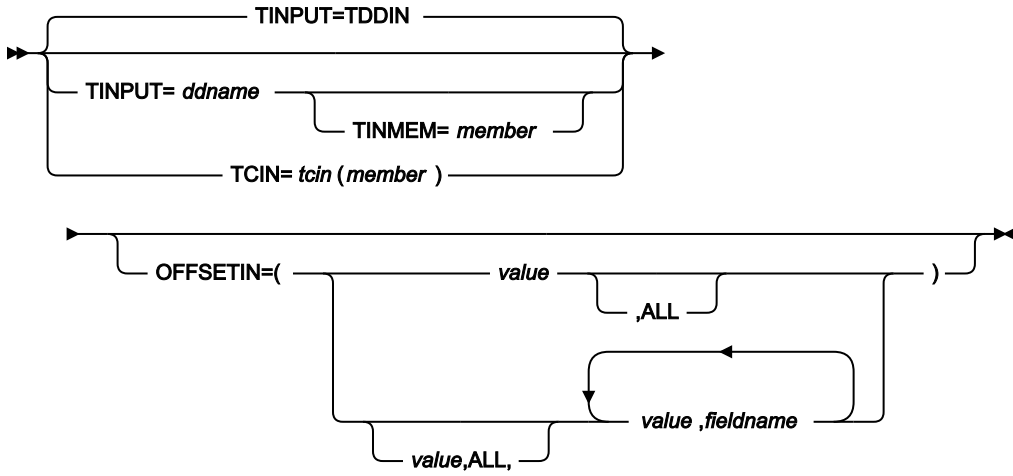

Output template options

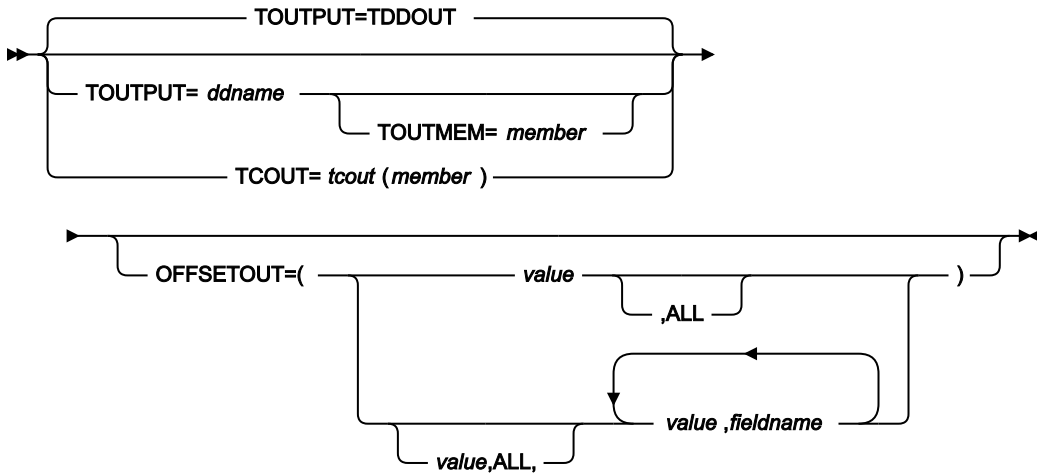

Copybook processing

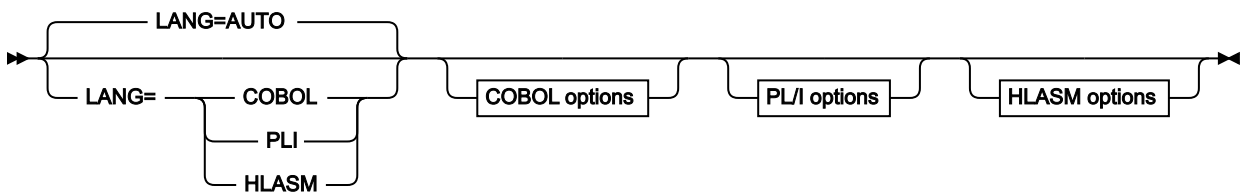

COBOL options

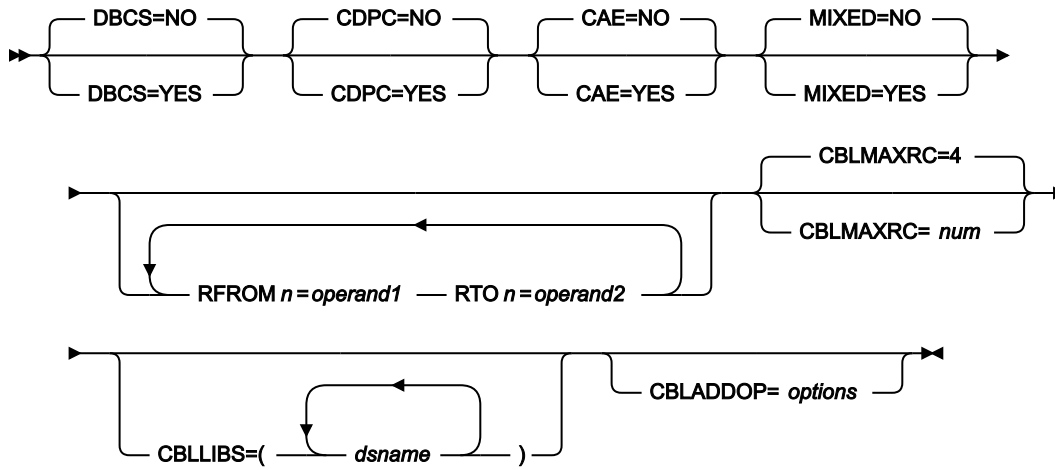

PL/I options

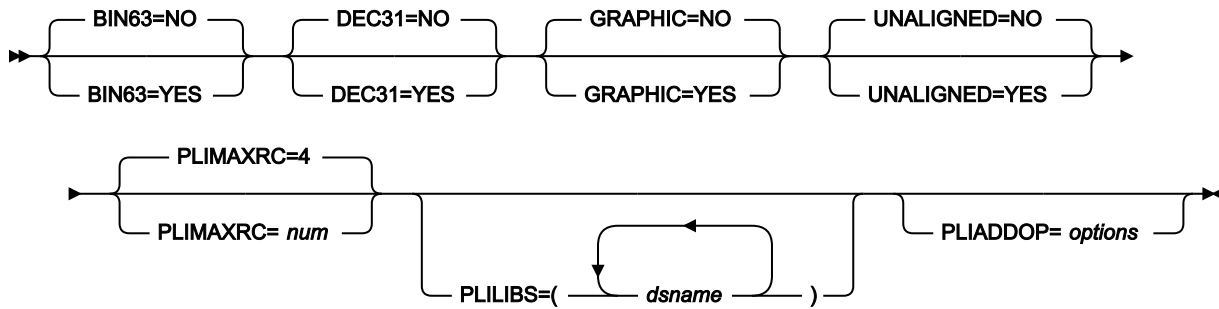

HLASM options

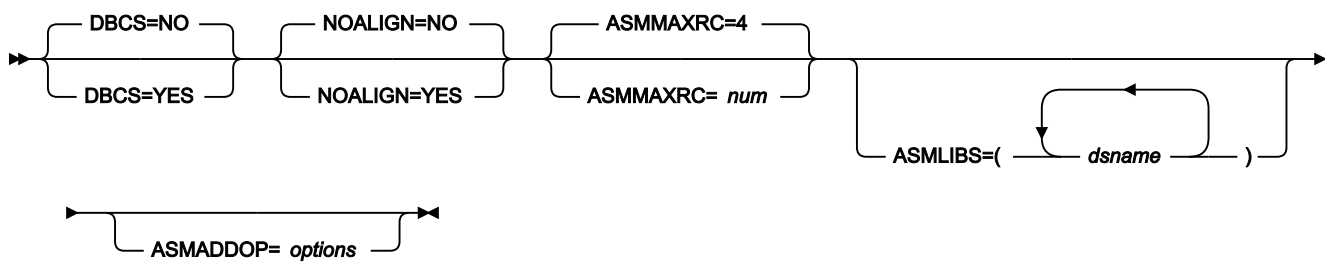

XML export options

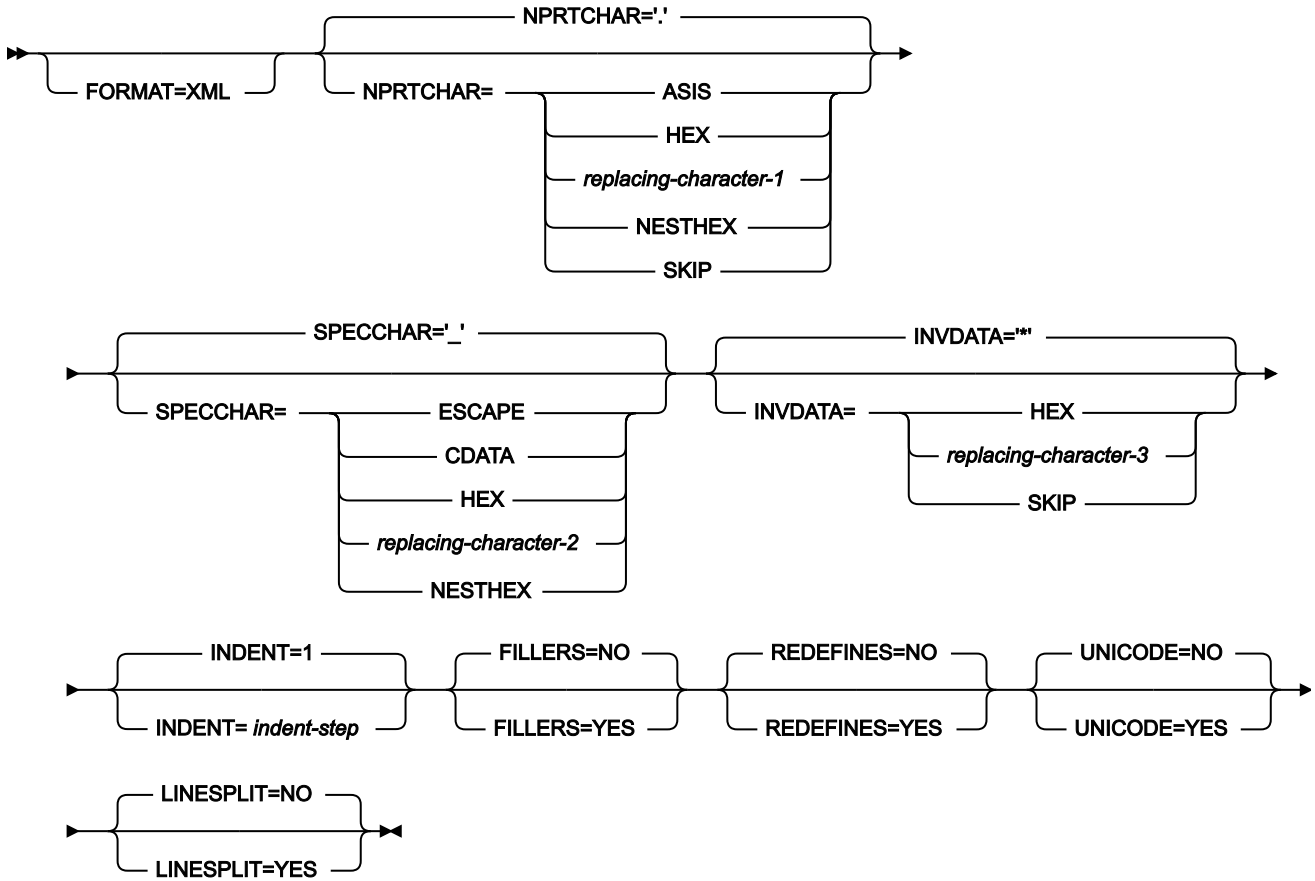

CSV export options

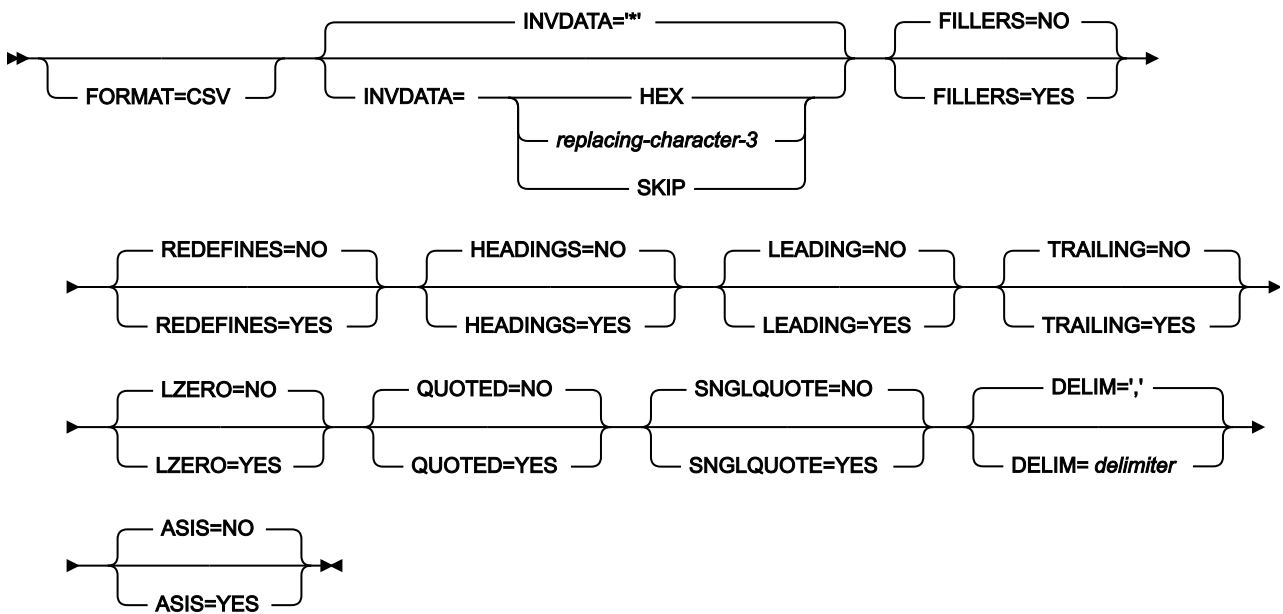

CSV import options

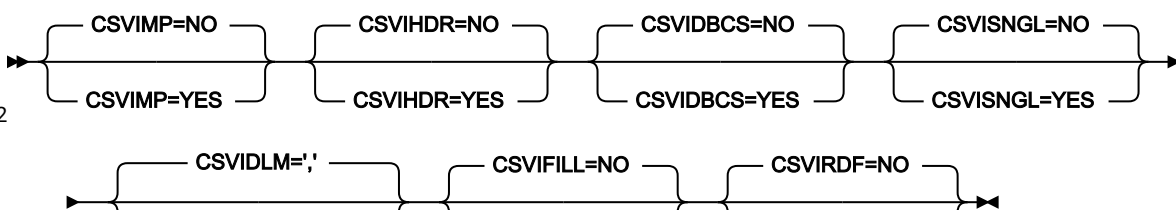

INPUT=ddname

Defines a reference to a DD or TSO ALLOC statement for the “From” data set or HFS file. The default is `DDIN`.

DSNIN=dsname

Defines the name of the “From” data set or an absolute path to the “From” HFS file (directory). If any DD statements are specified, they are not used. The name can include a member name in parenthesis. If the member is specified here, the associated Member parameter must be empty. An absolute path to an HFS file (directory) must be enclosed in apostrophes. If it does not fit on one line, you can split it over more than one line. You can further describe this data set, as follows:

VOLSERIN=volser

Volume serial number for a non-cataloged “From” data set.

MQ:manager.queueName

You can specify a MQ queue in place of a data set name, where:

manager

The MQ manager to be used. If you specify a generic name, File Manager displays a list of matching managers to select from.

queueName

The queue to be used. If you specify a generic name, File Manager displays a list of matching queues to select from.

Generic names are not supported for MQ when running in batch.

rt.applid:rname

You can specify a CICS® resource in place of a data set name, where:

rt

Resource type. Valid values are:

FI

For a CICS® file.

TD

For a Transient Data Queue.

TS

For a Temporary Storage Queue.

applid

The VTAM® applid of the CICS® system.

rname

The name of the resource.

MEMBER=member1

The name of a single member in a PDS, or a member name pattern representing one or more members in a PDS. If the input data set is a PDS(E), you may specify this parameter, or a member name in the DD statement for *ddname*, or specify a member or members in the CPYMBR parameter, or specify a range of member names via the MEMSTART and/or MEMEND keywords.

A member name pattern can consist of any characters that are valid in a member name and two special pattern characters: the asterisk (*) and the percent symbol (%).

*

represents any number of characters. As many asterisks as required can appear anywhere in a member name pattern. For example, if you enter a member name pattern of *d*, all members in the PDS whose name contains "d" are processed.

%

is a place holding character that means a single character. As many percent symbols as necessary can appear anywhere in a member name pattern. For example, if you enter a member name pattern of %%%%, all members in the PDS whose name is four characters in length are processed.

member1 is ignored if the data set is not a PDS.



Note: See [Usage notes on page 1302](#).

MEMSTART=startstring

Is used to specify the start of a range of member names to be included in the copy. If MEMSTART is specified but MEMEND is omitted, all members of the PDS(E) from the *startstring* value onwards are included. *startstring* can have the same values, including wild cards, as for the *member1* parameter of the MEMBER keyword.



Note: See [Usage notes on page 1302](#).

MEMEND=endstring

Is used to specify the end of a range of member names to be included in the copy. If MEMEND is specified but MEMSTART is omitted, all members of the PDS(E) up to the *endstring* value onwards are included. *endstring* can have the same values, including wild cards, as for the *member1* parameter of the MEMBER keyword.



Note: See [Usage notes on page 1302](#).

XMEMBERS

Provides a way to exclude from processing library members that would otherwise be selected using the MEMSTART, MEMEND, and MEMBER options.

xmem_filter

A member name filter identifying one or more members that are to be excluded from processing. A filter can be a member name pattern representing multiple members.

To specify a member name filter containing lowercase characters, use a character string in the format `c'string'`. Filter values can also be specified as hexadecimal strings in the format `x'hex-digits'`.

GEN=*generation*

Specifies the generation of the member to be copied. A value of 0 refers to the current member. A negative value refers to the relative generation number. A positive value refers the absolute generation number.

If the input data set is not a PDSE that supports member generations, the GEN keyword is ignored.

MGENS

Specifies if member generations are to be copied when copying the current member of a PDSE that supports member generations.

NO

Do not copy member generations.

YES

Also copy member generations.

LIMIT=*nnnnn*

Specify a limit for the number of generations that will be copied for any given member when MGENS=YES. The default is to copy all generations up to the MAXGENS limit on the output PDSE.

CREATED=*created*

The date on which a member was created, in YYYY/MM/DD format.

If the input data set is a PDS(E), you may specify this parameter, or specify a range of creation dates with the CRESTART and CREEND keywords.

You can specify an asterisk (*) as the last character to indicate a range of dates or a percent sign (%) in place of a single character to indicate a selection of dates.

created is ignored if the data set is not a PDS.

CRESTART=*crestart*

The start of a range of creation dates in YYYY/MM/DD format to be included in the copy.

If CRESTART is specified but CREEND is omitted, all members of the PDS(E) from the *crestart* value onwards are included.

If omitted, or you do not enter a full date, or you specify an asterisk (*) as the last character, the unspecified portion of *crestart* defaults to the right as follows:

DD

= 01

MM

= 01

YYYY

= 0000

No other wildcarding is allowed.

CREEND=*creend*

The end of a range of creation dates in YYYY/MM/DD format to be included in the copy.

If omitted, or you do not enter a full date, or you specify an asterisk (*) as the last character, the unspecified portion of *creend* defaults to the right as follows:

DD

= 31

MM

= 12

YYYY

= 9999

No other wildcarding is allowed.

CHANGED=*changed*

The date on which a member was last modified, in YYYY/MM/DD format.

If the input data set is a PDS(E), you may specify this parameter, or specify a range of modification dates with the CHGSTART and CHGEN keywords.

You can specify an asterisk (*) as the last character to indicate a range of dates or a percent sign (%) in place of a single character to indicate a selection of dates.

changed is ignored if the data set is not a PDS.

CHGSTART=*chgstart*

The start of a range of modification dates in YYYY/MM/DD format to be included in the copy.

If CHGSTART is specified but CHGEN is omitted, all members of the PDS(E) from the *chgstart* value onwards are included.

If omitted, or you do not enter a full date, or you specify an asterisk (*) as the last character, the unspecified portion of *chgstart* defaults to the right as follows:

DD

= 01

MM

= 01

YYYY

= 0000

No other wildcarding is allowed.

CHGEND=*chgend*

The end of a range of modification dates in YYYY/MM/DD format to be included in the copy.

If omitted, or you do not enter a full date, or you specify an asterisk (*) as the last character, the unspecified portion of *chgend* defaults to the right as follows:

DD

= 31

MM

= 12

YYYY

= 9999

No other wildcarding is allowed.

USERID=*userid*

The TSO user ID by which the member was last updated.

If the input data set is a PDS(E), you may specify this parameter, or specify a range of user IDs with the UIDSTART and UIDEND keywords.

You can enter a generic user ID by using asterisks and percent signs.

userid is ignored if the data set is not a PDS.

UIDSTART=*uidstart*

The start of a range of user IDs to be included in the copy.

If UIDSTART is specified but UIDEND is omitted, all members of the PDS(E) from the *uidstart* value onwards are included.

If omitted, or you do not enter a full 7-character user ID, or you specify an asterisk (*) as the last character, File Manager replaces the asterisk and pads the unspecified portion of *uidstart* to the right with low values (X'00').

UIDEND=*uidend*

The end of a range of user IDs to be included in the copy.

If you omit this field, it defaults to high values (X'FF').

If you specify less than 7 characters (without an asterisk as the last character), File Manager pads *uidstart* to the right with low values (X'00'). If you specify an asterisk (*) as the last character, File Manager replaces the asterisk and pads the unspecified portion of *uidend* with high values (X'FF').

CPYMBR

Provides a means of selecting input members from a PDS(E) where no generic name pattern and no member name range has been specified. Also provides a means for renaming the selected members as they are copied to the output data set. If the CPYMBR keyword is specified, only those members included in the CPYMBR arguments are copied to the output data set. Members selected by the MEMBER=*member1* that are not included in the CPYMBR arguments are not copied.

The CPYMBR arguments also refine the member list specified in the MEMBER=*member1* parameter. If the MEMBER keyword is *not* specified, it is assumed to be MEMBER=*, and all members named in the CPYMBR list are processed. However, if the MEMBER keyword is specified, for example as MEMBER=TEST*, the members included in the CPYMBR list are selected from the TEST* subset of members. Any members named in the CPYMBR arguments that do not match the mask given in the MEMBER parameter are not copied.

from_mem

The name of the member to be copied. Generic name masks are allowed.

to_mem

The name of the member after it has been copied to the output data set. If unspecified, the output member is not renamed.



Note: See [Usage notes on page 1302](#).

BINRECIN=*binrecin-len*

Specifies the record length used for processing the "From" HFS file. Valid range: 1 to 32760.

The file is processed in Binary mode (fixed-length records derived from the file, delimiters not distinguished). If you do not specify this parameter, the file is processed in Text mode (variable-length records, boundaries determined by delimiters).

USEIOXIN

Specifies whether to invoke a user I/O exit, to process the input data set.

NO

Default. Do not invoke a user I/O exit.

YES

Invoke a user I/O exit to process the input data set. This option is only available if the person who did the site customization for File Manager allowed user I/O exits on a site-wide basis.

IOXIN

Specifies the name of the user I/O exit used for the input data set. There are no restrictions on the programming language that you can use to write an exit. The exit must be provided to File Manager in the STEPLIB/ISPLLIB concatenation or their extensions (LINKLIST, LPA, and so on).

sysexit

Default. If you specify USEIOXIN=YES and do not supply a user I/O exit name, File Manager uses the name of the exit provided in the installation customization options. If USEIOXIN has been set to YES and no installation default has been provided, you must specify IOXIN=*ioxname*.



Note: If you have selected batch processing in an online panel, the generated JCL statements use the default name provided in your Set System Processing Options panel.

ioxname

The name of a PDS(E) member of a data set that has been provided to File Manager in the STEPLIB concatenation.

EXCLUSIVE

Note: This option is supported for backward compatibility only.

Use the new DIRINTEGR option.

Determines the disposition of the From (input) data set.

NO

Default. The data set is allocated with DISP=SHR, so that other users can obtain concurrent access to a PDS or PDSE during execution of DSC.

YES

The data set is allocated with DISP=OLD, preventing concurrent access to the PDS or PDSE.



Note: If you pre-allocate the input data set with DISP=SHR and then specify EXCLUSIVE=YES in batch, I/O errors might occur during concurrent access to the data.

DIRINTEGR

Specifies whether to invoke a user I/O exit to process the input data set.

NO

Default. File Manager uses a faster PDS(E) directory processing method. This may cause I/O errors when multiple users are concurrently updating the directory of the data set being processed.

YES

File Manager uses safer, but slower, PDS(E) directory processing method. This method allows for safe concurrent updates of the PDS(E) directory by multiple users.

INCLUDEMD

This parameter determines what happens to the descriptor for an Websphere MQ message.

YES

The descriptor is added as a prefix as the data is copied.

NO

Just the message data is copied. This is the default.

This parameter applies only when the input describes an MQ queue.

JCL=NO

Treat the data set as a non-JCL data set.

JCL=YES

Indicates the file or PDS(E) members being copied contain JCL, the syntax of which is to be maintained during the copy process.

This option is only available when the **PROC** option is selected as changes can only be made to the input data by means of REXX processing.

This option is ignored if a template is being used.

Use of this option may affect the performance of the copy due to the overhead of verifying the syntax of the JCL.

OUTPUT=ddname

Defines a reference to a DD or TSO ALLOC statement for the "To" data set or HFS file. The default is `DDOUT`.

DSNOUT=dsname

Defines the name of the "To" data set or an absolute path to the "To" HFS file (directory). If any DD statements are specified, they are not used. The name may include a member name in parenthesis. If the member is specified here, the associated Member parameter must be empty. You can further describe this data set, as follows:

(*member2*)

Where `DSNOUT=dsname` specifies a PDS and you want to send the output to a specific member within this data set, this defines the output member name. An absolute path to an HFS file

(directory) must be enclosed in apostrophes. If it does not fit on one line, you can split it over more than one line.

VOLSEROUT=*volser*

Volume serial number for a new or non-cataloged “To” data set.

DATACLAS=*value*

The name of a data class defined in your SMS installation. Do not enter a value on a system without SMS.

STORCLAS=*value*

The name of a storage class defined in your SMS installation. Do not enter a value on a system without SMS.

MGMTCLAS=*value*

The name of a management class defined in your SMS installation. Do not enter a value on a system without SMS.

BINRECOUT=*binrecout-len*

Specifies the record length used for processing the “To” HFS file. Valid range: 1 to 32760.

The file is processed in Binary mode (fixed-length records derived from the file, delimiters not distinguished). If you do not specify this parameter, the file is processed in Text mode (variable-length records, boundaries determined by delimiters).



Note: See [Usage notes on page 1302](#).

USEIOXOUT

Specifies whether to invoke a user I/O exit, to process the output data set.

NO

Default. Do not invoke a user I/O exit.

YES

Invoke a user I/O exit to process the output data set. This option is only available if the person who did the site customization for File Manager allowed user I/O exits on a site-wide basis.

MEMOUT=*mask*

Where a number of input members have been specified, you can specify a member name pattern for the output members, allowing you to rename your members as they are copied. The member name pattern can consist of any characters that are valid in a member name and two special pattern characters: the asterisk (*) and percent sign (%).

Asterisk (*)

The asterisk is a place-holding character that means multiple characters with no change. Only one asterisk should appear in the mask. Any subsequent asterisk characters are treated as percent signs. For example, if you enter:

```
ABC*
```

The renamed members all begin with ABC followed by the remainder of the old member name.

Percent sign (%)

The percent sign is a place-holding character that means a single character with no change. As many percent symbols as necessary may appear anywhere in a member name. For example, if you enter:

```
%%%A*
```

The 1st 3 characters of the renamed members remain unchanged, the 4th character is replaced with the letter "A" and the remainder of the old member name remains unchanged.

MQOPEN

This parameter determines if the Websphere MQ queue is opened in browse or share mode and the messages from that queue read in a destructive manner.

BROWSE

The Websphere MQ queue is opened in browse mode. Messages are not removed from the queue as they are read. This is the default.

SHARE

The WebSphere MQ queue is opened in share mode. Messages are removed from the queue as they are read (the queue is read in a destructive manner).

This applies only when the input describes an MQ queue.

IOXOUT

Specifies the name of the user I/O exit used for the output data set. There are no restrictions on the programming language that you can use to write an exit. The exit must be provided to File Manager in the STEPLIB/ISPLLIB concatenation or their extensions (LINKLIST, LPA, and so on).

sysexit

Default. If you specify USEIOXOUT=YES and do not supply a user I/O exit name, File Manager uses the name of the exit provided in the installation customization options. If USEIOXOUT has been set to YES and no installation default has been provided, you must specify IOXOUT=*ioxname*.



Note: If you have selected batch processing in an online panel, the generated JCL statements use the default name provided in your Set System Processing Options panel.

ioxname

The name of a PDS(E) member of a data set that has been provided to File Manager in the STEPLIB concatenation.

STATS=ON

Default. This updates the ISPF statistics (if already present) when a PDS or PDSE member has been changed.

STATS=OFF

The ISPF statistics are not updated when a PDS or PDSE member has been changed.

STATS=FORCE

The ISPF statistics that exist for members being processed are always updated and statistics for a member that previously did not have statistics are created.

DISP

Determines the disposition of the To (output) data set. Specify OLD or MOD.

OLD

Writes input records to the existing output data set, starting from the beginning.

MOD

Default. Appends the input records to the end of the existing output data set.



Note: MOD is not available for PDS(E) member processing.



Note: SMS might modify the allocation of new data sets on your system. For details, contact your SMS Administrator.

POSITION=*skip*

Number of logical records to be skipped from the beginning of the data set. The default is 0.

SMPLINCL=*sample_include*

Number of physical records to be included in a repeating sample from a data set. Both SMPLINCL and SMPLSKIP keywords must have non-zero values for sampling to take effect. Range: 0–9999999.

SMPLSKIP=*sample_skip*

Number of physical records to be skipped in a repeating sample from a data set. Both SMPLINCL and SMPLSKIP keywords must have non-zero values for sampling to take effect. Range: 0–9999999.

KEY=*key* (VSAM only)

A key for KSDS records, or a slot number for RRDS records. The maximum key length is 30 characters. The first record with a key or slot value greater than or equal to *key* is the first record copied. If you omit the *key* and *skip* values, copying begins with the first record in the data set.

If the key contains lowercase characters, blanks, or commas, enclose it in quotation marks. You can also specify a key in hexadecimal format (for example, X'C1C2C3').

NLRECS

Number of records to be copied or ALL.

ALL

If you specify ALL or omit the parameter, all the remaining records are copied.

nlrecs

The maximum number is 999 999 999.

When you are coding a REXX procedure and NLRECS is specified, then this can affect the number of records presented to the REXX procedure. NLRECS only applies to the number of records written to the primary output data set. It does not apply to records written in the REXX procedure with the WRITE() function.

CORRESP

Specifies whether or not File Manager maps output fields to input fields with the corresponding name. The default is NO.

NO

Instructs File Manager to use the existing field mapping in the TCOU member. If the TCOU member is a copybook, or no field mapping is supplied, then File Manager ignores this option and performs a corresponding copy (as if you had specified CORRESP=YES).

YES

Instructs File Manager to map output fields to input fields with the corresponding name.

If you want to use existing mapping in the "To" template, specify CORRESP=NO.

REPLACE

Specifies whether or not File Manager replaces like-named members in an output partitioned data set. The default is NO.

NO

Like-named members in the output partitioned data set are not replaced.

YES

Like-named members in the output partitioned data set are replaced.

IGNLEN

Specifies whether or not File Manager ignores length mismatches when selecting records for processing.

NO

Do not ignore length mismatches. Records that are shorter than the matching structure length in the template are not selected for processing.

YES

Use this option to ignore length mismatches.

When a field in the "From" template spans or is beyond the copied record's boundary, the corresponding field on the output record is initialized (since there is no data available from the from field). The exception is alphanumeric fields, where the portion of the field that exists on the input record is copied (a partial copy) and the remainder of the output field is padded with blanks.

RECCOUNTS

Controls whether or not the count of records for copied PDS(E) members and sequential/VSAM data sets is printed in the processing listing in batch.

NO

Record counts are not reported.

YES

Record counts are reported.



Note: This option affects PDS(E) processing ONLY. For sequential/VSAM data sets, the record counts are always provided. When the option is selected, it prevents the use of IEBCOPY for PDS(E) processing, which may affect the copy performance.

PACK

Determines if File Manager should detect if the input data is in ISPF packed format and specifies if the output data is to be written in ISPF packed format. This keyword is ignored when processing VSAM data sets. When an I/O exit has been specified for either the input or output data set (or both), the only valid option is PACK=NONE.

ASIS

Instructs File Manager to write the output in ISPF Packed format only if the input is in ISPF packed format.

PACK

Instructs File Manager to write the output in ISPF packed format regardless of the input format.

UNPACK

Instructs File Manager to write the output without ISPF packing, regardless of the input format.

NONE

Instructs File Manager not to determine if the input data set is in ISPF packed format and writes the output records as they are read from the input data set (after any enhanced processing).

SKIP

Instructs File Manager to determine if the input data set is in ISPF packed format and if so, to skip the copy processing.

PROC=*proc*

Member name of a REXX procedure that you want to use to process each record before it is copied, or an asterisk (*) to indicate the procedure is inline. If you specify a member name, you must define an FMNEXEC ddname that identifies the PDS containing the member. If you specify *, the procedure is read from SYSIN immediately following the control statement for the current function. The inline procedure is terminated by a record containing a slash and a plus sign (/+) in columns 1–2.

For more information about using DFSORT or REXX procedures to process records before they are copied, see [Enhancing File Manager processing on page 517](#).

If PROC=*proc* is specified, you can then choose to include a MEMPROC parameter:

MEMPROC

Specifies that REXX member selection is in effect. Records are read from the input member and then cached in memory until a decision is made, within the REXX procedure, on whether the member is to be copied or dropped. Once the decision has been made, the entire member is either copied or dropped, depending upon the RETURN string specified in the REXX procedure.

If the entire member is processed without encountering a RETURN DROP MEMBER or RETURN PROCESS MEMBER string, the member is processed according to the action specified by the parameter specified for MEMPROC. These are:

PROCESS

The member is to be included in the copy. The member is copied intact, subject to any specified template processing, which is performed before the user REXX proc is invoked.

This is the default action, if no parameter is specified with the MEMPROC keyword.

DROP

The member is to be excluded from the copy. Processing continues with the next member.

INRDW

Controls whether or not to adjust the input start location when the specified start location takes into account the record descriptor word (RDW).

NO

Does not adjust the input start location.

YES

Subtracts 4 from all start locations that have been coded on external functions that refer to the input record.

OUTRDW

Controls whether or not to adjust the output start location when the specified start location takes into account the record descriptor word (RDW).

NO

Does not adjust the output start location.

YES

Subtracts 4 from all start locations that have been coded on external functions that refer to the output record.

Template options

The template options define which templates (if any) are used to describe the record structure in the “From” and “To” data sets, and how File Manager processes those templates.

TINPUT=ddname

Defines a reference to a DD or TSO ALLOC statement for the data sets which contain the copybook or template that describes the record structure of your input data. The default is TDDIN.

If you specify a concatenated DD, then you must provide the member name, *member*.



Note: When you specify concatenated data sets in the template DD statement, and these data sets are vendor-managed copybook libraries, a maximum of 20 data sets are supported.

TINMEM=member

The name of the copybook or template member in the data sets identified by the TINPUT parameter if it has not been specified on the DD statement. This parameter must not be specified if the TCIN parameter is specified.

TCIN=tcin(member)

PDS and member name of the copybook or template that describes the record structure of your input data.

OFFSETIN

The length of the 01 field in the “From” template and the start locations of the fields within that 01 field are adjusted by the value provided.

value

The offset value, which must be in the range -32760 to 32760, to be applied to the corresponding field identifier. If no field identifier is supplied and ALL is not used, the value is applied to the first Level 01 field in the "From" template.

ALL

Where the template contains multiple record structures, this keyword applies the corresponding *value* to all Level 01 within the "From" template.



Note: You can specify a value for ALL and then override this value for individual layouts by providing subsequent *value* and *fieldname* combinations.

fieldname

The name of the Level 01 field to which *value* is to be applied. The default is the first Level 01 field in the "From" template.

TOUTPUT=ddname

Defines a reference to a DD or TSO ALLOC statement for the data sets which contain the copybook or template that describes the record structure of your output data. The default is TDDOUT.

If you specify a concatenated DD, then you must provide the member name, *member*.

TOUTMEM=member

The name of the copybook or template member in the data sets identified by the TOUTPUT parameter if it has not been specified on the DD statement. This parameter must not be specified if the TCOU parameter is specified.

TCOUT=tcout(member)

PDS and member name of the copybook or template that describes the record structure of your output data.

OFFSETOUT

The length of the 01 field in the "To" template and the start locations of the fields within that 01 field are adjusted by the value provided.

value

The offset value, which must be in the range -32760 to 32760, to be applied to the corresponding field identifier. If no field identifier is supplied and ALL is not used, the value is applied to the first Level 01 field in the "To" template.

ALL

Where the template contains multiple record structures, this keyword applies the corresponding *value* to all Level 01 fields within the “To” template.



Note: You can specify a value for ALL and then override this value for individual layouts by providing subsequent *value* and *fieldname* combinations.

fieldname

The name of the Level 01 field to which *value* is applied. The default is the first Level 01 field in the “To” template.

Copybook processing

If you specify a copybook (instead of an existing template), File Manager uses these processing options to compile the copybook into a template:

LANG

Determines whether File Manager automatically detects the copybook language or interprets the language as COBOL, PL/I, or HLASM.



Note: The COMPLANG setting in FMN0POPT is the equivalent of the LANG parameter in batch functions.

- If COMPLANG is set it determines the installation default language for online and batch compilation.
- If COMPLANG is not specified then COBOL is the installation default for online compilation and AUTO is the default for batch compilation.
- If a value of COBOL, HLASM, PL/1, or AUTO is specified (in the **Compiler Language Selection** panel or through the LANG parameter in a batch job) it overrides the default language.

AUTO

Automatically detect whether the copybook language is COBOL or PL/I, and invoke the appropriate compiler. If the compilation results in a return code greater than 4, then invoke the compiler for the other language. If the second compilation also results in a return code greater than 4, then retry the first compiler and report the compilation errors. If File Manager successfully creates a template (despite the compilation errors), then continue processing with the template.

COBOL

Invoke the COBOL compiler to create a template from the copybook. (Do not invoke the PL/I compiler, even if the COBOL compilation results in errors.)

PLI

Invoke the PL/I compiler to create a template from the copybook. (Do not invoke the COBOL compiler, even if the PL/I compilation results in errors.)

HLASM

Invoke the HLASM compiler to create a template from the copybook.

DSINFO

Specifies whether additional data set information for input and output sources should be produced in batch reports for the DSP, DSM, DSC, and FCH commands.

NO

No additional data set information is generated.

YES

Generates data set information including DSORG, RECFM, LRECL, BLKSIZE, and VSAM attributes including average record length, maximum record length, key offset, key length and reuse, for input and output data sets when applicable.

COBOL options

The following options are used to compile a COBOL copybook into a template:

DBCS=YES

Use the DBCS compiler option.

DBCS=NO

Use the NODBCS compiler option.

For details on the effect of the DBCS and NODBCS compiler options, see the *IBM COBOL Programming Guide for OS/390 & VM*.

CDPC=NO

Do not use the COBOL SPECIAL-NAMES paragraph "Decimal-point is comma".

CDPC = YES

Use the COBOL SPECIAL-NAMES paragraph "Decimal-point is comma".

CAE=NO

Do not use the COBOL compile option ARITH(EXTEND).

CAE = YES

Use the COBOL compile option ARITH(EXTEND).

MIXED = NO

Field names stored in the template in uppercase.

MIXED = YES

Field names stored in the template in the original case as coded in the COBOL copybook.

RFROM1 RT01 ... RFROM5 RT05

Up to five pairs of “From” and “To” pseudo-text character strings for the COBOL REPLACE compiler-directing statement.

If your COBOL copybooks contain characters that you want to remove or replace with other characters before compiling the copybooks into templates, then use these replacing options.

For example, if your copybooks contain colon characters (:) that you want to remove before compiling, then specify '==:==' as *operand1* and '=====' as *operand2*.

For details on specifying “From” and “To” strings for COBOL REPLACE, see the *IBM COBOL Language Reference*.

CBLMAXRC

Sets the maximum acceptable return code for a copybook compile. A return code higher than the specified level causes the function to stop. Default is 4.



Note: The COMPMAXRC parameter is still supported but it is recommended that the CBLMAXRC parameter is used instead. If you do specify the COMPMAXRC parameter, it takes precedence over the language MAXRC.

CBLLIBS

Allows you to specify a list of up to ten data set names to be specified in the SYSLIB concatenation list. These data sets are searched in the order specified for COPY and INCLUDE members for the compilation.

dsname

The name of the data set name to be processed. Generic name masks are not allowed.

CBLADDOP

Additional COBOL compiler options which are included in a CBL statement when compiling COBOL copybooks.

PL/I options

The following options are used to compile a PL/I copybook into a template:

BIN63=YES

Use the LIMITS(FIXEDBIN(63)) compiler option.

BIN63=NO

Use the LIMITS(FIXEDBIN(31)) compiler option.

DEC31=YES

Use the LIMITS(FIXEDDEC(31)) compiler option.

DEC31=NO

Use the LIMITS(FIXEDDEC(15)) compiler option.

GRAPHIC=YES

Use the GRAPHIC compiler option.

GRAPHIC=NO

Use the NOGRAPHIC compiler option.

UNALIGNED=YES

Use the DEFAULT RANGE (*) UNALIGNED, language statement to change the default alignment.

UNALIGNED=NO

Use the PL/I default.

PLIMAXRC

Sets the maximum acceptable return code for a copybook compile. A return code higher than the specified level causes the function to stop. Default is 4.



Note: The COMPMAXRC parameter is still supported but it is recommended that the PLIMAXRC parameter is used instead. If you do specify the COMPMAXRC parameter, it takes precedence over the language MAXRC.

PLILIBS

Allows you to specify a list of up to ten data set names to be specified in the SYSLIB concatenation list. These data sets are searched in the order specified for COPY and INCLUDE members for the compilation.

dsname

The name of the data set name to be processed. Generic name masks are not allowed.

PLIADDOP

Additional PL/I compiler options which are included in a *PROCESS statement when compiling PL/I copybooks.

For details on the effect of these compiler options, see the *IBM VisualAge PL/I for OS/390 Programming Guide*.

HLASM options

The following options are used to compile a HLASM copybook into a template:

DBCS=YES

Use the DBCS compiler option.

DBCS=NO

Use the NODBCS compiler option

NOALIGN=YES

Use the NOALIGN compiler option.

NOALIGN=NO

Use the ALIGN compiler option.

ASMMAXRC

Sets the maximum acceptable return code for a copybook compile. A return code higher than the specified level causes the function to stop. Default is 4.



Note: The COMPMAXRC parameter is still supported but it is recommended that the ASMMAXRC parameter is used instead. If you do specify the COMPMAXRC parameter, it takes precedence over the language MAXRC.

ASMLIBS

Allows you to specify a list of up to ten data set names to be specified in the SYSLIB concatenation list. These data sets are searched in the order specified for COPY and INCLUDE members for the compilation.

dsname

The name of the data set name to be processed. Generic name masks are not allowed.

ASMADDOP

Additional HLASM compiler options which are included in a *PROCESS statement when compiling COPY and MACRO members.

For details on the effect of these compiler options, see the *HLASM V1R6 Programmer's Guide*.

XML Export options

When generating the output in an external format such as XML or CSV, File Manager uses the following options:

FORMAT

Specifies the external format to be used for output.

XML

Indicates that XML format is used.

CSV

Indicates that CSV format is used.

NPRTCHAR

Determines how non-printable characters are to be represented in the output.

'.' (dot)

Default. Each non-printable character is replaced with ".".

ASIS

Non-printable characters appear unchanged in the output.

HEX

Any non-printable character is converted into its hexadecimal representation.

'replacing-character-1'

Each non-printable character is replaced with the replacing-character-1. The set of allowable characters is limited to printable characters with exception of special characters. You may specify:

char

A character, such as "?".

C'char'

A character used without case translation.

X'cc'

A character defined by its hexadecimal value.

NESTHEX

Each string of consecutive non-printable characters will be nested into content of element as *X'hex-representation-of-string-of-non-printable-characters'*

SKIP

Any non-printable character causes the value to be skipped (data is represented by start and end tags, without any content).

SPECCHAR

Determines how special characters are to be represented in the XML output.

'_' (underscore)

Default. Each special character is replaced with "_".

ESCAPE

Special characters are converted into escaped strings:

">" for ">"
 "<" for "<"
 "'" for "'"
 """ for ""
 "&" for "&"

CDATA

Unchanged string containing special characters are enclosed into the CDATA section.

HEX

Any special character will cause the XML value to be converted into its hexadecimal representation.

'replacing-character-2'

Each special character is replaced with the replacing-character-2. The set of allowable characters is limited to printable characters with exception of special characters. You may use:

char

A character, such as "?".

C'char'

A character used without case translation.

X'cc'

A character defined by its hexadecimal value.

NESTHEX

Each string of consecutive special characters is nested into content of element as *X'hex-representation-of-string-of-special-characters'*

INVDATA

Determines how invalid data is to be represented in the output.

'*' (asterisk)

Default. Invalid data is represented by string of "*" with a length equal to the assumed length of the output value.

HEX

Invalid data causes the output value to be a hexadecimal representation of the input value.

'replacing-character-3'

Invalid data is represented by a string of *replacing-character-3* with a length equal to the assumed length of the output value. The set of allowable characters is limited to printable characters with exception of special characters. You can use:

char

A character, such as "?".

C'char'

A character used without case translation.

X'cc'

A character defined by its hexadecimal value.

SKIP

Invalid data is skipped (data is represented by start and end tags, without any content).

INDENT

Specifies the number of blanks used to indent each level of XML tag corresponding to the nested level in the template or copybook.

1

Default. Each nested level causes an increase in indentation of each XML level by one blank.

indent-step

Any value from 0 to 9. INDENT=0 will force no indentation. Each positive number will cause an increase in indentation of each XML level by this number of blanks.

FILLERS

Indicates whether fillers (unnamed data elements) are to be included into the output or not.

NO

Default. Fillers are ignored (not represented in the output).

YES

Fillers are treated as named data elements and represented in the output.

REDEFINES

Indicates whether data elements redefining other data elements are to be included into the output or not.

NO

Default. Redefines are ignored (not represented in the output).

YES

Redefines are treated as other data elements and represented in the output.

UNICODE

Indicates whether the output is to be converted to Unicode or not.

NO

Default. The output is not converted.

YES

The output is converted to Unicode.

LINESPLIT

Indicates, whether the output lines resulting from processing an input record are spanned contiguously over multiple output records, or each output line must be included as the only line in an output record.

NO

Default. Output line is contained, as the only output line, in one output record.

YES

Output records are cut independently of external formatting. An output line can span multiple output records and not necessarily start from the beginning of the record. However, output representation of each input record starts from the new output record.

CSV Export Options**FORMAT**

Specifies the external format to be used for output.

CSV

Indicates that CSV format is used.

XML

Indicates that XML format is used.

INVDATA

Determines how invalid data is to be represented in the output.

'*' (asterisk)

Default. Invalid data is represented by string of "*" with a length equal to the assumed length of the output value.

HEX

Invalid data causes the output value to be a hexadecimal representation of the input value.

'replacing-character-3'

Invalid data is represented by a string of *replacing-character-3* with a length equal to the assumed length of the output value. The set of allowable characters is limited to printable characters with exception of special characters. You can use:

char

A character, such as "?".

C'char'

A character used without case translation.

X'cc'

A character defined by its hexadecimal value.

SKIP

Invalid data is skipped (data is represented by start and end tags, without any content).

FILLERS

Indicates whether fillers (unnamed data elements) are to be included into the output or not.

NO

Default. Fillers are ignored (not represented in the output).

YES

Fillers are treated as named data elements and represented in the output.

REDEFINES

Indicates whether data elements redefining other data elements are to be included into the output or not.

NO

Default. Redefines are ignored (not represented in the output).

YES

Redefines are treated as other data elements and represented in the output.

HEADINGS

Indicates whether to include field names as headings in the first line of CSV output.

NO

Default. Field headings are not included in the output.

YES

Field headings are included in the output.



Note: Field headings will be produced when a layout changes or the headings required for subsequent value fields change.

LEADING

Indicates whether to preserve leading blanks in field values.

NO

Default. Leading blanks are ignored (not represented in the output).

YES

Leading blanks are included in the output.

TRAILING

Indicates whether to preserve trailing blanks in field values.

NO

Default. Trailing blanks are ignored (not represented in the output).

YES

Trailing blanks are included in the output.

LZERO

Indicates whether leading zeros in numeric fields are to be included in the CSV output.

NO

Default. Leading zeros are removed unless the field definitions in the associated template specify leading zeros as YES.

YES

Format numeric fields with leading zeros.

QUOTED

Indicates whether all CSV values are to be encapsulated in quotes.

NO

Default. Automatic encapsulation occurs when the field value contains:

- A delimiter.
- A quote for the first character.

YES

All CSV values are encapsulated in quotes.

SNGLQUOTE

Indicates whether to use single quotation marks or double quotation marks to wrap output field values.

NO

Default. Use double quotation marks for quoted values.

YES

Use single quotation marks for quoted values.

DELIM=*delimiter*

Specifies an alternate character to delimit fields in the output file. The default character is a comma. The character will be uppercased unless it is specified in one of the following formats:

C'char'

A character used without case translation.

X'cc'

A character defined by its hexadecimal value.

ASIS

Indicates whether to suppress automatic encapsulation.

NO

Default. No suppression of automatic encapsulation.

YES

Suppress automatic encapsulation. Automatic encapsulation occurs when QUOTE=YES is not specified and the field value contains:

- A delimiter.
- A quote for the first character.

CSV Import Options

CSVIMP

Default NO. Specify CSVIMP=YES when importing CSV data with a template.

CSVIHDR

Default NO. Specify YES if the CSV data set to be imported includes headings.

CSVIDBCS

Default NO. Specify YES if the CSV data set to be imported includes double-byte data (DBCS) characters wrapped in shift-in (x'0E') and shift-out (x'0F') characters.

CSVISNGL

Default NO. Specify YES option if the CSV data set to be imported has single quote encapsulation.

CSVIDL=delimiter

Default is the comma "," character. Use this keyword to specify an alternate delimiter value to the comma "," character.

CSVIFILL

Default No. Specify YES if the CSV data set to be imported includes filler fields.

CSVIRDF

Default No. Specify YES if the CSV data set to be imported includes redefines fields.



Note: You cannot specify different options for compiling "From" and "To" copybooks; the same copybook options are used for both.

```
//DSC JOB (acct),'name'
/* Copy data set to data set
/*
//FMBAT    PROC
//FMBAT    EXEC PGM=FILEMGR
//STEPLIB DD DSN=FMN.SFMNMOD1,DISP=SHR
//SYSPRINT DD SYSOUT=*
//SYSABEND DD SYSOUT=*
//SYSUDUMP DD SYSOUT=*
//        PEND
/*
//STPSSEX    EXEC FMBAT
//SYS1INP  DD DISP=SHR,
//          DSN=SYS1.PARMLIB(LNKLIST00)
//SYSIN    DD *
$$$FILEM VER
$$$FILEM DSC INPUT=SYS1INP,
$$$FILEM   DSNOUT=FMNUSER.TEMP.LINKLIST,
$$$FILEM   TCIN=FMNUSER.FMN.TEMPLATE(ODOTW001)
$$$FILEM E0J
/*
```

This example copies all members of the input PDS ('USERID.PLXIN') that match the input mask 'XYZE*' to the output PDS('USERID.PLXOUT'), renaming them using the rename mask JBG*. The members XYZEDIT, XYZEDIT1, XYZEDIT2, XYZEDIT3, XYZEDIT4, XYZEDIT5 and XYZEDIT6 are copied and renamed as JBGEDIT, JBGEDIT1, JBGEDIT2, JBGEDIT3, JBGEDIT4, JBGEDIT5 and JBGEDIT6 respectively.

```
//SYSIN DD *
$$$FILEM DSC DSNIN=USERID.PLXIN,
$$$FILEM MEMBER=XYZEDIT*,
$$$FILEM DISP=MOD,
$$$FILEM DSNOUT=USERID.PLXOUT,
$$$FILEM MEMOUT=JBG*
```

This example copies a PDS using a TSO environment. This is required for load module processing when File Manager is not APF-authorized and recommended for better performance with a PDS or PDSE.

```
//FMBAT EXEC PGM=IKJEFT01,DYNAMNBR=100
//STEPLIB DD DSN=FMN.SFMNMOD1,DISP=SHR
//SYSTSPRT DD SYSOUT=*
//SYSTSIN DD *
CALL *(FMNMAIN)
//SYSPRINT DD SYSOUT=*
//SYSIN DD *
$$FILEM DSC DSNIN=TEST.PDS,
$$FILEM MEMBER=*,
$$FILEM REPLACE=YES,
$$FILEM DISP=OLD,
$$FILEM DSNOUT=TEST2.PDS
```

DSE (Data Set Edit)

Purpose

The DSE function displays the Data Set Edit or Edit Entry panel, in online mode. This function can be invoked from a REXX program or a TSO clist or entered on an ISPF Command line, but **cannot** be used in batch jobs as it is an interactive function.

Usage notes

When invoked from an ISPF Command line without a parameter, the Data Set Edit Entry panel is displayed in interactive mode and you can specify a valid data set for browsing. If you include a valid data set name as a parameter, then you bypass the Entry panel, and go directly to editing the specified data set.

When invoked from a REXX procedure or TSO list, you must supply the data set name.

Related functions

DSB

Display Data Set Browse or Browse Entry panel

DSEB

Update disk data set records

DSU

Update disk data set records

DSV

Display the Data Set View or View Entry panel

Figure 426. Syntax

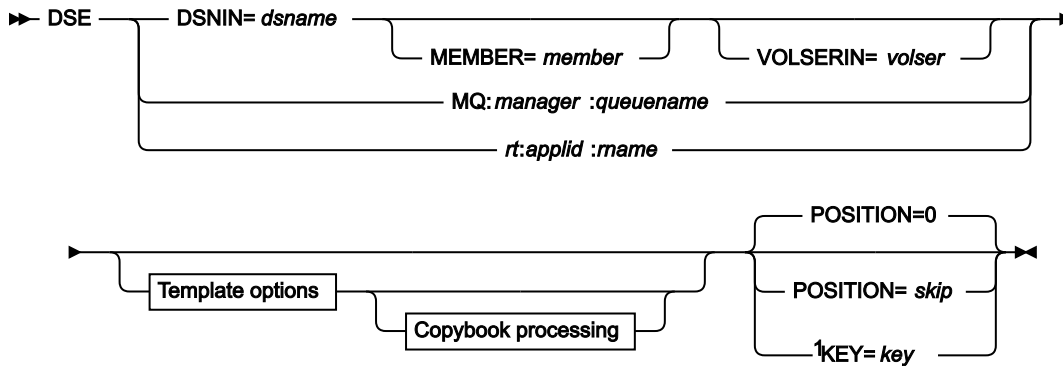

Template options

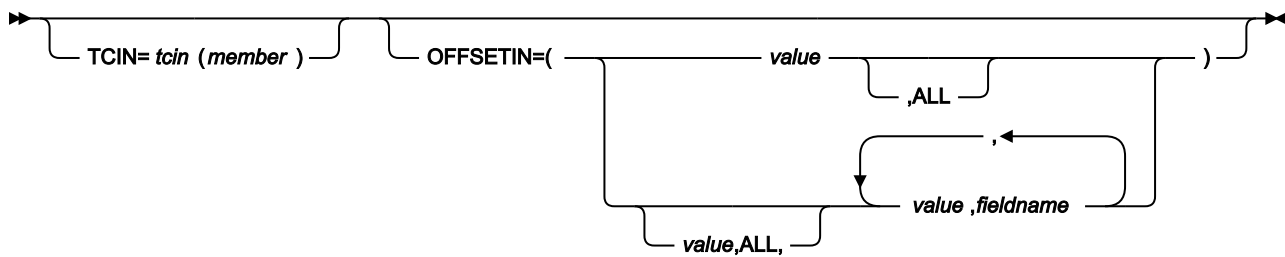

Copybook processing

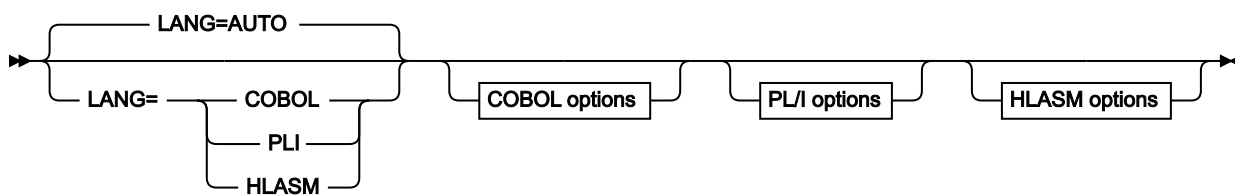

COBOL options

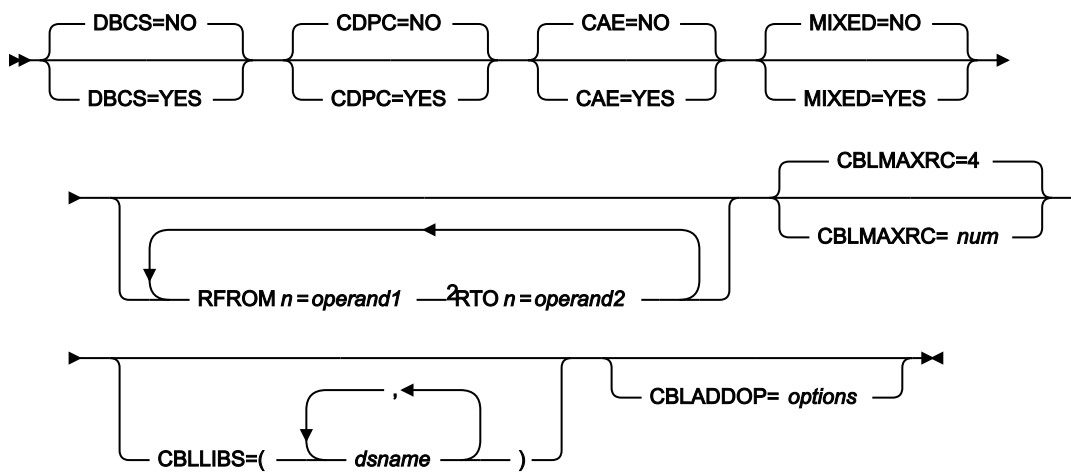

Notes:

¹ VSAM only.

² *n*= 1 to 5.

PL/I options

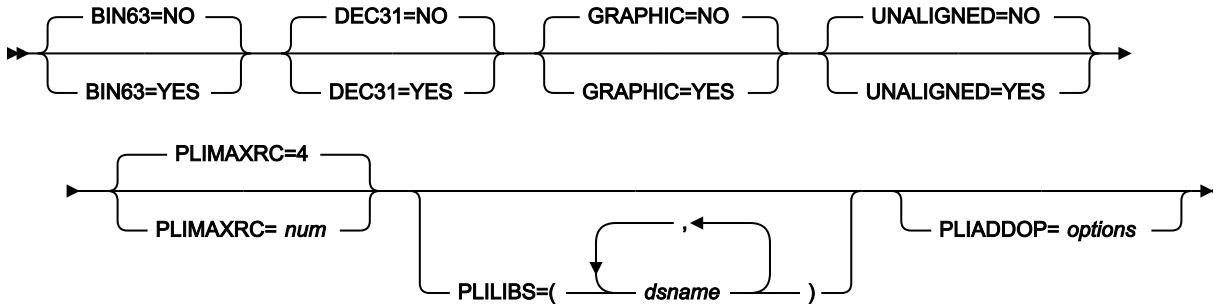

HLASM options

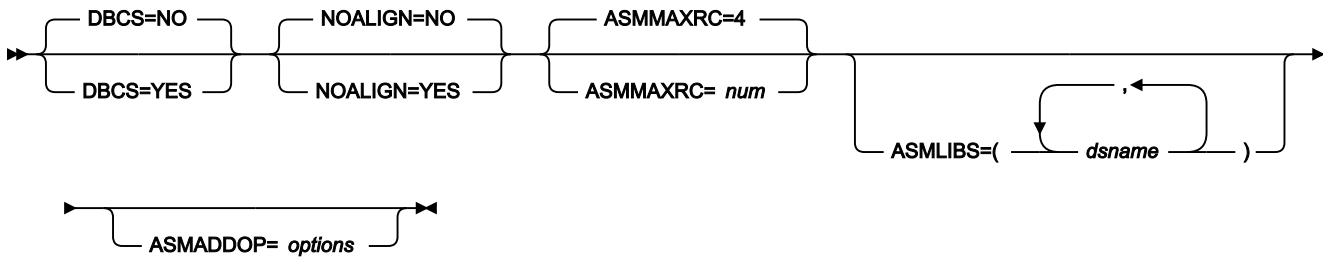

DSNIN=dsname

Defines the name of the data set to be edited. If any DD statements are specified, they are not used. The name may include a member name in parenthesis. If the member is specified here, the associated Member parameter must be empty. Must be specified when \$DSE is invoked from a REXX procedure or TSO clist.

Can be omitted when DSE is entered on a command line. If specified, you bypass the Entry panel, and go directly to the Data Set Edit panel. When omitted, the Data Set Edit Entry panel is displayed in interactive mode and you can specify a valid data set for browsing.

You can further describe this data set, as follows:

MEMBER=member

The name of a single member in a PDS, or a member name pattern representing one or more members in a PDS. If the data set is a PDS, you must specify this parameter.

A member name pattern can consist of any characters that are valid in a member name and two special pattern characters: the asterisk (*) and the percent symbol (%).

*

represents any number of characters. As many asterisks as required can appear anywhere in a member name pattern. For example, if you enter a member name pattern of *d*, all members in the PDS whose name contains "d" are processed.

%

is a place holding character that means a single character. As many percent symbols as necessary can appear anywhere in a member name pattern. For

example, if you enter a member name pattern of `****`, all members in the PDS whose name is four characters in length are processed.

`MEMBER=member` is ignored if the data set is not a PDS.

MQ:manager.queueName

You can specify a MQ queue in place of a data set name, where:

manager

The MQ manager to be used. If you specify a generic name, File Manager displays a list of matching managers to select from.

queueName

The queue to be used. If you specify a generic name, File Manager displays a list of matching queues to select from.

rt.applid:rname

You can specify a CICS® resource in place of a data set name, where:

rt

Resource type. Valid values are:

FI

For a CICS® file.

TD

For a Transient Data Queue.

TS

For a Temporary Storage Queue.

applid

The VTAM® applid of the CICS® system.

rname

The name of the resource.

VOLSERIN=volser

Volume serial number for a non-cataloged data set.

POSITION=skip

Number of logical records to be skipped from the beginning of the data set. The default is 0.

KEY=key (VSAM only)

A key for KSDS records, or a slot number for RRDS records. The maximum key length is 30 characters. The first record with a key or slot value greater than or equal to *key* is the first record copied. If you omit the *key* and *skip* values, browsing begins with the first record in the data set.

If the key contains lowercase characters, blanks, or commas, enclose it in quotation marks. You can also specify a key in hexadecimal format (for example, X'C1C2C3').

TCIN=*tcin(member)*

PDS and member name of the copybook or template that describes the record structure of your data set.

OFFSETIN

The length of the 01 field in the template and the start locations of the fields within that 01 field are adjusted by the value provided.

value

The offset value, which must be in the range -32760 to 32760, to be applied to the corresponding field identifier. If no field identifier is supplied and ALL is not used, the value is applied to the first Level 01 field in the template.

ALL

Where the template contains multiple record structures, this keyword applies the corresponding *value* to all Level 01 within the template.



Note: You can specify a value for ALL and then override this value for individual layouts by providing subsequent *value* and *fieldname* combinations.

fieldname

The name of the Level 01 field to which *value* is to be applied. The default is the first Level 01 field in the template.

Copybook processing

If you specify a copybook (instead of an existing template), File Manager uses these processing options to compile the copybook into a template:

LANG

Determines whether File Manager automatically detects the copybook language or interprets the language as COBOL, PL/I, or HLASM.



Note: The COMPLANG setting in FMN0POPT is the equivalent of the LANG parameter in batch functions.



- If COMPLANG is set it determines the installation default language for online and batch compilation.
- If COMPLANG is not specified then COBOL is the installation default for online compilation and AUTO is the default for batch compilation.
- If a value of COBOL, HLASM, PL/I, or AUTO is specified (in the **Compiler Language Selection** panel or through the LANG parameter in a batch job) it overrides the default language.

AUTO

Automatically detect whether the copybook language is COBOL or PL/I, and invoke the appropriate compiler. If the compilation results in a return code greater than 4, then invoke the compiler for the other language. If the second compilation also results in a return code greater than 4, then retry the first compiler and report the compilation errors. If File Manager successfully creates a template (despite the compilation errors), then continue processing with the template.

COBOL

Invoke the COBOL compiler to create a template from the copybook. (Do not invoke the PL/I compiler, even if the COBOL compilation results in errors.)

PLI

Invoke the PL/I compiler to create a template from the copybook. (Do not invoke the COBOL compiler, even if the PL/I compilation results in errors.)

HLASM

Invoke the HLASM compiler to create a template from the copybook.

DSINFO

Specifies whether additional data set information for input and output sources should be produced in batch reports for the DSP, DSM, DSC, and FCH commands.

NO

No additional data set information is generated.

YES

Generates data set information including DSORG, RECFM, LRECL, BLKSIZE, and VSAM attributes including average record length, maximum record length, key offset, key length and reuse, for input and output data sets when applicable.

COBOL options

The following options are used to compile a COBOL copybook into a template:

DBCS=YES

Use the DBCS compiler option.

DBCS=NO

Use the NODBCS compiler option.

For details on the effect of the DBCS and NODBCS compiler options, see the *IBM COBOL Programming Guide for OS/390 & VM*.

CDPC=NO

Do not use the COBOL SPECIAL-NAMES paragraph "Decimal-point is comma".

CDPC = YES

Use the COBOL SPECIAL-NAMES paragraph "Decimal-point is comma".

CAE=NO

Do not use the COBOL compile option ARITH(EXTEND).

CAE = YES

Use the COBOL compile option ARITH(EXTEND).

MIXED = NO

Field names stored in the template in uppercase.

MIXED = YES

Field names stored in the template in the original case as coded in the COBOL copybook.

RFROM1 RT01 ... RFROM5 RT05

Up to five pairs of "From" and "To" pseudo-text character strings for the COBOL REPLACE compiler-directing statement.

If your COBOL copybooks contain characters that you want to remove or replace with other characters before compiling the copybooks into templates, then use these replacing options.

For example, if your copybooks contain colon characters (:) that you want to remove before compiling, then specify '==:==' as *operand1* and '=====' as *operand2*.

For details on specifying "From" and "To" strings for COBOL REPLACE, see the *IBM COBOL Language Reference*.

CBLMAXRC

Sets the maximum acceptable return code for a copybook compile. A return code higher than the specified level causes the function to stop. Default is 4.



Note: The COMPMAXRC parameter is still supported but it is recommended that the CBLMAXRC parameter is used instead. If you do specify the COMPMAXRC parameter, it takes precedence over the language MAXRC.

CBLLIBS

Allows you to specify a list of up to ten data set names to be specified in the SYSLIB concatenation list. These data sets are searched in the order specified for COPY and INCLUDE members for the compilation.

dsname

The name of the data set name to be processed. Generic name masks are not allowed.

CBLADDOP

Additional COBOL compiler options which are included in a CBL statement when compiling COBOL copybooks.

PL/I options

The following options are used to compile a PL/I copybook into a template:

BIN63=YES

Use the LIMITS(FIXEDBIN(63)) compiler option.

BIN63=NO

Use the LIMITS(FIXEDBIN(31)) compiler option.

DEC31=YES

Use the LIMITS(FIXEDDEC(31)) compiler option.

DEC31=NO

Use the LIMITS(FIXEDDEC(15)) compiler option.

GRAPHIC=YES

Use the GRAPHIC compiler option.

GRAPHIC=NO

Use the NOGRAPHIC compiler option.

UNALIGNED=YES

Use the DEFAULT RANGE (*) UNALIGNED, language statement to change the default alignment.

UNALIGNED=NO

Use the PL/I default.

PLIMAXRC

Sets the maximum acceptable return code for a copybook compile. A return code higher than the specified level causes the function to stop. Default is 4.



Note: The COMPMAXRC parameter is still supported but it is recommended that the PLIMAXRC parameter is used instead. If you do specify the COMPMAXRC parameter, it takes precedence over the language MAXRC.

PLILIBS

Allows you to specify a list of up to ten data set names to be specified in the SYSLIB concatenation list. These data sets are searched in the order specified for COPY and INCLUDE members for the compilation.

dsname

The name of the data set name to be processed. Generic name masks are not allowed.

PLIADDOP

Additional PL/I compiler options which are included in a *PROCESS statement when compiling PL/I copybooks.

For details on the effect of these compiler options, see the *IBM VisualAge PL/I for OS/390 Programming Guide*.

HLASM options

The following options are used to compile a HLASM copybook into a template:

DBCS=YES

Use the DBCS compiler option.

DBCS=NO

Use the NODBCS compiler option.

NOALIGN=YES

Use the NOALIGN compiler option.

NOALIGN=NO

Use the ALIGN compiler option.

ASMMAXRC

Sets the maximum acceptable return code for a copybook compile. A return code higher than the specified level causes the function to stop. Default is 4.



Note: The COMPMAXRC parameter is still supported but it is recommended that the ASMMAXRC parameter is used instead. If you do specify the COMPMAXRC parameter, it takes precedence over the language MAXRC.

ASMLIBS

Allows you to specify a list of up to ten data set names to be specified in the SYSLIB concatenation list. These data sets are searched in the order specified for COPY and INCLUDE members for the compilation.

dsname

The name of the data set name to be processed. Generic name masks are not allowed.

ASMADDOP

Additional HLASM compiler options which are included in a *PROCESS statement when compiling COPY and MACRO members.

For details on the effect of these compiler options, see the *HLASM V1R6 Programmer's Guide*.

For more information on using this function, see:

- [Invoking File Manager panels from outside File Manager on page 39](#)
- [Introduction to programming with File Manager functions on page 503](#)
- [Invoking File Manager panels from REXX procedures or TSO clists on page 507](#)

```
FILEMGR "$DSE DSNIN='FMUSER.TEST.KSDS1',KEY=000100"
```

```
FILEMGR DSE
```

DSEB (Data Set Edit Batch) -- batch only

Purpose

Update disk data set records.

Usage notes

Use this function to update logical records in a single sequential disk data set, a single VSAM data set, one or more members of a PDS, an MQ queue, or a CICS® resource. You cannot use DSEB with compressed non-VSAM extended format data sets (compressed PSE data sets).

You can select the records to be processed using:

- Member name selection criteria
- Date created selection criteria
- Date last modified selection criteria
- User ID selection criteria

After the first record in the data set is read, File Manager invokes the REXX procedure specified in the PROC parameter. From now on, the processing of records is controlled by the REXX procedure. This includes the updating of the currently active record, and accessing the next record to be updated. You do not need to move through the data set sequentially. Instead, the REXX procedure can use UP, DOWN, BOTTOM, and TOP commands to position to a different record. After you have changed the contents of a record, you must update it before you position to a different record, otherwise the changes are lost.

For procedures requiring REXX, after a record is read, the contents are passed in two File Manager-defined REXX variables, INREC and OUTREC. The contents of the two variables are initially identical. The INREC variable is intended to be used as a reference variable. Any changes made to it are ignored by File Manager. The OUTREC variable can be updated by the exec.

You cannot add records or delete records using DSEB. If you need to add or delete records, you can use one of the File Manager data set copy functions. You cannot change the length of records in a data set using DSEB. If the REXX procedure increases the length of the data in OUTREC or output record (FASTREXX), the data is truncated to its original length before the record is updated. If the REXX procedure decreases the length of the data in OUTREC or output record (FASTREXX), the data is padded to its original length using the pad value specified in the PAD processing option. If no pad value has been specified, the contents of the record are unpredictable.

Performance tips

- DSEB may not be the most efficient function to perform a given task. If an operation is performance critical, first consider using another utility such as DSC, DSP, DSU or FCH.

DSU is the utility most similar to DSEB, although DSU performs only one pass over the file, from top to bottom.

- DSEB can be run under FASTREXX as long as it adheres to the supported REXX syntax for FASTREXX.
- The DSEB-only File Manager REXX command UP() can be inefficient. If you have a performance-critical DSEB operation which must reprocess records preceding the current record, consider ways of rewriting using the TOP() command, and try to do more work in each forward "pass" over the data.

Options

When you specify the PROC option, you are supplying a REXX procedure. For more information, see the *proc* parameter below.

Return codes

The default return codes from the DSEB function have the following modified meanings:

- 1**
One or more members not updated
- 2**
Change failed (for example invalid key change)
- 4**
No records updated and NOUPDATE=NO
- 4**
No records processed because no members to process
- 4**
No records processed because input empty
- 4**
No records processed because input is in ISPF Packed Data format and the "PACK=STOP" option was specified.
- 8**
REXX non-syntax error encountered while processing records
- 16**
Program Object specified - this is not supported
- 16**
Data set or member in use
- 16**
Data set or member open error
- 16**
Data set not found
- 16**
Other input or output error occurred
- 16**
Insufficient storage available
- 16**
DSEB abended
- 16**
Other serious error that stops processing occurred



Note: Return codes can be customized during installation. If you receive return codes that do not match those listed above, your site might have customized the return codes for this function. File Manager may also issue the 999 abend, if the return code in batch is equal to or greater than the ABENDCC value. Contact your File Manager systems administrator for details.

Related functions

DSG

Write test data to a data set

DSU

Update disk data set records

Figure 427. Syntax

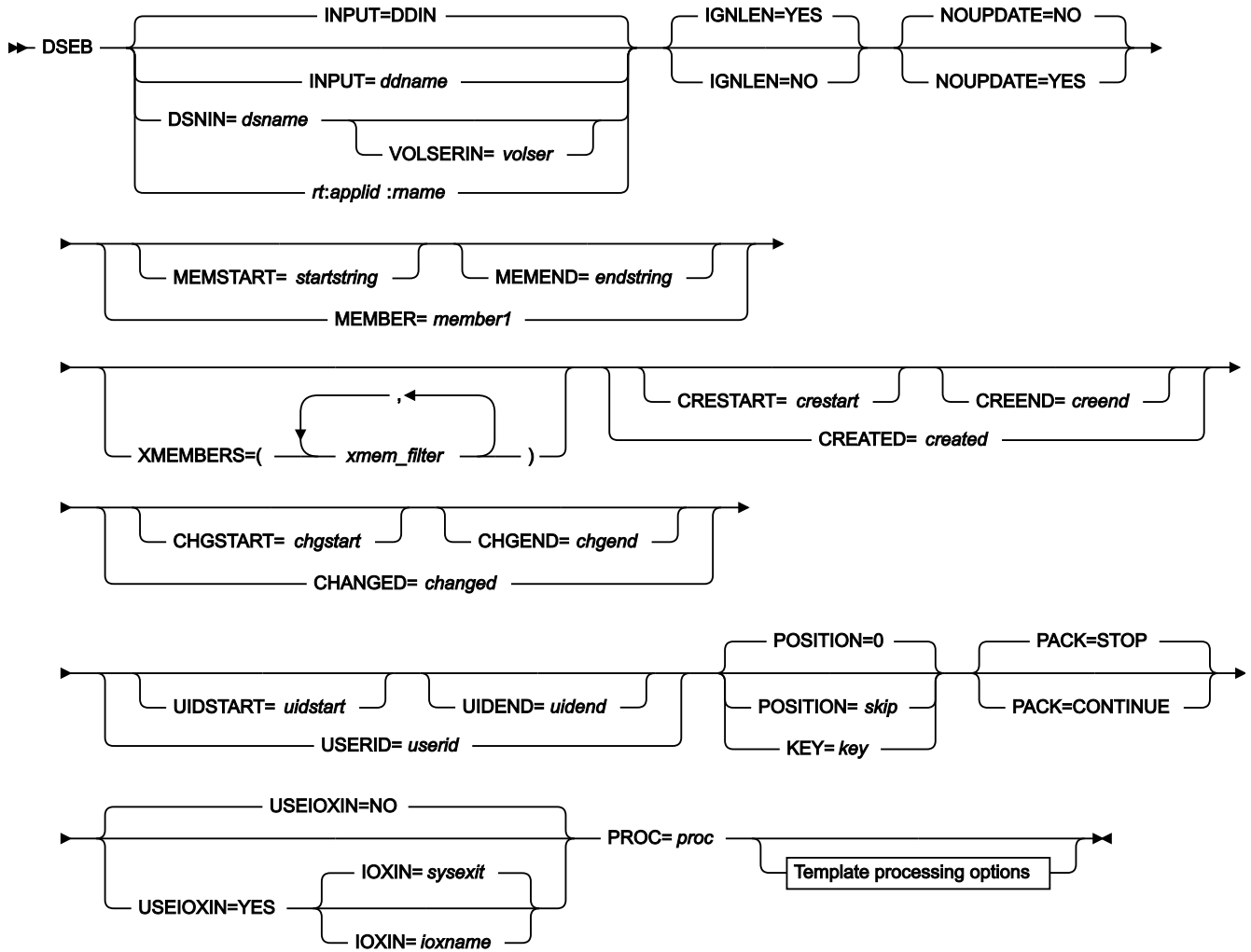

Template processing options

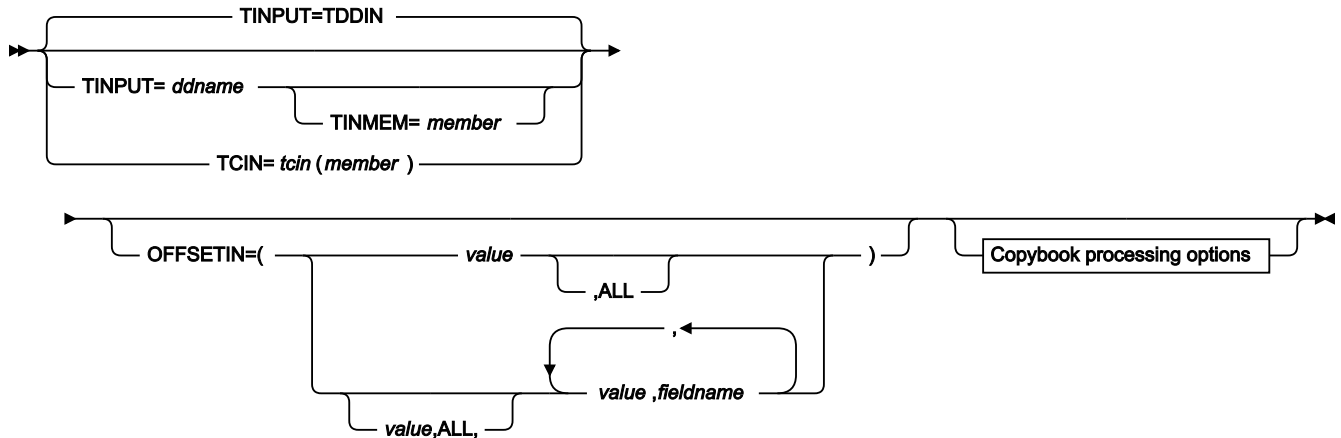

Copybook processing

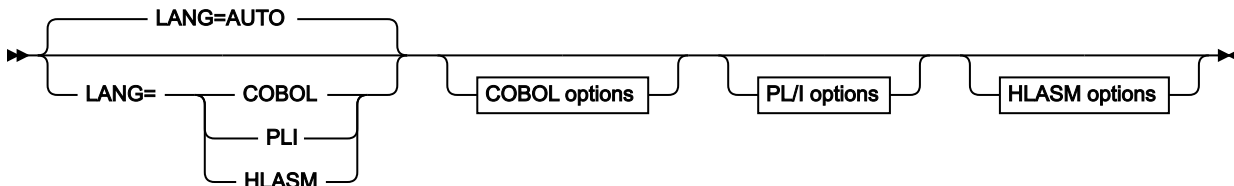

COBOL options

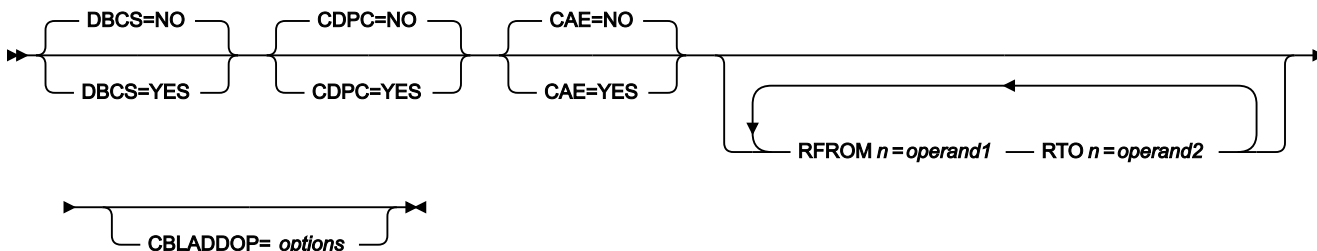

PL/I options

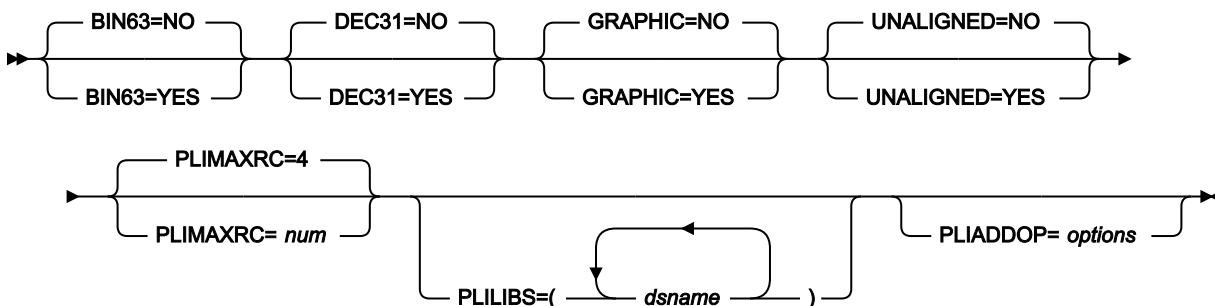

HLASM options

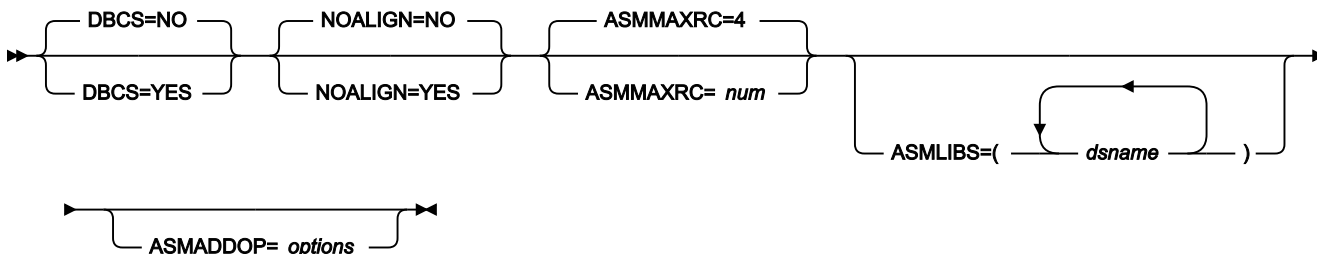

INPUT=ddname

Defines a reference to a DD or TSO ALLOC statement for the input data set. The default is `DDIN`.

DSNIN=dsname

Defines the name of the input data set. If any DD statements are specified, they are not used. The name may include a member name in parenthesis. If the member is specified here, the associated Member parameter must be empty. You can further describe this data set, as follows:

VOLSERIN=volser

Volume serial number for a non-cataloged data set.

rt:applid:rname

You can specify a CICS® resource in place of a data set name, where:

rt

Resource type. Valid values are:

FI

For a CICS® file.

TD

For a Transient Data Queue.

TS

For a Temporary Storage Queue.

applid

The VTAM® applid of the CICS® system.

rname

The name of the resource.

IGNLEN

Specifies whether or not File Manager ignores length mismatches when selecting records for processing.

NO

Do not ignore length mismatches. Records that are shorter than the matching structure length in the template are not selected for processing.

YES

Use this option to ignore length mismatches.

NOUPDATE

Allows you to specify that you intend no updates to the data set while executing the utility.

NO

Updates to the data are honored.

YES

Forces the allocation of the data set as input only. UPDATE() function is ignored.

MEMBER=member1

The name of a single member in a PDS, or a member name pattern representing one or more members in a PDS. If the input data set is a PDS(E), you may specify this parameter, or a member name in the DD statement for *ddname*, or specify a range of member names with the MEMSTART and MEMEND keywords.

A member name pattern can consist of any characters that are valid in a member name and two special pattern characters: the asterisk (*) and the percent symbol (%).

*

represents any number of characters. As many asterisks as required can appear anywhere in a member name pattern. For example, if you enter a member name pattern of `*d*`, all members in the PDS whose name contains "d" are processed.

%

is a place holding character that means a single character. As many percent symbols as necessary can appear anywhere in a member name pattern. For example, if you enter a member name pattern of `%%%`, all members in the PDS whose name is four characters in length are processed.

member1 is ignored if the data set is not a PDS.

MEMSTART=*startstring*

Is used to specify the start of a range of member names to be included in the copy. If MEMSTART is specified but MEMEND is omitted, all members of the PDS(E) from the *startstring* value onwards are included. *startstring* can have the same values, including wild cards, as for the *member1* parameter of the MEMBER keyword.

MEMEND=*endstring*

Is used to specify the end of a range of member names to be included in the copy. If MEMEND is specified but MEMSTART is omitted, all members of the PDS(E) up to the *endstring* value onwards are included. *endstring* can have the same values, including wild cards, as for the *member1* parameter of the MEMBER keyword.

XMEMBERS

Provides a way to exclude from processing library members that would otherwise be selected using the MEMSTART, MEMEND, and MEMBER options.

xmem_filter

A member name filter identifying one or more members that are to be excluded from processing. A filter can be a member name pattern representing multiple members.

To specify a member name filter containing lowercase characters, use a character string in the format `c'string'`. Filter values can also be specified as hexadecimal strings in the format `x'hex-digits'`.

CREATED=*created*

The date on which a member was created, in YYYY/MM/DD format.

If the input data set is a PDS(E), you may specify this parameter, or specify a range of creation dates with the CRESTART and CREEND keywords.

You can specify an asterisk (*) as the last character to indicate a range of dates or a percent sign (%) in place of a single character to indicate a selection of dates.

created is ignored if the data set is not a PDS.

CRESTART=*crestart*

The start of a range of creation dates in YYYY/MM/DD format to be included in the copy.

If CRESTART is specified but CREEND is omitted, all members of the PDS(E) from the *crestart* value onwards are included.

If omitted, or you do not enter a full date, or you specify an asterisk (*) as the last character, the unspecified portion of *crestart* defaults to the right as follows:

DD

= 01

MM

= 01

YYYY

= 0000

No other wildcarding is allowed.

CREEND=*creend*

The end of a range of creation dates in YYYY/MM/DD format to be included in the copy.

If omitted, or you do not enter a full date, or you specify an asterisk (*) as the last character, the unspecified portion of *creend* defaults to the right as follows:

DD

= 31

MM

= 12

YYYY

= 9999

No other wildcarding is allowed.

CHANGED=*changed*

The date on which a member was last modified, in YYYY/MM/DD format.

If the input data set is a PDS(E), you may specify this parameter, or specify a range of modification dates with the CHGSTART and CHGEND keywords.

You can specify an asterisk (*) as the last character to indicate a range of dates or a percent sign (%) in place of a single character to indicate a selection of dates.

changed is ignored if the data set is not a PDS.

CHGSTART=*chgstart*

The start of a range of modification dates in YYYY/MM/DD format to be included in the copy.

If CHGSTART is specified but CHGENG is omitted, all members of the PDS(E) from the *chgstart* value onwards are included.

If omitted, or you do not enter a full date, or you specify an asterisk (*) as the last character, the unspecified portion of *chgstart* defaults to the right as follows:

DD

= 01

MM

= 01

YYYY

= 0000

No other wildcarding is allowed.

CHGENG=*chgeng*

The end of a range of modification dates in YYYY/MM/DD format to be included in the copy.

If omitted, or you do not enter a full date, or you specify an asterisk (*) as the last character, the unspecified portion of *chgeng* defaults to the right as follows:

DD

= 31

MM

= 12

YYYY

= 9999

No other wildcarding is allowed.

USERID=*userid*

The TSO user ID by which the member was last updated.

If the input data set is a PDS(E), you may specify this parameter, or specify a range of user IDs with the UIDSTART and UIDEND keywords.

You can enter a generic user ID by using asterisks and percent signs.

userid is ignored if the data set is not a PDS.

UIDSTART=*uidstart*

The start of a range of user IDs to be included in the copy.

If UIDSTART is specified but UIDEND is omitted, all members of the PDS(E) from the *uidstart* value onwards are included.

If omitted, or you do not enter a full 7-character user ID, or you specify an asterisk (*) as the last character, File Manager replaces the asterisk and pads the unspecified portion of *uidstart* to the right with low values (X'00').

UIDEND=*uidend*

The end of a range of user IDs to be included in the copy.

If you omit this field, it defaults to high values (X'FF').

If you specify less than 7 characters (without an asterisk as the last character), File Manager pads *uidstart* to the right with low values (X'00'). If you specify an asterisk (*) as the last character, File Manager replaces the asterisk and pads the unspecified portion of *uidend* with high values (X'FF').

POSITION=*skip*

Number of logical records to be skipped from the beginning of the data set. The default is 0.

KEY=*key* (VSAM only)

A key for KSDS records, or a slot number for RRDS records. The maximum key length is 30 characters. The first record with a key or slot value greater than or equal to *key* is the first record printed. If you omit the *key* and *skip* values, printing begins with the first record in the data set.

If the key contains lowercase characters, blanks, or commas, enclose it in quotation marks. You can also specify a key in hexadecimal format (for example, X'C1C2C3').

PACK

Determines if File Manager should detect if the input data is in ISPF packed format.

STOP

Default. File Manager detects whether the input data is in ISPF packed format, and if it is, stops the processing.

CONTINUE

File Manager does not detect whether the input data is in ISPF packed format and continues processing.

USEIOXIN

Specifies whether to invoke a user I/O exit, to process the input data set.

NO

Default. Do not invoke a user I/O exit.

YES

Invoke a user I/O exit to process the input data set. This option is only available if the person who did the site customization for File Manager allowed user I/O exits on a site-wide basis.

IOXIN

Specifies the name of the user I/O exit used for the input data set. There are no restrictions on the programming language that you can use to write an exit. The exit must be provided to File Manager in the STEPLIB/ISPLLIB concatenation or their extensions (LINKLIST, LPA, and so on).

sysexit

Default. If you specify USEIOXIN=YES and do not supply a user I/O exit name, File Manager uses the name of the exit provided in the installation customization options. If USEIOXIN has been set to YES and no installation default has been provided, you must specify IOXIN=*ioxname*.



Note: If you have selected batch processing in an online panel, the generated JCL statements use the default name provided in your Set System Processing Options panel.

ioxname

The name of a PDS(E) member of a data set that has been provided to File Manager in the STEPLIB concatenation.

PROC=*proc*

Member name of a REXX procedure that you want to use to process each record before it is updated, or an asterisk (*) to indicate the procedure is inline. If you specify a PDS member name, you must define an FMNEXEC ddname that identifies the PDS containing the member. If you specify *, the procedure is read from SYSIN immediately following the control statement for the current function. The inline procedure is terminated by a record containing a slash and a plus sign (/+) in columns 1–2.

For more information about using REXX procedures to process records before they are updated, see [Enhancing File Manager processing on page 517](#).

Template processing

Define which template (if any) is used to describe the record structure in the input data set, and how File Manager processes this template.

TINPUT=*ddname*

Defines a reference to a DD or TSO ALLOC statement for the data sets which contain the copybook or template that describes the record structure of your input data. The default is TDDIN.

If you specify a concatenated DD, then you must provide the member name, *member*.

TINMEM=*member*

The name of the copybook or template member in the datasets identified by the TINPUT parameter if it has not been specified on the DD statement. This parameter must not be specified if the TCIN parameter is specified.

TCIN=tcin(member)

PDS and member name of the copybook or template that describes the record structure of your input data.



Note: If you specify a template for DSEB and DSU, it is ignored, except for calls to the external REXX function PRINT specifying TABL or SNGL format.

OFFSETIN

The length of the 01 field in the template and the start locations of the fields within that 01 field are adjusted by the value provided.

value

The offset value, which must be in the range -32760 to 32760, to be applied to the corresponding field identifier. If no field identifier is supplied and ALL is not used, the value is applied to the first Level 01 field in the template.

ALL

Where the template contains multiple record structures, this keyword applies the corresponding *value* to all Level 01 within the template.



Note: You can specify a value for ALL and then override this value for individual layouts by providing subsequent *value* and *fieldname* combinations.

fieldname

The name of the Level 01 field to which *value* is to be applied. The default is the first Level 01 field in the template.

Copybook processing

If you specify a copybook (instead of an existing template), File Manager uses these processing options to compile the copybook into a template:

LANG

Determines whether File Manager automatically detects the copybook language or interprets the language as COBOL, PL/I, or HLASM.



Note: The COMPLANG setting in FMN0POPT is the equivalent of the LANG parameter in batch functions.



- If COMPLANG is set it determines the installation default language for online and batch compilation.
- If COMPLANG is not specified then COBOL is the installation default for online compilation and AUTO is the default for batch compilation.
- If a value of COBOL, HLASM, PL/I, or AUTO is specified (in the **Compiler Language Selection** panel or through the LANG parameter in a batch job) it overrides the default language.

AUTO

Automatically detect whether the copybook language is COBOL or PL/I, and invoke the appropriate compiler. If the compilation results in a return code greater than 4, then invoke the compiler for the other language. If the second compilation also results in a return code greater than 4, then retry the first compiler and report the compilation errors. If File Manager successfully creates a template (despite the compilation errors), then continue processing with the template.

COBOL

Invoke the COBOL compiler to create a template from the copybook. (Do not invoke the PL/I compiler, even if the COBOL compilation results in errors.)

PLI

Invoke the PL/I compiler to create a template from the copybook. (Do not invoke the COBOL compiler, even if the PL/I compilation results in errors.)

HLASM

Invoke the HLASM compiler to create a template from the copybook.

DSINFO

Specifies whether additional data set information for input and output sources should be produced in batch reports for the DSP, DSM, DSC, and FCH commands.

NO

No additional data set information is generated.

YES

Generates data set information including DSORG, RECFM, LRECL, BLKSIZE, and VSAM attributes including average record length, maximum record length, key offset, key length and reuse, for input and output data sets when applicable.

COBOL options

The following options are used to compile a COBOL copybook into a template:

DBCS=YES

Use the DBCS compiler option.

DBCS=NO

Use the NODBCS compiler option.

For details on the effect of the DBCS and NODBCS compiler options, see the *IBM COBOL Programming Guide for OS/390 & VM*.

CDPC=NO

Do not use the COBOL SPECIAL-NAMES paragraph "Decimal-point is comma".

CDPC = YES

Use the COBOL SPECIAL-NAMES paragraph "Decimal-point is comma".

CAE=NO

Do not use the COBOL compile option ARITH(EXTEND).

CAE = YES

Use the COBOL compile option ARITH(EXTEND).

MIXED = NO

Field names stored in the template in uppercase.

MIXED = YES

Field names stored in the template in the original case as coded in the COBOL copybook.

RFROM1 RT01 ... RFROM5 RT05

Up to five pairs of "From" and "To" pseudo-text character strings for the COBOL REPLACE compiler-directing statement.

If your COBOL copybooks contain characters that you want to remove or replace with other characters before compiling the copybooks into templates, then use these replacing options.

For example, if your copybooks contain colon characters (:) that you want to remove before compiling, then specify '==:==' as *operand1* and '=====' as *operand2*.

For details on specifying "From" and "To" strings for COBOL REPLACE, see the *IBM COBOL Language Reference*.

CBLMAXRC

Sets the maximum acceptable return code for a copybook compile. A return code higher than the specified level causes the function to stop. Default is 4.



Note: The COMPMAXRC parameter is still supported but it is recommended that the CBLMAXRC parameter is used instead. If you do specify the COMPMAXRC parameter, it takes precedence over the language MAXRC.

CBLLIBS

Allows you to specify a list of up to ten data set names to be specified in the SYSLIB concatenation list. These data sets are searched in the order specified for COPY and INCLUDE members for the compilation.

dsname

The name of the data set name to be processed. Generic name masks are not allowed.

CBLADDOP

Additional COBOL compiler options which are included in a CBL statement when compiling COBOL copybooks.

PL/I options

The following options are used to compile a PL/I copybook into a template:

BIN63=YES

Use the LIMITS(FIXEDBIN(63)) compiler option.

BIN63=NO

Use the LIMITS(FIXEDBIN(31)) compiler option.

DEC31=YES

Use the LIMITS(FIXEDDEC(31)) compiler option.

DEC31=NO

Use the LIMITS(FIXEDDEC(15)) compiler option.

GRAPHIC=YES

Use the GRAPHIC compiler option.

GRAPHIC=NO

Use the NOGRAPHIC compiler option.

UNALIGNED=YES

Use the DEFAULT RANGE (*) UNALIGNED, language statement to change the default alignment.

UNALIGNED=NO

Use the PL/I default.

PLIMAXRC

Sets the maximum acceptable return code for a copybook compile. A return code higher than the specified level causes the function to stop. Default is 4.



Note: The COMPMAXRC parameter is still supported but it is recommended that the PLIMAXRC parameter is used instead. If you do specify the COMPMAXRC parameter, it takes precedence over the language MAXRC.

PLILIBS

Allows you to specify a list of up to ten data set names to be specified in the SYSLIB concatenation list. These data sets are searched in the order specified for COPY and INCLUDE members for the compilation.

dsname

The name of the data set name to be processed. Generic name masks are not allowed.

PLIADDOP

Additional PL/I compiler options which are included in a *PROCESS statement when compiling PL/I copybooks.

For details on the effect of these compiler options, see the *IBM VisualAge PL/I for OS/390 Programming Guide*.

HLASM options

The following options are used to compile a HLASM copybook into a template:

DBCS=YES

Use the DBCS compiler option.

DBCS=NO

Use the NODBCS compiler option.

NOALIGN=YES

Use the NOALIGN compiler option.

NOALIGN=NO

Use the ALIGN compiler option.

ASMMAXRC

Sets the maximum acceptable return code for a copybook compile. A return code higher than the specified level causes the function to stop. Default is 4.



Note: The COMPMAXRC parameter is still supported but it is recommended that the ASMMAXRC parameter is used instead. If you do specify the COMPMAXRC parameter, it takes precedence over the language MAXRC.

ASMLIBS

Allows you to specify a list of up to ten data set names to be specified in the SYSLIB concatenation list. These data sets are searched in the order specified for COPY and INCLUDE members for the compilation.

dsname

The name of the data set name to be processed. Generic name masks are not allowed.

ASMADDOP

Additional HLASM compiler options which are included in a *PROCESS statement when compiling COPY and MACRO members.

For details on the effect of these compiler options, see the *HLASM V1R6 Programmer's Guide*.

```
//FMNDSEB JOB 'change YPE to ORK every record'
//FMNBAT EXEC PGM=FILEMGR
//STEPLIB DD DSN=FMN.SFMNMOD1,DISP=SHR
//SYSPRINT DD SYSOUT=*
//FMNTSPRT DD SYSOUT=*
//SYSIN DD *
$$FILEM DSEB DSNIN=FMNUSER.KSDS.BASE,
$$FILEM PROC=*
filerc = 0
do while filerc = 0
  outrec=change(outrec,'YPE','ORK',0)
  update()
  filerc = down(1)
end
/+
//*
```

This example is the same as Batch example 1, but with FASTREXX.

```
//FMNDSEB JOB 'change YPE to ORK every record'
//FMNBAT EXEC PGM=FILEMGR
//STEPLIB DD DSN=FMN.SFMNMOD1,DISP=SHR
//SYSPRINT DD SYSOUT=*
//FMNTSPRT DD SYSOUT=*
//SYSIN DD *
$$FILEM DSEB DSNIN=FMNUSER.KSDS.BASE,
$$FILEM PROC=*
filerc = 0
do while filerc = 0
  outrec=change(outrec,'YPE','ORK',0)
```

```

update()
  filerc = down(1)
end
/+
/**

//FMNDSEB JOB  '4 recs into 1 rec'
/** Job to take SEQ500.BKUP file, copy it to SEQ500
/** and also create SEQ500.COMBINE, which is created from four input records
//DEL      EXEC PGM=IEFBR14
//COMBINE  DD DSN=FMNUSER.SEQ500.FOURUP,DISP=(MOD,DELETE),
//          SPACE=(TRK,(5,5)),DCB=(LRECL=320,BLKSIZE=0,RECFM=FB)
//FMNBAT   EXEC PGM=FILEMGR
//STEPLIB DD DSN=FMN.SFMNMOD1,DISP=SHR
//SYSPRINT DD SYSOUT=*
//FMNTSPRT DD SYSOUT=*
//COPY     DD DSN=FMNUSER.SEQ500,DISP=OLD
//COMBINE  DD DSN=FMNUSER.SEQ500.FOURUP,DISP=(NEW,CATLG),
//          SPACE=(TRK,(5,5)),DCB=(LRECL=320,BLKSIZE=0,RECFM=FB)
//SYSTEM   DD SYSOUT=*
//SYSIN    DD *
$$FILEM DSEB DSNIN=FMNUSER.SEQ500.BKUP,
$$FILEM PROC=*
fpos      = 0
recnum    = 0
filerc    = 0
Outrec.combine = ''
do while filerc = 0
  recnum = recnum +1
  /* Create just a copy of this file */
  Outrec.Copy = Outrec
  Write(Copy)
  /* concatenate every four records into one record on combine data set */
  Outrec.combine = Outrec.combine||Outrec
  If recnum // 4 = 0 then do
    Write(Combine)
    Outrec.combine = ''
  end
  filerc = down(1)
end
/+
/**

```

DSFA (Altering a data set)

Purpose

Change the attributes of a data set.

Usage notes

Data set attribute alteration parameters, as supported by Access Method Services, are provided with the exception of: EXCEPTIONEXIT, FILE, LOCK or UNLOCK, and NULLIFY. If the operation cannot be performed,

Access Method Services messages are returned; for example, where a parameter is not applicable to the type of data set.

Options

None.

Figure 428. Syntax

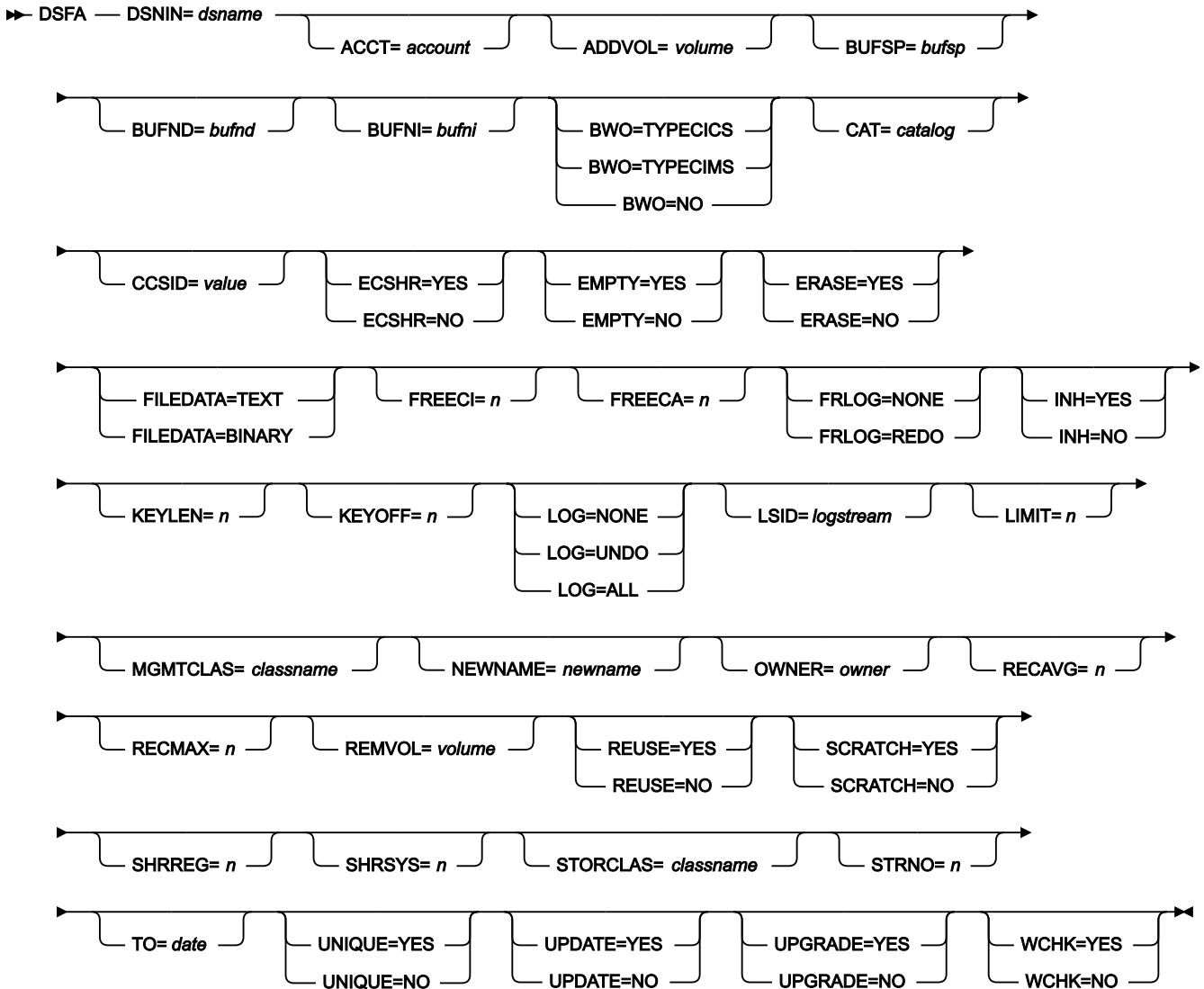

DSNIN=dsname

The name of the data set whose attributes you want to alter.



Note: All the parameters you specify for the DSFA function are passed to the Access Method Services (AMS) ALTER command.



For more information about these parameters, see *DFSMS AMS for Catalogs*, SC26-7394.

DSFC (Allocate a data set)

Purpose

Allocate a data set based on the attributes of another data set.

Options

None.

Figure 429. Syntax

►► DSFC — DSNOUT= *dsname* — LIKE= *dsname* ◄◄

DSNOUT=*dsname*

The name of the new data set whose attributes are to be based on the attributes of the data set specified for LIKE.

LIKE=*dsname*

The name of the data set whose attributes are to be used when allocating the new data set.

DSFD (Delete a data set)

Purpose

Delete a data set.

Options

None.

Figure 430. Syntax

►► DSFD — DSNIN= *dsname* ◄◄

DSNIN=*dsname*

The name of the data set you want to delete.

DSFR (Rename a data set)

Purpose

Rename a data set.

Options

None.

Figure 431. Syntax

►► DSFR — DSNIN= *dsname* — DSNOUT= *dsname* ◄◄

DSNIN=*dsname*

The existing name of the data set that you want to rename.

DSNOUT=*dsname*

The new name of the data set that you want to rename.

DSG (Data Set Generate)

Purpose

Use the DSG function to create and initialize data values in VSAM data sets, sequential data sets, PDS members, HFS files, MQ queues, or CICS® resources.

You specify the number of records that are to be created and how they are to be initialized. You can initialize the data with fill characters and patterns. When you use a copybook or a template you can initialize records at the field level. You can change the field create attributes for individual fields by editing the copybook or template.

Options

You can specify a fill character or fill pattern, a sequence field, and a block size.

Return codes

The default return codes from the DSG function have the following modified meanings:

4

No records generated because zero records specified

16

No records generated because DISP=MOD specified for member

16

No records generated because key not fully within data

16

Member name required and not specified

16

Program Object specified - this is not supported

16

Data set in use

16

Data set or member in use

16

Data set or member open error

16

Other input or output error occurred

16

Insufficient storage available

16

DSG abended

16

Other serious error that stops processing occurred



Note: Return codes can be customized during installation. If you receive return codes that do not match those listed above, your site might have customized the return codes for this function. File Manager may also issue the 999 abend, if the return code in batch is equal to or greater than the ABENDCC value. Contact your File Manager systems administrator for details.

Related functions**BT**

Write test data to a tape file

INT

Initialize a tape

Figure 432. Syntax

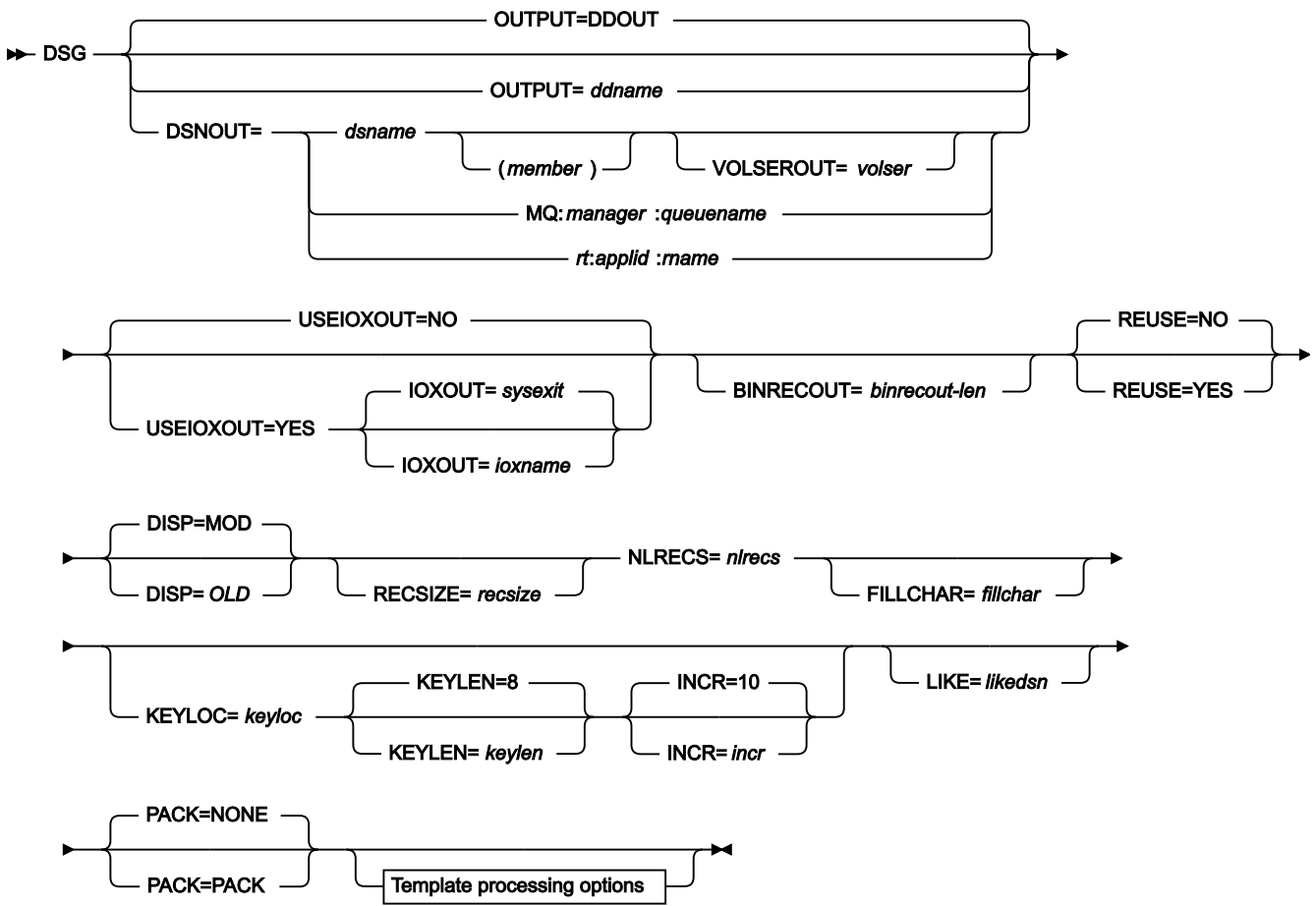

Template processing options

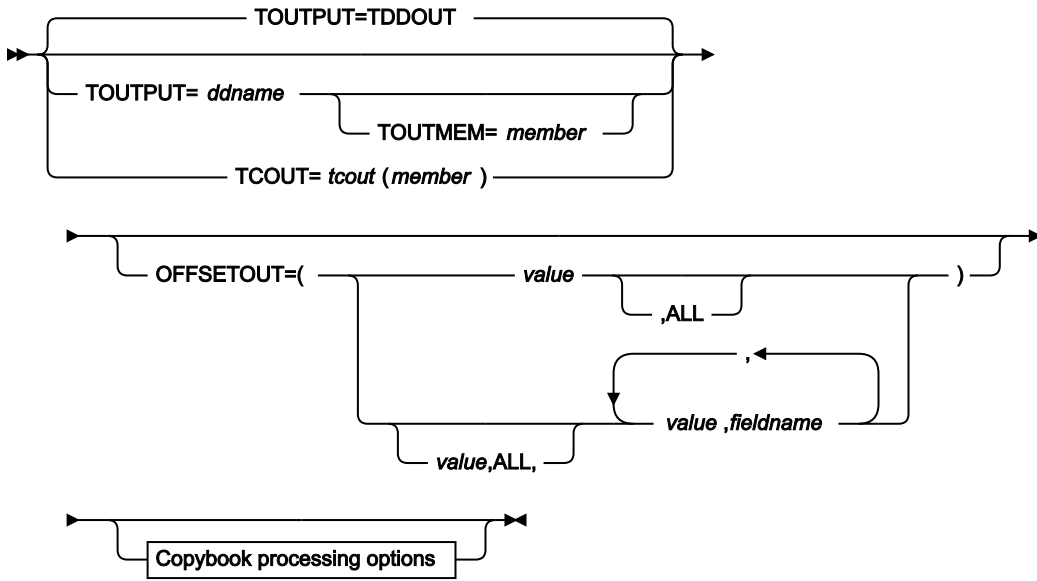

Copybook processing

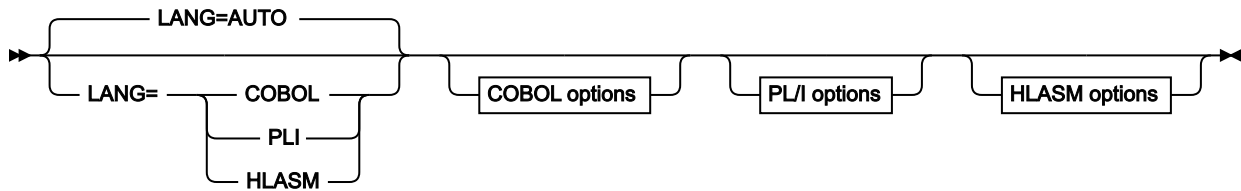

COBOL options

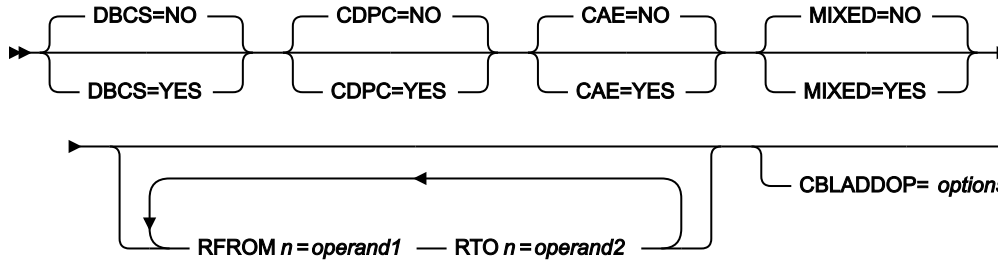

PL/I options

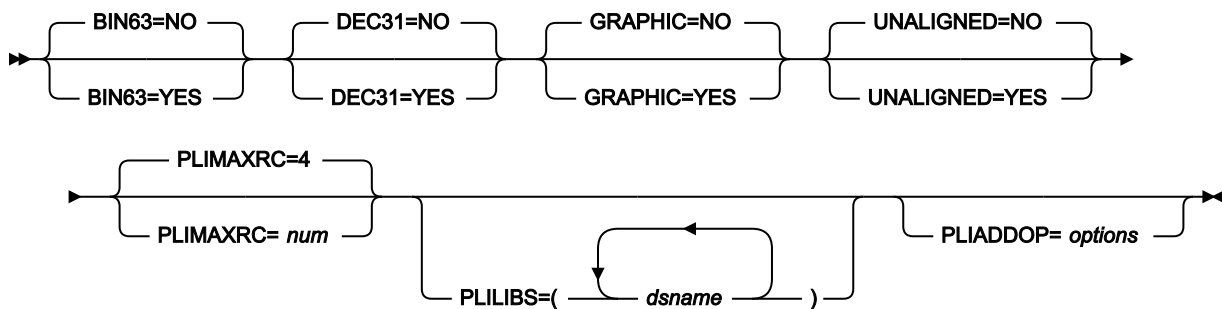

HLASM options

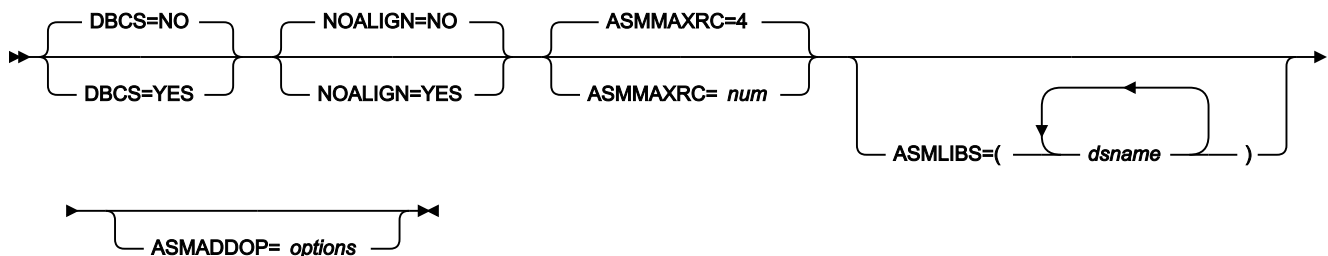
**OUTPUT=ddname**

Defines a reference to a DD or TSO ALLOC statement for the output data set or HFS file. The default is `DDOUT`.

DSNOUT=dsname

Defines the name of the output data set or an absolute path to the output HFS file. If any DD statements are specified, they are not used. The name may include a member name in parenthesis. If the member is specified here, the associated Member parameter must be empty.

An absolute path to an HFS file (directory) must be enclosed in apostrophes. If it does not fit on one line, you can split it over more than one line.

You can further describe this data set, as follows:

(member)

Where DSNOUT=*dsname* specifies a PDS and you want to send the output to a specific member within this data set, this defines the output member name.

VOLSEROUT=volser

Volume serial number for a new or non-cataloged data set.

MQ:manager.queueName

You can specify a MQ queue in place of a data set name, where:

manager

The MQ manager to be used. If you specify a generic name, File Manager displays a list of matching managers to select from.

queueName

The queue to be used. If you specify a generic name, File Manager displays a list of matching queues to select from.

rt.applid:rname

You can specify a CICS® resource in place of a data set name, where:

rt

Resource type. Valid values are:

FI

For a CICS® file.

TD

For a Transient Data Queue.

TS

For a Temporary Storage Queue.

applid

The VTAM® applid of the CICS® system.

rname

The name of the resource.

USEIOXOUT

Specifies whether to invoke a user I/O exit, to process the output data set.

NO

Default. Do not invoke a user I/O exit.

YES

Invoke a user I/O exit to process the output data set. This option is only available if the person who did the site customization for File Manager allowed user I/O exits on a site-wide basis.

IOXOUT

Specifies the name of the user I/O exit used for the output data set. There are no restrictions on the programming language that you can use to write an exit. The exit must be provided to File Manager in the STEPLIB/ISPLLIB concatenation or their extensions (LINKLIST, LPA, and so on).

sysexit

Default. If you specify USEIOXOUT=YES and do not supply a user I/O exit name, File Manager uses the name of the exit provided in the installation customization options. If USEIOXOUT has been set to YES and no installation default has been provided, you must specify IOXOUT=*ioxname*.



Note: If you have selected batch processing in an online panel, the generated JCL statements use the default name provided in your Set System Processing Options panel.

ioxname

The name of a PDS(E) member of a data set that has been provided to File Manager in the STEPLIB concatenation.

BINRECOUT=*binrecout-len*

Specifies the record length for processing the HFS file. Valid range: 1 to 32760.

The file is processed in Binary mode (fixed-length records derived from the file, delimiters not distinguished). If you do not specify this parameter, the file is processed in Text mode (variable-length records, boundaries determined by delimiters).

REUSE

Specify YES to replace any existing records in the output data set (if it is defined with the REUSE parameter in the catalog). Specify NO to add new records without deleting the old records. The default is NO.

DISP

Disposition of the output data set. Specify OLD or MOD.

OLD

Writes input records to the existing output data set, starting from the beginning.

MOD

Default. Appends the input records to the end of the existing output data set.



Note: If you are appending to a sequential data set, ensure that the existing data set does not contain data in ISPF Packed Data format. Appending records to a packed data set results in data errors.



Note: SMS might modify the allocation of new data sets on your system. For details, contact your SMS Administrator.

RECSIZE=*resize*

1-9999999, depending on the output file characteristics.

For fixed record formats the record length is set to the record length and user input is ignored.

For undefined record formats the record length is set to the block length and user input is ignored.

For variable record formats the record length specified is used if it is less than the maximum record size.

Otherwise the maximum record size is used and user input is ignored.

When the data create function is used with a template, the length of the records written depends upon whether the records are fixed-length or variable-length, and the length of the record description in the template (note that the length of the record in the template must always be less than or equal to the data set record length). The value specified in *resize* is ignored when using a template.

For fixed-length records created with a template, all records have the length specified for the data set. If the length of the record in the template is less than the data set record length, the records are padded with the fill character.

For variable-length records created with a template, the length of each record depends on the length of the record built using the field attributes in the template. If the template record description contains one or more variable-length arrays, the length of the record varies according to the value or values assigned to objects of the OCCURS DEPENDING ON clauses.

NLRECS=*nirecs*

Number of logical records to be written. The maximum is 999 999 999.

FILLCHAR=*fillchar*

To fill each byte of each record with data, specify one of the following:

char

A character, such as 0 to be written in each byte. (To specify a lowercase character such as 'a', use either C'a' or X'81'.)

X'cc'

A binary character, such as X'04' to be written in each byte.

AN

To write alphanumeric characters (A to Z and 0 to 9).

BIN

To write binary characters (X'00' to X'FF').

RAND

To write random binary characters (X'00' to X'FF').

If you specify AN or BIN, characters are written in a “ripple” pattern. For example, if you specify AN, the first 3 records look like this:

```

ABCDEFGHIJKLMN0PQRSTUVWXYZ0123456789A
BCDEFGHIJKLMN0PQRSTUVWXYZ0123456789AB
CDEFGHIJKLMN0PQRSTUVWXYZ0123456789ABC

```

The default is a blank.

KEYLOC=*keyloc*

Position (starting with 1) of the sequence field within the output records. If omitted, there is no sequence field.



Note: KEYLOC is not the same as a VSAM KSDS key position. KEYLOC refers to a "virtual" key field (sequence number) created in all records to identify a specific record within a file.

KEYLEN=*keylen*

Length of the sequence field, from 1 to 9. The default is 8.



Note: KEYLEN is not the same as a VSAM KSDS key length. KEYLEN refers to a "virtual" key field (sequence number) created in all records to identify a specific record within a file.

INCR=*incr*

Increment value for the sequence field. The default is 10.

LIKE=*likedsname*

Name of the data set to be used as the model for the output allocation.

File Manager uses the TSO prefix (as defined for your user ID) used as the high-level qualifier for any name that is not enclosed in quotation marks.

If copying data sets, “=” denotes the current input data set.

The model data set must reside on a DASD volume, be cataloged, and SMS must be active.

PACK

Determines if File Manager writes the output data in ISPF packed format. This keyword is ignored when processing VSAM data sets. When an I/O exit has been specified for either the input or output data set (or both), the only valid option is PACK=NONE.

PACK

Instructs File Manager to write the output in ISPF packed format.

NONE

Instructs File Manager not to write the output in ISPF packed format.



Note: Do not use the DISP=MOD and PACK=PACK option at the same time. Appending packed data to a packed or non-packed sequential data set results in data errors. Appending non-packed data to a packed data set also results in data errors.

Template processing

The template processing parameters define which template is used to describe the structure of the new records and how File Manager processes the template.

TOUTPUT=ddname

Defines a reference to a DD or TSO ALLOC statement for the data sets which contain the copybook or template that describes the record structure of your output data. The default is TDDOUT.

If you specify a concatenated DD, then you must provide the member name, *member*.

TOUTMEM=member

The name of the copybook or template member in the datasets identified by the TOUTPUT parameter if it has not been specified on the DD statement. This parameter must not be specified if the TCOUT parameter is specified.

TCOUT=tcout(member)

PDS and member name of the copybook or template that describes the record structure of your output data.

OFFSETOUT

The length of the 01 field in the template and the start locations of the fields within that 01 field are adjusted by the value provided.

value

The offset value, which must be in the range -32760 to 32760, to be applied to the corresponding field identifier. If no field identifier is supplied and ALL is not used, the value is applied to the first Level 01 field in the "To" template.

ALL

Where the template contains multiple record structures, this keyword applies the corresponding *value* to all Level 01 fields within the “To” template.



Note: You can specify a value for ALL and then override this value for individual layouts by providing subsequent *value* and *fieldname* combinations.

fieldname

The name of the Level 01 field to which *value* is applied. The default is the first Level 01 field in the “To” template.

Copybook processing

If you specify a copybook (instead of an existing template), File Manager uses these processing options to compile the copybook into a template:

LANG

Determines whether File Manager automatically detects the copybook language or interprets the language as COBOL, PL/I, or HLASM.



Note: The COMPLANG setting in FMN0POPT is the equivalent of the LANG parameter in batch functions.

- If COMPLANG is set it determines the installation default language for online and batch compilation.
- If COMPLANG is not specified then COBOL is the installation default for online compilation and AUTO is the default for batch compilation.
- If a value of COBOL, HLASM, PL/1, or AUTO is specified (in the **Compiler Language Selection** panel or through the LANG parameter in a batch job) it overrides the default language.

AUTO

Automatically detect whether the copybook language is COBOL or PL/I, and invoke the appropriate compiler. If the compilation results in a return code greater than 4, then invoke the compiler for the other language. If the second compilation also results in a return code greater than 4, then retry the first compiler and report the compilation errors. If File Manager successfully creates a template (despite the compilation errors), then continue processing with the template.

COBOL

Invoke the COBOL compiler to create a template from the copybook. (Do not invoke the PL/I compiler, even if the COBOL compilation results in errors.)

PLI

Invoke the PL/I compiler to create a template from the copybook. (Do not invoke the COBOL compiler, even if the PL/I compilation results in errors.)

HLASM

Invoke the HLASM compiler to create a template from the copybook.

DSINFO

Specifies whether additional data set information for input and output sources should be produced in batch reports for the DSP, DSM, DSC, and FCH commands.

NO

No additional data set information is generated.

YES

Generates data set information including DSORG, RECFM, LRECL, BLKSIZE, and VSAM attributes including average record length, maximum record length, key offset, key length and reuse, for input and output data sets when applicable.

COBOL options

The following options are used to compile a COBOL copybook into a template:

DBCS=YES

Use the DBCS compiler option.

DBCS=NO

Use the NODBCS compiler option.

For details on the effect of the DBCS and NODBCS compiler options, see the *IBM COBOL Programming Guide for OS/390 & VM*.

CDPC=NO

Do not use the COBOL SPECIAL-NAMES paragraph "Decimal-point is comma".

CDPC = YES

Use the COBOL SPECIAL-NAMES paragraph "Decimal-point is comma".

CAE=NO

Do not use the COBOL compile option ARITH(EXTEND).

CAE = YES

Use the COBOL compile option ARITH(EXTEND).

MIXED = NO

Field names stored in the template in uppercase.

MIXED = YES

Field names stored in the template in the original case as coded in the COBOL copybook.

RFROM1 RT01 ... RFROM5 RT05

Up to five pairs of “From” and “To” pseudo-text character strings for the COBOL REPLACE compiler-directing statement.

If your COBOL copybooks contain characters that you want to remove or replace with other characters before compiling the copybooks into templates, then use these replacing options.

For example, if your copybooks contain colon characters (:) that you want to remove before compiling, then specify '==:==' as *operand1* and '=====' as *operand2*.

For details on specifying “From” and “To” strings for COBOL REPLACE, see the *IBM COBOL Language Reference*.

CBLMAXRC

Sets the maximum acceptable return code for a copybook compile. A return code higher than the specified level causes the function to stop. Default is 4.



Note: The COMPMAXRC parameter is still supported but it is recommended that the CBLMAXRC parameter is used instead. If you do specify the COMPMAXRC parameter, it takes precedence over the language MAXRC.

CBLLIBS

Allows you to specify a list of up to ten data set names to be specified in the SYSLIB concatenation list. These data sets are searched in the order specified for COPY and INCLUDE members for the compilation.

dsname

The name of the data set name to be processed. Generic name masks are not allowed.

CBLADDOP

Additional COBOL compiler options which are included in a CBL statement when compiling COBOL copybooks.

PL/I options

The following options are used to compile a PL/I copybook into a template:

BIN63=YES

Use the LIMITS(FIXEDBIN(63)) compiler option.

BIN63=NO

Use the LIMITS(FIXEDBIN(31)) compiler option.

DEC31=YES

Use the LIMITS(FIXEDDEC(31)) compiler option.

DEC31=NO

Use the LIMITS(FIXEDDEC(15)) compiler option.

GRAPHIC=YES

Use the GRAPHIC compiler option.

GRAPHIC=NO

Use the NOGRAPHIC compiler option.

UNALIGNED=YES

Use the DEFAULT RANGE (*) UNALIGNED, language statement to change the default alignment.

UNALIGNED=NO

Use the PL/I default.

PLIMAXRC

Sets the maximum acceptable return code for a copybook compile. A return code higher than the specified level causes the function to stop. Default is 4.



Note: The COMPMAXRC parameter is still supported but it is recommended that the PLIMAXRC parameter is used instead. If you do specify the COMPMAXRC parameter, it takes precedence over the language MAXRC.

PLILIBS

Allows you to specify a list of up to ten data set names to be specified in the SYSLIB concatenation list. These data sets are searched in the order specified for COPY and INCLUDE members for the compilation.

dsname

The name of the data set name to be processed. Generic name masks are not allowed.

PLIADDOP

Additional PL/I compiler options which are included in a *PROCESS statement when compiling PL/I copybooks.

For details on the effect of these compiler options, see the *IBM VisualAge PL/I for OS/390 Programming Guide*.

HLASM options

The following options are used to compile a HLASM copybook into a template:

DBCS=YES

Use the DBCS compiler option.

DBCS=NO

Use the NODBCS compiler option.

NOALIGN=YES

Use the NOALIGN compiler option.

NOALIGN=NO

Use the ALIGN compiler option.

ASMMAXRC

Sets the maximum acceptable return code for a copybook compile. A return code higher than the specified level causes the function to stop. Default is 4.



Note: The COMPMAXRC parameter is still supported but it is recommended that the ASMMAXRC parameter is used instead. If you do specify the COMPMAXRC parameter, it takes precedence over the language MAXRC.

ASMLIBS

Allows you to specify a list of up to ten data set names to be specified in the SYSLIB concatenation list. These data sets are searched in the order specified for COPY and INCLUDE members for the compilation.

dsname

The name of the data set name to be processed. Generic name masks are not allowed.

ASMADDOP

Additional HLASM compiler options which are included in a *PROCESS statement when compiling COPY and MACRO members.

```
//DSG JOB (acct),'name' Create VSAM Data
//*
//FMBAT PROC
//FMBAT EXEC PGM=FILEMGR
//STEPLIB DD DSN=FMN.SFMNMOD1,DISP=SHR
//SYSPRINT DD SYSOUT=*
//SYSABEND DD SYSOUT=*
//SYSUDUMP DD SYSOUT=*
```

```

//          PEND
//*
//IDCPROC  PROC
//IDCAMS   EXEC PGM=IDCAMS
//SYSPRINT DD SYSOUT=*
//SYSABEND DD SYSOUT=*
//SYSUDUMP DD SYSOUT=*
//          PEND
//*
//* EXAMPLE DSG JOB
//* 17 RECORDS ARE WRITTEN TO A NONINDEXED
//* VSAM FILE. THE OUTPUT FILE CONTAINS
//* ALPHANUMERIC CHARACTERS.
//*
//DMBBV02  EXEC IDCPROC,REGION=6M
//SYSIN    DD *
DELETE FMNUSER.VSAM.DSG25 CLUSTER PURGE ERASE
DEFINE CLUSTER ( -
    NAME( FMNUSER.VSAM.DSG25 ) -
    CISZ(4096) -
    FREESPACE(30 30) -
    NONINDEXED -
    KEYS(12 0) -
    RECORDS(1000 100) -
    RECORDSIZE(234 234) -
    REUSE) -
    DATA( NAME(FMNUSER.VSAM.DSG25.DATA) )
/*
/*
//STP1005  EXEC FMBAT
//DDOUT   DD DISP=SHR,DSN=FMNUSER.VSAM.DSG25
//SYSIN    DD *
$$$FILEM VER
$$$FILEM DSG OUTPUT=DDOUT,REUSE=NO,NLRECS=17,
$$$FILEM RECSIZE=234,FILLCHAR=AN
$$$FILEM EOJ
/*

```

This example shows how to define a new data set set using a "model" data set (supports VSAM and non-VSAM data sets) and fill it with some data.

Note that the new data set is allocated based on the "model" data set as described by the LIKE parameter.

```

//STP1006 EXEC FMBAT
$$$FILEM DSG DSNOUT=TEST.BASE.NEW,
$$$FILEM LIKE='FMN.TEST.BASE.RFM0041.SEGMENT.PS',
$$$FILEM DISP=MOD,
$$$FILEM PACK=NONE,
$$$FILEM NLRECS=100
/*

```

DSI (Data Set Information)

Purpose

Display detailed dataset information.

Usage notes

Use this function to print the details about a data set. The data set information printed (returned) corresponds to the INFO primary command output for online processing. If the data set is migrated, File Manager recalls the data set to provide the required data set information.

Options

None.

Related functions**DSX**

Print disk dataset EXTENT information

DVT

Print VTOC entries

Figure 433. Syntax

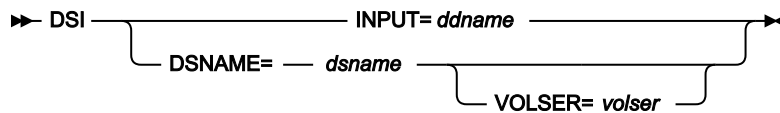
**ddname**

Refers to a DD or TSO ALLOC statement.

dsname

Name of a disk data set.

volser

Volume serial number for a non-cataloged data set.

```

//DP JOB (acct), 'name' Data Set Info
//*
//FMBAT PROC
//FMBAT EXEC PGM=FILEMGR
//STEPLIB DD DSN=FMN.SFMNMOD1,DISP=SHR
//SYSPRINT DD SYSOUT=*
//SYSABEND DD SYSOUT=*
//SYSUDUMP DD SYSOUT=* /
/ PEND
//*
//FILEMGR EXEC FMBAT
//DISK DD DSN=SYS1.PROCLIB,DISP=SHR
//SYSIN DD *
$$FILEM DSI INPUT=DISK
$$FILEM DSI DSN=SYS1.PROCLIB equivalent DSN use
$$FILEM EOJ
/*
  
```

DSM (Data Set Compare)

Purpose

Use the DSM function to:

- Compare data from any partitioned, sequential or VSAM data set, HFS file, MQ queue, or CICS® resource to data in any other partitioned, sequential or VSAM data set, HFS file, MQ queue, or CICS® resource.
- Perform a field level comparison. By using an "Old" copybook or template with a "New" copybook or template, you can compare selected fields with the result of the comparison reflecting the types of data in the fields.
- Perform a load module comparison. Load module and CSECT information from both the "Old" and "New" versions of the module is extracted and compared. By specifying compare criteria, you can see differences between specific properties of the load modules, such as load module size, link date, CSECT names, and compilers used.
- Produce a comparison report, showing information such as where insertions, deletions or changes have occurred in the "New" data set. The report's content and structure reflects the various comparison options used.
- Create output data sets containing records identified as inserted, deleted, old and new changed records, and old and new matched records.

You can define the same data set to save both the inserted and new changed records. Similarly, you can define the same data set to save both the deleted and old changed records.

Usage notes

- Select the records to be compared, using:
 - The start key (VSAM only)
 - The skip field
 - The compare count field
 - Conditional expressions defined in the "Old" and/or "New" templates.
 - The "Number of differences to report" option

To perform a field level comparison, you must provide an "Old" and a "New" copybook or template and use the TYPE=FORMATTED comparison option. You can use the field mapping specified in a "New" template (created online), or you can use the default mapping generated from the template or copybook contents, or you can specify the field mapping in the batch file, using the FIELDOLD and FIELDNEW keywords.

- Specify the way in which the comparison is performed, using:
 - The compare options
 - The synchronization options

If SYNCH=KEYED is used, up to sixteen key segments can be specified to create a single composite key.

- Specify the type of output produced and the way in which the output is displayed, using:
 - The listing type
 - The listing options
- To specify a field name containing lowercase or mixedcase characters, use the character literal form of the name surrounded by quotation marks and preceded with character C. For example, C'aBc'.

Performance tips

- DSM was designed with a focus on comparing data in fields using templates or copybooks. See the template performance tips in [General tips about performance when you use File Manager functions on page 1243](#).
- The ISPF utility SuperC may perform more efficiently when comparing ordinary text data sets, since the special features of File Manager are not required. For more details on SuperC, see the *z/OS ISPF User's Guide Vol II*.

Return codes

The default return codes from the DSM function have the following modified meanings:

0

The function was completed successfully and the compare sets match.

1

The function was completed successfully and the compare sets do not match.

2

One of the compare sets was empty, so no comparison was performed.

4

Both of the compare sets were empty, so no comparison was performed.

4

No comparison was performed because one of the input data sets or members in ISPF Packed Data format and the "PACK=SKIP" option was specified.

4

At least one record with an unmapped type was encountered.

8

A data error occurred, for example, a key sequence error was found when using a keyed comparison. The conditions that result in a return code of 8 are:

For keyed synchronization:

key truncation error

A key truncation error occurs when a key segment falls outside the record.

key sequence error

A key sequence error occurs when the key for a record is found to be less than or equal to the key for the previous record.

For read-ahead synchronization:

read-ahead resynchronization failure

Read-ahead resynchronization fails when matching records cannot be found within the read-ahead limit.

16

No records compared because input and output physically the same.

16

Invalid data in template.

16

Data set or member in use.

16

Data set or member open error.

16

Data set or member not found.

16

Other input or output error occurred.

16

Member name required and not specified.

16

Insufficient storage available.

16

DSM abended

16

Input data appears ISPF packed but is not valid.

16

Other serious error that stops processing occurred.

16

A severe error occurred, causing File Manager to terminate.

 **Tip:** When handling return codes 0, 1, 2, and 4 in your JCL, you might choose to deal with each code separately or you might choose to deal with return codes 0 and 4 as a single result (the compare sets match) and 1 and 2 as another result (the compare sets do not match).

 **Note:** Return codes can be customized during installation. If you receive return codes that do not match those listed above, your site might have customized the return codes for this function. File Manager may also issue the 999 abend, if the return code in batch is equal to or greater than the ABENDCC value. Contact your File Manager systems administrator for details.

Figure 434. Syntax



Old data set

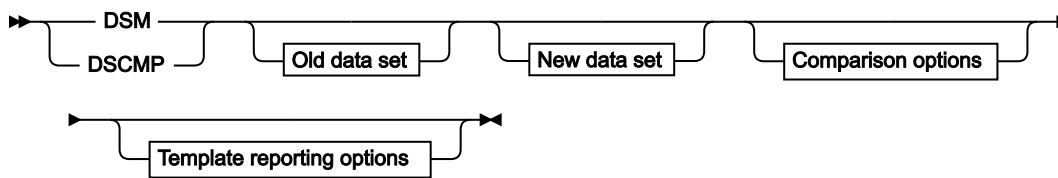
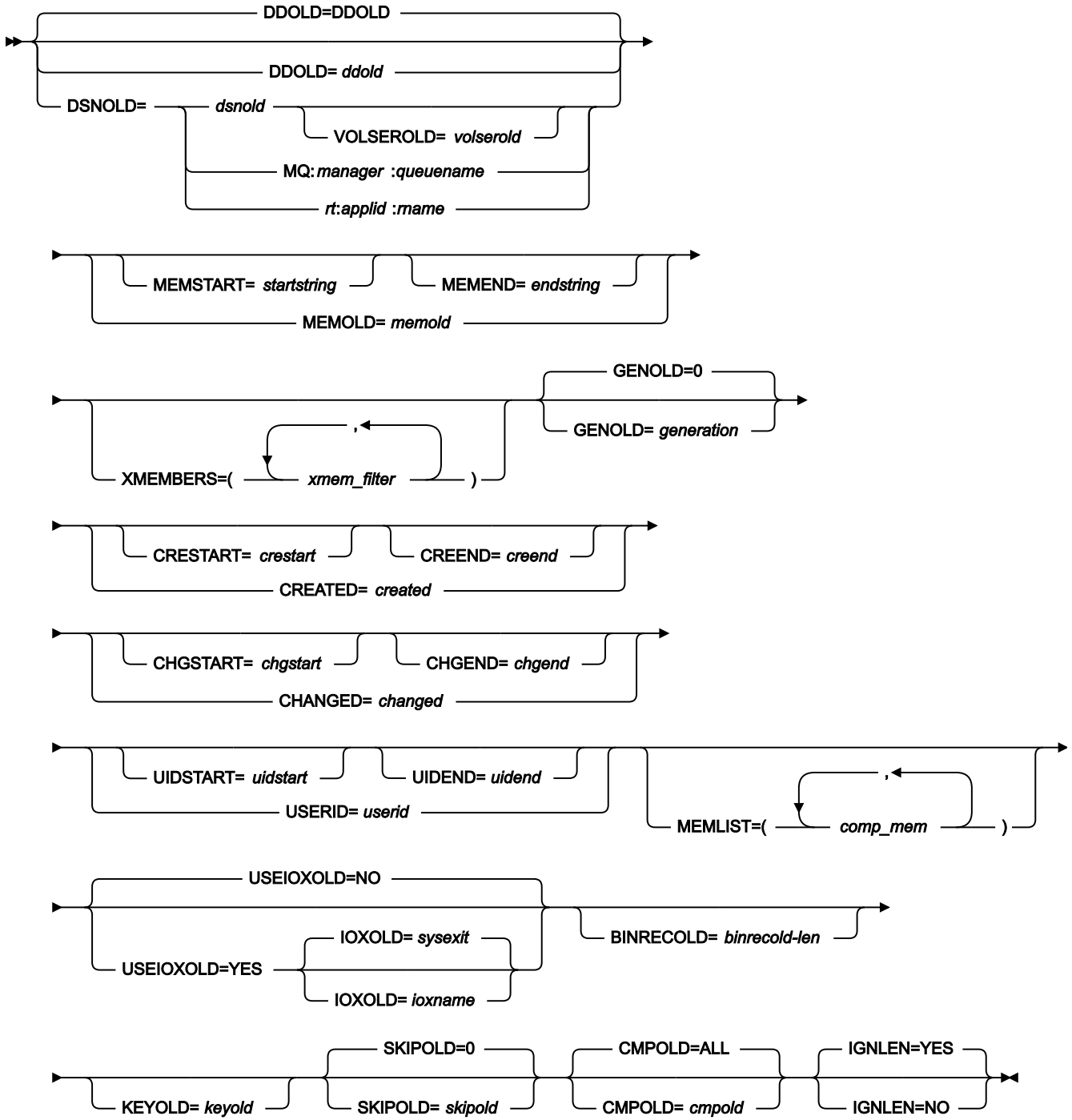

Old template processing

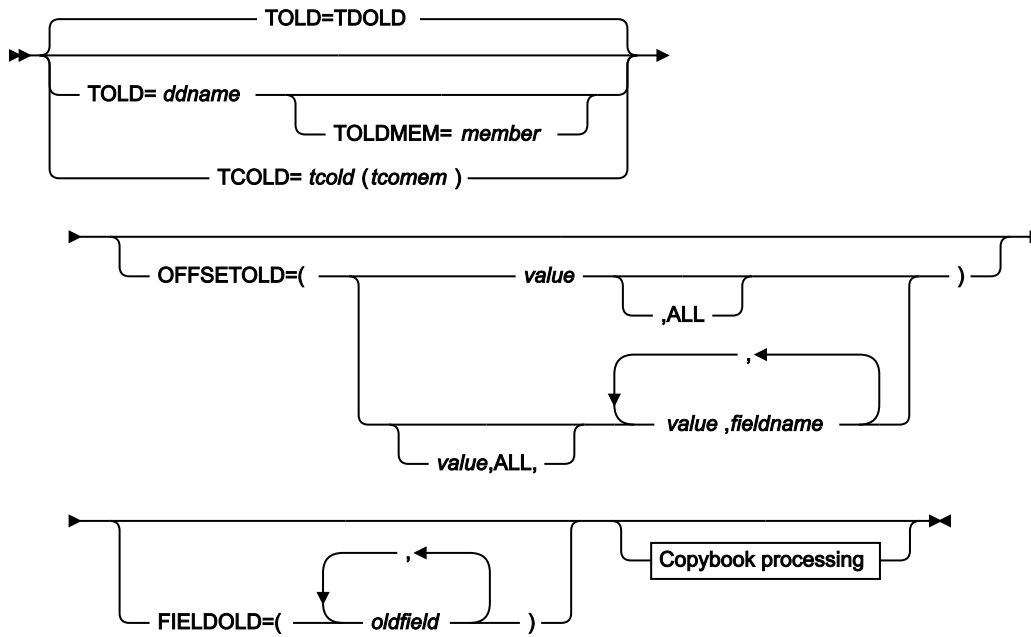

New data set

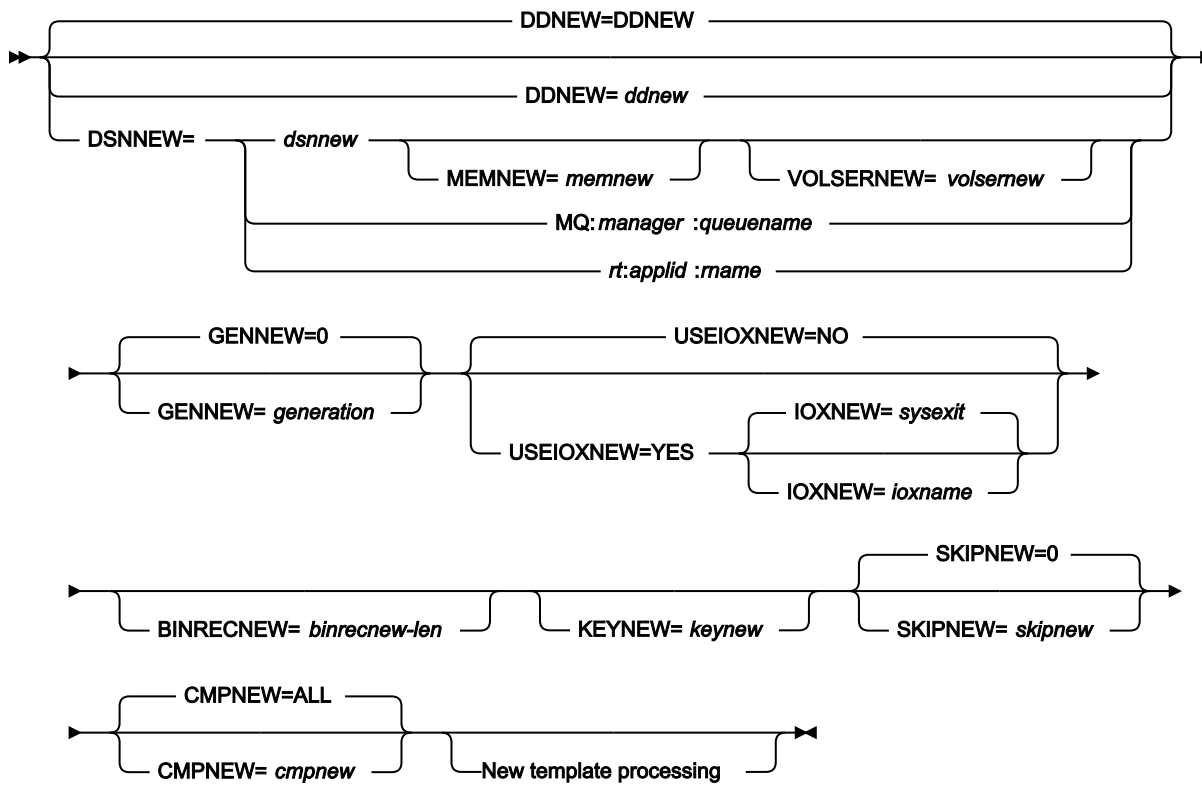

New template processing

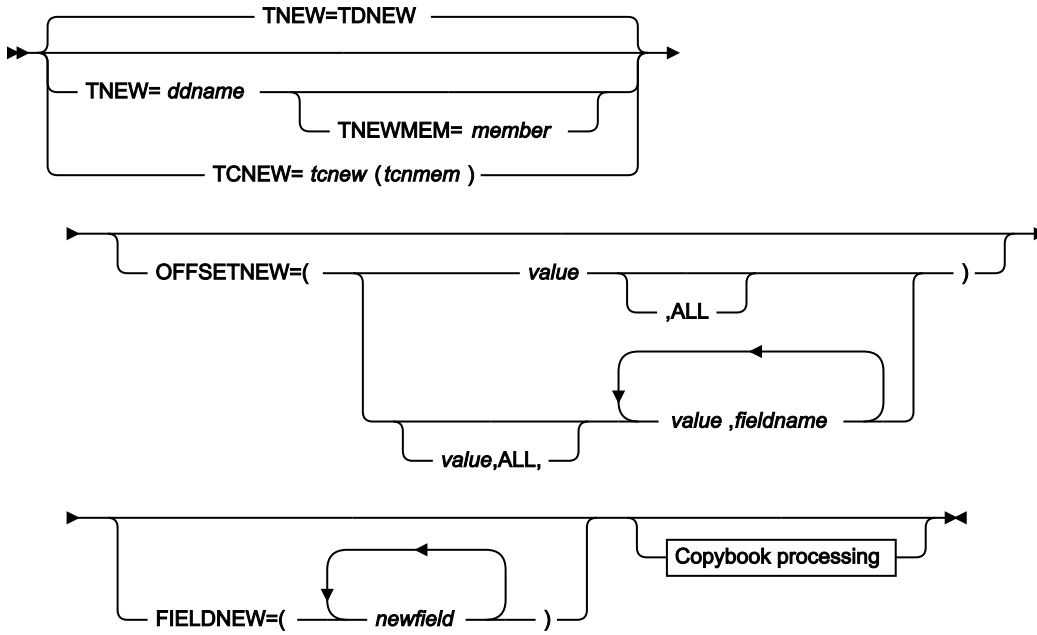

Copybook processing

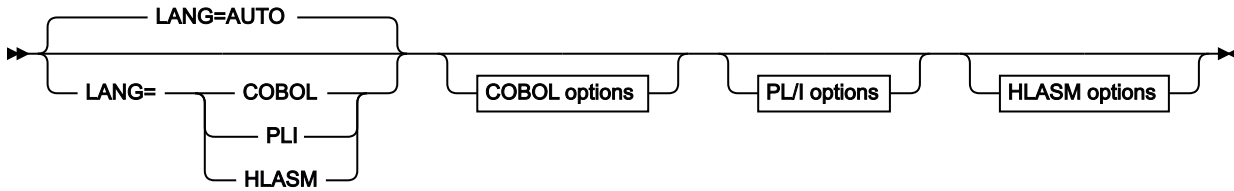

COBOL options

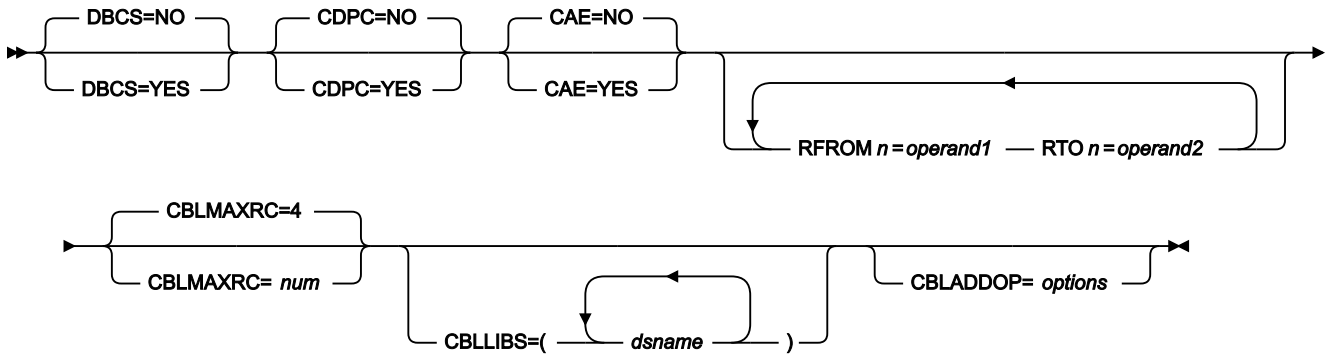

PL/I options

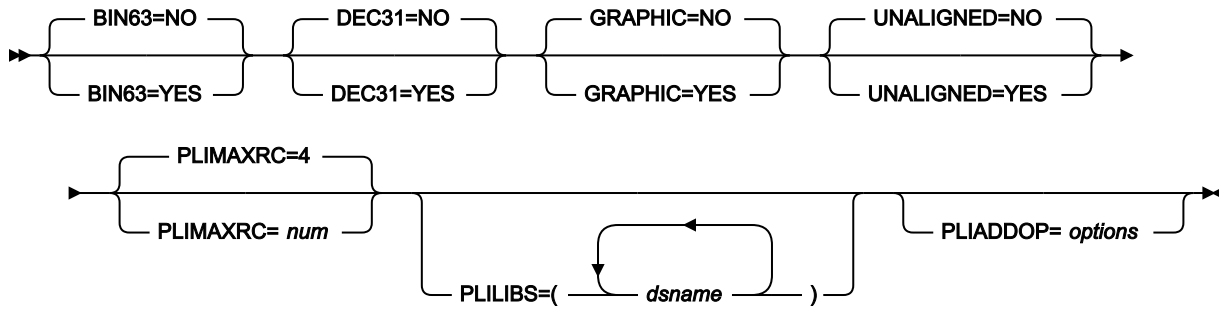

HLASM options

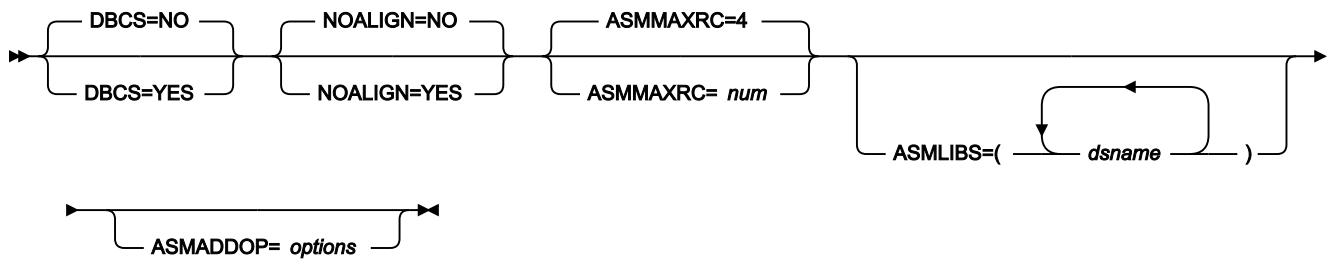

Comparison options

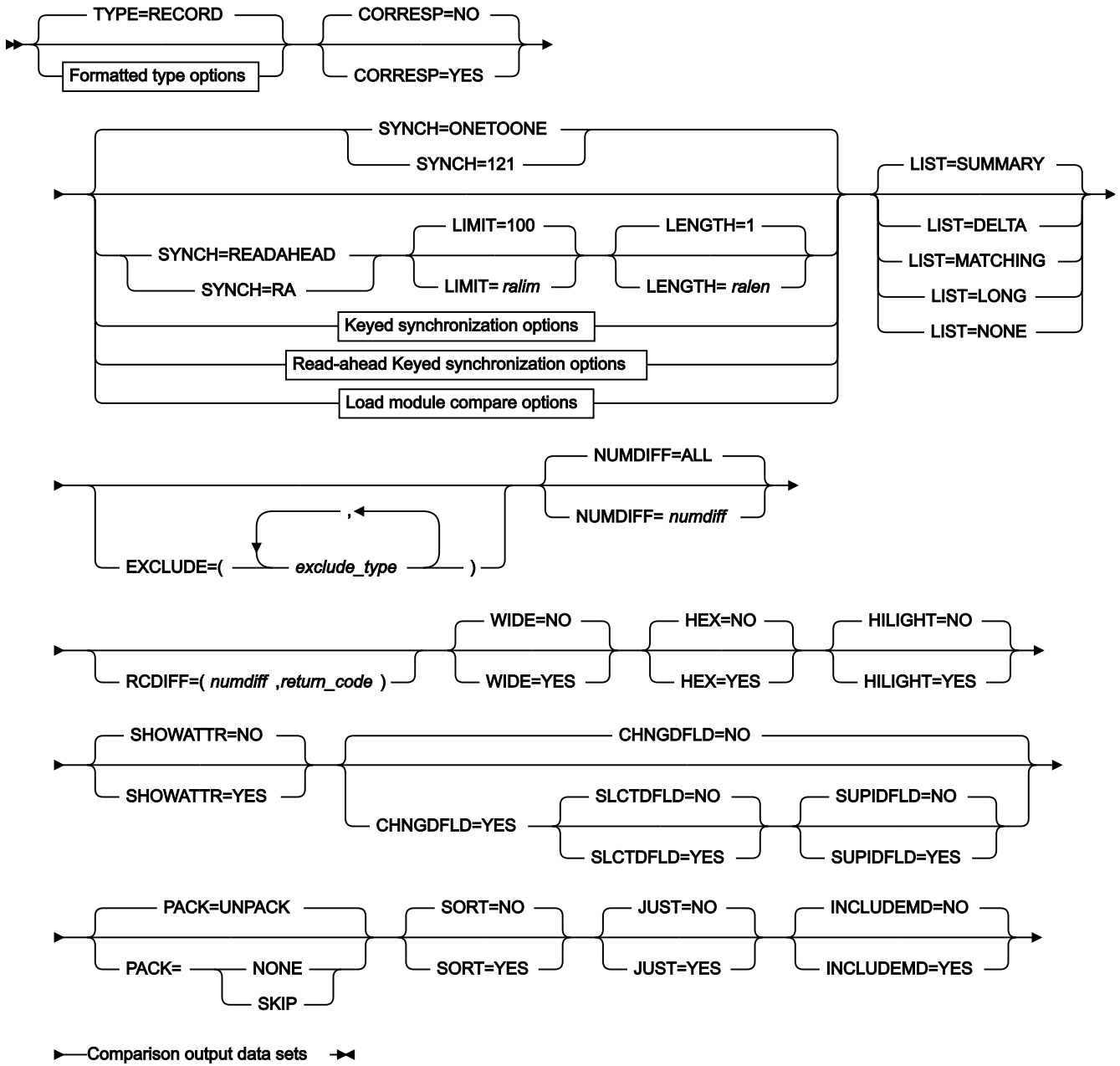

Comparison output data sets

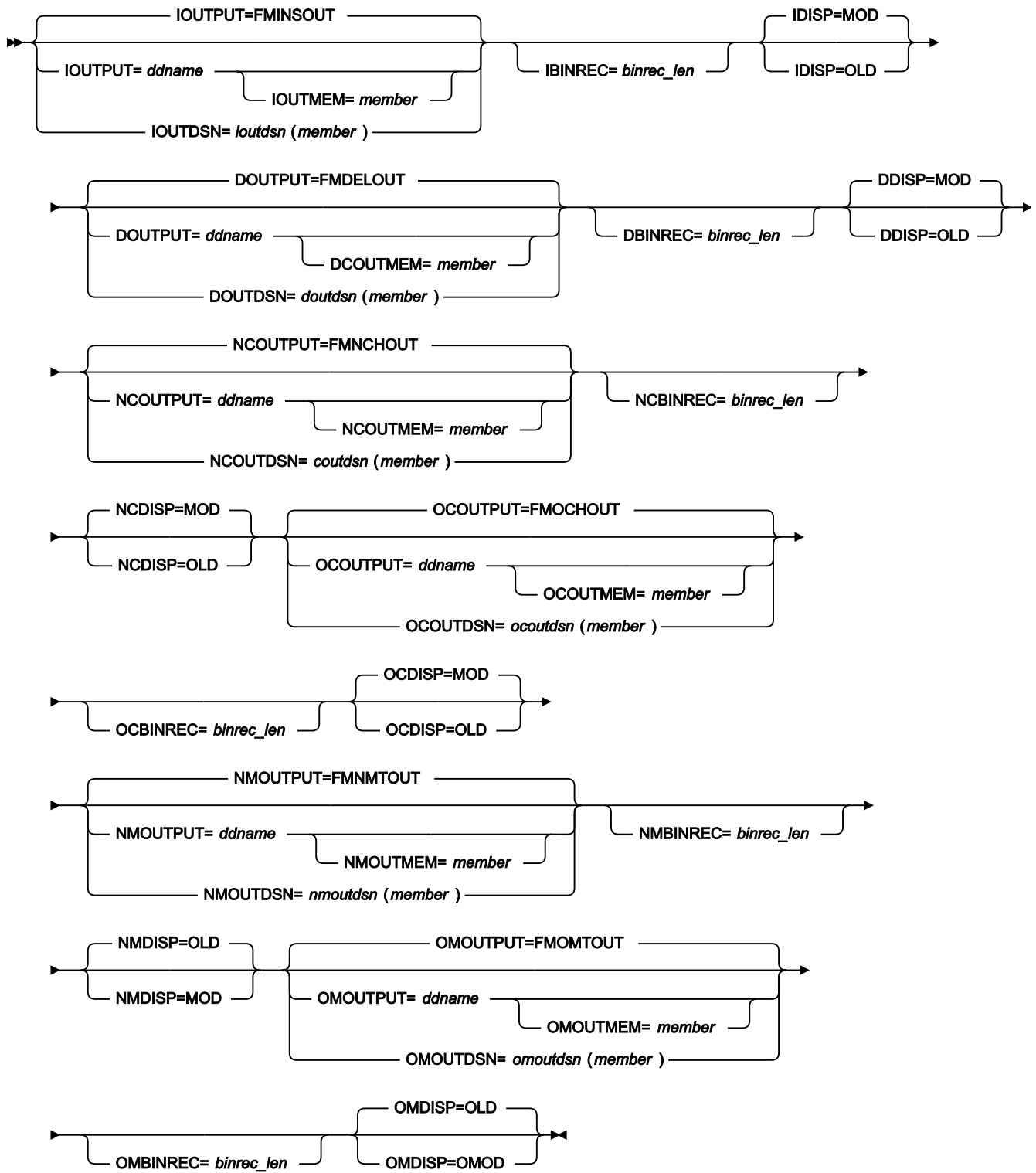

Formatted type options

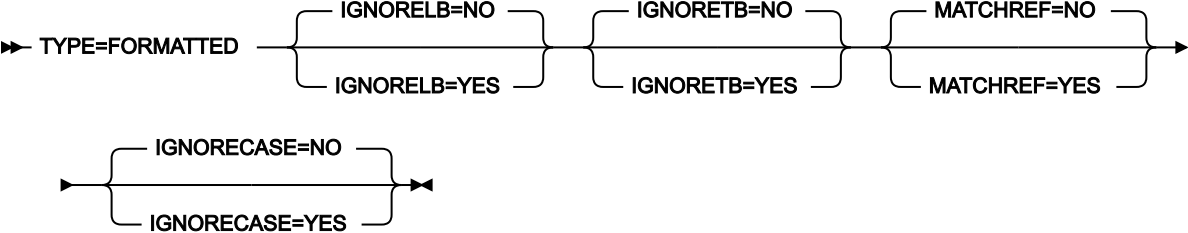

Keyed synchronization options

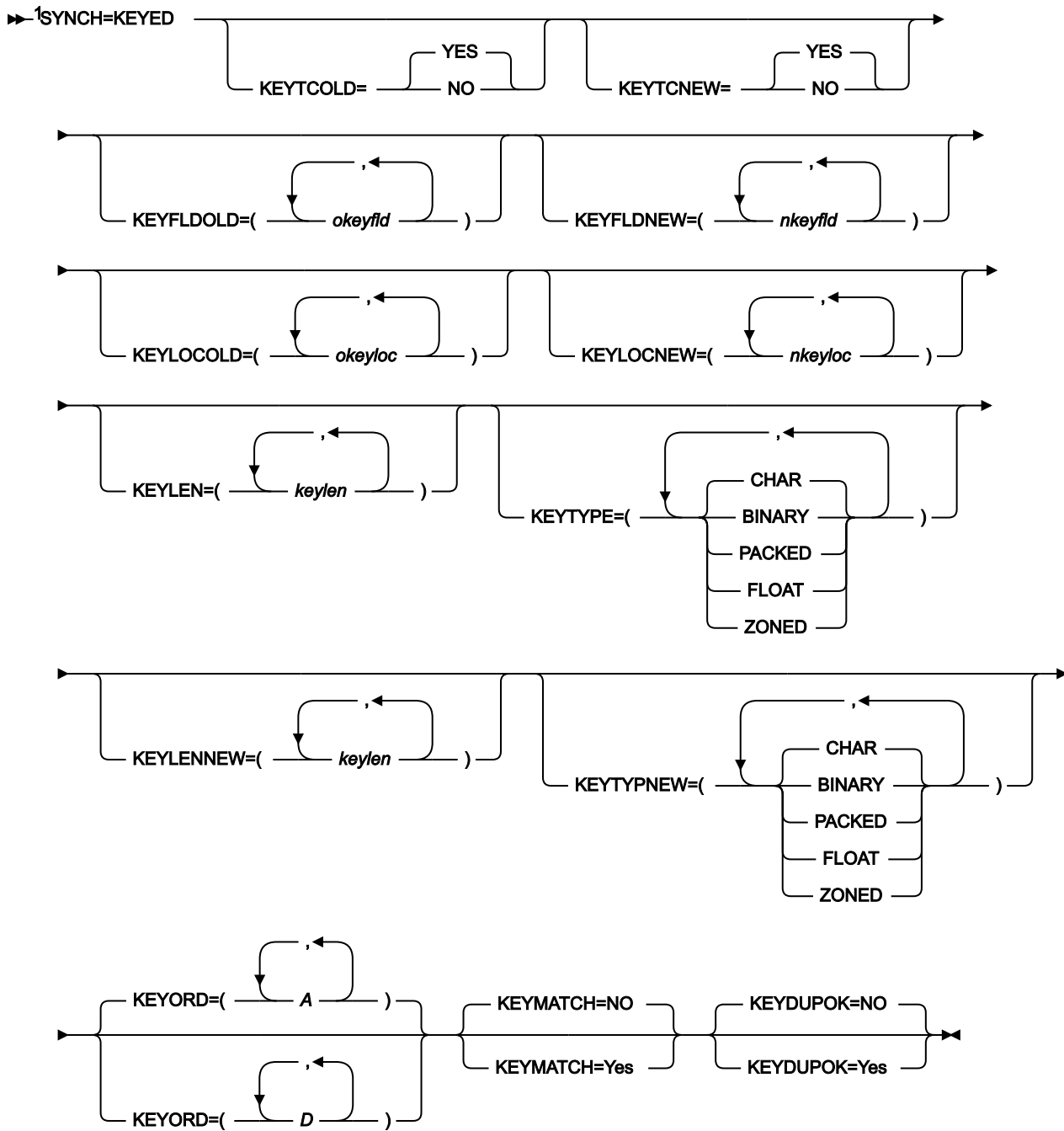

Notes:

¹ All of the following keywords are shown as optional in the syntax, but in practice the actual requirements are dependent on a number of factors, as described in the SYNCH=KEYED definition below the syntax diagram.

Read-ahead Keyed synchronization options

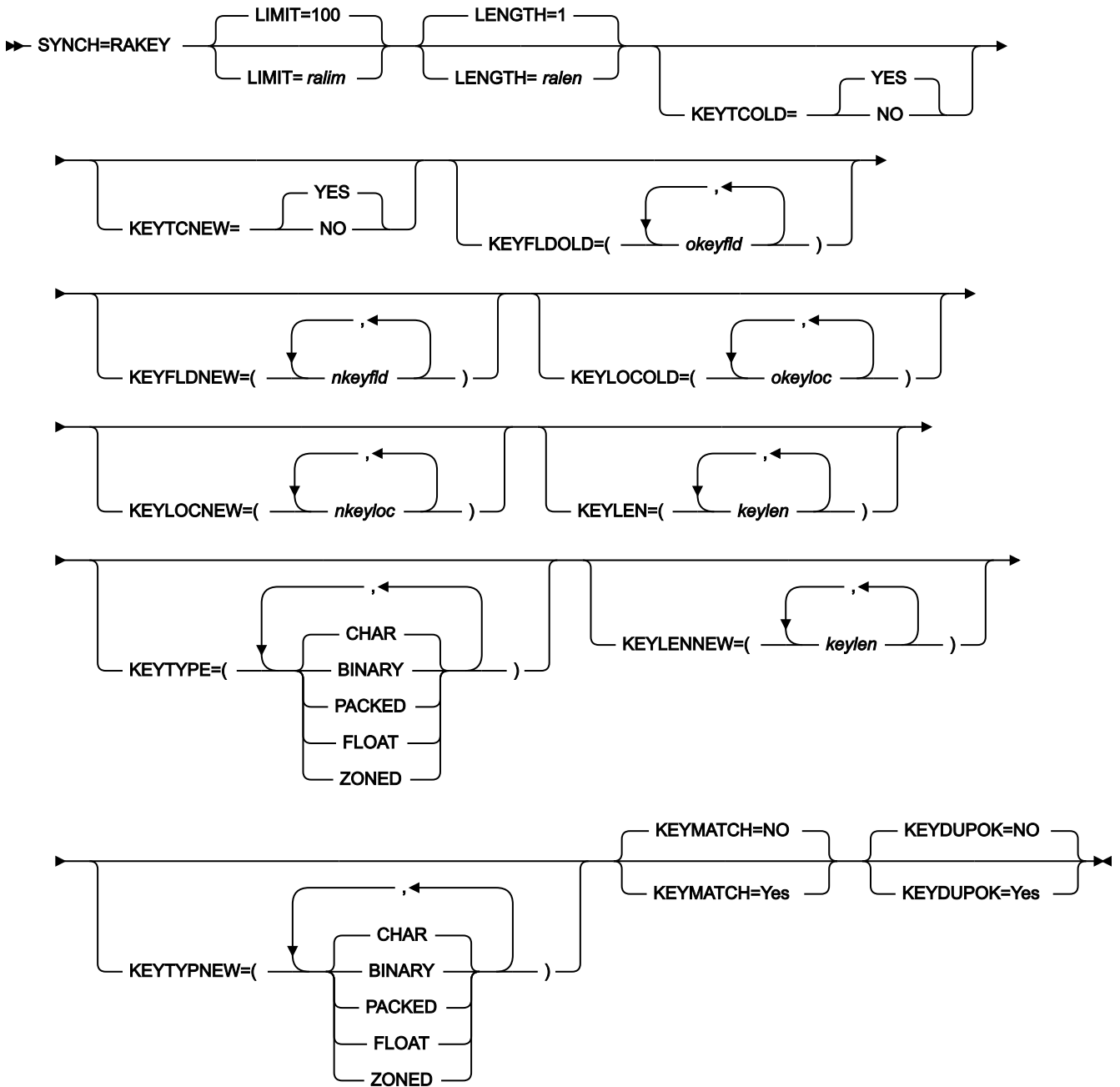

Template reporting options

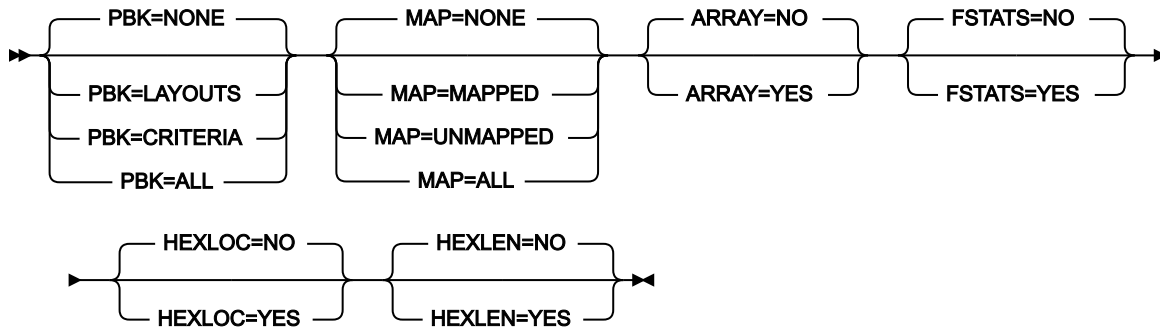

Load module compare options

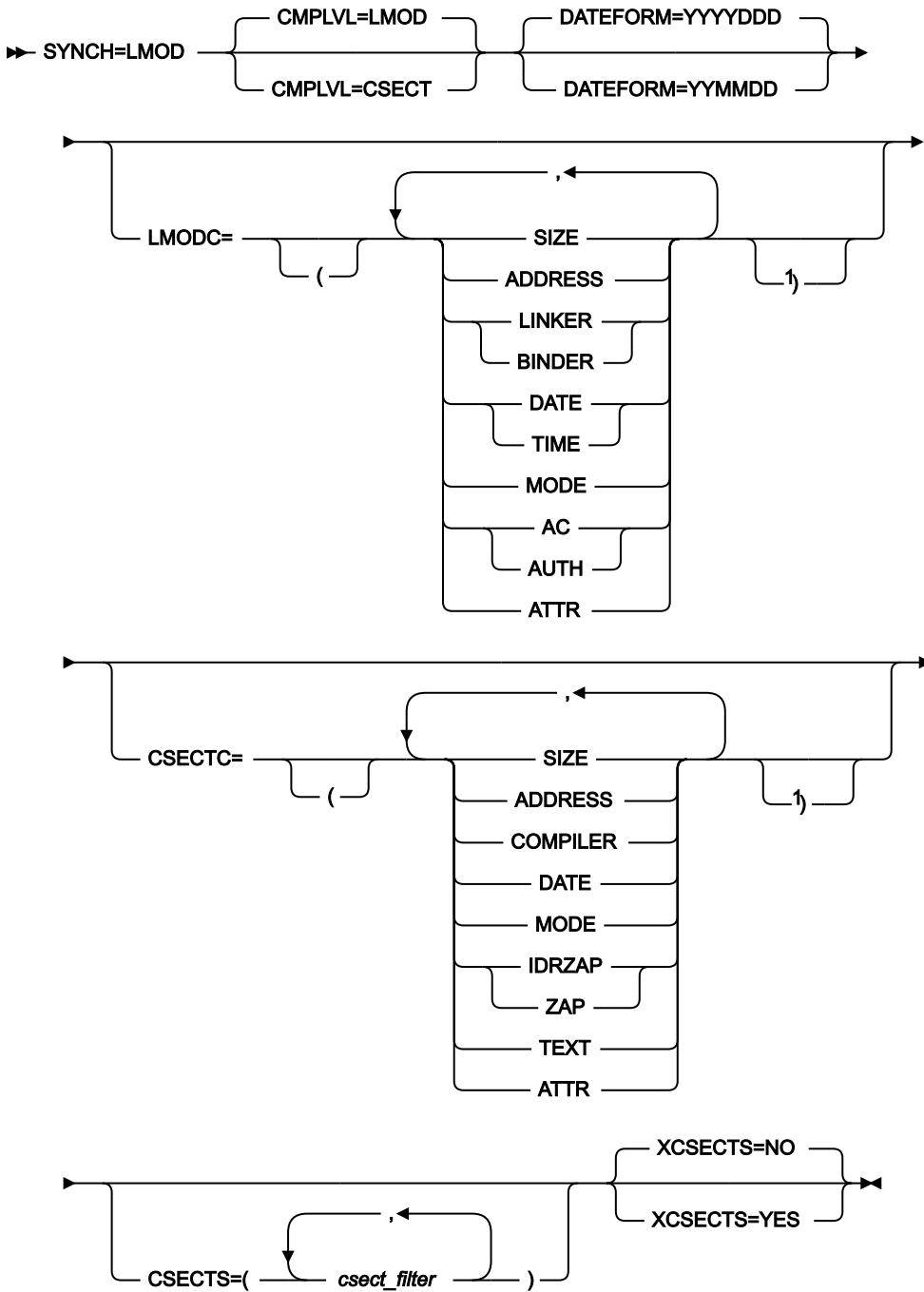

Notes:

¹ Provide closing bracket when opening bracket has been used.

Old data set specifications

The "Old" data set can be specified as follows:

DDOLD=*ddold*

Defines a reference to a DD or TSO ALLOC statement for the “Old” data set or HFS file. The default is DDOLD.

DSNOLD=*dsnold*

Defines the name of the “Old” data set or an absolute path to the “*Old*” HFS file. If any DD statements are specified, they are not used. The name may include a member name in parenthesis. If the member is specified here, the associated MEMOLD parameter must be empty. An absolute path to an HFS file must be enclosed in apostrophes. If it does not fit on one line, you can split it over more than one line. To further describe the data set, use the following:

VOLSEROLD=*volserold*

The VOLUME serial number for a non-cataloged “Old” data set.

MEMOLD=*memold*

The name of a single member in a PDS, or a member name pattern representing one or more members in a PDS library. You can specify this parameter, or a member name in the DD statement for *ddname*, or specify a member or members in the MEMLIST parameter, or specify a range of member names with the MEMSTART and MEMEND keywords.

A member name pattern can consist of any characters that are valid in a member name, and two special pattern characters: the asterisk (*) and the percent symbol (%).

An * represents any number of characters. As many asterisks as required can appear anywhere in a member name pattern. For example, if you enter a member name pattern of *d*, all members in the PDS whose name contains “d” are processed.

A % is a place-holding character that represents a single character. As many percent symbols as necessary can appear anywhere in a member name pattern. For example, if you enter a member name pattern of %%%%, all members in the PDS with a 4-character name are processed.

MEMOLD is ignored if the data set is not a PDS.

MEMSTART=*startstring*

Is used to specify the start of a range of member names to be included in the compare. If MEMSTART is specified but MEMEND is omitted, all members of the PDS(E) from the *startstring* value onwards are included. *startstring* can have the same values, including wild cards, as for the *memold* parameter of the MEMOLD keyword.

MEMEND=*endstring*

Is used to specify the end of a range of member names to be included in the compare. If MEMEND is specified but MEMSTART is omitted, all members of the PDS(E) up to the *endstring* value onwards are included. *endstring* can have the same values, including wild cards, as for the *memold* parameter of the MEMOLD keyword.

XMEMBERS

Provides a way to exclude from processing library members that would otherwise be selected using the MEMSTART, MEMEND, and MEMBER options.

xmem_filter

A member name filter identifying one or more members that are to be excluded from processing. A filter can be a member name pattern representing multiple members.

To specify a member name filter containing lowercase characters, use a character string in the format `c'string'`. Filter values can also be specified as hexadecimal strings in the format `x'hex-digits'`.

MQ:manager.queueName

You can specify a MQ queue in place of a data set name, where:

managerold

The "Old" MQ manager to be used. If you specify a generic name, File Manager displays a list of matching managers to select from.

queueNameold

The "Old" queue to be used. If you specify a generic name, File Manager displays a list of matching queues to select from.

rt.applid:rname

You can specify a CICS® resource in place of a data set name, where:

rt

Resource type. Valid values are:

FI

For a CICS® file.

TD

For a Transient Data Queue.

TS

For a Temporary Storage Queue.

applid

The VTAM® applid of the CICS® system.

rname

The name of the resource.

GENOLD=*generation*

Specifies the generation of the old member to be compared. A value of 0 refers to the current member. A negative value refers to the relative generation number. A positive value refers the absolute generation number.

 **Tip:** The GENOLD and GENNEW keywords can be used to compare different generations of the same member in the same data set.

If the input data set is not a PDSE that supports member generations, the GENOLD keyword is ignored.

CREATED=*created*

The date on which a member was created, in YYYY/MM/DD format.

If the “Old” data set is a PDS(E), you can specify this parameter, or specify a range of creation dates with the CRESTART and CREEND keywords.

You can specify an asterisk (*) as the last character to indicate a range of dates, or a percent sign (%) in place of a single character to indicate a selection of dates.

created is ignored if the data set is not a PDS.

CRESTART=*crestart*

The start of a range of creation dates in YYYY/MM/DD format to be included in the compare.

If CRESTART is specified but CREEND is omitted, all members of the PDS(E) from the *crestart* value onwards are included.

If omitted, or you do not enter a full date, or you specify an asterisk (*) as the last character, the unspecified portion of *crestart* defaults to the right as follows:

DD

= 01

MM

= 01

YYYY

= 0000

No other wildcarding is allowed.

CREEND=*creend*

The end of a range of creation dates in YYYY/MM/DD format to be included in the compare.

If omitted, or you do not enter a full date, or you specify an asterisk (*) as the last character, the unspecified portion of *creend* defaults to the right as follows:

DD

= 31

MM

= 12

YYYY

= 9999

No other wildcarding is allowed.

CHANGED=*changed*

The date on which a member was last modified, in YYYY/MM/DD format.

If the "Old" data set is a PDS(E), you can specify this parameter, or specify a range of modification dates with the CHGSTART and CHGENDD keywords.

You can specify an asterisk (*) as the last character to indicate a range of dates, or a percent sign (%) in place of a single character to indicate a selection of dates.

changed is ignored if the data set is not a PDS.

CHGSTART=*chgstart*

The start of a range of modification dates in YYYY/MM/DD format to be included in the compare.

If CHGSTART is specified but CHGENDD is omitted, all members of the PDS(E) from the *chgstart* value onwards are included.

If omitted, or you do not enter a full date, or you specify an asterisk (*) as the last character, the unspecified portion of *chgstart* defaults to the right as follows:

DD

= 01

MM

= 01

YYYY

= 0000

No other wildcarding is allowed.

CHGENDD=*chgend*

The end of a range of modification dates in YYYY/MM/DD format to be included in the compare.

If omitted, or you do not enter a full date, or you specify an asterisk (*) as the last character, the unspecified portion of *chgend* defaults to the right as follows:

DD

= 31

MM

= 12

YYYY

= 9999

No other wildcarding is allowed.

USERID=*userid*

The TSO user ID by which the member was last updated.

If the “Old” data set is a PDS(E), you can specify this parameter, or specify a range of user IDs with the UIDSTART and UIDEND keywords.

You can enter a generic user ID by using asterisks and percent signs.

userid is ignored if the data set is not a PDS.

UIDSTART=*uidstart*

The start of a range of user IDs to be included in the compare.

If UIDSTART is specified but UIDEND is omitted, all members of the PDS(E) from the *uidstart* value onwards are included.

If omitted, or you do not enter a full 7-character user ID, or you specify an asterisk (*) as the last character, File Manager replaces the asterisk and pads the unspecified portion of *uidstart* to the right with low values (X'00').

UIDEND=*uidend*

The end of a range of user IDs to be included in the compare.

If you omit this field, it defaults to high values (X'FF').

If you specify less than 7 characters (without an asterisk as the last character), File Manager pads *uidstart* to the right with low values (X'00'). If you specify an asterisk (*) as the last character, File Manager replaces the asterisk and pads the unspecified portion of *uidend* with high values (X'FF').

MEMLIST

Provides a means of selecting members from a PDS where no generic name pattern and no member name range has been specified. If the MEMLIST keyword is specified, only those members included in the MEMLIST arguments are compared with the corresponding members in the output data set. Members selected by the MEMBER=*memold* that are not included in the MEMLIST arguments are not compared.

comp_mem

The name of the member to be compared. Generic name masks are not allowed.

USEIOXOLD

Specifies whether to invoke a user I/O exit, to process the "Old" data set.

NO

Default. Do not invoke a user I/O exit.

YES

Invoke a user I/O exit to process the "Old" data set. This option is only available if the person who did the site customization for File Manager allowed user I/O exits on a site-wide basis.

IOXOLD

Specifies the name of the user I/O exit used for the "Old" data set. There are no restrictions on the programming language that you can use to write an exit. The exit must be provided to File Manager in the STEPLIB/ISPLLIB concatenation or their extensions (LINKLIST, LPA, and so on).

sysexit

Default. If you specify USEIOXOLD=YES and do not supply a user I/O exit name, File Manager uses the name of the exit provided in the installation customization options. If USEIOXOLD has been set to YES and no installation default has been provided, you must specify IOXOLD=*ioxname*.



Note: If you have selected batch processing in an online panel, the generated JCL statements use the default name provided in your Set System Processing Options panel.

ioxname

The name of a PDS(E) member of a data set that has been provided to File Manager in the STEPLIB concatenation.

BINRECOLD=*binrecold-len*

Specifies the record length used for processing the "Old" HFS file. Valid range: 1 to 32760.

The file is processed in Binary mode (fixed-length records derived from the file, delimiters not distinguished). If you do not specify this parameter, the file is processed in Text mode (variable-length records, boundaries determined by delimiters).

KEYOLD=*keyold*

A key for KSDS records or a slot number for RRDS records, for the "Old" data set. The maximum key length is 30 characters. The first record with a key or slot value greater than or equal to *key* is

the first record compared. If you omit the *keyold* and *skipold* values, the comparison begins with the first record in the data set.

If the key contains lowercase characters, blanks, or commas, enclose it in quotation marks. You can also specify a key in hexadecimal format (for example, X'C1C2C3').

SKIPOLD=*skipold*

Number of logical records to be skipped from the beginning of the "Old" data set. The default is 0.

CMPOLD=*cmpold*

Number of records from the "Old" data set to be compared. The maximum number is 999 999 999. If you specify ALL or omit the parameter, all the remaining records are compared.

IGNLEN

Specifies whether or not File Manager ignores length mismatches when selecting records for processing.

NO

Do not ignore length mismatches. Records that are shorter than the matching structure length in the template are not selected for processing.

YES

Use this option to ignore length mismatches.

Old template processing

Use these options to specify the "Old" copybook or template that describes the record structure of your "Old" data set.

TOLD=*ddname*

Defines a reference to a DD or TSO ALLOC statement for the data sets which contain the copybook or template that describes the record structure of your "Old" data set. The default is TDOLD.

If you specify a concatenated DD, then you must provide the member name, *member*.

TOLDMEM=*member*

The name of the copybook or template member in the datasets identified by the TOLD parameter if it has not been specified on the DD statement. This parameter must not be specified if the TCOLD parameter is specified.

TCOLD=*tcold(tcmem)*

PDS and member name of the "Old" copybook or template that describes the record structure of your "Old" data set.

OFFSETOLD

The length of the 01 field in the “Old” template and the start locations of the fields within that 01 field are adjusted by the value provided.

value

The offset value, which must be in the range -32760 to 32760, to be applied to the corresponding field identifier. If no field identifier is supplied and ALL is not used, the value is applied to the first Level 01 field in the “Old” template.

ALL

Where the template contains multiple record structures, this keyword applies the corresponding *value* to all Level 01 fields within the “Old” template.



Note: You can specify a value for ALL and then override this value for individual layouts by providing subsequent *value* and *fieldname* combinations.

fieldname

The name of the Level 01 field to which *value* is to be applied. The default is the first Level 01 field in the “Old” template.

FIELDOLD=(*oldfield1,oldfield2,...*)

Field name or names in the “Old” template, used to create a mapping for a formatted comparison. This keyword is used in conjunction with the FIELDNEW keyword to define mapping within the batch file. The parentheses are optional when only one field is specified but mandatory when more than one field is included. The names are mapped in the order given, that is, *oldfield1* is mapped to *newfield1* and so on, overriding any default or existing mapping.

FIELDOLD and FIELDNEW can be used with or without an existing mapping in the template and with or without the CORRESP keyword setting, as follows:

Table 25. Batch mapping behavior

Specifications			Behavior
“New” template contains mapping?	CORRESP=?	FIELDxxx specified?	
no	NO	no	map corresponding fields
		yes	map specified fields
	YES	no	map corresponding fields

Table 25. Batch mapping behavior

(continued)

Specifications			Behavior
“New” template contains mapping?	CORRESP=?	FIELDxxx specified?	
		yes	map corresponding fields then remap specified fields
yes	NO	no	use mapping in TCNEW template
		yes	use mapping in TCNEW template then remap specified fields
	YES	no	map corresponding fields
		yes	map corresponding fields then remap specified fields



Note: “Specified fields” refers to those fields specified in the FIELDOLD and FIELDNEW arguments.

Handling multiple 01s and duplicate field names

Field mapping specifications that are created via the FIELDOLD and FIELDNEW keywords are applied on a first match basis. For example, if the “Old” template came from a copybook containing:

```
01 OLD-TYPE01.
03 BINARY-X          PIC 999999999 USAGE BINARY.
01 OLD-TYPE02.
03 BINARY-1          PIC 999999999 USAGE BINARY.
01 OLD-TYPE03.
03 BINARY-1          PIC 999999999 USAGE BINARY.
```

and the “New” template came from a copybook containing:

```
01 NEW-TYPE01.
03 BINARY-2          PIC 999999999 USAGE BINARY.
01 NEW-TYPE02.
03 BINARY-2          PIC 999999999 USAGE BINARY.
05 DUP-FIELD.
07 BINARY-2          PIC 999999999 USAGE BINARY.
01 NEW-TYPE03.
03 BINARY-2          PIC 999999999 USAGE BINARY.
```

a mapping specification of:

```
$$$FILEM FIELDOLD=BINARY-1,
$$$FILEM FIELDNEW=BINARY-2,
```

maps the 03 BINARY-2 field in NEW-TYPE02 to the BINARY-1 field in OLD-TYPE02. This is because the 03 BINARY-2 field in NEW-TYPE02 is the first “New” template field found named BINARY-2, where the corresponding 01-level, OLD-TYPE02, contains a field called BINARY-1. The 03 BINARY-2 field in NEW-TYPE01 is not mapped because the corresponding 01-level, OLD-TYPE01, does not contain a 03 BINARY-1 field.

You can override this default behavior to specify different field mappings by using a dot qualification. For example,

```
$$$FILEM FIELDOLD=BINARY-1,
$$$FILEM FIELDNEW=DUPFIELD.BINARY-2,
```

would map the 07 BINARY-2 field in NEW-TYPE02 to the BINARY-1 field in OLD-TYPE02.

```
$$$FILEM FIELDOLD=BINARY-1,
$$$FILEM FIELDNEW=NEW-TYPE03.BINARY-2,
```

would map the 03 BINARY-2 field in NEW-TYPE03 to the BINARY-1 field in OLD-TYPE03.



Note:

1. This only affects the mapping. Normal record identification procedures must be understood and employed to ensure the correct 01 is in effect for each record comparison.
2. The qualifiers are resolved from left to right, skipping over levels not present in the qualification so that only enough information to uniquely identify a field need be provided.

New data set specifications

The “New” data set can be specified as follows:

DDNEW=ddnew

Defines a reference to a DD or TSO ALLOC statement for the “New” data set or HFS file. The default is DDNEW.

DSNNEW=dsnnew

Defines the name of the “New” data set or an absolute path to the “New” HFS file. If any DD statements are specified, they are not used. The name may include a member name in parenthesis. If the member is specified here, the associated MEMNEW parameter must be empty. An absolute path to an HFS file (directory) must be enclosed in apostrophes. If it does not fit on one line, you can split it over more than one line. To further describe the data set, use the following:

VOLSERNEW=volsernew

The VOLUME serial number for a non-cataloged “New” data set.

MEMNEW=memnew

The name of a single member in a PDS library, or a member name pattern representing one or more members in the library. You can specify this parameter, or a member name in the DD statement for *ddname*.

A member name pattern can consist of any characters that are valid in a member name, and two special pattern characters: the asterisk (*) and the percent symbol (%).

An * represents any number of characters. As many asterisks as required can appear anywhere in a member name pattern. For example, if you enter a member name pattern of *d*, all members in the library whose name contains "d" are processed.

A % is a place holding character that means a single character. As many percent symbols as necessary can appear anywhere in a member name pattern. For example, if you enter a member name pattern of %%%%, all members in the library with a 4-character name are processed.

Specification of MEMNEW (or a member in DSNNEW) depends on the parameters used in MEMOLD (or member used in DSNOLD). If MEMOLD (member in DSNOLD) specifies one member, MEMNEW (member in DSNNEW) must also point at one member. If MEMOLD (member in DSNOLD) contains a member name pattern, the specification of MEMNEW (member in DSNNEW) must use the same pattern or an "*".

MEMNEW is ignored if the data set is not a PDS.

MQ:manager.queueName

You can specify a MQ queue in place of a data set name, where:

managernew

The "New" MQ manager to be used. If you specify a generic name, File Manager displays a list of matching managers to select from.

queuenameNew

The "New" queue to be used. If you specify a generic name, File Manager displays a list of matching queues to select from.

rt:applid:rname

You can specify a CICS® resource in place of a data set name, where:

rt

Resource type. Valid values are:

FI

For a CICS® file.

TD

For a Transient Data Queue.

TS

For a Temporary Storage Queue.

applid

The VTAM® applid of the CICS® system.

rname

The name of the resource.

GENNEW=*generation*

Specifies the generation of the new member to be compared. A value of 0 refers to the current member. A negative value refers to the relative generation number. A positive value refers the absolute generation number.



Tip: The GENOLD and GENNEW keywords can be used to compare different generations of the same member in the same data set.

If the input data set is not a PDSE that supports member generations, the GENNEW keyword is ignored.

USEIOXNEW

Specifies whether to invoke a user I/O exit, to process the “New” data set.

NO

Default. Do not invoke a user I/O exit.

YES

Invoke a user I/O exit to process the “New” data set. This option is only available if the person who did the site customization for File Manager allowed user I/O exits on a site-wide basis.

IOXNEW

Specifies the name of the user I/O exit used for the “New” data set. There are no restrictions on the programming language that you can use to write an exit. The exit must be provided to File Manager in the STEPLIB/ISPLLIB concatenation or their extensions (LINKLIST, LPA, and so on).

sysexit

Default. If you specify USEIOXNEW=YES and do not supply a user I/O exit name, File Manager uses the name of the exit provided in the installation customization options. If USEIOXNEW has been set to YES and no installation default has been provided, you must specify IOXNEW=*ioxname*.



Note: If you have selected batch processing in an online panel, the generated JCL statements use the default name provided in your Set System Processing Options panel.

ioxname

The name of a PDS(E) member of a data set that has been provided to File Manager in the STEPLIB concatenation.

BINRECNEW=*binrecnew-len*

Specifies the record length used for processing the “New” HFS file. Valid range: 1 to 32760.

The file is processed in Binary mode (fixed-length records derived from the file, delimiters not distinguished). If you do not specify this parameter, the file is processed in Text mode (variable-length records, boundaries determined by delimiters).

KEYNEW=*keynew*

A key for KSDS records or a slot number for RRDS records, for the “New” data set. The maximum key length is 30 characters. The first record with a key or slot value greater than or equal to *key* is the first record compared. If you omit the *keynew* and *skipnew* values, the comparison begins with the first record in the data set.

If the key contains lowercase characters, blanks, or commas, enclose it in quotation marks. You can also specify a key in hexadecimal format (for example, X'C1C2C3').

SKIPNEW=*skipnew*

Number of logical records to be skipped from the beginning of the “New” data set. The default is 0.

CMPNEW=*cmpnew*

Number of records from the “New” data set to be compared. The maximum number is 999 999 999. If you specify ALL or omit the parameter, all the remaining records are compared.

New template processing

Use these options to specify the “New” copybook or template that describes the record structure of your “New” data set.

TNEW=*ddname*

Defines a reference to a DD or TSO ALLOC statement for the data sets which contain the copybook or template member that describes the record structure of your “New” data set. The default is TDNEW.

If you specify a concatenated DD, then you must provide the member name, *member*.

TNEWMEM=member

The name of the copybook or template member in the datasets identified by the TNEW parameter if it has not been specified on the DD statement. This parameter must not be specified if the TCNEW parameter is specified.

TCNEW=tcnew(tcnmemb)

PDS and member name of the "New" copybook or template that describes the record structure of your "New" data set.

OFFSETNEW

The length of the 01 field in the "New" template and the start locations of the fields within that 01 field are adjusted by the value provided.

value

The offset value, which must be in the range -32760 to 32760, to be applied to the corresponding field identifier. If no field identifier is supplied and ALL is not used, the value is applied to the first Level 01 field in the "New" template.

ALL

Where the template contains multiple record structures, this keyword applies the corresponding *value* to all Level 01 fields within the "New" template.



Note: You can specify a value for ALL and then override this value for individual layouts by providing subsequent *value* and *fieldname* combinations.

fieldname

The name of the Level 01 field to which *value* is to be applied. The default is the first Level 01 field in the "New" template.

FIELDNEW=(newfield1,newfield2,...)

Field name or names in the "New" template, used to create a mapping for a formatted comparison. This keyword is used in conjunction with the FIELDOLD keyword to define mapping within the batch file. The parentheses are optional when only one field is specified but mandatory when more than one field is included. The names are mapped in the order given, that is, *oldfield1* is mapped to *newfield1* and so on, overriding any default or existing mapping.

FIELDOLD and FIELDNEW can be used with or without an existing mapping in the template and with or without the CORRESP keyword setting. See [Table 25: Batch mapping behavior on page 1410](#) for details.

Copybook processing

If you specify a copybook (instead of an existing template) for either TCOLD or TCNEW, then File Manager uses these processing options to compile the copybook into a template:

LANG

Determines whether File Manager automatically detects the copybook language or interprets the language as COBOL, PL/I, or HLASM.



Note: The COMPLANG setting in FMN0POPT is the equivalent of the LANG parameter in batch functions.

- If COMPLANG is set it determines the installation default language for online and batch compilation.
- If COMPLANG is not specified then COBOL is the installation default for online compilation and AUTO is the default for batch compilation.
- If a value of COBOL, HLASM, PL/1, or AUTO is specified (in the **Compiler Language Selection** panel or through the LANG parameter in a batch job) it overrides the default language.

AUTO

Automatically detect whether the copybook language is COBOL or PL/I, and invoke the appropriate compiler. If the compilation results in a return code greater than 4, then invoke the compiler for the other language. If the second compilation also results in a return code greater than 4, then retry the first compiler and report the compilation errors. If File Manager successfully creates a template (despite the compilation errors), then continue processing with the template.

COBOL

Invoke the COBOL compiler to create a template from the copybook. (Do not invoke the PL/I compiler, even if the COBOL compilation results in errors.)

PLI

Invoke the PL/I compiler to create a template from the copybook. (Do not invoke the COBOL compiler, even if the PL/I compilation results in errors.)

HLASM

Invoke the HLASM compiler to create a template from the copybook.

COBOL options

The following options are used to compile a COBOL copybook into a template:

DBCS=YES

Use the DBCS compiler option.

DBCS=NO

Use the NODBCS compiler option.

For details on the effect of the DBCS and NODBCS compiler options, see the *IBM COBOL Programming Guide for OS/390 & VM*.

CDPC=NO

Do not use the COBOL SPECIAL-NAMES paragraph "Decimal-point is comma".

CDPC = YES

Use the COBOL SPECIAL-NAMES paragraph "Decimal-point is comma".

CAE=NO

Do not use the COBOL compile option ARITH(EXTEND).

CAE = YES

Use the COBOL compile option ARITH(EXTEND).

MIXED = NO

Field names stored in the template in uppercase.

MIXED = YES

Field names stored in the template in the original case as coded in the COBOL copybook.

RFROM1=RT01 ... RFROM5=RT05

Up to five pairs of "From" and "To" pseudo-text character strings for the COBOL REPLACE compiler-directing statement.

If your COBOL copybooks contain characters that you want to remove or replace with other characters before compiling the copybooks into templates, then use these replacing options.

For example, if your copybooks contain colon characters (:) that you want to remove before compiling, then specify '==:==' as *operand1* and '=====' as *operand2*.

For details on specifying "From" and "To" strings for COBOL REPLACE, see the *IBM COBOL Language Reference*.

CBLMAXRC

Sets the maximum acceptable return code for a copybook compile. A return code higher than the specified level causes the function to stop. Default is 4.



Note: The COMPMAXRC parameter is still supported but it is recommended that the CBLMAXRC parameter is used instead. If you do specify the COMPMAXRC parameter, it takes precedence over the language MAXRC.

CBLLIBS

Allows you to specify a list of up to ten data set names to be specified in the SYSLIB concatenation list. These data sets are searched in the order specified for COPY and INCLUDE members for the compilation.

dsname

The name of the data set name to be processed. Generic name masks are not allowed.

CBLADDOP

Additional COBOL compiler options which are included in a CBL statement when compiling COBOL copybooks.

PL/I options

The following options are used to compile a PL/I copybook into a template:

BIN63=YES

Use the LIMITS(FIXEDBIN(63)) compiler option.

BIN63=NO

Use the LIMITS(FIXEDBIN(31)) compiler option.

DEC31=YES

Use the LIMITS(FIXEDDEC(31)) compiler option.

DEC31=NO

Use the LIMITS(FIXEDDEC(15)) compiler option.

GRAPHIC=YES

Use the GRAPHIC compiler option.

GRAPHIC=NO

Use the NOGRAPHIC compiler option.

UNALIGNED=YES

Use the DEFAULT RANGE (*) UNALIGNED, language statement to change the default alignment.

UNALIGNED=NO

Use the PL/I default.

PLIMAXRC

Sets the maximum acceptable return code for a copybook compile. A return code higher than the specified level causes the function to stop. Default is 4.



Note: The COMPMAXRC parameter is still supported but it is recommended that the PLIMAXRC parameter is used instead. If you do specify the COMPMAXRC parameter, it takes precedence over the language MAXRC.

PLILIBS

Allows you to specify a list of up to ten data set names to be specified in the SYSLIB concatenation list. These data sets are searched in the order specified for COPY and INCLUDE members for the compilation.

dsname

The name of the data set name to be processed. Generic name masks are not allowed.

PLIADDOP

Additional PL/I compiler options which are included in a *PROCESS statement when compiling PL/I copybooks.

For details on the effect of these compiler options, see the *IBM VisualAge PL/I for OS/390 Programming Guide*.

HLASM options

The following options are used to compile a HLASM copybook into a template:

DBCS=YES

Use the DBCS compiler option.

DBCS=NO

Use the NODBCS compiler option.

NOALIGN=YES

Use the NOALIGN compiler option.

NOALIGN=NO

Use the ALIGN compiler option.

ASMMAXRC

Sets the maximum acceptable return code for a copybook compile. A return code higher than the specified level causes the function to stop. Default is 4.



Note: The COMPMAXRC parameter is still supported but it is recommended that the ASMMAXRC parameter is used instead. If you do specify the COMPMAXRC parameter, it takes precedence over the language MAXRC.

ASMLIBS

Allows you to specify a list of up to ten data set names to be specified in the SYSLIB concatenation list. These data sets are searched in the order specified for COPY and INCLUDE members for the compilation.

dsname

The name of the data set name to be processed. Generic name masks are not allowed.

ASMADDOP

Additional HLASM compiler options which are included in a *PROCESS statement when compiling COPY and MACRO members.

For details on the effect of these compiler options, see the *HLASM V1R6 Programmer's Guide*.



Note: You cannot specify different options for compiling “Old” and “New” copybooks; the same copybook options are used for both.

Comparison options

TYPE=RECORD

Record comparison.

CORRESP=NO

Use this option if the field mapping you want to use is in the TCNEW member. If the TCNEW member is a copybook, or no field mapping is supplied, then File Manager ignores this option and performs a compare as if you had specified CORRESP=YES.

CORRESP=YES

This option instructs File Manager to map output fields to input fields with the corresponding name.

If you want to use the existing mapping in the “New” template, specify CORRESP=NO.

SYNCH=ONETOONE

One-to-one synchronization.

SYNCH=READAHEAD

Read-ahead synchronization. If specified, you can use the following option:

LIMIT=ralim

Limit for read-ahead synchronization.

LENGTH=ralen

The number of records that must match during read-ahead processing for synchronization to occur.

LIST=SUMMARY

Summary listing.

LIST=DELTA

Delta listing.

LIST=MATCHING

Matching listing.

LIST=LONG

Long listing.

LIST=NONE

No listing.

Listing Options

The following option takes effect if the LIST=LONG parameter is specified:

EXCLUDE=exclude_type

The specified compare result types are not reported.

exclude_type can have the following values:

INSERTED

Excludes inserted records from the report.

DELETED

Excludes deleted records from the report.

CHANGED

Excludes changed records from the report.

MATCHED

Excludes matched records from the report.

The following options take effect if the LIST keyword is not specified (that is, it defaults to SUMMARY) or is set to anything other than NONE:

NUMDIFF=numdiff

The number of differences after which the Compare Utility stops processing the data sets. A *numdiff* value of zero results in all differences being reported.

RCDIFF=(*numdiff*,*return_code*)

Sets the batch return code when a threshold of changes has been met, where:

numdiff

The minimum number of differences to trigger the return code. A *numdiff* value of zero always trigger the return code.

return_code

The batch return code value that is set if the number of differences have been detected.

WIDE=NO

Narrow listing.

WIDE=YES

Wide listing. The WIDE listing is limited in width to approximately 32K bytes of (record) data. When working with records longer than 32K, the record data, and optional change highlighting, is truncated past 32K bytes of data because of the SYSPRINT output record limitation. The entire record length is used to perform the comparison so records are marked correctly as "changed" regardless of length.

HEX=NO

No hex formatting.

HEX=YES

Show hex formatting.



Note: The print processing option, DUMP, is ignored and the hexadecimal print output is in updown format.

HILIGHT=NO

No highlighting of changed fields.

HILIGHT=YES

Highlight changed fields.



Note: For SYNCH=READAHEAD this option has no effect because read-ahead synchronization can only produce matched records and inserted/deleted records. By definition there cannot be changed records.

SHOWATTR=NO

Suppress attribute information in headings (affects formatted comparisons only).

SHOWATTR=YES

Show attribute information in headings (affects formatted comparisons only).

CHNGDFLD=NO

Show all fields in the formatted comparison reports.

CHNGDFLD=YES

Show only changed fields in formatted comparison reports. This option has no effect if the 'Wide listing' (**WIDE=YES**) option has been selected, for record type comparisons, or for SYNCH=READAHEAD.

SLCTDFLD=NO

Fields selected in the template are not shown in addition to changed fields. This option has effect only if CHNGDFLD=YES is also specified.

SLCTDFLD=YES

Fields selected in the template are always shown. This option takes effect only if CHNGDFLD=YES is also specified.

SUPIDFLD=NO

Fields for inserted and deleted records are printed. This option takes effect only if CHNGDFLD=YES is also specified.

SUPIDFLD=YES

Fields for inserted and deleted records are suppressed. This option takes effect only if CHNGDFLD=YES is also specified.

PACK=UNPACK

Allow detection of ISPF packed data and unpack the records if they are packed before passing to the processing routine or printing.

JUST=NO

Do not left-justify numeric fields if Formatted Compare Type option has been selected.

JUST=YES

Left-justify numeric fields if Formatted Compare Type option has been selected.

SORT=NO

Do not sort the old and new data sets before the records are compared.

SORT=YES

Sort the records in the old and new data sets before they are compared. This option is only valid when the SYNCH=KEYED or SYNCH=RAKEY options are used. The records are sorted based on the old and new key field or key location, length and type values specified with the keyed synchronization options.

A sort request is ignored if the old or new data set has any of the following characteristics:

- RECFM=U
- VSAM linear file
- VSAM file with maximum record length greater than 32K
- QSAM spanned file with a record length greater than 32K
- The template indicates that the file has segmented records
- PDS or PDSE file

A sort request is also ignored when any of the following conditions is true:

- I/O exits are used to process the data sets
- The comparison involves MQ queues
- The comparison involves remote files
- The comparison involves HFS files



Note: Using PDS or PDSE files with SORT=YES is possible when the data sets are allocated to DD names that are specified using the DDOLD and DDNEW DSM parameters.

INCLUDEMD

This parameter determines what happens to the descriptor for an Websphere MQ message.

YES

The descriptor is added as a prefix as the data is compared.

NO

Just the message data is compared. This is the default.

This parameter applies only when the input describes an MQ queue.

PACK=SKIP

Check for ISPF packed data and if packed, skip processing of this data set or member.

Comparison output data sets

IOUTPUT=*ddname*

Defines a reference to a DD or TSO ALLOC statement for the data set or HFS file the "inserted" records are to be written to.

IOUTMEM=*member*

The name of the member in the dataset identified by the COUPTPUT parameter if it has not been specified on the DD statement.

IOUTDSN=*ioutdsn(member)*

The name of the output data set, or an absolute path to the output HFS file, the "inserted" records are to be written to. The name can include a member name in parenthesis.

An absolute path to an HFS file (directory) must be enclosed in apostrophes. If it does not fit on one line, you can split it over more than one line.

IBINREC=*binrec_len*

Specifies the record length to be used for processing the inserted HFS output data set. Valid range is 1–32760. The file is processed in binary mode. If you do not specify this parameter, the file is processed in text mode.

IDISP=MOD

Writes inserted records to the existing output data set, starting from the beginning.

IDISP=OLD

Appends inserted records to the existing output data set.

DOUTPUT=*ddname*

Defines a reference to a DD or TSO ALLOC statement for the data set or HFS file the "deleted" records are to be written to.

DOUTMEM=*member*

The name of the member in the dataset identified by the COUTPUT parameter if it has not been specified on the DD statement.

DOUTDSN=*doutdsn(member)*

The name of the output data set, or an absolute path to the output HFS file, the "deleted" records are to be written to. The name can include a member name in parenthesis.

An absolute path to an HFS file (directory) must be enclosed in apostrophes. If it does not fit on one line, you can split it over more than one line.

DBINREC=*binrec_len*

Specifies the record length to be used for processing the deleted HFS output data set. Valid range is 1–32760. The file is processed in binary mode. If you do not specify this parameter, the file is processed in text mode.

DDISP=MOD

Writes deleted records to the existing output data set, starting from the beginning.

DDISP=OLD

Appends deleted records to the existing output data set.

NCOUTPUT=ddname

Defines a reference to a DD or TSO ALLOC statement for the data set or HFS file the new "changed" records are to be written to. The default is FMNCHOUT.

NCOUTMEM=member

The name of the member in the dataset identified by the NCOUTPUT parameter if it has not been specified on the DD statement.

NCOUTDSN=ncoutdsn(member)

The name of the output data set, or an absolute path to the output HFS file, the new "changed" records are to be written to. The name can include a member name in parenthesis.

An absolute path to an HFS file (directory) must be enclosed in apostrophes. If it does not fit on one line, you can split it over more than one line.

NCBINREC=binrec_len

Specifies the record length to be used for processing the New Change HFS output data set. Valid range is 1–32760. The file is processed in binary mode. If you do not specify this parameter, the file is processed in text mode.

NCDISP=MOD

Writes new changed records to the existing output data set, starting from the beginning.

NCDISP=OLD

Appends new changed records to the existing output data set.

OCOUTPUT=ddname

Defines a reference to a DD or TSO ALLOC statement for the data set or HFS file the new "changed" records are to be written to. The default is FMOCHOUT.

OCOUTMEM=member

The name of the member in the dataset identified by the OCOUTPUT parameter if it has not been specified on the DD statement.

OCOUTDSN=ocoutdsn(member)

The name of the output data set, or an absolute path to the output HFS file, the old "changed" records are to be written to. The name can include a member name in parenthesis.

An absolute path to an HFS file (directory) must be enclosed in apostrophes. If it does not fit on one line, you can split it over more than one line.

OCBINREC=binrec_len

Specifies the record length to be used for processing the New Change HFS output data set. Valid range is 1–32760. The file is processed in binary mode. If you do not specify this parameter, the file is processed in text mode.

OCDISP=MOD

Writes old changed records to the existing output data set, starting from the beginning.

OCDISP=OLD

Appends old changed records to the existing output data set.

NMOUTPUT=*ddname*

Defines a reference to a DD or TSO ALLOC statement for the data set or HFS file the new "matched" records are to be written to. The default is FMNMTOUT.

NMOUTMEM=*member*

The name of the member in the dataset identified by the COUTPUT parameter if it has not been specified on the DD statement.

NMOUTDSN=*nmoutdsn(member)*

The name of the output data set, or an absolute path to the matched HFS file, the new "matched" records are to be written to. The name can include a member name in parenthesis.

An absolute path to an HFS file (directory) must be enclosed in apostrophes. If it does not fit on one line, you can split it over more than one line.

NMBINREC=*binrec_len*

Specifies the record length to be used for processing the new matched HFS output data set. Valid range is 1–32760. The file is processed in binary mode. If you do not specify this parameter, the file is processed in text mode.

NMDISP=MOD

Writes new matched records to the existing output data set, starting from the beginning.

NMDISP=OLD

Appends new matched records to the existing output data set.

OMOUTPUT=*ddname*

Defines a reference to a DD or TSO ALLOC statement for the data set or HFS file the old "matched" records are to be written to. The default is FMOMTOUT.

OMOUTMEM=*member*

The name of the member in the dataset identified by the COUTPUT parameter if it has not been specified on the DD statement.

OMOUTDSN=*omoutdsn(member)*

The name of the output data set, or an absolute path to the matched HFS file, the old "matched" records are to be written to. The name can include a member name in parenthesis.

An absolute path to an HFS file (directory) must be enclosed in apostrophes. If it does not fit on one line, you can split it over more than one line.

OMBINREC=binrec_len

Specifies the record length to be used for processing the old matched HFS output data set. Valid range is 1–32760. The file is processed in binary mode. If you do not specify this parameter, the file is processed in text mode.

OMDISP=MOD

Writes old matched records to the existing output data set, starting from the beginning.

OMDISP=OLD

Appends old matched records to the existing output data set.

Formatted type options

If you specify TYPE=FORMATTED, for a formatted comparison, you can use the following options:

IGNORELB=NO

Respect leading blanks when comparing alphanumeric fields.

IGNORELB=YES

Ignore leading blanks when comparing alphanumeric fields.

IGNORETB=NO

Respect trailing blanks when comparing alphanumeric fields.

IGNORETB=YES

Ignore trailing blanks when comparing alphanumeric fields.

MATCHREF=NO

Ignore leading blanks (unless IGNORELB=NO is also specified), trailing blanks (unless IGNORETB=YES also specified) and embedded blanks when comparing alphanumeric fields.

MATCHREF=YES

Respect leading blanks, trailing blanks and embedded blanks when comparing alphanumeric fields.



Note: Any setting of IGNORELB or IGNORETB is ignored if MATCHREF=YES is also specified.

IGNORECASE=NO

Respect case when comparing alphanumeric fields.

IGNORECASE=YES

Ignore case when comparing alphanumeric fields.

Keyed synchronization options

If you specify SYNCH=KEYED, you are requesting keyed synchronization.

If specified, you can define up to sixteen key segments to be concatenated to form a single key. A key segment consists of the key's location in the "Old" and "New" data sets and the key's length and data type. These values are built using one of the following sources or a combination of these elements:

- The intrinsic data set keys (where the data set is keyed, for example, VSAM KSDS).

If only one of the data sets is keyed, the location and length values for the first segment is initialized from the available data set key information, and the keywords corresponding to the initialized values are not required. However, you need to supply the location value and, optionally, the data type for the non-keyed data set. If you do not specify the data type, the default type of AN is used.

If both data sets are keyed, you do not need to supply any of the keywords and the location values is initialized from the data set key. The length value is that of the shorter of the two keys.

If used in a multi-segment key, this defines the first segment. To prevent other segment sources from overriding the intrinsic key, leave the first argument in the **KEYxxx** keyfields as a void, for example, **KEYLOCOLD=(,keylocold)**.

- The key segment sequence information stored in your templates.
- The **KEYFLDOLD** and **KEYFLDNEW** keyfields (when a template has been specified)
- The **KEYLOCOLD**, **KEYLOCNEW**, **KEYLEN**, and (optionally) **KEYTYPE** keyfields.

In most situations, you would use only one of these sources to define your key segments, however, all of them can be intermixed to define the key segments, with the caveat that **KEYLOCOLD**, **KEYLOCNEW**, **KEYLEN**, **KEYTYPE**, **KEYLENNEW**, **KEYTYPNEW** and **KEYORD** override **KEYFLDOLD** and **KEYFLDNEW** when both specify data for the same segment.

Up to 16 values can be specified for each keyword, and the parentheses can be omitted if only one value is provided. The same number of key segments must be defined for both data sets, and the data type and length of corresponding segments must match. Each set of corresponding values then defines a key segment.



Note:

1. **KEYFLDOLD** and **KEYFLDNEW** can only be specified if a template is specified for the corresponding data set.
2. Any segment whose presence is implied by a keyword must be fully specified, except that the data type for the segment can default as described in **KEYTYPE** below.

KEYTCOLD

Determines whether or not any key segment information stored in the "Old" template is used.

If unspecified, the default behavior is that key segment information stored in the "Old" template is only used when all of the following conditions are met:

- TCOLD=*tcold* has been specified.
- The “Old” template contains key segment information.
- No other keyed synchronization options have been specified for either the “Old” or the “New” data sets.

If any of these conditions are not met, key segment information in an “Old” template is ignored.

If specified, the setting given overrides the default behavior.

YES

The key segment information in the “Old” template is loaded regardless of whether or not other **KEY...** keywords have been specified. Where present, the other **KEY...** keywords function as overrides to the template specifications.

NO

The key segment information in the “Old” template is ignored regardless of whether or not other **KEY...** keywords have been specified.

KEYTCNEW

Determines whether or not any key segment information stored in the “New” template is used.

If unspecified, the default behavior is that key information stored in the “New” template is only used when all of the following conditions are met:

- TCNEW=*tcnew* has been specified.
- The “New” template contains key segment information.
- No other keyed synchronization options have been specified for either the “Old” or the “New” data sets.

If any of these conditions are not met, key segment information in an “New” template is ignored.

If specified, the setting given overrides the default behavior.

YES

The key segment information in the “New” template is loaded regardless of whether or not other **KEY...** keywords have been specified. Where present, the other **KEY...** keywords function as overrides to the template specifications.

NO

The key segment information in the “New” template is ignored regardless of whether or not other **KEY...** keywords have been specified.

KEYFLDOLD=(*keyfieldold*,...)

Specifies the name of the field or fields in the “Old” template to be used as key segments. When used in combination with other key segment sources, empty arguments must be included to indicate the position of the *keyfieldold* value or values in the concatenated key.

KEYFLDNEW=(*keyfieldnew*,...)

Specifies the name of the field or fields in the "New" template to be used as key segments. When used in combination with other key segment sources, empty arguments must be included to indicate the position of the *keyfieldnew* value or values in the concatenated key.

KEYLOCOLD=(*keylocold*,...)

Key locations in "Old" data set for keyed synchronization. When used in combination with other key segment sources, empty arguments must be included to indicate the position of the *keylocold* value or values in the concatenated key.

KEYLOCNEW=(*keylocnew*)

Key location in "New" data set for keyed synchronization. When used in combination with other key segment sources, empty arguments must be included to indicate the position of the *keylocnew* value or values in the concatenated key.

KEYLEN=*keylen*

Key length for keyed synchronization. When used in combination with other key segment sources, empty arguments must be included to indicate the position of the *keylen* value in the concatenated key.

KEYTYPE

Defines the data type of the key segment. Can be used to override the data type of an existing template field. When used in combination with other key segment sources, empty arguments must be included to indicate the position of the *keytype* value in the concatenated key.

KEYTYPE is optional - any key segments defined by **KEYLOCxxx/KEYLEN** that do not have a corresponding **KEYTYPE** keyword is given type **CHAR**.

Key segments defined using **KEYFLDOLD** and **KEYFLDNEW** inherit the type of the template field on which they are based, and the expected record sequence is assumed to follow accordingly. In practice this is only likely to be significant for signed binary and packed decimal fields (though internal floating point is also supported). For example, if a key were defined on a two-byte field by location and length, then a value of '001C'x would be less than a value of '001D'x. However if the key were defined via a packed-decimal template field then '001D'x (-1) would be less than '001C'x (+1). Equivalent results can be obtained by using **KEYTYPE** with **KEYLOCxxx** and **KEYLEN**.

CHAR

This is equivalent to the internal C/AN data type. CHAR data type segments are synchronized using the normal EBCDIC collating sequence.

BINARY

This is equivalent to the internal B/BI data type. BINARY data type segments are synchronized as signed binary integers. They must have a length of 2, 4 or 8.

PACKED

This is equivalent to the internal P/PD data type. PACKED data type segments are synchronized as signed packed decimal integers. They must have a length less than or equal to 16.

FLOAT

This is equivalent to the internal FP data type. FLOAT data type segments are synchronized as signed floating point numbers. They must have a length less of 4 or 8.

ZONED

This is equivalent to the internal ZD data type. ZONED data type segments are synchronized as numeric fields. They must have a length less than or equal to 32.



Note: Template fields that are selected as key segments but do not have one of the above data types, is treated as CHAR. In particular, this means that the actual data lengths of varying fields is ignored.

KEYLENNEW=keylen

The key length in “New” data set for keyed synchronization.

This is required only if the length is different from what was specified on the KEYLEN keyword. When you use this option with other key segment sources, you must include empty arguments to indicate the position of the *keylennew* value in the concatenated key.



Note: If the new key length is different from the old key length, the shorter key is padded with hex zeros or the pad character (normally blank) in alphanumeric fields if the pad option is on, before comparison is performed.

KEYTYPNEW

Defines the data type for the “New” data set of the key segment.

This is required only if the type is different from what was specified on the KEYTYPE keyword. You can use this option to override the data type of an existing template field. When you use this option with other key segment sources, you must include empty arguments to indicate the position of the *keytypnew* value in the concatenated key.

KEYORD

Defines the order of the key segment. Specify **A** for ascending. Specify **D** for descending. When you use this option with other key segment sources, you must include empty arguments to indicate the position of the *keyord* value in the concatenated key. The default value is **A** (ascending).

KEYMATCH

Specify *YES* to match records when all of the key fields match.

KEYDUPOK

Specify *YES* to suppress sequence error messages for duplicate key values. The default is *NO*.

Read-ahead Keyed synchronization options

If you specify `SYNCH=RAKEY`, you are requesting read-ahead keyed synchronization. This option is similar to `SYNCH=READAHEAD` except the fact that instead of record matching, key field matching is performed when synchronizing records. As a result, it can detect changes to records that match according to key field data but differ according to record comparison. Therefore, both the [SYNCH=READAHEAD on page 1421](#) and the [SYNCH=KEYED on page 1429](#) suboptions apply with the exception of `KEYORD`.

Load module compare options

If you specify `SYNCH=LMOD`, you are requesting load module comparison.

Load module comparison has these specific options:

CMPPLVL

Determines the level of load module comparison.

LMOD

Only information on the load module level is extracted and compared. CSECT information (and differences at CSECT level) is ignored. This results in a less detailed comparison.

CSECT

Information on both the load module and CSECT levels is extracted and compared. This results in a detailed comparison.

DATEFORM=YYYYDDD

Reported dates (link and compile dates) shown in YYYY.DDD format.

DATEFORM=YMMDD

Reported dates (link and compile dates) shown in YY/MM/DD format.

LMODC

Determines what information at the load module level is to be included in the compare. The criteria correspond with load module properties; only those specified are compared and displayed. Each of the options below can be specified in any sequence, enclosed in parenthesis:

SIZE

The load module size is compared.

ADDRESS

The entry point address of load module is compared.

LINKER | BINDER

The version of the linkage editor or binder used to prepare the load module is compared. LINKER and BINDER are mutually exclusive.

DATE | TIME

The load module link (bind) date and time are compared. DATE and TIME are mutually exclusive.

MODE

The AMODE and RMODE of the load module are compared.

AC | AUTH

The load module authorization code is compared. AC and AUTH are mutually exclusive.

ATTR

The load module link (bind) attributes are compared.

CSECTC

Determines what information at the CSECT level is to be included in the compare. The criteria correspond with the CSECT properties; only those specified are compared and displayed. Each of the options below can be specified in any sequence, enclosed in parenthesis. If CMPLVL=LMOD, this parameter is ignored.

SIZE

The CSECT size is compared.

ADDRESS

The address of the CSECT is compared.

COMPILER

The versions of the language compilers used to compile the CSECT are compared

DATE

The date of the CSECT compile is compared.

MODE

The AMODE and RMODE of the CSECT are compared.

IDRZAP | ZAP

The AMSPZAP IDR data is compared. The IDR ZAP data is an extension of the CSECT information, but is formatted into separate records. ISRZAP and ZAP are mutually exclusive.

TEXT

The CSECT content is compared. The CSECT content is an extension of the CSECT information, but is formatted into separate, 32-byte records shown in "memory dump" format (hexadecimal and character).



Note: If you specify TEXT, the listing option is set to WIDE=YES to accommodate the dump format comparison.

COPT

The compiler options for each CSECT are compared if they can be determined.

Template reporting options

PBK=NONE

Template layout and criteria information not reported.

PBK=LAYOUTS

Template layout information reported if TYPE=FORMATTED is also specified.

PBK=CRITERIA

Template criteria information reported. In this case, a terse layout report is also generated, containing only the fields referred to in the criteria expressions.

PBK=ALL

Template layout and criteria information reported. If TYPE=RECORD is specified, a terse layout report is generated, containing only the fields referred to in the criteria expressions. If TYPE=FORMATTED is specified, a full layout report is generated.

MAP=NONE

Template mapping information not reported.

MAP=MAPPED

Mapped template fields reported if TYPE=FORMATTED is also specified.

MAP=UNMAPPED

Unmapped template fields reported if TYPE=FORMATTED is also specified.

MAP=ALL

Both mapped and unmapped template fields reported if TYPE=FORMATTED is also specified.

ARRAY=YES

If field information is reported, all occurrences of any array elements are reported.

For COBOL OCCURS DEPENDING ON tables, the maximum occurrences are reported.

For PL/1 REFER arrays, the minimum occurrences are reported.

ARRAY=NO

Occurrences of array elements not reported.

FSTATS=NO

The Field Statistics report is not to be generated.

FSTATS=YES

The Field Statistics report is to be generated.

HEXLOC=YES

If field information is reported, all field start and end positions are reported as hexadecimal offsets.

HEXLOC=NO

Field start and end positions not reported as hexadecimal offsets.

HEXLEN=YES

If field information is reported, all field lengths are reported in hexadecimal.

HEXLEN=NO

Field lengths not reported in hexadecimal.

```
//DSM JOB (ACCT), 'NAME'
/* COMPARE DATA SETS
/*
//FMBAT PROC
//FMBAT EXEC PGM=FILEMGR
//STEPLIB DD DSN=FMN.SFMNMOD1,DISP=SHR
//SYSPRINT DD SYSOUT=*
//SYSABEND DD SYSOUT=*
//SYSUDUMP DD SYSOUT=*
// PEND
/*
//STPSSEX EXEC FMBAT
//SYSIN DD *
$$FILEM VER
$$FILEM DSM TYPE=RECORD,
$$FILEM SYNCH=ONETOONE,
$$FILEM LIST=LONG,
$$FILEM WIDE=YES,
$$FILEM HILIGHT=YES,
$$FILEM DSNOLD=FMN.SFMNSAM1(FMNCDATA),
$$FILEM SKIPOLD=0,
$$FILEM CMPOLD=20,
$$FILEM DSNNEW=FMN.SFMNSAM1(FMNCDATA),
$$FILEM SKIPNEW=20,
$$FILEM CMPNEW=20
$$FILEM EOJ
/*
```

```

$$$FILEM DSCMP TYPE=RECORD,
$$$FILEM SYNCH=KEYED,
$$$FILEM LIST=LONG,
$$$FILEM WIDE=YES,
$$$FILEM HILIGHT=YES,
$$$FILEM HEX=YES,
$$$FILEM DSNOLD=USERID.COMPARE.KSDS1,1
$$$FILEM KEYLOCOLD=(,11),2
$$$FILEM DSNNEW=USERID.COMPARE.FLAT2,3
$$$FILEM TCNEW=USERID.TEMPLATE(FLAT2),4
$$$FILEM KEYTCNEW=YES,5
$$$FILEM KEYFLDNEW=(,FIELD-3),6
$$$FILEM KEYLEN=(,1),7
$$$FILEM KEYTYPE=(,CHAR)8
$$$FILEM      EOJ

```

The resulting key segments are shown in the following table:

Segment number	"Old" key position	"New" key position	Key length	Key type
1	1 ¹	1 ²	10 ³	AN ⁴
2	11 ⁵	12 ⁶	1 ⁷	AN ⁸

Source of key information:

1. DSNOLD catalog entry
2. Template field FIELD-1
3. DSNOLD catalog entry and template field FIELD-1 (must be consistent)
4. Template field FIELD-1 (consistent with AN default for key type)
5. KEYLOCOLD
6. Template field FIELD-3 via KEYFLDNEW
7. KEYLEN
8. KEYTYPE

DSP (Data Set Print)

Purpose

Use the DSP function to print sequential data sets, VSAM data sets, PDS members, HFS files, MQ queues, or CICS® resources in a selected format. You can print data by:

1. DSNOLD is intrinsically keyed with key position 1 and length 10.
2. KEYLOCOLD provides a position for the second segment of the "Old" key.
3. DSNNEW is not intrinsically keyed.
4. TCNEW specifies a new template: the template specifies FIELD-1 (position 1, length 10, type AN) as key segment 1.
5. KEYTCNEW forces the loading of the TCNEW key segment information, in spite of the presence of the other KEY... keywords, which act as overrides wherever they clash with the information from the template.
6. KEYFLDNEW specifies FIELD-3 (position 12, length 2, type BI) as the second segment of the "New" key
7. KEYLEN overrides the length of the second key segment
8. KEYTYPE overrides the type of the second key segment

- record
- block (non-VSAM)
- control interval (VSAM)
- field (if a template or copybook has been provided)

You can select records for printing using:

- Member name selection criteria
- Date created selection criteria
- Date last modified selection criteria
- User ID selection criteria
- the start key (VSAM only)
- skip and print count fields
- conditional expression defined in the provided template

The print function can be run in the foreground or as a batch job. The output for the print function is controlled by the SET options.

Usage notes

Choose between four data print formats:

- character
- hexadecimal
- single-record, using a template
- multiple-record (tabular), using a template

When you use a copybook or template, records are formatted field by field using the record layout defined in the copybook or template.

You can Print concatenated data sets with like or unlike attributes. Note that, under some conditions (with tape data sets), File Manager may not be able to detect unlike data set attributes and still invoke DFSORT for processing. Such invocation may fail as DFSORT does not allow for unlike concatenation of data sets. In such cases, you can disable DFSORT with the NOSORT function to allow for successful processing of concatenated datasets with unlike attributes.

Performance tips

- See [General tips about performance when you use File Manager functions on page 1243](#). The comments about File Manager using DFSORT technology when performing sequential file I/O are important to DSP performance.

Options

You can specify the following options:

- Whether to process logical records or physical blocks.
- The position of the first record to print.
- The number of records to print.
- The name of a DFSORT or REXX procedure, if you want the output records passed to a procedure for processing before they are printed.

Physical block processing is not compatible with SNGL or TABL print format, or with using templates, and SNGL or TABL print format requires you to use a template.

You can use the various SET processing options to control the print output:

- SET PRINTOUT defines the destination of the print output. If set to PRINTOUT=SYSOUT, you can use the PB (Print Browse) function to browse the accumulated output.
- When you specify CHAR or LHEX print format, SET RECLIMIT controls how many bytes of each record are printed, and SET DATAHDR determines whether header information, such as record number, is printed.
- The format of the print output also depends on the settings of SET PAGESIZE, SET PRINTLEN, and SET PRTRAN.
- Use SET DUMP to specify the dump format.

Note that additional formatting options are available when using formatted print in SNGL mode. Additional field information (redefined fields, field reference number, field type and length values, picture clause, start location, structure and numeric field justification) can be set and printed depending on the options selected using the keywords listed later in this section.

When you specify the PROC option, you are supplying a REXX procedure. For more information, see the *proc* parameter below.

Return codes

The default return codes from the DSP function have the following modified meanings:

1

No records printed for some of multiple members

2

Print error encountered

2

No print - REXX procedure has dropped records which are not subsequently printed.

3

REXX member selection is in effect but the procedure encountered a RETURN DROP, STOP or STOP IMMEDIATE string. This has been treated as a RETURN string with no arguments.
OR REXX member selection is NOT in effect but the procedure encountered a RETURN DROP

MEMBER or RETURN PROCESS MEMBER string. This has been treated as a RETURN string with no arguments.

4

No records printed because no records selected

4

No records printed because no members to process

4

No records printed because input empty

4

No records printed because the input data set or member is in ISPF Packed Data format and the "PACK=SKIP" option was specified

8

REXX non-syntax error encountered while processing records

16

Data set or member open error

16

Data set not found

16

Input data appears ISPF packed but is not valid.

16

Other input or output error occurred

16

Insufficient storage available

16

DSP abended

16

Other serious error that stops processing occurred



Note: Return codes can be customized during installation. If you receive return codes that do not match those listed above, your site might have customized the return codes for this function. File Manager



may also issue the 999 abend, if the return code in batch is equal to or greater than the ABENDCC value. Contact your File Manager systems administrator for details.

Related functions

DP

Print physical disk records

DVT

Print VTOC entries

Figure 435. Syntax

► DSP ►

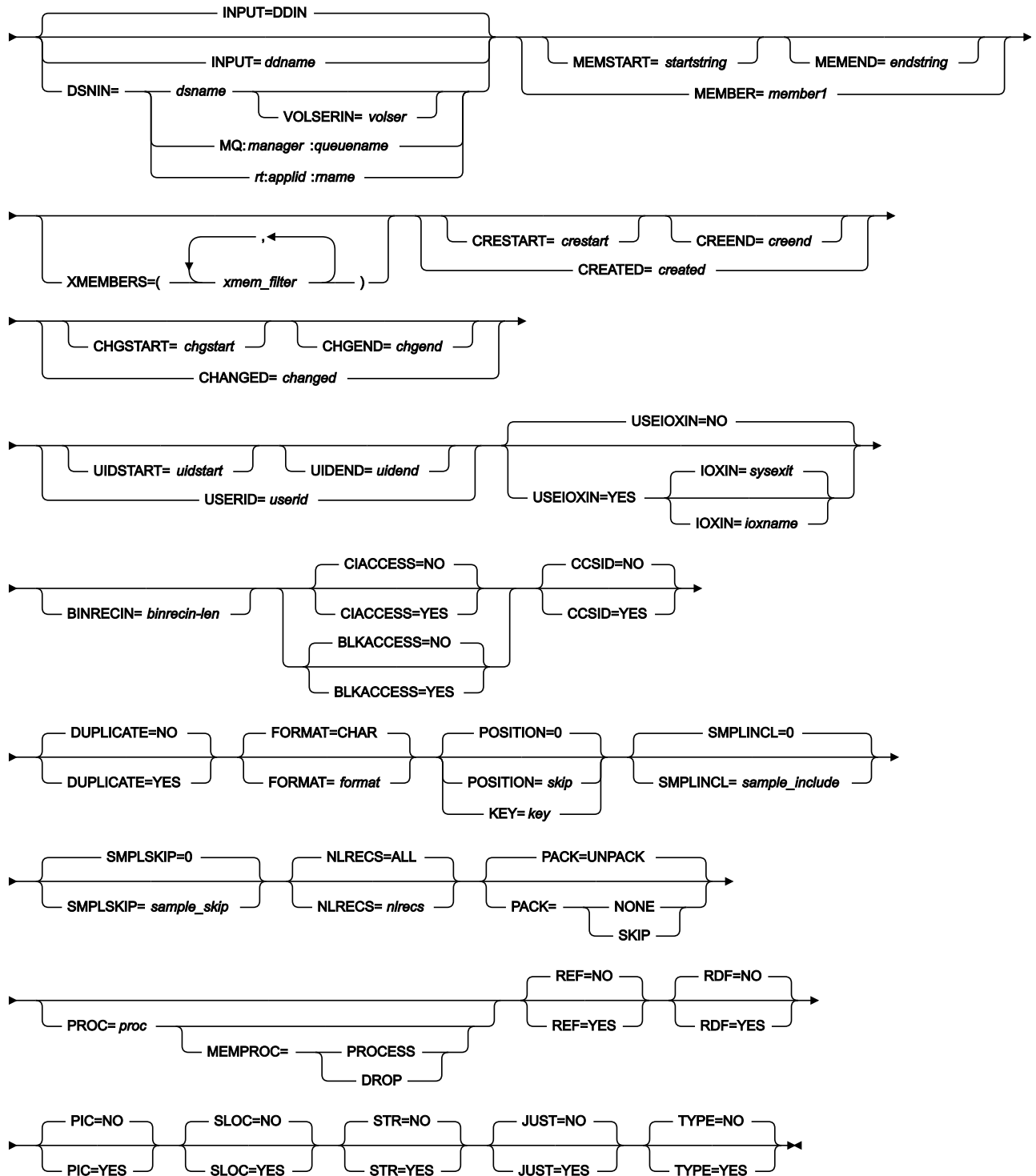

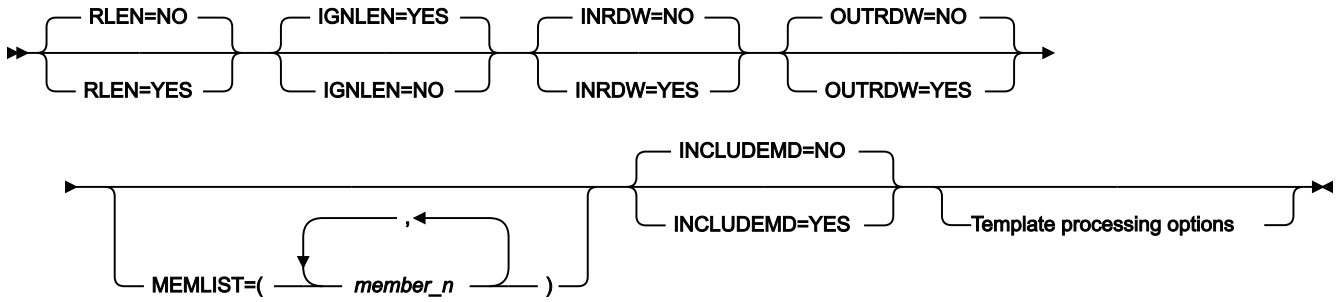

Template processing options

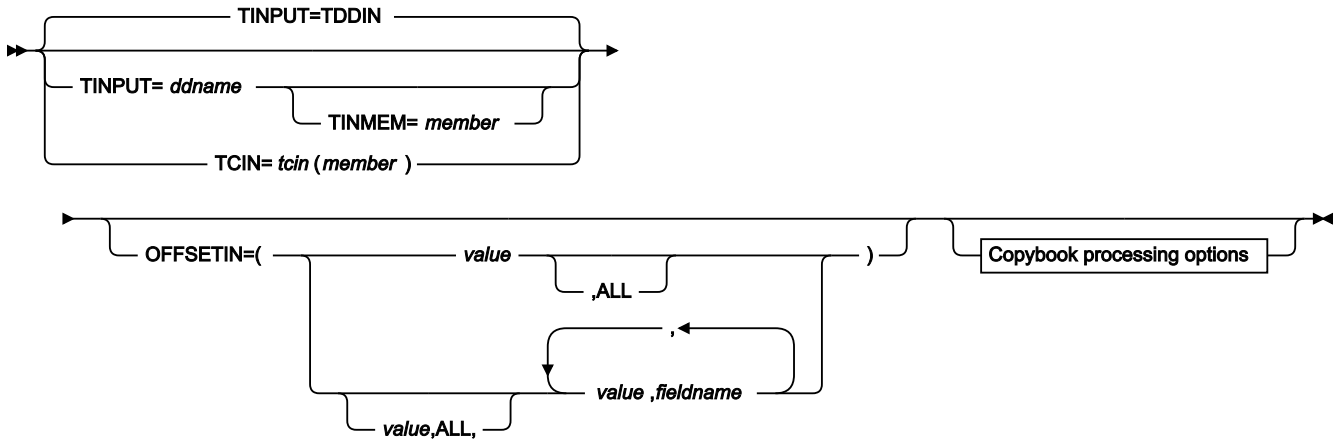

Copybook processing

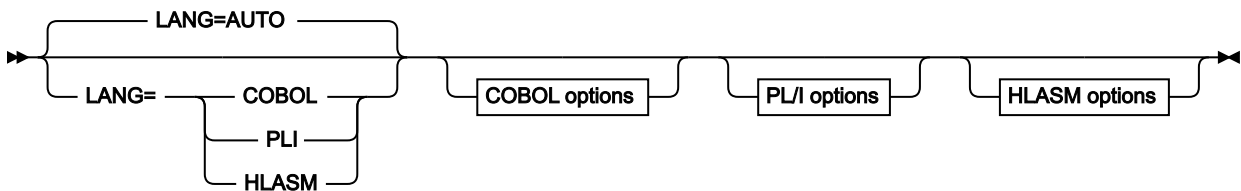

COBOL options

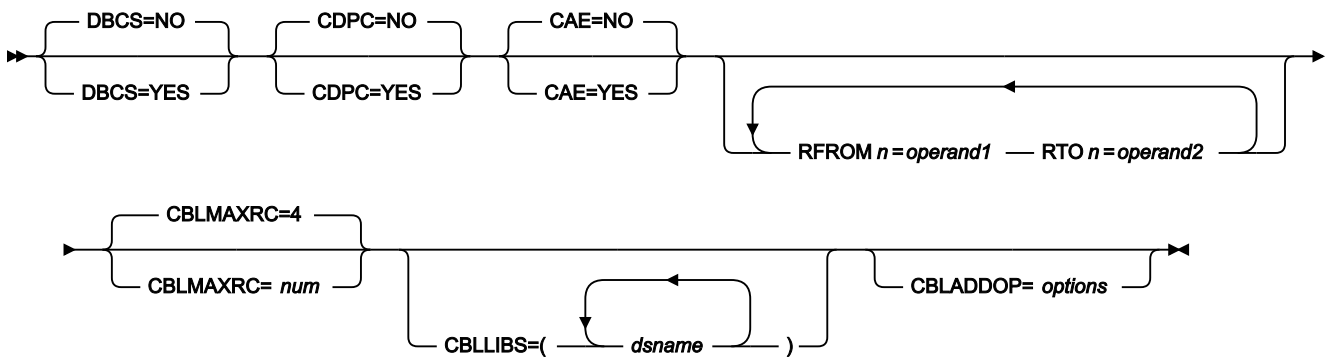

PL/I options

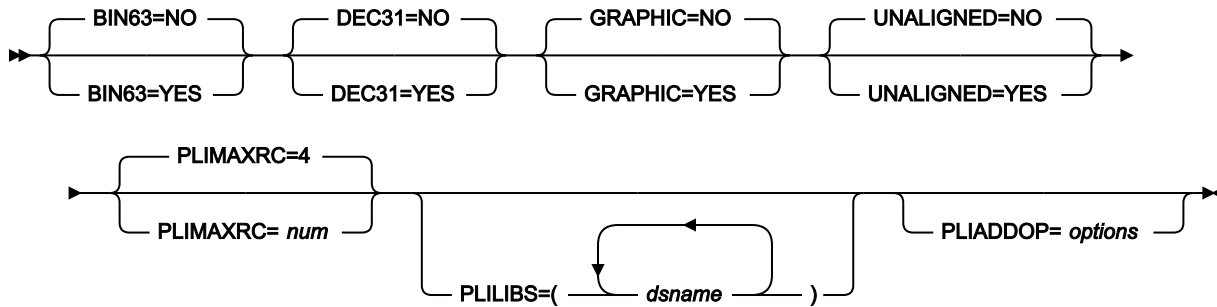

HLASM options

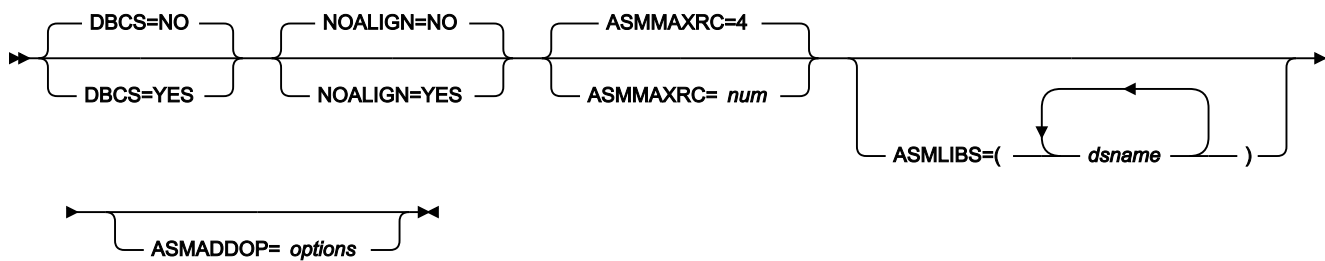
**INPUT=ddname**

Defines a reference to a DD or TSO ALLOC statement for the input data set or HFS file. The default is `DDIN`.

DSNIN=dsname

Defines the name of the input data set or an absolute path to the input HFS file (directory). If any DD statements are specified, they are not used. The name may include a member name in parenthesis. If the member is specified here, the associated Member parameter must be empty. An absolute path to an HFS file (directory) must be enclosed in apostrophes. If it does not fit on one line, you can split it over more than one line. You can further describe this data set, as follows:

VOLSERIN=volser

Volume serial number for a non-cataloged data set.

MEMBER=member1

The name of a single member in a PDS, or a member name pattern representing one or more members in a PDS. If the input data set is a PDS(E), you may specify this parameter, or a member name in the DD statement for *ddname*, or specify a range of member names with the MEMSTART and MEMEND keywords.

A member name pattern can consist of any characters that are valid in a member name and two special pattern characters: the asterisk (*) and the percent symbol (%).

*

represents any number of characters. As many asterisks as required can appear anywhere in a member name pattern. For example, if you enter a member name pattern of `*d*`, all members in the PDS whose name contains "d" are processed.

%

is a place holding character that means a single character. As many percent symbols as necessary can appear anywhere in a member name pattern. For example, if you enter a member name pattern of `%%%`, all members in the PDS whose name is four characters in length are processed.

member1 is ignored if the data set is not a PDS.

MEMSTART=*startstring*

Is used to specify the start of a range of member names to be included in the copy. If MEMSTART is specified but MEMEND is omitted, all members of the PDS(E) from the *startstring* value onwards are included. *startstring* can have the same values, including wild cards, as for the *member1* parameter of the MEMBER keyword.

MEMEND=*endstring*

Is used to specify the end of a range of member names to be included in the copy. If MEMEND is specified but MEMSTART is omitted, all members of the PDS(E) up to the *endstring* value onwards are included. *endstring* can have the same values, including wild cards, as for the *member1* parameter of the MEMBER keyword.

XMEMBERS

Provides a way to exclude from processing library members that would otherwise be selected using the MEMSTART, MEMEND, and MEMBER options.

xmem_filter

A member name filter identifying one or more members that are to be excluded from processing. A filter can be a member name pattern representing multiple members.

To specify a member name filter containing lowercase characters, use a character string in the format `c'string'`. Filter values can also be specified as hexadecimal strings in the format `x'hex-digits'`.

MQ:*manager.queue*

You can specify a MQ queue in place of a data set name, where:

manager

The MQ manager to be used. If you specify a generic name, File Manager displays a list of matching managers to select from.

queue

The queue to be used. If you specify a generic name, File Manager displays a list of matching queues to select from.

rt:*applid.rname*

You can specify a CICS® resource in place of a data set name, where:

rt

Resource type. Valid values are:

FI

For a CICS® file.

TD

For a Transient Data Queue.

TS

For a Temporary Storage Queue.

applid

The VTAM® applid of the CICS® system.

rname

The name of the resource.

CREATED=*created*

The date on which a member was created, in YYYY/MM/DD format.

If the input data set is a PDS(E), you may specify this parameter, or specify a range of creation dates with the CRESTART and CREEND keywords.

You can specify an asterisk (*) as the last character to indicate a range of dates or a percent sign (%) in place of a single character to indicate a selection of dates.

created is ignored if the data set is not a PDS.

CRESTART=*crestart*

The start of a range of creation dates in YYYY/MM/DD format to be included in the copy.

If CRESTART is specified but CREEND is omitted, all members of the PDS(E) from the *crestart* value onwards are included.

If omitted, or you do not enter a full date, or you specify an asterisk (*) as the last character, the unspecified portion of *crestart* defaults to the right as follows:

DD

= 01

MM

= 01

YYYY

= 0000

No other wildcarding is allowed.

CREEND=*creend*

The end of a range of creation dates in YYYY/MM/DD format to be included in the copy.

If omitted, or you do not enter a full date, or you specify an asterisk (*) as the last character, the unspecified portion of *creend* defaults to the right as follows:

DD

= 31

MM

= 12

YYYY

= 9999

No other wildcarding is allowed.

CHANGED=*changed*

The date on which a member was last modified, in YYYY/MM/DD format.

If the input data set is a PDS(E), you may specify this parameter, or specify a range of modification dates with the CHGSTART and CHGEN keywords.

You can specify an asterisk (*) as the last character to indicate a range of dates or a percent sign (%) in place of a single character to indicate a selection of dates.

changed is ignored if the data set is not a PDS.

CHGSTART=*chgstart*

The start of a range of modification dates in YYYY/MM/DD format to be included in the copy.

If CHGSTART is specified but CHGEN is omitted, all members of the PDS(E) from the *chgstart* value onwards are included.

If omitted, or you do not enter a full date, or you specify an asterisk (*) as the last character, the unspecified portion of *chgstart* defaults to the right as follows:

DD

= 01

MM

= 01

YYYY

= 0000

No other wildcarding is allowed.

CHGEN=*chengend*

The end of a range of modification dates in YYYY/MM/DD format to be included in the copy.

If omitted, or you do not enter a full date, or you specify an asterisk (*) as the last character, the unspecified portion of *chgend* defaults to the right as follows:

DD

= 31

MM

= 12

YYYY

= 9999

No other wildcarding is allowed.

USERID=*userid*

The TSO user ID by which the member was last updated.

If the input data set is a PDS(E), you may specify this parameter, or specify a range of user IDs with the UIDSTART and UIDEND keywords.

You can enter a generic user ID by using asterisks and percent signs.

userid is ignored if the data set is not a PDS.

UIDSTART=*uidstart*

The start of a range of user IDs to be included in the copy.

If UIDSTART is specified but UIDEND is omitted, all members of the PDS(E) from the *uidstart* value onwards are included.

If omitted, or you do not enter a full 7-character user ID, or you specify an asterisk (*) as the last character, File Manager replaces the asterisk and pads the unspecified portion of *uidstart* to the right with low values (X'00').

UIDEND=*uidend*

The end of a range of user IDs to be included in the copy.

If you omit this field, it defaults to high values (X'FF').

If you specify less than 7 characters (without an asterisk as the last character), File Manager pads *uidstart* to the right with low values (X'00'). If you specify an asterisk (*) as the last character, File Manager replaces the asterisk and pads the unspecified portion of *uidend* with high values (X'FF').

USEIOXIN

Specifies whether to invoke a user I/O exit, to process the input data set.

NO

Default. Do not invoke a user I/O exit.

YES

Invoke a user I/O exit to process the input data set. This option is only available if the person who did the site customization for File Manager allowed user I/O exits on a site-wide basis.

IOXIN

Specifies the name of the user I/O exit used for the input data set. There are no restrictions on the programming language that you can use to write an exit. The exit must be provided to File Manager in the STEPLIB/ISPLLIB concatenation or their extensions (LINKLIST, LPA, and so on).

sysexit

Default. If you specify USEIOXIN=YES and do not supply a user I/O exit name, File Manager uses the name of the exit provided in the installation customization options. If USEIOXIN has been set to YES and no installation default has been provided, you must specify IOXIN=*ioxname*.



Note: If you have selected batch processing in an online panel, the generated JCL statements use the default name provided in your Set System Processing Options panel.

ioxname

The name of a PDS(E) member of a data set that has been provided to File Manager in the STEPLIB concatenation.

BINRECIN=*binrecin-len*

Specifies the record length used for processing the HFS file. Valid range: 1 to 32760.

The file is processed in Binary mode (fixed-length records derived from the file, delimiters not distinguished). If you do not specify this parameter, the file is processed in Text mode (variable-length records, boundaries determined by delimiters).

CIACCESS=NO (VSAM only)

Process logical records.

CIACCESS=YES (VSAM only)

Process control intervals.

BLKACCESS=NO (Non-VSAM only)

Process logical records.

BLKACCESS=YES (Non-VSAM only)

Process blocks.

CCSID=YES

Show the CCSID assigned to each field, if applicable, on SNGL print.

CCSID=NO

Do not show the CCSID assigned to each field, if applicable, on SNGL print.

DUPLICATE

Specify whether or not duplicate member names are to be processed for printing.

NO

Default. Do not process duplicate member names.

YES

Process duplicate member names.

FORMAT=*format*

The format of the output:

CHAR

Character format (the default).

HEX

Hexadecimal format.

SNGL

Single-record format (one field on each line). This option is available when viewing logical records.

TABL

Tabular format (fields printed across the page). This option is available when viewing logical records.

POSITION=*skip*

Number of logical records to be skipped from the beginning of the data set. The default is 0.

SMPLINCL=*sample_include*

Number of physical records to be included in a repeating sample from a data set. Both SMPLINCL and SMPLSKIP keywords must have non-zero values for sampling to take effect. Range: 0–9999999.

SMPLSKIP=*sample_skip*

Number of physical records to be skipped in a repeating sample from a data set. Both SMPLINCL and SMPLSKIP keywords must have non-zero values for sampling to take effect. Range: 0–9999999.

KEY=*key* (VSAM only)

A key for KSDS records, or a slot number for RRDS records. The maximum key length is 30 characters. The first record with a key or slot value greater than or equal to *key* is the first record printed. If you omit the *key* and *skip* values, printing begins with the first record in the data set.

If the key contains lowercase characters, blanks, or commas, enclose it in quotation marks. You can also specify a key in hexadecimal format (for example, X'C1C2C3').

NLRECS

Number of records to be printed or ALL.

ALL

If you specify ALL or omit the parameter, all the remaining records are copied.

nirecs

The maximum number is 999 999 999.

PACK

Determines if File Manager should detect if the input data is in ISPF packed format. This keyword is ignored when processing VSAM data sets. When an I/O exit has been specified for either the input or output data set (or both), the only valid option is PACK=NONE.

UNPACK

Instructs File Manager to check if the input data set is in ISPF packed format and if so, to unpack it before print processing.

NONE

Instructs File Manager not to check if the input data set is in ISPF packed format.

SKIP

Instructs File Manager to determine if the input data set is in ISPF packed format and if so, to skip the print processing.

PROC=*proc*

Member name of a REXX procedure that you want to use to process each record before it is printed, or an asterisk (*) to indicate the REXX procedure is inline. If you specify a member name, you must define an FMNEXEC ddname that identifies the PDS containing the member. If you specify *, the procedure is read from SYSIN immediately following the control statement for the current function. The inline procedure is terminated by a record containing a slash and a plus sign (/+) in columns 1–2.

For more information about using REXX procedures to process records before they are printed, see [Enhancing File Manager processing on page 517](#).

MEMPROC

Specifies that REXX member selection is in effect. Records are read from the input member and then cached in memory until a decision is made, within the REXX procedure, on whether the member is to be copied or dropped. Once the decision has been made, the entire member is either copied or dropped, depending upon the RETURN string specified in the REXX procedure. If the entire member is processed without encountering a RETURN DROP MEMBER or RETURN PROCESS MEMBER string, the member is processed according to the action specified by the parameter specified for MEMPROC. These are:

PROCESS

The member is to be included in the copy. The member is copied intact, subject to any specified template processing, which is performed before the user REXX proc is invoked. This is the default action, if no parameter is specified with the MEMPROC keyword.

DROP

The member is to be excluded from the copy. Processing continues with the next member.

REF=YES

Show field reference number on SNGL print.

REF=NO

Do not show field reference number on SNGL print.

RDF=YES

Show redefined fields on SNGL or TABL print.

RDF=NO

Do not show redefined fields on SNGL or TABL print.

PIC=YES

Show picture clause on SNGL print.

PIC=NO

Do not show picture clause on SNGL print.

SLOC=YES

Show start location on SNGL print.

SLOC=NO

Do not show start location on SNGL print.

STR=YES

Show structure on SNGL print.

STR=NO

Do not show structure on SNGL print.

JUST=YES

Left-justify numeric fields on SNGL print.

JUST=NO

Do not left-justify numeric fields on SNGL print.

TYPE=YES

Show field type and length values on SNGL print.

TYPE=NO

Do not show field type and length values on SNGL print.

RLEN=YES

Print record length in TABL and SNGL formats.

RLEN=NO

Do not print record length in TABL and SNGL formats.

IGNLEN

Specifies whether or not File Manager ignores length mismatches when selecting records for processing.

NO

Do not ignore length mismatches. Records that are shorter than the matching structure length in the template are not selected for processing.

YES

Use this option to ignore length mismatches.

INRDW

Controls whether or not to adjust the input start location when the specified start location takes into account the record descriptor word (RDW).

NO

Does not adjust the input start location.

YES

Subtracts 4 from all start locations that have been coded on external functions that refer to the input record.

OUTRDW

Controls whether or not to adjust the output start location when the specified start location takes into account the record descriptor word (RDW).

NO

Does not adjust the output start location.

YES

Subtracts 4 from all start locations that have been coded on external functions that refer to the output record.

MEMLIST

Allows you to specify a list of member names.

member_n

The name of the member to be processed. Generic name masks are allowed.

INCLUDEMD

This parameter determines what happens to the descriptor for an Websphere MQ message.

YES

The descriptor is added as a prefix as the data is printed.

NO

Just the message data is printed. This is the default.

This parameter applies only when the input describes an MQ queue.

Template processing

Define which template (if any) is used to describe the record structure in the input data set, and how File Manager processes this template.

TINPUT=ddname

Defines a reference to a DD or TSO ALLOC statement for the data sets which contain the copybook or template that describes the record structure of your input data. The default is TDDIN.

If you specify a concatenated DD, then you must provide the member name, *member*.

TINMEM=member

The name of the copybook or template member in the datasets identified by the TINPUT parameter if it has not been specified on the DD statement. This parameter must not be specified if the TCIN parameter is specified.

TCIN=tcin(member)

PDS and member name of the copybook or template that describes the record structure of your input data.

OFFSETIN

The length of the 01 field in the template and the start locations of the fields within that 01 field are adjusted by the value provided.

value

The offset value, which must be in the range -32760 to 32760, to be applied to the corresponding field identifier. If no field identifier is supplied and ALL is not used, the value is applied to the first Level 01 field in the template.

ALL

Where the template contains multiple record structures, this keyword applies the corresponding *value* to all Level 01 fields within the template.



Note: You can specify a value for ALL and then override this value for individual layouts by providing subsequent *value* and *fieldname* combinations.

fieldname

The name of the Level 01 field to which *value* is to be applied. The default is the first Level 01 field in the template.

Copybook processing

If you specify a copybook (instead of an existing template), File Manager uses these processing options to compile the copybook into a template:

LANG

Determines whether File Manager automatically detects the copybook language or interprets the language as COBOL, PL/I, or HLASM.



Note: The COMPLANG setting in FMN0POPT is the equivalent of the LANG parameter in batch functions.

- If COMPLANG is set it determines the installation default language for online and batch compilation.
- If COMPLANG is not specified then COBOL is the installation default for online compilation and AUTO is the default for batch compilation.
- If a value of COBOL, HLASM, PL/1, or AUTO is specified (in the **Compiler Language Selection** panel or through the LANG parameter in a batch job) it overrides the default language.

AUTO

Automatically detect whether the copybook language is COBOL or PL/I, and invoke the appropriate compiler. If the compilation results in a return code greater than 4, then invoke the compiler for the other language. If the second compilation also results in a return code greater than 4, then retry the first compiler and report the compilation errors. If File Manager successfully creates a template (despite the compilation errors), then continue processing with the template.

COBOL

Invoke the COBOL compiler to create a template from the copybook. (Do not invoke the PL/I compiler, even if the COBOL compilation results in errors.)

PLI

Invoke the PL/I compiler to create a template from the copybook. (Do not invoke the COBOL compiler, even if the PL/I compilation results in errors.)

HLASM

Invoke the HLASM compiler to create a template from the copybook.

DSINFO

Specifies whether additional data set information for input and output sources should be produced in batch reports for the DSP, DSM, DSC, and FCH commands.

NO

No additional data set information is generated.

YES

Generates data set information including DSORG, RECFM, LRECL, BLKSIZE, and VSAM attributes including average record length, maximum record length, key offset, key length and reuse, for input and output data sets when applicable.

COBOL options

The following options are used to compile a COBOL copybook into a template:

DBCS=YES

Use the DBCS compiler option.

DBCS=NO

Use the NODBCS compiler option.

For details on the effect of the DBCS and NODBCS compiler options, see the *IBM COBOL Programming Guide for OS/390 & VM*.

CDPC=NO

Do not use the COBOL SPECIAL-NAMES paragraph "Decimal-point is comma".

CDPC = YES

Use the COBOL SPECIAL-NAMES paragraph "Decimal-point is comma".

CAE=NO

Do not use the COBOL compile option ARITH(EXTEND).

CAE = YES

Use the COBOL compile option ARITH(EXTEND).

MIXED = NO

Field names stored in the template in uppercase.

MIXED = YES

Field names stored in the template in the original case as coded in the COBOL copybook.

RFROM1 RT01 ... RFROM5 RT05 (1 to 5)

Up to five pairs of "From" and "To" pseudo-text character strings for the COBOL REPLACE compiler-directing statement.

If your COBOL copybooks contain characters that you want to remove or replace with other characters before compiling the copybooks into templates, then use these replacing options.

For example, if your copybooks contain colon characters (:) that you want to remove before compiling, then specify '====' as *operand1* and '===== ' as *operand2*.

For details on specifying "From" and "To" strings for COBOL REPLACE, see the *IBM COBOL Language Reference*.

CBLMAXRC

Sets the maximum acceptable return code for a copybook compile. A return code higher than the specified level causes the function to stop. Default is 4.



Note: The COMPMAXRC parameter is still supported but it is recommended that the CBLMAXRC parameter is used instead. If you do specify the COMPMAXRC parameter, it takes precedence over the language MAXRC.

CBLLIBS

Allows you to specify a list of up to ten data set names to be specified in the SYSLIB concatenation list. These data sets are searched in the order specified for COPY and INCLUDE members for the compilation.

dsname

The name of the data set name to be processed. Generic name masks are not allowed.

CBLADDOP

Additional COBOL compiler options which are included in a CBL statement when compiling COBOL copybooks.

PL/I options

The following options are used to compile a PL/I copybook into a template:

BIN63=YES

Use the LIMITS(FIXEDBIN(63)) compiler option.

BIN63=NO

Use the LIMITS(FIXEDBIN(31)) compiler option.

DEC31=YES

Use the LIMITS(FIXEDDEC(31)) compiler option.

DEC31=NO

Use the LIMITS(FIXEDDEC(15)) compiler option.

GRAPHIC=YES

Use the GRAPHIC compiler option.

GRAPHIC=NO

Use the NOGRAPHIC compiler option.

UNALIGNED=YES

Use the DEFAULT RANGE (*) UNALIGNED, language statement to change the default alignment.

UNALIGNED=NO

Use the PL/I default.

PLIMAXRC

Sets the maximum acceptable return code for a copybook compile. A return code higher than the specified level causes the function to stop. Default is 4.



Note: The COMPMAXRC parameter is still supported but it is recommended that the PLIMAXRC parameter is used instead. If you do specify the COMPMAXRC parameter, it takes precedence over the language MAXRC.

PLILIBS

Allows you to specify a list of up to ten data set names to be specified in the SYSLIB concatenation list. These data sets are searched in the order specified for COPY and INCLUDE members for the compilation.

dsname

The name of the data set name to be processed. Generic name masks are not allowed.

PLIADDOP

Additional PL/I compiler options which are included in a *PROCESS statement when compiling PL/I copybooks.

For details on the effect of these compiler options, see the *IBM VisualAge PL/I for OS/390 Programming Guide*.

HLASM options

The following options are used to compile a HLASM copybook into a template:

DBCS=YES

Use the DBCS compiler option.

DBCS=NO

Use the NODBCS compiler option.

NOALIGN=YES

Use the NOALIGN compiler option.

NOALIGN=NO

Use the ALIGN compiler option.

ASMMAXRC

Sets the maximum acceptable return code for a copybook compile. A return code higher than the specified level causes the function to stop. Default is 4.



Note: The COMPMAXRC parameter is still supported but it is recommended that the ASMMAXRC parameter is used instead. If you do specify the COMPMAXRC parameter, it takes precedence over the language MAXRC.

ASMLIBS

Allows you to specify a list of up to ten data set names to be specified in the SYSLIB concatenation list. These data sets are searched in the order specified for COPY and INCLUDE members for the compilation.

dsname

The name of the data set name to be processed. Generic name masks are not allowed.

ASMADDOP

Additional HLASM compiler options which are included in a *PROCESS statement when compiling COPY and MACRO members.

For details on the effect of these compiler options, see the *HLASM V1R6 Programmer's Guide*.

PACK

Determines if File Manager should detect if the input data sets are in ISPF packed format. This keyword is ignored when processing VSAM data sets. When an I/O exit has been specified for either data set (or both), the only valid option is PACK=NONE.

UNPACK

Instructs File Manager to check if the input data sets are in ISPF packed format and if they are, to unpack them before the comparison.

NONE

Instructs File Manager not to check if the input data sets are in ISPF packed format.

SKIP

Instructs File Manager to check if the input data set is in ISPF packed format and if so, to skip the compare processing.

Example

Example 1

```
//DSP JOB (acct),'name' Print QSAM Data
//*
//FMBAT PROC
//FMBAT EXEC PGM=FILEMGR
//STEPLIB DD DSN=FMN.SFMNMOD1,DISP=SHR
//SYSPRINT DD SYSOUT=*
//SYSABEND DD SYSOUT=*
//SYSUDUMP DD SYSOUT=*
// PEND
//*
//STPSPEX EXEC FMBAT
//SYSIN DD *
$$FILEM VER
$$FILEM DSP DSNIN=SYS1.PROCLIB,MEMBER=COBUCLG
$$FILEM EOJ
/*
```

Example**Example 2**

```
//DSPJPN JOB (acct),'name' Print with DBCS characters
//JAPEF96 OUTPUT DUPLEX=NORMAL,CHARS=(GT15,EF96),PRMODE=SOSI1
//FILEMGR EXEC PGM=FILEMGR
//SYSPRINT DD SYSOUT=*,OUTPUT=(*.JAPEF96)
//FMNTSPRT DD SYSOUT=*
//SYSTEM DD SYSOUT=*
//SYSIN DD *
$$FILEM SET LANGUAGE=JAPANESE
$$FILEM DSP FORMAT=SNGL,
$$FILEM TCIN=h1q.TEMPLATE(member),
$$FILEM DSNIN=h1q.DBCSDATA
```

Example**Example 3**

```
//FMNUSR3 JOB (FMNUSER),'USER',USER=FMNUSER,NOTIFY=FMNUSER,
// TIME=(5),CLASS=A,MSGLEVEL=(1,1),MSGCLASS=H
//*
/* TEST PRINTING USING JAPANESE CHARACTER SETS WITH FMT
/*
//JAPEF96 OUTPUT DUPLEX=NORMAL,CHARS=(GT15,EF96),PRMODE=SOSI1
//FILEMGR EXEC PGM=FMNMAIN
//STEPLIB DD DSN=FMN.SFMNMOD1,DISP=SHR
//SYSPRINT DD SYSOUT=H,OUTPUT=(*.JAPEF96),DEST=(PTHMVS8,QAPT22Q1)
//SYSTEM DD SYSOUT=*
//SYSIN DD *
$$FILEM SET LANGUAGE=JAPANESE
$$FILEM FMT SET,FLD=(11,20,DB),FLD=(31,40,DB),FLD=(51,60,DB),
$$FILEM FLD=(71,80,DB)
$$FILEM DSP DSNIN=FMNUSER.JPN.TESTDATA,MEMBER=$FMTDATA
/*
```

DSU (Data Set Update) -- batch only

Purpose

Update disk data set records.

Usage notes

Use this function to update logical records in a single sequential disk data set, a single VSAM data set, one or more members of a PDS, an MQ queue, or a CICS® resource.



Note: Compressed non-VSAM extended format data sets (compressed PSE data sets) are not supported (for use with DSU). It is recommended that you use FCH with a PROC if you want to update compressed data sets with a PROC.

You can select the records to be processed using:

- Member name selection criteria
- Date created selection criteria
- Date last modified selection criteria
- User ID selection criteria

Records in the data set are read sequentially. After each record is read, File Manager invokes the REXX procedure specified in the PROC parameter, and passes the contents of the record to the exec. The contents are passed in two File Manager-defined REXX variables, INREC and OUTREC. When the exec is invoked, the contents of the two variables are identical. The INREC variable is intended to be used as a reference variable. Any changes made to it are ignored by File Manager. The OUTREC variable can be updated by the exec. After the REXX procedure has processed the record, if the data in OUTREC has changed, the record is updated in the data set using the contents of OUTREC.

You cannot add records or delete records using DSU. If you need to add or delete records, you can use one of the File Manager data set copy functions. You cannot change the length of records in a data set using DSU. If the REXX procedure increases the length of the data in OUTREC, the data is truncated to its original length before the record is updated. If the REXX procedure decreases the length of the data in OUTREC, the data is padded to its original length using the pad value specified in the PAD processing option. If no pad value has been specified, the contents of the record are unpredictable.

Performance tips

- When you use DSU to update members of a PDS(E):

One DSU default is STATS=ON, which causes the ISPF statistics for each updated member to be updated. This can significantly increase I/O (EXCP) and CPU utilization. To improve performance, consider using STATS=OFF.

Options

When you specify the PROC option, you are supplying a REXX procedure. For more information, see the *proc* parameter below.

Return codes

The default return codes from the DSU function have the following modified meanings:

- 1**
One or more members not updated
- 2**
Change failed (for example invalid key change)
- 4**
No records updated (NOUPDATE=NO)
- 4**
No records processed because no members to process
- 4**
No records processed because input empty
- 4**
No records processed because input is in ISPF Packed Data format and the "PACK=STOP" option was specified.
- 8**
REXX non-syntax error encountered while processing records
- 16**
Program Object specified - this is not supported
- 16**
Data set or member in use
- 16**
Data set or member open error
- 16**
Data set not found
- 16**
Other input or output error occurred
- 16**
Insufficient storage available

16

DSU abended

16

Other serious error that stops processing occurred



Note: Return codes can be customized during installation. If you receive return codes that do not match those listed above, your site might have customized the return codes for this function. File Manager may also issue the 999 abend, if the return code in batch is equal to or greater than the ABENDCC value. Contact your File Manager systems administrator for details.

Related functions

DSEB

Edit a data set via batch job processing.

DSX

Display the extents of a data set.

Figure 436. Syntax

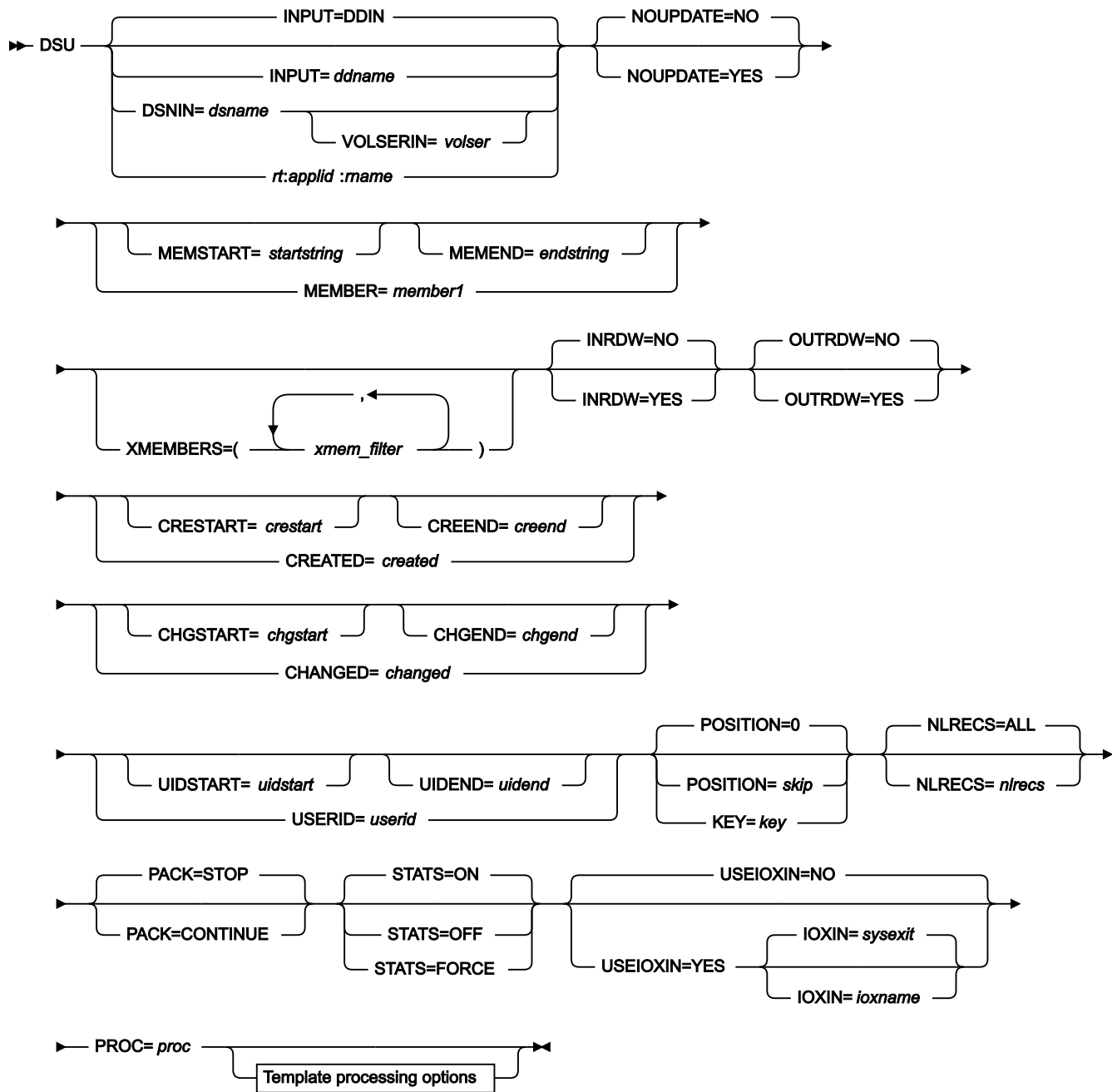

Template processing options

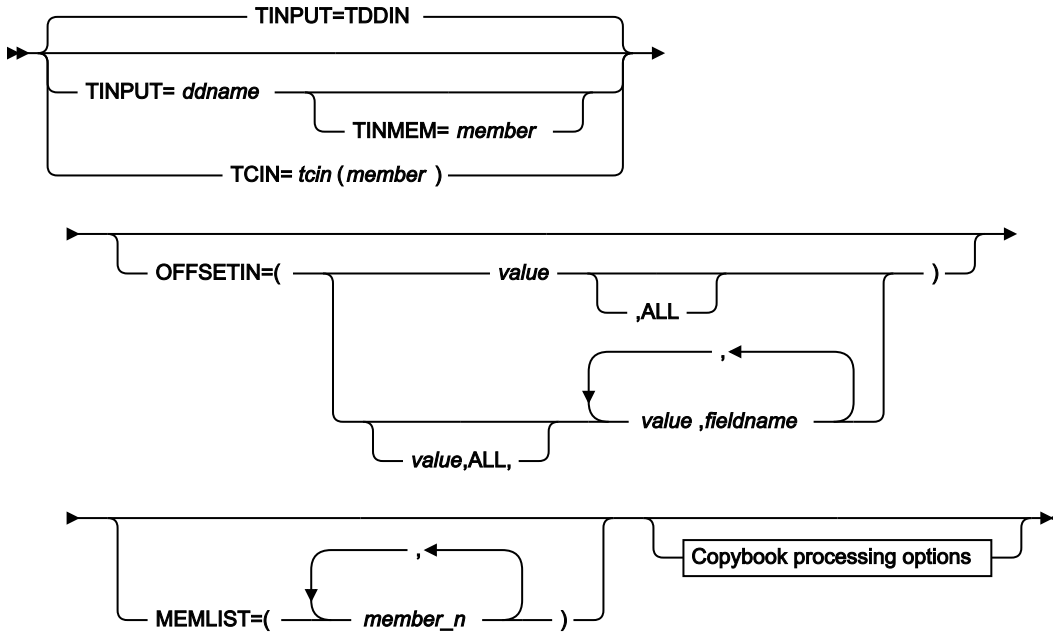

Copybook processing

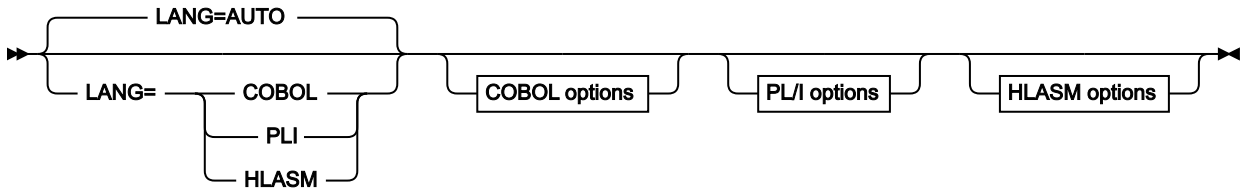

COBOL options

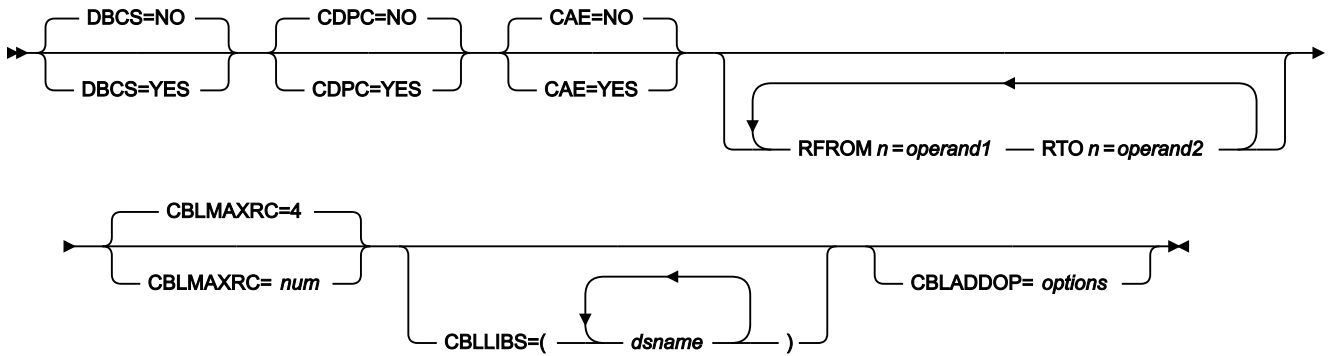

PL/I options

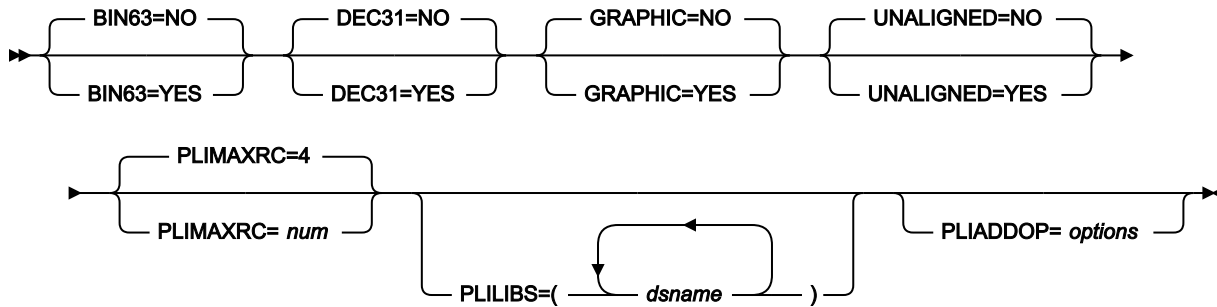

HLASM options

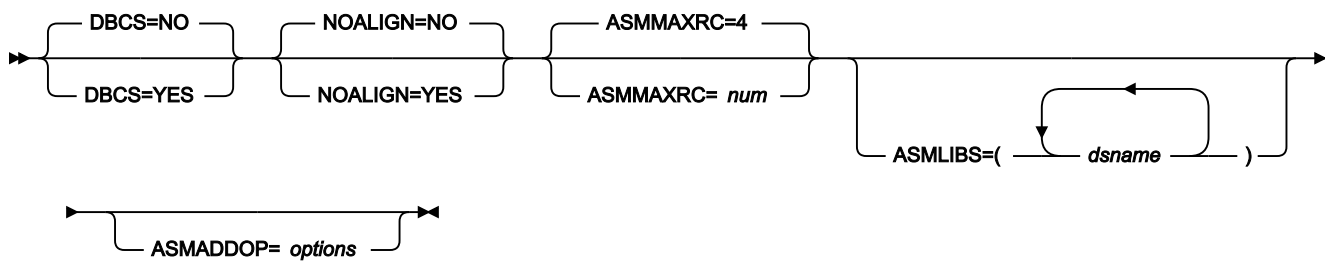
**INPUT=ddname**

Defines a reference to a DD or TSO ALLOC statement for the input data set. The default is `DDIN`.

DSNIN=dsname

Defines the name of the input data set. If any DD statements are specified, they are not used. The name may include a member name in parenthesis. If the member is specified here, the associated Member parameter must be empty. You can further describe this data set, as follows:

VOLSERIN=volser

Volume serial number for a non-cataloged data set.

rt.applid:rname

You can specify a CICS® resource in place of a data set name, where:

rt

Resource type. Valid values are:

FI

For a CICS® file.

TD

For a Transient Data Queue.

TS

For a Temporary Storage Queue.

applid

The VTAM® applid of the CICS® system.

rname

The name of the resource.

NOUPDATE

Allows you to specify that you intend no updates to the data set while executing the utility.

NO

Updates to the data are honored.

YES

Forces the allocation of the data set as input only. All updates to the data are ignored.

MEMBER=*member1*

The name of a single member in a PDS, or a member name pattern representing one or more members in a PDS. If the input data set is a PDS(E), you may specify this parameter, or a member name in the DD statement for *ddname*, or specify a range of member names with the MEMSTART and MEMEND keywords.

A member name pattern can consist of any characters that are valid in a member name and two special pattern characters: the asterisk (*) and the percent symbol (%).

*

represents any number of characters. As many asterisks as required can appear anywhere in a member name pattern. For example, if you enter a member name pattern of *d*, all members in the PDS whose name contains "d" are processed.

%

is a place holding character that means a single character. As many percent symbols as necessary can appear anywhere in a member name pattern. For example, if you enter a member name pattern of %%%%, all members in the PDS whose name is four characters in length are processed.

member1 is ignored if the data set is not a PDS.

MEMSTART=*startstring*

Is used to specify the start of a range of member names to be included in the copy. If MEMSTART is specified but MEMEND is omitted, all members of the PDS(E) from the *startstring* value onwards are included. *startstring* can have the same values, including wild cards, as for the *member1* parameter of the MEMBER keyword.

MEMEND=*endstring*

Is used to specify the end of a range of member names to be included in the copy. If MEMEND is specified but MEMSTART is omitted, all members of the PDS(E) up to the *endstring* value onwards are included. *endstring* can have the same values, including wild cards, as for the *member1* parameter of the MEMBER keyword.

XMEMBERS

Provides a way to exclude from processing library members that would otherwise be selected using the MEMSTART, MEMEND, and MEMBER options.

xmem_filter

A member name filter identifying one or more members that are to be excluded from processing. A filter can be a member name pattern representing multiple members.

To specify a member name filter containing lowercase characters, use a character string in the format `c'string'`. Filter values can also be specified as hexadecimal strings in the format `x'hex-digits'`.

INRDW

Controls whether or not to adjust the input start location when the specified start location takes into account the record descriptor word (RDW).

NO

Does not adjust the input start location.

YES

Subtracts 4 from all start locations that have been coded on external functions that refer to the input record.

OUTRDW

Controls whether or not to adjust the output start location when the specified start location takes into account the record descriptor word (RDW).

NO

Does not adjust the output start location.

YES

Subtracts 4 from all start locations that have been coded on external functions that refer to the output record.

CREATED=*created*

The date on which a member was created, in YYYY/MM/DD format.

If the input data set is a PDS(E), you may specify this parameter, or specify a range of creation dates with the CRESTART and CREEND keywords.

You can specify an asterisk (*) as the last character to indicate a range of dates or a percent sign (%) in place of a single character to indicate a selection of dates.

created is ignored if the data set is not a PDS.

CRESTART=*crestart*

The start of a range of creation dates in YYYY/MM/DD format to be included in the copy.

If CRESTART is specified but CREEND is omitted, all members of the PDS(E) from the *crestart* value onwards are included.

If omitted, or you do not enter a full date, or you specify an asterisk (*) as the last character, the unspecified portion of *crestart* defaults to the right as follows:

DD

= 01

MM

= 01

YYYY

= 0000

No other wildcarding is allowed.

CREEND=*creend*

The end of a range of creation dates in YYYY/MM/DD format to be included in the copy.

If omitted, or you do not enter a full date, or you specify an asterisk (*) as the last character, the unspecified portion of *creend* defaults to the right as follows:

DD

= 31

MM

= 12

YYYY

= 9999

No other wildcarding is allowed.

CHANGED=*changed*

The date on which a member was last modified, in YYYY/MM/DD format.

If the input data set is a PDS(E), you may specify this parameter, or specify a range of modification dates with the CHGSTART and CHGEND keywords.

You can specify an asterisk (*) as the last character to indicate a range of dates or a percent sign (%) in place of a single character to indicate a selection of dates.

changed is ignored if the data set is not a PDS.

CHGSTART=*chgstart*

The start of a range of modification dates in YYYY/MM/DD format to be included in the copy.

If CHGSTART is specified but CHGEND is omitted, all members of the PDS(E) from the *chgstart* value onwards are included.

If omitted, or you do not enter a full date, or you specify an asterisk (*) as the last character, the unspecified portion of *chgstart* defaults to the right as follows:

DD

= 01

MM

= 01

YYYY

= 0000

No other wildcarding is allowed.

CHGEND=*chgend*

The end of a range of modification dates in YYYY/MM/DD format to be included in the copy.

If omitted, or you do not enter a full date, or you specify an asterisk (*) as the last character, the unspecified portion of *chgend* defaults to the right as follows:

DD

= 31

MM

= 12

YYYY

= 9999

No other wildcarding is allowed.

USERID=*userid*

The TSO user ID by which the member was last updated.

If the input data set is a PDS(E), you may specify this parameter, or specify a range of user IDs with the UIDSTART and UIDEND keywords.

You can enter a generic user ID by using asterisks and percent signs.

userid is ignored if the data set is not a PDS.

UIDSTART=*uidstart*

The start of a range of user IDs to be included in the copy.

If UIDSTART is specified but UIDEND is omitted, all members of the PDS(E) from the *uidstart* value onwards are included.

If omitted, or you do not enter a full 7-character user ID, or you specify an asterisk (*) as the last character, File Manager replaces the asterisk and pads the unspecified portion of *uidstart* to the right with low values (X'00').

UIDEND=*uidend*

The end of a range of user IDs to be included in the copy.

If you omit this field, it defaults to high values (X'FF').

If you specify less than 7 characters (without an asterisk as the last character), File Manager pads *uidstart* to the right with low values (X'00'). If you specify an asterisk (*) as the last character, File Manager replaces the asterisk and pads the unspecified portion of *uidend* with high values (X'FF').

POSITION=*skip*

Number of logical records to be skipped from the beginning of the data set. The default is 0.

KEY=*key* (VSAM only)

A key for KSDS records, or a slot number for RRDS records. The maximum key length is 30 characters. The first record with a key or slot value greater than or equal to *key* is the first record updated. If you omit the *key* and *skip* values, updating begins with the first record in the data set.

If the key contains lowercase characters, blanks, or commas, enclose it in quotation marks. You can also specify a key in hexadecimal format (for example, X'C1C2C3').

NLRECS

Number of records to be printed or ALL.

ALL

If you specify ALL or omit the parameter, all the remaining records are copied.

nirecs

The maximum number is 99 999 999.

PACK

Determines if File Manager should detect if the input data is in ISPF packed format.

STOP

Default. File Manager detects whether the input data is in ISPF packed format, and if it is, stops the processing.

CONTINUE

File Manager does not detect whether the input data is in ISPF packed format and continues processing.

STATS=ON

Default. This updates the ISPF statistics (if already present) when a PDS or PDSE member has been changed.

STATS=OFF

The ISPF statistics is not updated when a PDS or PDSE member has been changed.

STATS=FORCE

The ISPF statistics that exist for members being processed are always updated and statistics for a member that previously did not have statistics are created.

USEIOXIN

Specifies whether to invoke a user I/O exit, to process the input data set.

NO

Default. Do not invoke a user I/O exit.

YES

Invoke a user I/O exit to process the input data set. This option is only available if the person who did the site customization for File Manager allowed user I/O exits on a site-wide basis.

IOXIN

Specifies the name of the user I/O exit used for the input data set. There are no restrictions on the programming language that you can use to write an exit. The exit must be provided to File Manager in the STEPLIB/ISPLLIB concatenation or their extensions (LINKLIST, LPA, and so on).

sysexit

Default. If you specify USEIOXIN=YES and do not supply a user I/O exit name, File Manager uses the name of the exit provided in the installation customization options. If USEIOXIN has been set to YES and no installation default has been provided, you must specify IOXIN=*ioxname*.



Note: If you have selected batch processing in an online panel, the generated JCL statements use the default name provided in your Set System Processing Options panel.

ioxname

The name of a PDS(E) member of a data set that has been provided to File Manager in the STEPLIB concatenation.

PROC=*proc*

Member name of a REXX procedure that you want to use to process each record before it is updated, or an asterisk (*) to indicate the REXX procedure is inline. If you specify a member name, you must define an FMNEXEC ddname that identifies the PDS containing the member. If you specify *, the procedure is read from SYSIN immediately following the control statement for the current function. The inline procedure is terminated by a record containing a slash and a plus sign (/+) in columns 1–2.

For more information about using REXX procedures to process records before they are updated, see [Enhancing File Manager processing on page 517](#).

Template processing

Define which template (if any) is used to describe the record structure in the input data set, and how File Manager processes this template.

TINPUT=*ddname*

Defines a reference to a DD or TSO ALLOC statement for the data sets which contain the copybook or template that describes the record structure of your input data. The default is TDDIN.

If you specify a concatenated DD, then you must provide the member name, *member*.

TINMEM=*member*

The name of the copybook or template member in the datasets identified by the TINPUT parameter if it has not been specified on the DD statement. This parameter must not be specified if the TCIN parameter is specified.

TCIN=*tcin(member)*

PDS and member name of the copybook or template that describes the record structure of your input data.



Note: If you specify a template for DSEB and DSU, it is ignored, except for calls to the external REXX function PRINT specifying TABL or SNGL format.

OFFSETIN

The length of the 01 field in the template and the start locations of the fields within that 01 field are adjusted by the value provided.

value

The offset value, which must be in the range -32760 to 32760, to be applied to the corresponding field identifier. If no field identifier is supplied and ALL is not used, the value is applied to the first Level 01 field in the template.

ALL

Where the template contains multiple record structures, this keyword applies the corresponding *value* to all Level 01 fields within the template.



Note: You can specify a value for ALL and then override this value for individual layouts by providing subsequent *value* and *fieldname* combinations.

fieldname

The name of the Level 01 field to which *value* is to be applied. The default is the first Level 01 field in the template.

MEMLIST

Allows you to specify a list of member names.

member_n

The name of the member to be processed. Generic name masks are allowed.

Copybook processing

If you specify a copybook (instead of an existing template), File Manager uses these processing options to compile the copybook into a template:

LANG

Determines whether File Manager automatically detects the copybook language or interprets the language as COBOL, PL/I, or HLASM.



Note: The COMPLANG setting in FMN0POPT is the equivalent of the LANG parameter in batch functions.

- If COMPLANG is set it determines the installation default language for online and batch compilation.
- If COMPLANG is not specified then COBOL is the installation default for online compilation and AUTO is the default for batch compilation.
- If a value of COBOL, HLASM, PL/1, or AUTO is specified (in the **Compiler Language Selection** panel or through the LANG parameter in a batch job) it overrides the default language.

AUTO

Automatically detect whether the copybook language is COBOL or PL/I, and invoke the appropriate compiler. If the compilation results in a return code greater than 4, then invoke the compiler for the other language. If the second compilation also results in a return code greater than 4, then retry the first compiler and report the compilation errors. If File Manager successfully creates a template (despite the compilation errors), then continue processing with the template.

COBOL

Invoke the COBOL compiler to create a template from the copybook. (Do not invoke the PL/I compiler, even if the COBOL compilation results in errors.)

PLI

Invoke the PL/I compiler to create a template from the copybook. (Do not invoke the COBOL compiler, even if the PL/I compilation results in errors.)

HLASM

Invoke the HLASM compiler to create a template from the copybook.

DSINFO

Specifies whether additional data set information for input and output sources should be produced in batch reports for the DSP, DSM, DSC, and FCH commands.

NO

No additional data set information is generated.

YES

Generates data set information including DSORG, RECFM, LRECL, BLKSIZE, and VSAM attributes including average record length, maximum record length, key offset, key length and reuse, for input and output data sets when applicable.

COBOL options

The following options are used to compile a COBOL copybook into a template:

DBCS=YES

Use the DBCS compiler option.

DBCS=NO

Use the NODBCS compiler option.

For details on the effect of the DBCS and NODBCS compiler options, see the *IBM COBOL Programming Guide for OS/390 & VM*.

CDPC=NO

Do not use the COBOL SPECIAL-NAMES paragraph "Decimal-point is comma".

CDPC = YES

Use the COBOL SPECIAL-NAMES paragraph "Decimal-point is comma".

CAE=NO

Do not use the COBOL compile option ARITH(EXTEND).

CAE = YES

Use the COBOL compile option ARITH(EXTEND).

MIXED = NO

Field names stored in the template in uppercase.

MIXED = YES

Field names stored in the template in the original case as coded in the COBOL copybook.

RFROM1 RT01 ... RFROM5 RT05

Up to five pairs of “From” and “To” pseudo-text character strings for the COBOL REPLACE compiler-directing statement.

If your COBOL copybooks contain characters that you want to remove or replace with other characters before compiling the copybooks into templates, then use these replacing options.

For example, if your copybooks contain colon characters (:) that you want to remove before compiling, then specify `'::::::'` as *operand1* and `'::::::'` as *operand2*.

For details on specifying “From” and “To” strings for COBOL REPLACE, see the *IBM COBOL Language Reference*.

CBLMAXRC

Sets the maximum acceptable return code for a copybook compile. A return code higher than the specified level causes the function to stop. Default is 4.



Note: The COMPMAXRC parameter is still supported but it is recommended that the CBLMAXRC parameter is used instead. If you do specify the COMPMAXRC parameter, it takes precedence over the language MAXRC.

CBLLIBS

Allows you to specify a list of up to ten data set names to be specified in the SYSLIB concatenation list. These data sets are searched in the order specified for COPY and INCLUDE members for the compilation.

dsname

The name of the data set name to be processed. Generic name masks are not allowed.

CBLADDOP

Additional COBOL compiler options which are included in a CBL statement when compiling COBOL copybooks.

PL/I options

The following options are used to compile a PL/I copybook into a template:

BIN63=YES

Use the LIMITS(FIXEDBIN(63)) compiler option.

BIN63=NO

Use the LIMITS(FIXEDBIN(31)) compiler option.

DEC31=YES

Use the LIMITS(FIXEDDEC(31)) compiler option.

DEC31=NO

Use the LIMITS(FIXEDDEC(15)) compiler option.

GRAPHIC=YES

Use the GRAPHIC compiler option.

GRAPHIC=NO

Use the NOGRAPHIC compiler option.

UNALIGNED=YES

Use the DEFAULT RANGE (*) UNALIGNED, language statement to change the default alignment.

UNALIGNED=NO

Use the PL/I default.

PLIMAXRC

Sets the maximum acceptable return code for a copybook compile. A return code higher than the specified level causes the function to stop. Default is 4.



Note: The COMPMAXRC parameter is still supported but it is recommended that the PLIMAXRC parameter is used instead. If you do specify the COMPMAXRC parameter, it takes precedence over the language MAXRC.

PLILIBS

Allows you to specify a list of up to ten data set names to be specified in the SYSLIB concatenation list. These data sets are searched in the order specified for COPY and INCLUDE members for the compilation.

dsname

The name of the data set name to be processed. Generic name masks are not allowed.

PLIADDOP

Additional PL/I compiler options which are included in a *PROCESS statement when compiling PL/I copybooks.

For details on the effect of these compiler options, see the *IBM VisualAge PL/I for OS/390 Programming Guide*.

HLASM options

The following options are used to compile a HLASM copybook into a template:

DBCS=YES

Use the DBCS compiler option.

DBCS=NO

Use the NODBCS compiler option.

NOALIGN=YES

Use the NOALIGN compiler option.

NOALIGN=NO

Use the ALIGN compiler option.

ASMMAXRC

Sets the maximum acceptable return code for a copybook compile. A return code higher than the specified level causes the function to stop. Default is 4.



Note: The COMPMAXRC parameter is still supported but it is recommended that the ASMMAXRC parameter is used instead. If you do specify the COMPMAXRC parameter, it takes precedence over the language MAXRC.

ASMLIBS

Allows you to specify a list of up to ten data set names to be specified in the SYSLIB concatenation list. These data sets are searched in the order specified for COPY and INCLUDE members for the compilation.

dsname

The name of the data set name to be processed. Generic name masks are not allowed.

ASMADDOP

Additional HLASM compiler options which are included in a *PROCESS statement when compiling COPY and MACRO members.

For details on the effect of these compiler options, see the *HLASM V1R6 Programmer's Guide*.

```
//DSU JOB (acct),'name' PDS Member Update
//*
//FMBAT PROC
//FMBAT EXEC PGM=FILEMGR
//STEPLIB DD DSN=FMN.SFMNMOD1,DISP=SHR
//SYSPRINT DD SYSOUT=*
//SYSABEND DD SYSOUT=*
//SYSUDUMP DD SYSOUT=*
// PEND
//*
//FILEMGR EXEC FMBAT
//FMNTSPRT DD SYSOUT=*
//JCLPDS DD DSN=FMNUSER.FM0S390.JCL,DISP=SHR
//SYSIN DD *
$$FILEM DSU INPUT=JCLPDS,MEMBER=*,PROC=*
/* Translate all records to uppercase */
Upper outrec
```

```

Return
/+
$$$FILEM E0J
/*

//DSU JOB (acct),'name' Fix post code
//*
//FMBAT PROC
//FMBAT EXEC PGM=FILEMGR
//STEPLIB DD DSN=FMN.SFMNMOD1,DISP=SHR
//SYSPRINT DD SYSOUT=*
//SYSABEND DD SYSOUT=*
//SYSUDUMP DD SYSOUT=*
// PEND
//*
//FILEMGR EXEC FMBAT
//FMNTSPRT DD SYSOUT=*
//SYSIN DD *
$$$FILEM DSU DSNIN=FMNUSER.FM0S390.TRANRECS,
$$$FILEM PROC=*
/* Locate name and address record for James */
/* Browne and change postcode, stored in */
/* packed decimal, from 6011 to 6194 */
If Substr(inrec,1,1) == 'A' &
   Substr(inrec,32,5) == 'James' &
   Substr(inrec,57,6) == 'Browne' then
   outrec = Change(outrec,'06011F'x,'06194F'x,1,125,3)
Return
/+
$$$FILEM E0J
/*

```

DSV (Data Set View)

Purpose

The DSV function displays the Data Set View or View Entry panel, in online mode. This function can be invoked from a REXX program or a TSO clist or entered on an ISPF Command line, but **cannot** be used in batch jobs as it is an interactive function.

Usage notes

When invoked from an ISPF Command line without a parameter, the Data Set View Entry panel is displayed in interactive mode and you can specify a valid data set for browsing. If you include a valid data set name as a parameter, then you bypass the Entry panel, and go directly to viewing the specified data set.

When invoked from a REXX procedure or TSO list, you must supply the data set name.

Related functions

DSB

Display Data Set Browse or Browse Entry panel

DSE

Display Data Set Edit or Edit Entry panel

DSEB

Update disk data set records

DSU

Update disk data set records

Figure 437. Syntax

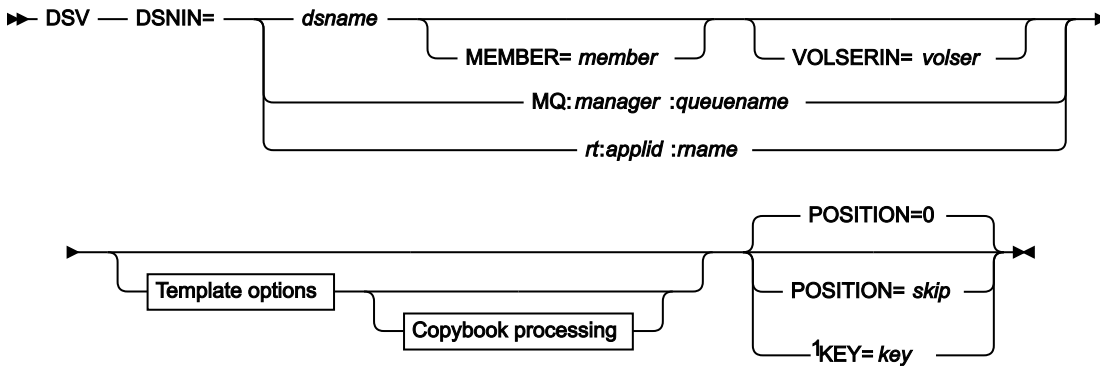

Template options

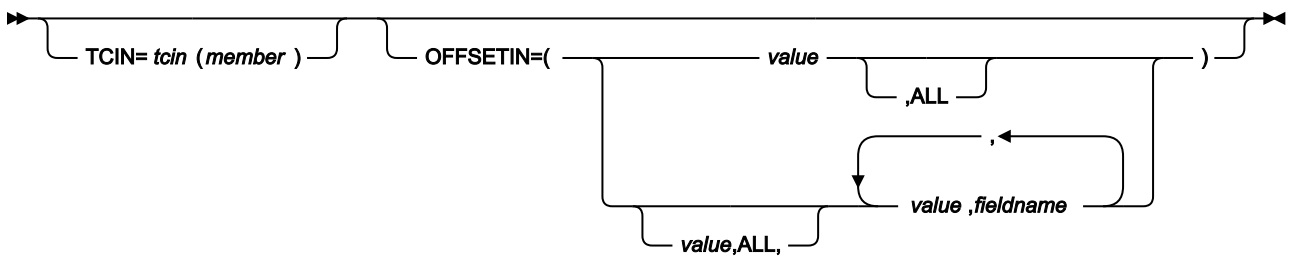

Copybook processing

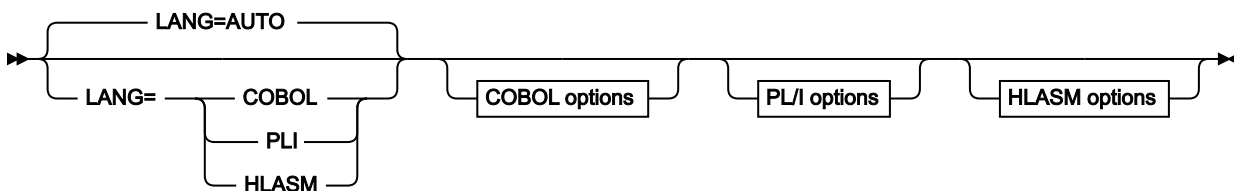

COBOL options

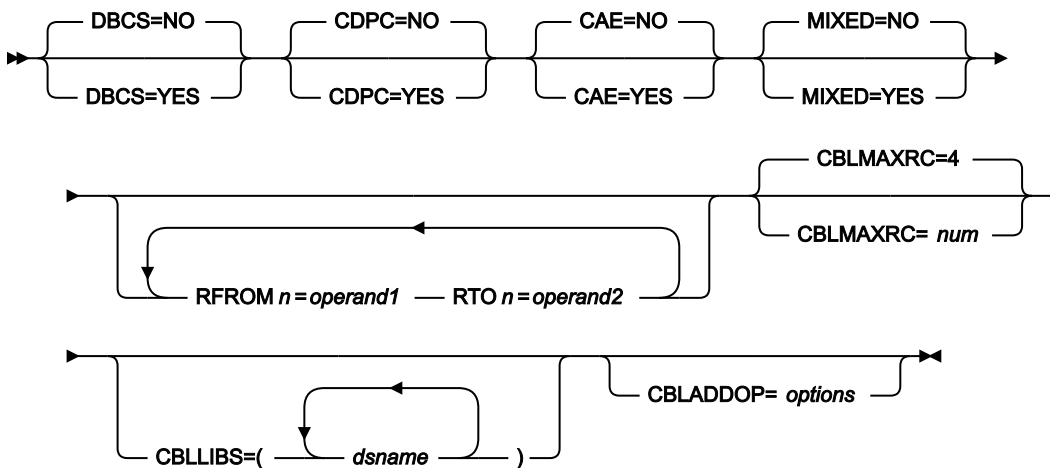

Notes:

¹ VSAM only.

PL/I options

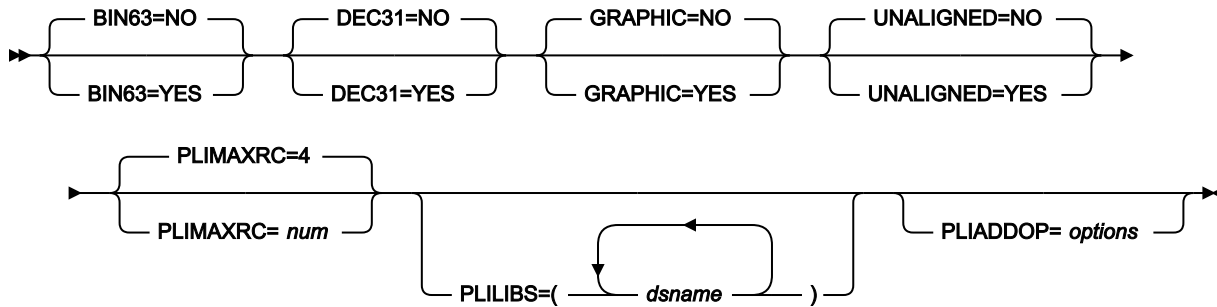

HLASM options

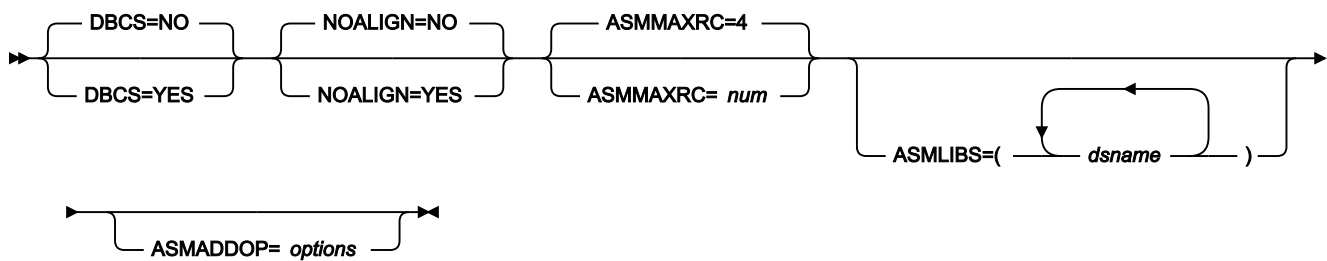
**DSNIN=dsname**

Defines the name of the data set to be viewed. If any DD statements are specified, they are not used. The name may include a member name in parenthesis. If the member is specified here, the associated Member parameter must be empty. Must be specified when \$DSV is invoked from a REXX procedure or TSO clist.

Can be omitted when DSV is entered on a command line. If specified, you bypass the Entry panel, and go directly to the Data Set View panel. When omitted, the Data Set View Entry panel is displayed in interactive mode and you can specify a valid data set for browsing.

You can further describe this data set, as follows:

MEMBER=member

The name of a single member in a PDS, or a member name pattern representing one or more members in a PDS. If the data set is a PDS, you must specify this parameter.

A member name pattern can consist of any characters that are valid in a member name and two special pattern characters: the asterisk (*) and the percent symbol (%).

*

represents any number of characters. As many asterisks as required can appear anywhere in a member name pattern. For example, if you enter a member name pattern of *d*, all members in the PDS whose name contains "d" are processed.

%

is a place holding character that means a single character. As many percent symbols as necessary can appear anywhere in a member name pattern. For

example, if you enter a member name pattern of `****`, all members in the PDS whose name is four characters in length are processed.

`MEMBER=member` is ignored if the data set is not a PDS.

`VOLSERIN=volser`

Volume serial number for a non-cataloged data set.

`MQ:manager.queueName`

You can specify a MQ queue in place of a data set name, where:

`manager`

The MQ manager to be used. If you specify a generic name, File Manager displays a list of matching managers to select from.

`queueName`

The queue to be used. If you specify a generic name, File Manager displays a list of matching queues to select from.

`rt.applid:rname`

You can specify a CICS® resource in place of a data set name, where:

`rt`

Resource type. Valid values are:

FI

For a CICS® file.

TD

For a Transient Data Queue.

TS

For a Temporary Storage Queue.

`applid`

The VTAM® applid of the CICS® system.

`rname`

The name of the resource.

`POSITION=skip`

Number of logical records to be skipped from the beginning of the data set. The default is 0.

`KEY=key (VSAM only)`

A key for KSDS records, or a slot number for RRDS records. The maximum key length is 30 characters. The first record with a key or slot value greater than or equal to *key* is the first record copied. If you omit the *key* and *skip* values, browsing begins with the first record in the data set.

If the key contains lowercase characters, blanks, or commas, enclose it in quotation marks. You can also specify a key in hexadecimal format (for example, X'C1C2C3').

TCIN=*tcin(member)*

PDS and member name of the copybook or template that describes the record structure of your data set.

OFFSETIN

The length of the 01 field in the template and the start locations of the fields within that 01 field are adjusted by the value provided.

value

The offset value, which must be in the range -32760 to 32760, to be applied to the corresponding field identifier. If no field identifier is supplied and ALL is not used, the value is applied to the first Level 01 field in the template.

ALL

Where the template contains multiple record structures, this keyword applies the corresponding *value* to all Level 01 within the template.



Note: You can specify a value for ALL and then override this value for individual layouts by providing subsequent *value* and *fieldname* combinations.

fieldname

The name of the Level 01 field to which *value* is to be applied. The default is the first Level 01 field in the template.

Copybook processing

If you specify a copybook (instead of an existing template), File Manager uses these processing options to compile the copybook into a template:

LANG

Determines whether File Manager automatically detects the copybook language or interprets the language as COBOL, PL/I, or HLASM.



Note: The COMPLANG setting in FMN0POPT is the equivalent of the LANG parameter in batch functions.



- If COMPLANG is set it determines the installation default language for online and batch compilation.
- If COMPLANG is not specified then COBOL is the installation default for online compilation and AUTO is the default for batch compilation.
- If a value of COBOL, HLASM, PL/I, or AUTO is specified (in the **Compiler Language Selection** panel or through the LANG parameter in a batch job) it overrides the default language.

AUTO

Automatically detect whether the copybook language is COBOL or PL/I, and invoke the appropriate compiler. If the compilation results in a return code greater than 4, then invoke the compiler for the other language. If the second compilation also results in a return code greater than 4, then retry the first compiler and report the compilation errors. If File Manager successfully creates a template (despite the compilation errors), then continue processing with the template.

COBOL

Invoke the COBOL compiler to create a template from the copybook. (Do not invoke the PL/I compiler, even if the COBOL compilation results in errors.)

PLI

Invoke the PL/I compiler to create a template from the copybook. (Do not invoke the COBOL compiler, even if the PL/I compilation results in errors.)

HLASM

Invoke the HLASM compiler to create a template from the copybook.

DSINFO

Specifies whether additional data set information for input and output sources should be produced in batch reports for the DSP, DSM, DSC, and FCH commands.

NO

No additional data set information is generated.

YES

Generates data set information including DSORG, RECFM, LRECL, BLKSIZE, and VSAM attributes including average record length, maximum record length, key offset, key length and reuse, for input and output data sets when applicable.

COBOL options

The following options are used to compile a COBOL copybook into a template:

DBCS=YES

Use the DBCS compiler option.

DBCS=NO

Use the NODBCS compiler option.

For details on the effect of the DBCS and NODBCS compiler options, see the *IBM COBOL Programming Guide for OS/390 & VM*.

CDPC=NO

Do not use the COBOL SPECIAL-NAMES paragraph "Decimal-point is comma".

CDPC = YES

Use the COBOL SPECIAL-NAMES paragraph "Decimal-point is comma".

CAE=NO

Do not use the COBOL compile option ARITH(EXTEND).

CAE = YES

Use the COBOL compile option ARITH(EXTEND).

MIXED = NO

Field names stored in the template in uppercase.

MIXED = YES

Field names stored in the template in the original case as coded in the COBOL copybook.

RFROM1 RT01 ... RFROM5 RT05

Up to five pairs of "From" and "To" pseudo-text character strings for the COBOL REPLACE compiler-directing statement.

If your COBOL copybooks contain characters that you want to remove or replace with other characters before compiling the copybooks into templates, then use these replacing options.

For example, if your copybooks contain colon characters (:) that you want to remove before compiling, then specify '==:==' as *operand1* and '=====' as *operand2*.

For details on specifying "From" and "To" strings for COBOL REPLACE, see the *IBM COBOL Language Reference*.

CBLMAXRC

Sets the maximum acceptable return code for a copybook compile. A return code higher than the specified level causes the function to stop. Default is 4.



Note: The COMPMAXRC parameter is still supported but it is recommended that the CBLMAXRC parameter is used instead. If you do specify the COMPMAXRC parameter, it takes precedence over the language MAXRC.

CBLLIBS

Allows you to specify a list of up to ten data set names to be specified in the SYSLIB concatenation list. These data sets are searched in the order specified for COPY and INCLUDE members for the compilation.

dsname

The name of the data set name to be processed. Generic name masks are not allowed.

CBLADDOP

Additional COBOL compiler options which are included in a CBL statement when compiling COBOL copybooks.

PL/I options

The following options are used to compile a PL/I copybook into a template:

BIN63=YES

Use the LIMITS(FIXEDBIN(63)) compiler option.

BIN63=NO

Use the LIMITS(FIXEDBIN(31)) compiler option.

DEC31=YES

Use the LIMITS(FIXEDDEC(31)) compiler option.

DEC31=NO

Use the LIMITS(FIXEDDEC(15)) compiler option.

GRAPHIC=YES

Use the GRAPHIC compiler option.

GRAPHIC=NO

Use the NOGRAPHIC compiler option.

UNALIGNED=YES

Use the DEFAULT RANGE (*) UNALIGNED, language statement to change the default alignment.

UNALIGNED=NO

Use the PL/I default.

PLIMAXRC

Sets the maximum acceptable return code for a copybook compile. A return code higher than the specified level causes the function to stop. Default is 4.



Note: The COMPMAXRC parameter is still supported but it is recommended that the PLIMAXRC parameter is used instead. If you do specify the COMPMAXRC parameter, it takes precedence over the language MAXRC.

PLILIBS

Allows you to specify a list of up to ten data set names to be specified in the SYSLIB concatenation list. These data sets are searched in the order specified for COPY and INCLUDE members for the compilation.

dsname

The name of the data set name to be processed. Generic name masks are not allowed.

PLIADDOP

Additional PL/I compiler options which are included in a *PROCESS statement when compiling PL/I copybooks.

For details on the effect of these compiler options, see the *IBM VisualAge PL/I for OS/390 Programming Guide*.

HLASM options

The following options are used to compile a HLASM copybook into a template:

DBCS=YES

Use the DBCS compiler option.

DBCS=NO

Use the NODBCS compiler option.

NOALIGN=YES

Use the NOALIGN compiler option.

NOALIGN=NO

Use the ALIGN compiler option.

ASMMAXRC

Sets the maximum acceptable return code for a copybook compile. A return code higher than the specified level causes the function to stop. Default is 4.



Note: The COMPMAXRC parameter is still supported but it is recommended that the ASMMAXRC parameter is used instead. If you do specify the COMPMAXRC parameter, it takes precedence over the language MAXRC.

ASMLIBS

Allows you to specify a list of up to ten data set names to be specified in the SYSLIB concatenation list. These data sets are searched in the order specified for COPY and INCLUDE members for the compilation.

dsname

The name of the data set name to be processed. Generic name masks are not allowed.

ASMADDOP

Additional HLASM compiler options which are included in a *PROCESS statement when compiling COPY and MACRO members.

For details on the effect of these compiler options, see the *HLASM V1R6 Programmer's Guide*.

For more information on using this function, see:

- [Invoking File Manager panels from outside File Manager on page 39](#)
- [Introduction to programming with File Manager functions on page 503](#)
- [Invoking File Manager panels from REXX procedures or TSO clists on page 507](#)

```
FILEMGR "$DSV DSNIN='FMNUSER.TEST.KSDS1',KEY=000100"
```

```
FILEMGR DSV
```

DSX (Data Set Extents)

Purpose

Display the extents of a data set.

Usage notes

Use this function to display the "begin" and "end" of the extents of a data set.

Use the information for all basic disk functions which require the location of a disk extent.

For multivolume data sets, only the extents on the selected volume are shown.

Absolute disk extents and disk extents relative to the beginning of the data set are displayed.

Options

None.

Related functions**DSU**

Update disk data set records

DVT

Print VTOC entries

Figure 438. Syntax

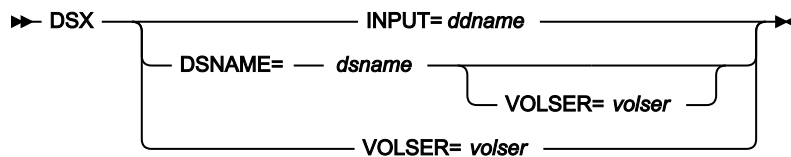
**ddname**

Refers to a DD or TSO ALLOC statement.

dsname

Name of a disk data set.

volser

Volume serial number for a non-cataloged data set.

```

//DP JOB (acct),'name' Data Set Extents
//*
//FMBAT PROC
//FMBAT EXEC PGM=FILEMGR
//STEPLIB DD DSN=FMN.SFMNMOD1,DISP=SHR
//SYSPRINT DD SYSOUT=*
//SYSABEND DD SYSOUT=*
//SYSUDUMP DD SYSOUT=*
// PEND
//*
//FILEMGR EXEC FMBAT
//DISK DD DSN=SYS1.PROCLIB,DISP=SHR
//SYSIN DD *
$$$FILEM DSX INPUT=DISK
$$$FILEM EOJ
/*
  
```

DVT (Display VTOC)**Purpose**

Display or print a list of the data sets on a disk volume obtained from the disk VTOC.

Usage notes

Use this function to display or print information about data sets and free space on a disk volume. The information is obtained from the disk VTOC. In the list, you can scroll forward and backward, select the alternate display, and locate specific data set names. You can print this list.

You can sort the information by any one of several criteria (see following description for the DVT function variable, *sortdsnby*). The listing also shows free extents on the disk.

Alternatively, you can request that only a VTOC summary, similar to that shown in [Figure 107: Work with VTOC: list of volumes on page 435](#), is produced. You can sort the summary list by any one of several criteria (see following description for the DVT function variable, *sortvolby*).

You can also request for a combined data set and summary list report to be produced.



Note: DVT shows “never to expire” expiration dates of 99/999 and 99/366 as 9999.999 and 9999.366, respectively. An expiration date that was explicitly specified as 99/365 is also considered “never to expire”, and is shown as 9999.365. However, an expiration date of 99/365 that was calculated from a specified retention period (current date + number of days = 99/365) *will* expire, and is shown as 1999.365. If you sort the list by expiration date, values beginning with 9999 appear first.

Options

Use a fully-qualified or generic file ID, or search patterns to limit the output. The list can be sorted by entry name, creation date, expiration date, or disk extent.

Return codes

The default return codes from the DVT function have the following modified meanings:

4

No data sets found

4

No data set matches pattern on selected volumes

4

No volume matches pattern

16

Volume not mounted

16

Insufficient storage available

16

DVT abended

16

Other serious error that stops processing occurred (for example an input or output error)



Note: Return codes can be customized during installation. If you receive return codes that do not match those listed above, your site might have customized the return codes for this function. File Manager may also issue the 999 abend, if the return code in batch is equal to or greater than the ABENDCC value. Contact your File Manager systems administrator for details.

Related function

DSX

Display the extents of a data set

Figure 439. Syntax

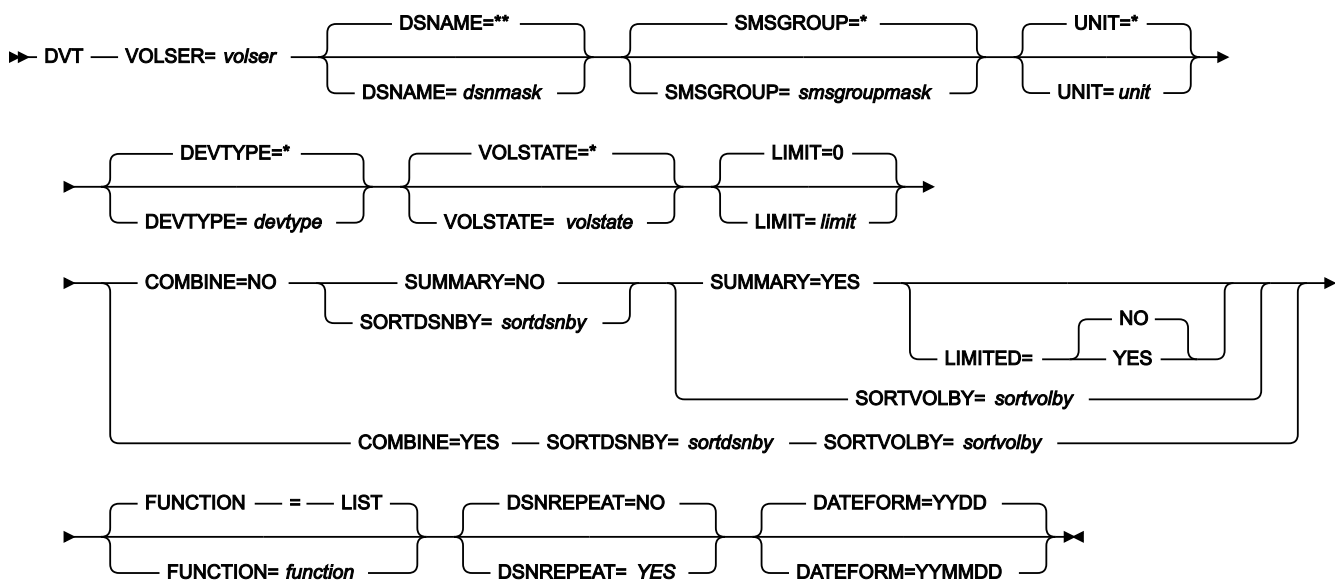

volser

Volume serial number of the disk. Can include a "volume mask" with a percent sign (%) representing exactly one character, or an asterisk (*) representing any number of characters (or no characters). Only volumes matching the mask participate in processing.

dsnmask

A generic data set name, or search pattern. Within the data set name, you can include a percent sign (%) to represent exactly one character, an asterisk (*) to represent any number of characters (or no characters) within a qualifier, or two asterisks (**) to represent any number of characters (or no characters) within any number of qualifiers. The default is **.

If you also specify a "volume mask" in **volser**, only volumes having data sets matching the dsnmask participate in the processing.

In any mode except batch mode, the user's TSO prefix (normally the user ID) is used as the high-level qualifier for any name that is not entered in quotation marks. For example, the default of ** lists all entries in batch mode; in any other mode, it lists all entries that have the user's TSO prefix as high-level qualifier.

smsgroupmask

A generic SMS storage group name, or search pattern. Within the name, you can include a percent sign (%) to represent exactly one character, an asterisk (*) to represent any number of characters (or no characters).

unit

A generic device address, or search pattern. Within the address, you can include a percent sign (%) to represent exactly one character, an asterisk (*) to represent any number of characters (or no characters).

devtype

A generic device type name, or search pattern. Within the name, you can include a percent sign (%) to represent exactly one character, an asterisk (*) to represent any number of characters (or no characters).

volstate

A generic volume status name, or search pattern. Within the name, you can include a percent sign (%) to represent exactly one character, an asterisk (*) to represent any number of characters (or no characters).

The following full names are supported:

- PRIVATE (also includes PRIV/RSDNT)
- RESIDENT
- PUBLIC
- STORAGE
- ALL

limit

The maximum number of data sets to be selected for processing. The default (0) indicates that there is no limit on the number of data sets selected.

function

The command that you want to execute:

LIST

Display the list (the default)

PRINT

Print the list

SUMMARY

Determines whether or not the VTOC list is produced in full or as a summary.

NO

(Default) The full list is produced.

YES

A summary is produced and the SORTBY parameter is ignored. The list is sorted by device number.

LIMITED

Determines where the volume summary list (SUMMARY=YES) contains detailed (NO) or limited (YES) data about the number of datasets located on the volumes processed. Specifying LIMITED=YES provides faster response times.

NO

Detailed dataset information included in the volume summary list.

YES

No dataset counts provided in the volume summary list.

sortdsnby

Determines the sequence in which the VTOC data set list appears:

NAME

Sorted by data set name

VOLSER

Sorted by volume serial

EXTENT

Sorted by extent

SIZE

Sorted by data set size

TYPE

Sorted by DSORG

RECFM

Sorted by RECFM

LRECL

Sorted by LRECL

BLKSIZE

Sorted by BLKSIZE

DATE

Sorted by creation date

EDATE

Sorted by expiration date

RDATE

Sorted by last referred date

sortvolby

Determines the sequence in which the VTOC volume list appears:

VOLSER

Sorted by volume serial

UNIT

Sorted by device address (unit)

DTYPE

Sorted by device type

SMSSG

Sorted by SMS storage group

TTTRK

Sorted by disk capacity

USTRK

Sorted by tracks used

USPTRK

Sorted by utilization in %

TRKF

Sorted by tracks available

TDSN

Sorted by number of data sets

TVSDSN

Sorted by number of VSAM data sets

TNVSDSN

Sorted by number of non-VSAM data sets

SVTOC

Sorted by VTOC size

UPVTOC

Sorted by VTOC utilization in %

INDX

Sorted by VTOC indexing

DSCBS

Sorted by VTOC free DSCBs

FCYL

Sorted by cylinders available

MFCYL

Sorted by maximum free space in cylinders

FTRK

Sorted by tracks available

MFTRK

Sorted by maximum free space in tracks

COMBINE

Determines whether a combined data set and volume summary list report is produced.

NO

Does not produce a combined data set and volume summary list report.

YES

Produces a combined data set and volume summary list report.

DSNREPEAT

Determines whether a combined data set and volume summary list report is produced.

NO

Suppresses the data set name on the second and subsequent extents.

YES

The data set name appears for each extent.

DATEFORM

Determines the display format for the date fields.

YYDD

Use the date format YYYY.DDD.

YYMMDD

Use the date format YY/MM/DD.

```
//DVT JOB (acct),'name' Display VTOC
//*
//FMBAT PROC
//FMBAT EXEC PGM=FILEMGR
//STEPLIB DD DSN=FMN.SFMNMOD1,DISP=SHR
//SYSPRINT DD SYSOUT=*
//SYSABEND DD SYSOUT=*
```

```
//SYSUDUMP DD SYSOUT=*
//          PEND
//*
//FILEMGR EXEC FMBAT
//SYSPRINT DD SYSOUT=*
//SYSIN    DD *
$$FILEM DVT VOLSER=SCPMV5,DSNAME=**,SORTBY=DATE
$$FILEM EOJ
/*
```

EOJ (End of Job)

Purpose

Exit File Manager.

No parameters.

ERT (Erase Tape)

Purpose

Erase a tape from the current position until the end of the tape.

Usage notes

This function writes two tape marks at the current tape position, erases the remainder of the tape, then rewinds the tape.

ERT can be used only with tape units that support the data security erase I/O command code, such as the IBM® 3400 series.

Options

None.

Related functions

REW

Rewind a tape to its load point

RUN

Rewind a tape and unload it

WTM

Write one or more tape marks

Figure 440. Syntax



ddname

Refers to a DD or TSO ALLOC statement.

LABEL=BLP

Specifies that bypass label processing is used. This parameter must be specified with the first File Manager function that uses the tape. For BLP processing requirements, see “Customizing the Security Environment” in the *File Manager for z/OS Customization Guide*.

mm

A 2-byte tape mode as shown in [Tape density and mode values on page 449](#).

EVC (Exported Stacked Volume Copy)**Purpose**

Copy a logical volume from an Exported Stacked Volume to a physical volume.

Usage notes

If either the input volume or the output volume are not at their load point, this function rewinds the volumes.

The input volume is verified to ensure that it was created by the VTS export function. If valid, then the Table of Contents located at the end of the Exported Stacked Volume volume is read. The Exported Stacked Volume is then rewound again before the copy process starts.

The requested logical volumes are then copied to the physical volumes. The copy sequence is the same as the sequence of the logical volumes on the Exported Stacked Volume. The requested list of logical volumes is internally sorted into the same sequence as the Exported Stacked Volume Table of Contents to enable all copies to be completed without the need to rewind the input volume during the copy process.

Specify a DDNAME for the tape. If the DDNAME is not allocated, you are asked for allocation information.

You can copy up to 5 logical volumes in a single step.

If you do not know the VOLSER and first data set name of the tape, specify BLP during allocation.

For more information about using this function, see [ESV options on page 452](#).

Options

None.

Related function**EVL**

Print a table of contents list for an Exported Stacked Volume

Figure 441. Syntax

**ddname**

Refers to a DD or TSO ALLOC statement.

There must be one to one correspondence between the logical volumes requested (*ivolser*) and the physical output volumes specified in the VOL= parameter of the DD statement specified by *ddname* in the OUTPUT parameter.

LABEL=BLP

Specifies that bypass label processing is used. This parameter must be specified with the first File Manager function that uses the tape. For BLP processing requirements, see “Customizing the Security Environment” in the *File Manager for z/OS Customization Guide*.

ivolser

Logical volume numbers of the volumes to be copied. Use VOL1 for a standard labeled volume. Specify up to five logical volume numbers in the form (*ivolser1, ivolser2, ...*).

The logical volume numbers must be unique, duplicates are not permitted (that is, one logical volume cannot be specified more than once). Each logical volume is copied to a single physical output volume (specified in *tapevol*).

mm

A 2-byte tape mode as shown in [Tape density and mode values on page 449](#).

```
//EVC JOB (acct),'name' Exported Stacked Volume Copy
/* Copy 1 logical volume to 1 specified volume
//DTCOEV EXEC PGM=FILEMGR
//STEPLIB DD DSN=FMN.SFMNMOD1,DISP=SHR
//SYSPRINT DD SYSOUT=*
//TAPE1 DD UNIT=561,VOL=SER=ESV001,
// DISP=SHR,LABEL=(,BLP)
//TAPE2 DD UNIT=562,VOL=SER=NEWVOL,
// DISP=SHR,LABEL=(,BLP)
//SYSIN DD *
$$FILEM EVC INPUT=TAPE1,OUTPUT=TAPE2,VOLSER=LVL03
$$FILEM E0J
/*
```

```
File Manager
$$FILEM EVC INPUT=TAPE1,OUTPUT=TAPE2,VOLSER=LVL03
Logical volume LVL03 being copied to physical volume NEWVOL
Standard Label File Number 1 DSN='LVL03.TEST '
Copy of logical volume LVL03 to physical volume NEWVOL complete
EVC completed
```

```
//EVC JOB (acct),'name' Exported Stacked Volume Copy
/* Copy 2 logical volumes to 2 specified volumes
//DTCOEV EXEC PGM=FILEMGR
//STEPLIB DD DSN=FMN.SFMNMOD1,DISP=SHR
//SYSPRINT DD SYSOUT=*
//TAPE1 DD UNIT=561,VOL=SER=ESV001,
// DISP=SHR,LABEL=(,BLP)
//TAPE2 DD UNIT=562,VOL=SER=(NEWVL1,NEWVL2),
// DISP=SHR,LABEL=(,BLP)
//SYSIN DD *
$$FILEM EVC INPUT=TAPE1,OUTPUT=TAPE2,
$$FILEM VOLSER=(LVL03,LVL06)
```



```

$$$$FILEM E0J
/*

//EVC JOB (acct),'name'  Exported Stacked Volume Copy
//* Copy 5 logical volumes to 5 scratch volumes
//DTEVC   EXEC PGM=FILEMGR
//STEPLIB DD DSN=FMN.SFMNMOD1,DISP=SHR
//SYSPRINT DD SYSOUT=*
//TAPE1   DD UNIT=561,VOL=SER=ESV001,
//        DISP=SHR,LABEL=(,BLP)
//TAPE2   DD UNIT=562,DISP=(NEW,PASS),LABEL=(,SL)
//SYSIN   DD *
$$$$FILEM EVC INPUT=TAPE1,OUTPUT=TAPE2,
$$$$FILEM   VOLSER=(LVOL03,LVOL06,LVOL01,LVOL99,LVOL10)
$$$$FILEM E0J
/*

```

EVL (Exported Stacked Volume List)

Purpose

List the contents of an Exported Stacked Volume.

Usage notes

File Manager first verifies that the volume loaded was created by the VTS export function. File Manager forward spaces the volume to the Table of Contents and then prints a listing of the Table of Contents. The sequence printed is the same as the sequence of the logical volumes on the Exported Stacked Volume.

You can choose a short listing using the SHORT listing type, which prints only the logical volumes on the Exported Stacked Volume, or you can obtain a more detailed list of the Table of Contents by using the LONG listing type. This listing shows standard label header and trailer information and the location of tape marks.

Specify a DDNAME for the tape. If the DDNAME is not allocated, you are asked for allocation information.

If you do not know the VOLSER and first data set name of the tape, specify BLP during allocation.

For more information about using this function, see [ESV options on page 452](#).

Options

None.

Related function

EVC

Copy a logical volume from an Exported Stacked Volume

Figure 442. Syntax

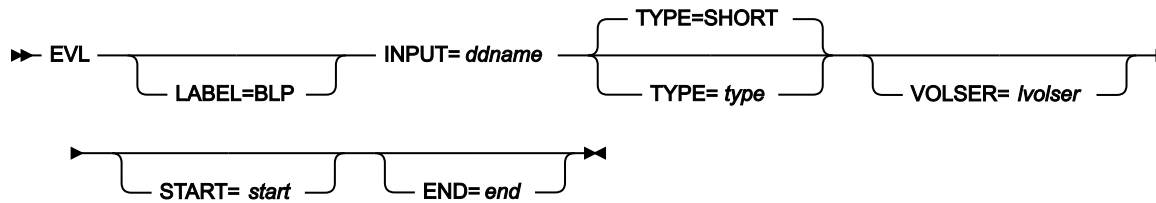
**ddname**

Refers to a DD or TSO ALLOC statement.

end

The relative number of the logical volume on the input Exported Stacked Volume where the listing is to stop. For example, END=9 causes the listing of logical volumes to stop after volume 9 has been listed. If omitted, or greater than the number of logical volumes on the input Exported Stacked Volume, then the value defaults to the maximum number of volumes on the input Exported Stacked Volume. Ignored if TYPE=SHORT, or VOLSER has been specified.

LABEL=BLP

Specifies that bypass label processing is used. This parameter must be specified with the first File Manager function that uses the tape. For BLP processing requirements, see "Customizing the Security Environment" in the *File Manager for z/OS Customization Guide*.

ivolser

Logical volume numbers of the volumes to be listed. Use VOL1 for a standard labeled volume. Specify up to five logical volume numbers in the form (*volser1, volser2, ...*). If omitted, and START, END parameters are not used, then all logical volumes on the input Exported Stacked Volume are listed. Ignored if TYPE=SHORT.

start

The relative number of the logical volume on the input Exported Stacked Volume where the listing is to start. For example, START=5 causes the first 4 logical volumes to be skipped and the listing starts with logical volume 5. If omitted, the value defaults to 1. If START is greater than END, then no logical volumes is listed. Ignored if TYPE=SHORT, or VOLSER has been specified.

type

Specify one of the following:

SHORT

Print only the volsers of the logical volumes on the input Exported Stacked Volume (the default).

LONG

Print detailed listing of the format of the logical volumes on the input Exported Stacked Volume. Parameters VOLSER or START, END can be used to qualify the logical volumes listed.

```
//EVL JOB (acct),'name' Exported Stacked Volume List
//DTEVL EXEC PGM=FILEMGR
```

```
//STEPLIB DD DSN=FMN.SFMNMOD1,DISP=SHR
//SYSPRINT DD SYSOUT=*
//TAPE DD UNIT=F07M3N80,VOL=SER=ESV994,
// DISP=SHR,LABEL=(,BLP)
//SYSIN DD *
$$FILEM EVL INPUT=TAPE,TYPE=LONG,VOLSER=(EJ0020,EJ1019,EJ1029,EJ1035)
$$FILEM EOJ
/*
```

File Manager

```
$$FILEM EVL INPUT=TAPE,TYPE=LONG,VOLSER=(EJ0020,EJ1019,EJ1029,EJ1035)
```

```
Exported Stacked Volume Table of Contents for Volume ESV994
```

VOLSER	SEQ NO	Logical Volume Layout
EJ1019	3	VOL1EJ1019
		HDR1PE.MNT06.TAB35100
		----- TAPE MARK -----
		Data File
		----- TAPE MARK -----
		EOF1PE.MNT06.TAB35100
		----- TAPE MARK -----
		----- TAPE MARK -----
		===== End of Volume =====
		===== End of Volume =====
EJ1035	4	VOL1EJ1035
		HDR1PE.MNT12.TAB35100
		----- TAPE MARK -----
		Data File
		----- TAPE MARK -----
		EOF1PE.MNT12.TAB35100
		----- TAPE MARK -----
		----- TAPE MARK -----
		===== End of Volume =====
		===== End of Volume =====
EJ1029	7	VOL1EJ1029
		HDR1PE.MNT08.TAB35100
		----- TAPE MARK -----
		Data File
		----- TAPE MARK -----
		EOF1PE.MNT08.TAB35100
		----- TAPE MARK -----
		----- TAPE MARK -----
		===== End of Volume =====
		===== End of Volume =====
EJ0020	10	VOL1EJ0020
		HDR1.BACKTAPE.DATASET
		----- TAPE MARK -----
		Data File
		----- TAPE MARK -----
		EOF1.BACKTAPE.DATASET
		----- TAPE MARK -----
		----- TAPE MARK -----
		===== End of Volume =====
		===== End of Volume =====

```
EVL completed
```

```
$$FILEM EOJ
```

FCH (Find/Change)

Purpose

The FCH function allows you to:

- Search for, and optionally change, strings in a PDS, VSAM data set, sequential data set, MQ queue, or CICS® resource.
- Search for strings in HFS files.

Usage notes

You can select the records to be processed using:

- Member name selection criteria
- Date created selection criteria
- Date last modified selection criteria
- User ID selection criteria

You can either specify a REXX procedure with the *proc* parameter, or enter a FIND or CHANGE command in the Command line. For information about the primary commands, see [Finding and changing data in multiple PDS members on page 368](#). The LOCATE primary command is ignored in batch jobs. When working with compressed non-VSAM extended format data sets (compressed PSE data sets), any CHANGE command is performed as if MEMORY=YES is specified.

Multiple command processing

There is no limit on the number of FIND or CHANGE commands that can be processed in one pass of the file, but each FIND or CHANGE command must start on a new line. Be careful when using overlapping change commands such as `C cat dog` and `C catapult crossbow`. A string is only matched against the first command with a matching search argument. Therefore, you must place the longer change first. For example, if you specify the following change commands:

```
C Cat Dog
C Catapult Crossbow
```

The second command would never get processed. Reversing the command order would ensure any occurrences of “Catapult” were changed.

After a change is made, FCH processing continues for the same data record. The point where processing resumes is immediately following the most recently changed string. As a result, changes are not recursive, so that `C cat cow` and `C cow dog` does not change “cat” to “dog”, unless separate runs are done. Furthermore, if the search argument is found but the change fails, subsequent FIND or CHANGE commands that match that string are not done.

Data sets containing variable length records

If a CHANGE command would result in an increase in the length of a variable length record, the change is not processed unless MEMORY=YES is specified, and the change does not exceed the maximum variable record length for a data set.

Performance tips

- When you use FCH to update members of a PDS(E):

One FCH default is STATS=ON, which causes the ISPF statistics for each changed member to be updated. This can significantly increase I/O (EXCP) and CPU utilization. To improve performance, consider using STATS=OFF.

- Using JCL processing (JCL=YES) is more CPU intensive than JCL=NO. Only use JCL=YES if necessary.
- You can improve concurrent read access by other users or jobs to the target data set when there is a user PROC, by using the NOUPDATE=YES option when the PROC will not be performing any updates.

Options

When you specify the PROC option, you are supplying a REXX procedure. For more information, see the *proc* parameter below.

Return codes

The default return codes from the FCH function have the following modified meanings:

1

One or more FIND or CHANGE commands successful but one or more FIND or CHANGE commands unsuccessful because no strings found.

2

One or more strings found but one or more CHANGE commands could not be performed (no space available or invalid key change).

4

No FIND or CHANGE command successful because no strings found (no matches).

4

No FIND or CHANGE command successful because no members to process.

4

No FIND or CHANGE command successful because input empty.

8

Bad FIND/CHANGE command(s) supplied.

8

Too many FIND/CHANGE commands supplied.

8

REXX error encountered.

8

Job step interrupted/cancelled.

16

Program Object not supported (but specified).

16

Data set in use.

16

Member in use.

16

Data set/member open error.

16

Data set not found / allocation error.

16

Insufficient storage available.

16

Input data appears ISPF packed but is not valid.

16

FCH abended.

16

Other serious error that stops processing occurred (for example an input/output error).



Note: Return codes can be customized during installation. If you receive return codes that do not match those listed above, your site might have customized the return codes for this function. File Manager may also issue the 999 abend, if the return code in batch is equal to or greater than the ABENDCC value. Contact your File Manager systems administrator for details.

Related functions

DSEB

Edit a data set via batch job processing

TRS

Locate data within a tape file

Figure 443. Syntax

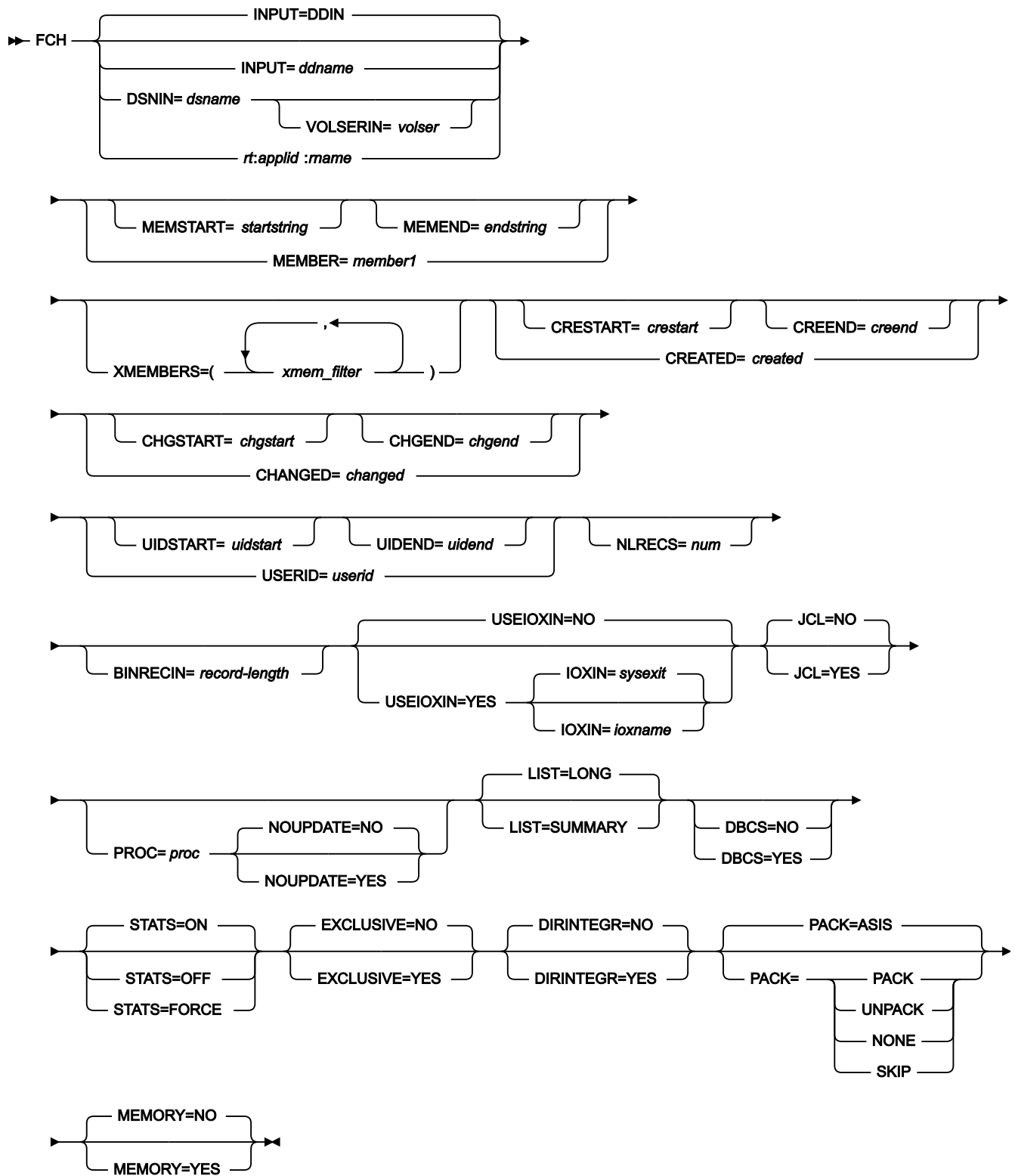

INPUT=ddname

Defines a reference to a DD or TSO ALLOC statement for the input data set, or HFS file. The default is `DDIN`.

DSNIN=dsname

Defines the name of the input data set, or an absolute path to a HFS file (directory). If any DD statements are specified, they are not used. The name may include a member name in parenthesis. If the member is specified here, the associated Member parameter must be empty. You can further describe this data set, as follows:

VOLSERIN=volser

Volume serial number for a non-cataloged data set.

An absolute path to a HFS file (directory) must be enclosed in apostrophes. If it does not fit on one line, it can be split into several lines.

rt:applid:rname

You can specify a CICS® resource in place of a data set name, where:

rt

Resource type. Valid values are:

FI

For a CICS® file.

TD

For a Transient Data Queue.

TS

For a Temporary Storage Queue.

applid

The VTAM® applid of the CICS® system.

rname

The name of the resource.

MEMBER=member1

The name of a single member in a PDS, or a member name pattern representing one or more members in a PDS. If the input data set is a PDS(E), you may specify this parameter, or a member name in the DD statement for *ddname*, or specify a range of member names with the MEMSTART and MEMEND keywords.

A member name pattern can consist of any characters that are valid in a member name and two special pattern characters: the asterisk (*) and the percent symbol (%).

*

represents any number of characters. As many asterisks as required can appear anywhere in a member name pattern. For example, if you enter a member name pattern of `*d*`, all members in the PDS whose name contains "d" are processed.

%

is a place holding character that means a single character. As many percent symbols as necessary can appear anywhere in a member name pattern. For example, if you enter a member name pattern of `%%%`, all members in the PDS whose name is four characters in length are processed.

member1 is ignored if the data set is not a PDS.

MEMSTART=*startstring*

Is used to specify the start of a range of member names to be included in the copy. If MEMSTART is specified but MEMEND is omitted, all members of the PDS(E) from the *startstring* value onwards are included. *startstring* can have the same values, including wild cards, as for the *member1* parameter of the MEMBER keyword.

MEMEND=*endstring*

Is used to specify the end of a range of member names to be included in the copy. If MEMEND is specified but MEMSTART is omitted, all members of the PDS(E) up to the *endstring* value onwards are included. *endstring* can have the same values, including wild cards, as for the *member1* parameter of the MEMBER keyword.

XMEMBERS

Provides a way to exclude from processing library members that would otherwise be selected using the MEMSTART, MEMEND, and MEMBER options.

xmem_filter

A member name filter identifying one or more members that are to be excluded from processing. A filter can be a member name pattern representing multiple members.

To specify a member name filter containing lowercase characters, use a character string in the format `c'string'`. Filter values can also be specified as hexadecimal strings in the format `x'hex-digits'`.

CREATED=*created*

The date on which a member was created, in YYYY/MM/DD format.

If the input data set is a PDS(E), you may specify this parameter, or specify a range of creation dates with the CRESTART and CREEND keywords.

You can specify an asterisk (*) as the last character to indicate a range of dates or a percent sign (%) in place of a single character to indicate a selection of dates.

created is ignored if the data set is not a PDS.

CRESTART=*crestart*

The start of a range of creation dates in YYYY/MM/DD format to be included in the copy.

If CRESTART is specified but CREEND is omitted, all members of the PDS(E) from the *crestart* value onwards are included.

If omitted, or you do not enter a full date, or you specify an asterisk (*) as the last character, the unspecified portion of *crestart* defaults to the right as follows:

DD

= 01

MM

= 01

YYYY

= 0000

No other wildcarding is allowed.

CREEND=*creend*

The end of a range of creation dates in YYYY/MM/DD format to be included in the copy.

If omitted, or you do not enter a full date, or you specify an asterisk (*) as the last character, the unspecified portion of *creend* defaults to the right as follows:

DD

= 31

MM

= 12

YYYY

= 9999

No other wildcarding is allowed.

CHANGED=*changed*

The date on which a member was last modified, in YYYY/MM/DD format.

If the input data set is a PDS(E), you may specify this parameter, or specify a range of modification dates with the CHGSTART and CHGEN keywords.

You can specify an asterisk (*) as the last character to indicate a range of dates or a percent sign (%) in place of a single character to indicate a selection of dates.

changed is ignored if the data set is not a PDS.

CHGSTART=*chgstart*

The start of a range of modification dates in YYYY/MM/DD format to be included in the copy.

If CHGSTART is specified but CHGEN is omitted, all members of the PDS(E) from the *chgstart* value onwards are included.

If omitted, or you do not enter a full date, or you specify an asterisk (*) as the last character, the unspecified portion of *chgstart* defaults to the right as follows:

DD

= 01

MM

= 01

YYYY

= 0000

No other wildcarding is allowed.

CHGEND=*chgend*

The end of a range of modification dates in YYYY/MM/DD format to be included in the copy.

If omitted, or you do not enter a full date, or you specify an asterisk (*) as the last character, the unspecified portion of *chgend* defaults to the right as follows:

DD

= 31

MM

= 12

YYYY

= 9999

No other wildcarding is allowed.

USERID=*userid*

The TSO user ID by which the member was last updated.

If the input data set is a PDS(E), you may specify this parameter, or specify a range of user IDs with the UIDSTART and UIDEND keywords.

You can enter a generic user ID by using asterisks and percent signs.

userid is ignored if the data set is not a PDS.

UIDSTART=*uidstart*

The start of a range of user IDs to be included in the copy.

If UIDSTART is specified but UIDEND is omitted, all members of the PDS(E) from the *uidstart* value onwards are included.

If omitted, or you do not enter a full 7-character user ID, or you specify an asterisk (*) as the last character, File Manager replaces the asterisk and pads the unspecified portion of *uidstart* to the right with low values (X'00').

UIDEND=*uidend*

The end of a range of user IDs to be included in the copy.

If you omit this field, it defaults to high values (X'FF').

If you specify less than 7 characters (without an asterisk as the last character), File Manager pads *uidstart* to the right with low values (X'00'). If you specify an asterisk (*) as the last character, File Manager replaces the asterisk and pads the unspecified portion of *uidend* with high values (X'FF').

NLRECS=*num*

Specifies the number of records to be processed in each data set or member.

BINRECIN=*record-length*

Specifies the record length used for processing a HFS file. Valid range: 1 to 32760. The file is processed in binary mode (fixed-length records derived from the file, delimiters not distinguished). If you do not specify this parameter, the file is processed in text mode (variable-length records, boundaries determined by delimiters).

USEIOXIN

Specifies whether to invoke a user I/O exit, to process the input data set.

NO

Default. Do not invoke a user I/O exit.

YES

Invoke a user I/O exit to process the input data set. This option is only available if the person who did the site customization for File Manager allowed user I/O exits on a site-wide basis.

IOXIN

Specifies the name of the user I/O exit used for the input data set. There are no restrictions on the programming language that you can use to write an exit. The exit must be provided to File Manager in the STEPLIB/ISPLLIB concatenation or their extensions (LINKLIST, LPA, and so on).

sysexit

Default. If you specify USEIOXIN=YES and do not supply a user I/O exit name, File Manager uses the name of the exit provided in the installation customization options. If USEIOXIN has been set to YES and no installation default has been provided, you must specify IOXIN=*ioxname*.



Note: If you have selected batch processing in an online panel, the generated JCL statements use the default name provided in your Set System Processing Options panel.

ioxname

The name of a PDS(E) member of a data set that has been provided to File Manager in the STEPLIB concatenation.

JCL=NO

Treat the data set as a non-JCL data set.

JCL=YES

The data set contains JCL and the JCL syntax is to be preserved.

The columns searched are set to 3 through 71, unless the statement is not a JCL statement. A statement is considered to be a JCL statement if it begins with the strings `/*` or `/**`. If the statement does not begin with either of these strings, it is not considered to be a JCL statement in which case any column range specified on the FIND (or CHANGE, respectively) command or preset using the BOUNDS command is honored. If no column range has been specified, the full record is searched.

If not successful at maintaining the number and size of records, File Manager attempts to rewrite the file:

- More errors are possible in this case. For example, a PDS(E) may run out of room.
- If a logical line is changed and requires more physical records, the file is rewritten. The data in columns 73–record length for new physical records is copied from the last related original physical record. Data past column 72 is treated as non-changeable sequence numbers or comments.

PROC=*proc*

Member name of a REXX procedure that you want to use to process each record, or an asterisk (*) to indicate the procedure is inline. If you specify a member name, you must define an FMNEXEC ddname that identifies the PDS containing the member. If you specify *, the procedure is read from SYSIN immediately following the control statement for the current function. The inline procedure is terminated by a record containing a slash and a plus sign (/+) in columns 1–2.

Whether or not a record appears in the FCH report is determined by the return code from the REXX procedure for that record. (If no PROC statement is specified, one is assumed at the end of the \$\$FILEM control statements.) If the REXX procedure ends with a RETURN DROP statement, then the current record is considered to be “not selected” (not one of the records you wanted to find), and does not appear in the FCH report. If the REXX procedure ends normally, or with an explicit RETURN (without the DROP keyword), then the current record is considered to be “selected”, and is included in the FCH report. Records that have been selected without being changed by the REXX procedure are marked in the FCH report by an “s” suffix attached to their record number, while records that have been selected and changed are marked by a “c”.

In a REXX procedure for FCH, explicitly code a RETURN statement when you identify a record that you want to select. To ensure that other records are not selected, on the last line of the REXX procedure, code a RETURN DROP statement.

For more information about using REXX procedures to process records, see [Enhancing File Manager processing on page 517](#).

NOUPDATE

Allows you to specify that you intend no updates to the FCH data set while executing the utility. This option is valid only when a REXX procedure has been specified and is ignored otherwise.

NO

Updates to the data are honored.

YES

Forces the allocation of the data set as input only. All updates to the data are ignored.

LIST=LONG

Default. This prints each record where the string was found as well as a summary report.

LIST=SUMMARY

This produces a summary report only.

DBCS=YES

(Default for LANGUAGE=JAPANESE). This processes and preserves DBCS shiftin and shiftout characters within the data records.

DBCS=NO

(Default for LANGUAGE=ENGLISH). This ignores DBCS shiftin and shiftout characters within the data records.

STATS=ON

Default. This updates the ISPF statistics (if already present) when a PDS or PDSE member has been changed.

STATS=OFF

The ISPF statistics is not updated when a PDS or PDSE member has been changed.

STATS=FORCE

The ISPF statistics that exist for members being processed are always updated and statistics for a member that previously did not have statistics are created.

EXCLUSIVE=NO



Note: This option is supported for backward compatibility only.

Use the new DIRINTEGR option.

Default. The data set is allocated with DISP=SHR, so that other users can obtain concurrent access to a PDS or PDSE during execution of FCH.

EXCLUSIVE=YES

Forces an override of the PDS(E) member processing method which allows for safe concurrent updates by other users. This option has significant performance impact. When set to YES, the member processing is performed much faster but may be affected by PDS(E) directory updates, possibly causing I/O errors if the

data set is concurrently updated. This option overrides the processing method selected by File Manager (EXCLUSIVE=NO, default, unless the input data set has been allocated OLD by the user), which always assumes concurrent safe processing when the data set is allocated to multiple users.

DIRINTEGR

Specifies whether to invoke a user I/O exit to process the input data set.

NO

Default. File Manager uses a faster PDS(E) directory processing method. This may cause I/O errors when multiple users are concurrently updating the directory of the data set being processed.

YES

File Manager uses safer, but slower, PDS(E) directory processing method. This method allows for safe concurrent updates of the PDS(E) directory by multiple users.

PACK

Determines if File Manager should detect if the input data is in ISPF packed format and specifies if the output data is to be written in ISPF packed format. This keyword is ignored when processing VSAM data sets. When an I/O exit has been specified for either the input or output data set (or both), the only valid option is PACK=NONE.

ASIS

Instructs File Manager to write the output in ISPF Packed format only if the input is in ISPF packed format.

PACK

Instructs File Manager to write the output in ISPF packed format regardless of the input format.

UNPACK

Instructs File Manager to write the output without ISPF packing, regardless of the input format.

NONE

Instructs File Manager not to determine if the input data set is in ISPF packed format and writes the output records as they are read from the input data set (after any enhanced processing).

SKIP

Instructs File Manager to determine if the input data set is in ISPF packed format and if so, to skip the find/change processing.

MEMORY

Specifies whether to perform changes in memory.

NO

Default.

YES

Perform the changes in memory. The following occurs:

1. Opens the data set or member for input and reads all the records into memory.
2. Supports record length changes when the search and replace strings are different lengths and the resultant length is less than or equal to the maximum logical record length of a variable length data set.
3. Opens for output and writes all the records loaded back to the data set when a change is made.

**Note:**

1. This option is ignored for VSAM files.
2. This option can be used to avoid the restrictions associated with opening the data set in UPDATE mode.
3. The function is terminated if there is insufficient memory to load the entire member or data set into memory. A larger region size may be required.
4. For compressed data sets, the change is always performed in memory.
5. Memory processing performs slower than update in place.

See [Finding and changing data in multiple PDS members on page 368](#) for details of the FCH commands.



Note: It is not possible to use multiple FINDNOT commands in the input stream for batch processing. Similarly, it is not possible to combine FINDNOT commands with FIND or CHANGE commands in the batch input stream.

```
//FMUSRFCH JOB (@TS2,MVS6), 'FMUSER',NOTIFY=FMUSER,
// CLASS=A,MSGLEVEL=(1,1),MSGCLASS=H
//FMNBAT EXEC PGM=FILEMGR
//STEPLIB DD DSN=FMUSER.FMN110.TSTLOAD,DISP=SHR
// DD DSN=hlq.TSTLOAD,DISP=SHR
// DD DSN=hlq.SFMNMOD1,DISP=SHR
// DD DSN=FMN.IGYV1R20.SIGYCOMP,DISP=SHR
//SYSPRINT DD SYSOUT=*
//FMNEXEC DD DSN=FMN.EXEC,DISP=SHR
//FMNTSPRT DD SYSOUT=*
//DDIN DD DSN=FMUSER.JCL.TESTING,DISP=SHR
//SYSTEM DD SYSOUT=*
//SYSIN DD *
$$FILEM FCH ,
$$FILEM INPUT=DDIN,MEMBER=J*
F 'rights reserved'
C 'Copyright 2001-2002' ,
'Copyright 2001-2003' 1 71
C 'Alpha Company Ltd' ,
'Alpha Beta Company Ltd' 1 71
C 'Beta Company Ltd' ,
'Alpha Beta Company Ltd' 1 71
```



```

/+
/*

```

FMT (Set DBCS Format)

Purpose

Specify the format of records that contain double-byte character set (DBCS) data.

Usage notes

File Manager considers data as being contained in one or more fields in the input record. This function lets you define where each type of field is located within the record. You can define up to 32 fields in ascending order. They must not overlap, but they need not be contiguous. Specify for each field: start column, end column, type. An asterisk (*) for end column indicates end-of-record. For type, you can specify EB (for EBCDIC format), DB (for DBCS format), or MI (for mixed format).

For all areas you do not define, File Manager creates an EBCDIC field definition.

If you use the FMT function within a batch job, your format definition affects only the current batch job. In any other case, your format definition is saved in the user profile and is available for further File Manager sessions.

The FMT function and the “DBCS capable language” processing option of the SET function work together as follows:

- The FMT function specifies which data within each record is DBCS.
- The “DBCS capable language” option of the SET function causes DBCS data to be printed correctly.

For more information about the SET function, see [SET \(Set Processing Options\) on page 1550](#).



Note: The FMT function has no effect on data printed in TABL or SNGL print format by a print function in advanced-function mode when the language used is a DBCS capable language or when using TSO if the terminal used is DBCS capable. However, when either the language is a non DBCS language or the TSO terminal is not DBCS capable then the DB type can be used to format graphic fields correctly in the output.

Options

RESET specifies that the default (1,*,EB) is to be used. LIST prints a listing of the current FMT setting.

Figure 444. Syntax

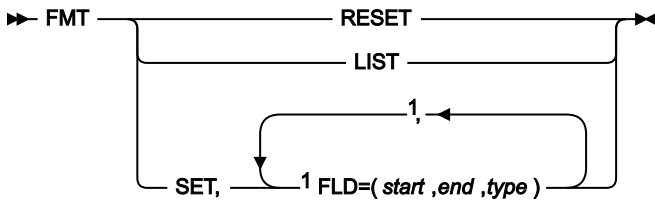

Notes:

¹ You can specify up to 32 fields using the FLD keyword.

LIST

Lists all the field definitions, whether you defined them explicitly or File Manager used the default.

RESET

Resets all field definitions to the default FLD=(1,*,EB).

SET

Defines a new set of fields.

start

Starting position of a field, in bytes, where 1 represents the start of the record.

end

Ending position of the field, in bytes. Specify an asterisk (*) for the end of the record.

type

Type of a field:

DB

DBCS data. The field length must be an even number of characters. Unformatted graphic fields are not treated as DBCS.

MI

Mixed DBCS and EBCDIC data. Data between the shift out character X'0E' and the shift in character X'0F' is treated as DBCS data.

EB

EBCDIC data (the default).

The field definitions must be in ascending order, and must not overlap. Any areas that you do not define are considered EBCDIC data.

You can define up to 32 fields.

For example, the command:

```
FMT,SET,FLD=(10,27,MI),FLD=(40,59,DB)
```

gives you these field definitions:

```
FIELD1 (1,9,EB)
FIELD2 (10,27,MI)
FIELD3 (28,39,EB)
FIELD4 (40,59,DB)
FIELD5 (60,*,EB)
```

File Manager prints a mask of the record, with a scale to help you to adjust your definition:

```
EEEEEEEEMMMMMMMMMMMMMMMMMMMMEEEEEEEEEEEEEDBDBDBDBDBDBDBDBDBDBE*
1...5...10...5...20...5...30...5...40...5...50...5...60.
```

The valid double-byte hexadecimal values are X'0000', X'4040', and X'4141' to X'FEFE'. File Manager replaces all other pairs of double-byte characters with X'4040'.

```
//FMT JOB (acct),'name' Define DBCS Record Fmt
//FILEMGR EXEC PGM=FILEMGR
//SYSPRINT DD SYSOUT=*
//SYSIN DD *
$$FILEM FMT SET,FLD=(10,27,MI),FLD=(40,59,DB)
$$FILEM E0J
/*
```

FSF (Forward Space File)

Purpose

Move the tape forward one or more tape files.

Usage notes

A tape file consists of blocks of data delimited by a tape mark. For this function, a tape label set is also considered a file. The tape stops after the specified number of tape marks has been read. The tape is positioned after the tape mark and a following read or write command reads or overwrites the record following that tape mark.

Options

None.

Related functions

BSF

Move the tape backward one or more files

BSR

Move the tape backward one or more records

FSR

Move the tape forward one or more records

REW

Rewind a tape to its load point

RUN

Rewind a tape and unload it

Figure 445. Syntax

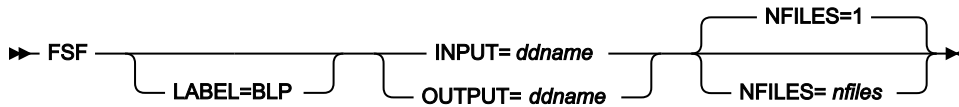

ddname

Refers to a DD or TSO ALLOC statement.

LABEL=BLP

Specifies that bypass label processing is used. This parameter must be specified with the first File Manager function that uses the tape. For BLP processing requirements, see "Customizing the Security Environment?" in the *File Manager for z/OS Customization Guide*.

nfiles

Number of tape files to be spaced forward. The maximum is 99 999; the default is 1. Leading tape marks are also counted.

FSR (Forward Space Record)

Purpose

Move the tape forward one or more tape records or tape marks.

Usage notes

A physical tape record is either a block of data bytes or a tape mark. A tape mark is treated as a special record. For each tape mark crossed, File Manager displays an information message.

Options

None.

Related functions

BSR

Move the tape backward one or more records

BSF

Move the tape backward one or more files

FSF

Move the tape forward one or more files

REW

Rewind a tape to its load point

RUN

Rewind a tape and unload it

Figure 446. Syntax

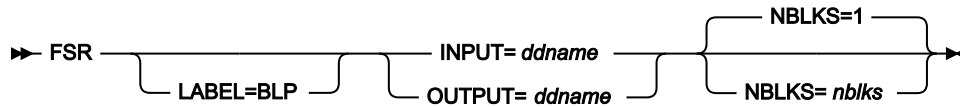
**ddname**

Refers to a DD or TSO ALLOC statement.

LABEL=BLP

Specifies that bypass label processing is used. This parameter must be specified with the first File Manager function that uses the tape. For BLP processing requirements, see “Customizing the Security Environment” in the *File Manager Customization Guide*.

nblks

Number of tape blocks to be spaced forward. The maximum is 99 999 999; the default is 1. A tape mark is considered a block.

INT (Initialize Tape)

Purpose

Initialize tapes in IBM® standard label format, ASCII label format, or NL tape.

Usage notes

Use this function to initialize a labeled or unlabeled tape. File Manager first rewinds the tape. To initialize with labels, File Manager writes a volume label set in either IBM® standard format or ANSI type 3 or 4 (ASCII) format. For NL initialization, a single tape mark is written.

Specify a DDNAME for the tape. To check existing labels on the output tape before creating the new label set, specify the appropriate label value on the tape allocation panel. Specifying BLP initializes the tape unconditionally.

After completion of the function, the tape remains positioned after the label set. To make your system aware of the new volume serial number, rewind, unload, and reallocate it with the new volume serial number.

Options

You can initialize a tape with ANSI type 3 or 4 labels to be used with ASCII files. You can also specify a file identifier to be used for the file header label. Omit the volser to initialize an NL tape.

A scaling capacity can be added to the tape provided the function is supported by the hardware. The scaling capacity limits the amount of the tape actually used.

Related function

WTM

Write one or more tape marks

Figure 447. Syntax

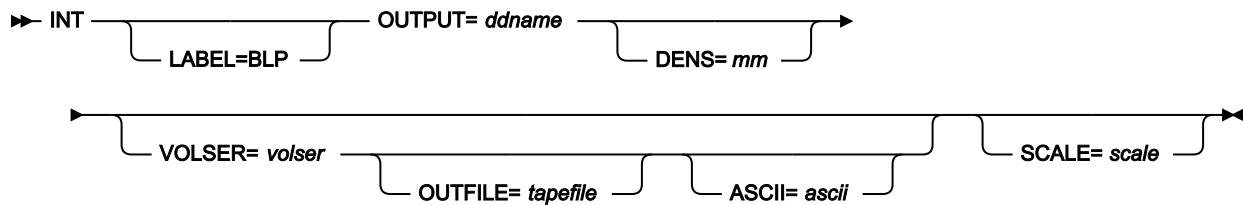

ascii

Specify YES to format the tape with American National Standard labels for use with ASCII files. Specify NO to format the tape with EBCDIC labels. The default depends on the value of the SET TAPELBL parameter.

ddname

Refers to a DD or TSO ALLOC statement.

LABEL=BLP

Specifies that bypass label processing is used. This parameter must be specified with the first File Manager function that uses the tape. For BLP processing requirements, see "Customizing the Security Environment" in the *File Manager for z/OS Customization Guide*.

mm

A 2-byte tape mode as shown in [Tape density and mode values on page 449](#).

scale

Limits the amount of data that can be stored on the tape to a percentage of its capacity. Allowed values are 0 (100% capacity; no limit applied), 25, 50, or 75. For example, SCALE=25 limits the tape to 25% of its normal capacity. Only valid for 3590 devices; it is not valid for a 3590 running in 3489E emulation mode.

tapefile

Name to be used to write the HDR1 label. The default is to create a HDR1 label with a dummy name for labeled tapes. This parameter is ignored for NL tapes.

volser

Volume serial number to be used for initialization. If omitted, an NL tape with no volser is produced.

```

//INT JOB (acct),'name' Initialize SL Tape
//FMBAT PROC
//FMBAT EXEC PGM=FILEMGR
//STEPLIB DD DSN=FMN.SFMNMOD1,DISP=SHR
//SYSPRINT DD SYSOUT=*

```

```

//SYSABEND DD SYSOUT=*
//SYSUDUMP DD SYSOUT=*
//          PEND
//*
//FILEMGR  EXEC FMBAT
//SYSPRINT DD SYSOUT=*
//TAPE     DD UNIT=561,VOL=SER=FM0001,
//          DISP=SHR,LABEL=(,BLP)
//SYSIN    DD *
$$FILEM INT OUTPUT=TAPE,VOLSER=FM0001,
$$FILEM   SCALE=25,OUTFILE=MY.TEST.TAPE
$$FILEM EOI
/*

```

NOSORT (Disable the use of DFSORT)

Purpose

Disable the use of DFSORT for copy or print processing of data sets.

Usage notes

File Manager may use DFSORT internally for processing to achieve better performance. Under certain conditions (for example, unlike concatenated input data sets), such use may result in DFSORT processing errors and should be disabled.

Figure 448. Syntax

►► NOSORT ◀◀

ODL (Object Directory List)

Purpose

Work with a list of OAM objects from the specified collection or optical disk.

Usage notes

You can print the list.

Select the objects by a fully-qualified or a generic object name. Specify the collection name, the volser of an optical volume, or both.

The information listed by ODL includes:

- Object name
- Creation timestamp
- Object size
- Storage location (DASD or Library)
- Volser information (if known)
- Storage class
- Management class
- Expiration date

Options

Limit processing to objects residing in DASD storage, on optical storage media, or on a specific optical volume. You can also specify a range for the creation date. The information displayed can be sorted by name, creation date, size or expiration date.

Related functions

OE

Erase an OAM object

OO

Copy an object to the same or another collection

OP

Print an object in character or hexadecimal dump format

OS

Backup objects from an OAM database to a data set

OV

Backup objects from an OAM database to a VSAM data set

Figure 449. Syntax

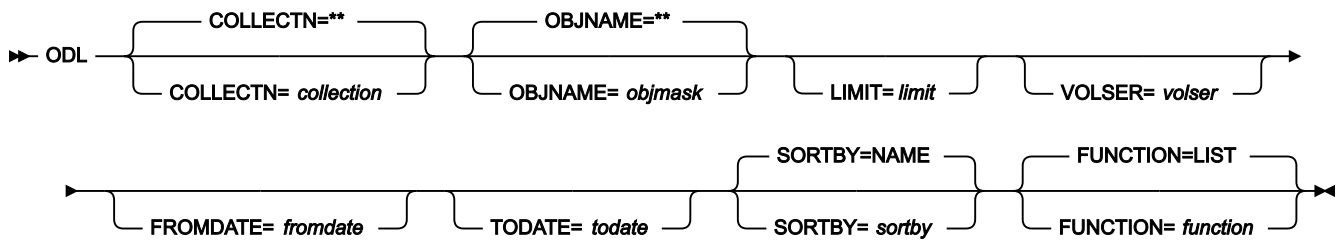

collection

A collection name. In any mode except batch mode, the user's TSO prefix (normally the user ID) is used as the high-level qualifier for any name that is not entered in quotation marks.

The default is all collections; in this case, you must specify LIMIT=VOLUME and a *volser*.

fromdate

The earliest creation date, in the form *yyyymmdd*. By default, all objects are listed regardless of their creation date.

function

The command that you want to execute:

LIST

Display the list (the default)

PRINT

Print the list.

limit

To limit the list based on where objects are located, specify one of the following:

DASD

Only objects that are stored on DASD

OPTICAL

Only objects that are stored on optical disks

VOLUME

Only objects that are stored on a specified optical disk. You must also specify the volser of the optical disk.

objmask

An object name or generic object name. Within the name, you can include a percent sign (%) to represent exactly one character, an asterisk (*) to represent any number of characters (or no characters) within a qualifier, or two asterisks (**) to represent any number of characters (or no characters) within any number of qualifiers.

In any mode except batch mode, the user's TSO prefix (normally the user ID) is used as the high-level qualifier for any name that is not entered in quotation marks.

The default is **. In batch mode, this means all objects; in any other mode, this means all objects that have the user's TSO prefix as high-level qualifier.

sortby

One of the following:

NAME

Sorts by object name (the default)

DATE

Sorts by creation date

EDATE

Sorts by expiration date

SIZE

Sorts by object size.

todate

The latest creation date, in the form *yyyymmdd*.

volser

If you specified VOLUME for *limit*, the volume serial number of the optical disk.

```
//JOB (acct),'name',Optical Volume Contents
//S1      EXEC PGM=FILEMGR
//SYSPRINT DD SYSOUT=*
//SYSIN   DD *
$$FILEM ODL LIMIT=VOLUME,VOLSER=VBKUP6
$$FILEM EOJ
/*
```

OE (Object Erase)

Purpose

Erase an OAM object.

Usage notes

Use this function to remove an object from a specified collection.

Options

None.

Related function

ODL

List OAM objects

Figure 450. Syntax

► OE — COLLECTN= *collection* — OBJNAME= *object* ◄

collection

Name of the OAM object collection. In any mode except batch mode, the user's TSO prefix (normally the user ID) is used as the high-level qualifier for any name that is not entered in quotation marks.

object

Name of the OAM object. In any mode except batch mode, the user's TSO prefix (normally the user ID) is used as the high-level qualifier for any name that is not entered in quotation marks.

```
//S1      EXEC PGM=FILEMGR
//SYSPRINT DD SYSOUT=*
//SYSIN   DD *
$$FILEM OE COLLECTN=SYSU.OAM.CLLCT001,
$$FILEM   OBJNAME=DTT.ITT.WORK12
$$FILEM EOJ
/*
```

OO (Object to Object)

Purpose

Copy an object

Usage notes

Use this function to copy an OAM object within a collection (using a different object name) or to another collection.

Options

You can specify SMS storage class and management class values to be used for storing the object. These might, however, be overridden by your installation defaults.

Related functions**ODL**

List OAM objects

OE

Erase an OAM object

OS

Backup objects from an OAM database to a data set

OV

Backup objects from an OAM database to a VSAM data set

OP

Print an object in character or hexadecimal dump format

SO

Copy a data set to an object database

VO

Copy VSAM data to an object database

Figure 451. Syntax

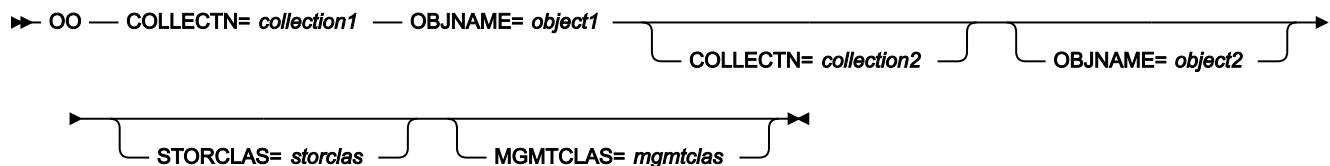
**collection1**

Name of the OAM object collection that contains the object. In any mode except batch mode, the user's TSO prefix (normally the user ID) is used as the high-level qualifier for any name that is not entered in quotation marks.

collection2

Name of the OAM object collection to which you are copying the object. In any mode except batch mode, the user's TSO prefix (normally the user ID) is used as the high-level qualifier for any name that is not entered in quotation marks.

By default, the collection name is not changed. (In this case, you must change the object name.)

mgmtclas

Name of an SMS management class.

object1

Current® name of the OAM object. In any mode except batch mode, the user's TSO prefix (normally the user ID) is used as the high-level qualifier for any name that is not entered in quotation marks.

object2

New name of the OAM object. In any mode except batch mode, the user's TSO prefix (normally the user ID) is used as the high-level qualifier for any name that is not entered in quotation marks.

By default, the object name is not changed. (In this case, you must change the collection name.)

storclas

Name of an SMS storage class.



Note: The same keywords are used for input and output. The first occurrences of COLLECTN and OBJNAME refer to the input object; the second occurrences refer to the output object.

```
/* REXX */
/* Copy object within a collection ... */
"FILEMGR $00 COLLECTN='SYSU.OAM.CLLCT000',"
"OBJNAME=' DTT.I TT.WORK12',"
"OBJNAME=' DTT.I TT.COPY12'"
/* Copy object to other collection.. */
"FILEMGR $00 COLLECTN='SYSU.OAM.CLLCT000',"
"OBJNAME=' DTT.I TT.COPY12',"
"COLLECTN=' SYSU.OAM.CLLCT001'"
return
```

OP (Object Print)

Purpose

Print an Object Access Method (OAM) object.

Usage notes

Use this function to print the contents of an object in character format or one of the two dump formats.

Options

You can select the range of bytes or records to print.

You can use the various SET processing options to control the print output:

- SET PRINTOUT defines the destination of the print output. If set to PRINTOUT=SYSOUT, you can use the PB (Print Browse) function to browse the accumulated output.
- SET RECLIMIT controls how many bytes of each record are printed.

- The format of the print output also depends on the settings of SET PAGESIZE, SET PRINTLEN, and SET PRTRTRANS.
- Use SET DUMP to specify the dump format.

Related functions

ODL

List OAM objects

OE

Erase an OAM object

Figure 452. Syntax

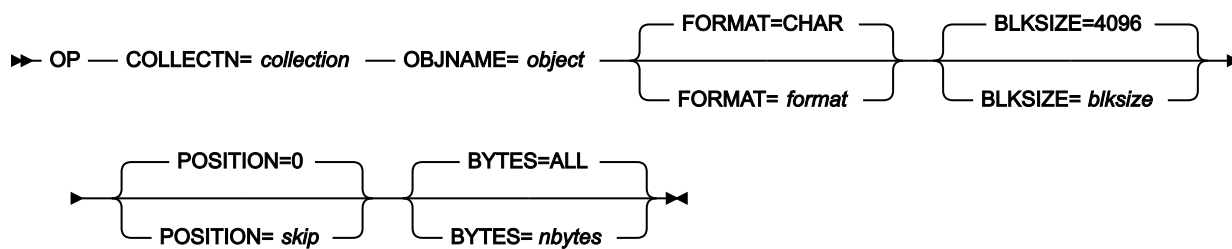

blksize

Logical record size to be used to deblock the OAM object into logical records. The maximum is 32 768; the default is 4 096.

collection

Name of the OAM object collection. In any mode except batch mode, the user's TSO prefix (normally the user ID) is used as the high-level qualifier for any name that is not entered in quotation marks.

format

The format of the output:

CHAR

Character format (the default)

HEX

Hexadecimal format.

nbytes

Maximum number of bytes to be printed or ALL. If this number is exceeded, printing stops. This parameter provides protection against printing an OAM object that is much larger than expected. The maximum number is 99 999 999. If you specify ALL or you omit the parameter, the entire object is printed.

object

Name of the OAM object. In any mode except batch mode, the user's TSO prefix (normally the user ID) is used as the high-level qualifier for any name that is not entered in quotation marks.

skip

Number of bytes to be skipped from the beginning of the object. The maximum is 99 999 999; the default is 0.

```
//JOB (acct),'name',Print OAM Object
//S1      EXEC PGM=FILEMGR
//SYSPRINT DD SYSOUT=*
//SYSIN   DD *
$$FILEM OP COLLECTN='SYSU.OAM.CLLCT000',
$$FILEM  OBJNAME='DTT.ITT.TBL21',
$$FILEM  BYTES=1000
$$FILEM EOJ
/*
```

OS (Object to Sequential Data)

Purpose

Copy one or more OAM objects from a collection, or a primary or backup optical volume, to a sequential data set.

Usage notes

To copy only the data within an object, specify the collection and the object name, and that you do not want a header record.

To create a backup of a single object, specify the collection and the object name, and that you want the header record. File Manager saves the object together with its directory information. Use the SO (Sequential Data to Object) function to restore the object.

To create a backup of multiple objects from a collection, a primary or backup optical volume, specify a generic object name. Specify the collection name, the volser of an optical volume, or both. File Manager saves the directory information of all objects copied. Use the SO (Sequential Data to Object) function to restore all, or selected, objects.

For more information about using this function, see [Backing up OAM objects on page 494](#).

Options

Limit processing to objects residing in DASD storage, on optical storage media, or on a specific optical volume. You can also specify a range for the creation date.

Specify the block size to be used for the output records. The default block size is 4096 bytes, the maximum is 32760 bytes.

Related functions**OO**

Copy an object to the same or another collection

OV

Backup objects from an OAM database to a VSAM data set

SO

Copy a data set to an object database

Figure 453. Syntax

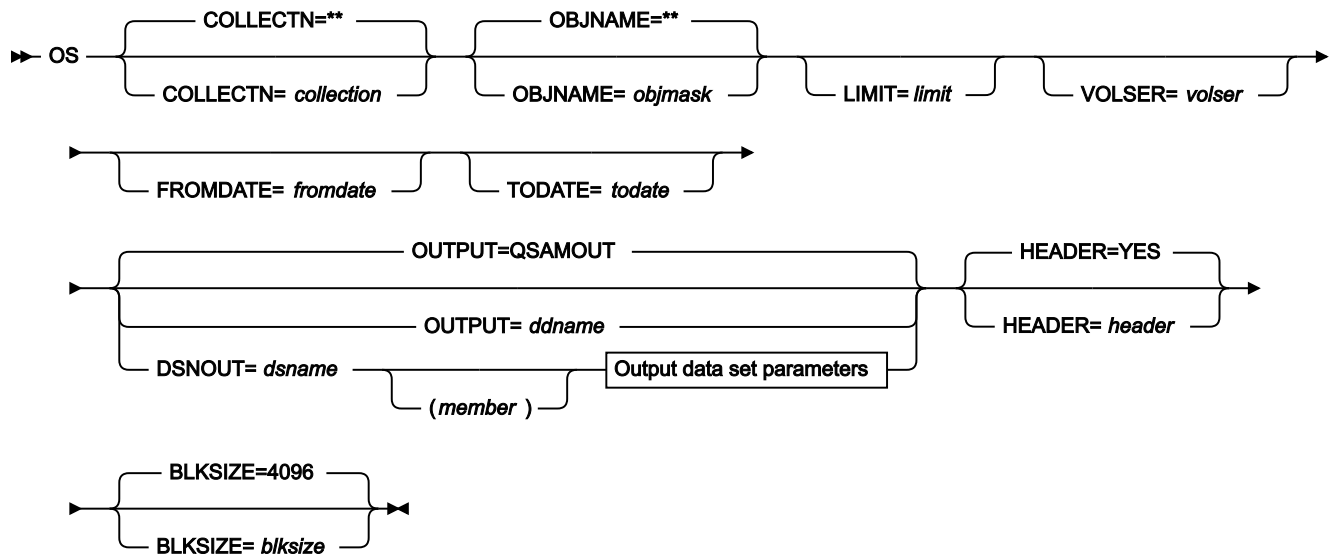

Output data set parameters

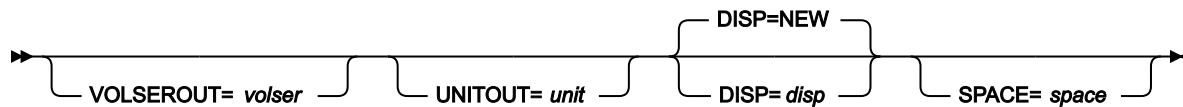
**blksize**

Block size for the output data set. The maximum is 32 760; the default is 4 096.

collection

A collection name. In any mode except batch mode, the user's TSO prefix (normally the user ID) is used as the high-level qualifier for any name that is not entered in quotation marks.

The default is all collections; in this case, you must specify **LIMIT=VOLUME** and a *volser*.

ddname

Refers to a DD or TSO ALLOC statement. The default is QSAMOUT.

disp

Disposition of the output data set. Specify OLD, MOD, NEW, or CAT for NEW,CATLG. The default is NEW.



Note: SMS might modify the allocation of new data sets on your system. For details, contact your SMS Administrator.

dsname

Name of a sequential data set. If any DD statements are specified, they are not used. To further describe the data set, use the appropriate keywords as shown in the syntax diagram.

fromdate

The earliest creation date, in the form *yyyymmdd*. By default, all objects are copied regardless of their creation date.

header

If you are copying only one object, specify NO if you do not want a header record. The default is to put a header record at the beginning of the output data set.

limit

To limit the objects that are copied based on where objects are located, specify one of the following:

DASD

Only objects that are stored on DASD

OPTICAL

Only objects that are stored on optical disks

VOLUME

Only objects that are stored on a specified optical disk. You must also specify the volser of the optical disk.

member

For a PDS, the member name.

objmask

An object name or generic object name. Within the name, you can include a percent sign (%) to represent exactly one character, an asterisk (*) to represent any number of characters (or no characters) within a qualifier, or two asterisks (**) to represent any number of characters (or no characters) within any number of qualifiers.

In any mode except batch mode, the user's TSO prefix (normally the user ID) is used as the high-level qualifier for any name that is not entered in quotation marks.

The default is **. In batch mode, this means all objects; in any other mode, this means all objects that have the user's TSO prefix as high-level qualifier.

space

The number of tracks to be allocated for a new data set. Specify *n* or *(n,m)*, where *n* is the number of primary tracks, and *m* is the number of secondary tracks.

todate

The latest creation date, in the form *yyyymmdd*.

unit

A 3 hexadecimal digit device number, a 4 hexadecimal digit device number prefixed by a slash (/), a device type, or an installation-defined group name.

volser

On input: if you specified VOLUME for *limit*, the volume serial number of the optical disk.

On output: the volume serial number for a new or non-cataloged data set.

```
// JOB (acct),'name',Save collection on tape
//S1      EXEC PGM=FILEMGR
//BACKUP  DD DSN='OBJECT.BACKUP',UNIT=CARTR,
//          DISP=(NEW,CATLG)
//SYSPRINT DD SYSOUT=*
//SYSIN   DD *
$$FILEM OS COLLECTN=SYSU.OAM.CLLCT000,
$$FILEM  OUTPUT=BACKUP
$$FILEM E0J
/*
```

OV (Object to VSAM)

Purpose

Copy one or more OAM objects from a collection or a primary or backup optical volume to a VSAM data set.

Usage notes

To copy only the data within an object, specify the collection and the object name, and that you do not want a header record.

To create a backup of a single object, specify the collection and the object name, and that you want the header record. The output data set must be a VSAM ESDS. File Manager saves the object together with its directory information. Use the VO (VSAM to Object) function to restore the object.

To create a backup of multiple objects from a collection, a primary or backup optical volume, specify a generic object name. Specify the collection name, the volser of an optical volume, or both. The output data set must be a VSAM ESDS. File Manager saves the directory information of all objects copied. Use the VO (VSAM to Object) function to restore all or selected objects.

For more information about using this function, see [Backing up OAM objects on page 494](#).

Options

Limit processing to objects residing in DASD storage, on optical storage media, or on a specific optical volume. You can also specify a range for the creation date.

Specify the block size to be used for the output records. The default block size is 4096 bytes, the maximum is limited by the maximum record size defined for the VSAM cluster.

Related functions

OO

Copy an object to the same or another collection

OS

Backup objects from an OAM database to a data set

VO

Copy VSAM data to an object database

Figure 454. Syntax

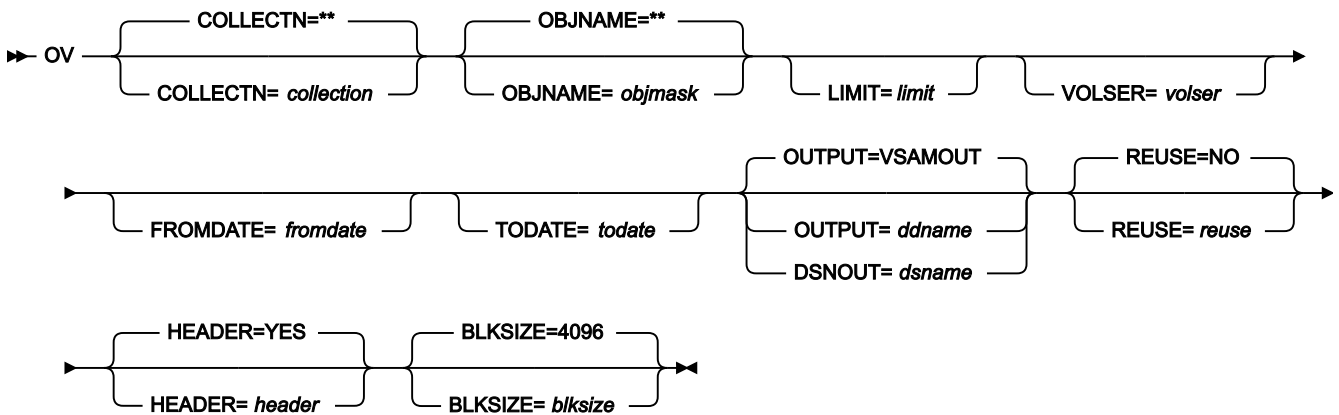

blksize

Block size for the output data set. The maximum depends on the cluster definition; the default is 4 096.

collection

A collection name. In any mode except batch mode, the user's TSO prefix (normally the user ID) is used as the high-level qualifier for any name that is not entered in quotation marks.

The default is all collections; in this case, you must specify LIMIT=VOLUME and a *volser*.

ddname

Refers to a DD or TSO ALLOC statement. The default is VSAMOUT.

dsname

Name of a VSAM data set.

fromdate

The earliest creation date, in the form *yyyymmdd*. By default, all objects are copied regardless of their creation date.

header

If you are copying only one object, specify NO if you do not want a header record. The default is to put a header record at the beginning of the output data set.

limit

To limit the objects that are copied based on where objects are located, specify one of the following:

DASD

Only objects that are stored on DASD

OPTICAL

Only objects that are stored on optical disks

VOLUME

Only objects that are stored on a specified optical disk. You must also specify the volser of the optical disk.

objmask

An object name or generic object name. Within the name, you can include a percent sign (%) to represent exactly one character, an asterisk (*) to represent any number of characters (or no characters) within a qualifier, or two asterisks (**) to represent any number of characters (or no characters) within any number of qualifiers.

In any mode except batch mode, the user's TSO prefix (normally the user ID) is used as the high-level qualifier for any name that is not entered in quotation marks.

The default is **. In batch mode, this means all objects; in any other mode, this means all objects that have the user's TSO prefix as high-level qualifier.

reuse

Specify YES to replace any existing records in the output data set (if it is defined with the REUSE parameter in the catalog). Specify NO to add new records without deleting the old records. The default is NO.

todate

The latest creation date, in the form *yyyymmdd*.

volser

If you specified VOLUME for *limit*, the volume serial number of the optical disk.

```
/* REXX */
/* This EXEC saves all OAM objects in a VSAM */
/* data set which were added to a collection */
/* at the current day: */

/* Get date in format YYYYMMDD */
fromdate = DATE('STANDARD')
say 'Saving objects from' fromdate

/* create backup copy of all new objects */
"FILEMGR $OV COLLECTN='SYSU.OAM.CLLCT000'," ,
```

```
"FROMDATE=" | | fromdate,  
"DSNOUT=REUSABLE . ESDS, REUSE=YES"
```

```
return
```

PBK (Print Copybook)

Purpose

Prints a report showing the field definitions in:

- a copybook
- a template that was based on a copybook (not Db2® templates)
- a dynamic template
- an IMS™ view
- an IMS™ criteria set

Usage notes

When referencing a copybook, the copybook must be stored in a partitioned data set member, a CA-Panvalet library member, or a library accessed using the Library Management System Exit. All other source types can be stored in a sequential data set, partitioned data set member, CA-Panvalet library member, or a library accessed using the Library Management System Exit.

Options

None.

Related functions

None.

Figure 455. Syntax

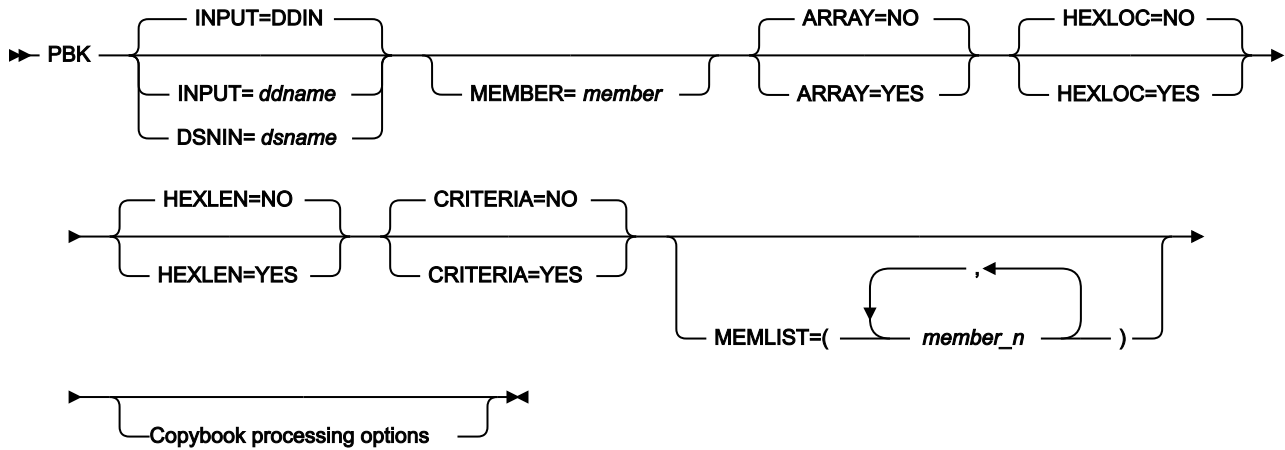

Copybook processing

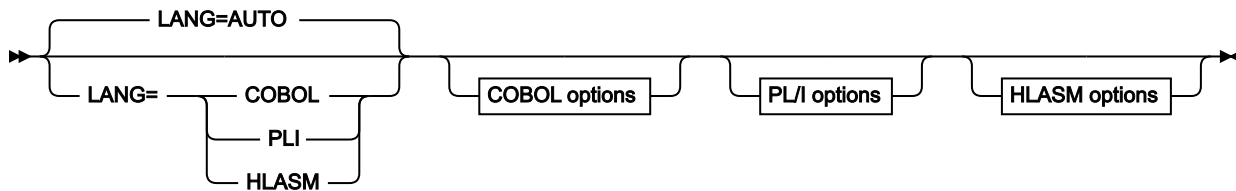

COBOL options

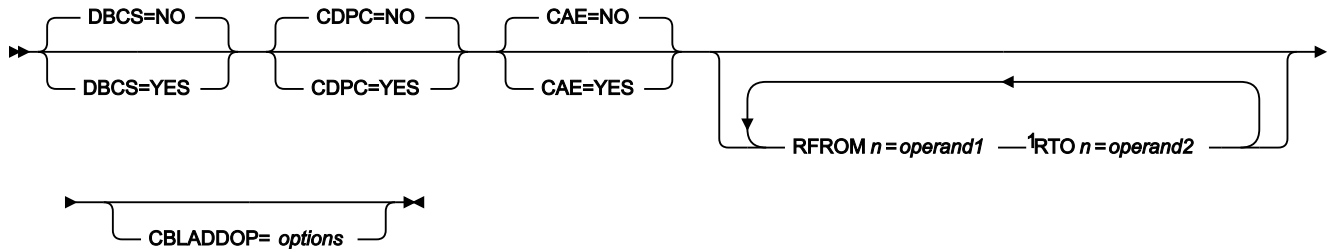

PL/I options

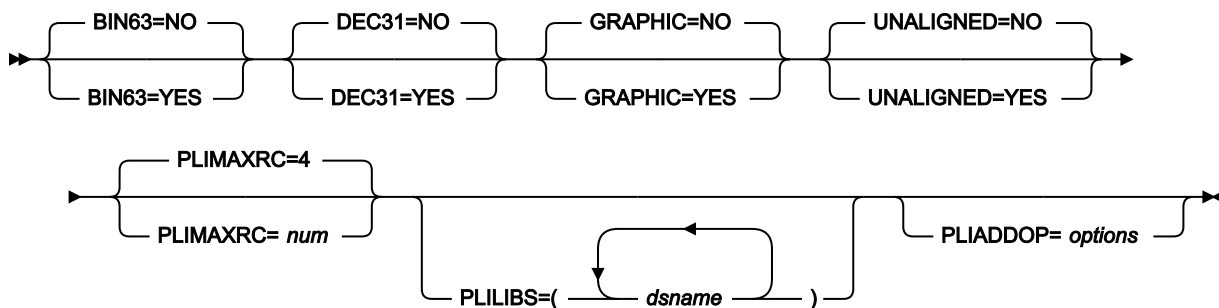

Notes:

¹ n= 1 to 5.

HLASM options

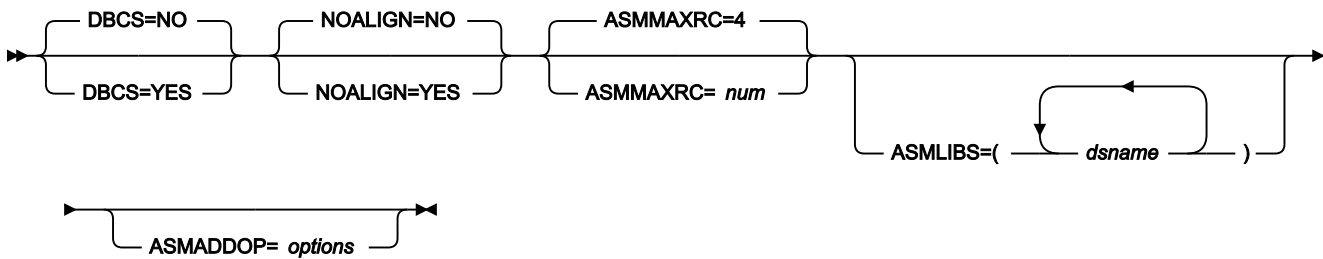

INPUT=ddname

Defines a reference to a DD or TSO ALLOC statement for the input data sets. The default is DDIN.

If you specify a concatenated DD, then you must provide the member name, *member*.

DSNIN=dsname

Specifies the name of the data set that contains the copybooks, templates, IMS™ views, or IMS™ criteria sets. The name may include a member name in parenthesis. If the member is specified here, the associated Member parameter must be empty.

MEMBER=member

Where *dsname* is a partitioned data set, CA-Panvalet library, or a library accessed using the Library Management System Exit, specifies the member name. You can specify a pattern to print multiple members. If the input data set is partitioned and you omit the MEMBER parameter, then every member is printed.

ARRAY=YES

Print all occurrences of array elements.

ARRAY=NO

Do not print all occurrences of array elements.

HEXLOC=YES

Print start and end values as hexadecimal offsets.

HEXLOC=NO

Print start and end values as decimal offsets.

HEXLEN=YES

Print length values as hexadecimal.

HEXLEN=NO

Print length values as decimal.

CRITERIA=YES

Both template layout and template criteria information are reported.

CRITERIA=NO

Only template layout information (and not template criteria information) is reported.

MEMLIST

Allows you to specify a list of member names.

member_n

The name of the member to be processed. Generic name masks are allowed.

INPUT=DDIN

Note: If you specify a concatenated DD, then you must provide the member name, *member*.

Copybook processing

If you specify a copybook (instead of an existing template), File Manager uses these processing options to compile the copybook into a template:

LANG

Determines whether File Manager automatically detects the copybook language or interprets the language as COBOL, PL/I, or HLASM.



Note: The COMPLANG setting in FMN0POPT is the equivalent of the LANG parameter in batch functions.

- If COMPLANG is set it determines the installation default language for online and batch compilation.
- If COMPLANG is not specified then COBOL is the installation default for online compilation and AUTO is the default for batch compilation.
- If a value of COBOL, HLASM, PL/1, or AUTO is specified (in the **Compiler Language Selection** panel or through the LANG parameter in a batch job) it overrides the default language.

AUTO

Automatically detect whether the copybook language is COBOL or PL/I, and invoke the appropriate compiler. If the compilation results in a return code greater than 4, then invoke the compiler for the other language. If the second compilation also results in a return code greater than 4, then retry the first compiler and report the compilation errors. If File Manager successfully creates a template (despite the compilation errors), then continue processing with the template.

COBOL

Invoke the COBOL compiler to create a template from the copybook. (Do not invoke the PL/I compiler, even if the COBOL compilation results in errors.)

PLI

Invoke the PL/I compiler to create a template from the copybook. (Do not invoke the COBOL compiler, even if the PL/I compilation results in errors.)

HLASM

Invoke the HLASM compiler to create a template from the copybook.

DSINFO

Specifies whether additional data set information for input and output sources should be produced in batch reports for the DSP, DSM, DSC, and FCH commands.

NO

No additional data set information is generated.

YES

Generates data set information including DSORG, RECFM, LRECL, BLKSIZE, and VSAM attributes including average record length, maximum record length, key offset, key length and reuse, for input and output data sets when applicable.

COBOL options

The following options are used to compile a COBOL copybook into a template:

DBCS=YES

Use the DBCS compiler option.

DBCS=NO

Use the NODBCS compiler option.

For details on the effect of the DBCS and NODBCS compiler options, see the *IBM COBOL Programming Guide for OS/390 & VM*.

CDPC=NO

Do not use the COBOL SPECIAL-NAMES paragraph "Decimal-point is comma".

CDPC = YES

Use the COBOL SPECIAL-NAMES paragraph "Decimal-point is comma".

CAE=NO

Do not use the COBOL compile option ARITH(EXTEND).

CAE = YES

Use the COBOL compile option ARITH(EXTEND).

MIXED = NO

Field names stored in the template in uppercase.

MIXED = YES

Field names stored in the template in the original case as coded in the COBOL copybook.

RFROM1 RT01 ... RFROM5 RT05

Up to five pairs of “From” and “To” pseudo-text character strings for the COBOL REPLACE compiler-directing statement.

If your COBOL copybooks contain characters that you want to remove or replace with other characters before compiling the copybooks into templates, then use these replacing options.

For example, if your copybooks contain colon characters (:) that you want to remove before compiling, then specify '==:==' as *operand1* and '=====' as *operand2*.

For details on specifying “From” and “To” strings for COBOL REPLACE, see the *IBM COBOL Language Reference*.

CBLMAXRC

Sets the maximum acceptable return code for a copybook compile. A return code higher than the specified level causes the function to stop. Default is 4.



Note: The COMPMAXRC parameter is still supported but it is recommended that the CBLMAXRC parameter is used instead. If you do specify the COMPMAXRC parameter, it takes precedence over the language MAXRC.

CBLLIBS

Allows you to specify a list of up to ten data set names to be specified in the SYSLIB concatenation list. These data sets are searched in the order specified for COPY and INCLUDE members for the compilation.

dsname

The name of the data set name to be processed. Generic name masks are not allowed.

CBLADDOP

Additional COBOL compiler options which are included in a CBL statement when compiling COBOL copybooks.

PL/I options

The following options are used to compile a PL/I copybook into a template:

BIN63=YES

Use the LIMITS(FIXEDBIN(63)) compiler option.

BIN63=NO

Use the LIMITS(FIXEDBIN(31)) compiler option.

DEC31=YES

Use the LIMITS(FIXEDDEC(31)) compiler option.

DEC31=NO

Use the LIMITS(FIXEDDEC(15)) compiler option.

GRAPHIC=YES

Use the GRAPHIC compiler option.

GRAPHIC=NO

Use the NOGRAPHIC compiler option.

UNALIGNED=YES

Use the DEFAULT RANGE (*) UNALIGNED, language statement to change the default alignment.

UNALIGNED=NO

Use the PL/I default.

PLIMAXRC

Sets the maximum acceptable return code for a copybook compile. A return code higher than the specified level causes the function to stop. Default is 4.



Note: The COMPMAXRC parameter is still supported but it is recommended that the PLIMAXRC parameter is used instead. If you do specify the COMPMAXRC parameter, it takes precedence over the language MAXRC.

PLILIBS

Allows you to specify a list of up to ten data set names to be specified in the SYSLIB concatenation list. These data sets are searched in the order specified for COPY and INCLUDE members for the compilation.

dsname

The name of the data set name to be processed. Generic name masks are not allowed.

PLIADDOP

Additional PL/I compiler options which are included in a *PROCESS statement when compiling PL/I copybooks.

For details on the effect of these compiler options, see the *IBM VisualAge PL/I for OS/390 Programming Guide*.

HLASM options

The following options are used to compile a HLASM copybook into a template:

DBCS=YES

Use the DBCS compiler option.

DBCS=NO

Use the NODBCS compiler option.

NOALIGN=YES

Use the NOALIGN compiler option.

NOALIGN=NO

Use the ALIGN compiler option.

ASMMAXRC

Sets the maximum acceptable return code for a copybook compile. A return code higher than the specified level causes the function to stop. Default is 4.



Note: The COMPMAXRC parameter is still supported but it is recommended that the ASMMAXRC parameter is used instead. If you do specify the COMPMAXRC parameter, it takes precedence over the language MAXRC.

ASMLIBS

Allows you to specify a list of up to ten data set names to be specified in the SYSLIB concatenation list. These data sets are searched in the order specified for COPY and INCLUDE members for the compilation.

dsname

The name of the data set name to be processed. Generic name masks are not allowed.

ASMADDOP

Additional HLASM compiler options which are included in a *PROCESS statement when compiling COPY and MACRO members.

For details on the effect of these compiler options, see the *HLASM V1R6 Programmer's Guide*.

```
$$FILEM PBK DSNIN=FMUSER.TEMPLATE,
$$FILEM MEMBER=DITTST1
```

PWB (PDSE Workbench)

Purpose

Display the member list for PDS and PDSE data sets. For PDSEs that support generations, member generations can optionally be displayed. Commands can be performed against members, including member generations.

Usage notes

When invoked from an ISPF Command line without any parameters, or from the File Manager Utilities menu, the PDSE Workbench Entry panel is displayed. If you specify any parameters, the PDSE Workbench Entry panel is bypassed and the PDSE Workbench Member List panel is displayed.

The PDSE Workbench function is not supported in batch.

Options

None.

Figure 456. Syntax

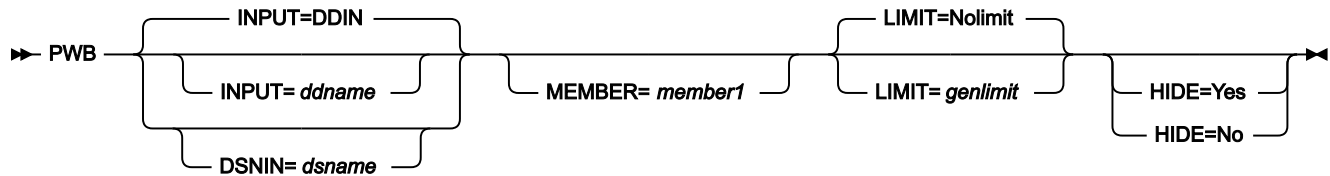

INPUT=*ddname*

Defines a reference to a DD or TSO ALLOC statement for the input data set to be displayed in PDSE Workbench. The default is DDIN. The allocated ddname must be a single PDS or PDSE. Concatenated data sets are not supported.

DSNIN=*dsname*

Defines the name of the cataloged input PDS or PDSE. The name can include a member name or member name pattern in parentheses. If the member name is specified here, the MEMBER parameter must not be specified.

MEMBER=*member1*

The name of a single member or a pattern representing one or more members of the PDS or PDSE to display in the member list. A pattern is a partial member name that uses either an * (asterisk) or % (percent sign) as place holders:

- A * symbol represents a string of characters.
- A % symbol represents only a single character.

LIMIT=*genlimit*|Nolimit

Specifies the maximum number of generations to be displayed in the member list for each member. Range: 0 - 2000000000.

LIMIT=0 displays member alias information but does not display any member generations. LIMIT=Nolimit displays all member generations that match the member name or member name pattern. Current members (generation 0) are always displayed.

genlimit is ignored for data sets that do not support member generations.

HIDE=Yes|No

Yes

Displays PDSE Workbench with the input fields hidden to maximize the size of the member list.

No

Displays PDSE Workbench including all of the input fields.

When HIDE is not specified, the previous setting is used. The default is HIDE=NO for first-time users. When PDSE Workbench is displayed, use the HIDE primary command to toggle the display of the input fields.

REW (Tape Rewind)

Purpose

Rewind a tape to the load point.

Usage notes

After completion of the function, the tape is positioned at load point (beginning of tape).

Options

None.

Related functions

BSF

Move the tape backward one or more files

BSR

Move the tape backward one or more records

ERT

Erase a tape from the current position to the end of the tape

FSF

Move the tape forward one or more files

FSR

Move the tape forward one or more records

RUN

Rewind a tape and unload it

WTM

Write one or more tape marks

Figure 457. Syntax

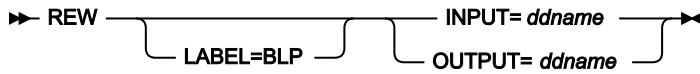
**ddname**

Refers to a DD or TSO ALLOC statement.

LABEL=BLP

Specifies that bypass label processing is used. This parameter must be specified with the first File Manager function that uses the tape. For BLP processing requirements, see “Customizing the Security Environment” in the *File Manager for z/OS Customization Guide*.

RUN (Tape Rewind-Unload)**Purpose**

Rewind a tape and unload it.

Usage notes

Use this function to rewind a tape and unload it. The tape is closed; the allocation is freed if the tape was dynamically allocated during the current File Manager session.

Options

None.

Related functions**BSF**

Move the tape backward one or more files

BSR

Move the tape backward one or more records

FSF

Move the tape forward one or more files

FSR

Move the tape forward one or more records

REW

Rewind a tape to its load point

Figure 458. Syntax

**ddname**

Refers to a DD or TSO ALLOC statement.

SCS (Catalog Services)**Purpose**

Print a list of catalog entries.

Usage notes

Use this function to print catalog entries.

Options

Use a fully-qualified or generic file ID to limit the output. You can also specify the type of objects you want to see. The list can be sorted by entry name, creation date, expiration date, or amount of free space.

Related function**DVT**

Print VTOC entries

Figure 459. Syntax

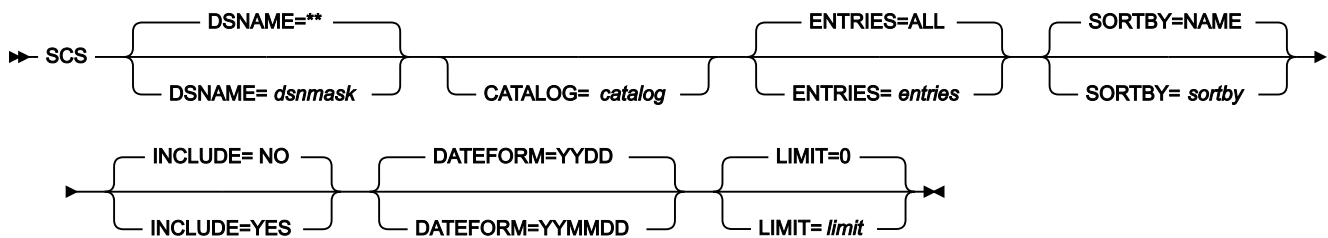
**CATALOG**

Name of a catalog. By default, the system catalog search order is used.

dsnmask

A generic data set name. Within the data set name, you can include a percent sign (%) to represent exactly one character, an asterisk (*) to represent any number of characters (or no characters) within a qualifier, or two asterisks (**) to represent any number of characters (or no characters) within any number of qualifiers. The default is **.

To print a single entry, specify a fully-qualified entry name.

ENTRIES

The entries you want listed:

ALL

All catalog entries (the default)

ALLVSAM

All VSAM catalog entries

ALIAS

Alias entries

AIX®

Alternate index entries

CLUSTER

Cluster entries

DATA

VSAM data entries

GDG

Generation data group entries

INDEX

VSAM index entries

NONVSAM

NonVSAM entries

OAM

OAM collection entries

PATH

VSAM path entries

PGSPC

Pagespace entries

UCAT

User catalog entries.

SORTBY

One of the following:

ALLOC

Sorts by allocated space

DATE

Sorts by creation date

DSORG

Sorts by organisation

FREESP

Sorts by free space

LRECL

Sorts by logical record length

NAME

Sorts by data set name (the default)

RECFM

Sorts by record format

INCLUDE

One of the following:

NO

Restricts the data set list to data sets with only the qualifiers entered in the **DSNAME** field. Data sets with additional qualifiers are not be included.

YES

Generates the data set list with all data sets matching the qualifiers in the **DSNAME** field, including data sets with additional qualifiers.

DATEFORM

One of the following:

YYDDD

All dates on the Data Set List panel and listing shown as YYYY.DDD.

YYMMDD

All dates on the Data Set List panel and listing shown as YY/MM/DD.

limit

The maximum number of data sets selected for VTOC or catalog processing.

```
//SCS JOB (acct),'name' Catalog Services
//*
//FMBAT PROC
//FMBAT EXEC PGM=FILEMGR
//STEPLIB DD DSN=FMN.SFMNMOD1,DISP=SHR
//SYSPRINT DD SYSOUT=*
//SYSABEND DD SYSOUT=*
//SYSUDUMP DD SYSOUT=*
// PEND
//*
//DELETE EXEC PGM=IEFBR14
//FILE DD DSN=FMNUSER.SCS.LISTING,
```

```

//          DISP=(MOD,DELETE),
//          SPACE=(TRK,(30,10)),UNIT=SYSDA,
//          RECFM=FBA,LRECL=133
//*
//SCS00    EXEC FMBAT,REGION=6M
//SYSPRINT DD DSN=FMNUSER.SCS.LISTING,
//          DISP=(,CATLG),
//          SPACE=(TRK,(30,10)),UNIT=SYSDA,
//          RECFM=FBA,LRECL=133
//SYSIN DD *
$$FILEM SCS
$$FILEM E0J
/*

```

SET (Set Processing Options)

Purpose

Set various File Manager processing control options.

Usage notes

Use this function to list the processing options that are currently in effect. You can also use the SET function to change one or more options, or reset options to the installation default. If you use the SET function within a batch job, your changes affect only the current batch job. In any other case, your changes are saved in the user profile and are available for further File Manager sessions.

To change the installation defaults that apply to *all* users and batch jobs, see the *File Manager Customization Guide*.

Options

None.

Figure 460. Syntax

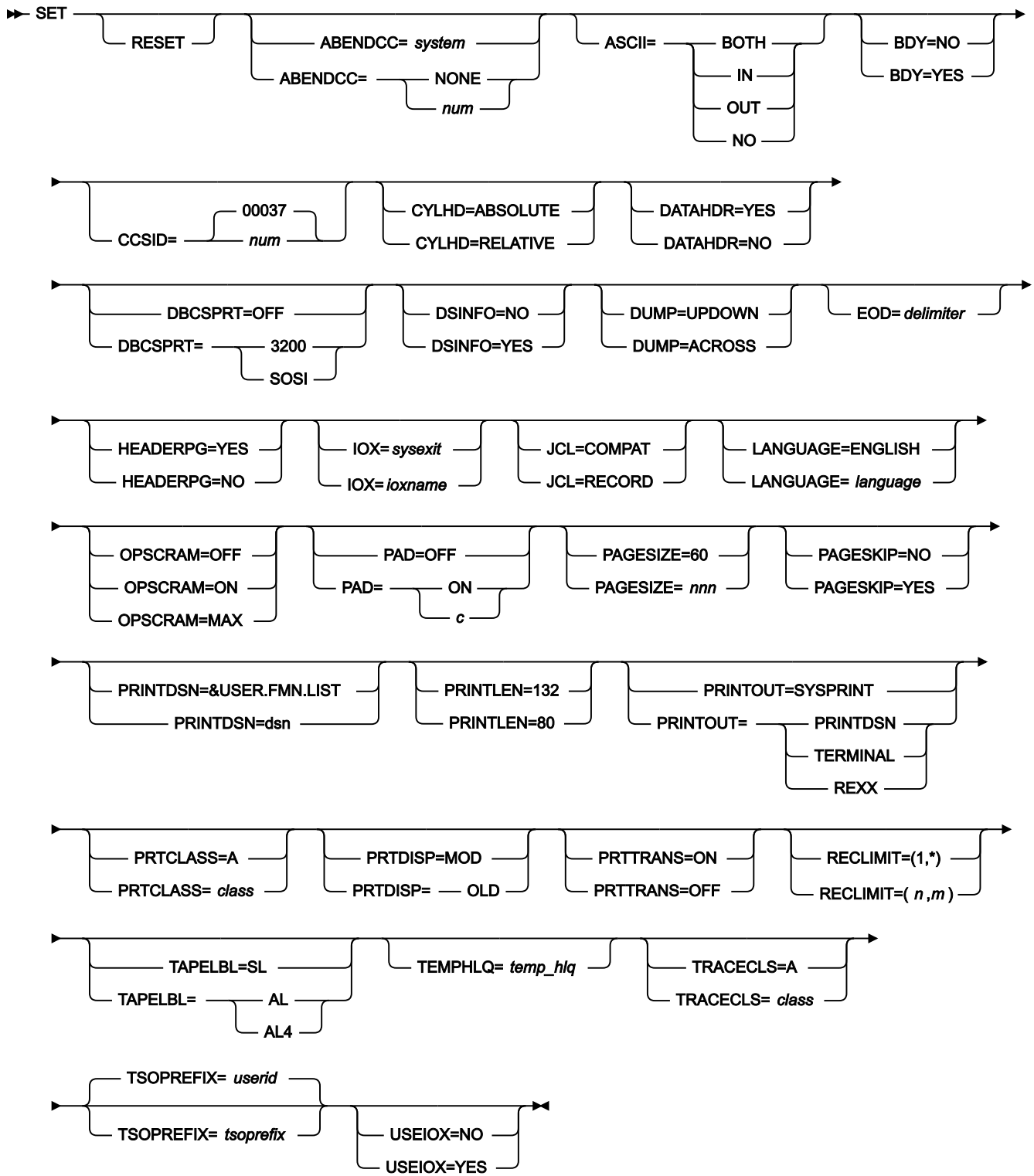
**RESET**

Returns all options to the installation default values (described in the *File Manager Customization Guide*).

ABENDCC

Specifies how File Manager processing resulting in non-zero return code (including customized return code) is completed in batch.

system

Default. This option can be set as part of the customization options for your site. If you do not specify the ABENDCC parameter in the SET function, the installation setting is used. The installation setting defaults to NONE, but if it is set as an integer, that integer becomes the default setting for File Manager batch processing.

NONE

The job step is finished with a non-zero return code.

num

Must be specified as an integer, from 1 to 32767 (0 is treated as NONE).

Use this parameter to transform an original or customized non-zero return code to an abend. If the return code is greater than or equal to *num*, File Manager abends with U999, Reason Code=888 (hex: 378). Abnormal termination of a File Manager step prevents the execution of successors (steps and/or jobs). You can specify the *num* value appropriately to suit the customized return codes issued by File Manager functions.



Note: In addition, specification of any non-zero integer prevents File Manager from intercepting abnormal terminations (system abends).

ASCII

Specifies requirements for translation of tape data between ASCII and EBCDIC. The default setting for this parameter is determined at installation, by the value of the ASCII parameter in the FMNOPOPT macro. Typically, this is set to BOTH.

BOTH

Translates tape input from ASCII format to EBCDIC format, and translates tape output from EBCDIC format to ASCII format.

IN

Translates tape input from ASCII format to EBCDIC format.

NO

Does not translate data.

OUT

Translates tape output from EBCDIC format to ASCII format.

This processing option applies to all tape input and output functions except: Initialize Tape, Tape Browse, Tape Label Display, and Tape Update. For Tape Label Display, ASCII translation is automatically performed when

needed. For Initialize Tape and Tape Browse, you can specify ASCII input or output when invoking the function. For the other (non-tape) functions, ASCII translation is not supported by FMN.

BDY

When data is displayed or printed in SNGL format, this option specifies whether fields that start beyond the current record boundary should be suppressed.

NO

Fields starting beyond the record's boundary are not suppressed.

YES

Fields starting beyond the record's boundary are suppressed.

CCSID

Specifies the CCSID to be used as the default CCSID when File Manager is run in batch. The CCSID specified should be a valid CCSID and a CCSID which is recognised by the Z/OS system which runs the batch job.

CYLHD

Defines the way you specify the location of a disk data set in disk functions.

ABSOLUTE

File Manager interprets cylinder-head and track-number values as actual physical addresses.

RELATIVE

File Manager interprets cylinder-head and track-number values as relative to the start of the data set.

DATAHDR

When data is printed in CHAR print format, specifies whether record number and length are included in character-format print output.

The DATAHDR setting affects only DSP and FCH processing.

NO

Record header information is not included in character-format output. Specify DATAHDR=NO to left-justify the data in the print output, without header information.

YES

Record header information is included in character-format output.

DBCSPRT

This option is no longer used. The syntax is kept for compatibility only.

DSINFO

Specifies whether additional data set information for input and output sources should be produced in batch reports for the DSP, DSM, DSC, and FCH commands.

NO

No additional data set information is generated.

YES

Generates data set information including DSORG, RECFM, LRECL, BLKSIZE, and VSAM attributes including average record length, maximum record length, key offset, key length and reuse, for input and output data sets when applicable.

DUMP

Specifies the format of hexadecimal print output (for example, when you use Tape Print with **Print format** set to HEX). For an example of each format, see [Selecting a display format on page 105](#).

ACROSS

The hexadecimal digits are displayed as 2 groups of 4 full words resulting in 32 hexadecimal digits followed by the EBCDIC character display to the right of the hexadecimal display.

UPDOWN

The two digits making up the hexadecimal representation of each EBCDIC character are displayed vertically directly under that character.

EOD

End-of-data delimiter for tape input.

delimiter

A 1- to 8-character delimiter. For character data, enclose the string in quotation marks if it contains blanks, commas, or lowercase letters. For hexadecimal data, enter an X followed by the string enclosed in quotation marks (for example, X'04').

For some tape functions, you specify the number of files to process in an NFILES keyword. If you specify NFILES=EOD, then files are processed until the first record that begins with the EOD delimiter. However, there is no default EOD delimiter for tape input. So, if you want to specify NFILES=EOD, then you must first use the SET function to specify an EOD delimiter; otherwise, File Manager issues an error.

HEADERPG

Specifies whether a header page (a title page with File Manager on it) is included in print output. If the PRINTOUT option is set to TERMINAL, then the header page is not included in print output, even if HEADERPG is set to YES.

NO

A header page is not included in print output.



Note: For the HEADERPG=NO setting to be effective for the duration of the entire batch processing, you must specify it as the first File Manager control statement. The HEADERPG=NO setting also suppresses the output of the message "FMN0062I current SET function values" as long as it is active.

YES

A header page is included in print output.

IOX

Specifies the name of the user I/O exit. This option only takes effect if your site customization for File Manager allows user I/O exits on a site-wide basis, *and* one of these is true:

- A prior SET function set USEIOX to YES.
- The current SET function is setting USEIOX to YES.

There are no restrictions on the programming language that you can use to write an exit, however, the exit must be provided to File Manager in the STEPLIB/ISPLLIB concatenation or their extensions (LINKLIST, LPA, and so on).

sysexit

Default. If you specify USEIOX=YES and do not supply a user I/O exit name, File Manager uses the name of the exit provided by either a prior SET function in the current job step, or the installation customization options. If you specify USEIOX=YES and no installation default has been provided, you must specify IOX=*ioxname*.



Note: If you have selected batch processing in an online panel, the generated JCL statements use the default name provided in your Set System Processing Options panel.

ioxname

The name of a PDS(E) member of a data set that has been provided to File Manager in the STEPLIB concatenation.

JCL

Defines the method by which JCL data is processed when running FCH or DSC with JCL=YES.

COMPAT

File Manager reformats the physical JCL records into a single logical JCL statement for processing and then builds a new set of physical JCL records.

RECORD

File Manager processes each physical JCL record as is, unless it contains a parameter field enclosed in apostrophes. If this parameter continues across multiple records, the records are flowed together to join the parameter before processing.

LANGUAGE

Specifies the language of File Manager message text and panel text. The possible values depend on which translated message text you installed.

For instructions on installing translated messages and panels, and the keyword values that you can specify for the LANGUAGE processing option, see the *File Manager Customization Guide*.

OPSCRAM

This option specifies the method used to perform random scrambling or repeatable scrambling as defined in the **To** template.



Note: Each optimization option uses a different repeatable scrambling algorithm. Repeatable results can only be obtained by using the same optimization option.

OFF

No optimization is performed.

ON

This option is designed to improve performance when scrambling large amounts of data where the Repeat or Random option has been specified for various fields.

MAX

This option is designed to provide the maximum performance improvement.



Note: If Repeat or Random has been specified for a field and a value list is not provided then duplicate alphanumeric characters within a field will yield the same scrambled character.

Example:

```

$$FILEM SET OPSCRAM=ON
$$FILEM DSC ,
$$FILEM DSNIN=FMNAPAR.PH31085.DATA,
$$FILEM MEMBER=RFTEST,
$$FILEM TCIN=FMNAPAR.PH31085.TEMPLATE(RFTEST),
$$FILEM DISP=OLD,
$$FILEM TCOUT=FMNAPAR.PH31085.TEMPLATE(RFTEST),
$$FILEM MEMOUT=RFTEST,
$$FILEM DSNOUT=FMNAPAR.PH31085.DATAO.REPEAT.FIELD

```

PAD

Specifies whether records are padded or truncated while being copied.

OFF

Records are not padded with blanks or a specified character, except where required by the output record format. If the output records are fixed format, they are padded with nulls ('00'x), as required to match the output record length. Variable and undefined format outputs are not padded.

Output records are always truncated if they exceed the maximum record length (for fixed or variable) or maximum block length (for undefined formats). However, trailing blanks that fit within the maximum length are not stripped from the record.

ON

Records are modified, depending on the output record format. For fixed-format output, input records that do not fit are truncated or padded with blanks. For variable or undefined output, trailing blanks are stripped from the input record. (For reasonable results, do not try to deblock and pad in one run.)

c

The value used for padding records. This can be a single character or a hexadecimal value. For example, you can enter an `x` followed by two hexadecimal characters enclosed in quotation marks (`X'00'`). In addition, for variable or undefined output, a trailing series of the specified character is stripped from the input record. Essentially, this option has the same effect as `PAD=ON` except that the specified character `c` is used for padding or truncation instead of blanks.

PAGESIZE

Specifies the number of lines printed on each page of print output. You can specify a value from 1 to 999. The default is 60.

PAGESKIP

Specifies whether print output from each function begins on a new page.

NO

Print output from each function does not begin on a new page.

YES

Print output from each function begins on a new page.

PRINTDSN

If `PRINTOUT=PRINTDSN` (see below) is specified, then File Manager sends print output to this temporary data set. The default is `userid.FMN.LIST`, unless changed in your File Manager installation.

To browse this data set, enter PB on any File Manager Command line. Then, to forward the contents of the data set to PRTCLASS class, enter PRINT. For details, see [Printing from File Manager on page 402](#).

PRINTLEN

Specifies the line length of print output.

80

The line length of print output is 80 characters, suitable for a terminal.

132

The line length of print output is 132 characters, suitable for a printer.



Note: PRINTLEN is not applicable when:

- The data is printed in TABL format, or
- You specify the wide format for the compare output listing

In either of the above cases, when data is printed the line length is determined from the number and size of fields printed. If this length is greater than the record length specified for the data set, the print line is truncated. The maximum print line length is 32760.

PRINTOUT

Specifies where print output is sent, except for batch execution.

SYSPRINT

Send print output to the current SYSPRINT allocation.

TERMINAL

Send print output to the TSO terminal.

PRINTDSN

Output is accumulated in the print data set specified in the Data set name field (PRINTDSN). This data set can be browsed using the PB command or sent for printing to the JES spool queue with class specified in the Output class field using the PRINT command while browsing.

REXX

Send output to a REXX stem variable. Each line corresponds to a variable named FILEM.*nnn*. FILEM.0 contains the line count.

When you use the PRINT primary command in Print Browse (option 3.9), or if you specify batch execution in a File Manager panel, then print output is always sent to a JES class.

PRTCLASS

Specifies the class of the JES spool queue to be used when the PRINT command is issued while browsing the temporary print data set.

PRTDISP

Specifies the disposition of a print data set.

OLD

The print data set is cleared before each print operation, and print output is written from the beginning of the data set.

MOD

Default setting. Print output is appended to the existing print data set.

PRTRTRANS

Specifies how File Manager translates non-printable characters.

OFF

No translation performed. Use PRTRTRANS=OFF to support special print chains. This might make printing faster.

ON

Non-printable characters translated to blanks using a translate table.

For instructions on altering the print translate table, see the *File Manager Customization Guide*.

RECLIMIT

When data is printed in CHAR or LHEX print format, limits print output for each record (or OAM object).

(*n,m*)

Print output is limited to the data from columns (bytes) *n* through *m*. An asterisk (*) specified for *m* indicates the end of the record.

(1,*)

The entire record (or block) is printed.

TAPELBL

Specifies the type of labels that are created:

AL

ANSI Version 3 labels are created. ("Version 3" refers to ANSI X3.27-1978, ISO 1001-1979, and FIPS 79 standards.)

AL4

ANSI Version 4 labels are created. ("Version 4" refers to ANSI X3.27-1987 level 4 and ISO 1001-1986(E) standards.)

SL

EBCDIC labels are created.

For detailed information about ANSI tape labels, see z/OS DFSMS: Using Magnetic Tapes.

This parameter only affects Initialize Tape (option 4.12).

TEMPHLQ

TEMPHLQ specifies an installation-specific high-level qualifier for the temporary data sets created during a File Manager session. You can specify any valid qualifier, including multilevel if required, up to a total length of 24 characters. If you specify &USER. for any part of the qualifier, this is replaced with the user's userid. A multilevel qualifier with symbols follows the same rules as in the specification of a data set name with symbolic parameters in JCL procedures. Thus, a single period used after a symbol combines the symbol with the text following it (see Example 1); a period separating parts of a multilevel qualifier must be doubled (see Example 2).

Example 1

If the userid is XXXX, then specifying &USER.1.TEMP results in a high-level-qualifier of
XXX1.TEMP

Example 2

If the userid is ZZZZ then specifying FMN.&USER..ABCD results in a high-level-qualifier of
FMN.ZZZZ.ABCD



Note:

1. The TEMPHLQ parameter can be up to 24 characters long. However, temporary data sets can have different lengths, and the system part of the data set name may be longer than 20 characters. In this case, minor levels of TEMPHLQ are ignored, to the extent that the final data set name is less than or equal to 44 characters.
2. Concatenation of &USER.string could result in a part of the high-level qualifier being longer than 8 characters. In this case, the string is shortened to the extent that the final part of the qualifier is 8 characters long.

TRACECLS

Specifies the class of the JES spool queue to be used when the PRINT command is issued when browsing the temporary trace data set.

TSOPREFIX

This parameter allows you to specify the user's TSO prefix. The parameter is provided because functions run in batch mode cannot obtain the user's TSO prefix but sometimes they require it. Batch functions may require it when the &PREFIX symbol is specified in the TEMPHLQ or AUDITHLQ parameters in the File Manager Installation Options modules or the TEMPHLQ parameter of a SET function. The &PREFIX symbol represents the user's TSO prefix, so when File Manager functions encounter this symbol in any of the above parameters,

they are supposed to substitute the user's TSO prefix. Batch functions can only do this, if this parameter is specified.

USEIOX

Specifies whether to invoke a user I/O exit.



Note:

1. If your site customization for File Manager does not allow user I/O exits, you cannot use this option to override that setting.
2. The user I/O exit values set with the SET function have no effect unless a subsequent function requests I/O exit processing using its own options; for example, USEIOXIN for the DSC (Data Set Copy) input user I/O exit.

Also, see [Setting your System Processing Options \(option 0.2\) on page 80](#).

NO

Do not invoke a user I/O exit.

YES

Invoke a user I/O exit. This option is only effective if your site customization for File Manager allows user I/O exits on a site-wide basis.

SETCICS (Update the status of CICS® files) -- batch only

Purpose

Change the status of files for a CICS® region from a batch job.

Usage notes

The function requires the following information to be supplied:

- The APPLID of the CICS® region
- A list of names for the CICS files to be updated
- A list of the status values to be applied to the files

The `CICS File Status Update Report` lists the CICS files that were updated and their file status. Any errors that occurred are also shown in the report.

Related functions

None.

Figure 461. Syntax

► SETCICS — APPLID= *applid* — FILE=(*file_n*) — STATUS=(*stat_n*) ►

applid

The APPLID of the CICS region for the files.

file_n

The name of a single CICS file or a file name pattern representing one or more CICS files.

A CICS file name pattern can consist of any characters that are valid in a file name and the following two special pattern characters:

asterisk (*)

Represents any number of characters. As many asterisks as required can appear anywhere in a file name pattern. For example, if you enter `*d*`, all files for the CICS region whose name contains "d" are processed.

percent sign (%)

A place-holding character representing a single character. As many percent symbols as necessary may appear anywhere in a file name pattern. For example, if you enter `****`, all files for the CICS region whose name is four characters in length is displayed.

file_n

The new status that the selected CICS files must be changed to:

OPE

Open

CLO

Closed

ENA

Enabled

DIS

Disabled

REA

Read

NOR

Remove read status

UPD

Update

NOU

Remove update status

ADD

Add

NOA

Remove add status

BRO

Browse

NOB

Remove browse status

DEL

Delete

NOD

Remove delete status

Example

For a CICS region with APPLID C68D1FM2, update files whose name begins with BIG and the file named ESDSPATH to be open and available for update.

```
//FMBAT EXEC PGM=FILEMGR
//SYSPRINT DD SYSOUT=*
//SYSIN DD *
$$FILEM SETCICS APPLID=C68D1FM2,
$$FILEM FILE=(BIG*,ESDSPATH),STATUS=(OPE,UPD)
/*
```

The following report is produced:

```
IBM File Manager for CICS                                     4/29/2020
(2020.120) 14:10 Page 3

CICS File Status Update Report for APPLID C68D1FM2

File      Data Set                                           Attributes          Errors
-----
BIGESDS1  FMN.REGTEST.CICS.TEST.BIGESDS1                    OPE ENA REA UPD ADD BRO
BIGKSDS1  FMN.REGTEST.CICS.TEST.BIGKSDS1                          OPE ENA REA UPD ADD BRO DEL
BIGKSDS2  FMN.REGTEST.CICS.TEST.BIGKSDS2                          OPE ENA REA UPD ADD BRO DEL
ESDSPATH  FMN.REGTEST.BASE.ESDS.PATH2                             OPE ENA REA UPD ADD BRO DEL
```

SETRC (Set the job step return code)

Purpose

Use the SETRC function to set the job step return code to a specified value. Use conditional parameters to set the return code based on an existing return code value.

Figure 462. Syntax

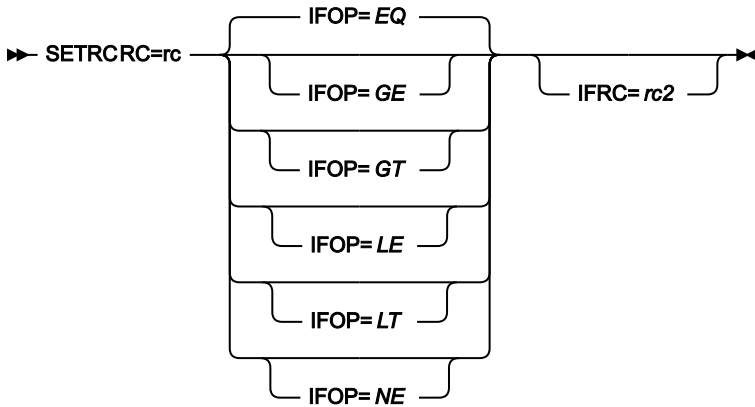

RC=rc

Defines the numeric value that the job step return code is set to.

Range: 0-9999



Note: If you do not specify the **IFRC** parameter with a value, the return code is automatically set to the specified value.

IFOP=nn

Use this parameter with the **IFRC** parameter. The **IFOP** parameter specifies the condition that must be met to set the *RC=rc* value.

EQ

The current return code must be equal to the value that is specified on the **IFRC** parameter.

GE

The current return code must be greater than or equal to the value that is specified on the **IFRC** parameter.

GT

The current return code must be greater than the value that is specified on the **IFRC** parameter.

LE

The current return code must be less than or equal to the value that is specified on the **IFRC** parameter.

LT

The current return code must be less than the value that is specified on the **IFRC** parameter.

NE

The current return code must not be equal to the value that is specified on the **IFRC** parameter.



Note: You must specify the **IFRC** parameter before using the **IFOP** parameter. If you do not specify a value, the default is *IFOP=EQ*.

IFRC=rc2

Defines the numeric value that is checked against the current job step return code. This is to determine if the job step return code is set to the *RC=rc* value.

Range: 0-9999



Note: The **IFOP** parameter determines the condition that must be met to set the job step return code.

SO (Sequential Data to Object)

Purpose

Restore one or more OAM objects that were backed up in a sequential data set, or create a new object from a sequential data set.

Usage notes

Use this function to copy data from a QSAM data set to an object database. If the input is a backup data set created with the OS (Object to Sequential Data) function, the object header records are used for restoring.

If loading from an object backup data set the objects are restored with the original name into the original collection. To filter loading specify a collection name, a generic object name, the location (DASD or OPTICAL, or a specific optical volume), and a creation date range. The filter applies to the object header information saved with the objects.

If the input does not contain backup copies of multiple objects, one object is created. You can specify a collection name and an object name. If the input data begins with an object header record, the default values are taken from it. The object is made up of the concatenated input records, excluding any object header.

Options

You can specify SMS storage class and management class values to be used for storing the object; these might, however, be overridden by your installation defaults. You can also specify whether an existing object with a matching name is to be replaced in the output collection.

For more information about using this function, see [Restoring OAM objects on page 495](#).

Related functions

OO

Copy an object to the same or another collection

OS

Backup objects from an OAM database to a data set

VO

Copy VSAM data to an object database

Figure 463. Syntax

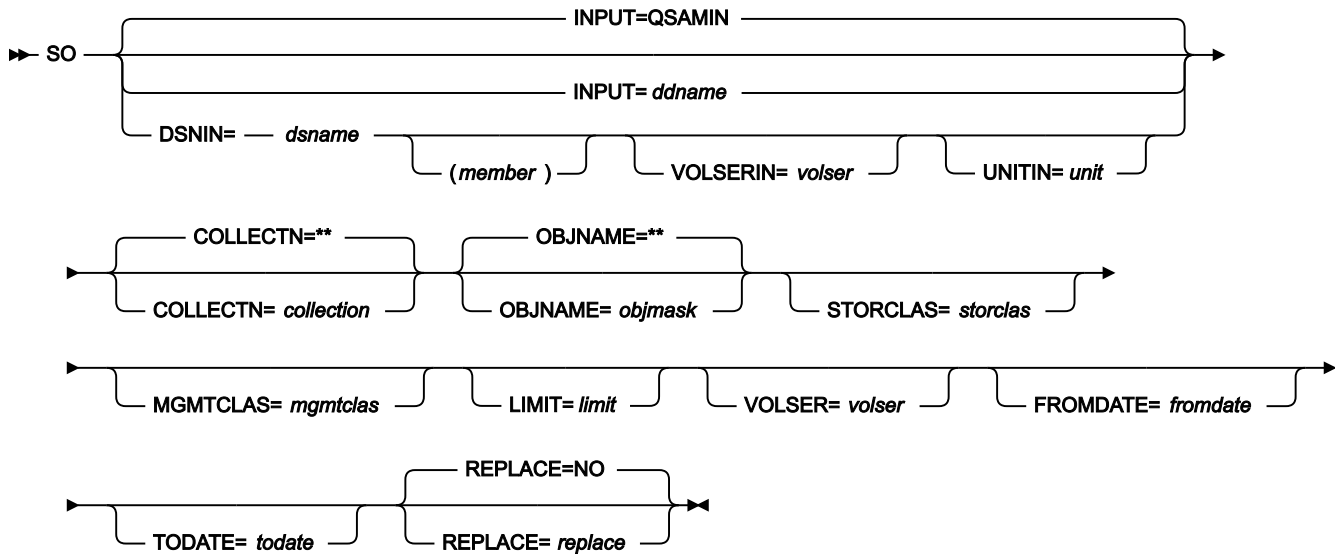

collection

If the data set contains one object with a header, you can optionally specify a collection name to override the collection name in the header.

If the data set contains one object with no header (or, equivalently, it contains data that was not previously an object), you must specify the collection where the object is stored.

If the data set contains one or more objects that were stored during a multiple-object backup, you can optionally specify a collection name to restore only objects from the specified collection.

In any mode except batch mode, the user's TSO prefix (normally the user ID) is used as the high-level qualifier for any name that is not entered in quotation marks.

ddname

Refers to a DD or TSO ALLOC statement. The default is QSAMIN.

dsname

Name of a sequential data set. If any DD statements are specified, they are not used. To further describe the data set, use the appropriate keywords as shown in the syntax diagram.

fromdate

The earliest creation date, in the form *yyyymmdd*. By default, all objects are copied regardless of their creation date.

limit

To limit the objects that are copied based on where the objects were located (before they were backed up to a data set), specify one of the following:

DASD

Only objects that were stored on DASD

OPTICAL

Only objects that were stored on optical disks

VOLUME

Only objects that were stored on a specified optical disk. You must also specify the volser of the optical disk.

member

For a PDS, the member name.

mgmtclas

Name of an SMS management class.

objmask

If the data set contains one object with a header, you can optionally specify an object name to override the object name in the header.

If the data set contains one object with no header (or, equivalently, it contains data that was not previously an object), you must specify a name for the object.

If the data set contains one or more objects that were stored during a multiple-object backup, you can optionally specify an object name or generic object name to limit the objects that are restored based on object name. Within the name, you can include a percent sign (%) to represent exactly one character, an asterisk (*) to represent any number of characters (or no characters) within a qualifier, or two asterisks (**) to represent any number of characters (or no characters) with any number of qualifiers.

In any mode except batch mode, the user's TSO prefix (normally the user ID) is used as the high-level qualifier for any name that is not entered in quotation marks.

replace

Specify YES to replace any existing objects with the same name in the collection. By default, the object is not copied.

storclas

Name of an SMS storage class.

todate

The latest creation date, in the form *yyyymmdd*.

unit

A 3 hexadecimal digit device number, a 4 hexadecimal digit device number prefixed by a slash (/), a device type, or an installation-defined group name.

volser

On input: the volume serial number for a non-cataloged data set.

On output: if you specified VOLUME for *limit*, the volume serial number of the optical disk.

```
//SO JOB (acct), 'name' Restore Objects
//FILEMGR EXEC PGM=FILEMGR
//SYSPRINT DD SYSOUT=*
//OBJBKUP DD DSN='FMN.OBJECT.BKUP',
//          VOL=SER=FM0010,UNIT=CARTR,
//          DISP=OLD
//SYSIN DD *
$$FILEM SO INPUT=OBJBKUP,OBJNAME=**,
$$FILEM COLLECTN=SYSU.OAM.CLLCT000,
$$FILEM LIMIT=VOLUME,VOLSER=OVOL03
$$FILEM EOJ
/*
```

ST (Sequential Data to Tape)

Purpose

Copy records from a sequential data set to a tape file.

Usage notes

Use this function to copy records from a sequential data set to an unlabeled tape.

Unless you have strong reasons for not doing so, use bypass label processing (BLP) with this function.

Specify a DDNAME for the tape.

Options

You can specify the number of records to skip from the beginning of the input data set. You can also specify the number of records to copy, and the output record format and block size.

Related functions**DSC**

Copy a data set to another one

TLT

Copy multivolume, multiple-file labeled tapes

TS

Copy tape data to a data set

Figure 464. Syntax

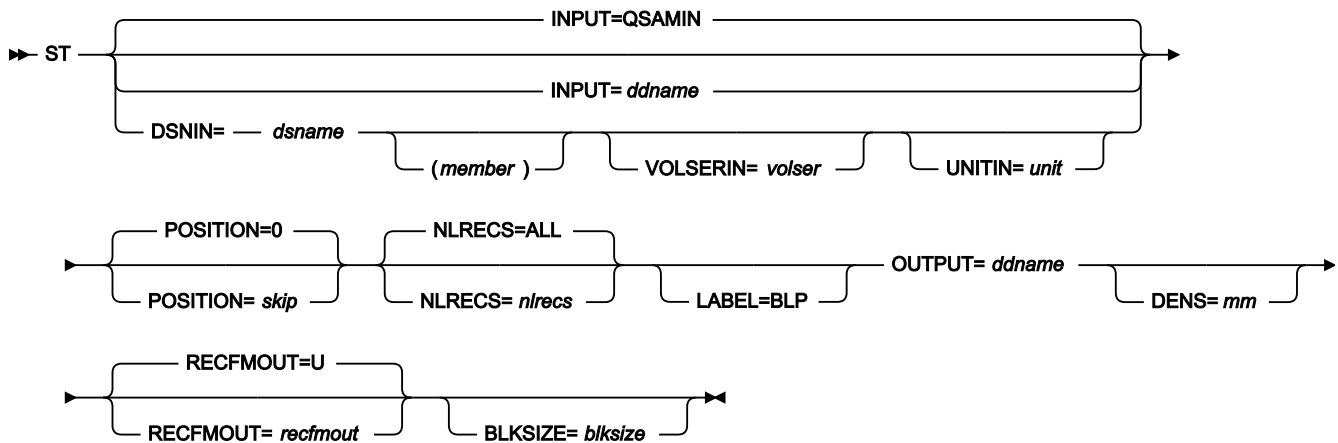
**blksize**

If *recfmout* contains F, the actual block size; otherwise, the maximum block size. If *recfmout* contains B or S, *blksize* is required; otherwise, it is optional. The maximum is 65 535 (for V), 9 999 (for D), or 9 999 999 (otherwise). If the tape is processed by other utilities or standard access methods, you must also consider the operating system limits.

ddname

Refers to a DD or TSO ALLOC statement. The default is QSAMIN for input. To create the output tape file with standard labels, specify AL or SL processing on the DD or TSO ALLOC statement.

dsname

Defines the name of the data set. If any DD statements are specified, they are not used. The name may include a member name in parenthesis. If the member is specified here, the associated Member parameter must be empty. To further describe the data set, use the appropriate keywords as shown in the syntax diagram.

LABEL=BLP

Specifies that bypass label processing is used. This parameter must be specified with the first File Manager function that uses the tape. For BLP processing requirements, see “Customizing the Security Environment” in the *File Manager for z/OS Customization Guide*.

member

For a PDS, the member name.

mm

A 2-byte tape mode as shown in [Tape density and mode values on page 449](#).

nlrecs

Number of records to be copied or ALL. The maximum number is 99 999 999. If you specify ALL or omit the parameter, all the remaining records are copied.

recfmout

Record format for the output. Each value is a combination of the following letters:

B

Blocked

D

Variable-length ISO/ANSI tape records

F

Fixed length

S

Spanned format

U

Undefined length

V

Variable length

The possible values are: U, F, FB, V, VB, VBS, VS, D, DB, DBS, and DS.

skip

Number of logical records to be skipped from the beginning of the data set. The default is 0.

unit

A device number. A 3 hexadecimal digit device number, a 4 hexadecimal digit device number prefixed by a slash (/), a device type, or an installation-defined group name.

volser

Volume serial number for a non-cataloged data set.

```
//ST JOB (acct),'name'  
//* Copy Sequential file to SL Tape  
//*  
//FMBAT PROC  
//FMBAT EXEC PGM=FILEMGR  
//STEPLIB DD DSN=FMN.SFMNMOD1,DISP=SHR
```

```

//SYSPRINT DD SYSOUT=*
//SYSABEND DD SYSOUT=*
//SYSUDUMP DD SYSOUT=*
//          PEND
//*
//DELETE   EXEC PGM=IEFBR14
//BSA1     DD DISP=(MOD,DELETE),UNIT=SYSALLDA,
//          SPACE=(TRK,(1,1),RLSE),
//          DSN=FMNUSER.BS43FB
//*
//STP1001  EXEC FMBAT
//QSAMOUT  DD DISP=(,CATLG),UNIT=SYSALLDA,
//          SPACE=(CYL,(1,1),RLSE),
//          RECFM=FBS,DSN=FMNUSER.BS43FB
//OUTTAPE  DD DSN=TDALAI.S.TAPEOUT,UNIT=CART,
//          DISP=(,KEEP),LABEL=(2,SL),
//          VOL=(,RETAIN,,,SER=FM0001)
//SYSIN    DD *
$$FILEM VER
$$FILEM DSG OUTPUT=QSAMOUT,NLRECS=5677,
$$FILEM RECSIZE=800,KEYLOC=1,KEYLEN=5,
$$FILEM INCR=5,RECFMOUT=FB,FILLCHAR=AN
$$FILEM ST INPUT=QSAMOUT,OUTPUT=OUTTAPE,
$$FILEM RECFMOUT=VB,BLKSIZE=6000
$$FILEM E0J
/*

```

TLB (Tape Label Display)

Purpose

Print tape labels and a tape label summary.

Usage notes

Use this function to print header and trailer label records for all the data sets on a tape.

If a tape is labeled (or if you want to find out if it is labeled), use the TLB function to print the tape labels. File Manager scans the tape until end-of-volume and prints the header and trailer label records for all files on the tape. A summary of the label data is printed at the end of the listing.

Specify the unit address of the tape and optionally a tape mode.

If you do not know the volser and first data set name of the tape, specify BLP during allocation. If your installation does not allow BLP usage, but File Manager is running APF-authorized, File Manager forces BLP for this function; for security reasons, the tape is freed (unallocated) when TLB ends. You must code a deferred mount in the DD statement.

For further information on the use of this function, see [Tape Label Display \(option 4.8\) on page 469](#).

Options

You can choose a short listing, which prints only the VOL1 label and the first header label set.

Related functions**DSP**

Print records from a data set

TMP

Print a summary of the tape contents

TP

Print a specified number of blocks from one or more files on a tape

Figure 465. Syntax

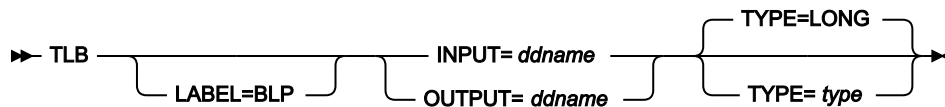
**ddname**

Refers to a DD or TSO ALLOC statement.

LABEL=BLP

Specifies that bypass label processing is used. This parameter must be specified with the first File Manager function that uses the tape. For BLP processing requirements, see "Customizing the Security Environment" in the *File Manager Customization Guide*.

type

Specify one of the following:

LONG

Print all header and trailer label records for all data sets on the tape (the default).

SHORT

Print only the VOL1 label and the header labels for the first data set.

```

//TLB JOB (acct),'name' Tape Label Display
//*
//FMBAT PROC
//FMBAT EXEC PGM=FILEMGR
//STEPLIB DD DSN=FMN.SFMNMOD1,DISP=SHR
//SYSPRINT DD SYSOUT=*
//SYSABEND DD SYSOUT=*
//SYSUDUMP DD SYSOUT=*
// PEND
//*
//FILEMGR EXEC FMBAT
//SYSPRINT DD SYSOUT=*
//TAPE DD UNIT=561,VOL=SER=FM0001,
// DISP=SHR,LABEL=(,BLP)
//SYSIN DD *
$$$$FILEM TLB INPUT=TAPE
  
```



```
$$$FILEM E0J
/*
```

TLT (Tape to Labeled Tape)

Purpose

Copy standard labeled tapes with label processing.

Usage notes

Use this function to copy standard labeled tapes (without requiring you to specify every file ID). Labels read from the input tape are interpreted and copied to the output tape. Input from, and output to, multivolume and multiple file tapes is supported.

You can copy all of the files on the tape (the default), or specify the number of files that you want to copy. Copying starts at the current tape position. This lets you select files from the input volume, and append output volumes.

For an input tape containing both labeled and unlabeled files, specify a MIXED tape format. By default, File Manager ends the function and indicates an error when the input tape does not adhere to the IBM® label standards.

File Manager might force BLP when switching to the next volume. If BLP is forced, for security reasons the tape is freed (unallocated) when TLT ends.

In some error conditions (for example, if unexpired output volumes are used), prompt messages are sent to the operator console.

Specify a DDNAME for the tape.

For further information on the use of this function, see [Tape to Labeled Tape \(option 4.2.3\) on page 459](#).

Options

You can specify a list of new volume serial numbers to be used to rename (initialize) the output volumes dynamically. Specify an asterisk (*) instead of new serial numbers to copy the serial numbers of the input volumes. By default, the serial numbers of the output volumes are not changed.

Related functions

TT

Copy files from one tape to another without label processing

TTC

Compare two tapes byte by byte

TTR

Copy a file from one tape to another with reblocking

Figure 466. Syntax

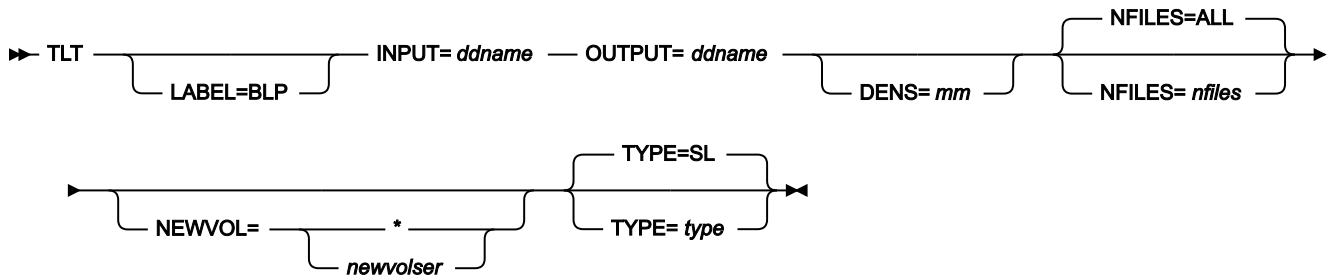
**ddname**

Refers to a DD or TSO ALLOC statement.

LABEL=BLP

Specifies that bypass label processing is used. This parameter must be specified with the first File Manager function that uses the tape. For BLP processing requirements, see "Customizing the Security Environment" in the *File Manager for z/OS Customization Guide*.

mm

A 2-byte tape mode as shown in [Tape density and mode values on page 449](#).

newvolser

Serial number (VOL1) for the initialization of the output volumes. Specify up to five serial numbers in the form (*volser1, volser2,...*) or specify an asterisk (*) to copy the volume serial numbers of the input volumes. If omitted, the serial numbers of the output volumes are not changed.

nfiles

Number of tape files to be copied or ALL. The maximum is 99 999; the default is ALL.

type

Specify one of the following:

MIXED

When copying a tape containing both labeled and unlabeled files.

SL

When copying a standard labeled tape (the default). File Manager indicates an error if the input tape does not have IBM® standard labels.

```
//TLT JOB (acct),'name' Tape to Labeled Tape
//FILEMGR EXEC PGM=FILEMGR
//SYSPRINT DD SYSOUT=*
//TAPE1 DD UNIT=(381,,DEFER),LABEL=(,BLP),
// VOL=SER=(FM01,FM02),DISP=OLD
//TAPE2 DD UNIT=(382,,DEFER),LABEL=(,BLP),
// VOL=SER=(FM03,FM04),DISP=OLD
//SYSIN DD *
$$FILEM TLT INPUT=TAPE1,OUTPUT=TAPE2,NFILES=ALL
```

```
$$$FILEM E0J
/*
```

TMP (Tape Map)

Purpose

Summarize tape contents.

Usage notes

Use this function to determine the contents of a tape. For a specified number of files on the tape, this function prints the contents of the first block or blocks, the number of records, the minimum and maximum block sizes, the size of the file, and the amount of tape used.

You can summarize the contents of the entire tape, or you can limit the summary to a specific number of tape files and, within each tape file, to a specific number of blocks.

Printing starts with the record following the current tape position and includes any leading tape mark.

Processing stops after the specified number of files.

Specify a DDNAME for the tape.

For further information about the use of this function, see [Tape Label Display \(option 4.8\) on page 469](#).

Options

Specify the number of files to be mapped, the number of blocks to be printed from each file, and whether to print in character format or one of the two dump formats.

Various SET processing options allow you to control the print output:

- SET PRINTOUT defines the destination of the print output. If set to PRINTOUT=SYSOUT, you can use the PB (Print Browse) function to browse the accumulated output.
- SET RECLIMIT controls how many bytes of each record are printed.
- The format of the print output also depends on the settings of SET PAGESIZE, SET PRINTLEN, and SET PRTRTRANS.
- Use SET DUMP to specify the dump format.

Related functions

TLB

Print tape labels and a tape label summary

TP

Print a specified number of blocks from one or more files on a tape

Figure 467. Syntax

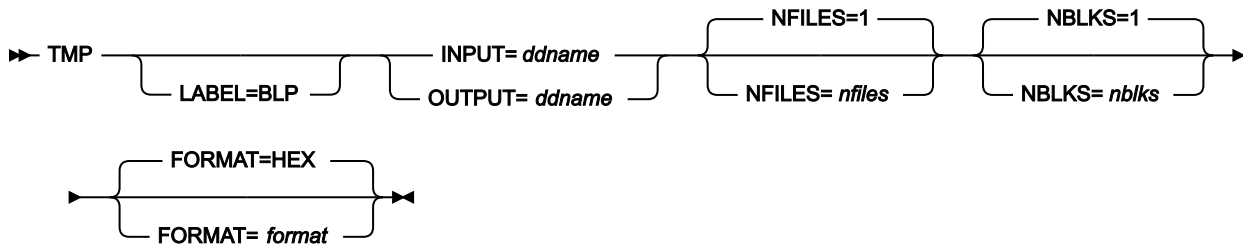

ddname

Refers to a DD or TSO ALLOC statement.

format

The format of the output:

HEX

Hexadecimal format (the default)

CHAR

Character format.

LABEL=BLP

Specifies that bypass label processing is used. This parameter must be specified with the first File Manager function that uses the tape. For BLP processing requirements, see "Customizing the Security Environment" in the *File Manager for z/OS Customization Guide*.

nblks

Number of tape blocks to be printed from each file. The range is 0 to 99 999 999; the default is 1.

nfiles

Number of tape files to be summarized. The maximum is 99 999; the default is 1.

EOV

Summarizes files until a double tape mark or an EOV label is reached.

EOD

Summarizes files until the delimiter specified in the EOD parameter of the SET function is reached. The EOD delimiter is detected only if it appears in the block or blocks specified by *nblks*.

```

//TMP JOB (acct),'name' Tape Map
//*
//FMBAT PROC
//FMBAT EXEC PGM=FILEMGR
//STEPLIB DD DSN=FMN.SFMNMOD1,DISP=SHR
//SYSPRINT DD SYSOUT=*
//SYSABEND DD SYSOUT=*
//SYSUDUMP DD SYSOUT=*
// PEND
  
```

```

/*
//FILEMGR EXEC FMBAT
//SYSPRINT DD SYSOUT=*
//TAPETMP DD UNIT=561,VOL=SER=FM0001,
//          DISP=SHR,LABEL=(,BLP)
//SYSIN DD *
$$FILEM TMP INPUT=TAPETMP,NFILES=EOV
$$FILEM EOJ
/*

```

TP (Tape Print)

Purpose

Print tape files.

Usage notes

Use this function to print tape records in character format or one of the two dump formats. Printing starts with the record following the current tape position and includes any leading tape mark. Processing stops after the specified number of files, or after printing the specified number of records in any one file.

Specify a DDNAME for the tape.

For further information on the use of this function, see [Tape Print \(option 4.5\) on page 466](#).

Options

You can specify the record format and the record length of the input data. In the case of fixed-blocked format, the block length does not need to be a multiple of the specified record length. The remainder is printed as a short record.

Various SET processing options allow you to control the print output:

- SET PRINTOUT defines the destination of the print output. If set to PRINTOUT=SYSOUT, you can use the PB (Print Browse) function to browse the accumulated output.
- SET RECLIMIT controls how many bytes of each record are printed.
- The format of the print output also depends on the settings of SET PAGESIZE, SET PRINTLEN, and SET PRTRANS.
- Use SET DUMP to specify the dump format.

Related function

TMP

Print a summary of the tape contents

Figure 468. Syntax

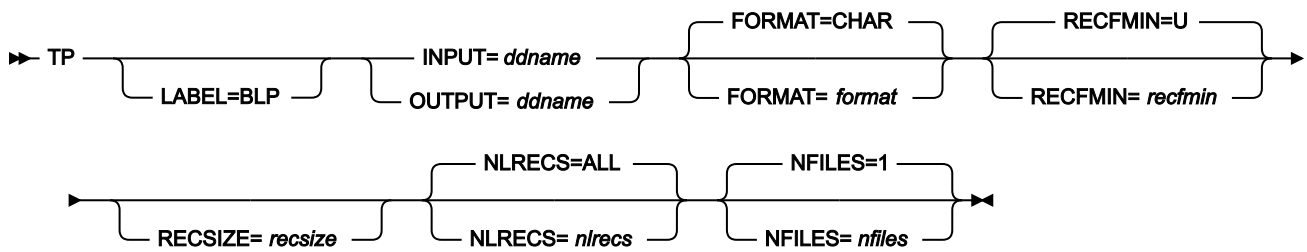

ddname

Refers to a DD or TSO ALLOC statement.

format

The format of the output:

CHAR

Character format (the default)

HEX

Hexadecimal format.

LABEL=BLP

Specifies that bypass label processing is used. This parameter must be specified with the first File Manager function that uses the tape. For BLP processing requirements, see “Customizing the Security Environment” in the *File Manager for z/OS Customization Guide*.

nfiles

Number of tape files to be printed. The maximum is 99 999; the default is 1.

EOV

Prints files until a double tape mark or an EOV label is reached.

EOD

Prints files until the delimiter specified in the EOD parameter of the SET function is reached.

If the maximum number of records per file (*nrecs*) is reached, printing stops and the function ends regardless of the *nfiles* value.

nrecs

Maximum number of records to be printed from any one file. If this number is exceeded, printing stops. This parameter provides protection against printing a file that is much larger than expected. The maximum number is 99 999 999. If you specify ALL or omit the parameter, all the remaining records in the file, up to and including the next tape mark, are printed.

recfmin

Record format for the input. Each value is a combination of the following letters:

B

Blocked

D

Variable-length ISO/ANSI tape records

F

Fixed length

S

Spanned format

U

Undefined length

V

Variable length

The possible values are: U, F, FB, V, VB, VBS, VS, D, DB, DBS, and DS.

resize

Length of the input records, if *recfmin* is F or FB. If *recfmin* is F, the length of the first record is used by default. If *recfmin* is FB, *resize* is required.

TPEXP (Export template to XML)**Purpose**

Export one or more templates to an XML format.

Usage Notes

You can filter the templates selected for processing by providing a filter member names or member masks.

This ensures for File Manager Base component or IMS™ templates built using copybooks that only templates that reference matching copybooks are selected for processing. For IMS™ views and criteria sets the filter is used to match the originating template name. Any other type of template is skipped if you provide a filter.

Related functions**TPIMP**

Template import

Figure 469. Syntax

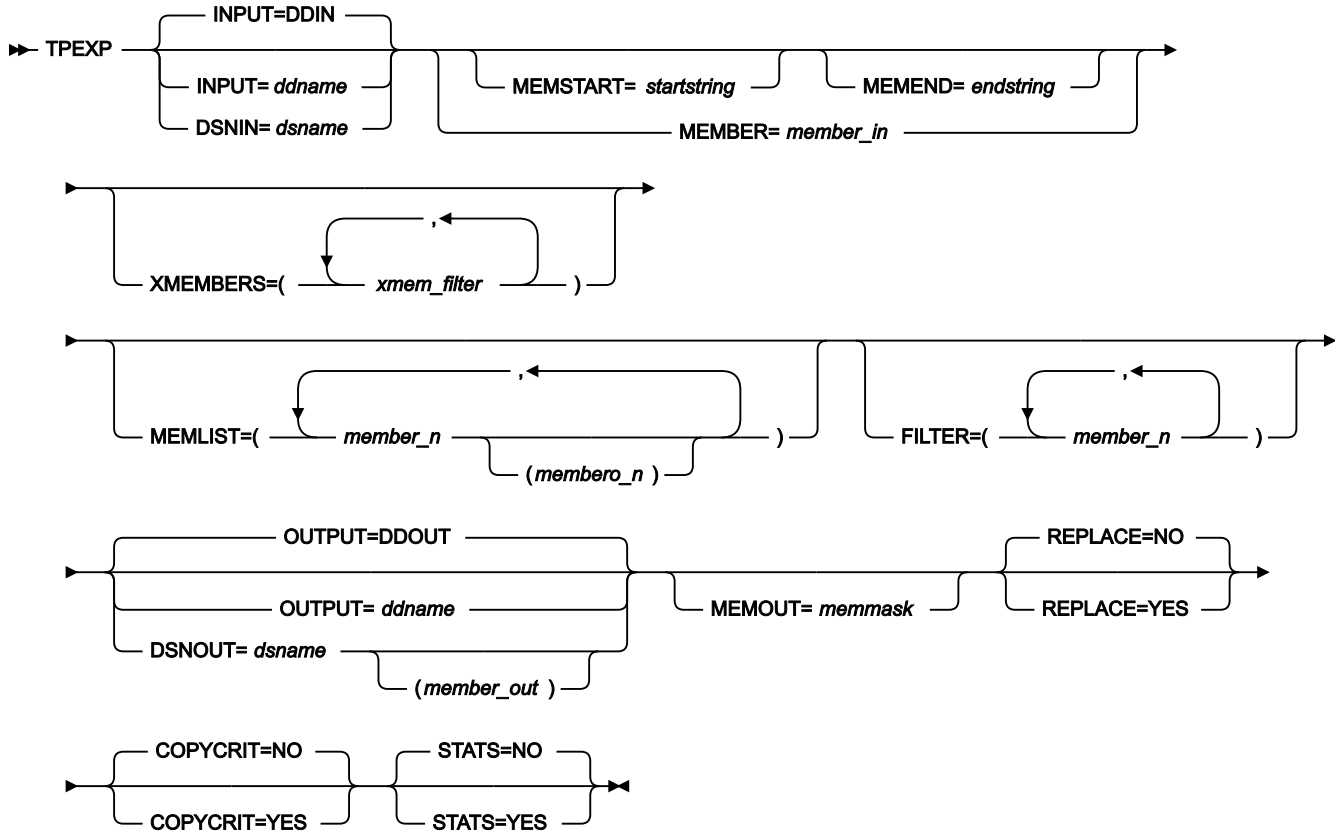

INPUT=ddname

This points to the input DD name which can have one or more associated data sets that must be valid template data sets. If you do not specify INPUT or DSN parameters, then the DD DDIN is used as a default DD name for the input data sets. You can specify concatenated data sets.

DSNIN=dsname

Data set name where templates reside.

MEMBER=member_in

The name of a single member in a PDS, or a member name pattern representing one or more members in a PDS to be processed. A member name pattern can consist of any characters that are valid in a member name and two special pattern characters: the asterisk (*) and the percent symbol (%).

*

represents any number of characters. As many asterisks as required can appear anywhere in a member name pattern. For example, if you enter a member name pattern of *d*, all members in the PDS whose name contains "d" are processed.

%

is a place holding character that means a single character. As many percent symbols as necessary can appear anywhere in a member name pattern. For example, if you enter a member name pattern of %%%%, all members in the PDS whose name is four characters in length are processed. member_in is ignored if the data set is not a PDS.

MEMSTART=startstring

Is used to specify the start of a range of member names to be included. If MEMSTART is specified but MEMEND is omitted, all members of the PDS(E) from the startstring value onwards are included. startstring can have the same values, including wild cards, as for the member-in parameter of the MEMBER keyword.

MEMEND=endstring

Is used to specify the end of a range of member names to be included. If MEMEND is specified but MEMSTART is omitted, all members of the PDS(E) up to the endstring value onwards are included. endstring can have the same values, including wild cards, as for the member_in parameter of the MEMBER keyword.

XMEMBERS

Provides a way to exclude from processing library members that would otherwise be selected using the MEMSTART, MEMEND, and MEMBER options.

xmem_filter

A member name filter identifying one or more members that are to be excluded from processing. A filter can be a member name pattern representing multiple members.

To specify a member name filter containing lowercase characters, use a character string in the format `c' string'`. Filter values can also be specified as hexadecimal strings in the format `x' hex-digits'`.

FILTER

Allows you to specify a list of member names or patterns used to filter so that only templates referencing those copybooks, or copybooks that match the patterns for File Manager Base component and IMS™ templates built using copybooks. For IMS™ views and criteria sets the filter is taken to represent an originating template name. Any other type of template is skipped if a filter is specified.

MEMLIST

Allows you to specify a list of member names with optional associated output XML template names. If you do not specify the output member name File Manager uses the input name or the name as identified by the MEMOUT mask, memmask.

member_n

The name of the member to be processed. Generic name masks are allowed.

membero_n

Exported member name If unspecified, the exported member is not renamed.

OUTPUT=ddname

Identifies the DD card which points to the import template data set in which the exported template is/are stored or replaced. It must refer to a PDS, PDSE, or sequential data set.

DSNOUT=dsname

Defines the data set name where exported templates are created/replaced. It must be a PDS, PDSE, or sequential data set. You can further describe this data set, as follows: (member-out) Where DSNOUT=dsname specifies a PDS and you want to send the output to a specific member within this data set, this defines the output member name.

MEMOUT=memmask

Where a number of input members have been specified, you can specify a member name pattern for the exported templates, allowing you to rename your templates as they are created. The member name pattern can consist of any characters that are valid in a member name and two special pattern characters: the asterisk (*) and percent sign (%).

Asterisk (*)

The asterisk is a place-holding character that means multiple characters with no change. Only one asterisk should appear in the mask. Any subsequent asterisk characters are treated as percent signs. For example, if you enter `ABC*` the renamed members all begin with "ABC" followed by the remainder of the old member name.

Percent sign (%)

The percent sign is a place-holding character that means a single character with no change. As many percent symbols as necessary may appear anywhere in a member name. For example, if you enter `%%%A*` the first three characters of the renamed members remain unchanged, the fourth character is replaced with the letter "A" and the remainder of the old member name remains unchanged.

REPLACE

Specifies whether or not File Manager replaces like-named templates in an output partitioned data set.

NO

Like-named XML templates are not replaced.

YES

Like-named XML templates in the output partitioned data set are replaced.

COPYCRIT

Specifies whether or not to limit the output XML to copybook definitions and criteria. This option is ignored when processing dynamic template as <symbol> elements are required to import a dynamic template.

NO

All XML elements describing the template are produced.

YES

XML is limited to the elements required to create the template and criteria.

STATS

Specifies ISPF member statistics are to be either created or updated by the export process.

NO

Do not update or create ISPF statistics for the exported member(s).

YES

ISPF statistics are updated or created for the exported member(s).

Example: Base export of all templates with member names starting with D through to members starting with C. The exported members are renamed to start with X.

```
//FMBAT EXEC PGM=FILEMGR
//SYSPRINT DD SYSOUT=*
//SYSIN DD *
$$FILEM TPEXP DSNIN=FMN.TEMPLATE.EXAMPLE,
$$FILEM MEMSTART=D*,
$$FILEM MEMEND=C*,
$$FILEM MEMOUT=X*,
$$FILEM DSNOUT=FMN.XML.TEMPLATE,
$$FILEM COPYCRIT=YES,
$$FILEM STATS=YES,
$$FILEM REPLACE=YES
```

It produces this report:

```
Template Export Report
Template      New name     Type         Status
-----
DJ1E         XJ1E        IMS          Exported
DJ1ECR2      XJ1ECR2     IMS CRIT     Exported
DJ1EVW       XJ1EVW      IMS VIEW     Exported
CTEMP1       XTEMP1      BASE         Exported
CTEMP1DYN   XTEMP1DYN   DYNAMIC      Exported
CTEMP3       XTEMP3      BASE         Exported
FMNBA631 6 members read 6 Exported 0 Export replaced 0 Errors
```

Table 26. Export status and action

Status	Explanation	Action
Exported	Template successfully exported to XML format.	None
Exported replaced	Template successfully exported to XML format and existing member replaced	None
Not replaced	Output member exists and REPLACE=NO is specified.	If you want to replace the member specify REPLACE=YES

Table 26. Export status and action (continued)

Status	Explanation	Action
Corrupt template	The input template could not be loaded because it is corrupt.	Recreate the input template and rerun the job.
Template allocate error	The input template data set could not be allocated, possibly not found.	Correct the input data set name and rerun the job.
Not found	The input member name could not be found on the input template data set.	Correct the member name or data set name and rerun the job.
Unexpected error	There should be previous error messages describing the error that occurred.	Read and act on the preceding error messages.

TPIMP (Import template from XML)

Purpose

Import one or more templates from an XML format.

Usage notes

The executed program to import an IMS™ template, view, or criteria set must be FMNIMS. The executed program to import a Db2® template must be FMNDB2. For Db2® templates you must specify the SSID on the execute PARM, and the Db2® object referred to in the XML <db2object> element must exist in the Db2® subsystem for the import to be successful.

Related functions

TPEXP

Template export

Figure 470. Syntax

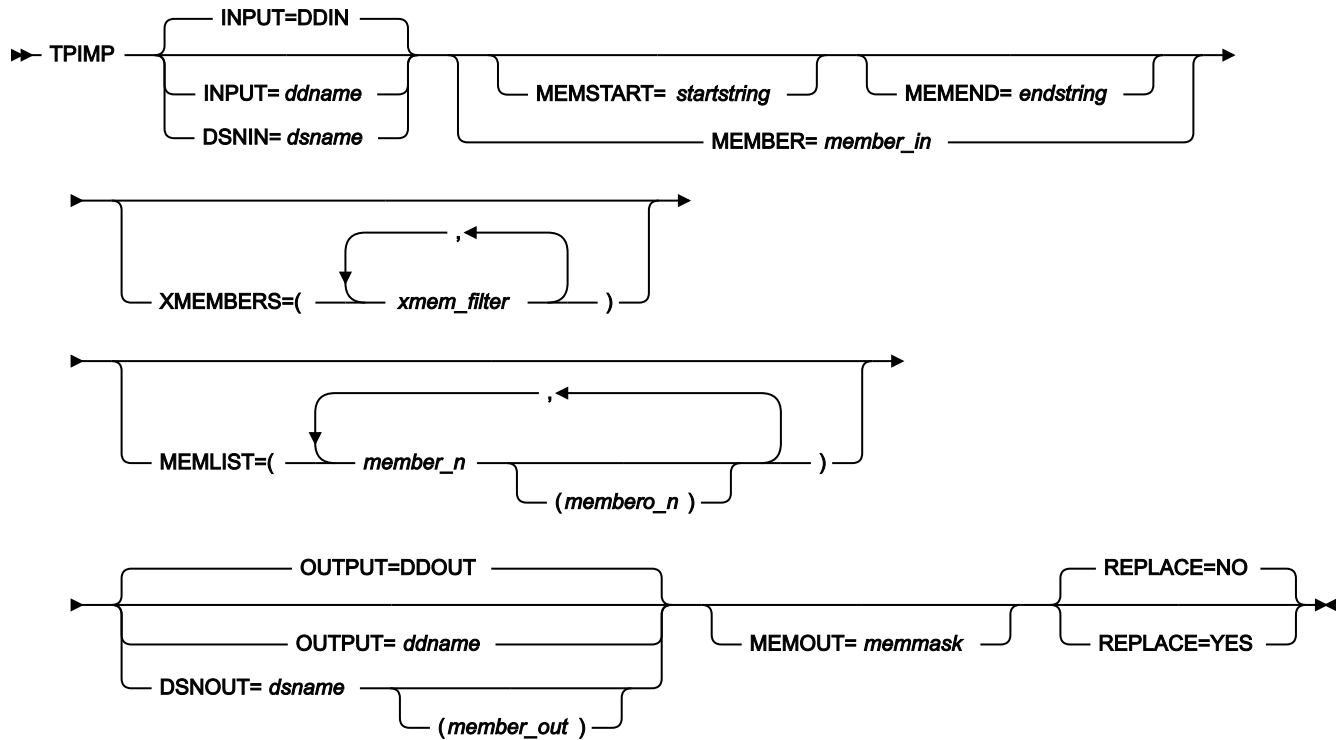
**INPUT=ddname**

This points to the input DD name which can have one or more associated data sets that must be valid XML template data sets. If you do not specify INPUT or DSN parameters, then the DD DDIN is used as a default DD name for the input data sets. You can specify concatenated data sets.

DSNIN=dsname

Data set name where templates reside.

MEMBER=member_in

The name of a single member in a PDS, or a member name pattern representing one or more members in a PDS to be processed. A member name pattern can consist of any characters that are valid in a member name and two special pattern characters: the asterisk (*) and the percent symbol (%).

*

represents any number of characters. As many asterisks as required can appear anywhere in a member name pattern. For example, if you enter a member name pattern of *d*, all members in the PDS whose name contains "d" are processed.

%

is a place holding character that means a single character. As many percent symbols as necessary can appear anywhere in a member name pattern. For example, if you enter a member

name pattern of %%%, all members in the PDS whose name is four characters in length are processed. `member_in` is ignored if the data set is not a PDS.

MEMSTART=startstring

Is used to specify the start of a range of member names to be included. If MEMSTART is specified but MEMEND is omitted, all members of the PDS(E) from the startstring value onwards are included. startstring can have the same values, including wild cards, as for the member-in parameter of the MEMBER keyword.

MEMEND=endstring

Is used to specify the end of a range of member names to be included. If MEMEND is specified but MEMSTART is omitted, all members of the PDS(E) up to the endstring value onwards are included. endstring can have the same values, including wild cards, as for the member_in parameter of the MEMBER keyword.

XMEMBERS

Provides a way to exclude from processing library members that would otherwise be selected using the MEMSTART, MEMEND, and MEMBER options.

xmem_filter

A member name filter identifying one or more members that are to be excluded from processing. A filter can be a member name pattern representing multiple members.

To specify a member name filter containing lowercase characters, use a character string in the format `c'string'`. Filter values can also be specified as hexadecimal strings in the format `x'hex-digits'`.

FILTER

Allows you to specify a list of member names or patterns used to filter so that only templates referencing those copybooks, or copybooks that match the patterns for base and IMS™ templates built using copybooks. For IMS™ views and criteria sets the filter is taken to represent an originating template name. Any other type of template is skipped if a filter is specified.

MEMLIST

Allows you to specify a list of member names with optional associated output template names. If you do not specify the output member name File Manager uses the input name or the name as identified by the MEMOUT mask, memmask.

member_n

The name of the member to be processed. Generic name masks are allowed.

membero_n

Imported member name If unspecified, the imported member is not renamed.

OUTPUT=ddname

Identifies the DD card which points to the import template data set in which the imported template is/are stored or replaced. It must refer to a PDS, PDSE, or sequential data set.

DSNOUT=dsname

Defines the data set name where imported templates are created/updated. It must be a PDS, PDSE, or sequential data set. You can further describe this data set, as follows: (member-out) Where DSNOUT=dsname specifies a PDS and you want to send the output to a specific member within this data set, this defines the output member name.

MEMOUT=memmask

Where a number of input members have been specified, you can specify a member name pattern for the imported templates, allowing you to rename your templates as they are created. The member name pattern can consist of any characters that are valid in a member name and two special pattern characters: the asterisk (*) and percent sign (%).

Asterisk (*)

The asterisk is a place-holding character that means multiple characters with no change. Only one asterisk should appear in the mask. Any subsequent asterisk characters are treated as percent signs. For example, if you enter `ABC*` the renamed members all begin with "ABC" followed by the remainder of the old member name.

Percent sign (%)

The percent sign is a place-holding character that means a single character with no change. As many percent symbols as necessary may appear anywhere in a member name. For example, if you enter `%%A*` the first three characters of the renamed members remain unchanged, the fourth character is replaced with the letter "A" and the remainder of the old member name remains unchanged.

REPLACE

Specifies whether or not File Manager replaces like-named templates in an output partitioned data set.

NO

Like-named templates are updated with the XML definitions.

YES

Like-named templates in the output partitioned data set are replaced.

Example 1. File Manager Base component import of all template with member names beginning with a and renaming the output member names to all begin with Z.

```
//FMBAT EXEC PGM=FILEMGR
//SYSPRINT DD SYSOUT=*
//SYSIN DD *
$$$FILEM TPIMP DSNIN=FMN.XML.EXAMPLE,
$$$FILEM MEMBER=A*,
$$$FILEM MEMOUT=X*,
$$$FILEM DSNOUT=FMN.IMP.EXAMPLE,
$$$FILEM REPLACE=YES
```

It produces this report:

Template Import Report			
Template	New name	Type	Status
ABEND	XBEND	BASE	Import replaced
AODAO140	XODAO140	DYNAMIC	Import replaced
ASMTEST	XSMTEST	BASE	Import replaced
FMNBA635 3 members read 0 Imported 3 Import replaced 0 Errors			

Example 2. Import an IMS™ template, criteria set and a view specifying member names

```
//FMBAT EXEC PGM=FMNIMS
//SYSPRINT DD SYSOUT=*
//FMNIMSIN DD *
$$$FILEM SET HEADERPG=YES,PAGESIZE=60
$$$FILEM TPIMP DSNIN=FMN.XML.EXAMPLE,
$$$FILEM MEMLIST=(DJ1E,
$$$FILEM          DJ1ECR2,
$$$FILEM          DJ1EVW),
$$$FILEM DSNOUT=FMN.IMP.EXAMPLE,
$$$FILEM REPLACE=YES
```

It produces this report:

Template Import Report			
Template	New name	Type	Status
DJ1E		IMS	Import replaced
DJ1ECR2		IMS CRIT	Imported
DJ1EVW		IMS VIEW	Imported
FMNBA635 3 members read 2 Imported 1 Import replaced 0 Errors			

Table 27. Import status and action

Status	Explanation	Action
Imported	Template successfully imported from XML format.	None
Import replaced	Template successfully imported from XML format and existing member replaced	None
Import updated	Template successfully imported from XML format and existing member updated.	None.
Not found	The input member name could not be found on the input template data set.	Correct the member name or data set name and rerun the job.
Unexpected error	There should be previous error messages describing the error that occurred.	These are normally errors in the XML definitions. The error messages should indicate the failing line and reasons. Correct the XML and rerun the job. (See XML definitions for a template on page 1823 .)

TRS (Tape Record Scan)

Purpose

Locate data within a tape file.

Usage notes

You can use this function to locate tape records containing data that meet your search conditions. Scanning starts at the current tape position. Scanning applies to logical records, if a record size or a variable record format is indicated.

The search string can contain up to 50 characters and can be:

- A character string. The string cannot contain blanks or commas. Case (uppercase or lowercase) is ignored.
- A character string enclosed in quotation marks. The string can contain blanks and commas and must match exactly (including case).
- A character string enclosed in quotation marks. The string can contain blanks and commas and must match exactly (including case).
- A hexadecimal string, for example X'04'.

Specify a DDNAME for the tape.

For further information on the use of this function, see [Tape Record Scan \(option 4.10\) on page 471](#).

Options

Specify a record format or a length to deblock the physical records before searching. You can request searching everywhere in the data, from a position you specify or only at the specified offset. You can also specify the number of blocks to be scanned and the number of occurrences of the string to be found before the scan stops. The scan stops when the specified number of blocks is reached or when the specified number of string occurrences have been found, whichever occurs first.

Various SET processing options allow you to control the print output:

- SET PRINTOUT defines the destination of the print output. If set to PRINTOUT=SYSOUT, you can use the PB (Print Browse) function to browse the accumulated output.
- SET RECLIMIT controls how many bytes of each record are printed.
- The format of the print output also depends on the settings of SET PAGESIZE, SET PRINTLEN, and SET PRTRTRANS.
- Use SET DUMP to specify the dump format.

Related functions

FCH

Find or change data

TP

Print a specified number of blocks from one or more files on a tape

Figure 471. Syntax

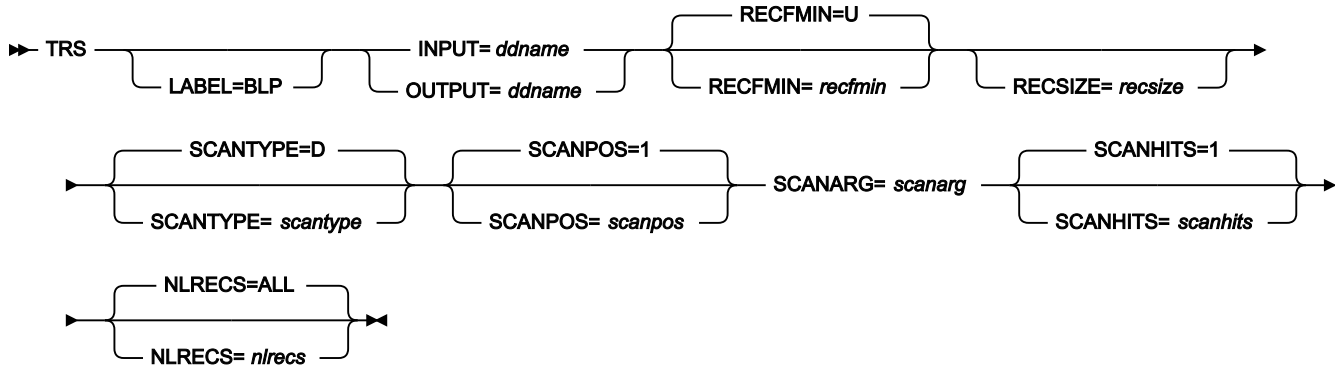

ddname

Refers to a DD or TSO ALLOC statement.

LABEL=BLP

Specifies that bypass label processing is used. This parameter must be specified with the first File Manager function that uses the tape. For BLP processing requirements, see "Customizing the Security Environment" in the *File Manager for z/OS Customization Guide*.

nlrecs

Number of records to be scanned or ALL. The maximum number is 99 999 999. If you specify ALL or omit the parameter, File Manager scans to the end of the file or until the specified number of hits is found.

recfmin

Record format for the input. Each value is a combination of the following letters:

B

Blocked

D

Variable-length ISO/ANSI tape records

F

Fixed length

S

Spanned format

U

Undefined length

V

Variable length

The possible values are: U, F, FB, V, VB, VBS, VS, D, DB, DBS, and DS.

reclsize

Length of the input records, if *reclmin* is F or FB. If *reclmin* is F, the length of the first record is used by default. If *reclmin* is FB, *reclsize* is required.

scanarg

The string to be searched for. The string can contain up to 50 characters and can be:

- A character string. The string cannot contain blanks or commas. Case (uppercase or lowercase) is ignored.
- A character string enclosed in quotation marks. The string *can* contain blanks and commas; the string must match exactly (including case).
- X followed by a hexadecimal string enclosed in quotation marks (for example, X'C1C2C3').

scanhits

Specifies whether scanning stops after the first match is found, after a specified number of matches, or at the end of the file. The maximum is 99 999 999; the default is 1. Specify ALL to scan to the end of the file.

scanpos

Offset (byte position) where the search begins within a record. The default is 1.

scantype

One of the following:

D

Scans records *only* at the position in the record specified by *scanpos* (the default)

DP

Scans records *starting* at the position specified by *scanpos*

```
//TRS JOB (acct),'name' Tape Record Scan
//*
//FMBAT PROC
//FMBAT EXEC PGM=FILEMGR
//STEPLIB DD DSN=FMN.SFMNMOD1,DISP=SHR
//SYSPRINT DD SYSOUT=*
//SYSABEND DD SYSOUT=*
//SYSUDUMP DD SYSOUT=*
// PEND
//*
//FILEMGR EXEC FMBAT
//SYSPRINT DD SYSOUT=*
//TAPE DD UNIT=561,VOL=SER=FM0001,
// DISP=SHR,LABEL=(,BLP)
//SYSIN DD *
```

```

$$$FILEM TRS INPUT=TAPE,SCANARG='HDR2'
$$$FILEM E0J
/*

```

TS (Tape to Sequential Data)

Purpose

Copy tape records to a sequential data set.

Usage notes

Use this function to copy all or selected data from a tape file to a sequential data set on disk, on tape, or SYSOUT. You can also use this function to convert a multiple file tape into a single sequential data set (tape image file), which can be distributed across a network. For more information, see [Copying tape data across a network on page 463](#). Specify a number of files other than one, but no tape file ID or start position.

File Manager converts tape marks into special records containing "FILEMTMFILEMTM...". When restoring the file to tape using the ST (Sequential Data to Tape) function, File Manager converts the special records back into tape marks. The resulting tape is an exact copy of the original tape.

Specify a DDNAME for the tape.

If you want to use allocation parameters that are not supported by File Manager, you must use the TSO ALLOCATE command to allocate the data set out of File Manager with the file name QSAMOUT.

Options

You can specify the record format and the record length of the input data. You can also specify the record format and the block size of the output, and the number of records to copy.

Related functions

ST

Copy a data set to tape

TV

Copy tape data to a VSAM data set

Figure 472. Syntax

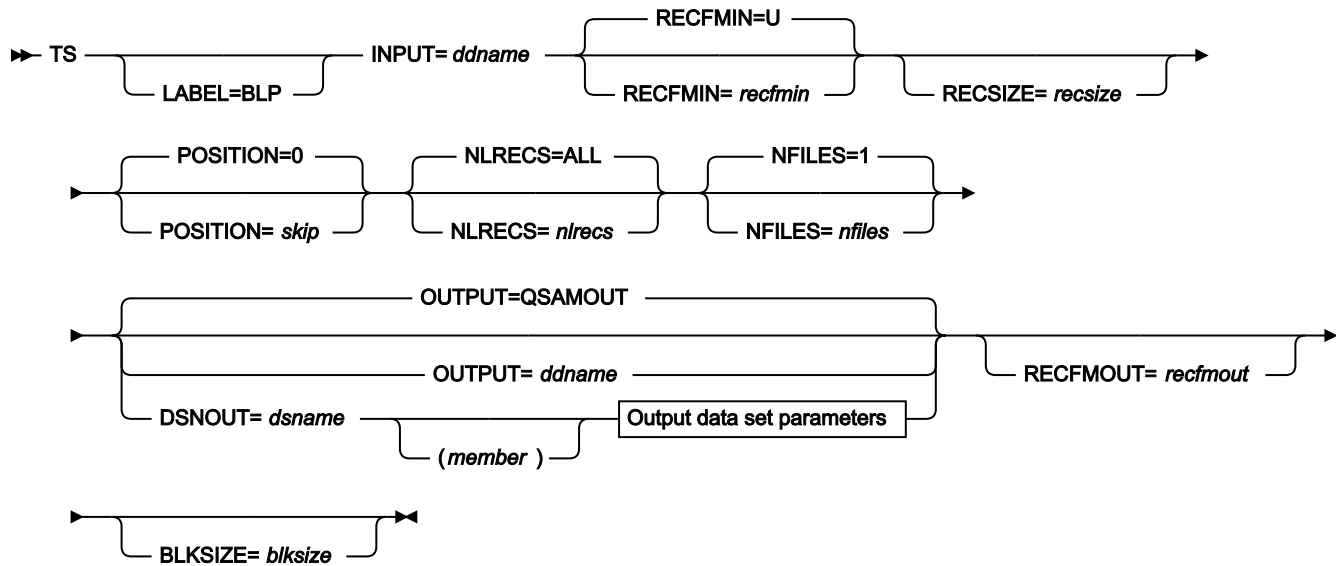

Output data set parameters

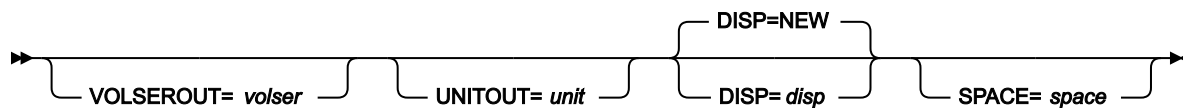

blksize

The maximum length of an output block in bytes. Specify it to change the block size of an old data set, or to override any system default for a new data set.

ddname

Refers to a DD or TSO ALLOC statement. The default is QSAMOUT for output.

disp

Disposition of the output data set. Specify OLD, MOD, NEW, or CAT for NEW,CATLG. The default is NEW.



Note: SMS might modify the allocation of new data sets on your system. For details, contact your SMS Administrator.

dsname

Defines the name of the data set. If any DD statements are specified, they are not used. The name may include a member name in parenthesis. If the member is specified here, the associated Member parameter must be empty. To further describe the data set, use the appropriate keywords as shown in the syntax diagram.

LABEL=BLP

Specifies that bypass label processing is used. This parameter must be specified with the first File Manager function that uses the tape. For BLP processing requirements, see "Customizing the Security Environment" in the *File Manager for z/OS Customization Guide*.

member

For a PDS, the member name.

nfiles

Number of tape files to be copied. The maximum is 99 999; the default is 1.

EOV

Copies files until a double tape mark or an EOV label is reached.

EOD

Copies files until the delimiter specified in the EOD parameter of the SET function is reached.

Use this parameter to copy a multfile tape, including tape marks, to a single sequential data set. (You can use the ST function to copy the data set back to tape, including the tape marks.) For more information, see [Copying tape data across a network on page 463](#).

nlrecs

Number of records to be copied or ALL. The maximum number is 99 999 999. If you specify ALL or omit the parameter, all the remaining records are copied.

recfmin

Record format for the input. Each value is a combination of the following letters:

B

Blocked

D

Variable-length ISO/ANSI tape records

F

Fixed length

S

Spanned format

U

Undefined length

V

Variable length

The possible values are: U, F, FB, V, VB, VBS, VS, D, DB, DBS, and DS.

recfmout

Record format for the output. Each value is a combination of the following letters:

A

Containing ISO/ANSI control characters

B

Blocked

D

Variable-length ISO/ANSI tape records

F

Fixed length

M

Containing machine code control characters

S

Standard format (fixed length) or spanned format (variable length)

U

Undefined length

V

Variable length

The possible values are: U, UA, UM, F, FA, FM, FB, FBA, FBM, FBS, FBSA, FBSM, V, VA, VM, VB, VBA, VBM, VS, VSA, VSM, VBS, VBSA, VBSM, D, DA, DB, DBA, DS, DSA, DBS, and DBSA.

Use *recfmout* to override existing DCB information. You cannot create a PDS with a record format of FBS. If output data sets with a record format containing the letter D are written to disk, unpredictable results might occur.

resize

Length of the input records, if *recfmin* is F or FB. If *recfmin* is F, the length of the first record is used by default. If *recfmin* is FB, *resize* is required.

skip

Number of logical records to be skipped. The default is 0.

space

The number of space units to be allocated for a new data set. Specify *n* or (*n,m*), where *n* is the number of primary units, and *m* is the number of secondary units. The space unit is a track.

tapevol

Serial number (external label or VOL1) of the tape volume to be mounted.

unit

A device number. A 3 hexadecimal digit device number, a 4 hexadecimal digit device number prefixed by a slash (/), a device type, or an installation-defined group name.

volser

Volume serial number for a new or non-cataloged data set.

```
//TS JOB (acct),'name' Create Tape Image File
//*
//FMBAT PROC
//FMBAT EXEC PGM=FILEMGR
//STEPLIB DD DSN=FMN.SFMNMOD1,DISP=SHR
//SYSPRINT DD SYSOUT=*
//SYSABEND DD SYSOUT=*
//SYSUDUMP DD SYSOUT=*
// PEND
//*
//FILEMGR EXEC FMBAT
//SYSPRINT DD SYSOUT=*
//TAPE DD UNIT=(561,,DEFER),VOL=SER=FM0001,
// DISP=SHR,LABEL=(,BLP)
//XMIT DD DSN=FMNUSER.TAPE.XMIT.WORK,
// DISP=(,CATLG),
// UNIT=SYSALLDA,
// SPACE=(CYL,(1,1),RLSE),
// VOL=SER=MVS1T3
//SYSIN DD *
$$FILEM TS INPUT=TAPE,LABEL=BLP,
$$FILEM OUTPUT=XMIT,NFILES=EOV
$$FILEM EOV
/*
```

TT (Tape to Tape)

Purpose

Copy tape data from one tape to another.

Usage notes

Use this function to copy tape files from one tape to another for an exact copy. No label processing is involved. Label sets are copied as files.

For each tape file copied, block count statistics are printed or displayed. Records are always copied as physical blocks, regardless of whether they are labels or ordinary data. Any leading tape mark is copied.

Specify a DDNAME for the tape.

Unless you have strong reasons for not doing so, use bypass label processing (BLP) with this function.

For further information on tape copy functions, see [Tape to Tape \(option 4.2.1\) on page 459](#).

Options

You can specify the number of tape files to be copied, or take the default of one. Copying starts at the current position and stops after the specified number of files.

Related functions

DSC

Copy a data set to another one

TLT

Copy multivolume, multiple-file labeled tapes

TTC

Compare two tapes byte by byte

TTR

Copy a file from one tape to another with reblocking

Figure 473. Syntax



ddname

Refers to a DD or TSO ALLOC statement.

LABEL=BLP

Specifies that bypass label processing is used. This parameter must be specified with the first File Manager function that uses the tape. For BLP processing requirements, see “Customizing the Security Environment” in the *File Manager for z/OS Customization Guide*.

mm

A 2-byte tape mode as shown in [Tape density and mode values on page 449](#).

nfiles

Number of tape files to be copied. The maximum is 99 999; the default is 1.

EOV

Copies files until a double tape mark or an EOV label is reached.

EOT

Copies files until the physical end of the volume

EOD

Copies files until the delimiter specified in the EOD parameter of the SET function is reached.

The records from the current tape position up to and including the next tape mark make up one file. However, if the tape is positioned immediately before a tape mark, the file is considered to end at the next tape mark.

```
//TT JOB (acct),'name' Tape to Tape Copy
//FILEMGR EXEC PGM=FILEMGR
//SYSPRINT DD SYSOUT=*
//TAPE1 DD UNIT=381,VOL=SER=FM01,
// DISP=OLD,LABEL=(,BLP)
//TAPE2 DD UNIT=382,VOL=SER=FM02,
// DISP=OLD,LABEL=(,BLP)
//SYSIN DD *
$$$FILEM TT INPUT=TAPE1,OUTPUT=TAPE2,
$$$FILEM NFILES=EOV
$$$FILEM EOJ
/*
```

TTC (Tape to Tape Compare)

Purpose

Compares two tapes byte by byte.

Usage notes

Use this function to compare, byte by byte, the data on one tape with the data on another. This function is particularly useful if you have made a copy of a tape, and you want to check that the duplicate is exactly the same as the original. Comparison starts at the current tape position of each tape. When the first difference is found, comparison stops and the comparison results are printed.

Specify a DDNAME for the tape.

Options

You can compare the entire tape, or a specific number of files.

Related functions

TLT

Copy multivolume, multiple-file labeled tapes

TT

Copy files from one tape to another without label processing

TTC

Compare two tapes byte by byte

TTR

Copy a file from one tape to another with reblocking

Figure 474. Syntax

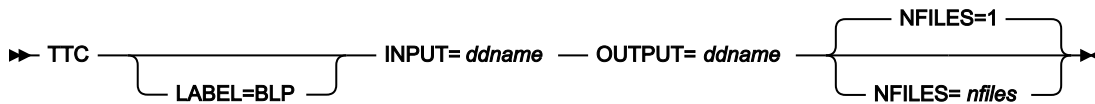
**ddname**

Refers to a DD or TSO ALLOC statement.

LABEL=BLP

Specifies that bypass label processing is used. This parameter must be specified with the first File Manager function that uses the tape. For BLP processing requirements, see “Customizing the Security Environment” in the *File Manager for z/OS Customization Guide*.

nfiles

Number of tape files to be compared. The maximum is 99 999; the default is 1.

EOV

Compares files until a double tape mark or an EOVS label is reached.

EOD

Compares files until the delimiter specified in the EOD parameter of the SET function is reached.

```
//TTC JOB (acct),'name' Tape to Tape Compare
//FILEMGR EXEC PGM=FILEMGR
//SYSPRINT DD SYSOUT=*
//TAPE1 DD UNIT=381,VOL=SER=FM01,
// DISP=OLD,LABEL=(,BLP)
//TAPE2 DD UNIT=382,VOL=SER=FM02,
// DISP=OLD,LABEL=(,BLP)
//SYSIN DD *
$$FILEM TTC INPUT=TAPE1,OUTPUT=TAPE2,
$$FILEM NFILES=EOV
$$FILEM EOV
/*
```

TTR (Tape to Tape Reblocked)

Purpose

Copy one file from tape to tape with reblocking.

Usage notes

Use this function to copy one tape file, starting from the current tape position, to one or more output tapes. You can change the record format and reblock the file during copying. Any leading tape mark is copied. No label processing is done. Any label sets on input are copied as files.

Specify a DDNAME for the tape.

Unless you have strong reasons for not doing so, use bypass label processing (BLP) with this function.

For further information about tape copy functions, see [Tape to Tape \(option 4.2.1\) on page 459](#).

Options

You can specify the input and output record format, the input record size and the output block size.

Related functions

DSC

Copy a data set to another one

TLT

Copy multivolume, multiple-file labeled tapes

TT

Copy files from one tape to another without label processing

TTC

Compare two tapes byte by byte

Figure 475. Syntax

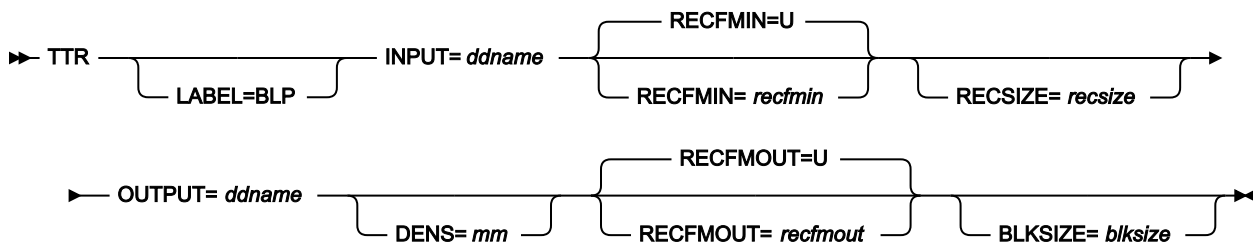

blksize

If *recfmout* contains F, the actual block size; otherwise, the maximum block size. If *recfmout* contains B or S, *blksize* is required; otherwise, it is optional. The maximum is 65 535 (for V), 9 999 (for D), or 9 999 999 (otherwise). If the tape is processed by other utilities or standard access methods, you must also consider the operating system limits.

ddname

Refers to a DD or TSO ALLOC statement.

LABEL=BLP

Specifies that bypass label processing is used. This parameter must be specified with the first File Manager function that uses the tape. For BLP processing requirements, see "Customizing the Security Environment" in the *File Manager for z/OS Customization Guide*.

mm

A 2-byte tape mode as shown in [Tape density and mode values on page 449](#).

recfmin

Record format for the input. Each value is a combination of the following letters:

B

Blocked

D

Variable-length ISO/ANSI tape records

F

Fixed length

S

Spanned format

U

Undefined length

V

Variable length

The possible values are: U, F, FB, V, VB, VBS, VS, D, DB, DBS, and DS.

recfmout

Record format for the output. Each value is a combination of the following letters:

B

Blocked

D

Variable-length ISO/ANSI tape records

F

Fixed length

S

Spanned format

U

Undefined length

V

Variable length

The possible values are: U, F, FB, V, VB, VBS, VS, D, DB, DBS, and DS.

resize

Length of the input records, if *recfmin* is F or FB. If *recfmin* is F, the length of the first record is used by default. If *recfmin* is FB, *resize* is required.

```
//TTR JOB (acct),'name' Tape to Tape Reblocked
//FILEMGR EXEC PGM=FILEMGR
```

```
//SYSPRINT DD SYSOUT=*
//TAPE1 DD UNIT=381,VOL=SER=FM01,
// DISP=OLD,LABEL=(,BLP)
//TAPE2 DD UNIT=382,VOL=SER=FM02,
// DISP=OLD,LABEL=(,BLP)
//SYSIN DD *
$$FILEM TTR INPUT=TAPE1,RECFMIN=VB,
$$FILEM OUTPUT=TAPE2,RECFMOUT=U
$$FILEM E0J
/*
```

TV (Tape to VSAM)

Purpose

Copy tape records to a VSAM data set.

Usage notes

Use this function to copy all or selected tape records to a VSAM data set. You can also use this function to convert a multiple file tape into a single VSAM ESDS (tape image file), which can be distributed across a network. For more information, see [Copying tape data across a network on page 463](#).

Specify a number of files other than one, but no tape file ID or start position. File Manager converts tape marks into special records containing "FILEMTMFILEMTM...". When restoring the file to tape using the VT (VSAM to Tape) function, File Manager converts the special records back into tape marks. The resulting tape is an exact copy of the original tape.

Specify a DDNAME for the tape.

Options

You can specify the record format and the record length of the input data, and the position of the first record to copy. You can also specify the number of records to be copied, and whether any existing records in the output data set are to be replaced.

Related functions

DSC

Copy a data set to another one

TS

Copy tape data to a data set

VT

Copy a VSAM data set to tape

Figure 476. Syntax

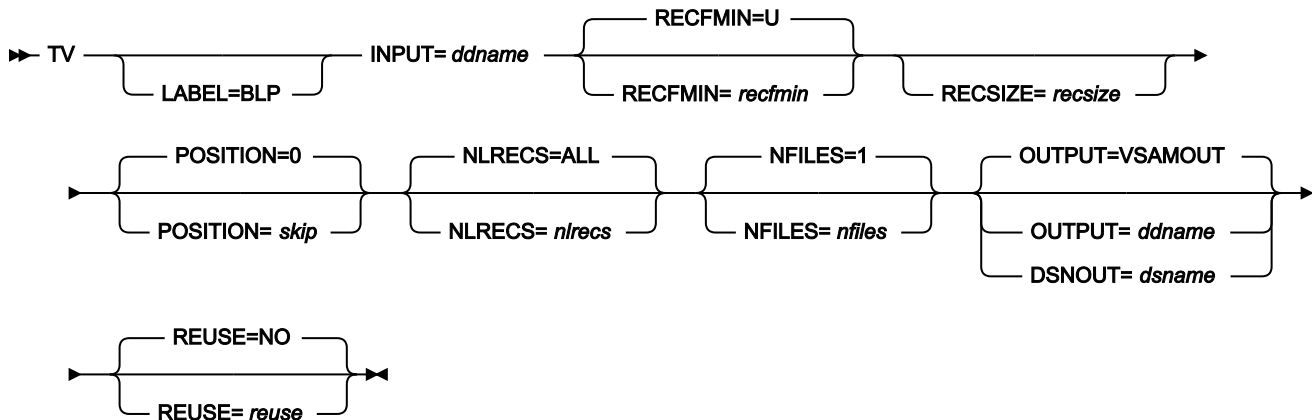
**ddname**

Refers to a DD or TSO ALLOC statement. The default is VSAMOUT for output.

dsname

Name of a VSAM data set.

LABEL=BLP

Specifies that bypass label processing is used. This parameter must be specified with the first File Manager function that uses the tape. For BLP processing requirements, see “Customizing the Security Environment” in the *File Manager for z/OS Customization Guide*.

nfiles

Number of tape files to be copied. The maximum is 99 999; the default is 1.

EOV

Copies files until a double tape mark or an EOV label is reached.

EOD

Copies files until the delimiter specified in the EOD parameter of the SET function is reached.

Use this parameter to copy a multifile tape, including tape marks, to a single VSAM entry-sequenced data set. (You can use the VT function to copy the VSAM file back to tape, including the tape marks.) For more information, see [Copying tape data across a network on page 463](#).

nlrecs

Number of records to be copied or ALL. The maximum number is 99 999 999. If you specify ALL or omit the parameter, all the remaining records are copied.

recfmin

Record format for the input. Each value is a combination of the following letters:

B

Blocked

D

Variable-length ISO/ANSI tape records

F

Fixed length

S

Spanned format

U

Undefined length

V

Variable length

The possible values are: U, F, FB, V, VB, VBS, VS, D, DB, DBS, and DS.

recsize

Length of the input records, if *recfmin* is F or FB. If *recfmin* is F, the length of the first record is used by default. If *recfmin* is FB, *recsize* is required.

reuse

Specify YES to replace any existing records in the output data set (if it is defined with the REUSE parameter in the catalog). Specify NO to add new records without deleting the old records. The default is NO.

skip

Number of logical records to be skipped. The default is 0.

```

/* REXX */
/* copy a tape file to a vsam data set      */
/* allocate input tape                      */
/* use SL processing.  required file is at  */
/* position 1                               */

"ALLOC FILE(TAPE) DA('FMNUSER.TAPEIN'),
      VOLUME(FM0001) UNIT(CART) LABEL(SL)",
      POSITION(1) OLD"

/* copy a tape file to a vsam data set      */

"FILEMGR $TV INPUT=TAPE,",
      DSNOUT=VSAM.DISK.VT55.DATA"

/* free the tape unit                      */

"FREE FILE(TAPE)"

return

```

TX (Tape to REXX Variable) -- REXX only

Purpose

Copy tape records into a REXX stem variable.

Usage notes

Each record is copied to a variable named *stem.nnn*. *stem.0* is a counter.

For example, if you copy 3 records, *stem* is VARXX. and VARXX.0 has the value 5:

- The records are copied to VARXX.6, VARXX.7, and VARXX.8.
- The value of VARXX.0 is changed to 8.

This function is available only from a REXX procedure.

Related functions

TS

Copy tape data to a data set

XT

Copy a REXX stem variable to a tape file

Figure 477. Syntax

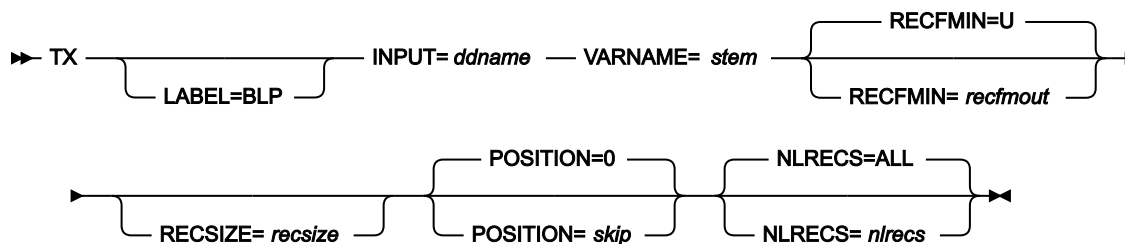

ddname

Refers to a DD or TSO ALLOC statement.

LABEL=BLP

Specifies that bypass label processing is used. This parameter must be specified with the first File Manager function that uses the tape. For BLP processing requirements, see "Customizing the Security Environment" in the *File Manager for z/OS Customization Guide*.

nlrecs

Number of records to be copied or ALL. The maximum number is 99 999 999. If you specify ALL or omit the parameter, all the remaining records are copied.

recfmin

Record format for the input. Each value is a combination of the following letters:

B

Blocked

D

Variable-length ISO/ANSI tape records

F

Fixed length

S

Spanned format

U

Undefined length

V

Variable length

The possible values are: U, F, FB, V, VB, VBS, VS, D, DB, DBS, and DS.

recsize

Length of the input records, if *recfmin* is F or FB. If *recfmin* is F, the length of the first record is used by default. If *recfmin* is FB, *recsize* is required.

skip

Number of logical records to be skipped. The default is 0.

stem

A REXX stem variable name. The maximum length is 44 characters.

```

/* REXX */
/* copy a tape file to a rexx stem      */
/* allocate input tape                  */
/* use SL processing.  required file is at */
/* position 1                            */

"ALLOC FILE(TAPE) DA('FMUSER.TAPEIN'),
  "VOLUME(FM0001) UNIT(CART) LABEL(SL)",
  "POSITION(1) OLD"

/* copy a tape file to a rexx stem      */

"FILEMGR $TX INPUT=TAPE,",
  "VARNAME=TAPE."

/* Show stem contents                    */

Do i=1 To tape.0
  Say tape.i      /* show tape record */
End

```

```
/* free the tape unit          */  
  
"FREE FILE(TAPE)"  
  
return
```

VER (Display Service Level)

Purpose

Display the current level of File Manager you are using.

Usage notes

The VER function also displays the latest PTF applied.

Options

None.

No parameters.

VLM (View Load Module)

Purpose

List symbols in a load module.

Usage notes

Use this function to print a list of the symbols (CSECTs, common sections, entry points, and ZAPs) in a load module.

Options

The list can be sorted by symbol address (offset within module) or symbol name.

Related functions

None.

Figure 478. Syntax

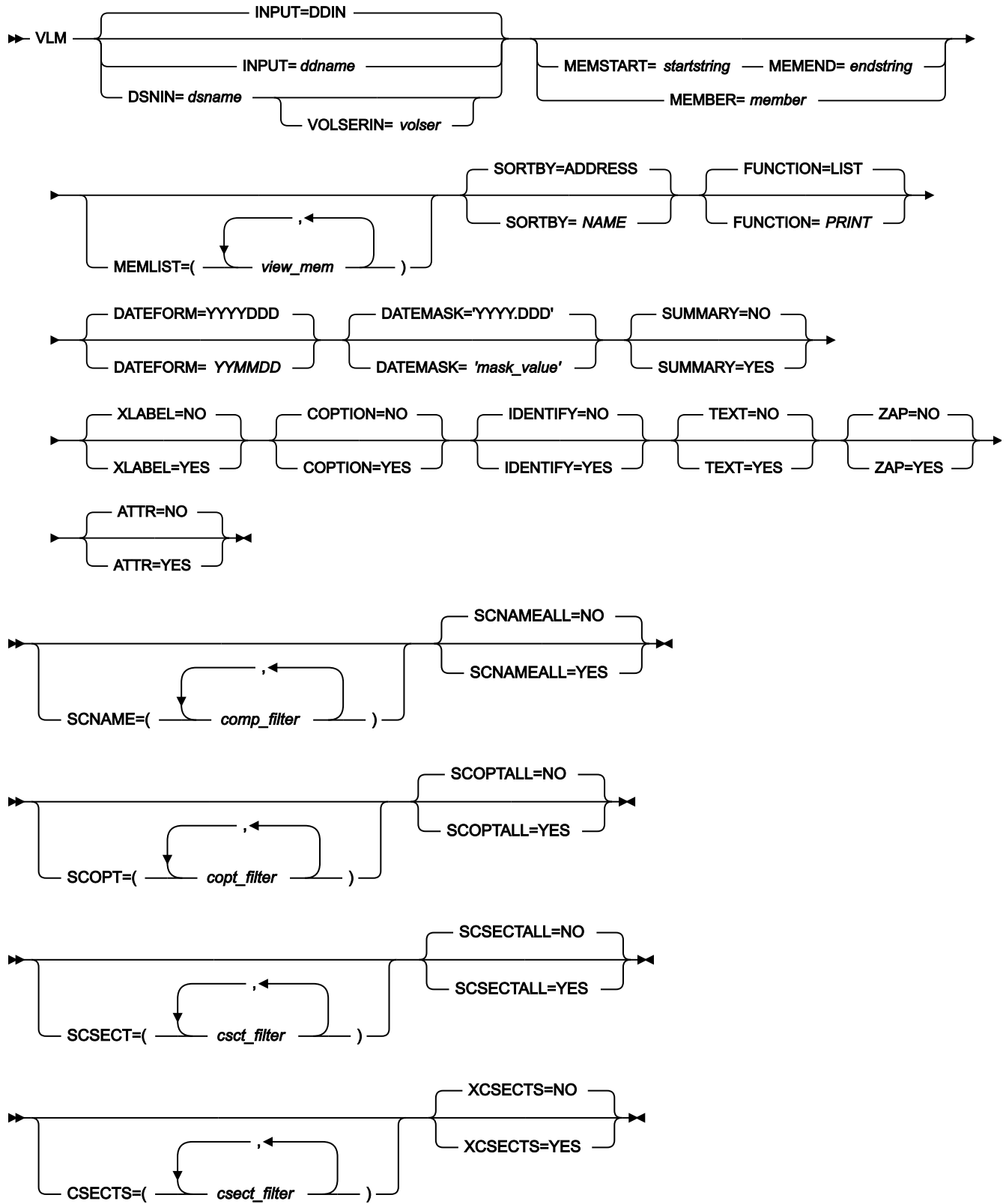

INPUT=ddname

Refers to a DD or TSO ALLOC statement. The default is DDIN for input, and DDOUT for output.

DSNIN=dsname

Defines the name of the input data set. If any DD statements are specified, they are not used. The name may include a member name or pattern in parenthesis. If the member is specified here, the associated Member parameter must be empty. To further describe the data set, use the appropriate keywords as shown in the syntax diagram. You can further describe this data set using:

VOLSER=volser

Volume serial number for a non-cataloged data set.

MEMBER=member

The name of a single member or pattern in a PDS load module.

MEMSTART=startstring

Is used to specify the start of a range of member names to be included in the processing. If MEMSTART is specified but MEMEND is omitted, all members of the PDS(E) from the *startstring* value onwards are included. *startstring* can have the same values, including wild cards, as for the *member* parameter of the MEMBER keyword.

MEMEND=endstring

Is used to specify the end of a range of member names to be included in the processing. If MEMEND is specified but MEMSTART is omitted, all members of the PDS(E) up to the *endstring* value onwards are included. *endstring* can have the same values, including wild cards, as for the *memold* parameter of the MEMOLD keyword.

MEMLIST

Provides a means of selecting members from a load library where no generic name pattern and no member name range has been specified. If the MEMLIST keyword is specified, only those members included in the MEMLIST arguments are processed. Members selected by the MEMBER=*member* that are not included in the MEMLIST arguments are not processed.

view_mem

The name of the member to be processed. Generic name masks are not allowed.

FUNCTION

The command that you want to execute:

LIST

Display the list (the default)

PRINT

Print the list



Note: The FUNCTION parameter is ignored in batch mode.

SORTBY

Sorts the list or print output by one of the following:

ADDRESS

Sort by the address of the symbol

NAME

Sort by the name of the symbol

DATEFORM

Specifies Gregorian or Julian format of dates:

YYYYDDD

Dates shown in the YYYY.DDD format

YYMMDD

Dates shown in YY/MM/DD format

DATEMASK=*mask_value*

Where the mask value is specified as a string (maximum 19 bytes) that contains picture characters that are supported by the Language Environment® date callable services. If the mask contains blanks, enclose it in quotation marks. All dates in the report follow this format.

Example mask	Result
YY/MM/DD	16/04/20
MM/DD/YYYY	04/20/2022
DD/MM/YYYY	20/04/2022
'Www Mmm DD, YYYY'	Wed Apr 20, 2022



Note: If specified, DATEMASK takes precedence over DATEFORM. Use DATEMASK because DATEFORM only remains for compatibility with old JCL.

SUMMARY=NO

CSECT information is not suppressed.

SUMMARY=YES

CSECT information is suppressed.

XLABEL=NO

Section labels (type LD) are included in the report.

XLABEL=YES

Section labels (type LD) are excluded from the report.

COPTION=NO

Compile options are not shown in the report.

COPTION=YES

Compile options are shown in the report if they can be determined.

IDENTIFY=NO

User data from the `IDENTIFY` statement is not shown in the report.

IDENTIFY=YES

User data from the `IDENTIFY` statement is shown in the report.

TEXT=NO

Text data is not produced.

TEXT=YES

Text data is produced in dump format for each control section in the report.

ZAP=NO

ZAP data is not shown in the report.

ZAP=YES

ZAP data is shown in the report.

ATTR=NO

Programming language attributes for a CSECT are not shown in the report.

ATTR=YES

Programming language attributes for a CSECT, if available, are shown in the report.

SCNAME

Provides a way to include for processing load modules containing CSECTs that were created with selected compilers.

comp_filter

Specifies strings that will be used to find matching names or product IDs (PIDs) of the compilers used to create CSECTs in the load module.

To specify a filter containing lowercase characters, use a character string in the format `c'string'`. Filters can also be specified as hexadecimal strings in the format `x'hex-digits'`.

When multiple search strings are specified, by default any string that is found in a compiler name or PID is treated as a match for the load module. If you need all of the search strings to be found to constitute a match, specify YES for the SCNAMEALL option.

If other search arguments are specified with the SCOPT or SCSECT options, these must also be found in the load module to have it included in the report.

SCNAMEALL

Specifies whether all of the compiler name search strings provided in SCNAME must be found in a load module to constitute a match.

NO

If any of the compiler name search strings is found in a load module it is deemed a match.

YES

All of the compiler name search strings must be found in a load module to constitute a match.

SCOPT

Provides a way to include for processing load modules containing CSECTs that were created with selected compiler options.

copt_filter

Specifies strings that will be used to search for a match in the set of compiler options used to create CSECTs in the load module.

To specify a filter containing lowercase characters, use a character string in the format `c'string'`. Filters can also be specified as hexadecimal strings in the format `x'hex-digits'`.

When multiple search strings are specified, by default any of those strings found in the set of compiler options is treated as a match for the load module. If you need all of the search strings to be found to constitute a match, specify YES for the SCOPTALL option.

If other search arguments are specified with the SCNAME or SCSECT options, these must also be found in the load module to have it included in the report.

SCOPTALL

Specifies whether all of the compiler option search strings provided in SCOPT must be found in a load module to constitute a match.

NO

If any of the compiler option search strings is found in a load module it is deemed a match.

YES

All of the compiler option search strings must be found in a load module to constitute a match.

SCSECT

Provides a way to include for processing load modules containing CSECTs with selected names.

csct_filter

Specifies strings that will be used to search for a match in the names of the CSECTs in the load module. Strings can contain the * and % wildcard characters.

To specify a filter containing lowercase characters, use a character string in the format `c'string'`. Filters can also be specified as hexadecimal strings in the format `x'hex-digits'`.

When multiple search strings are specified, by default any of those strings found in the CSECT names is treated as a match for the load module. If you need all of the search strings to be found to constitute a match, specify YES for the SCSECTALL option.

If other search arguments are specified with the SCNAME or SCOPT options, these must also be found in the load module to have it included in the report.

SCSECTALL

Specifies whether all of the CSECT name search strings provided in SCSECT must be found in a load module to constitute a match.

NO

If any of the CSECT name search strings is found in a load module it is deemed a match.

YES

All of the CSECT name search strings must be found in a load module to constitute a match.

CSECTS

Provides a way to exclude or include CSECTs from the report. The XCSECTS option identifies whether the filters are used to exclude or include CSECTS.

csect_filter

A CSECT name filter identifying one or more CSECTs to be either included or excluded from the report. The wildcard characters * and % can be used to define a CSECT name pattern representing multiple CSECTS.

XCSECTS=NO

Use the CSECTS option to identify CSECTS to be *included* in the report.

XCSECTS=YES

Use the CSECTS option to identify CSECTS to be *excluded* from the report.

```
//VLM JOB (acct),'name' View Load Module
//*
//FMBAT PROC
//FMBAT EXEC PGM=FMNMAIN
//STEPLIB DD DSN=FMNUSER.FMN310.TSTLOAD,DISP=SHR
```

```

//SYSPRINT DD SYSOUT=*
//SYSABEND DD SYSOUT=*
//SYSUDUMP DD SYSOUT=*
//          PEND
//*
//FMNMAIN EXEC FMBAT
//DDIN     DD DSN=FMNUSER.FMN310.TSTLOAD,DISP=SHR
//SYSPRINT DD SYSOUT=*
//SYSIN    DD *
$$$FILEM VLM MEMBER=FMNMAIN
$$$FILEM E0J
/*

```

VO (VSAM to Object)

Purpose

Copy data from a VSAM data set to one or more OAM objects.

Usage notes

Use this function to copy data from a VSAM data set to an object database. If the input is a backup data set created with the OV (Object to VSAM) function, the object header records are used for restoring.

If loading from an object backup data set the objects are restored with the original name into the original collection. To filter loading, specify a collection name, a generic object name, the location (DASD or OPTICAL, or a specific optical volume), and a creation date range. The filter applies to the object header information saved with the objects.

If the input does not contain backup copies of multiple objects, one object is created. You can specify a collection name and an object name. If the input data begins with an object header record, the default values are taken from it. The object is made up of the concatenated input records, excluding any object header.

For more information about using this function, see [Restoring OAM objects on page 495](#).

Options

You can specify SMS storage class and management class values to be used for storing the object; these might, however, be overridden by your installation defaults. You can also specify whether an existing object with matching name is to be replaced in the output collection.

Related functions

OO

Copy an object to the same or another collection

OV

Backup objects from an OAM database to a VSAM data set

SO

Copy a data set to an object database

Figure 479. Syntax

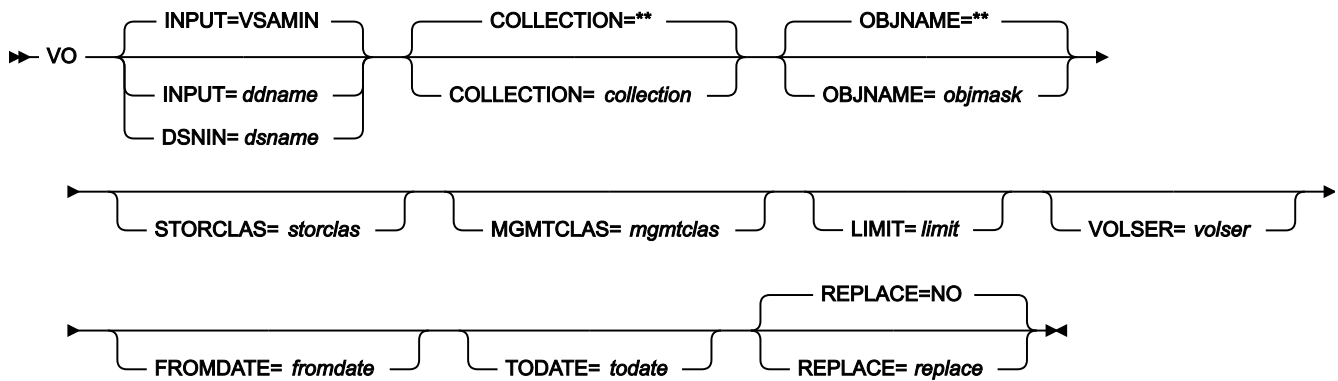
**collection**

If the data set contains one object with a header, you can optionally specify a collection name to override the collection name in the header.

If the data set contains one object with no header (or, equivalently, it contains data that was not previously an object), you must specify the collection where the object is stored.

If the data set contains one or more objects that were stored during a multiple-object backup, you can optionally specify a collection name to restore only objects from the specified collection.

In any mode except batch mode, the user's TSO prefix (normally the user ID) is used as the high-level qualifier for any name that is not entered in quotation marks.

ddname

Refers to a DD or TSO ALLOC statement. The default is VSAMIN.

dsname

Name of a VSAM data set.

fromdate

The earliest creation date, in the form *yyyymmdd*. By default, all objects are copied regardless of their creation date.

limit

To limit the objects that are copied based on where the objects were located (before they were backed up to a data set), specify one of the following:

DASD

Only objects that were stored on DASD

OPTICAL

Only objects that were stored on optical disks

VOLUME

Only objects that were stored on a specified optical disk. You must also specify the volser of the optical disk.

mgmtclas

Name of an SMS management class.

objmask

If the data set contains one object with a header, you can optionally specify an object name to override the object name in the header.

If the data set contains one object with no header (or, equivalently, it contains data that was not previously an object), you must specify a name for the object.

If the data set contains one or more objects that were stored during a multiple-object backup, you can optionally specify an object name or generic object name to limit the objects that are restored based on object name. Within the name, you can include a percent sign (%) to represent exactly one character, an asterisk (*) to represent any number of characters (or no characters) within a qualifier, or two asterisks (**) to represent any number of characters (or no characters) with any number of qualifiers.

In any mode except batch mode, the user's TSO prefix (normally the user ID) is used as the high-level qualifier for any name that is not entered in quotation marks.

replace

Specify YES to replace any existing objects with the same name in the collection. By default, the object is not copied.

storclas

Name of an SMS storage class.

todate

The latest creation date, in the form *yyyymmdd*.

volser

If you specified VOLUME for *limit*, the volume serial number of the optical disk.

VT (VSAM to Tape)

Purpose

Copy VSAM records to a tape file.

Usage notes

If you used the TV (Tape to VSAM) function to copy a multiframe tape to a single VSAM ESDS (tape image file), you can use VT to copy the file back to tape. File Manager converts the special records back into tape marks. The resulting tape is an exact copy of the original tape.

Specify a DDNAME for the tape.

Options

You can specify the number of records to skip from the beginning of the input data set, or the key or slot value to start processing. You can also specify the output record format and block size.

Related functions

DSC

Copy a data set to another one

TV

Copy tape data to a VSAM data set

VO

Copy VSAM data to an object database

Figure 480. Syntax

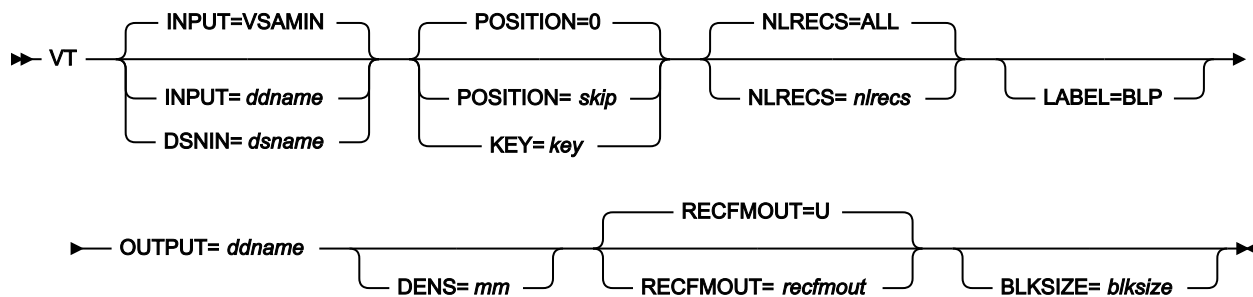

blksize

If *recfmout* contains F, the actual block size; otherwise, the maximum block size. If *recfmout* contains B or S, *blksize* is required; otherwise, it is optional. The maximum is 65 535 (for V), 9 999 (for D), or 9 999 999 (otherwise). If the tape is processed by other utilities or standard access methods, you must also consider the operating system limits.

ddname

Refers to a DD or TSO ALLOC statement. The default is VSAMIN for input. To create the output tape file with standard labels, specify AL or SL processing on the DD or TSO ALLOC statement.

dsname

Name of a VSAM data set.

key

A key for KSDS records, or a slot number for RRDS records. The maximum key length is 30 characters. The first record with a key or slot value greater than or equal to *key* is the first record copied. If you omit the *key* and *skip* values, copying begins with the first record in the data set.

If the key contains lowercase characters, blanks, or commas, enclose it in quotation marks. You can also specify a key in hexadecimal format (for example, X'C1C2C3').

LABEL=BLP

Specifies that bypass label processing is used. This parameter must be specified with the first File Manager function that uses the tape. For BLP processing requirements, see "Customizing the Security Environment" in the *File Manager for z/OS® Customization Guide*.

mm

A 2-byte tape mode as shown in [Tape density and mode values on page 449](#).

nlrecs

Number of records to be copied or ALL. The maximum number is 99 999 999. If you specify ALL or omit the parameter, all the remaining records are copied.

recfmout

Record format for the output. Each value is a combination of the following letters:

B

Blocked

D

Variable-length ISO/ANSI tape records

F

Fixed length

S

Spanned format

U

Undefined length

V

Variable length

The possible values are: U, F, FB, V, VB, VBS, VS, D, DB, DBS, and DS.

skip

Number of logical records to be skipped from the beginning of the data set. If you omit the *skip* and *key* values, copying begins with the first record in the data set.

```
//VT JOB (acct), 'name' VSAM to TAPE
//FMBAT PROC
//FMBAT EXEC PGM=FILEMGR
//STEPLIB DD DSN=FMN.SFMNMOD1, DISP=SHR
//SYSPRINT DD SYSOUT=*
//SYSABEND DD SYSOUT=*
//SYSUDUMP DD SYSOUT=*
```

```

//          PEND
//*
//IDCPROC  PROC
//IDCAMS   EXEC PGM=IDCAMS
//SYSPRINT DD SYSOUT=*
//SYSABEND DD SYSOUT=*
//SYSUDUMP DD SYSOUT=*
//          PEND
//*
//CREATE   EXEC IDCPROC,REGION=6M
//SYSIN    DD *
DELETE FMNUSER.VSAM.VT55 CLUSTER PURGE ERASE
DEFINE CLUSTER ( -
    NAME( FMNUSER.VSAM.VT55 ) -
    CISZ(4096) -
    FREESPACE(30 30) -
    NONINDEXED -
    KEYS(12 0) -
    RECORDS(1000 100) -
    RECORDSIZE(133 133) -
    REUSE -
    VOL(MVS1W2) ) -
DATA( NAME(FMNUSER.VSAM.VT55.DATA) )
/*
/*
//STP1005  EXEC FMBAT
//VSAMIN   DD DISP=SHR,DSN=FMNUSER.VSAM.VT55
//TAPE     DD UNIT=CART,
//          VOL=(,RETAIN,,SER=FM0001),
//          LABEL=(1,SL),DISP=(,KEEP),
//          DSN=FMNUSER.TAPEOUT
//SYSIN    DD *
$$$FILEM VER
*          GENERATE SOME DATA AND PLACE
*          IN A VSAM FILE
$$$FILEM DSG OUTPUT=VSAMIN,REUSE=NO,NLRECS=4000,
$$$FILEM RECSIZE=133,FILLCHAR=BIN,KEYLOC=1
*          NOW COPY THE VSAM FILE TO TAPE
$$$FILEM VT INPUT=VSAMIN,OUTPUT=TAPE
$$$FILEM EOJ
/*

```

VX (VSAM to REXX Variable) -- REXX only

Purpose

Copy records from a VSAM data set into a REXX stem variable.

Usage notes

Each record is copied to a variable named *stem.nnn*. *stem.0* is a counter.

For example, if you copy 3 records, *stem* is VARXX. and VARXX.0 has the value 5:

- The records are copied to VARXX.6, VARXX.7, and VARXX.8.
- The value of VARXX.0 is reset to 8.

This function is available only from a REXX procedure.

Related function

XV

Copy a REXX stem variable to a VSAM data set

Figure 481. Syntax

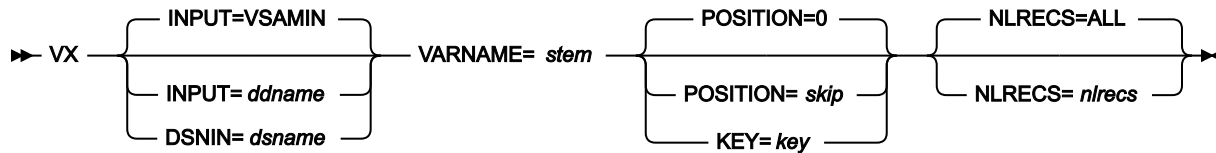

ddname

Refers to a DD or TSO ALLOC statement. The default is VSAMIN.

dsname

Name of a VSAM data set.

key

A key for KSDS records, or a slot number for RRDS records. The maximum key length is 30 characters. The first record with a key or slot value greater than or equal to *key* is the first record copied. If you omit the *key* and *skip* values, copying begins with the first record in the data set.

If the key contains lowercase characters, blanks, or commas, enclose it in quotation marks. You can also specify a key in hexadecimal format (for example, X'C1C2C3').

nlrecs

Number of records to be copied or ALL. The maximum number is 99 999 999. If you specify ALL or omit the parameter, all the remaining records are copied.

skip

Number of logical records to be skipped from the beginning of the data set. If you omit the *skip* and *key* values, copying begins with the first record in the data set.

stem

A REXX stem variable name. The maximum length is 44 characters.

```

/* REXX */
/* Copy a VSAM data set to a REXX stem      */
/* Change input.vsam.file to the name      */
/* of the required VSAM file                */

FILEMGR $VX DSNIN='input.vsam.file',",
          "VARNAME=STEM."

/* Show stem contents                        */

do i = 1 to stem.0;

```



```

say 'Record' i '=' stem.i;
end;

return;

```

WTM (Write Tape Mark)

Purpose

Write one or more tape marks.

Usage notes

Tape marks are special records on tape. Data between two tape marks make up a tape file. Two consecutive tape marks are considered a null file or indicate the end of data on a tape volume (if after an end-of-file or an end-of-volume label, or on a NL tape).

Specify a DDNAME for the tape.

Options

None.

Related function

INT

Initialize a tape

Figure 482. Syntax

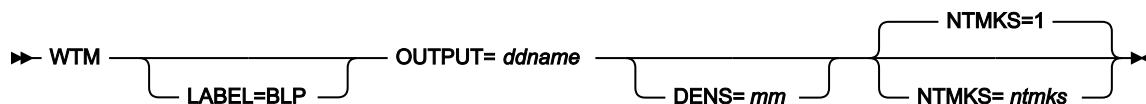

ddname

Refers to a DD or TSO ALLOC statement.

LABEL=BLP

Specifies that bypass label processing is used. This parameter must be specified with the first File Manager function that uses the tape. For BLP processing requirements, see "Customizing the Security Environment" in the *File Manager for z/OS Customization Guide*.

mm

A 2-byte tape mode as shown in [Tape density and mode values on page 449](#).

ntmks

Number of tape marks to be written. The maximum is 9 999; the default is 1.

XT (REXX Variable to Tape) -- REXX only

Purpose

Copy a REXX stem variable to a tape file.

Usage notes

Each variable is copied, starting with *stem.1* and finishing with *stem.nnn*, where *nnn* is the value of *stem.0*.

For example, if *stem* is VARXX. and VARXX.0 has the value 3, the variables VARXX.1, VARXX.2, and VARXX.3 are copied to a tape file.

This function is available only from a REXX procedure.

Related function

TX

Copy tape records into a REXX stem variable

Figure 483. Syntax

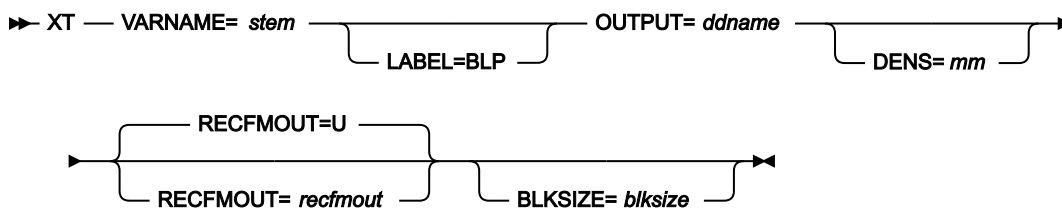

blksize

If *recfmout* contains F, the actual block size; otherwise, the maximum block size. If *recfmout* contains B or S, *blksize* is required; otherwise, it is optional. The maximum is 65 535 (for V), 9 999 (for D), or 9 999 999 (otherwise). If the tape is processed by other utilities or standard access methods, you must also consider the operating system limits.

ddname

Refers to a DD or TSO ALLOC statement.

LABEL=BLP

Specifies that bypass label processing is used. This parameter must be specified with the first File Manager function that uses the tape. For BLP processing requirements, see "Customizing the Security Environment" in the *File Manager for z/OS Customization Guide*.

mm

A 2-byte tape mode as shown in [Tape density and mode values on page 449](#).

recfmout

Record format for the output. Each value is a combination of the following letters:

B

Blocked

D

Variable-length ISO/ANSI tape records

F

Fixed length

S

Spanned format

U

Undefined length

V

Variable length

The possible values are: U, F, FB, V, VB, VBS, VS, D, DB, DBS, and DS.

stem

A REXX stem variable name. The maximum length is 44 characters.

XV (REXX Variable to VSAM) -- REXX only**Purpose**

Copy a REXX stem variable to a VSAM data set.

Usage notes

Each variable is copied, starting with *stem.1* and finishing with *stem.nnn*, where *nnn* is the value of *stem.0*.

For example, if *stem* is VARXX. and VARXX.0 has the value 3, the variables VARXX.1, VARXX.2, and VARXX.3 are copied to a VSAM data set.

This procedure is available only from a REXX procedure.

Related function**VX**

Copy records from a VSAM data set to a REXX stem variable

Figure 484. Syntax

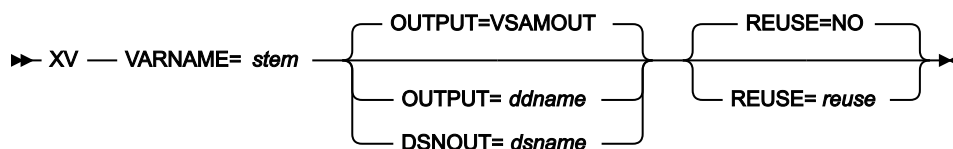
**ddname**

Refers to a DD or TSO ALLOC statement. The default is VSAMOUT.

dsname

Name of a VSAM data set.

reuse

Specify YES to replace any existing records in the output data set (if it is defined with the REUSE parameter in the catalog). Specify NO to add new records without deleting the old records. The default is NO.

stem

A REXX stem variable name. The maximum length is 44 characters.

External REXX functions

This section describes the REXX external functions that you can use when writing REXX procedures to enhance a File Manager function. In addition, File Manager provides access to the REXX internal functions described in the *z/OS TSO/E REXX Reference*.

CHANGE

Changes a specified character string.

CHG_OUT

(Can be used in FASTREXX procedures.) Changes a character string in the output record.

CHG_VAR

(Can be used in FASTREXX procedures.) Changes one or more occurrences of an old string in a variable to a new string.

CONTAINS

Checks for character values in a specified string.

FLD

(Can be used in FASTREXX condition expressions or internally processed criteria expressions.) Refers to a field from the current input record.

FLD_CO

(Can be used in FASTREXX condition expressions or internally processed criteria expressions.) Searches a field in the input record for one or more occurrences of a string, or tests a field in the input record for one more numeric values.

FLD_OUT

(Can be used in FASTREXX procedures.) Overlays the output record with a field from the input record.

FLD_TM

(Can be used in FASTREXX condition expressions or internally processed criteria expressions.) Tests selected bits of a field in the input record.

FLD_TYPE

(Can be used in FASTREXX condition expressions or internally processed criteria expressions.) Tests the data type of a field in the input record.

FLDI

(Can be used in FASTREXX procedures.) Performs a conditional test against an input record field.

FLDO

(Can be used in FASTREXX procedures.) Performs a conditional test against an output record field.

I_LENGTH

(Can be used in FASTREXX condition expressions or internally processed criteria expressions.) Returns the length of the input record.

MOD_DATE

(Can be used in FASTREXX procedures.) Sets, increments, or decrements a date field using year, month, or day values.

NCONTAIN

Checks for numeric values in a specified string.

O_LENGTH

(Can be used in FASTREXX condition expressions or internally processed criteria expressions.) Returns the current length of the output record.

OFLD_CO

(Can be used in FASTREXX condition expressions or internally processed criteria expressions.) Searches a field in the output record for one or more occurrences of a string, or tests a field in the output record for one more numeric values, and resets the current output relative position (OUTPOS) accordingly.

OVLY_OUT

(Can be used in FASTREXX procedures.) Overlays the output record with a literal (constant) or variable value.

OVLY_VAR

(Can be used in FASTREXX procedures.) Overlays the named character variable with a string.

PRINT

Prints a record.

PRTCOUNT

(Can be used in FASTREXX condition expressions or internally processed criteria expressions.) Returns the count of records printed.

RECSIN

(Can be used in FASTREXX condition expressions or internally processed criteria expressions.) Returns the count of records read.

RECSOUT

(Can be used in FASTREXX condition expressions or internally processed criteria expressions.) Returns the count of records written to a given data set.

RSTR_OUT

(Can be used in FASTREXX condition expressions.) Restores the most recently saved copy of the output buffer.

SAVE_OUT

(Can be used in FASTREXX condition expressions.) Saves a copy of the current output buffer.

SET_OLEN

(Can be used in FASTREXX procedures.) Sets the length of the output record.

SETC

(Can be used in FASTREXX procedures.) Defines or changes a character variable.

SETN

(Can be used in FASTREXX procedures.) Defines or changes a numeric variable

TESTC

(Can be used in FASTREXX procedures.) Performs a conditional test against a character variable.

TESTN

(Can be used in FASTREXX procedures.) Performs a conditional test against a numeric variable.

TALLY

(Can be used in FASTREXX procedures.) Totals a field value and reports the total.

TFLD

(Can be used in FASTREXX condition expressions or internally processed criteria expressions.) Searches a field in the input record for one or more occurrences of a string, or tests a field in the input record for one more numeric values. For dimensioned fields, you can search any or all of the elements of the array.

TM

Tests a string for a bit value.

VAR_OUT

(Can be used in FASTREXX procedures.) Overlays the output record with a field from a variable.

VAR_TM

(Can be used in FASTREXX procedures.) Tests selected bits of a field in a variable.

WRITE

(Can be used in FASTREXX procedures.) Writes a record.

The following REXX external functions can only be used with DSEB (Data Set Edit Batch):

BOT

(Can be used in FASTREXX procedures.) Move to the last record

DOWN

(Can be used in FASTREXX procedures.) Move down (forwards) a specified number of records

FINDNEXT

(Can be used in FASTREXX procedures.) Search for a string from the current record forwards

FINDPREV

(Can be used in FASTREXX procedures.) Search for a string from the current record backwards

RECCUR

(Can be used in FASTREXX procedures.) Return the current record number

TOP

(Can be used in FASTREXX procedures.) Move to the first record

UP

(Can be used in FASTREXX procedures.) Move up (backwards) a specified number of records

UPDATE

(Can be used in FASTREXX procedures.) Replace the current input record with the value in OUTREC

The following functions are only valid when used in template criteria for segmented templates.

SEGCNT

(Does not require REXX processing.) Returns the current segment number when identifying segments for a given record.

SEGNO

(Does not require REXX processing.) Returns the previous number of occurrences of a specified segment on the current record.



Note: You can only use these File Manager-specific REXX external functions, and the INREC and OUTREC variables, in a REXX procedure specified by the PROC parameter of a File Manager function (or, when using panels, by the **Use REXX proc** field). You cannot use these functions and variables in REXX procedures outside of this File Manager environment.

Absolute and relative positioning in external REXX functions

All File Manager external REXX functions that refer to positions within the input or output record can use absolute values to determine the byte location within the record. For example, the FLD function syntax is:

```
FLD(start_column,length,type)
```

where *start_column* can be an integer that refers to a specific byte in the input record.

However, some external REXX functions also allow positions to be specified as an offset value, relative to the “current position” within the input or output record. The current position is initialized as each record is processed but can be modified by these functions.

For input records, this allows you to perform tasks such as searching for a string in the input record and then testing or copying the contents of a field relative to the located string.

For output records, this allows you to easily append fields or constants at positions relative to the most recently updated output record field. For example, you could append a number of constants and fields, one after the other in the output record, without needing to keep track of the exact current starting position or manually updating the starting position with the length of added fields.



Note: You cannot use the REXX external functions to write data beyond the logical record limitations of the output data set. For example, when using a Fixed Block data set that has an LRECL of 80, you cannot write data to position 81 or beyond.

The following functions support relative positioning:

- CHG_OUT
- CHG_VAR
- FINDNEXT
- FINDPREV
- FLD
- FLD_CO
- FLD_OUT
- FLD_TM
- FLD_TYPE
- FLDI
- FLDO
- MOD_DATE
- OVLY_OUT
- OVLY_VAR
- SETC
- SETN
- TESTC
- TESTN
- VAR_OUT
- VAR_TM

To maintain the current position within the input and output records, these functions use two internal variables, INPOS and OUTPOS. These values have not been externalized to the REXX environment and can only be accessed or altered indirectly by using the functions listed above or SET_OLEN (which does not support relative position arguments but does alter the value of OUTPOS in some circumstances).

INPOS

For each new record that is processed, INPOS is set to 1. INTPOS is then modified (as a side effect) when the following functions are used:

FLD_CO

Whenever the FLD_CO function executes a successful search for a *needle* that is a string (type C or U), INPOS is then changed for the current input record. If a *needle* is found, INPOS is set to the first byte of the located *needle*. If no *needle* is found, INPOS is unchanged.

FLDI

Whenever the FLDI function (with contains operator) executes a successful search for a *needle* that is a string (type C or U), INPOS is then changed for the current input record. If a *needle* is found, INPOS is set to the first byte of the located *needle*. If no *needle* is found, INPOS is unchanged.

When you use the FLDI function with the VER operator and the verification fails, INPOS is set to the column of the character that failed the verification.

FINDNEXT

Whenever the FINDNEXT function executes a successful search for a *needle*, the INPOS is changed and set to the first byte of the located *needle*. If no *needle* is found, then INPOS is unchanged.

FINDPREV

Whenever the FINDPREV function executes a successful search for a *needle*, the INPOS is changed and set to the first byte of the located *needle*. If no *needle* is found, then INPOS is unchanged.

OUTPOS

For each new record that is processed, OUTPOS is set to 1 greater than the length of the current output record. The output record is initially the same length as the input record, unless templates have been used to reformat the record. OUTPOS is then modified (as a side effect) when the following functions are used:

CHG_OUT

CHG_OUT sets OUTPOS to one byte past the end of the last changed field in the output record.

FLD_OUT

FLD_OUT sets OUTPOS to one byte past the end of the field being overlaid in the output record.

OVLY_OUT

OVLY_OUT sets OUTPOS to one byte past the end of the field being overlaid in the output record.

SET_OLEN

SET_OLEN only changes OUTPOS if it truncates the output record so that the existing OUTPOS becomes greater than the reduced record length. In this case, OUTPOS is reset to the reduced length plus 1.

FLDO with contains operator

Whenever the FLDO function (with contains operator) executes a successful search for a *needle* that is a string (type C or U), OUTPOS is then changed for the current input record. If a *needle* is found, OUTPOS is set to the first byte of the located *needle*. If no *needle* is found, OUTPOS is unchanged.

When you use the FLDO function with the VER operator and the verification fails, OUTPOS is set to the column of the character that failed the verification.

VARPOS

For each new record that is processed, VARPOS is set to 1. VARPOS is then modified (as a side effect) when the following functions are used:

CHG_VAR

CHG_VAR sets VARPOS to one byte past the end of the last changed field in the variable.

OVLY_VAR

OVLY_VAR sets VARPOS to one byte past the end of the field being overlaid in the variable.

TESTC

Whenever the TESTC function (with contains operator) executes a successful search for a *needle* that is a string (type C or U), VARPOS is then changed for the current variable. If a *needle* is found, VARPOS is set to the first byte of the located *needle*. If no *needle* is found, VARPOS is unchanged.

When you use the TESTC function with the VER operator and the verification fails, VARPOS is set to the column of the character that failed the verification.

Specifying relative positions

Relative positioning is specified when you use a special character string, in the form of <type><offset>, in place of an integer in the *start* argument of a supported function. The relative position can be specified in the following ways:

IPx

The start position is taken from the current INPOS (the "I" in <type>) and then offset a positive (the "P" in <type>) number of bytes, as specified by x. For example, if the INPOS was currently 20 and you specified a *start* argument of IP5, the start position would be 25.

INx

The start position is taken from the current INPOS and then offset a negative (the "N" in <type>) number of bytes, as specified by x. For example, if the INPOS was currently 20 and you specified a *start* argument of IN5, the start position would be 15.

OPx

The start position is taken from the current OUTPOS (the “O” in <type>) and then offset a positive number of bytes, as specified by *x*. For example, if the OUTPOS was currently 20 and you specified a *start* argument of OP5, the start position would be 25.

ONx

The start position is taken from the current OUTPOS and then offset a negative number of bytes, as specified by *x*. For example, if the OUTPOS was currently 20 and you specified a *start* argument of ON5, the start position would be 15.

When the start argument's natural target is the input record, **IPx** and **INx** can be abbreviated to **Px** or **Nx**.

When the argument's natural target is the output record, **OPx** and **ONx** can be abbreviated to **Px** or **Nx**.

When the argument's natural target is a variable, **IPx**, **INx**, **OPx**, **ONx**, can be used to denote the current relative variable position. They can be abbreviated to **Px** or **Nx**.

For example, `FLD(start_column, length, type)` reads from the input record, so you could specify *start_column* as IP5 or P5 and get the same result. On the other hand, if you wanted to use the current value of OUTPOS to specify the *start_column* in the input record, you must specify the <type> in full, that is, as OP5.

Using FASTREXX variables

File Manager supports these variables for FASTREXX processing:

- System numeric variables. See [Table 30: System numeric variables on page 1632](#) below for descriptions.
- System character variables. See [Table 29: System character variables on page 1632](#) below for descriptions.
- User character variables.
- User numeric variables.
- Tally registers.

System and tally variables are maintained by File Manager and are read-only to user procedures.

User variables are defined by SETC or SETN functions (there is an implied definition in TESTC and TESTN functions for variables that do not exist). These variables can be referenced and modified by these functions:

Table 28. Batch update status and action

Function	Reference	Modify
CHG_VAR	Y	Y
CHG_OUT	Y	N
FLDI	Y	N
FLDO	Y	N

Table 28. Batch update status and action (continued)

Function	Reference	Modify
OVLY_VAR	Y	Y
OVLY_OUT	Y	N
SETC	Y	Y
SETN	Y	Y
TESTC	Y	N
TESTN	Y	N
VAR_OUT	Y	N
VAR_TM	Y	N

A user variable persists from its creation by a procedure to the end of the File Manager invocation. This allows any number of procedures run within the same File Manager invocation to refer to the same variables.

Table 29. System character variables

Name	Description
ZINREC	Input record
ZOUTREC	Output record
ZMEMBERI	Input member name
ZMEMBERO	Output member name
ZDSNIN	Input data set name
ZDSNOUT	Output data set name

Table 30. System numeric variables

Name	Description
ZRECSIN	Input record count
ZRECSOUT	Output record count

Tally register for external REXX functions

[Table 31: Functions supporting a TALLY register on page 1633](#) shows the functions that support a tally register that allows you to report on the function activity.

Table 31. Functions supporting a TALLY register

Function name	Counts number of	Sample coding for tally literal
CHANGE	Strings changed	<code>(fld(1),'a','c',0,,, 'Change 'a' to 'c' ')</code>
CHG_OUT	Strings changed	<code>chg_out('a','c',0,,, 'Change 'a' to 'c' ')</code>
CHG_VAR	Strings changed	<code>chg_var(myvar,'a','c',0,,, 'Change 'a' to 'c' ')</code>
CMP_DATE	True results	<code>cmp_date('maturity-date',,,, 'rg', '2013-01-01', '2013-12-31', cmp_date('maturity-date',,,, 'rg', '2013-01-01', '2013-12-31', 'Loans ending in 2013'))</code>
CMP_TIME	True results	<code>cmp_time('start-time', 'HH:MI:SS', '>', '12:00:00', 'Starts after midday')</code>
CONTAINS	True results	<code>co(fld(1,2), 'aa', 'bb', 'cc',, 'Contains 'aa', 'bb', 'cc')</code>
FLD_CO	True results	<code>fld_co(1,2,c, 'aa', 'bb', 'cc',, 'Contains 'aa', 'bb', 'cc')</code>
FLD_OUT	Invocations	<code>fld_out(1,2,3,2,, 'Move Columns 1,2 to Columns 3,4 ')</code>
FLD_TM	True results	<code>fld_tm(1, '01'x, 'Test under mask column 1 for '01'x ')</code>
FLD_TYPE	True results	<code>fld_type(36,1,Z, 'Check Column 36 for valid zoned')</code>
FLDI	True results	<code>fldi(1,4,b, '>', 64, 'People over 64')</code>
FLDO	True results	<code>fldo(1,4,b, '>', 64, 'People over 64')</code>
NCONTAIN	True results	<code>nco(fld(36,1), 1,4,3,2,, 'Column 36 contains 1,4,3,2')</code>
OFLD_CO	True results	<code>ofld_co(1,2,c, 'aa', 'bb', 'cc',, 'Output contains 'aa', 'bb', 'cc')</code>
OVLY_OUT	Invocations	<code>ovly_out('**', 1,2,, 'Overlay columns 1,2 with '**' ')</code>
OVLY_VAR	Invocations	<code>ovly_var(myvar, '**', 1,2,, 'Overlay columns 1,2 with '**' ')</code>
SET_FLD	Invocations	<code>set_fld('emp-bonus', 0, 'Reset employee bonus to zero')</code>
SET_OLEN	Invocations	<code>set_olen(84, 'b', 'Change output record length to 84')</code>
SETC	True results	<code>setc(myvar, 'abc',, 'Set myvar to abc')</code>
SETN	True results	<code>setn(mynum, '+2', 'Add 2 to mynum')</code>
TESTC	True results	<code>testc(myname, 'cu', 'Smith', 'Jones',, 'Common surnames')</code>
TESTN	True results	<code>testn(varage, '>', 64, 'People over 64')</code>
TFLD	True results	<code>tfld('Age', '>', 64, 'People over 64')</code> <code>tfld('Age', 'NN', 'Non-Numeric Age fields')</code> <code>tfld('Age', 'RG', 21, 75, 'People between 21 and 75 ')</code> <code>tfld('Name', 'CU', 'Smith', 'Jones',, 'Common surnames')</code>
TM	True results	<code>tm(fld(1,1), '01'x, 'Test under mask column 1 for '01'x ')</code>

Table 31. Functions supporting a TALLY register (continued)

Function name	Counts number of	Sample coding for tally literal
VAL_FLD	Invocations	<code>val_fld('emp-no','Retrieved employee number')</code>
VAR_OUT	Invocations	<code>var_out(myvar,1,2,3,2,, 'Move Columns 1,2 to Columns 3,4 ')</code>
VAR_TM	True results	<code>var_tm(myvar,1,'01'x,, 'Test under mask column 1 for '01'x ')</code>

Specifying your tally register

The tally register is defined when you provide a literal value as an additional operand to the functions in [Table 31: Functions supporting a TALLY register on page 1633](#). For functions that have a fixed number of operands, the literal operand is the next positional operand beyond the defined operands for the given function. For functions that have an indefinite number of operands, a null operand is required to delimit the function operands and to denote the next operand as a tally literal.

Example 1

```
IF FLD_CO(1,8,c,'a',, 'Number of records with "a"') then
  chg_out('a','c',0,,, 'Number of strings changed from "a" to "c"')
```

produces this tally report:

```
TALLY summary report
-----
Number of records with "a"                4
Number of strings changed from "a" to "c" 32
```



Note: FLD_CO can have an indefinite number of search literals. As a result, the tally register is specified by `,, 'Number of records with "a"'`.

For CHG_OUT, no null positional delimiter is required and the TALLY literal must be the seventh operand.

Example 2

```
*FASTREXX
if fld_tm(1,'01'x) then do;
  OVLY_OUT('**',1,2,,, 'Count of first 2 chars set to "**"')
  return
end;
```

produces this tally report:

```
TALLY summary report
-----
Count of first 2 chars set to "**"        4
```

Using a tally register

Each tally register is defined by the literal description. If you code the same literal description in a number of functions, then the same tally registered is incremented as determined by the function being invoked.

BOT (DSEB only)

Figure 485. Syntax

►► BOT() ◄◄

(Can be used in FASTREXX procedures.)

Moves to the last input record.

CHANGE

Figure 486. Syntax

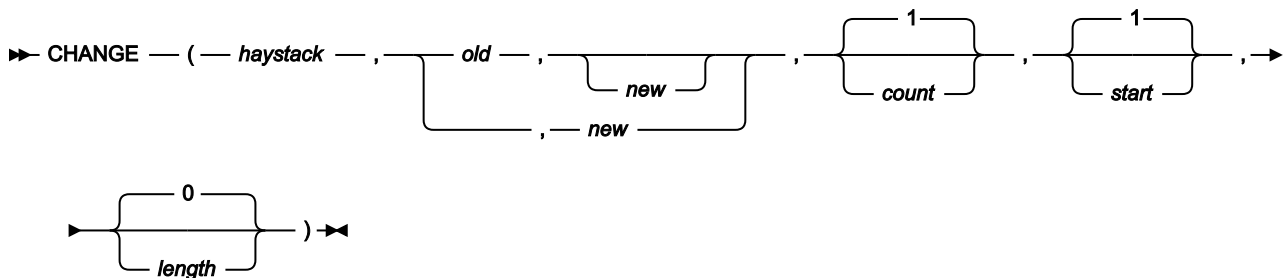

Note: Commas following the last specified argument can be omitted.

Searches *haystack* and changes one or more occurrences of *old* to *new*.

Returns

Returns *haystack*, with up to *count* occurrences of the substring *old* changed to the substring *new*.

haystack

The string that you want to search.

old

Old string to change. If this argument is omitted, the new string is inserted at the *start* location.

new

New string. If this argument is omitted, then *count* occurrences of *old* are deleted.

count

Maximum number of occurrences of *old* to change. Must be a non-negative integer. Default value is 1. A value of 0 indicates that all occurrences should be changed, unless the *old* string field is omitted, in which case it is equivalent to a value of 1.

start

Position in *haystack* in bytes at which to start searching for occurrences of *old*. Must be a positive integer. The default value is 1. If *start* is greater than the current length of the output record, the function has no effect.

length

Number of bytes within *haystack* to search for occurrences of *old*. Must be a non-negative integer. A value of 0 indicates that the remainder of *haystack* from *start* should be searched. If *length* is less than the length of *old*, the function has no effect.

Example 1

```
CHANGE('abcabcabc','abc','DeF')    ► 'DeFabcabc'
/* 1 (default) occurrence of old changed */
```

Example 2

```
CH('abcabcabc','abc','DeF',2)     ► 'DeFDeFabc'
/* 2 occurrences of old changed */
```

Example 3

```
CHANGE('abcabcabc','abc','DeF',0)  ► 'DeFDeFDeF'
/* count = 0, all occurrences of old changed */
```

Example 4

```
CH('abcabcabc','abc','DeF',,4)     ► 'abcDeFabc'
/* 1 (default) occurrences of old changed, */
/* starting at position 4 */
```

Example 5

```
CHANGE('aaaaaaaa','a','A',0,3,2)    ► 'aaAAaaaa'
/* all occurrences of old changed, starting at */
/* position 3 for a length of 2 */
```

Example 6

```
CH('abcabcabc','a',,0)              ► 'bcabc'
/* new omitted, count = 0, */
/* all occurrences of old deleted */
```

Example 7

```
CHANGE('abc',,'def',,2)             ► 'defbc'
/* old omitted, new inserted, starting at */
/* position 2 */
```

CHG_OUT

Figure 487. Syntax

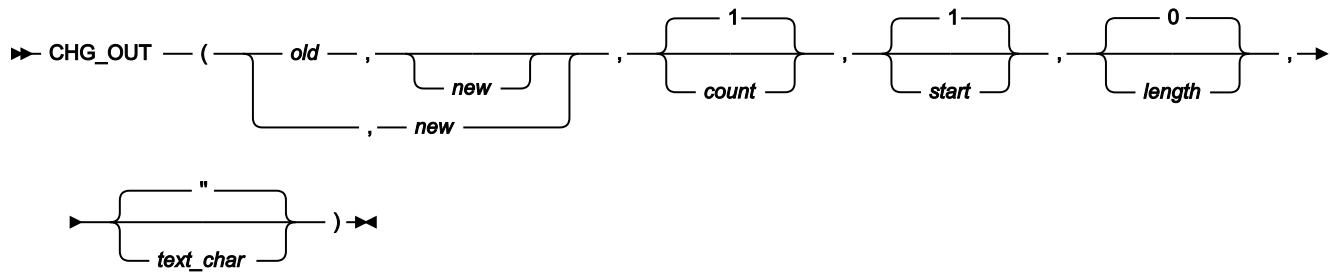

Note: Commas following the last specified argument can be omitted.

Can be used in FASTREXX procedures.

Changes one or more occurrences of an *old* string in the output record to a *new* string. On successful execution, also updates the value of OUTPOS to one byte past the end of the last changed field in the output record.

Returns

A single blank.

old

Old string to change. If this argument is omitted, the new string is inserted at the *start* location.

You can substitute a character or numeric variable or tally literal by specifying an *&varname* where *varname* matches an existing variable name.



Note:

1. Numeric values are converted to display form with leading zeros removed.
2. If a variable name is not found, then the string is interpreted as literal.

new

New string. If this argument is omitted, then *count* occurrences of *old* are deleted.

You can substitute a character or numeric variable or tally literal by specifying an *&varname* where *varname* matches an existing variable name.



Note:



1. Numeric values are converted to display form with leading zeros removed.
2. If a variable name is not found, then the string is interpreted as literal.

count

Maximum number of occurrences of *old* to change. Must be a non-negative integer. Default value is 1. A value of 0 indicates that all occurrences should be changed, unless the *old* string field is omitted, in which case it is equivalent to a value of 1.

start

Position, in bytes, in the output record at which to start searching for occurrences of *old*. Can be specified as:

Absolute position

Must be a positive integer. Default value is 1. If *start* is greater than the current length of the output record, the function has no effect.

Relative to current INPOS

Must be specified as IPx or INx. If this resolves to a value of less than or equal to zero, the function results in an error. If this resolves to a value that is greater than the current length of the output record, the function has no effect.

Relative to current OUTPOS

Can be specified as OPx or ONx, or as Px or Nx. If this resolves to a value of less than or equal to zero, the function results in an error. If this resolves to a value that is greater than the current length of the output record, the function has no effect.

length

Amount, in bytes, of the output record to search for occurrences of *old*. Must be a non-negative integer. Default value is 0. A value of 0 indicates that the remainder of the output from *start* should be searched. If *length* is less than the length of *old*, the function has no effect.

text_char

Can be a null string or a single character.

Specifying a null string (the default), indicates CHG_OUT should behave without text sensitivity.

Specifying a single character defines the special text-sensitive character and indicates that text-sensitive change behaviour is required. When a character has been specified for *text_char*, CHG_OUT behaves as follows:

- If the new and old strings are the same length, CHG_OUT behaves as if text-sensitive change behaviour had not been requested.
- If the new string is shorter than the old string, then when a replacement is made, CHG_OUT searches for the first *text_char* character following the end of the replaced string. Note that the entire record is searched. If the *text_char* character is found, additional *text_char* characters are inserted at the point

of this first subsequent character, to make up the difference in length between new and old. If the *text_char* character is not found in the remainder of the record, then no insertion takes place and the record is reduced in length. If the record is fixed-length and no subsequent action occurs to make up the shortfall, then the File Manager record padding process fills out the record when it is written.

The intended effect is that text on multiple lines, if aligned in columns separated by the text char character, continues to align in columns after replacement. This is useful for updating files with sequence numbers on the right, such as COBOL or JCL.

- When the new string is longer than the old string, then when a replacement is made, CHG_OUT searches to the right of the replaced string for two consecutive *text_char* characters. Note that the entire record is searched. If two consecutive *text_char* characters are found, they are replaced with a single *text_char* character. This process is repeated, starting from the remaining single character (and including that character) until the length difference between old and new is accounted for. Using this algorithm, multiple *text_char* characters can be reduced to a single *text_char* character, but a single *text_char* character between other characters is never eliminated.

The intended effect is to try to use existing “blank” areas in the string, to leave text on the right unchanged as much as possible. There is no guarantee that there will be an adequate number of *text_char* characters to accomplish the goal. If there are not enough *text_char* characters, then the rest of the record is shifted right and possibly truncated when it is written, if fixed in length. This is useful for modifying files like COBOL or JCL source, where a sequence number may exist to the right.

- If you have specified multiple string replacements (*count* is greater than 1), then the intent remains the same. The search proceeds from left to right, firstly checking for the search argument, and secondly *text_char* characters to expand or collapse. If the search argument is found, it is replaced and the search continues immediately following the replaced string.
- Note that the string replacement may be limited to byte positions by the *length* argument. However, the search for *text char* characters to add or remove continues past that limit to the end of the record if required.

Example 1

Assuming that the current output record contains 'abcabcabcabcabcabc', then:

```
CHG_OUT('abc','DeF',0)
/* All occurrences of old within the      */
/* output record are changed              */
```

The output record becomes 'DeFDeFDeFDeFDeFDeF'.

Example 2

Assuming that the current output record contains 'abcabcabcabcabcabc', then:

```
CHG_OUT('abc','DeF',,4)
/* 1 (default) occurrences of old changed, */
/* starting at position 4 within the output record */
```

The output record becomes 'abcDeFabcbcabcbcabcb'.

Example 3

Assuming that the current output record contains 'aaaaaaaa', then:

```
CHG_OUT('a','A',0,3,2)
/* all occurrences of old changed, starting at */
/* position 3 in the output record, for a length of 2 */
```

The output record becomes 'aaAAaaaaaa'.

Example 4

Assuming that the current output record contains 'abcabcabcabcabcabc', and that INPOS is currently set to 13 and OUTPOS is currently set to 4, then:

```
CHG_OUT('abc','DeF',1,P3)
/* 1 occurrence of old changed, */
/* uses OUTPOS as the default target, therefore */
/* starts at position 7 within the output record */
```

The output record becomes 'abcabcDeFabcbcabcbcabcb' and OUTPOS is set to 10 (INPOS remains unchanged).

Example 5

Assuming that the current output record contains 'abcabcabcabcabcabc', and that INPOS is currently set to 13 and OUTPOS is currently set to 4, then:

```
CHG_OUT('abc','DeF',1,IN3)
/* 1 occurrence of old changed, */
/* forces start to use INPOS value, therefore */
/* starts at position 10 within the output record */
```

The output record becomes 'abcabcabcDeFabcbcabcbcabcb' and OUTPOS is set to 13 (INPOS remains unchanged).

CHG_VAR

Figure 488. Syntax

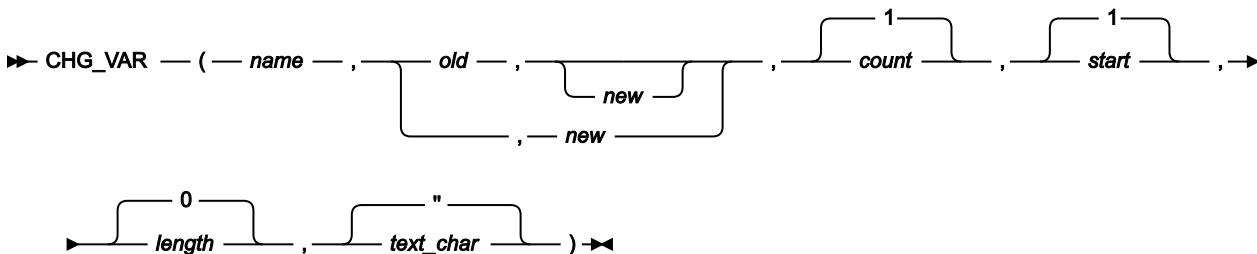

(Can be used in FASTREXX procedures.)



Note: Commas following the last specified argument can be omitted.

Changes one or more occurrences of an old string in the variable to a new string. On successful execution, also updates the value of OUTPOS to one byte past the end of the last changed field in the variable.

Returns

A single blank.

name

1–256 character variable identifier. Variable name matching is not case sensitive. If the name is not found, a severe error occurs and the procedure is terminated. Cannot be a system character variable or a system numeric variable. See [Using FASTREXX variables on page 1631](#).

old

Old string to change. If this argument is omitted, the new string is inserted at the start location. You can substitute a character or numeric variable or tally literal by specifying an *&varname* where *varname* matches an existing variable name.



Note:

1. Numeric values are converted to display form with leading zeros removed.
2. If a variable name is not found, then the string is interpreted as a literal.

new

New string. If this argument is omitted, then *count* occurrences of *old* are deleted. You can substitute a character or numeric variable or tally literal by specifying an *&varname* where *varname* matches an existing variable name.



Note:

1. Numeric values are converted to display form with leading zeros removed.
2. If a variable name is not found, then the string is interpreted as a literal.

count

Maximum number of occurrences of *old* to change. Must be a non-negative integer. Default value is 1. A value of 0 indicates that all occurrences should be changed.

start

Position, in bytes, in the variable at which to start searching for occurrences of *old*. Can be specified as:

Absolute position

Must be a positive integer. Default value is 1. If *start* is greater than the current length of the variable, the function has no effect.

Relative to current variable position

Can be specified as OPx or ONx, or as Px or Nx, or as IPx or INx. If this resolves to a value of less than or equal to zero, the function results in an error. If this resolves to a value that is greater than the current length of the variable, the function has no effect.

length

Amount, in bytes, of the variable to search for occurrences of *old*. Must be a non-negative integer. Default value is 0. A value of 0 indicates that the remainder of the output from *start* should be searched. If *length* is less than the length of *old*, the function has no effect.

text_char

Can be a null string or a single character.

Specifying a null string (the default), indicates CHG_VAR should behave without text sensitivity.

Specifying a single character defines the special text-sensitive character and indicates that text-sensitive change behaviour is required. When a character has been specified for *text_char*, CHG_VAR behaves in this way:

- If the new and old strings are the same length, CHG_VAR behaves as if text-sensitive change behaviour had not been requested.
- If the new string is shorter than the old string, then when a replacement is made, CHG_VAR searches for the first *text_char* character following the end of the replaced string. Note that the entire record is searched. If the *text_char* character is found, additional *text_char* characters are inserted at the point of this first subsequent character, to make up the difference in length between *new* and *old*. If the *text_char* character is not found in the remainder of the record, then no insertion takes place and the record is reduced in length. If the record is fixed-length and no subsequent action occurs to make up the shortfall, then the File Manager record padding process fills out the record when it is written.

The intended effect is that text on multiple lines, if aligned in columns separated by the text char character, continues to align in columns after replacement. This is useful for updating files with sequence numbers on the right, such as COBOL or JCL.

- When the new string is longer than the old string, then when a replacement is made, CHG_VAR searches to the right of the replaced string for two consecutive *text_char* characters. Note that the entire record is searched. If two consecutive *text_char* characters are found, they are replaced with a single *text_char* character. This process is repeated, starting from the remaining single character (and including that character) until the length difference between *old* and *new* is accounted for. Using this algorithm, multiple *text_char* characters can be reduced to a single *text_char* character, but a single *text_char* character between other characters is never eliminated.

The intended effect is to try to use existing "blank" areas in the string, to leave text on the right unchanged as much as possible. There is no guarantee that there will be an adequate number of *text_char* characters to accomplish the goal. If there are not enough *text_char* characters, then the rest of the record is shifted right and possibly truncated when it is written, if fixed in length. This is useful for modifying files like COBOL or JCL source, where a sequence number may exist to the right.

- If you have specified multiple string replacements (*count* is greater than 1), then the intent remains the same. The search proceeds from left to right, firstly checking for the search argument, and secondly *text_char* characters to expand or collapse. If the search argument is found, it is replaced and the search continues immediately following the replaced string.
- Note that the string replacement may be limited to byte positions by the length argument. However, the search for *text_char* characters to add or remove continues past that limit to the end of the record if required.

Example 1

Assuming that the current variable contains 'abcabcabcabcabcabc', then:

```
CHG_VAR(MYVAR,'abc','DeF',0)
/* All occurrences of old within the      */
/* variable are changed                    */
```

The variable becomes 'DeFDeFDeFDeFDeFDeF'.

Example 2

Assuming that the current variable contains 'abcabcabcabcabcabc', then:

```
CHG_VAR(MYVAR,'abc','DeF',,4)
/* 1 (default) occurrences of old changed, */
/* starting at position 4 within the variable */
```

The variable becomes 'abcDeFabcabcabcabc'.

Example 3

Assuming that the current variable contains 'aaaaaaaa', then:

```
CHG_VAR(MYVAR,'a','A',0,3,2)
/* all occurrences of old changed, starting at */
/* position 3 in the variable, for a length of 2 */
```

The variable becomes 'aaAAaaaa'.

Example 4

Assuming that the current variable contains 'abcabcabcabcabcabc', and that current variable position is 4, then:

```
CHG_VAR(MYVAR,'abc','DeF',1,P3)
/* 1 occurrence of old changed,           */
/* uses current position as the default target, therefore */
/* starts at position 7 within the variable */
```

The variable becomes 'abcabcDeFabcabcbcabcb' and the variable position is set to 10.

Example 4

Assuming that the current variable contains 'abcabcabcabcabcabc', and that current variable position is currently set to 13, then:

```
CHG_VAR(MYVAR,'abc','DeF',1,IN3)
/* 1 occurrence of old changed,          */
/* forces start to use current position value, therefore */
/* starts at position 10 within the variable          */
```

The variable becomes 'abcabcabcDeFabcabcbcabcb' and the variable position is set to 13.

CONTAINS

Figure 489. Syntax

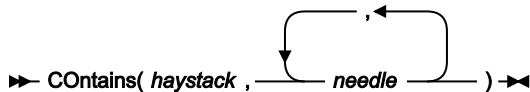

Checks the contents of *haystack* for one or more occurrences of *needle*.

Returns

If the *haystack* string contains one or more of the *needle* strings, then CONTAINS returns 1. Otherwise, CONTAINS returns 0.

CONTAINS is case-sensitive: it only returns 1 if the *haystack* contains a string with the same mix of uppercase and lowercase as a *needle*.

haystack

The string that you want to search.

needle

The string that you are attempting to find within *haystack*. You can search for up to 20 strings at a time.

For a similar function that matches numeric values, see [NCONTAIN on page 1672](#). For a FASTREXX-eligible equivalent, see [FLD_CO on page 1655](#).

Example 1

If the current input record contains "Michael", "Mick" or "Mike" in the first ten columns, then print the record.

```
If CO(FLD(1,10),'Michael','Mick','Mike') Then
PRINT(inrec, 'CHAR')
```

Example 2

If the current input record contains "USA", "Australia" or "England", then drop the record from processing.

```
If CONTAINS(inrec,'USA','Australia','England') Then
  Return 'DROP'
```

CMP_DATE

Figure 490. CMP_DATE syntax – with template

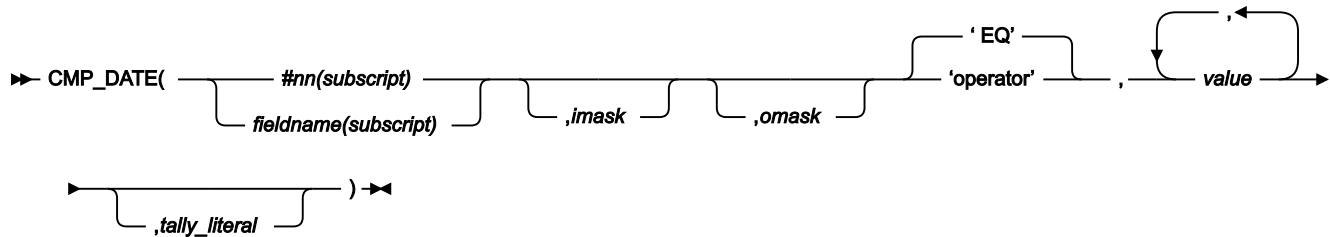
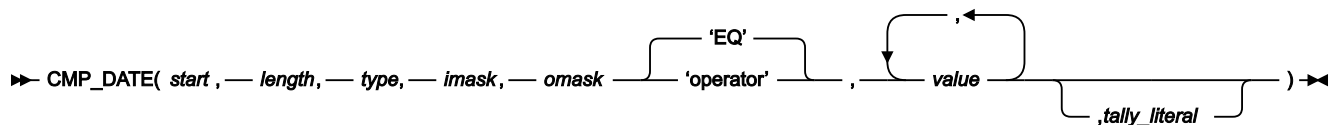

Figure 491. CMP_DATE syntax – without template



(Can be used in FASTREXX condition expressions.)

`CMP_DATE` is a Boolean function which can be run with or without a template. It enables you to perform a conditional test against date values in a field.



Note:

1. The date value can also include a time component.
2. If the field is defined as a date and time field in the template, `imask` and `omask` do not need to be specified as File Manager takes these values from the template.
3. The Field name (`fieldname`), field reference (`#nn`), operator (`operator`), and non-numeric values should all be enclosed in quotation marks to avoid syntax errors.
4. Commas following the last specified argument can be omitted.

#nn or fieldname

#nn

Use this form when providing free-format criteria during template edit. `nn` is the field reference number displayed during template edit. It is not valid to use `fieldname` for a field reference when providing criteria during template edit.

fieldname

Use this form of identifying fields when coding user procedures. For non-unique names, you can specify a name in the form `groupname.dataname`. Name matching is not case-sensitive. If the name is unqualified, then the first occurrence of the name is used. Do not code `#nn` values in user

procedures, as the displayed field reference values do not identify the correct field when running from a user procedure.

subscript

This applies *only* to dimensioned fields. You can specify one of these forms:

(ANY)

This is the default if you do not specify a subscript for a dimensioned field and it indicates that at least one element of the associated array must satisfy the condition for a true result.

(ALL)

This indicates that all elements of the associated array must satisfy the condition for a true result.

(nn)

This refers to a single array element and you should provide a valid subscript for the dimensioned field.

start

Position, in bytes, in the input record at which to start reading the field value. Can be specified as:

Absolute position

Must be a positive integer. Default value is 1. If start is greater than the current length of the input record, the function has no effect.

Relative to current INPOS

Can be specified as IPx or INx, or as Px or Nx. If this resolves to a value of less than or equal to zero or greater than the current length of the input record, the function has no effect.

Relative to current OUTPOS

Must be specified as OPx or ONx. If this resolves to a value of less than or equal to zero or greater than the current length of the input record, the function has no effect.

length

The length of the field in bytes.

For binary fields, either omit the length or specify 4.

For packed decimal fields, if you specify the length, it must be in the range 1–16. If you omit the length, CMP_DATE attempts to determine the packed field length from the record data and returns only that field.

For zoned decimal fields the length must be in the range 1-32.

type

The data type of the field. Valid values are:

B

Binary.

C

Character. This is the default.

P

Packed decimal.

B

Zoned decimal.

imask

A value or picture string that defines the format used to store the date in the field. For a picture string, File Manager supports all pictures described in the z/OS® Language Environment® Programming Services, Appendix B, "Date and time services tables".

File Manager also supports specifying one of the following values:

CBLDATE

COBOL date (the number of days since 31 December 1600).

CYYDDD

Julian date with C as the century indicator (0 = 1900s, 1 = 2000s)

LILDATE

Lilian date (the number of days since 14 October 1582)

LILTIME

Date and time stored as the number of seconds since 00:00:00 14 October 1582.

STCK

Date and time stored as a TOD clock value.

STCKE

Date and time stored as an extended TOD clock value.

An *imask* value must be available for File Manager to use. If a template is used and *imask* is not specified, File Manager uses the internal mask saved in the template.

omask

A picture string that describes the format used for the date values passed as parameters to CMP_DATE. File Manager supports all pictures described in the z/OS® Language Environment® Programming Services, Appendix B, "Date and time services tables".

An *omask* value must be available for File Manager to use. If a template is used and *omask* is not specified, File Manager uses the output mask saved in the template.

operator

The default is EQ or =. This function supports all the operators described for dynamic template and criteria edit. For details about the operators supported and their description, see:

- [Dynamic Template panel on page 845](#)
- [Entering criteria expressions for an array element on page 292](#)
- [Record Selection Criteria panel on page 991](#)

value

The value or values must be valid in the context of the operator and the field which is being referenced. For example, only certain operators like CO (contains) allow multiple values. The format of a value must be based on the date format described by *omask*.

tally_literal

Specify a literal to appear on a tally report that counts every true result from the CMP_DATE function.

Example 1

Process only those records with a START-DATE value that falls on a Monday or is in the month of May.

```
IF CMP_DATE('START-DATE',, 'Www Mmm DD,YYYY', 'CO', 'Mon', 'May') THEN
  RETURN
ELSE
  RETURN 'DROP'
```

Example 2

Process only those records with a 5 byte packed decimal field positioned at byte 34 that contains a Julian date value after the 31st of December 2009.

```
IF CMP_DATE(34,5,P, 'CYYDDD', 'YYYY-MM-DD', 'GT', '2009-12-31') THEN
  RETURN
ELSE
  RETURN 'DROP'
```

CMP_TIME

Figure 492. CMP_TIME syntax – with template

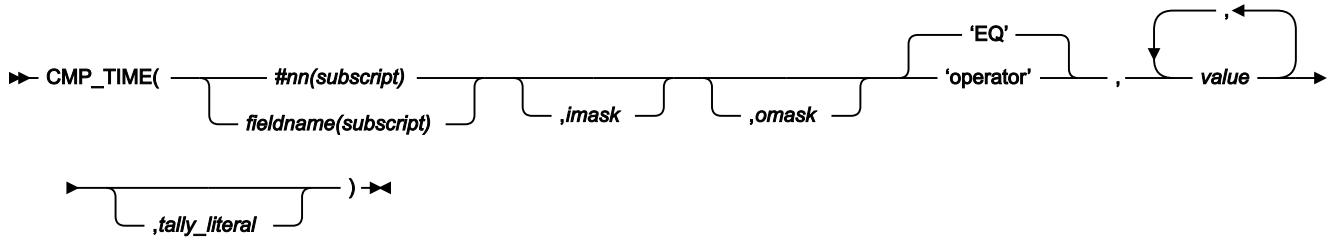
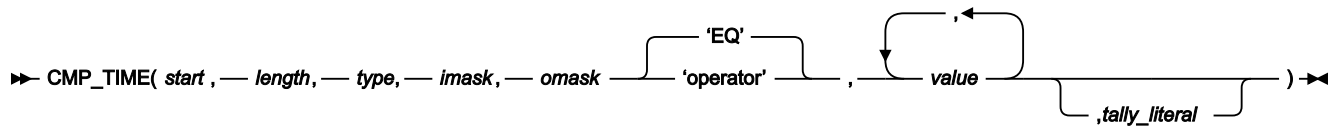

Figure 493. CMP_TIME syntax – without template



(Can be used in FASTREXX condition expressions.)

CMP_TIME is a Boolean function which can be run with or without a template. It enables you to perform a conditional test against time values in a field.



Note:

1. If the field is defined as a date and time field in the template, *imask* and *omask* do not need to be specified as File Manager will take these values from the template.
2. The Field name (*fieldname*), field reference (*#nn*), operator (*operator*), and non-numeric values should all be enclosed in quotation marks to avoid syntax errors.
3. Commas following the last specified argument can be omitted.

#nn or fieldname

#nn

Use this form when providing free-format criteria during template edit. *nn* is the field reference number displayed during template edit. It is not valid to use *fieldname* for a field reference when providing criteria during template edit.

fieldname

Use this form of identifying fields when coding user procedures. For non-unique names, you can specify a name in the form *groupname.dataname*. Name matching is not case-sensitive. If the name is unqualified, then the first occurrence of the name is used. Do not code *#nn* values in user procedures, as the displayed field reference values do not identify the correct field when running from a user procedure.

subscript

This applies *only* to dimensioned fields. You can specify one of these forms:

(ANY)

This is the default if you do not specify a subscript for a dimensioned field and it indicates that at least one element of the associated array must satisfy the condition for a true result.

(ALL)

This indicates that all elements of the associated array must satisfy the condition for a true result.

(nn)

This refers to a single array element and you should provide a valid subscript for the dimensioned field.

start

Position, in bytes, in the input record at which to start reading the field value. Can be specified as:

Absolute position

Must be a positive integer. Default value is 1. If start is greater than the current length of the input record, the function has no effect.

Relative to current INPOS

Can be specified as IPx or INx, or as Px or Nx. If this resolves to a value of less than or equal to zero or greater than the current length of the input record, the function has no effect.

Relative to current OUTPOS

Must be specified as OPx or ONx. If this resolves to a value of less than or equal to zero or greater than the current length of the input record, the function has no effect.

length

The length of the field in bytes.

For binary fields, either omit the length or specify 4.

For packed decimal fields, if you specify the length, it must be in the range 1–16. If you omit the length, CMP_TIME attempts to determine the packed field length from the record data and returns only that field.

For zoned decimal fields the length must be in the range 1-32.

type

The data type of the field. Valid values are:

B

Binary.

C

Character. This is the default.

P

Packed decimal.

B

Zoned decimal.

imask

A value or picture string that defines the format used to store the date in the field. For a picture string, File Manager supports all pictures described in the z/OS® Language Environment® Programming Services, Appendix B, "Date and time services tables".

File Manager also supports specifying one of the following values:

CENTSECS

Time of day in hundredths of seconds.

MICSECS

Time of day in millionths of seconds.

MILLSECS

Time of day in thousandths of seconds.

An *imask* value must be available for File Manager to use. If a template is used and *imask* is not specified, File Manager uses the internal mask saved in the template.

omask

A picture string that describes the format used for the date values passed as parameters to CMP_TIME. File Manager supports all pictures described in the z/OS® Language Environment® Programming Services, Appendix B, "Date and time services tables".

An *omask* value must be available for File Manager to use. If a template is used and *omask* is not specified, File Manager uses the output mask saved in the template.

operator

The default is EQ or =. This function supports all the operators described for dynamic template and criteria edit. For details about the operators supported and their description, see:

- [Dynamic Template panel on page 845](#)
- [Entering criteria expressions for an array element on page 292](#)
- [Record Selection Criteria panel on page 991](#)

value

The value or values must be valid in the context of the operator and the field which is being referenced. For example, only certain operators like CO (contains) allow multiple values. The format of a value must be based on the date format described by *omask*.

tally_literal

Specify a literal to appear on a tally report that counts every true result from the CMP_TIME function.

Example 1

Process only those records with a START-TIME value after midday.

```

IF CMP_TIME('START-TIME',MILLSECS,'HH:MI:SS.999','GT','12:00:00.000')
THEN
  RETURN
ELSE
  RETURN 'DROP'

```

DOWN (DSEB only)

Figure 494. Syntax

► **DOWN(*n*)** ◄

(Can be used in FASTREXX procedures.)

Moves down *n* number of records, or to the last record, if there are less than *n* records below the current record.

Returns

If, before moving, the current record is the last record, then the DOWN function returns the string value "EOF" (end of file). Otherwise, DOWN returns 0.

FINDNEXT, FINDPREV (DSEB only)

Figure 495. Syntax

► **FINDNEXT** (*needle* , *start* , *end* , *CASE*) ◄
 FINDPREV

(Can be used in FASTREXX procedures.)

Searches for *needle* in the input data set, from the current input record forwards (FINDNEXT) or backwards (FINDPREV). You can limit the search to a range of columns, or to an exact matching case.

If a FINDNEXT() or FINDPREV() has located a needle on a given record, then repeated searching resumes from the previously located needle plus 1 for FINDNEXT and minus 1 for FINDPREV. If the record location has been changed by an UP(), Down(), TOP(), or BOT() command, or there has been no previous located needle, then FINDPREV searches from the end of the current record backward, and FINDNEXT searches from the start of the current record forward.

Returns

If the search is successful, the record in which *needle* was found becomes the current input record, and the FINDNEXT function returns the starting column of *needle* in the record. If the search is unsuccessful, the current input record remains the same, and FINDNEXT returns 0.

needle

String(s) or numeric(s) to search for. The needle can be a character variable in the form &*varname* where *varname* matches an existing variable name. If an "&" is coded and a variable name is not found, then the needle is treated as the string value to be searched for.

start

The position, in bytes, of the start of the range in each input record to be searched.

end

The position, in bytes, of the end of the range in each input record to be searched.

CASE

Specifies that the comparison is case-sensitive.

If you want to save any changes you have made to the record that was current prior to calling FINDNEXT or FINDPREV, use the UPDATE function. Otherwise, if the search is successful, any changes made to that record are lost when FINDNEXT or FINDPREV moves to another record.

Here are some examples:

Example 1

```
FINDPREV('abc') /* Finds 'abc', 'ABC', 'ABc' and so on */
```

Example 2

```
FINDNEXT('abc',1,10,'CASE') /* Finds 'abc', but not 'ABC', 'ABc' and so on */
```

FLD

Figure 496. Syntax

► FLD(*start_column* _____) ◄

└─── ,length ───┘ └─── ,type ───┘

Can be used in FASTREXX condition expressions.

Fetches the value of a field from the current input record (INREC), starting at *start_column*, of *length* number of bytes, interpreted according to the specified *type*.

Returns

The value of the field from the current input record.

start_column

Position, in bytes, in the input record at which to start reading the field value. Can be specified as:

Absolute position

Must be a positive integer. Default value is 1. If *start* is greater than the current length of the input record, the function has no effect.

Relative to current INPOS

Can be specified as IPx or INx, or as Px or Nx. If this resolves to a value of less than or equal to zero, the function results in an error. If this resolves to a value that is greater than the current length of the input record, the function has no effect.

Relative to current OUTPOS

Must be specified as OPx or ONx. If this resolves to a value of less than or equal to zero, the function results in an error. If this resolves to a value that is greater than the current length of the input record, the function has no effect.

length

The length of the field in bytes.

For binary fields, you must specify the length. It can be 2, 4, or 8.

For character fields, if you omit the length, FLD returns the remainder of the record.

For packed decimal fields, if you specify the length, it must be in the range 1–16. If you omit the length, FLD attempts to determine the packed field length from the record data and returns only that field.

For zoned decimal fields, if you specify the length, it must be in the range 1–31 or, if the field contains a separate sign character, in the range 1–32. If you omit the length, FLD returns the remainder of the record.

type

The data type of the field. Valid values are:

B

Binary. FLD interprets binary fields as being signed.

C

Character. This is the default.

P

Packed decimal.

U

Interprets the field as Character, but converts it to uppercase before returning the string.

Z

Zoned decimal. Interprets all of the COBOL external decimal variants as numeric data.

If you specify a value for *length* that would cause the record length to be exceeded:

- For character fields (*type* C, U), FLD returns the remainder of the record.
- For numeric fields (*types* B, P, Z), FLD returns a null string.

If you specify a numeric type (*types* B, P, Z), and the specified field contains invalid data for that type, then FLD returns a null string. Numeric data is always returned in integer form; that is, FLD does not perform scaling of numeric data.

The FLD function is similar to the built-in REXX SUBSTR function, except that FLD interprets the “substring” according to the specified data type, and returns the value formatted appropriately. (For a numeric field, FLD returns the value with a sign, and without leading zeros.)

Example 1

If the value of the packed decimal field that starts at column 8 is greater than 100, then do not process the current record.

```
If FLD(8,P) > 100 Then Return 'DROP'
```

Example 2

If the value of the 2-digit year field starting at column 42 is greater than 60, then insert the literal “19” before the year field; otherwise, insert “20”.

```
If FLD(42,2,Z) > 60 Then
  outrec = FLD(1,41)||'19'||FLD(42)
Else
  outrec = FLD(1,41)||'20'||FLD(42)
```

Example 3

If the 4-byte field that starts at column 11 does not contain valid packed decimal data, then do not process the current record.

```
If FLD(11,4,p) = '' Then Return 'DROP'
```

Example 4

If the value of the packed decimal field that starts at INPOS + 8 is greater than 100, then do not process the current record.

```
If FLD(P8,P) > 100 Then Return 'DROP'
```

FLD_CO

Figure 497. Syntax

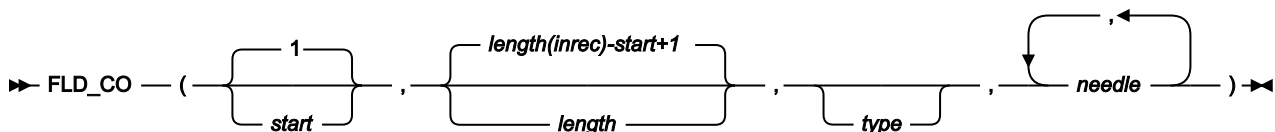

(Can be used in FASTREXX condition expressions.)

Searches the field within the input record specified by *start* and *length*, for one or more occurrences of *needle*. On successful execution when searching for a string, also updates the value of INPOS to the first byte of the located field in the input record.

Returns

If at least one occurrence of *needle* is found, returns 1. If no occurrences are found, returns 0.

start

Position, in bytes, in the input record at which to start searching for occurrences of *needle*. Can be specified as:

Absolute position

Must be a positive integer. Default value is 1. If *start* is greater than the current length of the input record, the function has no effect.

Relative to current INPOS

Can be specified as IPx or INx, or as Px or Nx. If this resolves to a value of less than or equal to zero, the function results in an error. If this resolves to a value that is greater than the current length of the input record, the function has no effect.

Relative to current OUTPOS

Must be specified as OPx or ONx. If this resolves to a value of less than or equal to zero, the function results in an error. If this resolves to a value that is greater than the current length of the input record, the function has no effect.

length

Length, in bytes, of the field to be searched.

- For character fields, the length defaults to the remaining record length from the start position to the end of the record (inclusive). A value of 0 also indicates that the field extends to the end of the record.
- For binary fields, you must specify the length. It can be 2, 4, or 8.
- For packed decimal fields, if you specify the length, it must be in the range 1-16. If you omit the length, FLD_CO attempts to determine the packed field length from the record data.
- For zoned decimal fields, if you specify the length, it must be in the range 1-31 or, if the field contains a separate sign character, in the range 1-32. If you omit the length, it defaults to the remainder of the record.

type

The data type of the field. Valid values are:

B

Binary. FLD_CO interprets binary fields as being signed.

C

Character. This is the default. The comparison is case sensitive.

P

Packed decimal.

U

Interprets the field as Character, but converts it to uppercase before comparing it with *needle*.

Z

Zoned decimal. Interprets all of the COBOL external decimal variants as numeric data.

needle

String(s) or numeric(s) to search for. For the character types, FLD_CO searches the *haystack* for each of the *needles*. In this context, it behaves like a combination of the FLD and CONTAINS functions. For the numeric data types, the *haystack* is treated as a single numeric field, and an appropriate numeric comparison is performed against each of the *needles*. In this context it behaves like a combination of the FLD and NCONTAIN functions. You can search for up to 20 strings at a time.

To perform case-insensitive searches, specify *type* as 'U' and *needle* in uppercase.

Example 1

If the current input record contains "MIKE", "Mike" or "mike" in the first ten columns, then write the record.

```
If FLD_CO(1,10,'U','MIKE') Then WRITE('MDD')
```

Example 2

If the current input record contains "USA", "Australia" or "England", then drop the record from processing.

```
If FLD_CO(,,'USA','Australia','England') Then Return 'DROP'
```

Example 3

If the current input record contains "MIKE", "Mike" or "mike" in the ten columns immediately after the current INPOS, then write the record.

```
If FLD_CO(P0,10,'U','MIKE') Then WRITE('MDD')
```

FLD_OUT

Figure 498. Syntax

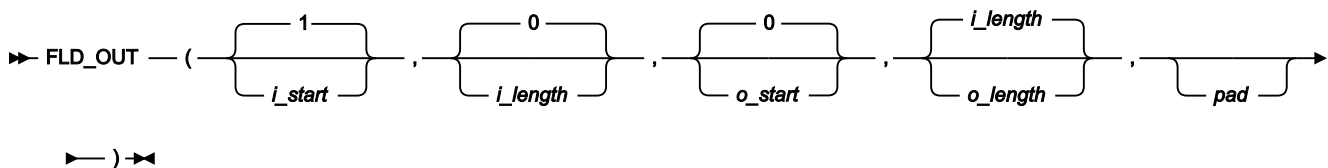

Note: Commas following the last specified argument can be omitted.

Can be used in FASTREXX procedures.

Overlays the output record with a field from the input record. See OVLY_OUT for a function to overlay the output record with a literal. If the target field length exceeds the source field length, then the source field is padded to the specified length using the pad character. If the target field length is less than the source field, the source field is truncated from the right. On successful execution, also updates the value of OUTPOS to one byte past the end of the field overlaid in the output record.

Returns

A single blank

i_start

Position, in bytes, in the input record at which to start reading the field to be copied. Can be specified as:

Absolute position

Must be a positive integer. Default value is 1.

Relative to current INPOS

Can be specified as IPx or INx, or as Px or Nx. Must resolve to a positive integer.

Relative to current OUTPOS

Must be specified as OPx or ONx. Must resolve to a positive integer.

i_length

Length, in bytes, of the source field. Must be a non-negative integer. Defaults to 0. If you omit *i_length* or specify zero, the remainder of the input record from the *i_start* position is used. This also applies if you specify a value that would cause the source field to be read from beyond the end of the current input record.

o_start

Position, in bytes, in the output record at which to start overlaying the copied field. If you omit *o_start* or specify zero, the field is appended to the end of the output record. If *o_start* is greater than the current length of the output record, the record is padded with the specified or defaulted pad character from the current record length to the specified start position. Can be specified as:

Absolute position

Must be a non-negative integer. Default value is 0.

Relative to current INPOS

Must be specified as IPx or INx. Must resolve to a positive integer.

Relative to current OUTPOS

Can be specified as OPx or ONx, or as Px or Nx. Must resolve to a positive integer.

o_length

Length, in bytes, of the target field. Defaults to the source field length (*i_length*). A value of 0 indicates that the target field length is the greater of *i_length* and the remaining output record length. If 0 is specified for both *o_start* and *o_length*, then *i_length* is used as the target length.

pad

Pad character. Defaults to the pad character set on the File Manager System Processing Options panel (when processing online) or the pad character specified in the SET function (when running in batch). If the current pad setting is OFF or unspecified, the default pad character is a blank.

Example 1

Copy the characters in columns one and two of the input record to columns three and four of the output record.

```
FLD_OUT(1,2,3,2)
```

Example 2

Append the characters in columns eleven and twelve of the input record to the end of the output record, padded with two blanks.

```
FLD_OUT(11,2,0,4,' ')
```

Example 3

Search a field in the input record for the characters 'AA' and, if found, copy to the end of the output record (assumes that OUTPOS is still set to end of output record).

```
IF FLD_CO(10,2,C,'AA') Then
/* when successful, updates INPOS to 12 */
FLD_OUT(N2,2,P0,2)
/* copies from INPOS - 2, appends to end of output record */
```

FLD_TM

Figure 499. Syntax

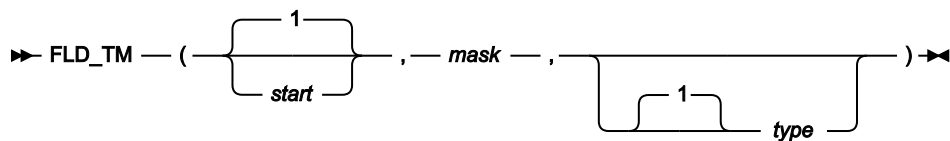

Note: Commas following the last specified argument can be omitted.

Can be used in FASTREXX condition expressions.

Tests selected bits of a field in the input record.

Returns

Returns 1 if the test evaluates as True, and 0 if the test evaluates as False.

start

Position, in bytes, in the input record at which to start testing. The length of the field is defined by the *mask*.

Can be specified as:

Absolute position

Must be a positive integer. Default value is 1. If *start* is greater than the current length of the input record, the function has no effect.

Relative to current INPOS

Can be specified as IPx or INx, or as Px or Nx. If this resolves to a value of less than or equal to zero, the function results in an error. If this resolves to a value that is greater than the current length of the input record, the function has no effect.

Relative to current OUTPOS

Must be specified as OPx or ONx. If this resolves to a value of less than or equal to zero, the function results in an error. If this resolves to a value that is greater than the current length of the input record, the function has no effect.

mask

Bit-string determining which bits to test in the field. The length of the mask defines the length of the input field. This field defines a bit-string mapping used to test the specified bits in the input record. You can use the bit-string, hex-string or character-string formats to define this field, Therefore, '0100 0000'b, '40'x, and ' ' are all legitimate and equivalent ways of defining a mask to test the second bit of a one-byte field.

type

Type of test.

1

FLD_TM returns True (1) if **all** the bits that are **on** in the mask are **on** in the input record field. This is the default value.

0

FLD_TM returns True (1) if **all** the bits that are **on** in the mask are **off** in the input record field.

M

FLD_TM returns True (1) if **at least one** of the bits that are **on** in the mask is **on** in the input record, and **at least one** is **off**.

N

FLD_TM returns True (1) if **at least one of** the bits that are **on** in the mask is **off** in the input record field.

Example 1

Test the third byte of the input record and, if the low order bit is set, overlay a hex FF into the second byte of the output record.

```
If FLD_TM(3, '01'x) Then Do
  OVLY_OUT('ff'x, 2, 1)
Return
End
Return 'DROP'
```

Example 2

Test the third byte of the input record and if some of the three high order bits are set, and some are not, overlay the contents of the second byte of that record with a hex 04.

```
If FLD_TM(3,'11100000'b,M) Then Do
  OVLY_OUT('04'x,2,1)
```

Example 3

Test the current INPOS position of the input record and, if the low order bit is set, overlay a hex FF into the byte prior to this location in the output record.

```
If FLD_TM(P0,'01'x) Then Do
  OVLY_OUT('ff'x,IN1,1)
  Return
End
Return 'DROP'
```

FLD_TYPE

Figure 500. Syntax

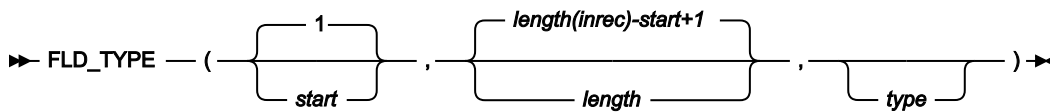

Note: Commas following the last specified argument can be omitted.

Can be used in FASTREXX condition expressions.

Tests the data type of a field in the input record.

Returns

Returns 1 if the test evaluates as True, and 0 if the test evaluates as False.

start

Position, in bytes, in the input record at which to start testing. Can be specified as:

Absolute position

Must be a positive integer. Default value is 1. If *start* is greater than the current length of the input record, the function has no effect.

Relative to current INPOS

Can be specified as IPx or INx, or as Px or Nx. If this resolves to a value of less than or equal to zero, the function results in an error. If this resolves to a value that is greater than the current length of the input record, the function has no effect.

Relative to current OUTPOS

Must be specified as OPx or ONx. If this resolves to a value of less than or equal to zero, the function results in an error. If this resolves to a value that is greater than the current length of the input record, the function has no effect.

length

Length of the field in the input record.

- For packed decimal fields, if you specify the length, it must be in the range 1-16. If you omit the length, FLD_CO attempts to determine the packed field length from the record data.
- For zoned decimal fields, if you specify the length, it must be in the range 1-31 or, if the field contains a separate sign character, in the range 1-32. If you omit the length, it defaults to the remainder of the record. A value of 0 also indicates that the field extends to the end of the record.

type

Data type to test for.

P

FLD_TYPE returns 1 if the field is a valid packed decimal field. Variant sign values (such as 'f'x for positive) are considered valid. Returns 0 otherwise.

Z

FLD_TYPE returns 1 if the field is a valid zoned decimal field. FLD_TYPE recognizes all of the COBOL external decimal variants as numeric data. Returns 0 otherwise.

Example 1

If the first three bytes of the current input record contain a valid packed decimal number, tally the field. Otherwise, tally the first two bytes as a binary number.

```
If FLD_TYPE(1,3,P) Then
  TALLY(1,3,P,'Tally packed')
Else
  TALLY(1,2,B,'Tally binary')
```

Example 2

If the three bytes starting at the current INPOS in the input record contain a valid packed decimal number, copy the three bytes to the end of the output record. Otherwise, copy the two bytes starting at INPOS to the end of the output record.

```
If FLD_TYPE(P0,3,P) Then
  FLD_OUT(P0,3,P0,3)
Else
  FLD_OUT(P0,2,P0,2)
```



Note: In this example, the abbreviated form of the relative position specification can be used in both arguments of the FLD_OUT function. This is because *i_start* naturally targets the input record and *o_start* naturally targets the output record.

FLDI

Figure 501. Syntax

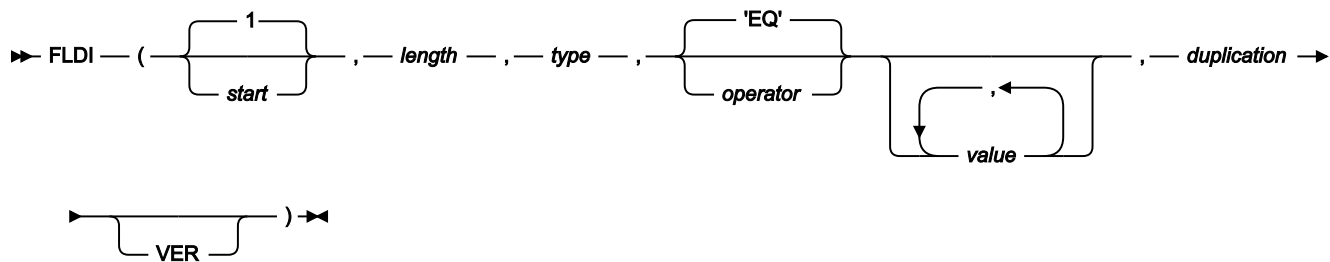

Can be used in FASTREXX condition expressions.

Performs a conditional test against input record field defined in by the start length and type parameters.



Note:

1. The operator (*operator*), and non-numeric values should all be enclosed in quotation marks to avoid syntax errors.
2. If you specify a value for *length* that would cause the record length to be exceeded, a false result is returned.
3. If you specify a numeric type (types B, P, Z), and the specified field contains invalid data for that type, then the function returns a false result. Numeric data is always returned in integer form; that is, the function does not perform scaling of numeric data.

start

Position in bytes, in the input record at which to start reading the field value. Can be specified as:

Absolute position

Must be a positive integer. If *start* is greater than the current length of the input record, the function has no effect.

Relative to current INPOS

Can be specified as IPx or INx, or as Px or Nx. If this resolves to a value of less than or equal to zero, the function results in an error. If this resolves to a value that is greater than the current length of the input record, the function produces a false result.

Relative to current OUTPOS

Must be specified as OPx or ONx. If this resolves to a value of less than or equal to zero, the function results in an error. If this resolves to a value that is greater than the current length of the input record, the function produces a false result.

length

The length of the field in bytes.

- For binary fields, you must specify the length. It can be 2, 4, or 8.
- For character fields, if you omit the length, the length is defaulted:
 - For contains type operators, to the rest of the input record.
 - When all values are variable substitutions, to the rest of the input record.
 - Otherwise, the maximum literal value length is be used.
- For packed decimal fields, if you specify the length, it must be in the range 1–16. If you omit the length, the function attempts to determine the packed field length from the record data and returns only that field.
- For zoned decimal fields, if you specify the length, it must be in the range 1–31 or, if the field contains a separate sign character, in the range 1–32. If you omit the length, the function returns the remainder of the record. If this exceeds 32, then the function returns a false result.

type

The data type of the field. Valid values are:

B

Binary. The function interprets binary fields as being signed.

C

Character. This is the default.

P

Packed decimal.

U

Interprets the field as character, but converts it to uppercase before returning the string.

Z

Zoned decimal. Interprets all of the COBOL external decimal variants as numeric data.

operator

The default is EQ or =. This function supports all the operators described for dynamic template and criteria edit. For details about the operators supported and their description, see:

- [Dynamic Template panel on page 845.](#)
- [Record Identification Criteria panel on page 982.](#)
- [Record Selection Criteria panel on page 991.](#)

value

The value or values entered must be valid in the context of the operator and the field which is being referenced. For example, only certain operators like CO (contains) allow multiple values. Numeric values should be entered when testing numeric fields, and so on.

- Specifying hexadecimal strings. A hexadecimal string must be in the form 'hhhhh'h'. The value enclosed in quotation marks must be an even number of characters and contain valid hexadecimal characters (0–9, A–F).
- Specifying binary strings. A binary string must be in the form 'nnnnn'b'. The value enclosed in quotation marks must be a combination of "0"s and "1"s.
- Specifying character strings. For non-numeric types, the value should be enclosed in quotation marks.
- Specify a variable by specifying &variable_name. A variable is substituted for the value if a matching character, numeric, or tally variable can be located. If a matching variable cannot be found, the string is treated as a literal value. If a numeric comparison is being performed, a character variable is converted to a number - if the conversion fails, the function returns a false result. If a numeric or tally variable is referenced in a character comparison, then the value is the number converted to its display form with leading zeros removed.

duplication

Specify an integer *n* to duplicate the literal value *n* times.



Note: This can only be used for operators that support a single value (for example, Not contains) and where the value is a literal constant and not a substitute variable.

VER

Verify the field is composed only of characters specified in the value column.

Example 1

Check the input record and process only those records that contain values of 'Smith' or 'Jones'.



Note: In this case, use operator CU so the contains processing is not case-sensitive.

```
if FLDI(1,,C,'CU','Smith','Jones') then
  return
else
  return 'DROP'
```

Example 2

Process all records with a salary greater than 75000, where salary is a packed decimal value found at start position 28.



Note: In this case, allow File Manager to calculate the packed decimal field length

```
if FLDI(28,,P,'>',75000) then
  return
else
  return 'DROP'
```

Example 3

Process all input records with the value 'ABCABCABCABC' at start position 10.



Note: The length defaults to 15, the literal value length.

```
If FLDI(10,'=', 'ABC',5) then
  return
else
  return 'DROP'
```

Example 4

The same as Example 2, but using a numeric variable.

```
SETN(salary_high,75000)
if FLDI(28,,P,'>', '&salary_high') then
  return
else
```

FLDO

Figure 502. Syntax

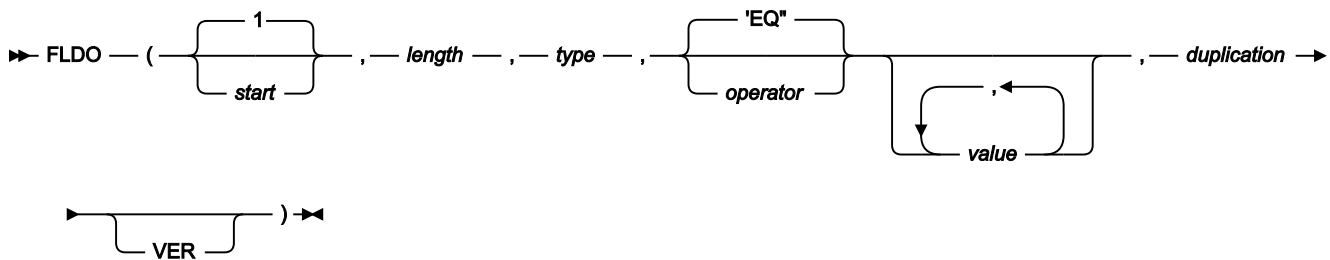

FLDO is the same as FLDI except it tests the current output record.

I_LENGTH

Figure 503. Syntax



Can be used in FASTREXX condition expressions.

Returns the length, in bytes, of the input record.

Example 1

Write only records with a length of 100 to the output file DD100.

```
If i_length() = 100 Then
  WRITE('DD100')
```

MOD_DATE

Figure 504. MOD_DATE syntax - with template

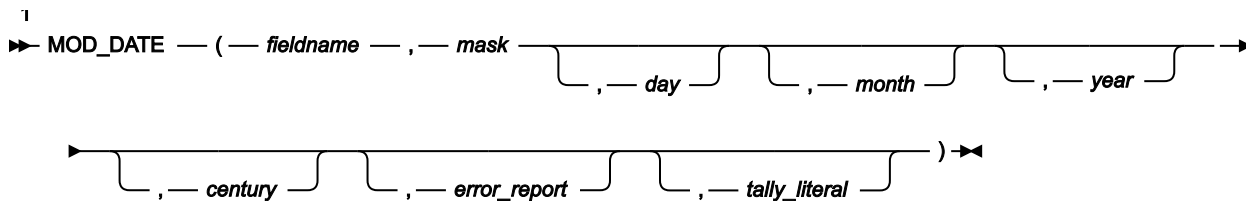

Notes:

- ¹ At least one of these parameters (*day*, *month*, *year*) must be specified.

Figure 505. MOD_DATE syntax - without template

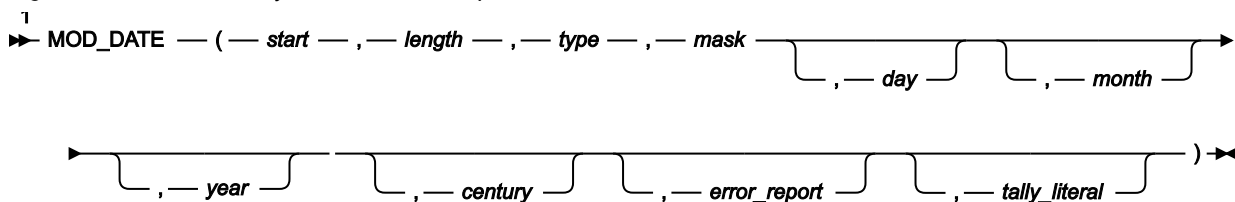

Notes:

- ¹ At least one of these parameters (*day*, *month*, *year*) must be specified.

(Can be used in FASTREXX procedures.)



Note:

1. Only modifies valid dates. Input and modified dates must range between and include 15 October 1582 to 31 December 9999.
2. Commas following the last specified argument can be omitted.

MOD_DATE can be run with or without a template and enables you to set, increment, or decrement a date field using year.month and day values. The *fieldname* or location parameters (*start*, *length*, *type*), the *mask* parameter and at least one of the *year* or *month* or *day* values must be specified for the function call to be valid. The input value is taken from the current output buffer and the modified value is stored in the output buffer.

fieldname

A template is required with this form and the name you specify must match a field name in the template. For non-unique names, you can specify a name in the form *groupname.dataname*. Name matching is not case-sensitive. If the name is unqualified, then the first occurrence of the name is used. For dimensioned fields, you can refer to an individual array element by providing a suffix subscript in the form (*nn*), where *nn* is a valid subscript for the dimensioned field. If you do not provide a subscript, the function applies to all elements of the array.

**Note:**

1. If you are running a copy process and you have specified an input and output template, then the field name must be defined to both input and output templates.
2. If you are copying multiple record layouts, the MOD_DATE function applies to records that have been identified as the record layout which contains this field.

start

Position, in bytes, in the input record at which to start reading the field value. Can be specified as:

Absolute position

Must be a positive integer. Default value is 1. If *start* is greater than the current length of the input record, the function has no effect.

Relative to current INPOS

Can be specified as IPx or INx, or as Px or Nx. If this resolves to a value of less than or equal to zero or greater than the current length of the input record, the function has no effect.

Relative to current OUTPOS

Must be specified as OPx or ONx. If this resolves to a value of less than or equal to zero or greater than the current length of the input record, the function has no effect.

length

The length of the field in bytes.

For binary fields, either omit the length or specify 4.

For packed decimal fields, if you specify the length, it must be in the range 1–16. If you omit the length, MOD_DATE attempts to determine the packed field length from the record data and returns only that field.

type

The data type of the field. Valid values are:

B

Binary.

C

Character. This is the default.

P

Packed decimal.

mask

Picture string describing the date. File Manager supports all pictures described in the *z/OS® Language Environment® Programming Services*, Appendix B, "Date and time services tables". In addition to those masks, File Manager supports CYYDDD to handle old century value Julian dates. A "C" value of "0" is interpreted as "19", and a "C" value of "1" is interpreted as "20". By default, 2-digit years lie within the 100-year range starting 80 years prior to the system date covered by the LE masks. The default range is changed by specifying the *century* parameter.



Note: If date and time attributes are defined in the template for *fieldname* the *mask* parameter can be omitted. File Manager uses the internal date format defined in the template.

day

Day adjustment.

month

Month adjustment.

year

Year adjustment.

The *day*, *month*, and *year* adjustment values can set, increment, and or decrement the respective value in the date field. The presence of a plus or minus symbol indicates the number provided is to *increment* or *decrement* the current value. The absence of plus or minus symbols indicates the number is to *replace* the current value. If the first non-blank character is an asterisk, then the current day, month, or year value is used to set the current value, otherwise it is derived from the record. For the *month* value or *year* value, you can suffix the value with an "E" to indicate end of month adjustment. If the input date is the end of month, then the resultant date is the end of month, unless day arithmetic is also performed.

Here are examples showing how to code them:

```
'*+10'
```

Sets the current day, month, or year and adds 10 to it.

```
'*-10'
```

Sets the current day, month, or year and subtracts 10 from it.

```
'+10'
```

Adds 10 to the current value found on the record.

`'-10'`

Subtracts 10 from the current value found on the record.

`'+3E'`

Adds 3 months and make adjustments for end of month if required.

`'22'`

Sets the respective day, month, or year value to 22.



Note: If you specify the symbols "*", "+", or "-", you must code the value in quotation marks.

Month and Year Arithmetic:

If input date is the last day of the month and you specify "E" as the suffix on the month or year value, or if the resulting month has fewer days than the day component of the input date, the result is the last day of the resulting month. Otherwise, the result has the same day component as input date.

Here are some examples:

- Assume today is January 31, 2007. Adding one month results in the end of February, 2007-02-28.
- "+3E" is specified for *month*, and the input date is February 28th 2007. The result is May 31st 2007.
- "+3" is specified for *month*, and the input date is February 28th 2007. The result is May 28th 2007.

century

Specify a value between 0 and 100 to be used to define the 100-year range to interpret a 2-digit year. The default value is 80 years prior to the system date. Use this parameter to adjust that value.

error_report

Specify "Y" if you want to produce error messages when the function cannot modify a date because either the input or resultant date is invalid. The default is to ignore such dates.

tally_literal

Specify a literal to appear on a tally report that counts every successful operation of the function.

Examples

This COBOL copybook describes an input record with different date formats and is used here to illustrate MOD_DATE usage with a template or copybook.

```
01 DATE-REC.
  03 DATE-YYYYMMDD          pic x(8).
  03 DATE-MM-DD-YYYY        pic x(10).
  03 DATE-DD-MM-YYYY        pic x(10).
  03 DATE-YYYYDDD          pic x(7).
  03 DATE-YYYYDDDp         pic 9(7) packed-decimal.
  03 DATE-YYYYMMDDb        pic 9(8) binary.
  03 DATE-CYYDDD           pic 9(6) packed-decimal.
  03 DATE-DDMMYYYY         pic 9(8).
```

```
03 DATE-YYMMDD OCCURS 6 times pic 9(6) packed-decimal.
03 filler pic x.
```

Example 1

Add 60 days to all date fields and report any errors. Note all array fields are modified.

```
$$$FILEM DSC INPUT=DDIN,
$$$FILEM IGNLEN=YES,
$$$FILEM TCIN=hlq.COBOL(SAMPLE),
$$$FILEM OUTPUT=DDOUT,PROC=*
MOD_DATE('DATE-YYYYMMDD','YYYYMMDD','+60',,,Y)
MOD_DATE('DATE-YYYYMMDD','YYYYMMDD','+60',,,Y)
MOD_DATE('DATE-MM-DD-YYYY','MM/DD/YYYY','+60',,,Y)
MOD_DATE('DATE-DD-MM-YYYY','DD/MM/YYYY','+60',,,Y)
MOD_DATE('DATE-YYYYDDD','YYYYDDD','+60',,,Y)
MOD_DATE('DATE-YYYYDDDP','YYYYDDD','+60',,,Y)
MOD_DATE('DATE-CYYDDD','CYYDDD','+60',,,Y)
MOD_DATE('DATE-DDMMYYYY','DDMMYYYY','+60',,,Y)
MOD_DATE('DATE-YYMMDD','YYMMDD','+60',,,Y)
/*
```

Example 2

Same as example 1 without using a copybook.

```
$$$FILEM DSC INPUT=DDIN,
$$$FILEM OUTPUT=DDOUT,PROC=*
MOD_DATE(1,8,C,'YYYYMMDD','+60',,,Y)
MOD_DATE(40,4,B,'YYYYMMDD','+60',,,Y)
MOD_DATE(9,10,C,'MM/DD/YYYY','+60',,,Y)
MOD_DATE(19,10,C,'DD/MM/YYYY','+60',,,Y)
MOD_DATE(29,7,C,'YYYYDDD','+60',,,Y)
MOD_DATE(36,,P,'YYYYDDD','+60',,,Y)
MOD_DATE(44,,P,'CYYDDD','+60',,,Y)
MOD_DATE(48,8,C,'DDMMYYYY','+60',,,Y)
MOD_DATE(56,,P,'YYMMDD','+60',,,Y)
MOD_DATE(60,,P,'YYMMDD','+60',,,Y)
MOD_DATE(64,,P,'YYMMDD','+60',,,Y)
MOD_DATE(68,,P,'YYMMDD','+60',,,Y)
MOD_DATE(72,,P,'YYMMDD','+60',,,Y)
MOD_DATE(76,,P,'YYMMDD','+60',,,Y)
/*
```

Example 3

Add 2 months and 20 days to all date fields and ignore errors.

```
$$$FILEM DSC INPUT=DDIN,
$$$FILEM IGNLEN=YES,
$$$FILEM TCIN=hlq.COBOL(SAMPLE),
$$$FILEM OUTPUT=DDOUT,PROC=*
MOD_DATE('DATE-YYYYMMDD','YYYYMMDD','+20','+2')
MOD_DATE('DATE-YYYYMMDD','YYYYMMDD','+20','+2')
MOD_DATE('DATE-MM-DD-YYYY','MM/DD/YYYY','+20','+2')
MOD_DATE('DATE-DD-MM-YYYY','DD/MM/YYYY','+20','+2')
MOD_DATE('DATE-YYYYDDD','YYYYDDD','+20','+2')
```

```

MOD_DATE('DATE-YYYYDDDP', 'YYYYDDD', '+20', '+2')
MOD_DATE('DATE-CYYDDD', 'CYYDDD', '+20', '+2')
MOD_DATE('DATE-DDMMYYYY', 'DDMMYYYY', '+20', '+2')
MOD_DATE('DATE-YYMMDD', 'YYMMDD', '+20', '+2')
/*

```

Example 4

Set all date field values to the current date plus 1 for year, month, and date. Change the century window used for DATE-YYMMDD field to 60.

```

$$$FILEM DSC INPUT=DDIN,
$$$FILEM IGNLEN=YES,
$$$FILEM TCIN=h1q.COBOL(SAMPLE),
$$$FILEM OUTPUT=DDOUT,PROC=*
MOD_DATE('DATE-YYYYMMDD', 'YYYYMMDD', '+*+1', '+*+1', '+*+1')
MOD_DATE('DATE-YYYYMMDDB', 'YYYYMMDD', '+*+1', '+*+1', '+*+1')
MOD_DATE('DATE-MM-DD-YYYY', 'MM/DD/YYYY', '+*+1', '+*+1', '+*+1')
MOD_DATE('DATE-DD-MM-YYYY', 'DD/MM/YYYY', '+*+1', '+*+1', '+*+1')
MOD_DATE('DATE-YYYYDDD', 'YYYYDDD', '+*+1', '+*+1', '+*+1')
MOD_DATE('DATE-YYYYDDDP', 'YYYYDDD', '+*+1', '+*+1', '+*+1')
MOD_DATE('DATE-CYYDDD', 'CYYDDD', '+*+1', '+*+1', '+*+1')
MOD_DATE('DATE-DDMMYYYY', 'DDMMYYYY', '+*+1', '+*+1', '+*+1')
MOD_DATE('DATE-YYMMDD', 'YYMMDD', '+*+1', '+*+1', '+*+1', '60')
/*

```

NCONTAIN

Figure 506. Syntax

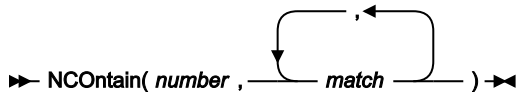

Compares the value represented by *number* against the value or values defined by *match*.

Returns

If the numeric value of any of the *match* arguments is equal to the numeric value of *number*, then NCONTAIN returns 1. Otherwise, NCONTAIN returns 0.

number

The value, represented by a number, a function returning a value or a variable to which a value has been assigned, that you are comparing with *match*.

match

The value or list of values that you are comparing with *number*. You can search for up to 20 values at a time.

For a similar function for matching string values, see [CONTAINS on page 1644](#). For a FASTREXX-eligible equivalent, see [FLD_CO on page 1655](#).

Example 1

If the current record contains a packed decimal value of 10, 20, or 30 starting at column 8, then print the record.

```
If NCO(FLD(8,P),10,20,30) Then PRINT(inrec,'CHAR')
```

Example 2

If the current record contains a zoned decimal value of 11, 12, or 13 starting at column 10, then drop the record from processing.

```
If NCO(FLD(10,5,Z),11,12,13) Then Return 'DROP'
```

O_LENGTH

Figure 507. Syntax

► O_LENGTH — (—) ◄

Can be used in FASTREXX condition expressions.

Returns the length, in bytes, of the output record.

Example 1

If the current length of the output record is 100, overlay the last 20 columns with asterisks.

```
If o_length() = 100 Then
  OVLY_OUT('*',81,20, '*')
```

OFLD_CO

Figure 508. Syntax

► OFLD_CO — (— , — , — , —) ◄

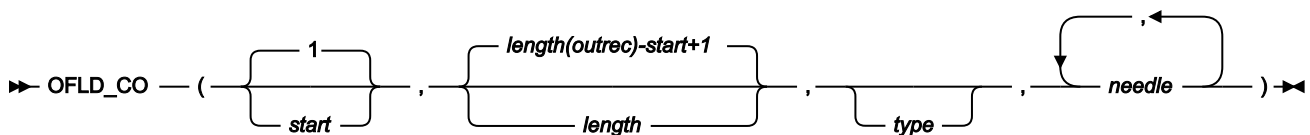

The diagram illustrates the syntax of the OFLD_CO function. It shows the function name followed by four arguments in parentheses, separated by commas. The first argument is labeled 'start' and has a bracket above it with the number '1'. The second argument is labeled 'length' and has a bracket above it with the expression 'length(outrec)-start+1'. The third argument is labeled 'type'. The fourth argument is labeled 'needle' and has a curved arrow above it pointing to the left, indicating a search operation.

(Can be used in FASTREXX condition expressions.)

Searches the field within the output record specified by *start* and *length*, for one or more occurrences of *needle*. On successful execution when searching for a string, also updates the value of OUTPOS to the first byte of the located field in the output record.

Returns

If at least one occurrence of *needle* is found, returns 1. If no occurrences are found, returns 0.

start

Position, in bytes, in the output record at which to start searching for occurrences of *needle*. Can be specified as:

Absolute position

Must be a positive integer. Default value is 1. If *start* is greater than the current length of the output record, the function has no effect.

Relative to current INPOS

Must be specified as IPx or INx. If this resolves to a value of less than or equal to zero, the function results in an error. If this resolves to a value that is greater than the current length of the input record, the function has no effect.

Relative to current OUTPOS

Can be specified as OPx or ONx, or as Px or Nx. If this resolves to a value of less than or equal to zero, the function results in an error. If this resolves to a value that is greater than the current length of the output record, the function has no effect.

length

Length, in bytes, of the field to be searched.

- For character fields, the length defaults to the remaining record length from the start position to the end of the record (inclusive). A value of 0 also indicates that the field extends to the end of the record.
- For binary fields, you must specify the length. It can be 2, 4, or 8.
- For packed decimal fields, if you specify the length, it must be in the range 1-16. If you omit the length, FLD_CO attempts to determine the packed field length from the record data.
- For zoned decimal fields, if you specify the length, it must be in the range 1-31 or, if the field contains a separate sign character, in the range 1-32. If you omit the length, it defaults to the remainder of the record.

type

The data type of the field. Valid values are:

B

Binary. FLD_CO interprets binary fields as being signed.

C

Character. This is the default. The comparison is case sensitive.

P

Packed decimal.

U

Interprets the field as Character, but converts it to uppercase before comparing it with *needle*.

Z

Zoned decimal. Interprets all of the COBOL external decimal variants as numeric data.

needle

String(s) or numeric(s) to search for. For the character types, FLD_CO searches the *haystack* for each of the *needles*. In this context, it behaves like a combination of the FLD and CONTAINS functions. For the numeric data types, the *haystack* is treated as a single numeric field, and an appropriate numeric comparison is

performed against each of the *needles*. In this context it behaves like a combination of the FLD and NCONTAIN functions. You can search for up to 20 strings or numerics at a time.

To perform case-insensitive searches, specify *type* as 'U' and *needle* in uppercase.

Example 1

If the current output record contains "MIKE", "Mike" or "mike" in the first ten columns, then write the record.

```
If FLD_CO(1,10,'U','MIKE') Then WRITE('MDD')
```

Example 2

If the current output record contains "USA", "Australia" or "England", then drop the record from processing.

```
If FLD_CO(,,,'USA','Australia','England') Then Return 'DROP'
```

Example 3

If the current output record contains "MIKE", "Mike" or "mike" in the ten columns immediately after the current INPOS, then write the record.

```
If FLD_CO(P0,10,'U','MIKE') Then WRITE('MDD')
```

OVLY_OUT

Figure 509. Syntax

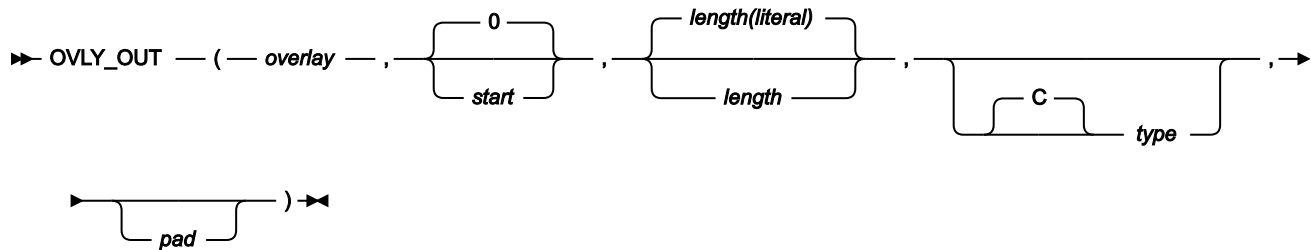

Note: Commas following the last specified argument can be omitted.

Can be used in FASTREXX procedures.

Overlays the output record with a string. If the length of the target field exceeds the length of the literal, the target field is padded to the specified length using the pad character. If the length of the target field is less than the length of the literal, the following occurs:

- Character overlays are truncated on the right without error. For example, `OVLY_OUT('ABCD',1,2)` overlays 'AB'.
- Numeric overlay truncations are considered to be an error. For example, `OVLY_OUT(500000,1,2,'B')` fails because you can't fit the specified value into a 2-byte binary field.

On successful execution, also updates the value of OUTPOS to one byte past the end of the field overlaid in the output record.

Returns

A single blank.

overlay

An expression that resolves to a string, which is overlaid on that part of the output record specified by *start* and *length*. To be eligible for FASTREXX processing, this must be a literal string, a symbol or a blank-delimited sequence of symbols and/or literal strings.

If the first character of the literal is an ampersand and the literal that follows matches an existing character or numeric variable or tally literal (matching not case-sensitive), then the variable value is substituted according to the type. For example, if the type is character and a numeric or tally value are referenced, then the literal is the numeric value in display format with no leading zeros. If the type is binary, packed or zoned, then the variable value is converted to binary, packed or zoned number.



Note:

1. Conversion errors may occur when converting a character variable to a numeric.
2. If a variable name is not found, then the string is interpreted as a literal.

start

Position, in bytes, in the output record at which to start overlaying the string. If you omit *start*, specify zero, or specify a value one greater than the length of the current output record, the field is appended to the end of the output record. If *start* is greater than the current length of the output record, the record is padded with the specified or defaulted pad character from the current record length to the specified start position. Can be specified as:

Absolute position

Must be a non-negative integer that is less than or equal to the maximum length of the output data set. Default value is 0.

Relative to current INPOS

Must be specified as IPx or INx. Must resolve to a non-negative integer.

Relative to current OUTPOS

Can be specified as OPx or ONx, or as Px or Nx. Must resolve to a non-negative integer.

length

Length, in bytes, of target field in the output record. Defaults as shown here:

Character fields

Defaults to the length of the literal. A value of 0 indicates that the target field length is the greater of the source (literal) length and the remaining record length. In particular, if 0 is specified for both start and length, then the length of the literal is used as the target length.

Packed decimal

Defaults to the last packed length value determined from the input record by a preceding function. For example,

```
if FLD(1,P) = 2 then
  OVLV_OUT('5',1,,P)
```

Uses the length determined by the FLD function to default the packed decimal length. If no previous packed decimal length was calculated, a length error occurs and the procedure is terminated.

type

The data type of the literal to be written to the output record.

B

Binary. The literal string must represent a positive or negative integer, and is stored in the output field as a signed two's-complement format binary number, right-justified in the target field. The length must be 2, 4, or 8, and cannot be omitted.

C

Character. This is the default.

P

Packed decimal. The literal string must represent a positive or negative integer, and is stored right-justified in the target field as a signed packed decimal number using the preferred positive ('c'x) and negative ('d'x) sign indicators. The length must be between 1 and 16.

Z

Zoned decimal (COBOL external decimal with non-character trailing sign). The literal string must represent a positive or negative integer, and is stored in the output field as a signed zoned decimal number. The length must be between 1 and 31.

pad

Pad character. Defaults to the pad character set on the File Manager System Processing Options panel. If the current pad setting is OFF, the default pad character is a blank. For numeric types such as B, P or Z, the pad character is not used when pre-fill characters are required to right-justify a numeric field. The pre-fill characters are always leading zeros, as required by the field type."

See FLD_OUT for a function to overlay the output record with a field from the input record.

Example 1

Set columns one and two of the output record to asterisks.

```
OVLY_OUT('**',1,2)
```

Example 2

Append the two-byte packed decimal value 2 to the end of the output record.

```
OVLY_OUT(2,0,2,P)
```

Example 3

Search the input record for a literal and then overlay the last two bytes of that literal with a new literal in the output record.

```
If FLD_CO(1,,C,'AABB') Then
  OVLY_OUT('CC',IP2,2)
```

OVLY_VAR

Figure 510. Syntax

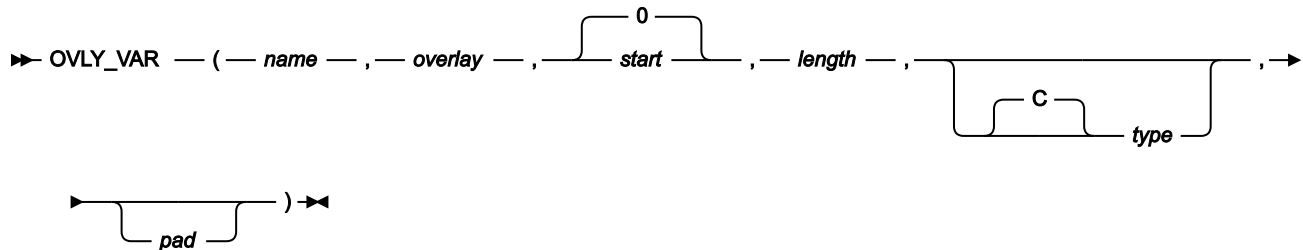

(Can be used in FASTREXX procedures.)



Note: Commas following the last specified argument can be omitted.

Overlays the named character variable with a string. If the length of the target field exceeds the length of the literal, the target field is padded to the specified length using the pad character. If the length of the target field is less than the length of the literal:

- Character overlays are truncated on the right without error. For example, `OVLY_VAR(MYVAR, 'ABCD', 1, 2)` overlays 'AB'.
- Numeric overlay truncations are considered to be an error. For example, `OVLY_VAR(MYVAR, 500000, 1, 2, 'B')` fails because you cannot fit the specified value into a 2-byte binary field.

On successful execution, also updates the value of current variable position to one byte past the end of the field overlaid in the variable.

Returns

A single blank.

name

1–256 character variable identifier. Variable name matching is not case sensitive. If the name is not found, a severe error occurs and the procedure is terminated. Cannot be a system character variable or a system numeric variable. See [Using FASTREXX variables on page 1631](#).

overlay

An expression that resolves to a string, which is overlaid on that part of the variable specified by *start* and *length*. To be eligible for FASTREXX processing, this must be a literal string, a symbol, or a blank-delimited sequence of symbols or literal strings. If the first character of the literal is an ampersand and the literal that follows matches an existing character, numeric variable, or tally literal (matching not case-sensitive), then the variable value is substituted according to the type. For example, if the type is character and a numeric or tally value are referenced, then the literal is the numeric value in display format with no leading zeros. If the type is binary then the variable value is converted to a binary number.



Note: Conversion errors may occur.

start

Position, in bytes, in the variable at which to start overlaying the string. If you omit *start*, specify zero, or specify a value one greater than the length of the current variable, the field is appended to the end of the variable. If *start* is greater than the current length of the variable, the record is padded with the specified or defaulted pad character from the current variable length to the specified start position. Can be specified as:

Absolute position

Must be a non-negative integer that is less than or equal to the maximum length of the output data set. Default value is 0.

Relative to current variable position

Must be specified as IPx or Inx, OPx or ONx, or as Px or Nx. Must resolve to a non-negative integer.

length

Length, in bytes, of target field in the variable. Defaults:

Character fields

To the length of the literal. A value of 0 indicates that the target field length is the greater of the source (literal) length and the remaining variable length. In particular, if 0 is specified for both *start* and *length*, then the length of the literal is used as the target length.

Packed decimal

To the last packed length value determined from the input record by a preceding function. For example:

```
if FLD(1,P) = 2 then
  OVLY_VAR(MYVAR, '5',1,,P)
```

Uses the length determined by the FLD function to default the packed decimal length. If no previous packed decimal length was calculated a length error occurs and the procedure is terminated.

type

The data type of the field. Valid values are:

B

Binary. FLD_CO interprets binary fields as being signed.

C

Character. This is the default. The comparison is case sensitive.

P

Packed decimal.

U

Interprets the field as Character, but converts it to uppercase before comparing it with *needle*.

Z

Zoned decimal. Interprets all of the COBOL external decimal variants as numeric data.

pad

Pad character. Defaults to the pad character set on the File Manager System Processing Options panel. If the current pad setting is OFF, the default pad character is a blank. For numeric types such as B, P, or Z, the pad character is not used when pre-fill characters are required to right-justify a numeric field. The pre-fill characters are always leading zeros, as required by the field type.

Example 1

Set columns one and two of the variable to asterisks.

```
OVLV_VAR(MYVAR, '**', 1, 2)
```

Example 2

Append the two-byte packed decimal value 2 to the end of the variable.

```
OVLV_VAR(MYVAR, 2, 0, 2, P)
```

Example 3

Search the variable for a literal and then overlay the last two bytes of that literal with a new literal in the variable.

```
If TESTC(MYVAR, 'CU', 'AABB') Then
  OVLV_VAR(MYVAR, 'CC', IP2, 2)
```

PRINT

Figure 511. Syntax

▶▶ PRINT(*record* ,*format*) ▶▶

Prints the *record* string in the specified *format*. The print output destination depends on how the procedure is invoked:

From an online panel:

The print output destination is determined by the value of the PRINTOUT field on the **Set Print Processing Options** panel.

From a batch job:

By default, report output is written to SYSPRINT. Sections of the output can be directed instead to the following ddnames:

FMNROPT

File Manager active options

FMNRPRM

\$\$FILEM command parameters and return codes

FMNRPRC

REXX procedure statements read from SYSIN

FMNREPT

Command reports and return codes

FMNRSUM

TALLY summary report

If FMNPRINT is present in the JCL, it is used instead of SYSPRINT.

From a REXX program:

The print output destination is determined by the PRINTOUT parameter of the SET function.

Returns

0

Function was successful.

4

Function was unsuccessful and the record is not printed because either:

- A *format* of SNGL or TABL was specified and File Manager cannot determine the record type.
- A template has been specified and the record did not pass the selection criteria.

12

Function was unsuccessful and the record is not printed because either:

- You did not provide parameters.
- A *format* of SNGL or TABL was specified, but no template or copybook was provided

record

Any string or variable representing a string can be used, however, INREC or OUTREC are most commonly used in this function.

format

Can be CHAR, HEX, SNGL or TABL. If you specify TABL or SNGL format:

- On the function or panel that you are enhancing, you must specify a copybook or template that describes the record type to be printed.
- File Manager determines the type of the record to be printed by comparing its length with the record types in the template, and also by using any record identification criteria in the template.
- If you are using PRINT with DSC or the Copy Utility (option 3.3) and you have specified both an input and an output copybook or template, the copybook or template used to format the printed record is determined as follows: if the value of the record to be printed matches the input record (INREC variable), the input copybook or template is used; otherwise, the output copybook or template is used.

Ensure that the record value matches the template that File Manager uses to print the data set.

- Only those fields that have been selected in the template are printed.
- If the record has been reformatted by template processing, the variable INREC contains the input record value and OUTREC contains the reformatted output record.



Note: Avoid using PRINT in a REXX procedure for a:

- DSP function
- FCH function
- Print Utility (option 3.2)

because output from PRINT is interspersed with their normal output, which can be confusing. Using PRINT in a REXX procedure that runs from the Find/Change Utility panel (option 3.6), does not result in this problem, because the report produced by the panel is sent to a data set, separate from print output.

Example 1

Print the first hundred records.

```
If PRTCOUNT() < 100 Then PRINT(inrec,'CHAR')
```

Example 2

Print the current input record in TABL format.

```
rc = PRINT(inrec,'TABL')
```

PRTCOUNT

Figure 512. Syntax

► PRTCOUNT() ◄

Can be used in FASTREXX condition expressions.

Returns the current count of records printed. The count is incremented for each record printed by the DSP function or Print Utility (option 3.2), and for each invocation of the PRINT function.

Example

Print the first 10 input records.

```
If PRTCOUNT() < 10 Then PRINT(inrec,'CHAR')
```

PRT_IN

Figure 513. Syntax

► PRT_IN(*format* ,*count*) ◄

Can be used in FASTREXX condition expressions.

Prints the input record in the format specified.

format

Format in which the input record is to be printed. Valid values are: CHAR, HEX, SNGL, or TABL.

If you specify TABL or SNGL format:

- On the function or panel that you are enhancing, you must specify a copybook or template that describes the record type to be printed.
- File Manager determines the type of the record to be printed by using the record identification criteria if present, or by comparing its length with the record types in the template.
- When using PRT_IN with DSC or the Copy Utility (option 3.3) and you have specified both an input and an output copybook or template, the copybook or template used to format the printed record is the output template.
- Only those fields that have been selected in the template are printed.

count

FASTREXX only. The maximum number of times this function will be performed. The default is no limit.



Note: Avoid using PRT_IN in a REXX procedure for:



- DSP function
- FCH function
- Print Utility (option 3.2)

Output from PRT_IN is interspersed with the normal output (from DSP, FCH, or Print) which can be confusing.

Using PRT_IN in a REXX procedure that runs from the Find/Change Utility panel (option 3.6) does not result in this problem because the report produced by the panel is sent to a data set, separate from print output.

Example

Print the first 5 records in hex format and print the remainder in tabular format.

```
PRT_IN('HEX',5)
If recsin() > 5 then PRT_IN('TABL')
```

PRT_OUT

Figure 514. Syntax

► PRT_OUT(*format* ,*count*) ◀

Can be used in FASTREXX condition expressions.

Prints the output record in the format specified.

format

Format in which the output record is to be printed. Valid values are: CHAR, HEX, SNGL, or TABL.

If you specify TABL or SNGL format:

- On the function or panel that you are enhancing, you must specify a copybook or template that describes the record type to be printed.
- File Manager determines the type of the record to be printed by using the record identification criteria if present, or by comparing its length with the record types in the template.
- When using PRT_OUT with DSC or the Copy Utility (option 3.3) and you have specified both an input and an output copybook or template, the copybook or template used to format the printed record is the output template.
- Only those fields that have been selected in the template are printed.

count

FASTREXX only. The maximum number of times this function will be performed. The default is no limit.



Note: Avoid using PRT_OUT in a REXX procedure for:



- DSP function
- FCH function
- Print Utility (option 3.2)

Output from PRT_OUT is interspersed with the normal output (from DSP, FCH, or Print) which can be confusing.

Using PRT_OUT in a REXX procedure that runs from the Find/Change Utility panel (option 3.6) does not result in this problem because the report produced by the panel is sent to a data set, separate from print output.

Example

Print the first 5 records in hex format and print the remainder in tabular format.

```
PRT_OUT('HEX',5)
If recsin() > 5 then PRT_OUT('TABL')
```

PRT_VAR

Figure 515. Syntax

► PRT_VAR(*name* ,*format* ,*count*) ◄

Can be used in FASTREXX condition expressions.

Prints the specified variable in the format specified.

name

The name of the variable to be printed. This must be the name of an existing character variable.

format

Format in which the output record is to be printed. Valid values are: CHAR, HEX, SNGL, or TABL.

If you specify TABL or SNGL format:

- On the function or panel that you are enhancing, you must specify a copybook or template that describes the record type to be printed.
- File Manager determines the type of the variable (record) to be printed by using the record identification criteria if present, or by comparing its length with the record types in the template.
- When using PRT_VAR with DSC or the Copy Utility (option 3.3) and you have specified both an input and an output copybook or template, then the copybook or template used to format the printed variable is the input template for any variable other than ZOUTREC. ZOUTREC is formatted with the output record.
- Only those fields that have been selected in the template are printed.

count

FASTREXX only. The maximum number of times this function will be performed. The default is no limit.



Note: Avoid using PRT_VAR in a REXX procedure for:



- DSP function
- FCH function
- Print Utility (option 3.2)

Output from PRT_VAR is interspersed with the normal output (from DSP, FCH, or Print) which can be confusing.

Using PRT_VAR in a REXX procedure that runs from the Find/Change Utility panel (option 3.6) does not result in this problem because the report produced by the panel is sent to a data set, separate from print output.

Example

Print the first 5 records in hex format and print the remainder in tabular format.

```
PRT_VAR('ZINREC','HEX',5)
If recsin() > 5 then PRT_VAR('ZINREC','TABL')
```

RECCUR (DSEB only)

Figure 516. Syntax

► RECCUR() ◀

(Can be used in FASTREXX procedures.)

Returns the current record number.

Example

If the current record is the hundredth record in the file, then print it.

```
If RECCUR() = 100 Then PRINT(inrec,'CHAR')
```

RECSIN

Figure 517. Syntax

► RECSIN() ◀

Can be used in FASTREXX condition expressions.

Returns the count of records read so far from the input data set. When the input data set is a PDS, the RECSIN count restarts for each member being processed.

When used with DSEB, RECSIN returns the record number of the furthest record read so far in the data set. (For example, if you have moved down as far as record number 500 in the data set, then you move up to a previous record, RECSIN still returns 500 after moving up.)

Example

Print every hundredth record.

```
IF RECSIN(//100 = 0 Then PRINT(inrec,'CHAR')
```

RECSOUT

Figure 518. Syntax

► **RECSOUT(*ddname*)** ◀

Notes:

¹ When used with a DSC or DSP function, *ddname* is optional.

Can be used in FASTREXX condition expressions.

Returns the count of records so far written to the specified output data set.

The argument you can specify is:

ddname

Specifies that the count of records so far written to the data set identified by the specified *ddname* be returned. If *ddname* is omitted when used with a DSC or DSP function, the default is the *ddname* of the primary output data set. The primary output data set depends on the File Manager function or panel being used:

Function or panel option	Primary output data set is...
Print Utility (option 3.2)	Determined by the value of the PRINTOUT field on the Set Print Processing Options panel. For details, see Printing from File Manager on page 402 .
DSC function Copy Utility (option 3.3)	The data set that is the target of the copy function.
DSP function	When used in a batch job, the primary output data set is SYSPRINT. When used in a REXX procedure, the primary output data set is determined by the PRINTOUT parameter of the SET function. For details, see SET (Set Processing Options) on page 1550 .

Specifying the *ddname* of the primary output data set is the same as omitting the argument.

If you specify a *ddname* that is not the *ddname* of the primary output data set and has not previously been specified as the argument to a WRITE function, the value returned is zero.

The count of records written to an output data set is incremented each time a WRITE function is issued against the specified data set. In the case of the primary output data set, the count is also incremented each time a record is written to the data set by the File Manager function. Unless a record is discarded using the RETURN DROP (or STOP IMMEDIATE) instruction, each record selected for processing is written to the primary output data set. For information about how to discard records, see [RETURN return values on page 1714](#).



Note: The RECSOUT function treats each member of the primary output data set as separate, that is, the count starts at zero for each output member. However, the count is maintained across members of the input data set so that, if copying from a PDS to a sequential data set, the RECSOUT function reflects the total number of records written, regardless of how many input members are involved.

If you are using the DSC function or Data Copy Utility and you have specified REXX member selection, the RECSOUT function is disabled for the primary output data set. When RECSOUT targets a *ddname* other than the primary output data set, it still functions as normal. However, you must keep in mind that after a decision has been made to DROP or PROCESS the member, no further records are passed to your REXX procedure, so subsequent records are not counted.

Example 1

If more than one hundred records have been written to the EXT100 file, then terminate File Manager processing.

```
rc = WRITE(EXT100)
If RECSOUT(EXT100) > 100 Then Return 'STOP'
```

RSTR_OUT

Figure 519. Syntax

►► RSTR_OUT() ◄◄

(Can be used in FASTREXX condition expressions.)

Restores the most recently saved copy of the output buffer.

There are no synchronization restrictions. The SAVE_OUT() invocation that a RSTR_OUT() invocation is “reversing” could have occurred for the current record, or any previously processed record.

There is no stacking of saved output buffers. If RSTR_OUT() is invoked twice in succession, then the second invocation restores the same data as the first.

If RSTR_OUT() is invoked without a prior invocation of SAVE_OUT(), then the output buffer is “cleared”. The effect is the same as executing SET_OLEN(0).

SAVE_OUT

Figure 520. Syntax

►► SAVE_OUT() ◄◄

(Can be used in FASTREXX condition expressions.)

Saves a copy of the current output buffer.

There are no synchronization restrictions. The SAVE_OUT() invocation that a RSTR_OUT() invocation is “reversing” could have occurred for the current record, or any previously processed record.

There is no stacking of saved output buffers. If `SAVE_OUT()` is invoked twice in succession, then the data saved by the first invocation is lost.

SEGCNT

Figure 521. Syntax

►► `SEGCNT(field_name)` ◄◄

Can only be used in criteria for a segmented template.

Returns the number of previous occurrences of the segment identified by the parameter, *field_name*. The default value of 0 is returned if used with non-segmented processing.

field_name

Must be a valid 01 name in the template being used.

For example, if SEG-A occurs the number of times specified in the header field SEG-NUM-A, the RID criteria shown in [Figure 522: SEGCNT example on page 1689](#) can be used to identify SEG-A.

Figure 522. SEGCNT example

```

:
File Manager      Related Id expression for SEG-A                               Line 1 of 5
----- Criteria - Enter 0 to specify related ID expression by field -----
0 Rid: segcnt('seg-a') < #2
Offset 0          Enter "/" to OR with related ID
Cmd Seq SHE Ref  Field Name          Picture  Type Start Length
          **** Top of data ****
          1 1 SEG-HDR                    AN       1     4
          2 2 SEG-NUM-A                 9        ZD     1     1
          3 2 SEG-NUM-B                 9        ZD     2     1
          4 2 SEG-NUM-C                 9        ZD     3     1
          5 2 SEG-NUM-D                 9        ZD     4     1
          **** End of data ****
:

```

SEGLLEN

Figure 523. Syntax

►► `SEGLLEN(field_name)` ◄◄

Can only be used in criteria for a segmented template.

Returns the length in the associated field name. This result is used as the segment length for the identified segment if the value is greater than zero.

field_name

Must be a valid field name for the current layout.



Note:



1. The field name is converted to a full word positive integer.
2. If the field is alphanumeric then it is assumed to contain a binary value. If it is longer than 4 bytes then the rightmost 4 bytes are used to obtain the binary value.
3. The last value returned by the SEGLEN function in successful identification criteria is used as the segment length. This takes precedence over the specification of a segment length field in a template definition.

For example, Consider the excerpt from an XML template with identification criteria for a section of the SMF 30 record SMF30PSS. The length of the section is in the header section SMFRCD30 field SMF30SLN. When the identification criteria for section SMF30PSS is satisfied the segment length is set to the value contained in the header field SMF30SLN.

```
<layout name="SMFRCD30" offset="-4">
  <criteria type="RID" rname="SMF30PSS">
    <exp><![CDATA[
      segcnt('smf30pss') < #SMF30SON &
      segoff(4) >= #SMF30SOF &
      seglen('SMF30SLN') > 0
    ]]></exp>
  </criteria>
</layout>
```

SEGOFF

► SEGOFF(*adjustment*) ◄

Can only be used in criteria for a segmented template.

Returns the current offset into the record during segmented identification processing.

adjustment

Default 0. This is a positive or negative number that is added to the offset value returned.

For example, consider the excerpt from an XML template with identification criteria for a section of the SMF 30 record SMF30PSS. The offset to the section is in the header section SMFRCD30 field SMF30SOF. We use related identification criteria with an adjustment of 4 because the header section includes the RDW which File Manager does not include when processing data. The header section is defined with an offset of minus 4 and we use SEGOFF(4) to adjust current offset in File Manager processing by 4 so the returned value can be compared with the offset value contained in the SMF30SOF field.

```
<layout name="SMFRCD30" offset="-4">
  <criteria type="RID" rname="SMF30PSS">
    <exp><![CDATA[
      segcnt('smf30pss') < #SMF30SON &
      segoff(4) >= #SMF30SOF &
      seglen('SMF30SLN') > 0
    ]]></exp>
  </criteria>
</layout>
```

SEGNO

Figure 524. Syntax

➔ SEGNO() ➔

Can only be used in criteria for a segmented template.

This function has no parameters and returns a numeric value representing the current segment number. It is only relevant when running with a segmented template. The default value of 1 is returned if used with non-segmented processing.

Figure 525: SEGNO example on page 1691 shows header or first segment identification criteria.

Figure 525. SEGNO example

```

:
File Manager                Field Selection/Edit                Line 1 of 5
---Criteria - Enter 0 - Related ID expression, 1 or 2 - expression by field---
0 Rid: _____ +
1 Id : segno()=1 _____ +
2 Sel: _____ +
Offset 0 Enter "/" to OR with related ID
Cmd Seq SHE Ref  Field Name      Picture  Type Start Length
          **** Top of data ****
          1 1 SEG-HDR              AN       1     4
          2 2 SEG-NUM-A          9        ZD       1     1
          3 2 SEG-NUM-B          9        ZD       2     1
          4 2 SEG-NUM-C          9        ZD       3     1
          5 2 SEG-NUM-D          9        ZD       4     1
          **** End of data ****

```

SET_FLD

➔ SET_FLD(*fieldname* , value , *duplication* , *tally_literal*) ➔

(Can be used in FASTREXX procedures.)

SET_FLD allows you to set a value for any field defined in a template.

fieldname

The name you specify must match a field name in the template. For nonunique names, you can specify a name in the form *groupname.dataname*. Name matching is not case-sensitive. If the name is unqualified, then the first occurrence of the name is used. For dimensioned fields, you can refer to an individual array element by providing a suffix subscript in the form (*nn*), where *nn* is a valid subscript for the dimensioned field. If you do not provide a subscript, the function applies to all elements of the array.

value

The value used to update the field. The value should be appropriate for the field data type. The following can be specified:

- A hexadecimal string in the form 'hhhhh'h. The value enclosed in quotation marks must be an even number of characters and contain valid hexadecimal characters (0–9, A–F).
- A binary string in the form 'nnnnn'b. The value enclosed in quotation marks must be a combination of "0"s and "1"s.
- A character string. For non-numeric types, the value should be enclosed in quotation marks.
- A numeric value.
- A variable in the form &variable_name. A variable is substituted for the value if a matching character, numeric, or tally variable can be located. If a matching variable cannot be found, the string is treated as a literal value.

You can refer to a substring of a variable by specifying &variable_name(n:length) which returns a string starting at the nth character of the variable for the minimum of the length specified by length or the remaining length of variable. If n is greater than the length of the variable, the value is treated as null.

duplication

Specify an integer *n* to duplicate the literal value *n* times.



Note: This cannot be used for numeric fields and can only be used where the value is a literal constant and not a substitute variable.

tally_literal

Specify a literal to appear on a tally report that counts every successful operation of the function.

Example 1

Store the value 'xxxxxxx' in the field ST-CHAR8.

```
SET_FLD('st-char8','x',8)
```

Example 2

Store the value of variable NEW_EMP in the field EMP_NO.

```
SET_FLD('emp_no','&new_emp')
```

SET_OLEN

Figure 526. Syntax

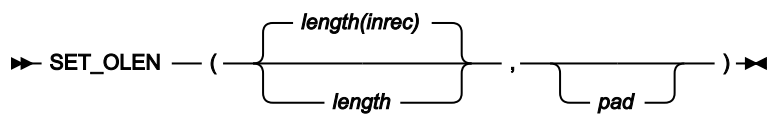



Note: Commas following the last specified argument can be omitted.

Can be used in FASTREXX procedures.

Sets the length of the output record. If the specified length is greater than the current length of the output record, the pad character is used to fill out the record to the specified length. If the specified length is less than the current OUTPOS, OUTPOS is reset to the new length + 1.

Returns

A single blank.

length

Length, in bytes, to set. Must be a non-negative integer. The default value is the length of the input record (which is also the original length of the output record).

pad

Pad character. Defaults to the pad character set on the File Manager System Processing Options panel. If the current pad setting is OFF, the default pad character is a blank.

Example

Set the length of the current output record to 80.

```
SET_OLEN(80)
```

SETC

Figure 527. Syntax

► **SETC** — (— *name* — , — '*value*' — , — *duplication* —) ►

Can be used in FASTREXX condition expressions.

Defines or changes a character variable.

name

1–256 character variable identifier. Variable name matching is not case sensitive. Cannot be a system character variable or a system numeric variable. See [Using FASTREXX variables on page 1631](#).

value

A single value can be entered:

- Specifying hexadecimal strings. A hexadecimal string must be in the form 'hhhhh'h'. The value enclosed in quotation marks must be an even number of characters and contain valid hexadecimal characters (0–9, A–F).
- Specifying binary strings. A binary string must be in the form 'nnnnn'b. The value enclosed in quotation marks must be a combination of "0"s and "1"s.

- Specifying character strings. For non-numeric types, the value should be enclosed in quotation marks.
- Specify a variable by specifying `&variable_name`. A variable is substituted for the value if a matching character, numeric, or tally variable can be located. If a matching variable cannot be found, the string is treated as a literal value. If a numeric or tally variable is referenced, then the value is the number converted to its display form with leading zeros removed.

You can refer to a substring of a variable by specifying `&variable_name(n:length)` which returns a string starting at the *n*th character of the variable for the minimum of the length specified by *length* or the remaining length of variable. If *n* is greater than the length of the variable, the value is treated as null.

duplication

Specify an integer *n* to duplicate the literal value *n* times.



Note: This can only be used where the value is a literal constant and not a substitute variable.

Example 1

Set up a variable called A10 with A value repeated 10 times.

```
IF RECSIN() = 1
  SETC('CHECK_CHAR', 'A', 10)
else
  SETC('CHECK_CHAR', 'B', 10)

If FLDI(20, 10, 'EQ', '&CHECK_CHAR') then
  Return
Else
  Return "DROP"
```

Example 2

Copy the tenth input record into variable REC10.

```
If RECSIN() = 10 then
  SETC('REC10', '&ZINREC')
```

Example 3

Copy the name value from column 3 for 20 on the input record into the variable name.

```
SETC('NAME', '&ZINREC(3:20)')
```

SETN

Figure 528. Syntax

►► **SETN** — (— *name* — , — *value* —) —►►

Can be used in FASTREXX condition expressions.

Defines or changes a numeric variable.

name

1–256 character variable identifier. Variable name matching is not case sensitive. Cannot be a system character variable or a system numeric variable. See [Using FASTREXX variables on page 1631](#).

value

An integer or substitute numeric or tally variable preceded with an optional plus or minus sign. The number can set, increment, or decrement the respective value in the variable. The variable is initialized with a zero value if it does not exist. The presence of a plus or minus symbol indicates the number provided is to increment or decrement the current value respectively. The absence of plus or minus symbols indicates the number is to replace the current value. Ensure that the value is enclosed in quotation marks if a plus or minus sign is specified. A substitute variable name should begin with an ampersand (&*variable_name*). This must refer to an existing tally or numeric variable. If the variable does not exist, the procedure fails with a severe error. The maximum number supported is 31 digits plus sign.

Example 1

Count the number of records with surname smith that have an age over 50.

```
If FLDI(1,20,C,'CU','SMITH') and FLD(25,,P) > 50 then
SETN ('Smith_over_50','+1')
```

Example 2

Save tally value for first 50 record.

```
TALLY(1,P,'Total Car crashes')
IF RECSIN() = 50 then
  SETN('Total_first_50','&total car crashes')
```

SETRC

► SETRC — (— *return_code* —) ◄

Can be used in FASTREXX condition expressions.

SETRC lets you change the batch return code to the value specified.

return_code

A number that sets the File Manager batch return code..

Example

Change the batch return code to 99.

```
SETRC(99)
```

STATS

Figure 529. STATS syntax – with template

►► **STATS**(*fieldname* , — *operator* , — *literal*) ►◄

Figure 530. STATS syntax – without template

►► **STATS**(*start* , — *length* , — *type* , — *operator* , — *literal*) ►◄

(Can be used in FASTREXX procedures.)

STATS allows you to do statistical calculations against the values in a field. The calculated value is maintained in a TALLY register and, at the end of the File Manager function, prints on SYSPRINT or FMNRSUM the TALLY register prefixed by *reportliteral*.

fieldname

The name you specify must match a field name in the template. For nonunique names, you can specify a name in the form *groupname.dataname*. Name matching is not case-sensitive. If the name is unqualified, then the first occurrence of the name is used. For dimensioned fields, you can refer to an individual array element by providing a suffix subscript in the form (*nn*), where *nn* is a valid subscript for the dimensioned field.

start

Position, in bytes, in the input record at which to start reading the field value.

length

The length of the field in bytes.

type

The data type of the field. The values that can be specified are:

B

Signed binary. If you specify B for type, length must be 2, 4, or 8.

P

Packed decimal. If you specify P for type, length must be between 1 and 16.

UB

Unsigned binary. If you specify UB for type, length must be 2, 4, or 8.

Z

Zoned decimal. This is the default. If you specify Z for type, length must be between 1 and 32 or, if the field contains a separate sign character or leading blanks, between 1 and 3. TALLY ignores leading blanks for zoned decimal fields, allowing simple character numeric fields to be tallied.

Records containing only blanks in the target field are ignored. If a separate sign is present, there must be no blanks between the sign and the zoned data.

operator

The statistical processing to be applied to the field. The values that can be specified are:

AVG

Calculate the average of the field values.

TOTAL

Accumulate the total of the field values.

literal

A literal string that is prefixed to the calculated values printed on SYSPRINT.

Example

Calculate the average value of all the loans recorded in the data set.

```
STATS('loan-value','AVG', 'Average value of all loans')
```

TALLY

Figure 531. Syntax

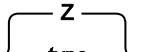
► TALLY(*start* , *length* ,  *type* , *string*) ◄

Can be used in FASTREXX procedures.

Accumulates the value of the specified input record field in a TALLY register and, at the end of the File Manager function, prints on SYSPRINT or FMNRSUM the TALLY register prefixed by *string*. The TALLY is maintained across members of a PDS.



Note: If REXX member selection has been used with the DSC function or the Data Copy Utility, input records are only passed to the REXX procedure until a decision has been made on whether to DROP or PROCESS the member. TALLY accumulates the value of the specified input record field for all records processed by the REXX procedure. This includes records that were processed for members that were subsequently DROPPed, and excludes records that were not passed to the REXX procedure because a decision had already been made to PROCESS or DROP the member.

Returns

A single blank.

start

Start, in bytes, position of the field to be tallied in the input record.

length

Length, in bytes, of the field to be tallied in the input record.

type

The data type of the field to be accumulated. The values that can be specified are:

B

Signed binary. If you specify B for *type*, *length* must be 2, 4, or 8.

P

Packed decimal. If you specify P for *type*, *length* must be between 1 and 16.

UB

Unsigned binary. If you specify UB for *type*, *length* must be 2, 4, or 8.

Z

Zoned decimal. This is the default. If you specify Z for *type*, *length* must be between 1 and 32 or, if the field contains a separate sign character or leading blanks, between 1 and 33. TALLY ignores leading blanks for zoned decimal fields, allowing simple character numeric fields to be tallied. Records containing only blanks in the target field are ignored. If a separate sign is present, there must be no blanks between the sign and the zoned data.

string

A literal string that is prefixed to the accumulated TALLY total.

The field whose value is to be accumulated starts at position *start* in the input record, and is *length* bytes long. If the sum of *start* and *length* is more than one greater than LENGTH(INREC), the TALLY function returns a blank without changing the TALLY register.

You can code more than one TALLY function in your procedure. File Manager creates a separate TALLY register for each TALLY function with a unique combination of arguments. This means that you can accumulate a given field in more than one TALLY register by specifying a different value for *string* in each TALLY function.

Example

Accumulate hours recorded in personnel records depending on record type.

```
Select
  When (FLD(1,1) == 'E') Then
    TALLY(15,4,B,'Sum of employee hours')
  When (FLD(1,1) == 'S') Then
    TALLY(15,4,B,'Sum of supervisor hours')
  Otherwise
    TALLY(28,4,B,'Sum of manager hours')
End
```

TESTC

Figure 532. Syntax

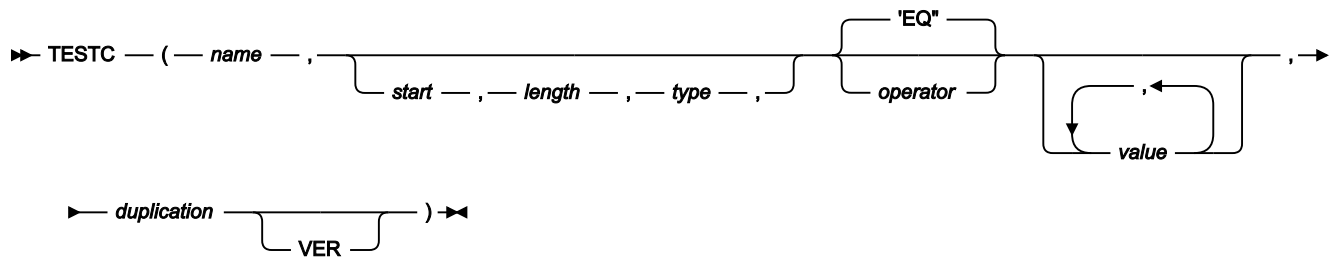

Can be used in FASTREXX condition expressions.



Note:

1. The operator (*operator*) and non-numeric values should all be enclosed in quotation marks to avoid syntax errors.
2. The start length and type parameters are optional to provide the capability to examine part of the variable. The second operand can be the operator. See examples provided.
3. If you specify a value for *length* that would cause the record length to be exceeded, a false result is returned.
4. If you specify a numeric type (types B, P, Z), and the specified field contains invalid data for that type, then the function returns a false result. Numeric data is always returned in integer form; that is, the function does not perform scaling of numeric data.

name

1–256 character variable identifier. Variable name matching is not case sensitive. If the name is not found, a variable is created with a length of 1 and value X'00'.

start

Position in bytes in the variable at which to start reading the field value. Can be specified as:

Absolute position

Must be a positive integer. If *start* is greater than the current length of the input record, the function has no effect.

Relative start position

Can be specified as IPx or INx, or as Px or Nx, OPx, or ONx. When testing a variable, the current variable position is the basis of calculation. The current variable position is changed by the TESTC function with a contains type operator. If this resolves to a value of less than or equal to zero, the function produces a false result. If this resolves to a value that is greater than the current length of the variable, the function produces a false result.

length

The length of the field in bytes.

- For binary fields, you must specify the length. It can be 2, 4, or 8.
- For character fields, if you omit the length, the length is defaulted:
 - For contains type operators, to the rest of the variable.
 - When all values are variable substitutions, to the rest of the variable.
 - Otherwise, the maximum literal value length is be used.
- For packed decimal fields, if you specify the length, it must be in the range 1–16. If you omit the length, the function attempts to determine the packed field length from the variable value and returns only that field.
- For zoned decimal fields, if you specify the length, it must be in the range 1–31 or, if the field contains a separate sign character, in the range 1–32. If you omit the length, the function returns the remainder of the variable. If this exceeds 32, then the function returns a false result.

type

The data type of the field. Valid values are:

B

Binary. The function interprets binary fields as being signed.

C

Character. This is the default.

P

Packed decimal.

U

Interprets the field as character, but converts it to uppercase before returning the string.

Z

Zoned decimal. Interprets all of the COBOL external decimal variants as numeric data.

operator

The default is EQ or =. This function supports all the operators described for dynamic template and criteria edit. For details about the operators supported and their description, see:

- [Dynamic Template panel on page 845.](#)
- [Record Identification Criteria panel on page 982.](#)
- [Record Selection Criteria panel on page 991.](#)

value

The value or values entered must be valid in the context of the operator and the field which is being referenced. For example, only certain operators like CO (contains) allow multiple values. Numeric values should be entered when testing numeric fields, and so on.

- Specifying hexadecimal strings. A hexadecimal string must be in the form 'hhhhh'h'. The value enclosed in quotation marks must be an even number of characters and contain valid hexadecimal characters (0–9, A–F).
- Specifying binary strings. A binary string must be in the form 'nnnnn'b. The value enclosed in quotation marks must be a combination of "0"s and "1"s.
- Specifying character strings. For non-numeric types, the value should be enclosed in quotation marks.
- Specify a variable by specifying &variable_name. A variable is substituted for the value if a matching character, numeric, or tally variable can be located. If a matching variable cannot be found, the string is treated as a literal value. If a numeric comparison is being performed, a character variable is converted to a number - if the conversion fails, the function returns a false result. If a numeric or tally variable is referenced in a character comparison, then the value is the number converted to its display form with leading zeros removed.

duplication

Specify an integer *n* to duplicate the literal value *n* times.



Note: This can only be used for operators that support a single value (for example, Not contains) and where the value is a literal constant and not a substitute variable.

VER

Verify the field is composed only of characters specified in the value column.

Example 1

SET variable named TESTREC to current input record. Check the variable and process only those records that contain values of 'Smith' or 'Jones'.



Note: In this case, use the operator CU so the contains processing is not case-sensitive. The start, length, and type parameters have been omitted.

```
SETC('TESTREC', '&ZINREC')

if TESTC(TESTREC, 'CU', 'Smith', 'Jones') then
  return
else
  return 'DROP'
```

Example 2

Process all records with a salary greater than 75000, where salary is a packed-decimal value found at start position 28.



Note: In this case, allow File Manager to calculate the packed-decimal field length.

```
SETC('TESTREC', '&ZINREC')
  if TESTC(TECREC,28,,P,'>',75000) then
    return
  else
    return 'DROP'
```

TESTN

Figure 533. Syntax

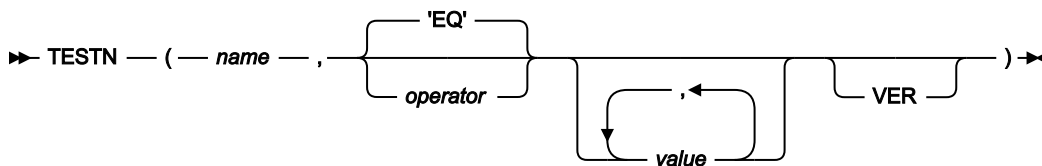

Can be used in FASTREXX condition expressions.

name

This is a 1-256 name that matches either a tally literal or a numeric variable. Variable name matching is not case sensitive. If the name is not found, a numeric variable is created with value of 0.

operator

The default is EQ or =. This function supports all the operators described for dynamic template and criteria edit. For details about the operators supported and their description, see:

- [Dynamic Template panel on page 845.](#)
- [Record Identification Criteria panel on page 982.](#)
- [Record Selection Criteria panel on page 991.](#)

value

The value or values entered must be valid in the context of the operator and the field which is being referenced. For example, only certain operators like CO (contains) allow multiple values. Numeric values should be entered when testing numeric fields, and so on.

- Specifying hexadecimal strings. A hexadecimal string must be in the form 'hhhhh'h'. The value enclosed in quotation marks must be an even number of characters and contain valid hexadecimal characters (0-9, A-F).
- Specifying binary strings. A binary string must be in the form 'nnnnn'b. The value enclosed in quotation marks must be a combination of "0"s and "1"s.
- Specifying character strings. For non-numeric types, the value should be enclosed in quotation marks.

- Specify a variable by specifying &variable_name. A variable is substituted for the value if a matching character, numeric, or tally variable can be located. If a matching variable cannot be found, the string is treated as a literal value. If a numeric comparison is being performed, a character variable is converted to a number - if the conversion fails, the function returns a false result. If a numeric or tally variable is referenced in a character comparison, then the value is the number converted to its display form with leading zeros removed.

VER

Verify the field is composed only of characters specified in the value column.

Example 1

Count the number of records with A in the first byte and stop processing after 20.

```
IF FLD(1,1) = 'A' then
  SETN(COUNTA,'+1')

if TESTN(COUNTA,'>',20) then
  return "STOP IMMEDIATE"
else
  return
```

Example 2

When the total of packed decimal field start at column 28 is greater than 100, stop processing



Note: In this case, allow File Manager to calculate the packed-decimal field length.

```
TALLY(28,P,'Total Sales')
if TESTN('Total Sales', '>', 100) then
  return "STOP IMMEDIATE"
else
  return
```

TFLD

Figure 534. Syntax

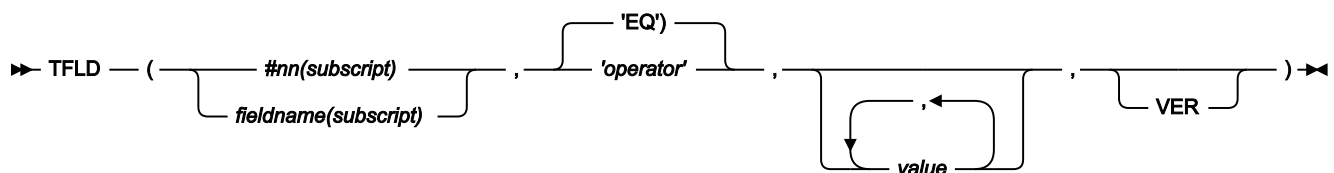

(Can be used in FASTREXX condition expressions.)

Performs a conditional test against any field defined in a template. For dimensioned fields, you can apply the condition to any or all of the elements of the array. You can only use this function if the associated function is running with a copybook or template.



Note: The Field name (*fieldname*), field reference (*#nn*), operator (*operator*), and non-numeric values should all be enclosed in quotation marks to avoid syntax errors.

#nn or fieldname

#nn

Use this form when providing free-format criteria during template edit. *nn* is the field reference number displayed during template edit. It is not valid to use *fieldname* for a field reference when providing criteria during template edit.

fieldname

Use this form of identifying fields when coding user procedures. For non-unique names, you can specify a name in the form *groupname.dataname*. Name matching is not case-sensitive. If the name is unqualified, then the first occurrence of the name is used. Do not code *#nn* values in user procedures, as the displayed field reference values do not identify the correct field when running from a user procedure.

subscript

This applies *only* to dimensioned fields. You can specify one of these forms:

(ANY)

This is the default if you do not specify a subscript for a dimensioned field and it indicates that at least one element of the associated array must satisfy the condition for a true result.

(ALL)

This indicates that all elements of the associated array must satisfy the condition for a true result.

(nn)

This refers to a single array element and you should provide a valid subscript for the dimensioned field.

operator

The default is EQ or =. This function supports all the operators described for dynamic template and criteria edit. For details about the operators supported and their description, see

- [Dynamic Template panel on page 845](#)
- [Record Identification Criteria panel on page 982](#)
- [Record Selection Criteria panel on page 991](#)

value

The value or values entered must be valid in the context of the operator and the field which is being referenced. For example, only certain operators like CO (contains) allow multiple values. Numeric values should be entered when testing numeric fields, and so on.

Specifying hexadecimal strings

A hexadecimal string must be in the form `'hhhhhh'x`. The value enclosed in quotation marks must be an even number of characters and contain valid hexadecimal characters (0–9, A–F).

Specifying binary strings

A binary string must be in the form `'nnnnnn'b`. The value enclosed in quotation marks must be a combination of "0"s and "1"s.

Specifying character strings

For non-numeric types, the value should be enclosed in quotation marks.

VER

Verify the field is composed only of characters specified in the value column.

Example 1

Check every element of the dimensioned field CONTACTS and process only those records with contact values of 'Smith' or 'Jones'.



Note: In this case, we use operator CU so the contains processing is not case-sensitive.

```
if TFLD('CONTACTS(ANY)', 'CU', 'Smith', 'Jones') then
  return
else
  return 'DROP'
```

Example 2

Check the monthly pay for a contract record types and process those with every month occurrence higher than 8000.



Note: MPAY is not unique, so we qualify which MPAY we want to check.

```
Copybook
01 REC-CONTRACT.
   05 MPAY      PIC S9(8) Binary OCCURS 12 Times.
01 REC-Employee.
   05 MPAY      PIC S9(8) Binary OCCURS 12 Times.

if TFLD('REC-CONTRACT.MPAY(ALL)', '>', 8000) then
  return
else
  return 'DROP'
```

Performance notes

TFLD is faster than FLD_CO, but requires a template to reference a field value.

```
TFLD('#3',, 'CO', 'A') & TFLD('#3',, 'CO', 'B')
```

would be faster if coded as:

```
TFLD('#3',, 'ACO', 'A', 'B')
```

TID

►► TID(*fieldname*) ◀◀

(Can be used in FASTREXX procedures.)

TID is a Boolean function available when using a template. It enables you to test whether the record currently being processed is defined by the record layout where *fieldname* is the 01 level name.

fieldname

The name of an 01 level field name in the template.

Example

Only process the records mapped by 01 level name SMFRCD30.

```
IF TID('SMFRCD30') THEN
  RETURN 0
ELSE
  RETURN 'DROP'
```

TM

Figure 535. Syntax

►► TM(*string*, *mask*) ◀◀

Tests selected bits of a string and sets the condition code accordingly. See [FLD_TM on page 1659](#) for a similar function that is FASTREXX eligible.

Returns

If the tested bits are all ones, then TM returns 1. Otherwise, TM returns 0.

string

A literal string, or variable representing a string.

mask

A bit-string determining which bits to test in *string*.

The length of the test is based on the length of the shorter of the two arguments, *string* and *mask*. A *mask* bit of one indicates that the equivalent bit in *string* is to be tested. When a *mask* bit is zero, the equivalent *string* bit is ignored.

Example 1

Test the third byte of the input record and, if the low order bit is set, overlay a hex FF into the second byte of that record.

```
If TM(FLD(3,1),'01'x) Then Do
  outrec = OVERLAY('FF'x,outrec,2)
  Return
End
Return 'DROP'
```

Example 2

Test the third byte of the input record and, if the high order bit is set, logically OR a hex 04 over the contents of the second byte of that record.

```
If TM(FLC(3,1),'10000000'b) Then Do
  outrec = OVERLAY(BITOR(fld(2,1),'04'x),outrec,2)
  Return
End
Return 'DROP'
```

TOP (DSEB only)

Figure 536. Syntax

►► TOP() ◄◄

(Can be used in FASTREXX procedures.)

Moves to the first input record.

UP (DSEB only)

Figure 537. Syntax

►► UP(*n*) ◄◄

(Can be used in FASTREXX procedures.)

Moves up *n* number of input records, or to the first input record, if there are less than *n* records above the current input record.

If, after moving, the current input record is the first input record, then the UP function returns the string value "TOF" (top of file).

UPDATE (DSEB only)

Figure 538. Syntax

► UPDATE() ◄

(Can be used in FASTREXX procedures.)

Replaces the current input record with the value in OUTREC. If you leave DSEB or move to another record before calling the UPDATE function, then any changes you made to the current OUTREC are lost.

VAL_FLD

► VAL_FLD(*fieldname* , *tally_literal*) ◄

(Can be used in FASTREXX procedures.)

VAL_FLD allows you to obtain the value for any field defined in a template.

fieldname

The name you specify must match a field name in the template. For nonunique names, you can specify a name in the form *groupname.dataname*. Name matching is not case-sensitive. If the name is unqualified, then the first occurrence of the name is used. For dimensioned fields, you can refer to an individual array element by providing a suffix subscript in the form (*nn*), where *nn* is a valid subscript for the dimensioned field.

tally_literal

Specify a literal to appear on a tally report that counts every successful operation of the function.

Example

Process the records for customer Id 10270.

```
if VAL_FLD('CUSTOMER-ID') = 10270 then
  return
else
  RETURN 'DROP'
```

VAR_OUT

Figure 539. Syntax

► VAR_OUT (*name* , *i_start* , *i_length* , *o_start* , *o_length* , *pad*) ◄

(Can be used in FASTREXX procedures.)



Note: Commas following the last specified argument can be omitted.

Overlays the output record with a field from the variable. See [OVLY_OUT on page 1675](#) for a function to overlay the output record with a literal. If the target field length exceeds the source field length, then the source field is padded to the specified length using the *pad* character. If the target field length is less than the source field, the source field is truncated from the right. On successful execution, also updates the value of OUTPOS to one byte past the end of the field overlaid in the output record.

Returns

A single blank.

name

A 1–256 character variable identifier. Variable name matching is not case-sensitive. If the name is not found, a variable is created and populated from the current input record.

i_start

Position, in bytes, in the variable at which to start reading the field to be copied. Can be specified as:

Absolute position

Must be a positive integer. Default value is 1.

Relative to current INPOS

Can be specified as IPx or INx, or as Px or Nx, or as OPx or ONx. Must resolve to a positive integer.

i_length

Length, in bytes, of the source field. Must be a non-negative integer. Defaults to 0. If you omit *i_length* or specify zero, the remainder of the variable from the *i_start* position is used. This also applies if you specify a value that would cause the source field to be read from beyond the end of the current variable.

o_start

Position, in bytes, in the output record at which to start overlaying the copied field. If you omit *o_start* or specify zero, the field is appended to the end of the output record. If *o_start* is greater than the current length of the output record, the record is padded with the specified or defaulted *pad* character from the current record length to the specified *start* position. Can be specified as:

Absolute position

Must be a positive integer. Default value is 1.

Relative to current INPOS

Can be specified as IPx or INx, or as Px or Nx, or as OPx or ONx. Must resolve to a positive integer.

Relative to current OUTPOS

Can be specified as OPx or ONx, or as Px or Nx. Must resolve to a positive integer.

o_length

Length, in bytes, of the target field. Defaults to the source field length (*i_length*). A value of 0 indicates that the target field length is the greater of *i_length* and the remaining output record length. If 0 is specified for both *o_start* and *o_length*, then *i_length* is used as the target length.

pad

Pad character. Defaults to the pad character set on the File Manager System Processing Options panel (when processing online) or the pad character specified in the SET function (when running in batch). If the current pad setting is OFF or unspecified, the default pad character is a blank.

Example 1

Copy the characters in columns 1 and 2 of the variable to columns 3 and 4 of the output record.

```
VAR_OUT(MYVAR,1,2,3,2)
```

Example 2

Append the characters in columns 11 and 12 of the variable to the end of the output record, padded with two blanks.

```
VAR_OUT(MYVAR,11,2,0,4, ' ')
```

Example 3

Search a field in the variable for the characters 'AA' and, if found, copy to the end of the output record (assumes that OUTPOS is still set to end of output record).

```
IF TESTC(MYVAR,'CU','AA') Then
/* when successful, updates variable position to 12 */
VAR_OUT(MYVAR,N2,2,P0,2)
/* copies from variable position - 2, appends to end of output record */
```

VAR_TM

Figure 540. Syntax

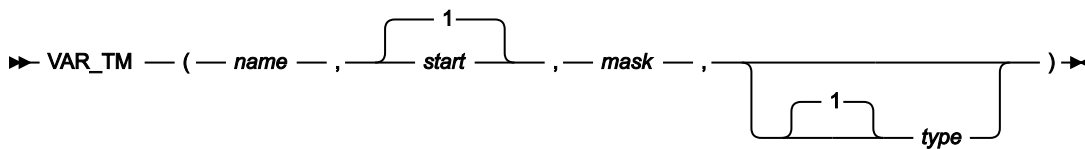

(Can be used in FASTREXX procedures.)



Note: Commas following the last specified argument can be omitted.

name

1–256 character variable identifier. Variable name matching is not case sensitive. If the name is not found, the function returns a false result.

start

Position, in bytes, in the variable at which to start testing. The length of the field is defined by the mask (*mask*). Can be specified as:

Absolute position

Must be a positive integer. Default value is 1. If *start* is greater than the current length of the variable, the function has no effect.

Relative to variable position

Can be specified as IPx or INx, or as Px or Nx, or as OPx or ONx. If this resolves to a value of less than or equal to zero, the function results in an error. If this resolves to a value that is greater than the current length of the variable, the function has no effect.

mask

A bit string determining which bits to test in the field. The length of *mask* defines the length of the input field. This field defines a bit string mapping used to test the specified bits in the variable. You can use the bit string, hex string or character string formats to define this field. Therefore, '0100 0000'b, '40'x, and ' ' are all legitimate and equivalent ways of defining a mask to test the second bit of a one-byte field.

type

The type of test:

1

VAR_TM returns True (1) if all the bits that are on in the mask are on in the variable field. This is the default value.

0

VAR_TM returns True (1) if all the bits that are on in the mask are off in the variable field.

M

VAR_TM returns True (1) if at least one of the bits that are on in the mask is on in the variable, and at least one is off.

N

VAR_TM returns True (1) if at least one of the bits that are on in the mask is off in the variable field.

Example 1

Test the third byte of the variable and, if the low order bit is set, overlay a hex FF into the second byte of the output record.

```
If VAR_TM(3,'01'x) Then Do
  OVLY_OUT('ff'x,2,1)
  Return
End
Return 'DROP'
```

Example 2

Test the third byte of the variable and, if some of the three high order bits are set, and some are not, overlay the contents of the second byte of that record with a hex 04.

```
If VAR_TM(3,'11100000'b,M) Then Do
  OVLY_OUT('04'x,2,1)
```

Example 3

Test the current position of the variable and, if the low order bit is set, overlay a hex FF into the byte prior to this location in the output record.

```
If VAR_TM(P0,'01'x) Then Do
  OVLY_OUT('ff'x,IN1,1)
  Return
End
Return 'DROP'
```

WRITE

Figure 541. Syntax

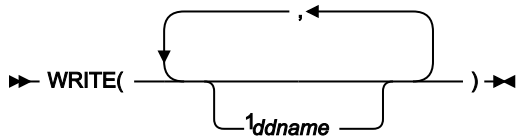

Notes:

¹ When used with a DSC or DSP function, *ddname* is optional.

Can be used in FASTREXX procedures.

Writes a record to the specified data set or sets.

Returns

A single blank.

ddname

Specifies a record is to be written to the data set identified by the specified *ddname*. If *ddname* is omitted when used with a DSC or DSP function, the default is the *ddname* of the primary output data set. The primary output data set depends on the File Manager function or panel being used:

Function or panel option	Primary output data set is...
Print Utility (option 3.2)	Determined by the value of the PRINTOUT field on the Set Print Processing Options panel. For details, see Set Print Processing Options panel (option 0.1) on page 1025 .
Copy Utility (option 3.3) or DSC function	The data set that is the target of the copy function. For the DSC function, if a ddname is associated with the primary output data set, then specifying that ddname is the same as omitting the argument. Do not target the primary output data set with another ddname.
DSP function	When used in a batch job, the primary output data set is SYSPRINT. When used in a REXX procedure, the primary output data set is determined by the PRINTOUT parameter of the SET function. For details, see SET (Set Processing Options) on page 1550 . If a ddname is associated with the primary output data set, then specifying that ddname is the same as omitting the argument. Do not target the primary output data set with another ddname.

Except for the primary output data set, the data set attributes of the output data set are derived from:

- The pre-allocated data set DCB attributes. Existing record formats, lengths and block sizes are preserved.
- If it has been allocated without DCB attributes then these attributes are inherited from the input data set.

Sequential data sets specified on a WRITE statement to which no records have been written during the execution of a program are still opened and closed by File Manager. This means that:

- Newly allocated data sets with DISP=(NEW,...) are initialized to an "empty" state and only contain an EOF record.
- Existing data sets with data are handled as follows:
 - DISP=(OLD,...) data sets are reset to an "empty" state and contain only an EOF record; all previously existing data is lost.
 - DISP=(MOD,...) data sets have their data preserved unaffected.

The record is written from the contents of one of the following REXX variables:

- If it has been assigned a value by the procedure, the variable `OUTREC.ddname`, where `ddname` is the ddname specified in the WRITE function.
- If the variable `OUTREC.ddname` has not been assigned a value, or has been unassigned using the DROP instruction, the File Manager-defined variable, `OUTREC`.

The length of the record written depends upon the data set attributes of the output data set. If the output data set contains variable-length records, the length of the record is determined from the length of the data in the REXX variable. If the length

of the data is greater than the maximum record length specified in the data set attributes, the record is truncated. If the output data set contains fixed-length records, the length of the record written is the length specified in the data set attributes, truncated or padded as necessary.

If the record format of the output data set specifies that the records contain a carriage control character, depending on the output device, the first character of the record data in the REXX variable is interpreted as a carriage control character. For more information about records containing carriage control characters, see the z/OS DFSORT Installation and Customization.

If you are using the DSC function or Data Copy Utility and the input data set is a PDS(E) and the *ddname* of the target refers to a PDS(E), then members are created in the target data set with names matching the name of the input data set member as the result of the WRITE execution.

Example 1

If the current record is type 01, then write it to the DD01 file.

```
If FLD(1,2) = 01 Then WRITE('DD01')
```

Example 2

If the current record is type 02, then write it to the DD02 and DD02COPY files.

```
If FLD(1,2) = 02 Then WRITE('DD02','DD02COPY')
```

RETURN return values

In REXX, you can use the RETURN instruction to leave a procedure. You can optionally specify a character string as a parameter on the RETURN instruction. This character string is returned to the caller of the procedure. File Manager recognizes and processes the following character strings if specified on the RETURN instruction. The character strings can be specified in uppercase, lower case, or a mixture of both.

DROP

The character string DROP tells File Manager to not write the current record to the primary output data set. The effect of specifying DROP on the RETURN instruction depends upon the File Manager function or panel being used:

- **For DSC or Copy Utility (option 3.3)**, the current record is not copied to the target data set.
- **For DSP or Print Utility (option 3.2)**, the current record is not printed.
- **For DSU**, the current record is not updated, regardless of any changes that have been made to the data in the variable OUTREC.
- **For DSEB**, the current record is not updated, unless the UPDATE function has already been called for the current record.

If this string is returned by a REXX procedure run in conjunction with the DSC function or Data Copy Utility and REXX member selection has been specified, it is treated as if it was a RETURN with no argument strings and a warning message is issued.

Subsequent records continue to be passed to the REXX procedure until a decision has been made on whether to DROP or PROCESS the member.

Here are some examples:

```
RETURN 'DROP'
Return 'Drop'
Return drop /* assumes no variable named 'drop' has been assigned */
```

DROP MEMBER

Indicates that the member is to be excluded from the copy. No more records in this member are passed to the REXX procedure for testing. Processing continues with the next member.

This string is only valid when used in conjunction with the DSC function or Data Copy Utility, and REXX member selection has been specified. If REXX member selection has NOT been specified, it is treated as a RETURN with no argument strings, and a warning message is issued. Subsequent records continue to pass to the REXX procedure.

PROCESS MEMBER

Indicates that the member is to be included in the copy. No more records in this member are passed to the REXX procedure for testing. The member is copied intact, subject to any specified template processing, which is performed before the user REXX procedure is invoked. Processing continues with the next member.

This string is only valid when used in conjunction with the DSC function or Data Copy Utility, and REXX member selection has been specified. If REXX member selection has NOT been specified, it is treated as a RETURN with no argument strings, and a warning message is issued. Subsequent records continue to pass to the REXX procedure.

STOP

The character string STOP tells File Manager to terminate the current File Manager function after the current record has been written to the primary output data set. The effect of specifying STOP on the RETURN instruction depends upon the File Manager function or panel being used:

- **For DSC or Copy Utility (option 3.3)**, the current record is copied to the target data set and the function is terminated.
- **For DSP or Print Utility (option 3.2)**, the current record is printed and the function is terminated.
- **For DSU**, the current record is updated if the data in the variable OUTREC has been changed, and the function is terminated.
- **For DSEB**, the current record is not updated, unless the UPDATE function has been called for the current record. In either case, the function is terminated.

If this string is returned by a REXX procedure run in conjunction with the DSC function or Data Copy Utility and where REXX member selection has been specified, it is treated as if it was a RETURN with no argument strings and a warning message is issued. Subsequent records continue to be passed to the REXX procedure until a decision has been made on whether to DROP or PROCESS the member.

Here are some examples:

```
RETURN 'STOP'  
Return 'Stop'  
Return stop /* assumes no variable named 'stop' has been assigned */
```

STOP IMMEDIATE

The character string STOP IMMEDIATE tells File Manager to terminate the current File Manager function without writing the current record to the primary output data set. The effect of specifying STOP IMMEDIATE on the RETURN instruction depends upon the File Manager function being used:

- For DSC (Data Set Copy), the current record is not copied to the target data set and the function is terminated.
- For DSP (Data Set Print), the current record is not printed and the function is terminated.
- For DSU (Data Set Update), the current record is not updated, regardless of any changes that have been made to the data in the variable OUTREC, and the function is terminated.
- For DSEB (Data Set Edit Batch), the current record is not updated, unless the UPDATE function has been called for the current record. In either case, the function is terminated.

If this string is returned by a REXX procedure run in conjunction with the DSC function or Data Copy Utility and where REXX member selection has been specified, it is treated as if it was a RETURN with no argument strings and a warning message is issued. Subsequent records continue to be passed to the REXX procedure until a decision has been made on whether to DROP or PROCESS the member.

Here are some examples:

```
RETURN 'STOP IMMEDIATE'  
Return 'Stop Immediate'  
Return stop immediate /* assumes variables 'stop' and 'immediate' not assigned */
```

Appendix A. Messages

Messages issued by File Manager Base component have a unique alphanumeric identifier with the format:

```
FMNB $a$ nnn
```

where:

a

Is an alphabetic character.

nnn

Is a 3-digit number.

When the message is issued by a batch function, the identifier is printed in front of the text of the message.

When the message is issued by an online function, the identifier is not displayed with the message. However, you can obtain the identifier of a message by typing `MSGID` on the command line and pressing Enter. This command causes the message identifier of the last message issued to be displayed on your screen.

Many of the online messages comprise a short message and long message. The short message is displayed in the upper right-hand corner of the panel. The long message is only displayed if you press the F1 key when the short message is displayed.

In this section, selected batch messages are listed in alphanumeric order. For each message, the information provided comprises:

- The message identifier.
- The text of the message.
- An explanation of the message.
- The required user response.

File Manager messages

FMNBA005

Function *name* unknown

Explanation: An attempt was made to execute function *name*. *name* is not a valid File Manager function.

User response: Check the spelling of the function name and retry with a valid function code.

FMNBA008

Invalid command

Explanation: This generic message is issued when an invalid command is detected.

User response: Check the spelling of the command and check that the command is valid in the current context. Retry with a valid command.

FMNBA009

Insufficient virtual storage available

Explanation: File Manager does not have enough virtual storage to start or to continue the current function.

User response: Run File Manager with a larger region size.

FMNBA011

Function *name* is not supported in batch mode

Explanation: You called a File Manager function that cannot be run in batch mode.

User response: Use a different function, or invoke File Manager in a different mode.

FMNBA012

Function *name* is not included in File Manager for z/OS®

Explanation: You called a function that is not part of File Manager for z/OS®.

FMNBA013

Function *name* is not supported in full-screen mode

Explanation: You called a File Manager function that cannot be run in full-screen mode.

User response: Use a different function, or invoke File Manager in a different mode.

FMNBA014

Function *name* is not supported in command mode

Explanation: You called a File Manager function that cannot be run in command mode.

User response: Use a different function, or invoke File Manager in a different mode.

FMNBA015

Function *name* is not supported in line mode

Explanation: You called a File Manager function that cannot be run in line mode.

User response: Use a different function, or invoke File Manager in a different mode.

FMNBA016

Function *name* is not supported in z/OS®

Explanation: You called a File Manager function that is not available.

User response: For a list of functions, refer to [Introduction to programming with File Manager functions on page 503](#).

FMNBA017

Invalid command: *command*

Explanation: This generic message is issued when an invalid command is detected. *command* is the invalid command.

User response: Check the spelling of the command and check that the command is valid in the current context. Retry with a valid command.

FMNBA019

The maximum limit of 255 Find and/or Change search strings has been exceeded

Explanation: The maximum number of Find and Change search strings that can be specified is 255. The operation cannot be performed.

User response: Specify 255 or fewer Find and Change search strings and then retry the operation.

FMNBA029

Deselected segment name (Short). The segment name entered was recognized, but has been deselected by the current view (Long).

Explanation: A valid segment name was specified, but the current view is not displaying that segment.

User response: Change the view to examine the specified segment.

FMNBA031

File Manager security setup failed - RACROUTE R15 X'*nn*', RC X'*nn*', RSCD X'*nn*',

Explanation: File Manager is unable to get RACF® information via RACROUTE. For more information, refer to the RACROUTE return and reason codes.

User response: Ensure that your RACF® environment is set up correctly. Refer to your RACF® documentation, the File Manager Program Directory, and the *File Manager for z/OS Customization Guide*.

FMNBA032

File Manager security setup failed - module 'FMNSECUR' not found in LPA

Explanation: The security exit must exist in LPA.

User response: Refer to the File Manager Program Directory and the *File Manager for z/OS Customization Guide*.

FMNBA033

Not authorized for *function*

Explanation: Your user ID is not authorized to use the function that you specified.

User response: If you need to use this function, contact your system support to enable your user ID for this function or function group. Refer to the *File Manager for z/OS Customization Guide*. To determine the resource permission required for the failing function, see “*Unprotected functions and profile names for protected functions*” in the *File Manager for z/OS Customization Guide*.

FMNBA036

Not authorized for fullpack access to VOLSER *volser*

Explanation: Your user ID is not authorized to use the fullpack disk functions on the specified volser.

User response: If you need to use fullpack disk functions, contact your system support to enable your user ID for fullpack access as described under “*Customizing the Security Environment*” in the *File Manager Customization Guide*.

FMNBA037

Function *name* not supported in authorized mode

Explanation: You invoked a function that cannot be run in authorized mode.

User response: Invoke File Manager in unauthorized mode.

FMNBA038

VOLSER *xxxxxx* too large for fullpack access

Explanation: The volume *xxxxxx* is too large for fullpack disk functions. Fullpack disk functions are restricted to volumes with total capacity less than 65536 tracks.

User response: Use a smaller disk

FMNBA040

Panel display error *rc* for panel *name*

Explanation: The panel cannot be displayed.

User response: Save any system error information and contact your system support.

FMNBA044

Not all stats available (Short). Some members were ignored because ISPF statistics were not available (Long).

Explanation: This message is issued by the member selection code. ISPF statistics were not available for all members. This resulted in some members being ignored.

User response: None.

FMNBA051

You cannot set this option with level field blank

Explanation: The Set Offset option was selected, but no value was specified in the Level field. A Level value is required.

User response: Specify a value for Level.

FMNBA052

You cannot set this option with both level and field name blank

Explanation: The Set Offset option was selected, but no value was specified in the Level or Field Name field. A value is required for both fields.

User response: Specify a value for both the Level and Field Name fields.

FMNBA055

WRITE(&dd) issued that would cause a re-open of a file with UNIT=AFF specified

Explanation: The DD name referenced has been closed due to processing of another WRITE function that shares the same tape unit. This file cannot be re-opened once it has been closed.

User response: Examine the logic in your procedure and correct the logic so that you are not writing to one file then the next file and then the previous file again.

FMNBA063

VSAM Return code=*rc* Error code=*error code*

Explanation: The requested CICS® I/O request failed against the selected CICS® resource. VSAM returned the listed return code and error code. Additional error messages may have been written to the CICS® or system log.

User response: Look up the VSAM return and error codes in *DFSMS Macro Instructions for Data Sets* for further information.

FMNBA065

File Manager profile save failed

Explanation: File Manager was updating the profile and an error occurred.

User response: Check the FMNPROF allocation or the FMNPROF specification in the installation profile. Refer to the *File Manager for z/OS Customization Guide*.

FMNBA066

File Manager profile not found or in error, defaults used

Explanation: The File Manager installation or user profile was not found or is in error. The default values supplied by IBM® are used.

User response: Refer to the *File Manager Customization Guide*.

FMNBA067

File Manager profile parameter *parameter=value* unknown, defaults used

Explanation: An invalid parameter was found in the File Manager installation profile. The default values supplied by IBM® are used.

User response: Refer to the *File Manager for z/OS Customization Guide*.

FMNBA068

Profile error on or near '*parameter*', File Manager defaults used

Explanation: A syntax error was detected in the File Manager installation profile, in or near the indicated parameter. The job continues using the IBM®-supplied defaults.

User response: Correct the user-supplied File Manager profile. Refer to the *File Manager for z/OS Customization Guide*.

FMNBA075

Required HOSTNAME parameter not specified.

Explanation: A client on a system that supports IPv6 attempted to establish a connection with File Manager but did not pass the required HOSTNAME parameter.

User response: Contact your system support.

FMNBA076

IPV is not at the minimum required service level.

Explanation: IPV is not at the minimum required service level to interface with your installed version of FM/CICS.

User response: Upgrade IPV to the required service level and then rerun File Manager.

FMNBA081

No User data associated with this section.

Explanation: You have issued the load module **I** command against a control section that does not have any user data stored for it.

User response: None.

Programmer response: None.

FMNBA082

No text data associated with this section.

Explanation: You have issued the load module **S** command against a control section that has no text data for this class.

User response: None.

Programmer response: None.

FMNBA083

RECLIMIT *nnnnn* start value exceeds *nnnnn* record length

Explanation: The SET RECLIMIT processing option specifies a start position that is greater than the record length of the record you are trying to print.

User response: Use the SET function and set the RECLIMIT start to a position within the record, then rerun the function.

FMNBA084

REXX not available, printout routed to SYSPRINT

Explanation: You specified SET PRINTOUT=REXX, but File Manager was not called from a REXX procedure. The print output is routed to SYSPRINT instead. (SET PRINTOUT=SYSPRINT).

User response: Use SET PRINTOUT=REXX only when calling File Manager from a REXX procedure.

FMNBA085

No Zap data associated with this section.

Explanation: You have issued the load module Z command against a control section that has no ZAP data.

User response: None.

Programmer response: None.

FMNBA091

Missing or invalid control card

Explanation: The message indicates an error in a control card. A subsequent message contains more information about the error.

User response: Correct the control card and rerun the job.

FMNBA092

Parameter *parameter* is missing

Explanation: You omitted a required parameter.

User response: Provide all required parameters.

FMNBA093

Missing or invalid function code

Explanation: You either omitted a function code or specified an invalid function code.

User response: Provide the correct function code in the control statement.

FMNBA094

Invalid syntax near card column *nn*

Explanation: The syntax of the control statement is invalid. A scale is printed to help you find the error.

User response: Correct the control statement.

FMNBA095

Too many parameters

Explanation: You might have specified excessive or duplicate parameters.

User response: Remove excessive or duplicate parameters.

FMNBA096

Parameters *parameter1* and *parameter2* are mutually exclusive

Explanation: You specified two parameters that cannot be used together.

User response: Provide the correct parameters.

FMNBA097

Parameter *parameter1* or *parameter2* missing

Explanation: You did not supply a required parameter.

User response: Specify one of the indicated parameters.

FMNBA098

Parameter *parameter1* or *parameter2* or *parameter3* missing

Explanation: You did not supply a required parameter.

User response: Specify one of the indicated parameters.

FMNBA099

Invalid continuation, syntax error near card column *nn*

Explanation: An expected continuation of the control statement could not be found or contains invalid syntax.

User response: Either remove the continuation indicator or correct the continuation card.

FMNBA100

Unexpected end of parameter specification

Explanation: The parameters for the File Manager invocation are terminated by a comma.

User response: Correct the parameter specification for File Manager invocation.

FMNBA101

IMS™ function requested and IMS™ component is not available

Explanation: You have tried to use a File Manager/IMS function, but the FM/IMS load module, FMNMOD1, failed to load. This module might have been deleted or protected (for example, if the functions supported by this module are not needed at your installation).

User response: If you need to use this function, contact your system support.

FMNBA102

Db2® function requested and Db2® component is not available

Explanation: You have tried to use a File Manager/Db2 function, but the FM/Db2 load module, FMNMOD2, failed to load. This module might have been deleted or protected (for example, if the functions supported by this module are not needed at your installation).

User response: If you need to use this function, contact your system support.

FMNBA108

Function *funcname* Return Code *retcode*

Explanation: The execution of a File Manager external REXX function *funcname* returned *retcode*.

User response: Check the return code and if necessary correct the File Manager function invocation.

FMNBA111

Recall successful

Explanation: A request to use DFSMSHsm HRECALL to recall a data set was successful.

User response: None.

FMNBA112

Recall failed, IKJEFTSR RC=*ikjrc*, RC=*rc* Reason=*reason*

Explanation: A request to use DFSMSHsm HRECALL to recall a data set failed. The attempt to run the command using IKJEFTSR gave return code *ikjrc*, and the command gave return code *rc* with reason code *reason*.

User response: Refer to the IKJEFTSR return code in the *z/OS TSO/E Programming Services* collection and the return and reason code from the HRECALL command in the *z/OS DFSMSHsm Diagnosis* collection in IBM® Knowledge Center.

FMNBA113

Parameter *parameter* invalid or not applicable for this function

Explanation: You specified an unknown parameter or a parameter that is not applicable for this function.

User response: Correct the File Manager invocation or the control statement.

FMNBA114

Parameter *parameter* is ambiguous

Explanation: File Manager cannot determine an abbreviated parameter that you specified.

User response: Specify the full parameter name.

FMNBA115

Value of parameter *parameter* missing

Explanation: A value for the specified parameter could not be found.

User response: Correct the File Manager invocation or the control statement.

FMNBA116

Extraneous parameter *parameter* ignored

Explanation: You supplied a parameter that is not used by this function, or a duplicate parameter.

User response: Remove the parameter from the File Manager invocation or the control statement.

FMNBA117

Invalid value for parameter *parameter*

Explanation: You specified an incorrect value for a parameter.

User response: Correct the File Manager invocation or the control statement.

FMNBA118

Value of parameter *parameter* too long

Explanation: You specified an incorrect value for a parameter.

User response: Correct the File Manager invocation or the control statement.

FMNBA119

Value out of range for parameter *parameter*

Explanation: You specified an incorrect value for a parameter.

User response: Correct the File Manager invocation or the control statement.

FMNBA120

Invalid or inconsistent KEYLOC or KEYLEN value

Explanation: The key length value and key location value that you specified would result in a key that does not fit into the record where it is to be used. The key location, plus the key length, minus 1 must be less than or equal to the record length. (For example, if the key location is 50 and the key length is 10, the record length must be 59 or more.)

User response: Change the key length, the key location, or both.

FMNBA121

Increment value too high

Explanation: The increment value does not fit within the key length specified.

User response: Change increment or key length.

FMNBA130

No print feature on SYSPUNCH device

Explanation: You called a function that interprets punched cards, but your card punch cannot interpret cards.

User response: Copy to cards without interpreting, or allocate SYSPUNCH to a card punch that has a print feature.

FMNBA131

No Compiler options associated with this section

Explanation: You have issued the load module O command against a control section where the compiler options cannot be determined.

User response: None.

Programmer response: None.

FMNBA133

ddname DD is allocated to a dummy device

Explanation: There is no data set available for processing. File Manager cannot process dummy data sets.

User response: Allocate a real data set, and rerun the function.

FMNBA134

FMNIIPT DD must be same unit as SYSPUNCH DD

Explanation: The function you tried to use requires the FMNIIPT DD to be allocated to the same device as SYSPUNCH.

User response: Allocate FMNIIPT with unit affinity to SYSPUNCH.

FMNBA150

End of xxxxx tape sensed

Explanation: The indicated tape is positioned at the end of the tape (that is, after the end-of-tape (EOT) mark). If the tape is a reel, it might be pulled off the feeding reel.

User response: If the tape stops before its physical end, you can proceed with caution if required (for example to copy a broken tape to its physical end).

FMNBA151

type="RDF" requires name="field name" attribute to be specified.

Explanation: An XML template contains a <criteria type="RDF"> element for REDEFINES criteria without the name="field name" attribute to associate the criteria with a valid REDEFINES field name. The XML template cannot be processed, and the associated function will fail.

Programmer response: Add the attribute name="field name" where field name is the name of a field with a REDEFINES clause or a field that is the target of a REDEFINES clause.

FMNBA152

name="field name" attribute error. Level 1 field name invalid.

Explanation: An XML template contains a <criteria type="RDF" name="field name"> element for redefines criteria. The field name specified is a level 1 field, which is not a valid redefines field.

Programmer response: Change the XML field name to a field that has a REDEFINES clause or a field that is the target of a REDEFINES clause.

FMNBA153

name="field name" attribute error. Field must have or be the target of a REDEFINES clause.

Explanation: An XML template contains a <criteria type="RDF" name="field name"> element for redefines criteria but the field name is not a valid redefines field.

Programmer response: Change the XML field name to a field that has a REDEFINES clause or a field that is the target of a REDEFINES clause.

FMNBA156

End of xxxxx tape sensed, function terminated

Explanation: The indicated tape is positioned at the end of the tape (that is, after the end-of-tape (EOT) mark). If the tape is a reel, it might be pulled off the feeding reel by subsequent forward processing of the tape.

FMNBA157

Field must have or be the target of a REDEFINES clause

Explanation: During a template edit session, the prefix commands CF and CR are only valid for redefines fields.

Programmer response: Issue the prefix command against fields that have a REDEFINES clause or are the target of a REDEFINES clause.

FMNBA158

No redefines criteria for this field in the associated template

Explanation: During an IMS view edit session, the prefix commands CF and CR are used for viewing redefines criteria that have been defined in the associated template. The field referenced by the prefix command does not have any redefines criteria.

Programmer response: Issue the prefix command against field references that are highlighted in red, indicating that redefines criteria exist in the associated template.

FMNBA159

No "by field" expression for this field in the associated template

Explanation: The prefix command CF or option 1 from a redefines criteria expression panel has been selected against a field in an IMS view. The expression in the associated template was entered in free format (CR command as opposed to CF command) so no "by field" display can be shown.

Programmer response: None. This expression cannot be viewed in "by field" format.

FMNBA160

Unit *unit* does not support Erase Tape

Explanation: You called the Erase Tape function, but the tape unit cannot perform the Erase Tape function.

User response: Mount the tape on an IBM® 3400 tape unit (or its equivalent) to perform this function.

FMNBA162

Error on xxxxx tape, ECB *ecb*, CSW *csw*, sense 0-6 *sense*

Explanation: An error occurred on the indicated tape unit. If a read data check occurred, message FMNBA163 might follow.

User response: Save the message text. Scan the console log for an I/O error message, and save it. If the error persists, give the message text to your system support.

FMNBA163

Bypass record - B, ignore error - I, user correct - C

Explanation: An error was found reading from an input tape.

User response: Reply **B** to skip the record and read the next record. Reply **I** to use the record as it was read into the input buffer. Reply **C** to correct the record.

FMNBA170

No EOD delimiter is set

Explanation: You specified EOD as the number of files in a tape function, but you have not specified an EOD value with the SET function. There is no default EOD value for tapes.

User response: Specify a different number of files or use the SET function to define an EOD delimiter.

FMNBA171

Input record exceeds *nnnn* byte buffer

Explanation: File Manager could not allocate a buffer large enough for the record.

User response: Rerun the function with more virtual storage.

FMNBA172

nnnn byte input block exceeds *nnnn* byte buffer

Explanation: File Manager could not allocate a buffer large enough for the block.

User response: Rerun the function with more virtual storage.

FMNBA181

No more data found on input tape

Explanation: The end of data on an input tape has been reached. (If a data check occurs immediately after a tape mark, File Manager assumes that the end-of-data has been reached.)

FMNBA191

Invalid element

Explanation:

The File Manager XML parser has detected one of the following:

- Invalid XML where it was expecting to find an element definition.
- An element definition that isn't valid for the current XML schema.

User response: None.

Programmer response: This message is followed by FMNBA665 or FMNBA666 and FMNBA667, which display the line number and line text where the error occurred. Correct the XML input and retry.

FMNBA192

Invalid attribute for element `<&ELEM>`

Explanation:

The File Manager XML parser has detected one of the following:

- Invalid XML where it was expecting to find an attribute definition.
- An attribute definition that isn't valid for the current XML schema.

User response: None.

Programmer response: This message is followed by FMNBA665 or FMNBA666 and FMNBA667, which display the line number and line text where the error occurred. Correct the XML input and retry.

FMNBA193

Duplicate attribute &ATTR specified for element &ELEM

Explanation: The attribute &ATTR has been specified more than once for element &ELEM at the offset &nn.

User response: None.

Programmer response: This message is followed by FMNBA665 or FMNBA666 and FMNBA667, which display the line number and line text where the error occurred. Correct the XML input and retry.

FMNBA194

End tag missing for element &ELEM

Explanation: Invalid XML - the expected end tag was not specified for element &ELEM.

User response: None.

Programmer response: This message is followed by FMNBA665 or FMNBA666 and FMNBA667, which display the line number and line text where the error occurred. Correct the XML input and retry.

FMNBA195

End tag invalid for element &ELEM

Explanation: Invalid XML - an incorrect endtag for the specified element was found.

User response: None.

Programmer response: This message is followed by FMNBA665 or FMNBA666 and FMNBA667, which display the line number and line text where the error occurred. Correct the XML input and retry.

FMNBA196

Invalid data beyond final end tag

Explanation: Invalid XML - data found beyond final end tag.

User response: None.

Programmer response: This message is followed by FMNBA665 or FMNBA666 and FMNBA667, which display the line number and line text where the error occurred. Either the length of the XML or XML sent is in error. Correct the XML input and retry.

FMNBA197

Severe internal error processing XML

Explanation: This message is preceded by other messages that indicate what the severe error was. This is most likely to be an insufficient memory issue.

User response: None.

Programmer response: This message is followed by FMNBA665 or FMNBA666 and FMNBA667, which display the line number and line text where the error occurred. Analyze the preceding messages and action appropriately. You may need to contact IBM® Support.

FMNBA198

Data around error: '&DATA'

Explanation: This is an informational message to display the XML where the error was detected. Its is followed by FMNBA199 which has a vertical bar to the current position the parser was processing when the error occurred.

User response: None.

Programmer response: This message is followed by FMNBA199 which indicates where the error occurred. Analyze the preceding messages and action appropriately. You may need to contact IBM® Support.

FMNBA199

Error occurred: '&DATA'

Explanation: This informational message follows the FMNBA198 message to indicate the exact location of the error.

User response: None.

Programmer response: This message is preceded by FMNBA198, which displays data around where the error occurred. Analyze the preceding messages and action appropriately. You may need to contact IBM® Support.

FMNBA214

Listing option changed to wide to support Text comparison

Explanation: You have requested TEXT comparison without the wide listing option. This is an informational message to say the listing option has been changed to accommodate TEXT comparison.

User response: None.

Programmer response: None.

FMNBA215

&nn Control sections processed

Explanation: This is an informational message produced by the view load module utility to document the number of control sections that were found.

User response: None.

Programmer response: None.

FMNBA216

Only the load module has been processed because the summary option is selected.

Explanation: This is an informational message produced by the view load module utility. The message documents the summary information on the load module only and no details of CSECTs because the summary option has been selected.

User response: None.

Programmer response: None.

FMNBA218

No disk record found

Explanation: The specified disk record does not exist on this track.

User response: If appropriate, specify a lower disk record number.

FMNBA219

No home address record

Explanation: A home address record was not found at the specified disk location. This is probably a hardware error.

User response: Rerun the function. If the problem recurs, contact your system support.

FMNBA220

Should new EOF be written after this record? Y or N

Explanation: The DRL function lets you change an end-of-file record into a record that has a KEY and DATA field (convert EOF to a data record).

User response: If you want a new end-of-file record to follow this record, reply **Y**. Otherwise, enter **N** or **U** to exit the function.

FMNBA230

Invalid element <&ELEM.> value: &VAL

Explanation: Either an attribute value or the data value for the specified element are invalid.

User response: None.

Programmer response: This message is followed by FMNBA665 or FMNBA666 and FMNBA667, which display the line number and line text where the error occurred. It may be preceded by messages giving more detail as to the specific problem. Correct the XML input and retry.

FMNBA231

Invalid CDATA ']]>' missing <&ELEM.>

Explanation: A CDATA tag has been provided but no end CDATA string was found.

User response: None.

Programmer response: This message is followed by FMNBA665 or FMNBA666 and FMNBA667, which display the line number and line text where the error occurred. Correct the XML input and retry.

FMNBA232

Child element <&ELEM.> with wrong parent

Explanation: The element specified is a child element, but has been specified with the wrong parent element.

User response: None.

Programmer response: This message is followed by FMNBA665 or FMNBA666 and FMNBA667, which display the line number and line text where the error occurred. Correct the XML input and retry.

FMNBA233

<&ELEM.> not specified

Explanation: A required element has not been specified.

User response: None.

Programmer response: This message is followed by FMNBA665 or FMNBA666 and FMNBA667, which display the line number and line text where the error occurred. Correct the XML input and retry.

FMNBA234

Library number &no exceeds number of <library> elements

Explanation: A <member lib="&no" ...> value has been specified where the library number exceeds the number of <library>data set name </library> value provided previously.

User response: None.

Programmer response: This message is followed by FMNBA230 to identify the element, and by messages FMNBA665 or FMNBA666 and FMNBA667 which display the line number and line text where the error occurred. Correct the XML input and retry.

FMNBA235

Attribute &ATTR invalid value &VAL

Explanation: The attribute value specified is invalid for the current element.

User response: None.

Programmer response: This message is followed by FMNBA230 to identify the element, and by messages FMNBA665 or FMNBA666 and FMNBA667 which display the line number and line text where the error occurred. Correct the XML input and retry.

FMNBA236

Template could not be updated - criteria would be lost

Explanation: During template editing an update was requested by providing the <copybooks> ... </copybooks> tags. The copybooks provided deleted fields that were referenced previously in criteria in the template and the template cannot be updated without this criteria information being lost.

User response: None.

Programmer response: Change the template to remove the field references that have been deleted in the latest version of the copybooks or change the copybooks to include the required field references and retry the update. Alternatively you can specify the REPLACE=YES option to override the existing template.

FMNBA237

id attribute not specified or invalid symbol number - &ID

Explanation: The <layout> id attribute is either missing or the value specified is not a valid 01 symbol reference number in the template.

User response: None.

Programmer response: This message is followed by FMNBA230 to identify the element, and by messages FMNBA665 or FMNBA666 and FMNBA667 which display the line number and line text where the error occurred. Correct the XML input and retry.

FMNBA238

related01="&ID." attribute specified invalid symbol number

Explanation: The related01 attribute specifies a value that is not a valid 01 symbol reference number in the template for related ID. A related 01 must be a symbol reference of an 01 layout other than the current layout.

User response: None.

Programmer response: This message is followed by FMNBA230 to identify the element, and by messages FMNBA665 or FMNBA666 and FMNBA667 which display the line number and line text where the error occurred. Correct the XML input and retry.

FMNBA239

type attribute not specified or invalid - &TYPE

Explanation: The <criteria > tag has been specified without the required type attribute or the type attribute does not specify one of the following values: ID, RID or SEL.

User response: None.

Programmer response: This message is followed by FMNBA230 to identify the element, and by messages FMNBA665 or FMNBA666 and FMNBA667 which display the line number and line text where the error occurred. Correct the XML input and retry.

FMNBA240

byfield="1" required for dynamic template

Explanation: The <criteria > tag must specify byfield="1" attribute value for a dynamic template.

User response: None.

Programmer response: This message is followed by FMNBA230 to identify the element, and by messages FMNBA665 or FMNBA666 and FMNBA667 which display the line number and line text where the error occurred. Correct the XML input and retry.

FMNBA241

Only type="SEL" allowed for dynamic template.

Explanation: The `<criteria>` tag must specify `type="SEL"`. Any other type value is invalid.

User response: None.

Programmer response: This message is followed by FMNBA230 to identify the element, and by messages FMNBA665 or FMNBA666 and FMNBA667 which display the line number and line text where the error occurred. Correct the XML input and retry.

FMNBA242

Expression exceeds allowable length.

Explanation: The specified expression causes the template segment block to exceed the maximum allowed 32760 bytes.

User response: None.

Programmer response: Reduce the expression length. This message is followed by FMNBA230 to identify the element, and by messages FMNBA665 or FMNBA666 and FMNBA667 which display the line number and line text where the error occurred. Correct the XML input and retry.

FMNBA243

Expression error around offset &nn.

Explanation: The specified expression is invalid. The offset provided is the byte location into the expression where the error was detected.

User response: None.

Programmer response: Check any preceding error message and correct the expression. This message is followed by FMNBA230 to identify the element, and by messages FMNBA665 or FMNBA666 and FMNBA667 which display the line number and line text where the error occurred. Correct the XML input and retry.

FMNBA244

Symbol `ref=&REF` is invalid for current layout - Should be in range `&LOW` to `&HIGH`.

Explanation: The reference number specified on the `<symbol>` tag is invalid for the current layout. Must be a number in the range shown in the message.

User response: None.

Programmer response: Correct the reference number. This message is followed by FMNBA230 to identify the element, and by messages FMNBA665 or FMNBA666 and FMNBA667 which display the line number and line text where the error occurred. Correct the XML input and retry.

FMNBA245

Symbol `ref=&ref` out of order

Explanation: When you are creating a dynamic template the symbols references must be provided in sequence starting from 2.

User response: None.

Programmer response: Correct the reference number. This message is followed by FMNBA230 to identify the element, and by messages FMNBA665 or FMNBA666 and FMNBA667 which display the line number and line text where the error occurred. Correct the XML input and retry.

FMNBA246

Symbol ref=&ref start valure required

Explanation: When you are creating a dynamic template the start attribute must be specified.

User response: None.

Programmer response: Specify the start value. This message is followed by FMNBA230 to identify the element, and by messages FMNBA665 or FMNBA666 and FMNBA667 which display the line number and line text where the error occurred. Correct the XML input and retry.

FMNBA247

Symbol ref=&ref start value cannot be zero

Explanation: When you are creating a dynamic template the start attribute value cannot be zero for non offset start values.

User response: None.

Programmer response: Provide a positive integer value for start or specify offset="1" on the <symbol > tag. This message is followed by FMNBA230 to identify the element, and by messages FMNBA665 or FMNBA666 and FMNBA667 which display the line number and line text where the error occurred. Correct the XML input and retry.

FMNBA248

Symbol ref=&ref Invalid type attribute.

Explanation: When you are creating a dynamic template the type attribute must be one of these values:

C

Alphanumeric

AN

Alphanumeric

AX

Alphanumeric displayed in long hexadecimal

VC

Varying character

ZC

Varying character null terminated

B

Binary

BI	Binary
P	Packed decimal
PD	Packed decimal
ZD	Zoned decimal
FE	External floating point
FP	Internal floating point
BT	Bit string
VB	Varying bit
G	Graphic string
VG	Varying graphic

User response: None.

Programmer response: Specify a valid type attribute. This message is followed by FMNBA230 to identify the element, and by messages FMNBA665 or FMNBA666 and FMNBA667 which display the line number and line text where the error occurred. Correct the XML input and retry.

FMNBA249

Symbol ref=&ref Invalid length attribute.

Explanation:

When you are creating a dynamic template the length attribute must be one of these values:

PD	Must be between 1 and 16.
BI	Must be 1, 2, 4 or 8.
ZD	Must be between 1 and 32.
FP	Must be 4 or 8.
FE	Must be >6 and <24. The precision is the length minus 6. The scale is the precision minus 1.

DBCS strings

Must be an even number of bytes.

User response: None.

Programmer response: Specify a valid length attribute. This message is followed by FMNBA230 to identify the element, and by messages FMNBA665 or FMNBA666 and FMNBA667 which display the line number and line text where the error occurred. Correct the XML input and retry.

FMNBA252

Output tape not positioned at load point or after EOF labels

Explanation: The output tape is not positioned correctly to write a labeled data set. Valid positions are the load point and after another labeled file.

User response: Ensure that the tape is positioned correctly and rerun the function, or rerun the function without label processing.

FMNBA253

No xxxxxx label found on input tape

Explanation: The tape indicated is not a standard label tape, or is not positioned correctly.

User response: Mount a labeled tape. Position it at the data set you want to process and rerun the function, or rerun the function without label processing.

FMNBA254

No xxxxxx label found on output tape

Explanation: The output continuation volume is not a standard label tape.

User response: Ensure that all output volumes are initialized with standard labels and rerun the function, or rerun the function without label processing.

FMNBA260

Symbol ref=&ref heading too long.

Explanation: The <heading> value cannot exceed 20 bytes in length.

User response: None.

Programmer response: Specify a shorter heading. This message is followed by FMNBA230 to identify the element, and by messages FMNBA665 or FMNBA666 and FMNBA667 which display the line number and line text where the error occurred. Correct the XML input and retry.

FMNBA261

Symbol ref=&ref <createn> element invalid for non numeric symbol.

Explanation: The <createn> value should not be specified for the current symbol because its not numeric.

User response: None.

Programmer response: Remove the <createn> element. This message is followed by FMNBA230 to identify the element, and by messages FMNBA665 or FMNBA666 and FMNBA667 which display the line number and line text where the error occurred. Correct the XML input and retry.

FMNBA262

element value too long

Explanation: The value specified for the element exceeds the allowable length for this element.

User response: None.

Programmer response: Correct the length of the element data. This message is followed by FMNBA230 to identify the element, and by messages FMNBA665 or FMNBA666 and FMNBA667 which display the line number and line text where the error occurred. Correct the XML input and retry.

FMNBA263

Element in conflict with previously specified elements or type

Explanation: The element specified in the following FMNBA230 message cannot be specified here because it is dependant on specific attributes being set in a parent or it has exceeded the allowed occurrence number for this element. Here is a list of possible problems: Template <scramble> specifications

- <translate> has been specified without `<scramble type="3">` being specified.
- <range> has been specified and conflicts with <scramble> type or a dsn attribute.
- <value> has been specified and conflicts with the <scramble> type or previous <range> specification.
- <sval> has been specified when a value list is not expected. Normally indicates a <scramble> dsn attribute was specified.

Editor <hex> specification

- <hex> tag has been specified more than once.

User response: None.

Programmer response: This message is followed by FMNBA230 to identify the element, and by messages FMNBA665 or FMNBA666 and FMNBA667 which display the line number and line text where the error occurred. Correct the XML input and retry.

FMNBA264

Required attributes not specified.

Explanation: The element requires certain attributes to be specified as documented in the associated schema:

- <translate> has been specified without incol, outcol or dsn attributes.
- <range> has been specified without min or max attributes.

User response: None.

Programmer response: This message is followed by FMNBA230 to identify the element, and by messages FMNBA665 or FMNBA666 and FMNBA667 which display the line number and line text where the error occurred. Correct the XML input and retry.

FMNBA265

Scramble translate attribute requires translate element.

Explanation: `<scramble type="3">` has been specified and a `<translate>` element is then expected to specify the translate options. The `<translate>` element has not been specified.

User response: None.

Programmer response: This message is followed by FMNBA230 to identify the element, and by messages FMNBA665 or FMNBA666 and FMNBA667 which display the line number and line text where the error occurred. Correct the XML input and retry.

FMNBA267

`<criteria>` must specify `byfield="1"` for `<byline>` to be valid

Explanation: A `<byline>` element requires `<criteria byfield="1">` and this has not been specified on the parent `<criteria>` element.

User response: None.

Programmer response: This message is followed by FMNBA230 to identify the element, and by messages FMNBA665 or FMNBA666 and FMNBA667 which display the line number and line text where the error occurred. Correct the XML input and retry.

FMNBA268

`<describe>` exceeds maximum 5 elements.

Explanation: Too many `<describe>` elements have been specified.

User response: None.

Programmer response: This message is followed by FMNBA230 to identify the element, and by messages FMNBA665 or FMNBA666 and FMNBA667 which display the line number and line text where the error occurred. Correct the XML input and retry.

FMNBA269

template required - command cannot be processed.

Explanation: A `<describe>` or `<layout>` element is being processed for a non-dynamic template and the TMPX session was invoked without a template.

User response: None.

Programmer response: This message is followed by FMNBA230 to identify the element, and by messages FMNBA665 or FMNBA666 and FMNBA667 which display the line number and line text where the error occurred. Correct the XML input and retry.

FMNBA271

<copybooks> can only be specified for a copybook template

Explanation: You have specified the <copybooks> element for a non-copybook or dynamic template.

User response: None.

Programmer response: Remove the <copybooks> element and children. This message is followed by FMNBA230 to identify the element, and by messages FMNBA665, or FMNBA666 and FMNBA667 which display the line number and line text where the error occurred. Correct the XML input and retry.

FMNBA273

related01="&ID." attribute specified without type="RID" attribute

Explanation: A <criteria > element has been specified incorrectly. The type="RID" attribute must be specified if a related01 attribute has been specified.

User response: None.

Programmer response: Correct the XML to specify type="RID" attribute. This message is followed by FMNBA230 to identify the element, and by messages FMNBA665 or FMNBA666 and FMNBA667 which display the line number and line text where the error occurred. Correct the XML input and retry.

FMNBA278

Element has exceeded maximum occurrences

Explanation: The element value as described in the following FMNBA230 message exceeds the maximum occurrences allowed for this element. See relevant schema.

User response: None.

Programmer response: This message is followed by FMNBA230 to identify the element, and by messages FMNBA665 or FMNBA666 and FMNBA667 which display the line number and line text where the error occurred. Correct the XML input and retry.

FMNBA279

Required element or child element not specified.

Explanation: Either the element value or a required child element has not been specified. This is issued for the <replace> element when either <repfrom> or <repto> are missing, or when <repfrom> or <repto> element is specified without any data.

User response: None.

Programmer response: This message is followed by FMNBA230 to identify the element, and by messages FMNBA665 or FMNBA666 and FMNBA667 which display the line number and line text where the error occurred. Correct the XML input and retry.

FMNBA281

Error on xxxxx tape, not a valid Exported Stacked Volume

Explanation: The volume loaded for input to the EVC (copy) or EVL (list) function is not a valid Exported Stacked Volume. Either the volume has been corrupted or the wrong volume has been requested. Processing cannot continue.

User response: Correct the input and retry the request.

FMNBA282

Error on xxxxx tape, bad table of contents on input volume

Explanation: The volume loaded for input to the EVC (copy) or EVL (list) function has a corrupted Table of Contents. Processing cannot continue.

User response: Correct the input and retry the request.

FMNBA283

Error logical volume xxxxx not found in TOC of volume vvvvvv

Explanation: The volume loaded for input to the EVC (copy) or EVL (list) function does not contain the requested logical volume in its Table of Contents. Processing continues.

User response: Correct the input and retry the request.

FMNBA284

Error duplicate logical volume vvvvvv in request list

Explanation: A duplicate logical volume name has been entered into the logical volume request list. Processing does not continue.

User response: Correct the input and retry the request.

FMNBA298

Output volume xxxxxx not long enough for logical volume vvvvvv

Explanation: Output volume is not long enough to contain the logical volume being copied. This is a report line (not a message number) for the EVL list function.

User response: Mount an output volume of suitable length.

FMNBA299

Error code *nn* processing Exported Stacked Volume

Explanation:

An unexpected error occurred while processing the input Exported Stacked Volume. The error code *nn* gives an indication of the problem:

01-03

Initial input volume positioning error. Possible drive error.

06-10

Error processing header labels on input volume. Possible bad input volume.

15-24

Error during Exported Stacked Volume verification process. This is not a volume created by the VTS export function, or the volume has become corrupted.

30-34

Error reading the Table of Contents file from the Exported Stacked Volume. The Table of Contents file on the Exported Stacked Volume may be corrupted.

40-48

Logical volume could not be correctly located on the Exported Stacked Volume. The volume may be corrupted.

49

Logical volume could not be correctly located on the Exported Stacked Volume. The drive on which the input Exported Stacked Volume is mounted may not support the locate block CCW, or the volume may be corrupted.

50-51

Error during copy process. Possible drive error.

55-58

Error during listing process. Possible drive error.

60-62

Error positioning output volume. Possible drive error.

66-79

Internal VTS record format error. The volume may be corrupted.

85-86

Error writing to output volume. Possible drive error.

90-93

Unable to obtain storage for work areas. Error codes 90-92 indicate that the storage has been requested above the 16M line. Error code 93 indicates that the storage has been requested below the 16M line.

95

General copy error. See earlier message for more detailed error code.

User response: Take corrective action according to the error code.

FMNBA301

unit is invalid device for this function

Explanation: The specified device has a type which cannot be used in the function you invoked. (For example, the input device for a disk function is a tape unit.)

User response: Use a valid device for this function, or use a File Manager function appropriate for the device specified.

FMNBA310

Data set *dsname* not found

Explanation: No data set *dsname* was found on the unit specified, or in the VSAM catalog used.

User response: Correct the data set name in the DD statement, in the File Manager invocation, or in the control statement.

FMNBA311

No *ddname* DD statement supplied

Explanation: *ddname* is a ddname referred by an INPUT or OUTPUT parameter, or any other ddname used by File Manager. Either the corresponding DD statement is missing, or the ddname was used and freed by a TLT function.

User response: Correct the JCL or the INPUT or OUTPUT parameter, and rerun the job. To access a tape again after a TLT function, end the job step and continue with another step.

FMNBA314

WARNING: *dsname* in use. *function* continues without exclusive control

Explanation: You invoked a disk update function for a data set already in use by another task.

User response: Ensure that your update request does not expose the data or the other task and continue, or run the function when the data set is available for exclusive control.

FMNBA315

Data set request denied by SVC99 validation routine

Explanation: A dynamic allocation request was rejected by your system's SVC99 validation routine. This is probably due to a restriction imposed by your system.

User response: Contact your system support.

FMNBA316

ddname DD open failed, ABEND code *abend-reason*

Explanation: The data set or tape specified by *ddname* could not be opened.

User response: Refer to the accompanying system message, and check the status of the data set or tape.

FMNBA317

Invalid xxxxxx data set for function xxx

Explanation: The function that you specified cannot be used with the data set that you specified. For example, a VSAM function cannot process a sequential data set.

User response: Specify a function capable of processing the data. You can use basic disk functions to inspect data with unknown organization.

FMNBA318

type data set *ddname macro* failed, ABEND code *xxxx-xxx*

Explanation: The indicated operation failed for the indicated data set.

User response: Check for any accompanying system messages, and refer to the appropriate system manual.

FMNBA319

type data set *ddname macro* RC *xxxx-xxxx*

Explanation: The indicated operation failed for the indicated data set.

User response: Check for any accompanying system messages, and refer to the appropriate system manual.

FMNBA320

No SYSPRINT DD statement supplied

Explanation: By default, report output is written to SYSPRINT. Sections of the output can be directed instead to the following ddnames:

FMNROPT

File Manager active options

FMNRPRM

\$\$FILEM command parameters and return codes

FMNRPRC

REXX procedure statements read from SYSIN

FMNREPT

Command reports and return codes

FMNRSUM

TALLY summary report

If FMNPRINT is present in the JCL, it is used instead of SYSPRINT. File Manager requires SYSPRINT to be allocated if alternate ddnames are not specified.

User response: Specify either a SYSPRINT or FMNPRINT DD statement, then rerun the job.



Tip: If all of the special-purpose FMNRxxx ddnames are provided, SYSPRINT or FMNPRINT is not required. (This is the only case in which you do not need to specify SYSPRINT or FMNPRINT.)

FMNBA321

EOV for *xxxx* failed, ABEND code *xxxx-xxxx*

Explanation: An ABEND occurred during EOV processing for the indicated tape.

User response: Check for any accompanying system messages, and refer to the appropriate system manual. If the problem persists, contact your system support.

FMNBA322

SL and NON SL functions cannot be used in the same execution

Explanation: The first function that was used on the tape volume required standard label processing, but the function you are trying to use requires non-standard label processing. The tape volume must be reallocated for non-standard label processing.

User response: Allocate the tape for non-standard label processing and retry the function.

FMNBA323

SL and NEW requested for NON SL function

Explanation: The tape volume was allocated for standard label output processing, but the function you tried to use requires non-standard label processing.

User response: Allocate the tape for non-standard label processing and retry the function.

FMNBA331

Permanent I/O error on *input/output* ECB *hhhhhhh*

Explanation: An unexpected return code was returned for a read or write operation (where *hhhhhhh* is the ECB value for the associated operation).

User response: Refer to the corresponding system message for more information.

FMNBA332

Permanent data check on *input/output*, CSW *csw*, sense *code*

Explanation: This is probably a hardware error.

User response: Refer to the hardware device reference manual for an interpretation of the CSW and the sense bytes.

FMNBA333

Read error, incorrect block length on *input/output*

Explanation: A block of the *input/output* data set does not correspond to the data set's format description from the VTOC or DD statement.

User response: Change the DCB parameter of the DD and rerun the job, or try using a tape or disk function instead of a QSAM function to process this data set.

FMNBA350

Block size (*xxxx*) invalid for FIXED, *reclsize* output

Explanation: The block size of a fixed unblocked data set must be the same as the record size.

User response: Specify a different block size or a different record size.

FMNBA351

Input data length (*length*) not multiple of *reclsize* (*reclsize*)

Explanation: An input block or record has a length that is not equal to, or a multiple of, the output record size.

User response: Correct the input specification or use the SET PAD processing option to adjust the input records.

FMNBA352

Block size (*nnnnn*) exceeds maximum (*max*)

Explanation: For a QSAM output function, you specified a block size greater than the maximum supported value.

User response: Specify a smaller block size.

FMNBA353

Record size (*reclsize*) exceeds maximum (*max*)

Explanation:

A record exceeds the maximum record size allowed for the output data set. This message might be issued if an output data set has inconsistent RECSIZE and BLKSIZE parameters. For example:

- RECFMOUT=VB and BLKSIZE is less than RECSIZE + 8
- RECFMOUT=V, B, or DB, and BLKSIZE is less than RECSIZE + 4

User response: Specify a smaller record size, or change the output data set definition.

FMNBA354

Block size (*blksize*) not multiple of record size (*reclsize*)

Explanation: A block consists of one or more records. The block size must be the same as the record size, or a multiple of the record size.

User response: Specify a different block size or a different record size.

FMNBA355

Record size (*nnnnn*) invalid for FIXED,*nnnnn* output

Explanation: The record size encountered is not compatible with the output specifications.

User response: Correct the input or output specification or use the SET PAD processing option to adjust the input records.

FMNBA356

Inconsistent record size (*nnnnn*) for FIXED,*nnnnn* input

Explanation: The record size encountered is not compatible with the input specifications.

User response: Correct the input or output specification.

FMNBA358

Inconsistent record length field X'*nnnnn*'

Explanation: While reading variable-length (blocked) input, File Manager found a data block whose record-length field contains either zero or a number greater than the physical length of the data block.

User response: Correct the input data, limit processing to stop before the incorrect block, or correct the input specifications.

FMNBA359

REXX variable *var* is empty

Explanation: The indicated REXX variable does not contain a string, or is not defined.

User response: Initialize the REXX variable in your procedure with the desired value before invoking File Manager.

FMNBA360

REXX Stem count *var* invalid

Explanation: The indicated REXX variable does not contain a valid number, or is not defined.

User response: Initialize the REXX variable in your procedure with the correct stem count before invoking File Manager.

FMNBA361

Incorrect block length field X'xxxx', block *nnnn*, length *nnnn*

Explanation: The indicated block does not contain variable format data, or the value in the block descriptor field is different from the physical length of the data block.

User response: Correct the input data, limit processing to stop before the incorrect block, or correct the input specifications.

FMNBA362

Incorrect record length field X'xxxx', block *nnnn*, offset *nnnn*

Explanation: The indicated block does not contain variable format data, or the value in a record descriptor field is invalid for deblocking.

User response: Correct the input data, limit processing to stop before the incorrect block, or correct the input specifications.

FMNBA363

Incorrect spanned record segmentation, block *nnnn*, record *nnnn*

Explanation: The indicated block contains a segment of a variable spanned record which cannot be assembled to an entire record.

User response: Correct the input data, limit processing to stop before the incorrect block, or correct the input specifications.

FMNBA370

Key positioning not possible

Explanation: You cannot specify a key position with control interval access or a NONINDEXED VSAM input.

User response: Remove the key position specification.

FMNBA371

Output data set not ESDS

Explanation: You are using the TV function with the *nfiles* parameter, to copy more than one tape data set to a single VSAM data set. The output VSAM data set must be an entry-sequenced data set.

User response: Specify an ESDS as the output data set.

FMNBA372

Inconsistent key length or key position

Explanation: You have copied records from one VSAM key-sequenced data set to another VSAM key-sequenced data set. The output data set has a different key position or key length than the input data set.

User response: Check that you really intended to change the key position or key length.

FMNBA375

VSAM *macro* RC *rc*, Error Code X'xx' *yyy*

Explanation: A VSAM macro returned with an unexpected code. The message includes the failing macro, the return and error codes, and, for some errors, an additional explanation. For more information, refer to the documentation of your current release of VSAM.

X'xx' is, in hexadecimal:

- The error byte of the ACB if OPEN or CLOSE failed
- The error byte of the RPL if POINT, GET, or PUT failed
- The contents of Register 0 if SHOWCB or TESTCB failed

yyy might present additional information about the error.

User response: Take corrective action as described in the documentation for your current release of VSAM.

FMNBA378

VSAM catalog RC *nn*, RSCD IGG0CLxx - *nnn*...

Explanation: Catalog management returned these return and reason codes as a result of a catalog error or exceptional condition. For an explanation of these codes, refer to the documentation of the system message IDC3009I. If the error is related to a single catalog entry, the defective entry is flagged in the SCS output and the function continues.

User response: Take the appropriate action based on the explanation of the codes.

FMNBA380

Sub system name must be 1-4 bytes long

Explanation: The subsystem name specified for the resource is longer than 4 bytes.

User response: Correct the subsystem name.

FMNBA381

Sub system name required

Explanation: When defining an IMS™ or Db2® resource the subsystem name must be provided as part of the resource name.

User response: For IMS™ the resource name is in the form I1:*subsys:dbdname*. For Db2® the resource name is in the form D2:*subsys:location.owner.name*. Ensure that the *subsys* component is specified.

FMNBA382

LOCATION.OWNER.NAME value required

Explanation: When defining a Db2® resource the object name is required.

User response: For Db2® the resource name is in the form D2:*subsys:location.owner.name*. Ensure that the object name is specified correctly.

FMNBA383

DBD name required

Explanation: For IMS™ the resource name is in the form I1:*subsys:dbdname*. The *dbdname* has not been specified.

User response: Specify a valid DBD name.

FMNBA384

DBD name too long.

Explanation: For IMS™ the resource name is in the form I1:*subsys:dbdname*. The *dbdname* must be 1 - 8 characters. The specified value exceeds 8 characters.

User response: Specify a valid DBD name.

FMNBA385

Invalid template type

Explanation: The template specified must be an IMS™ view for an IMS™ resource, a Db2® template for a Db2® resource, or a File Manager Base component template for a Base resource (such as a data set, MQ queue, or HFS file).

User response: Specify a valid template for the resource being defined.

FMNBA386

Only supported from ISPF

Explanation: The view option for an IMS™ or Db2® resource is only supported when running under ISPF. This operation cannot be performed from FM/CICS.

User response: Use the ISPF interface to view the resource.

FMNBA387

Masking on

Explanation: The TESTMASK command or the editor MASK command has been issued, and this resulted in masking being turned on for the current edit or view session.

User response: None. Information only.

FMNBA388

Masking off

Explanation: The TESTMASK command or the editor MASK command has been issued, and this resulted in masking being turned off for the current edit or view session.

User response: None. Information only.

FMNBA393

OPEN warning code X'xx' yyy. Continue ? Y or N

Explanation: VSAM OPEN returned a warning code indicated in the message. File Manager lets you decide whether to ignore the condition or to exit from the function. For more information, refer to the documentation of your current release of VSAM.

User response: Take corrective action as described in the documentation for your current release of VSAM. Enter **Y** to continue, or **N** to exit from the function.

FMNBA394

OPEN warning code X'nn'(condition). Processing continues.

Explanation: VSAM OPEN returned a warning condition. The reason code is documented in manual DFSMS Macro Instructions for Data Sets. File Manager attempts to continue processing.

Condition is a terse form of the explanation for some reason codes, as given by DFSMS Macro Instructions for Data Sets as follows:

```
X'4C' previously interrupted
X'60' data set flagged unusable
X'64' Alternate index not built
X'68' time stamp mismatch
X'6C' time stamp mismatch
X'74' not properly closed
```

User response: Consider the terse description and consult the DFSMS Macro Instructions for Data Sets manual for the OPEN reason code listed to determine if this condition is expected.

FMNBA395

Recovery from invalid RBA (nnnn) failed

Explanation: VSAM rejected the RBA you entered. An attempt to locate the first record with a higher RBA also failed.

User response: Enter an RBA matching the beginning of a record.

FMNBA396

SHOWCAT for *input/output* data set failed, RC *rc*

Explanation: A VSAM SHOWCAT macro failed (giving return code *rc*) while searching for information about the specified data set. For an explanation of these codes, refer to the documentation for your current release of VSAM. If the SHOWCAT macro failed for a VSAM alternate index operation, it might show incorrect return codes because of VSAM recovery action.

User response: Take the appropriate action based on the explanation of the codes.

FMNBA397

DIV *req* request error, RC *nn*, Reason Code *rsn*

Explanation: A data-in-virtual macro has failed. The message includes the type of macro request and the reason code. For an explanation of the return code and reason code, refer to the documentation for your current release of your z/OS® system.

User response: Take the appropriate action based on the explanation of the codes.

FMNBA401

Input/Output tape on *unit* is *vol1*, not *volser*.

Explanation: The tape that the operator mounted is not the volume requested.

User response: Ensure that you are using the correct volumes, check for incorrectly specified volume serial numbers, and rerun the function.

FMNBA407

Tape volume to be labeled on *unit*. Enter '*volser*', Cancel - U

Explanation: Standard label output was specified, but the named tape volume is not labeled. The system waits for a reply.

User response: Enter a serial identification to be used for the volume, or enter to cancel.

FMNBA409

Unexpired file *name date* on tape *unit,vol1*. Ignore - I, Cancel - U

Explanation: The expiration date on the volume mounted as the output tape was not reached. The system waits for a reply.

User response: Ensure that the tape can be used for output and enter to continue, or enter to cancel.

FMNBA411

Ready *unit*, then press ENTER

Explanation: The unit *unit* is not ready. The system waits for a reply.

User response: Ensure that the correct device is attached and assigned. Ready the device and press Enter. Enter , , , or to terminate.

FMNBA413

Manual unload/rewind detected on *unit*, press ENTER to rewind and continue

Explanation: A manual operator intervention occurred on the indicated unit. The system waits for a reply.

User response: Press Enter to rewind and continue, or enter `QUIT`, `CANCEL`, `EXIT`, or `EOJ` to terminate.

FMNBA420

Line &NO Syntax error detected at column &COL in the following statement.

Explanation: You are running a procedure with *FASTREXX ON specified and the procedure has failed FASTREXX syntax checking for the statement beginning at the line number specified. For continued statements the line number represents the first line for the statement. The column position is the position into the continued statement as printed. This message will be preceded by more detailed messages.

User response: None.

Programmer response: Check the preceding messages and correct the procedure. If this message is produced and a template expression is being run then an internal error has occurred and you need to contact IBM® Support.

FMNBA421

Keyword being processed: &KWD

Explanation: You are running a procedure with *FASTREXX ON specified and the procedure has failed FASTREXX syntax checking when processing the keyword referenced.

User response: None.

Programmer response: Check the preceding messages and correct the procedure.

FMNBA422

&statement

Explanation: This message is used to print the procedure statement (including continuations) that was being processed when the syntax error occurred, or to list the expected keywords when a keyword is processed that is not expected.

User response: None.

Programmer response: Check the preceding messages and correct the procedure.

FMNBA423

Error - one of the following keyword expected.

Explanation: This message indicates the keyword being processed is not expected and is followed by a list of expected keywords.

User response: None.

Programmer response: Check the following messages and correct the procedure.

FMNBA424

The function is incomplete - no closing parenthesis found

Explanation: A FASTREXX function has been coded incorrectly - a right parenthesis is missing.

User response: None.

Programmer response: Provide the missing parenthesis and rerun.

FMNBA425

The condition is incomplete

Explanation: A FASTREXX condition is incomplete - either the left hand side is expected or the right hand side has not been specified.

User response: None.

Programmer response: Correct the condition and rerun.

FMNBA426

Incomplete DO levels in procedure - END statements required

Explanation: A DO or SELECT statement does not have a matching END statement.

User response: None.

Programmer response: Provide the missing end statements and rerun.

FMNBA427

Incomplete quoted string - closing quote/apostrophe required

Explanation: A literal value has been coded that begins with a quotation mark or apostrophe and no ending quotation mark or apostrophe has been coded.

User response: None.

Programmer response: Provide the closing quotation mark or apostrophe and rerun.

FMNBA428

Incomplete comment - closing */ required

Explanation: A REXX comment is incomplete.

User response: None.

Programmer response: Provide the closing */ and rerun.

FMNBA429

Invalid continuation comma on last statement in procedure

Explanation: A comma has been coded as the last non blank character in the procedure.

User response: None.

Programmer response: Correct by either removing the comma or providing the continued statement and rerun.

FMNBA430

Right parenthesis missing

Explanation: A conditional statement has unbalanced left and right parenthesis.

User response: None.

Programmer response: Provide the same number of right and left parenthesis in the conditional statement referenced and rerun.

FMNBA431

Invalid operator found in condition

Explanation: The specified operator is not an operator that has is supported for FASTREXX processing.

User response: None.

Programmer response: Correct the operator to be valid REXX operator and rerun.

FMNBA432

Keyword not supported for FASTREXX processing

Explanation: The keyword is either a REXX keyword or external function that is not supported for FASTREXX processing.

User response: None.

Programmer response: Either change the keyword to an equivalent FASTREXX supported keyword or remove the *FASTREXX ON card to allow REXX to process.

FMNBA433

Internal error - Format template ptr for &nn.th record type is zero.

Explanation: The runtime control blocks for a Template have been corrupted and an expression that relies on them cannot be run.

User response: None.

Programmer response: Contact IBM® Support.

FMNBA434

Internal error - FASTREXX Function &FUN not found in File Manager REXX function load module FMNRXFUN

Explanation: FMNRXFUN load module is not the same level or version as the FMNMAIN load module.

User response: None.

Programmer response: Installation problem. Check where these load modules are being run from and ensure your job is loading the correct modules. Contact your systems programmer and check your installation.

FMNBA435

Internal error - File Manager load modules FMNMAIN and FMNRXFUN are not at the same version/level

Explanation: FMNRXFUN load module is not the same level or version as the FMNMAIN load module.

User response: None.

Programmer response: Installation problem. Check where these load modules are being run from and ensure your job is loading the correct modules. Contact your systems programmer and check your installation.

FMNBA436

Function &FUN function call failed rc = &RC.

Explanation: The specified function failed with the specified return code. This is normally a problem with the parameters passed to the function.

User response: None.

Programmer response: Check the preceding messages which should indicate the problem with the function parameters - correct and rerun.

FMNBA437

SIGNAL statement has no label

Explanation: A SIGNAL statement has been coded without a label value.

User response: None.

Programmer response: Provide the correct label value for the statement and rerun.

FMNBA438

Internal function coded incorrectly.

Explanation: This is an internal error that occurs running with a template. The internal function generated for the template expression is incorrect.

User response: None.

Programmer response: Contact IBM® Support.

FMNBA440

Line &nn Expression always true at column &col in the following statement

Explanation: Informational message to say the indicated condition is always true.

User response: None.

Programmer response: Correct the logic if required.

FMNBA441

Line &nn Expression always false at column &col in the following statement

Explanation: Informational message to say the indicated condition is always false.

User response: None.

Programmer response: Correct the logic if required.

FMNBA442

logical value not 0 or 1

Explanation: You have specified a constant for a condition and only a 0 or 1 maybe specified..

User response: None.

Programmer response: Correct the condition and rerun.

FMNBA443

Field reference

Explanation: This message may be produced when listing the expected keywords for message FMNBA423. It indicates that a field reference (#nn) is an allowed keyword.

User response: None.

Programmer response: Examine all related messages and correct the procedure accordingly.

FMNBA444

SIGNAL &label statement unresolvable

Explanation: A signal statement has referenced a label name that has not been coded in the procedure.

User response: None.

Programmer response: Either provide the label or correct the SIGNAL statement to refer to a valid label name and rerun.

FMNBA445

No executable logic in procedure

Explanation: The procedure is made up of non executable instructions and therefore cannot be run.

User response: None.

Programmer response: A procedure must have at least one statement that can be run to be a valid procedure.

FMNBA446

SIGNAL &lab causes infinite loop

Explanation: The SIGNAL &label causes an infinite loop because the specified label is the label for the SIGNAL instruction.

User response: None.

Programmer response: Correct the logic flow and rerun.

FMNBA448

Constant - numeric or character

Explanation: This message may be produced when listing the expected keywords for message FMNBA423. It indicates that a numeric or character literal is an allowed keyword.

User response: None.

Programmer response: Examine all related messages and correct the procedure accordingly.

FMNBA449

File Manager external function

Explanation: This message may be produced when listing the expected keywords for message FMNBA423. It indicates that a File Manager external function is an allowed keyword.

User response: None.

Programmer response: Examine all related messages and correct the procedure accordingly.

FMNBA450

External CICS® interface program DFHXCIS cannot be loaded

Explanation: DFHXCIS module cannot be loaded via an OS load service. Generally this means the cicshlq.SDFHEXCI has not been included in the TASKLIB, STEPLIB, or LINKLIST for the current File Manager function.

User response: None.

Programmer response:

Check the File Manager setup. Make sure the cicshlq.SDFHEXCI load library is defined in the following ways depending on how you are using File Manager:

- to the STEPLIB or the LINKLIST (for a TSO or batch session)
- to the FMNLIB or LINKLIST for the ADFzCC server (when using the File Manager Eclipse plug-in or FM/CICS)

See "Setting up CICS® access for File Manager Base component and Eclipse plug-in" in the *File Manager Customization Guide*.

FMNBA451

External CICS® interface &FUNC failed Resp=&RESP, Reason=&REAS

Explanation: File Manager has attempted to access a CICS® region using the external CICS® interface and has failed to perform the function &FUNC with the response code and reason codes shown in the message. This is normally indicative of a setup problem

User response: None.

Programmer response: Ensure that the steps documented in "Setting up CICS® access for File Manager Base component and Eclipse plug-in" in the *File Manager Customization Guide* have been performed. If they have been completed successfully then refer to the manual CICS® Transaction Server for z/OS® CICS External Interface Guide and search for the function documented in the message. The response and reason codes are documented. Check them and action accordingly or contact IBM® Support.

FMNBA453

External CICS® interface - DPL CICS® LINK failed RESP=&RESP, RESP2=&RESP2, Abend=&ABCODE

Explanation: File Manager has attempted to access a CICS® region using the external CICS® interface and has failed to perform the a DPL CICS® Link to the FMN3CICS program with the responses documented in the message. This would normally be a setup problem.

User response: None.

Programmer response: Ensure that the steps documented in "Setting up CICS® access for File Manager Base component and Eclipse plug-in" in the *File Manager Customization Guide* have been performed. If they have been completed successfully then refer to the *CICS® Transaction Server for z/OS® CICS® External Interface Guide* and search for the function documented in the message. The response and reason codes are documented. Check them and action accordingly or contact IBM® Support.

FMNBA454

Failed to start server CICS® applid &CICS failed RC=&RC RESP=&RESP, RESP2=&RESP2

Explanation: File Manager has attempted been unable to start a server task in the CICS® region requested.

User response: None.

Programmer response: This message precedes FMNBA462 messages which can be used to determine why the server task failed. Contact IBM® Support for more assistance.

FMNBA455

Socket create failed Rc=&RC,Reason=&RSN

Explanation: A UNIX™ System Service BPX1SOC to create a TCPIP socket has failed with the reason codes specified.

User response: None.

Programmer response: Refer to *z/OS® UNIX™ System Services Messages and Codes* for the reason code in the message. If you cannot determine the problem from the manual then contact IBM® Support.

FMNBA456

Socket connect failed Rc=&RC,Reason=&RSN

Explanation: A UNIX™ System Service BPX1CON to connect a socket to the CICS® region server task has failed with the reason codes specified.

User response: None.

Programmer response: Refer to *z/OS® UNIX™ System Services Messages and Codes* for the reason code in the message. If you cannot determine the problem from the manual then contact IBM® Support.

FMNBA457

Send to CICS® applid &CICS failed Rc=&RC,Reason=&RSN

Explanation: A UNIX™ System Service BPX1SND has failed to send data to the CICS® region for the reason code specified.

User response: None.

Programmer response: Refer to *z/OS® UNIX™ System Services Messages and Codes* for the reason code in the message. If you cannot determine the problem from the manual then contact IBM® Support.

FMNBA458

Receive from CICS® applid &CICS failed Rc=&RC,Reason=&RSN

Explanation: A UNIX™ System Service BPX1RCV has failed to receive data to the CICS® region for the reason code specified.

User response: None.

Programmer response: Refer to *z/OS® UNIX™ System Services Messages and Codes* for the reason code in the message. If you cannot determine the problem from the manual then contact IBM® Support.

FMNBA459

Send failed for logoff command CICS® applid &CICS failed Rc=&RC,Reason=&RSN

Explanation: A UNIX™ System Service BPX1SND has failed to send the logoff command to the CICS® region for the reason code specified.

User response: None.

Programmer response: Refer to *z/OS® UNIX™ System Services Messages and Codes* for the reason code in the message. If you cannot determine the problem from the manual then contact IBM® Support.

FMNBA460

Socket close failed for CICS® applid &CICS failed Rc=&RC,Reason=&RSN

Explanation: A UNIX™ System Service BPX1CLO has failed to close a socket that had been established with the CICS® region for the reason code specified.

User response: None.

Programmer response: Refer to *z/OS® UNIX™ System Services Messages and Codes* for the reason code in the message. If you cannot determine the problem from the manual then contact IBM® Support.

FMNBA461

CICS® server task failed to obtain port for CICS® applid &CICS®

Explanation: File Manager has tried to initiate the FM transaction as a background server task in the specified CICS® system and the started task has either failed to respond within 25 seconds or has not been able to obtain a TCPIP PORT number to be used for the communications that follow.

User response: None.

Programmer response: Check the status of the CICS® region to ensure a task can be started and ensure the CICS® region has been set up for TCPIP communications. If the problem persists contact IBM® Support.

FMNBA462

&CICS_MESSAGE

Explanation: This message is preceded by FMNBA454 and contains the error message encountered by the server task during initialization processing.

User response: None.

Programmer response: Address the error described by the message text or contact IBM® Support.

FMNBA463

Socket getaddrinfo failed Rc=&RC,Reason=&RSN

Explanation: A UNIX™ System Service BPX1GAI has failed to get the address information using the PORT and host name provided by the CICS® region. A connection to the CICS® region cannot be performed.

User response: None.

Programmer response: Refer to *z/OS® UNIX™ System Services Messages and Codes* for the reason code in the message. If you cannot determine the problem from the manual, then contact IBM® Support.

FMNBA464

No FMNCICS DD to produce CICS® Applid list

Explanation: A generic or blank CICS® APPLID has been entered in the data set name field for a function that will attempt to produce a selection list of CICS® APPLIDs from the FMNCICS DD and the FMNCICS DD has not been allocated to the session.

User response: None.

Programmer response: Perform the step to set up the FMNCICS DD as documented in *“Setting up CICS® access for File Manager Base component and Eclipse plug-in”* in the *File Manager Customization Guide*.

FMNBA465

Invalid attributes for FMNCICS file must be fixed 80

Explanation: The data set identified by the FMNCICS DD statement does not have a logical record length of 80 or is not fixed blocked.

User response: None.

Programmer response: Perform the step to set up the FMNCICS DD as documented in the *“Setting up CICS® access for File Manager Base component and Eclipse plug-in”* in the *File Manager Customization Guide*.

FMNBA466

Member name required in FMNCICS DD

Explanation: FMNCICS DD refers to a PDS or PDSE and a member name has not been specified.

User response: None.

Programmer response: Specify the member name on the DD statement and rerun the function.

FMNBA467

The FMNCICS DD has no records - no applid list can be produced

Explanation: FMNCICS DD refers to an empty data set or member, so no generic selection list can be produced.

User response: None.

Programmer response: Edit the data set or member and provide a list of CICS® applids and descriptions as specified in *“Setting up CICS® access for File Manager Base component and Eclipse plug-in”* in the *File Manager Customization Guide*.

FMNBA470

Authentication DD FMNAUTH not found and required for remote system access.

Explanation: You are running a File Manager function in batch or keyword mode and it references a remote resource. File Manager requires the authentication data set that contains the remote definition allocated to the DD name FMNAUTH.

User response: None.

Programmer response: Provide a //FMNAUTH DD card for batch JCL or allocate the FMNAUTH DD if running under TSO to the appropriate authentication file.

FMNBA471

Invalid attributes for FMNAUTH - required RECFM VB with LRECL >= &recl

Explanation: A File Manager function is being processed that references a remote resource and the authentication file (DD FMNAUTH) points to a data set with invalid attributes. &recl is the minimum logical record length allowed.

User response: None.

Programmer response: Delete and allocate the authentication file with record format VB, and a LRECL greater than or equal to the value specified in the message. The data set organization can be physical sequential or partitioned. If a partitioned data set is specified then the allocation or JCL DD card must specify a member name.

FMNBA472

Member name required in FMNAUTH DD.

Explanation: A File Manager function is being processed that references a remote resource and the authentication file (DD FMNAUTH) points to a partitioned data set and a member name has not been provided with the data set name.

User response: None.

Programmer response: Provide a JCL DD or allocation for the DD FMAUTH that includes the appropriate member name.

FMNBA473

FMNAUTH dataset - record &recno length &RECL too long

Explanation: The authentication file contains invalid information. This may have been caused by editing the authentication file outside of File Manager or an internal error during File Manager processing.

User response: None.

Programmer response: If the file has not been changed outside of File Manager then report the problem to IBM® Support. File Manager will present you with a list of valid credentials if other records are valid. By making a change to the credentials presented File Manager should correct the authentication data set.

FMNBA474

FMNAUTH dataset - record &RECNO contains corrupted data.

Explanation: The authentication file contains invalid information. This may have been caused by editing the authentication file outside of File Manager or an internal error during File Manager processing.

User response: None.

Programmer response: If the file has not been changed outside of File Manager then report the problem to IBM® Support. File Manager will present you with a list of valid credentials if other records are valid. By making a change to the credentials presented File Manager should correct the authentication data set.

FMNBA479

No selection was made for a remote system.

Explanation: A list of remote system has been presented and no selection has been made.

User response: None.

Programmer response: Select an remote system or remove the remote identifier in the resource name.

FMNBA480

Messages from remote system

Explanation: The remote system processing produced messages which will be displayed after this message.

User response: None.

Programmer response: View the proceeding messages and take the appropriate action.

FMNBA481

Messages from remote system

Explanation: The remote system processing produced messages which will be displayed after this message.

User response: None.

Programmer response: View the proceeding messages and take the appropriate action.

FMNBA482

Cannot connect to remote systems for this session.

Explanation: This indicates that another task in the address space has a signal handler and File Manager will not be able to initialize a Language Environment® with POSIX(ON) which is required for the session to perform communications with a remote system.

User response: None.

Programmer response: Normally this applies to ISPF where another session has a language environment that has been initialized with POSIX(ON). You may have to exit that session and depending on whether the address space still appears to be in a dubbed state you may need to logoff and logon again.

FMNBA483

No socket

Explanation: You are running a File Manager function that references a remote resource. An error occurred when creating a socket to connect to a remote File Manager, which may be one of:

- Permission to create a socket of the specified type or protocol is denied.
- Resource temporarily unavailable.
- There has been a network or transport failure.
- Insufficient system resources are available to complete the call.
- There was no NETWORK statement in the parmlib member to match the AF_INET domain.

User response: None.

Programmer response: This is primarily a TCPIP socket environmental error. Check that TCPIP is configured and operating normally in your environment. Check that the region size is large enough to support some buffer allocations for sockets.

FMNBA484

Peer unresolvable

Explanation: The named peer could not be resolved to an IP address.

User response: Check the peer name is as intended.

Programmer response: Once confirmed that the peer name is correct, consult your TCPIP administrator to determine why the z/OS® resolver could not translate the name to an IP. One possibility is that name resolution from the z/OS® system being used may require a network suffix to be added to the name.

FMNBA485

Peer connect fail.

Explanation: When attempting to connect to a remote File Manager, the intended peer would not connect.

User response: Check the peer name and port number correctly reflect a running common server on the remote system.

Programmer response: This error occurs when the name of the peer has been resolved, but the connect to the common server at the specified port did not succeed. Presuming that the TCPIP stack is working ok on your current system, then the most likely cause is that the common server is not running on the remote system, or there is a firewall blocking the port connection.

FMNBA486

Check server

Explanation: This message indicates that the remote address and port were contactable, however the response was not recognized. This can occur if the port specified is not that of a common server, or if the common server was stopping while attempting to connect to it.

User response: None.

Programmer response: Confirm that the port is the port of the remote common server. Also confirm that the remote common server is running. Lastly, check that no firewall is creating unexpected traffic on the intended port (e.g an unexpected firewall redirect or authorisation)

FMNBA487

TLS Handshake failed

Explanation: This message indicates the handshake between this machine and the target remote system did not complete.

User response: None.

Programmer response: Programmer Response: Most likely cause is that a setup step has been missed. The certificate of the remote system must be known to the local system for the handshake to complete. Consult the *File Manager Customization Guide* for the required steps to achieve this.

FMNBA488

No signon message

Explanation: The remote system server did not respond to the attempt to signon. This indicates an error with the remote system.

User response: None.

Programmer response: Investigate the remote system server.

FMNBA489

Server does not have FM

Explanation: The remote system server is not configured with an FM entry.

User response: None.

Programmer response: Check that the server name and port is correct. Otherwise complete the configuration of the server on the remote server to include a File Manager configuration.

FMNBA490

Invalid password

Explanation: The password given is not valid for the given user ID on the remote system.

User response: Correct the password.

Programmer response: None.

FMNBA491

Invalid parameter

Explanation: The remote server did not recognize a parameter while signing on. This indicates a configuration or level problem in the remote server.

User response: None.

Programmer response: Investigate the remote server configuration. Tracing may need to be activated on the remote server in order to identify and resolve the problem.

FMNBA492

Server environment error

Explanation: The remote server encountered a setup issue when attempting to process the user signon. Most likely the remote server is not running from a program controlled library.

User response: None.

Programmer response: Investigate the remote server configuration. Tracing may need to be activated on the remote server in order to identify and resolve the problem.

FMNBA493

Expired password

Explanation: The password for the specified user ID on the remote server is expired.

User response: Reset or renew the password for the remote system.

Programmer response: None.

FMNBA494

New password no good

Explanation: Check the password rules for the target system and respecify the new password.

User response: Reset or renew the password for the remote system.

Programmer response: None.

FMNBA495

Server setup error

Explanation: The target server has an authorisation problem and is not permitted to process the request.

User response: Report to remote server administrator.

Programmer response: Check the SYSLOG of the target server. The most likely cause is that the user ID of the server is not permitted to the BPX.SERVER resource.

FMNBA496

Unknown userid

Explanation: The user ID specified is not known by the target system.

User response: Check the user ID and remote server details and enter the correct details.

Programmer response: None.

FMNBA497

Unusable userid

Explanation: The user ID was refused. Most likely it is revoked on the target system.

User response: Check the user ID access on the remote system. Most likely a request to have the user ID resumed will be needed.

Programmer response: None.

FMNBA498

Unusable userid

Explanation: The user ID was refused.

User response: Check the user ID access on the remote system. Most likely a request to have the user ID resumed will be needed.

Programmer response: If the user ID can logon through other means, this indicates a setup problem with the remote server. Server tracing may need to be activated to help identify the problem.

FMNBA499

Common client error

Explanation: An error occurred invoking client.

User response: If the available virtual storage in the region was low, release or increase the region size and retry.

Programmer response: If the problem persists, check the load libraries for FMNCL.

FMNBA516

SSSARSN reason code &RC returned from IEFSSREQ Service request

Explanation: A nonzero reason code has been returned from the IEFSSREQ service function SSOBSSMS. The reason code is documented in the IBM-supplied IEFSSSA macro.

User response: Contact your systems programmer.

FMNBA517

Cannot connect to Db2®, CAF *request* RC *xx*, Reason Code *xx*

Explanation: File Manager failed to connect to Db2®. The indicated Call Attach Facility request did not complete successfully.

User response: Contact your Db2® administrator.

FMNBA518

Unexpected RC *xx* returned from IEFSSREQ *request*, token *nnnnnn*

Explanation: A subsystem request to retrieve OAM storage group information from SMS failed with an unexpected return code.

User response: Contact your system support.

FMNBA519

Function terminated by OAM environment error

Explanation: File Manager failed to establish connection with OAM.

User response: Contact system support.

FMNBA520

OAM *req* failed, RC *rc*, Reason Code *rsn*

Explanation: The requested OAM function failed.

User response: For an explanation of the return code and reason code, refer to the documentation for your current release of z/OS®.

FMNBA521

Directory *request* failed, Db2® not accessible

Explanation: The requested OAM function failed. File Manager could not access Db2®.

User response: Contact your Db2® administrator.

FMNBA522

Directory *request* failed, Db2® privilege not granted

Explanation: Your user ID is not authorized to access the object directory tables as required.

User response: Contact your Db2® administrator. For a list of tables, refer to the *File Manager for z/OS Customization Guide*.

FMNBA523

Directory *request* failed, unexpected SQL RC *rc*

Explanation: The requested OAM function failed. An unexpected return code was received from SQL.

User response: Contact your Db2® administrator.

FMNBA524

OAM STORE failed, collection not found or definition denied

Explanation: An OSREQ STORE request failed because the target collection could not be found, or the user is not authorized to define a new one.

User response: Check your installation SMS specifications for correct class values if necessary.

FMNBA525

Directory *request* failed with RC *rc*, trying again...

Explanation: The requested OAM function failed with an SQL return code indicating a locked Db2® resource. This is an information message only. File Manager continues and reissues the SQL request.

FMNBA526

Directory *request* failed with SQL RC *rc*, Db2® resource locked

Explanation: The requested OAM function failed with an SQL return code indicating a locked Db2® resource.

User response: Rerun the function. If the problem persists, contact your Db2® administrator.

FMNBA529

Skip count exceeds *bytes* byte object size

Explanation: You asked to skip more bytes than the object contains. You have effectively asked File Manager not to print any data.

User response: Specify a lower skip count value.

FMNBA530

No object header found on input, specify collection and object name

Explanation: The input data did not contain object header records, thus no defaults for collection and object name are available.

User response: Specify the collection and object name and rerun the function. To create input data with header records, use functions OS or OV with the HEADER option.

FMNBA534

STOR/MGMT class value overridden by defaults

Explanation: An OSREQ STORE has completed, but it could not use the Storage Class or Management Class that you specified. Default values for the collection were used instead.

User response: Check your installation SMS specifications for correct class values if necessary.

FMNBA538

Input data not in object dump format

Explanation: An input record was found with unexpected contents, or end of input occurred before the end of an object.

User response: Correct the input data and rerun the function.

FMNBA539

nnn object(s) could not be dumped

Explanation: Backup of one or more objects failed. File Manager issues this message at the end of the function. Message FMNBA200 shows the OAM error information for each failing object.

User response: Check the File Manager output for message FMNBA200 and take appropriate actions.

FMNBA558

Migrate successful

Explanation: A request to use DFSMSHsm HMIGRATE to migrate a data set was successful.

User response: None.

FMNBA559

Migrate failed, IKJEFTSR RC=*ikjrc*, RC=*rc* Reason=*reason*

Explanation: A request to use DFSMSHsm HMIGRATE to migrate a data set failed. The attempt to run the command using IKJEFTSR gave return code *ikjrc*, and the command gave return code *rc* with reason code *reason*.

User response: Refer to the IKJEFTSR return code in the *z/OS TSO/E Programming Services* collection and the return and reason code from the HMIGRATE command in the *z/OS DFSMSHsm Diagnosis* collection in IBM® Knowledge Center.

FMNBA590

Format of DB field incorrect at offset *nnnnn*

Explanation: The format of the indicated double-byte character set field is incorrect. File Manager found a double-byte field that has an odd length. File Manager issues this message for only the first incorrect field it finds. It prints this message at the end of the record, and replaces the last character with an EBCDIC blank (X'40'). The function continues.

FMNBA591

Mixed field ends before end of DB subfield at offset *nnnnn*

Explanation: The double-byte character set (DBCS) subfield, at the offset shown, was not reset at the end of a mixed DBCS and EBCDIC field. For example, there might be no shift in (X'0F') character marking the end of a double-byte field in mixed DBCS and EBCDIC data. File Manager issues this message for only the first incorrect field it finds. It prints this message at the end of the record. The function continues.

User response: Correct the field definition in the FMT command. Rerun the function.

FMNBA592

One or more records with incorrect DB fields found

Explanation: File Manager has detected incorrect double-byte character set fields in one or more records. File Manager prints this message at the end of the listing. It indicates that File Manager issued one or more error messages. The function continues.

User response: Check the listing for message FMNBA590 or FMNBA591 to find the incorrect record.

FMNBA600

Minimum requirement to run this level of File Manager is z/OS®

Explanation: To run File Manager for z/OS® V14R1, you need z/OS®.

User response: You cannot run File Manager on your system.

FMNBA601

Minimum requirement to run File Manager is DFP 3.3

Explanation: To run File Manager for z/OS® , you need MVS/DFP Version 3 Release 3 or later.

User response: You cannot run File Manager on your system.

FMNBA604

Load of module '*name*' failed, module not found

Explanation: File Manager cannot find a module which is required for your File Manager invocation. This module might have been deleted or protected (for example, if the functions supported by this module are not needed at your installation).

User response: If you need to use this function, contact your system support.

FMNBA605

Successfully recovered from ABEND

Explanation: An ABEND occurred while File Manager was running. Depending on the circumstances, a dump might be produced.

User response: Check for any system error or File Manager message and take corrective actions. If the problem persists, contact your system support.

FMNBA606

FILE MANAGER ENCOUNTERED AN INTERNAL ERROR - CODE *NNNN*

Explanation: File Manager encountered an internal problem. The error is identified by the File Manager error code.

User response: Contact your system support.

FMNBA607

FILE MANAGER ABENDED WITH CODE *CODE* - REASON *REASON*

Explanation: An abend occurred while File Manager was running. *code* is the z/OS® abend code; *reason* contains additional information that is available for some cancel codes and abend codes.

User response: Refer to the documentation for your current release of the z/OS® system.

FMNBA608

Load of module *xxxxxxx* failed, ABEND code *nnnn-*nnn**

Explanation: An attempt to load the specified module failed with an unexpected error. *nnnn-*nnn** is the z/OS® ABEND and REASON code.

User response: Refer to the accompanying system message or the system code, and take appropriate action.

FMNBA609

Access to REXX variable pool failed, *xxx* R15 *nn*

Explanation: During an attempt to establish connection with the REXX variable pool system services failed.

User response: Contact your system support.

FMNBA610

Unexpected code returned from REXX variable interface, RC *nn*

Explanation: During an attempt to read from or write to the REXX variable pool the REXX system interface returned an unexpected result.

User response: Contact your system support.

FMNBA613

I/O error on *unit*, ECB *ecb*, CSW *csw*, sense 0-3 *sense*

Explanation: An unrecoverable I/O error occurred on the indicated device.

User response: Ensure that you are using the correct device, and that it is set online correctly. Scan the console log for an I/O error message, and save it. If the error persists, give the message text to your system support.

FMNBA620

XML input data set must be sequential.

Explanation: This is issued when the XML input is not on a sequential data set or not a member in PDS or PDSE. The data set organization is not supported.

User response: None.

Programmer response: Change the XML input so it is coming from a sequential data set or a member of a PDS or PDSE and rerun the job.

FMNBA621

name=&NAM attribute error. Invalid 01 name

Explanation: Either the <layout name='value'> or the <criteria rname='value'> have referred to a field name that cannot be matched to an 01 layout name in the current template.

User response: None.

Programmer response: Change the name or rname value to be a valid 01 name for the current template.

FMNBA622

copybook=&CPY attribute error. Name cannot be matched or previously processed

Explanation: The copybook attribute of the <layout> element refers to a 1 - 8 byte copybook member name. This member must be a valid copybook that was used to build the template. The <layout copybook='&CPY'> can only be repeated for the number of 01s in the referenced copybook. You have either specified a copybook name that isn't referenced in this template or you have repeated the definition more times than the number of 01 layouts referenced in this copybook.

User response: None.

Programmer response: If you are updating an old template (REPLACE=NO) and you haven't specified <copybooks> then you may need to rebuild this template so the copybook names can be used for the <layout>. Do this by specifying the relevant

<copybook> elements. Otherwise correct the copybook name or remove the excessive <layout> elements and rerun the process.

FMNBA623

name=&NAM attribute error. Field name cannot be matched

Explanation: The name attribute value specifies a field name that cannot be located in the current template.

User response: None.

Programmer response: Correct the field name and rerun the process.

FMNBA628

A fully qualified member name is required

Explanation: You have specified either an output member mask or not specified an output member name when the input data set is sequential or you have specified an output sequential file without a blank or generic input member name.

User response: None.

Programmer response: Specify a valid member name and rerun the process.

FMNBA629

Template exported to XML successfully

Explanation: Successful completion of an export function.

User response: None.

Programmer response: None.

FMNBA630

&MEMCNT members read &UPCNT Exported &REPCNT Not replaced &ERRCNT Errors

Explanation: Statistical summary message for export template function

User response: None.

Programmer response: None.

FMNBA631

&MEMCNT members read &UPCNT Exported &REPCNT Export replaced &ERRCNT Errors

Explanation: Statistical summary message for export template function

User response: None.

Programmer response: None.

FMNBA634

&MEMCNT members read &UPCNT Imported &REPCNT Import Updated &ERRCNT Errors

Explanation: Statistical summary message for import template function

User response: None.

Programmer response: None.

FMNBA635

&MEMCNT members read &UPCNT Imported &REPCNT Import replaced &ERRCNT Errors

Explanation: Statistical summary message for import template function

User response: None.

Programmer response: None.

FMNBA649

SVC99 *type* failed, RC *rc*, ERR *ec*, SMS RSCD *ic ddname*

Explanation: The indicated SVC99 (allocation) operation failed. The failure occurred during SMS processing.

User response: For explanations of *rc*, *ec*, and *ic*, refer to the documentation for your current release of z/OS®.

FMNBA650

SVC99 *type* failed, RC *rc*, ERR *ec*, INFO *ic ddname*

Explanation: The indicated SVC99 (allocation) operation failed.

User response: For explanations of *rc*, *ec*, and *ic*, refer to the documentation for your current release of z/OS®.

FMNBA651

Locate macro failed, RC *rc*, REG0 X'xxxxxxxx'

Explanation: Unexpected return code from the LOCATE macro.

User response: For an explanation of the return code and register contents, refer to the documentation for your current release of z/OS®.

FMNBA652

TIOT scan error, *ddname* not found

Explanation: An error occurred while scanning the z/OS® control block TIOT. This is probably a File Manager error.

User response: Exit File Manager and rerun the function. If the problem persists, contact your system support.

FMNBA653

DSCB/JFCB read for xxxxxxx failed, RC *rc*

Explanation: Unexpected return code when reading the DSCB or JFCB.

User response: For an explanation of the return code, refer to the descriptions of the macros OBTAIN and RDJFCB in the documentation for your current release of z/OS®.

FMNBA654

UCB scan error, RC *rc*, Reason Code *rsn*

Explanation: A UCB scan operation (to determine the device) failed with an unexpected return code.

User response: For an explanation of the return code, refer to the description of the UCBSCAN macro in the documentation of your current release of z/OS®.

FMNBA655

TSO Service Facility call error - RC *rc*, Reason Code *rsn*

Explanation: An unexpected return code was received from the TSO Service Facility. The TSO command was not executed.

User response: For an explanation of the return code and reason code, refer to the z/OS TSO/E Programming Services.

FMNBA661

Template imported from XML successfully

Explanation: Successful completion of an import function.

User response: None.

Programmer response: None.

FMNBA665

XML error occurred on line &LINE at offset &OFFSET

Explanation: This message provides the line number and line offset where the XML error occurred.

User response: None.

Programmer response: Look at the previous messages to determine the type of error, correct the XML line referenced and rerun the process.

FMNBA666

XML error occurred on line &LINE

Explanation: This message provides the line number where the XML error occurred.

User response: None.

Programmer response: Look at the previous messages to determine the type of error, correct the XML line referenced and rerun the process.

FMNBA667

Line:&line value

Explanation: This message displays the line where the XML error occurred.

User response: None.

Programmer response: Look at the previous messages to determine the type of error, then correct the XML line referenced and rerun the process.

FMNBA668

Function must be run with File Manager for IMS to process IMS™ template, views or criteria sets.

Explanation: You cannot create or update an IMS™ template view or criteria set when running the import function under the File Manager Base component. It must be run from the FM/IMS template options if running in full screen mode or using the program FMNIMS for batch processing.

User response: None.

Programmer response: Rerun the function in a File Manager/IMS environment.

FMNBA669

Function must be run with File Manager for Db2® to process Db2® templates.

Explanation: You cannot create or update a Db2® template when running the import function under the File Manager Base component. It must be run from the FM/Db2 template options if running in full screen mode or using the program FMNDB2 for batch processing.

User response: None.

Programmer response: Rerun the function in a File Manager/Db2 environment.

FMNBA670

XML template type does not match the existing target template to be updated.

Explanation: You are trying to import a template from XML with REPLACE=NO meaning the XML is used to update the existing template. The existing template is as different type to the XML template being imported.

User response: None.

Programmer response: Either change the type on the <template type='value'> element to match the template to be updated or change the import to specify REPLACE=YES.

FMNBA671

Element <&ELEM.> exceeds the maximum occurrence of &NO.

Explanation: The XML element is repeated more than the allowed number of occurrences for that element.

User response: None.

Programmer response: Correct the XML to remove the unnecessary element definitions and rerun the process.

FMNBA672

Element <&ELEM.> invalid for &TYPE template.

Explanation: The element is not valid for the type of template being processed.

User response: None.

Programmer response: Remove the element definition or correct the <template type='value'> to reflect the correct template type for the element.

FMNBA673

Copybook <member> element has not been found for segment=&seg.

Explanation: You are trying to import a IMS™ template from XML and you have not provided copybook definitions to describe all the segments defined to the corresponding data base.

User response: None.

Programmer response: Provide <member name='name' segname='segment'> values for all segments in the referenced DBD.

FMNBA674

One of the IMS™ template libraries is not a PDS or PDS/E data set.

Explanation: The associated template data set for a view or criteria set import is not a PDS or PDSE. This could have been specified using the <imstp>data set name</imstp> element. The data set name may also be obtained from the existing view or criteria set for REPLACE=NO, or the existing template definitions for FM/IMS found either on the panels or in the options module definition.

User response: None.

Programmer response: Correct the IMS™ template library definitions and rerun the process.

FMNBA675

Template &TP for View or Criteria set was not found.

Explanation: The associated template member for a view or criteria set cannot be found in the current template libraries. The template member name is obtained from the <dbd>name</dbd> definition or for REPLACE=NO can be obtained from the existing view or criteria set definition.

User response: None.

Programmer response: Ensure the associated template member can be found. This may require providing <imstp>data set name</imstp> elements to identify the location of the template member.

FMNBA676

Template &TP for View or Criteria set is corrupted.

Explanation: The associated template member for a view or criteria set cannot be loaded because it contains invalid data for a File Manager/IMS template.

User response: None.

Programmer response: Recreate the template member or correct the template data sets (<imstp> definitions) and ensure the associated template member being loaded is a valid FM/IMS template.

FMNBA677

Cannot create a template of type: &type

Explanation: The import routine cannot create the template for one of the following reasons.

- The template is a BASE or IMS™ template and <copybook> elements have not been supplied to create the template.
- The template is a Db2® template and <db2object> element has not been provided.
- The template is an IMS™ view or criteria and <imstp> and <dbd> elements have not been provided.
- The template you are trying to import is an IMS™ extract template - this type of template can only be updated. REPLACE=NO must be specified and the template must exist.

User response: None.

Programmer response: Provide the <copybooks> elements so the template can be created.

FMNBA678

Attribute &ATTR invalid for &TYPE template.

Explanation: The attribute specified is not allowed for the type of template being processed.

User response: None.

Programmer response: Either remove the attribute or change the template type to a type that supports the attribute referenced in the message.

FMNBA679

<dbd> element is require for &TYPE template.

Explanation: You are trying to create a FM/IMS view or criteria set and you have not specified <dbd>name</dbd> which is required to create a view or criteria set.

User response: None.

Programmer response: Provide the associated DBD name via the <dbd>name</dbd> elements and rerun the process.

FMNBA719

Change failed

Explanation: The File Manager Find/Change utility could not change one or more strings because:

- The change string is longer than the find string and there is insufficient space in the record to accommodate the change string.
- An attempt is being made to change a VSAM KSDS key field, The key field will be identified with a 'K' next to the record number in the report.

User response: Change the find or change string to avoid the problem.

FMNBA730

Repository could not be allocated

Explanation: The template repository could not be allocated for one of the following reasons:

- The data set name could not be determined because there is no FMN4POPT REPOS definition or SYS1.PARMLIB definition or TPREPOS DD statement allocated.
- The data set name defined in the FMN4POPT REPOS keyword does not exist.
- You exited the **VSAM Define** dialog without saving the template repository data set.

User response: If the template data set name was set to ? to locate the repository template, customize a TPREPOS DD statement or use the REPOS keyword in either the FMN4POPT macro or SYS1.PARMLIB to point to a valid repository file. If the message was issued from an ISPF dialog then reenter the data set name in the **Template Repository Edit** dialog and then use the **VSAM Define** dialog to create the repository before continuing.

FMNBA731

Repository must be for a KSDS file

Explanation: The current template repository data set is not a valid VSAM KSDS.

User response: Confirm that the template repository data set is a VSAM KSDS with LRECL \geq 32756. If editing, import, or export repository functions are being run, change the repository data set name to a valid template repository KSDS file.

FMNBA732

Repository is a KSDS file with incorrect key attribute - must be offset 0 and length 255

Explanation: The template repository file should have a key length of 255 starting at offset 0.

User response: Use the repository edit function (ISPF option 7.7.1) to recreate the repository with the correct key attributes.

FMNBA733

Repository is a KSDS file with incorrect maximum record length attribute - should be 32756

Explanation: The template repository file should have a maximum record length (RECORDSIZE) of 32756.

User response: Use the repository edit function (ISPF option 7.7.1) to recreate the repository with the correct maximum record length attribute.

FMNBA736

The repository entry *entry_resource_name* has been deleted from the file

Explanation: A delete command has successfully been completed for *entry_resource_name*.

User response: None. Informational only.

FMNBA737

A repository has been either added or changed successfully.

Explanation: An insert or edit of a repository entry has successfully completed.

User response: None. Informational only.

FMNBA738

The resource name you have entered exists in the repository and the field values have been refreshed to reflect the current entry

Explanation: While editing or inserting a new repository entry you changed the resource name to the name of an existing entry. The other fields were changed to reflect this existing entry.

User response: None. Informational only.

FMNBA739

nnn entries exported successfully

Explanation: Informational message to indicate the number of records that were exported.

User response: None.

FMNBA750

Invalid entry element. Must have name or default attribute

Explanation: The XML element used for the repository import <entry> must specify either a `name="resource_name"` OR `base="1"` attribute. The element specified is invalid.

User response: Correct the XML in the import.

FMNBA751

Invalid entry element. "base=" must be the only attribute when specified

Explanation: If the `base` attribute is specified, no other attributes are valid for the <entry> element. It should be coded `<entry base="1">`.

User response: Correct the XML in the import.

FMNBA753

Repository file could not be initialized

Explanation: During the creation process of a new repository file the write for the initial record failed with a VSAM error.

User response: Check the corresponding VSAM errors. You might need to delete and recreate the repository file.

FMNBA754

The repository file contains no entries - insert new entry

Explanation: This occurs when editing a repository with no entries. This message is informational and is issued along with the repository update panel where the first entry can be defined.

User response: None.

FMNBA755

Entries *pp* processed *uu* Import updated *aa* Import added *ee* Errors

Explanation: This completion message is issued for the repository import function when the "Update entries" option is selected. The message shows the number of entries that were processed, added, or updated, and the number of processing errors that occurred.

User response: None. Informational only.

FMNBA756

Entries *pp* processed *uu* Import not updated *aa* Import added *ee* Errors

Explanation: This completion message is issued for the repository import function when the "Update entries" option is not selected. The message shows the number of entries that were processed, added, or not updated, and the number of processing errors that occurred.

User response: None. Informational only.

FMNBA758

No profile data sets selected

Explanation: This message is issued when exporting the template history and no ISPF profile data sets are selected from the displayed lists.

User response: Reenter and make selections for the ISPF profile data sets that contain history information to be exported and subsequently imported into the repository.

FMNBA759

No repository entry for the specified resource

Explanation: A template or copybook name has been specified with a ? and the associated data set name cannot be found in the current template repository.

User response: A template repository entry must be created before the ? value can be used for the template. If no repository entry can be created then the template name must be specified in full.

FMNBA760

Repository entry - template data set not found

Explanation: File Manager failed to allocate the template data sets associated with the repository entry and therefore could not load the repository template. A likely cause is that the template data set was deleted after the repository entry was created.

User response: Update the repository to reflect current template data sets and then retry the function.

FMNBA761

Repository entry - template load failed

Explanation: File Manager was unable to load the associated template. Check for any accompanying messages that might indicate why.

User response: Edit the repository entry and attempt to edit the associated template which should produce the primary errors associated with the load failure.

FMNBA762

MKDIR (BPX1MKD) service failed to create a new directory Rc=&RC, Reason=&RSN

Explanation: File Manager tried to create a new directory and the MKDIR command failed with the indicated return code and reason code.

User response: Refer to *z/OS® UNIX™ System Services Messages and Codes* to determine why the MKDIR command failed and action appropriately.

FMNBA820

Key area not mapped

Explanation: The layout specified does not map the key area of the record. Therefore a formatted key cannot be displayed.

User response: Either select a layout that can map the key field or position on a record mapped by a layout and enter FKEY with no layout.

FMNBA821

Layout not found

Explanation: The name you entered as a filter did not match any of the layouts in the current template.

User response: Use the "S" or "/" prefix commands to select a layout from the current listed layouts.

FMNBA822

No layout selected

Explanation: The user has exited the 01 Layout List Panel without selecting a layout. The FKEY command processing is terminated.

User response: None.

FMNBA823

Template required

Explanation: Formatted key processing requires a copybook or template to be provided to the edit, view or browse function.

User response: Specify the template or copybook that you require to map the key area.

FMNBA830

Picture string invalid

Explanation: You cannot use a picture string with numeric, bit, or Unicode fields.

User response: This message is only produced if only numeric bit or Unicode fields are the target of the search or change command. Either remove the picture clause, or change the scope so character fields can be searched.

FMNBB039

FASTPROC OUTFIL statement is not supported for this type of output data set

Explanation:

You ran a DSC function containing FASTPROC OUTFIL statements, and one of the following is true:

- The input data set has fixed length records, the output data set has variable length or undefined format records, and one of the following conditions is true:
 - The output record length is undefined
 - There is a user procedure or a template being used
 - The data is packed
 - The output is a PDS(E)
- The input data set has variable length or undefined format records, the output data set has fixed length records, and one of the following conditions is true:
 - There is a user procedure or a template being used
 - The output data set has longer records
- The input data set is a QSAM data set with spanned records with length exceeding 32747 and the output is a VSAM data set
- the output data set is a VSAM VRDS data set and the user requested a MOD disposition (instead of OLD)

User response: Recode the DSC function to avoid using FASTPROC OUTFIL statements. For example, you might need to recode it to use REXX statements in a REXXPROC.

FMNBB172

Error accessing CICS® resource *func=function Cond=condition Resp2=resp2*

Explanation: CICS® returned a non-zero condition after attempting to perform the listed function against the selected CICS® resource.

User response: Look up the listed *condition* and *resp2* values in the CICS Application Programming Reference or CICS System Programming Reference for further information about why the request failed.

In most cases (but not all) the listed function is the CICS® command that returned the non-zero condition. Below is a list of possible values for function and the CICS® command they relate to:

Function value	CICS command
INQSTART	INQUIRE
INQNEXT	INQUIRE
INQUIRE	INQUIRE
STARTBR	STARTBR
READ	READ
ENDBR	ENDBR
WRITE	WRITE
REWRITE	REWRITE
DELETE	DELETE
OPEN	SET (OPEN)
CLOSE	SET (CLOSE)
SET	SET
SYNCPT	SYNCPPOINT
DELETEQ	DELETEQ
ENQ	ENQ
DEQ	DEQ
INQGEN	INQUIRE
SET TASK	SET (TASK)
READNEXT	READNEXT
READPREV	READPREV
READUPD	READ (UPDATE)
DELQ	DELETEQ
READQ TD	READQ (TD)

FMNBB291

Function terminated. The user canceled the function, or the function could not be performed

Explanation: Errors were encountered that caused File Manager to terminate.

User response: Review the errors before this message to determine why File Manager was terminated.

FMNBB331

Fields referenced in the TO template don't exist in the FROM template.

Explanation: The To template has existing mapping and at least one of the fields it has been previously mapped to cannot be found in the from template. This indicates that the TO template has been either mapped to a different from template, or the from template has changed so that fields previously mapped cannot be found.

User response: If you are running under ISPF you should be given an option to regenerate the mapping fields and continue. For batch jobs, DSM, and DSC functions, the keyword CORRESP=YES can be used to regenerate a corresponding mapping. This way you can rerun the job with that keyword specified to override the existing mapping.

FMNBB537

Not running from APF Authorized libraries. Check STEPLIB/LINKLIST.

Explanation: File Manager, after being launched from the ADFzCC server, detected that it is not running APF authorized, which is required.

User response: Check that the steplib or linklist libraries have been correctly authorized. See also the *File Manager Customization Guide*.

FMNBB538

Terminating, not APF Authorized.

Explanation: File Manager is shutting down. This message is issued after FMNBB537.

User response: As for FMNBB537, check that the steplib or linklist libraries have been correctly authorized. See also the *File Manager Customization Guide*.

FMNBB573

Value data set record boundary exceeded for field FLD.

Explanation: The template does not correctly describe the data for field FLD. Processing is terminated. This occurs when the template describes a record with length LEN1 but a record read from a data set (described by the template) has a record length LEN2, LEN2 < LEN1.

User response: Determine why the template does not correctly describe the data, resolve the problem, and then retry the operation.

FMNBB631

You can only append to CICS® files - &CMD cannot be performed.

Explanation: A CREATE, REPLACE, SAVEAS command has been attempted to a CICS® file resource. These commands are not supported.

User response: None.

Programmer response: None.

FMNBB632

JCL option is not supported for CICS® resources.

Explanation: Option 3.6 or FCH batch with the JCL option is being run against a CICS® resource. The option is not supported.

User response: None.

Programmer response: Rerun the function with the option unspecified.

FMNBC003

The Websphere MQ feature has been disabled.

Explanation: A FACILITY class profile FMNMQ.DISABLE.*system_name* has been defined, and the current user ID has at least READ access. The result is that all File Manager MQ processing is disabled for this user ID.

User response: Consult with the security administrator to assess whether you should be allowed to run File Manager MQ processing on the system.

Programmer response: None.

FMNBC182

Global leading zeros ON. Leading zeros default to YES for all applicable numeric fields in the template.

Explanation: The template default for leading zeros is set to YES, so all applicable numeric fields are formatted with leading zeros when printing or viewing data with this template.

User response: None. This is an informational message to indicate the template leading zeros default is YES.

Programmer response: None.

FMNBC183

Global leading zeros OFF. Leading zeros default to NO for all applicable numeric fields in the template.

Explanation: The template default for leading zeros is set to NO, so all applicable numeric fields are formatted without leading zeros when printing or viewing data with this template.

User response: None. This is an informational message to indicate the template leading zeros default is NO.

Programmer response: None.

FMNBC184

Template locked. Template &MEMBER locked.

Explanation: The template with the name &MEMBER has been locked.

User response: None. This is an informational message to indicate the template is locked.

Programmer response: None.

FMNBC185

Template unlocked. Template &MEMBER unlocked.

Explanation: The template with the name &MEMBER has been unlocked.

User response: None. This is an informational message to indicate the template is unlocked.

Programmer response: None.

FMNBC250

UNIX service &serv failed

Explanation:

A z/OS® UNIX™ service was called, but returned a failure. Message FMNBC251 will follow. The &serv may be one of:

```
MVSSIGSETUP
SIGACTION
ACCEPT
READ
WRITE
```



```

WAIT
SOCKET
SETSOCKOPT
SET  KEEPALIVE
BIND
LISTEN
ASYNCIO
SPAWN
CLOSE
PASSWORD
GETPWNAM
SETUID
EXIT
ATTACH

```

User response: Examine the following message (FMNBC251)

FMNBC251

Unix Return value &rv, Return code &rc, reason code &RSN

Explanation: After the failure of a z/OS® UNIX™ System Services call, this lists the return value, return code, and reason code.

User response: Check the meaning of the reason code by either using BPXMTEXT (if it is available on your system, you can cut and paste the &RSN code and issue, from TSO, the command BPXMTEXT *reasoncode*, for an explanation of the z/OS® UNIX™ reason code) or by consulting the manual *z/OS® UNIX™ System Services Messages and Codes*.

FMNBC420

Date/time output format xxxxxxxx is not valid

Explanation: The output format specified for the date/time field is not a valid picture string for the z/OS® Language Environment® date and time services.

User response: Refer to z/OS® Language Environment® Programming Services, Appendix B, "Date and time services tables" for valid picture strings supported by z/OS® Language Environment®.

Programmer response: None.

FMNBC421

Invalid internal data type xx specified

Explanation:

The data type specified to override the field data type for date/time processing is not valid. The following are the valid data type values:

AN

Alphanumeric

B

Binary

BI

Binary

FE

External floating point

FP

Internal floating point

P

Packed decimal

PD

Packed decimal

ZD

Zoned decimal

User response: Specify one of the data types listed above.

Programmer response: None

FMNBC422

Date/time internal format is required

Explanation: The format used to store the date/time value in the field is required.

User response: Specify the internal format value.

Programmer response: None.

FMNBC423

Invalid data type for a date/time field

Explanation: The data type for a date/time field must be binary, floating point, packed decimal, zoned decimal, or alphanumeric.

User response: Specify one of the appropriate data types for the date/time field.

Programmer response: None.

FMNBC424

Internal format mask is too long

Explanation: The length of the user defined internal date/time format cannot be longer than the length of the alphanumeric field.

User response: Change the length of the internal date/time format.

Programmer response: None.

FMNBC425

Invalid internal date/time format

Explanation: The user defined internal date/time format specified is not a valid picture string for the z/OS® Language Environment® date and time services.

User response: Refer to z/OS® Language Environment® Programming Services, Appendix B, "Date and time services tables" for valid picture strings supported by z/OS® Language Environment®.

Programmer response: None.

FMNBC426

Data type must be character or binary for STCK/STCKE

Explanation: STCK or STCKE was specified as the internal format for the date and time field but the data type for the field is not character or binary.

User response: Specify AN or BI as the internal data type for the date and time field containing STCK/STCKE values.

Programmer response: None.

FMNBC427

Field length must be 8 bytes for STCK or 16 bytes for STCKE

Explanation: Date and time fields with an internal format of STCK or STCKE must have a length of either 8 or 16 bytes respectively in order to store TOD clock or extended TOD clock values.

User response: If possible change the size of the field to the required length or change the internal format specified for the date/time field.

Programmer response: None.

FMNBC428

Internal format mask is required

Explanation: The internal format mask parameter must be specified on the call to the CMP_DATE or CMP_TIME functions when there is no internal date/time format defined for the field in the template.

User response: None.

Programmer response: Specify the internal format mask parameter on the call to CMP_DATE or CMP_TIME.

FMNBC429

Output format mask is required

Explanation: The output format mask parameter must be specified on the call to the CMP_DATE or CMP_TIME functions when there is no date/time output format defined for the field in the template.

User response: None.

Programmer response: Specify the output format mask parameter on the call to CMP_DATE or CMP_TIME.

FMNBC430

Unique field name too long to generate CMP_DATE or CMP_TIME function.

Explanation: While attempting to build a qualified, unique field name to pass to the CMP_DATE or CMP_TIME functions, File Manager found the name would be greater than 255 bytes.

User response: None.

Programmer response: If possible try to change the data structure so that qualification will not result in such a long name.

FMNBC431

Conversion of date/time value to lilian seconds failed.

Explanation: z/OS® Language Environment® date and time services were unable to convert the field value to a Lilian seconds value.

User response: None.

Programmer response: Check that the field value is valid for the internal date/time format specified.

FMNBC432

Conversion from lilian seconds to lilian days failed.

Explanation: z/OS® Language Environment® date and time services were unable to convert the field value from Lilian seconds to Lilian days.

User response: None.

Programmer response: Check that the field value is valid for the internal date/time format specified.

FMNBC433

Conversion from lilian days to lilian seconds failed.

Explanation: z/OS® Language Environment® date and time services were unable to convert the field value from Lilian days to Lilian seconds.

User response: None.

Programmer response: Check that the field value is valid for the internal date/time format specified.

FMNBC434

Base date is required

Explanation: A base date must be provided if day, month, or year adjustment values have been specified.

User response: Specify a base date value.

Programmer response: None.

FMNBC435

Date/time output format is required

Explanation: The format used to display the date/time value is required.

User response: Specify an output format for the date/time field.

Programmer response: None.

FMNBC436

Start value for scrambling range is required

Explanation: If scrambling is required for the date/time field then a start value for the scrambling range must be provided.

User response: Specify a start value for the scrambling range.

Programmer response: None.

FMNBC437

End value for scrambling range is required

Explanation: If scrambling is required for the date/time field then an end value for the scrambling range must be provided.

User response: Specify an end value for the scrambling range.

Programmer response: None.

FMNBC438

Invalid date/time value specified

Explanation: The create base date, scrambling range start date, and scrambling range end date must be valid dates specified in the output format defined for the date/time field.

User response: Specify a valid date in the output format defined for the date/time field.

Programmer response: None.

FMNBC439

Error converting and storing a date/time value in the output field.

Explanation: During copy processing, creation or scrambling of a date/time value failed.

User response: Check that there is a valid date/time value in the input field.

Programmer response: None.

FMNBC440

Range start date/time must be before the range end date/time.

Explanation: When specifying scrambling options for a date/time field, the range start date/time must be before the range end value.

User response: Ensure the range start date/time is before the range end.

Programmer response: None.

FMNBC441

Scrambling type must be RANDOM or REPEAT.

Explanation: For XML for a date/time field, the scrtype (scrambling type) value must be RANDOM or REPEAT.

User response: None.

Programmer response: Specify either RANDOM or REPEAT as the value for the scrtype tag.

FMNBC442

The specified field does not contain numeric data.

Explanation: The field specified on a call to the STATS function is not defined as a numeric field in the template.

User response: None.

Programmer response: Specify a numeric field on the call to the STATS function or update the template to indicate the field is numeric.

FMNBC443

The ODPP API is unavailable to scramble field &FIELD.

Explanation: File Manager could not initialize the ODPP framework so the ODPP API is unavailable for scrambling the field name referenced.

User response: Ensure that the FMNODPP DD has been allocated, ensure that it is a single session, and check for any preceding messages that might explain why the environment could not be initialized.

Programmer response: None.

FMNBC444

Corrupt template - ODPP segment 45 not found for field &FIELD.

Explanation: This should not occur and indicates the template is corrupt.

User response: To repair the template you can attempt to export and import it.

Programmer response: None.

FMNBC445

The ODPP API is unavailable

Explanation: File Manager could not initialize the ODPP framework so the ODPP API is unavailable.

User response: Ensure that the FMNODPP DD has been allocated, ensure that it is a single session, and check for any preceding messages that might explain why the environment could not be initialized.

Programmer response: None.

FMNBC448

Date mask &MASK is invalid for field &FIELD attributes.

Explanation: If the date mask is the internal data mask then the field name specified is not able to support that mask. The most common cause would be its length isn't sufficient to contain the mask. If the date mask is the output date mask then it may be incompatible with the internal date mask.

User response: None.

Programmer response: Change the date masks or the field length to be compatible with each other.

FMNBC449

For DB2 the only valid DATE formats are 'YYYY-MM-DD', 'MM/DD/YYYY' and 'DD.MM.YYYY'

Explanation: An XML template has specified an invalid iform attribute value in the `<datetime iform="date_mask">` element. The only valid masks in FM/Db2 are specified in this message.

User response: Correct the iform attribute value and rerun the job.

FMNBC451

For DB2 the only valid Timestamp format is 'YYYY-DD-MM-HH.MI.SS'

Explanation: An XML template has specified an invalid iform attribute value in the `<datetime iform="date_mask">` element. The only valid mask for a timestamp field in FM/Db2 is 'YYYY-DD-MM-HH.MI.SS'

User response: Correct the iform attribute value and rerun the job.

FMNBC452

attribute invalid for a DB2 Date or timestamp field

Explanation: The attribute value specified by *attribute* is invalid for a Db2@ datetime field.

User response: Correct or remove the attribute value in the `<datetime>` element in the XML template. Rerun the job.

FMNBC453

scrstart and scrend attributes are required for a DB2 date or timestamp field

Explanation: Both scrstart and scrend attribute values must be provided for a Db2@ timestamp field when specifying the `<datetime>` element for timestamp scrambling.

User response: Correct the XML template to specify both scrstart and scrend values and rerun the job.

FMNBC454

The member specified is not a template

Explanation: A attempt to load a template that is defined as being defined in the template repository refers to a member that is not a template.

User response: Change the repository definition to refer to a valid template member.

FMNBC455

Format SNGL or TABL required when a mandatory template is being used

Explanation: Only formatted modes of viewing the data are available when a mandatory template is used.

User response: None.

FMNBC456

This command is not supported when using a mandatory template

Explanation: An attempt was made to issue an editor command that could expose data that is protected by a mandatory template.

User response: None.

FMNBC457

Find/Change commands cannot be applied to a field protected by a mandatory template

Explanation: A field that is protected by a mandatory template cannot be the subject of a find or change command.

User response: None.

FMNBC458

Mandatory repository users are not authorized to issue the MASK command

Explanation: The editor MASK command is not available when a mandatory template is being used.

User response: None.

FMNBC459

Not authorized to access the resource or data set specified

Explanation: The current repository definition restricts the user ID to accessing resources specified in the repository. The resource being accessed is not in the template repository that is assigned to the current user ID.

User response: Contact your system administrator.

FMNBC515

FMNOPTS allocated to name.

Explanation: File Manager has detected that the FMNOPTS DD statement is allocated to name, where name is either the name of the data set allocated to FMNOPTS, or "SYSIN" indicating that the FMNOPTS statements have been provided instream. A listing of the options read from FMNOPTS follows.

User response: None.

FMNBC516

Error processing FMNOPTS options file.

Explanation: File Manager has encountered one or more errors while processing the options file allocated to the FMNOPTS DD statement. This message is preceded on one more error messages describing the error(s) encountered.

User response: Refer to the previous error messages related to the FMNOPTS options file. Correct the errors, and then rerun File Manager.

FMNBC530

IOQ1196 Failed to lock global mutex. Is POSIX on ?

Explanation: File Manager has been unable initialize the ODPP framework. The ODPP API returned the message above.

User response: The File Manager Language Environment® always runs with POSIX on for ODPP, so refer to the ODPP documentation for further explanation.

Programmer response: None.

FMNBC531

IOQ1094 Data Privacy Component License has expired.

Explanation: File Manager has been unable to initialize the ODPP framework. The ODPP API returned the message above.

User response: Renew you ODPP license.

Programmer response: None.

FMNBC532

IOQ1086 Failed to open ODPP license key file for reading

Explanation: There was a problem opening or reading data from the ODPP license key file.

User response: Ensure you have read access for the license file.

Programmer response: None.

FMNBC533

IOQ1043 Failed to create trace file. Check path settings and write authority, etc.

Explanation: File Manager has been unable to initialize the ODPP framework. The ODPP API returned the message above.

User response: Check for write access to the trace file path, disk space/quota available etc.

Programmer response: None.

FMNBC534

Data Privacy component failed. Unable to format error message, rc = &RC

Explanation: File Manager has been unable to initialize the ODPP framework. The ODPP API return code is not known to File Manager.

User response: Check your ODPP documentation for the return code and follow the explanation and response given.

Programmer response: None.

FMNBC857

Member *&member_name* Deleted.

Explanation: This is an informational message produced after the delete line command has been processed on an enhanced search index member.

User response: None.

Programmer response: None.

FMNBC858

Member *&member_name* Renamed.

Explanation: This is an informational message produced after the rename line command has been processed on an enhanced search index member.

User response: None.

Programmer response: None.

FMNBC859

Hit **Enter** on a member name to select the member for the enhanced search command.

Explanation: This is an informational message produced after a find command has been issued from the enhanced search index list. If you place your cursor on a member name, it will be selected to become the target index member for the enhanced search operation. Press **Enter** on a hit line to navigate to the member in a view session positioned at that line.

User response: None.

Programmer response: None.

FMNBC860

History command deleted.

Explanation: This is an informational message produced after the delete line command has been processed on a history command list.

User response: None.

Programmer response: None.

FMNBC861

Delete failed – ReadOnly

Explanation: The deletion failed because the command history table is used by another session.

User response: Check for other ISPF sessions that might be using your user profile data set for an enhanced search session. The enhanced search session might open the table and exit the conflicting session before attempting to retry the deletion process.

Programmer response: None.

FMNBC862

Member name exists.

Explanation: The member name that you try to insert already exists as an index member.

User response: Choose another unique name.

Programmer response: None.

FMNBC863

Replace string required.

Explanation: You have specified a search string but not a replace string with the enhanced change panel.

User response: Specify a replace string.

Programmer response: None.

FMNBC864

History command deleted.

Explanation: This is an informational message produced after the delete line command has been processed on an history command list.

User response: None.

Programmer response: None.

FMNBC865

Strings required.

Explanation: The enhanced change requires both search and replace strings.

User response: Provide both search and replace strings.

Programmer response: None.

FMNBC866

&line_count line(s) in *&member_count* of *&member_total* Member(s) and *&file_count* of *&file_total* File(s)

Explanation: This is an informational statistical message for the enhanced search to summarize the results.

User response: None.

Programmer response: None.

FMNBC867

&change_count changes made in *&member_count* Members *&file_count* Files.

Explanation: This is an informational statistical message produced after enhanced change command is successfully issued.

User response: None.

Programmer response: None.

FMNBC868

Changes failed RC=*&rc*.

Explanation: The enhanced change command failed with the return code *&rc*.

User response: Refer to the associated messages that detail why the change couldn't be performed is displayed.

Programmer response: None.

FMNBD520

Invalid value for data set, prefix or suffix name: *&dsn*

Explanation: The current cursor positioned field has an invalid data set name, qualifier, or name.

User response: Correct the name so it represents a valid z/OS® data set name. Each qualifier must be a maximum of 8 characters, and the overall length must not exceed 44.

Programmer response: None.

FMNBD521

Invalid value for member name: *&member_name*

Explanation: An invalid partitioned member name has been specified.

User response: Correct the member name and retry the operation.

Programmer response: None.

FMNBD522

Invalid generic output data set name with non generic input: *&dsn*

Explanation: The name of the output data set can only have generic characters where there is a corresponding input qualifier to derive the generic value from.

User response: Remove the generic characters in the name of the output data set that cannot be derived from the input data set name.

Programmer response: None.

FMNBD523

Input and output data set names are the same: *&dsn*

Explanation: The input data set prefix or name and output data set name or prefix result in the same input and output data set – which is invalid for the copy process.

User response: Correct the output prefix or name so a different name is generated to the input data set.

Programmer response: None.

FMNBD524

Duplicate input or output data set name specified or generated: *&dsn*

Explanation: The clone process has generated a duplicate output data set name for different input data set names.

User response: Check your input and output prefixes or data set specifications and remove the specifications that would result in the same output data set.

Programmer response: None.

FMNBD525

Output mask invalid. Input data set:*&dsn* Output Prefix:*&prefix*. Invalid mask:*&mask*

Explanation: The output prefix value *&mask* is invalid because it does not have a corresponding input qualifier.

User response: Remove the generic characters from the *&mask* value.

Programmer response: None.

FMNBD526

Resultant output data set name *&odsn* invalid. Input data set: *&idsn*

Explanation: The output data set name exceeded 44 characters. This occurs if the output prefix or a suffix to the input data set is too long.

User response: Review the input and output prefix and suffix values based on the output data set name that is shown in the message, and correct them so a valid output data set name is generated.

Programmer response: None.

FMNBD527

No data sets matched the qualifier: *&prefix*.

Explanation: The prefix that is provided does not match any cataloged data sets on the system.

User response: Add a *.******* to the end of the *&prefix* value that is provided. Or correct the qualifier to match existing data sets.

Programmer response: None.

FMNBD528

FMNSREF - Required parameter not specified FUNC=*&function*, FCODE=*&code* RNAME=*&reference_name*

Explanation: The FMNSREF exec was called with an invalid parameter value.

User response: One of the references has not been specified by the calling EXEC. Check the parameters. If the values are missing, provide the values. If the calling EXEC is an IBM® exec, report this to IBM® Support.

Programmer response: None.

FMNBD529

FMNSREF - Function value invalid FUNC=*&function* must be GREF or SREF

Explanation: The FMNSREF exec was called with an invalid function value *&function*.

User response: The valid values are *GETREF*, *GREF*, *GR*, *SAVEREF*, *SREF*, *SR*. Correct the calling exec and rerun. If the calling EXEC is an IBM® exec, report this to IBM® Support.

Programmer response: None.

FMNBD530

The GETREF command was entered and no matching reference value can be found for the value or no references have been saved for the current function.

Explanation: The FMNSREF exec was called with an invalid function value *&function*.

User response: Issue the command with a valid reference. Or ensure you have used the SAVEREF command to save references for this function before a GETREF is attempted.

Programmer response: None.

FMNBD531

This is not a valid enhanced search report.

Explanation: You tried to convert a report to an enhanced search report format, but the report being edited is not a valid enhanced search report. This happens when you edit or view a data set or spool file and the REPORT command is entered with the enhanced search function key.

User response: None. The command only works in search reports that are produced by the File Manager enhanced search process.

Programmer response: None.

FMNBD532

Invalid enhanced search parameter value *&parm_value*

Explanation: The enhanced search command detected an invalid parameter in the command string *&parm_value*.

User response: Examine the command by comparing with the syntax that is described in the user's guide for the enhanced search command. Correct the invalid parameter value.

Programmer response: None.

FMNBD533

Report Converted

Explanation: This is an informational message. This message is issued when a report produced with the File Manager enhanced search batch option was successfully converted to the format required for enhanced search navigation.

User response: None.

Programmer response: None.

FMNBD534

String required after the operator

Explanation: An **AND** (&) or an **OR** (|) operator is put at the end of a search command string. This is an invalid command syntax. The operator must be followed by a search string.

User response: Correct the syntax and retry.

Programmer response: None.

FMNBD535

To Column value cannot be less than the **From Column** value.

Explanation: When you enter a column range, the **TO** value must be greater than or equal to the **FROM** value.

User response: Correct the range values and retry.

Programmer response: None.

FMNBD536

DD name *&DD* invalid

Explanation: The DD name that you entered is invalid. The ddname is 1 - 8 alphanumeric or national (\$, #, @) characters or generic characters (*, %). The first character must be alphabetic or national (\$, #, @) or generic characters (*, %).

User response: Correct the syntax and retry.

Programmer response: None.

FMNBD545

Member & MEMBER Locked. Save to another location.

Explanation: This message is produced with a template save panel where an alternate data set and member name can be provided to save the changes made during template edit.

User response: This is an informational message

Programmer response: None.

FMNBD546

Member & MEMBER Locked. Cannot be saved.

Explanation: The template member &MEMBER is a locked template and therefore cannot be changed unless it is unlocked.

User response: To change this template, it must be unlocked. Use the L prefix command with the Template Member List panel to unlock the template.

Programmer response: None.

FMNBD600

The SAVEREF command is not available for this function.

Explanation: The SAVEREF command was issued for a function or panel where it is not supported. For a list of the supported functions, see the *File Manager User's Guide*.

User response: If the function that you are working on is a common function and it needs to be supported, contact IBM® Support to raise a new requirement to support the function.

Programmer response: None.

FMNBD601

The GETREF command is not available for this function.

Explanation: The GETREF command was issued for a function or panel where it is not supported. For a list of the supported functions, see the *File Manager User's Guide*.

User response: If the function that you are working on is a common function and it needs to be supported, contact IBM® Support to raise a new requirement to support the function.

Programmer response: None.

FMNBD602

No function input field values have been previously saved.

Explanation: A GETREF command is being issued an the SAVEREF command was not issued for the current function or panel with the current profile or FMNREFTB allocation.

User response: You must issue the SAVEREF command before you issue a GETREF command for any function or panel where it is supported.

Programmer response: None.

FMNBD603

No saved input field values for this reference name

Explanation: The GETREF command was issued with a reference name that does not exist.

User response: Issue a GETREF command without a name that lists the current references. Select a name from a list of saved references.

Programmer response: None.

FMNBD604

&name saved.

Explanation: The SAVEREF command was issued successfully for the *&name* value.

User response: None.

Programmer response: None.

FMNBD605

Save cancelled.

Explanation: The SAVEREF command was cancelled after the replace warning was issued.

User response: None.

Programmer response: None.

FMNBD607

&name Retrieved.

Explanation: The GETREF command was successfully issued to retrieve all the field values that are saved with the reference *&name*.

User response: None.

Programmer response: None.

FMNBD608

&name Replaced.

Explanation: The SAVEREF command replaced the reference *&name* with the current values.

User response: None.

Programmer response: None.

FMNBD612

New name same as the old name.

Explanation: The rename panel for a function or panel reference has the same name for the old and new name values.

User response: Correct the new name so it is different from the old name.

Programmer response: None.

FMNBD613

New name exists.

Explanation: The new name field on the rename reference name panel has the name of an existing reference.

User response: Enter a new name that does not exist.

Programmer response: None.

FMNBD614

Invalid attributes for FMNREFTB file must be fixed 80.

Explanation: The data set that is allocated to the FMNREFTB for saving the function and panel reference table has invalid attributes. It must be partitioned and fixed blocked with a logical record length of 80.

User response: Enter a new name that does not exist.

Programmer response: None.

FMNBD810

Command &CMD is not valid for generation &GEN

Explanation: The line command you have entered is not valid against the selected member generation. Some commands are not valid for the current member (generation 0).

User response: Enter the line command for a different member generation.

FMNBD811

Command &CMD is only supported for generation &GEN

Explanation: The line command you have entered is not valid against the selected member generation. Some commands are only valid for current member (generation 0).

User response: Enter the line command for the member generation as indicated.

FMNBD812

No previous generation found for compare

Explanation: The CP (Compare Previous) line command specifies a generation for which no previous member generation can be found. This can occur when CP is entered for the current member.

User response: Enter the CP line command for a different generation, or use another compare command: CN (Compare Next), CC (Compare Current), or CS (Compare Selected).

FMNBD813

No next generation found for compare

Explanation: The CN (Compare Next) line command specifies a generation for which no next member generation can be found. This can occur when CN is entered for the last member generation.

User response: Enter the CN line command for a different generation, or use another compare command: CP (Compare Previous), CC (Compare Current), or CS (Compare Selected).

FMNBD814

Member &MEM generation &GEN recovered to current member. Display refreshed

Explanation: The specified generation has been recovered and is now the current member. The previous current member is retained as the newest member generation, being generation (-1). The display has been refreshed to reflect the updates to the relative generation numbers.

User response: None.

Programmer response: None.

FMNBD815

No matching member name. No match found for member &MEM generation &GEN

Explanation: No matching member was found for the specified member name and generation.

User response: Specify another member name or generation.

FMNBD816

Member &MEM generation &GEN deleted. Display refreshed

Explanation: The specified member generation has been deleted. The display has been refreshed to reflect the updates to the relative generation numbers.

User response: None.

Programmer response: None.

FMNBD817

Invalid option. The selected compare option is not one of the listed values

Explanation: An invalid comparison option has been specified.

User response: Enter a valid comparison option:

1. ISPF Edit compare, using the ISPF VIEW service. This is the default option.
 2. SuperC compare.
 3. File Manager Compare function (DSM).
-

FMNBD818

Primary member: &MEM. The primary member &MEM displayed for the selected alias &ALIAS

Explanation: The user selected an alias to display member history (generation) information. The generations are maintained against the primary member name.

User response: None.

Programmer response: None.

FMNBD819

Member &MEM deleted. Generation &GEN promoted to current member. Display refreshed

Explanation: The specified current member has been deleted and replaced by the most recent generation. The previous current member is permanently deleted. The display has been refreshed to reflect the updates to the relative generation numbers.

User response: None.

Programmer response: None.

FMNBD820

Files are different. The file &NEWSRC was compared to &OLDSRC

Explanation: Comparison of member generations found that the files are different.

User response: None.

Programmer response: None.

FMNBD821

Files are the same. The file &NEWSRC was compared to &OLDSRC

Explanation: Comparison of member generations found that the files are the same.

User response: None.

Programmer response: None.

FMNBD830

No generation found to promote for member &MEM. Member deleted

Explanation: The current member of a version 2 PDSE that supports member generations was deleted, but no other generations were found to promote to the current member.

User response: None.

Programmer response: None.

FMNBD831

Promote for member &MEM generation &GEN failed. &FUNC error code . &RC-&RSN. Member deleted.

Explanation: The current member of a version 2 PDSE that supports member generations was deleted. When promoting the most recent generation (-1) to be the current member an error occurred. As indicated by &FUNC, the error occurred in either the FIND macro or the STOW macro.

Programmer response: Refer to the completion codes in *DFSMS Macro Instructions for Data Sets* for either the FIND macro or the RECOVERG action on the STOW macro.

FMNBD832

No members deleted. No members selected for delete from data set &DSN.

Explanation: No members were selected to be deleted from the data set.

User response: None.

Programmer response: None.

FMNBD833

No members deleted. No member generations selected to be trimmed from data set &DSN.

Explanation: For a version 2 PDSE that supports member generations, no member generations were found to be trimmed from the data set.

User response: None.

Programmer response: None.

FMNBD834

No members deleted. No orphaned member generations selected for delete from data set &DSN.

Explanation: For a version 2 PDSE that supports member generations, no orphan members were found that matched the member name or member name pattern. No members were deleted.

User response: None.

Programmer response: None.

FMNBD835

No members to delete. Delete processing terminated. The displayed member list is empty.

Explanation: The current member list for the selected member name or member name pattern is empty. Processing of the DELETE primary command is terminated without further checking of the data set.

User response: If applicable, refresh the display to confirm no members exist for the member name or member name pattern before re-entering the DELETE command.

Programmer response: None.

FMNBD850

Data set not partitioned. Data set &DSN not defined as a PDS or PDSE.

Explanation: PDSE Workbench only supports partitioned data sets.

User response: Specify a valid PDS or PDSE for PDSE Workbench.

Programmer response: None.

FMNBD851

History unavailable. Data set &DSN does not support member generations.

Explanation: A HISTORY command was issued for a data set that is not defined to support member generations. Processing continues to invoke the PDSE Workbench.

User response: None.

Programmer response: None.

FMNBD852

Delete cancelled. Delete command was cancelled, no members deleted.

Explanation: Processing for the DELETE primary command was canceled. No members were deleted.

User response: None.

Programmer response: None.

FMNBD853

Delete error. Workbench &FUNC error for data set &DSN. Return code &RC.

Explanation: An error occurred while processing the DELETE primary command.

User response: None.

Programmer response: None.

FMNBD854

&DELCNT members deleted. &DELCNT members deleted from data set &DSN. Display refreshed.

Explanation: The DELETE ALL primary command completed successfully. The display has been refreshed to reflect the changes to the member list.

User response: None.

Programmer response: None.

FMNBD855

&DELCNT members deleted. &DELCNT member generations trimmed from data set &DSN. Display refreshed.

Explanation: The DELETE TRIM primary command completed successfully. The display has been refreshed to reflect the changes to the member list.

User response: None.

Programmer response: None.

FMNBD856

&DELCNT members deleted.&DELCNT orphaned member generations deleted from data set &DSN. Display refreshed.

Explanation: The DELETE ORPHAN primary command completed successfully. The display has been refreshed to reflect the changes to the member list.

User response: None.

Programmer response: None.

FMNBD857

&DELCNT members deleted, &ERRCNT members not deleted from data set &DSN. Display refreshed.

Explanation: The DELETE primary command has completed. Some members were deleted, but some members were not deleted. The display has been refreshed to reflect the changes to the member list.

User response: Review the member list to see whether any action needs to be taken for the members that were not deleted.

Programmer response: None.

FMNBD858

No members deleted, &ERRCNT members not deleted from data set &DSN.

Explanation: The DELETE request failed. No members have been deleted from the data set.

User response: The contents of the data set may have changed. Refresh the member list display and try the request again.

Programmer response: None.

FMNBD860

Delete option &DELOPT not supported for data set &DSN.

Explanation: The selected DELETE option is not supported for the data set.

User response: Select a valid option for the DELETE command.

Programmer response: None.

FMNBD861

&DELOPT keyword for Delete command not supported for data set &DSN.

Explanation: The specified DELETE option is not supported for the data set.

User response: Specify a valid keyword for the DELETE command.

Programmer response: None.

FMNBD862

Member &OLDMEM and &GENCNT member generations renamed to &NEWMEM. Display refreshed.

Explanation: The member and any of its generations were successfully renamed. The display has been refreshed to reflect the changes to the member list.

User response: None.

Programmer response: None.

FMNBD863

Member &OLDMEM renamed to &NEWMEM. Display refreshed.

Explanation: The member has been successfully renamed. The display has been refreshed to reflect the changes to the member list.

User response: None.

Programmer response: None.

FMNBD868

DESERV request set return code=&RC, reason code=&RSN.

Explanation: The DESERV request returned an unexpected error when processing the partitioned data set directory.

User response: None.

Programmer response: Refer to the DESERV completion codes in *DFSMS Macro Instructions for Data Set* for details of the error.

FMNBD869

Concatenated data sets not supported for PDSE Workbench DD &DDNAME.

Explanation: PDSE Workbench does not support a concatenation of data sets allocated to the ddname specified on the INPUT keyword.

User response: None.

Programmer response: None.

FMNBD880

Browse substituted. &CMD is not supported for program objects.

Explanation: Edit and View are not supported for program objects. The request has been changed to Browse.

User response: None.

Programmer response: None.

FMNBD881

View substituted &CMD is not supported for member generations.

Explanation: Editing of member generations is not supported by File Manager. The request has been changed to View.

User response: None.

Programmer response: None.

FMNBE004

Expressions requiring REXX cannot be used for redefines criteria

Explanation: Redefines criteria expressions are restricted to FASTREXX. Expressions requiring REXX (expressions that have arithmetic or REXX functions, such as SUBSTR, WORD) or FMN external functions that are not supported for FASTREXX cannot be used in the criteria.

Programmer response: Enter an expression that is supported by FASTREXX.

- See [External REXX functions on page 1624](#) for a list of the external functions that are available. Look for “*Can be used in FASTREXX*” to determine whether the function can be used.
 - REXX arithmetic is not supported in FASTREXX.
-

FMNBE005

CR,CF commands are not valid for a level 1 field.

Explanation: The prefix commands CF and CR during a template edit session are not valid for the level 1 field.

Programmer response: Issue the prefix command against fields that have a REDEFINES clause or fields that are the target of a REDEFINES clause.

FMNBE052

Template data invalid for load Rsn=*nnn*

Explanation: The File Manager template is invalid. It may have been corrupted by editing it outside of File Manager.

User response: If this is not the case, then please report the problem to your Support Representative, stating the Reason Code.

FMNBE094

COBOL compile failed with Language Environment® RC &RC and RSN &RSN

Explanation: When File Manager invokes COBOL compiler V5 or later, it may terminate with a Language Environment® abend code. If the abend code is 4093 and reason code X'1C' or 28, there is insufficient storage to run the compiler. COBOL V5 requires at least 100MB of storage.

User response: Language Environment® abend and reason codes can be found in *z/OS® Language Environment® Run-Time Messages*.

FMNBE098

Keyword verification discontinued for any subsequent command

Explanation: While processing the \$\$FILEM parameters, File Manager encountered errors that caused keyword verification to stop.

User response: Review the errors before this message to determine what caused File Manager to stop processing the \$ \$FILE parameters.

FMNBE113

Volume not available. Device is offline.

Explanation: File Manager tried to allocate a z/OS® data set. The volume was not available because the associated device was offline.

User response: Resolve the problems with the volume and try again to access the data set.

FMNBE249

PDSE data set is not supported for this function.

Explanation: PDSE data sets are not supported for the Disk Browse, Disk Edit, Disk Print, or Disk Record Scan Utilities.

User response: Use a non PDSE data set for this function.

FMNBE336

User I/O exit &NAME terminated because of a Language Environment problem, RC=&CODE.

Explanation: The z/OS® Language Environment® CEEPIPI failed to load the specified User Exit.

User response: Refer to *z/OS® Language Environment® Programming Guide Using Preinitialization Services - (add_entry)* Return codes.

Programmer response: Ensure the library containing the User Exit is made available to the File Manager function.

FMNBE351

Start position beyond end of file.

Explanation: A function specified a starting position whose value is higher than that of the last record on the file. The starting position type might be KEY, RBA, or record number.

User response: To process records, you must specify a starting position whose value is lower than that of the KEY, RBA, or record number of the last record.

Programmer response: None.

FMNBE491

No Db2® TABLE matches the value entered. It is possible a Db2® object (eg view) that matches the name entered exists - however the selected Db2® utility supports Db2® tables ONLY.

Explanation: This message is issued when a Db2® object name - other than a table - is entered when preparing a Db2® LOAD or UNLOAD utility job. The Db2® LOAD and UNLOAD utilities support only table objects - not views, aliases, synonyms etc.

User response: Ensure that the Db2® object name specified is a Db2® table.

FMNBE719

Change failed

Explanation: The Find/Change utility has terminated with a nonzero return code.

User response: The explanation of the associated return code can be found in [FCH \(Find/Change\) on page 1503](#).

FMNBE805

SMF logging error. Value returned by BPX1SMF: RC=&rc Reason Code=&RSN(Dec)

Explanation: File Manager is set up to write audit records to SMF for the current function. A failure occurred while attempting to write an audit record to SMF. The BPX1SMF call resulted in return code &rc and reason code &RSN, both expressed in decimal. The current function may be terminated.

User response:

This error usually indicates a setup problem. Possible reasons for an auditing failure to SMF are:

1. The user ID does have READ access to the SAF FACILITY class profile BPX.SMF.
2. The FMN0POPT module does not have a valid number specified for the SMFNO parameter.

Consult the systems programmer for assistance in resolving the cause of the error.

FMNBE808

CCSID not valid

Explanation: The specified CCSID is not known by this z/OS® system.

User response: Change the CCSID to one that is known by this z/OS system.

FMNBE895

CCSID display off

Explanation: The CCSID column is not displayed in single formatting.

User response: None

FMNBE898

CCSID display on

Explanation: The CCSID column is displayed in single formatting.

User response: None

FMNBE991

Not selected record

Explanation: When the FMAP command has been entered the cursor is not positioned on a selected record or the record at the top of screen is not a selected record.

User response: Identify the record containing the field to be mapped by positioning the record at the top of the screen or position the cursor on the record when the FMAP command is entered.

FMNBE992

No field selected

Explanation: The field to be mapped has not been selected on the Field Selection List panel.

User response: Reissue the FMAP command and select a field from the list supplied in the Field Selection List panel.

FMNBE993

No template provided

Explanation: The template to be used to map the field has not been provided.

User response: Supply Template or Copybook details on the FMAP Copybook or Template panel

FMNBE994

Data may be truncated

Explanation: The template being used to map the field is larger than the field and data may be truncated.

User response: None

FMNBE998

No column selected

Explanation: The column to be mapped has not been selected on the Field Selection List panel.

User response: Enter the FMAP command and select the column to be mapped on the Field Selection List panel.

FMNBE999

Field reference invalid

Explanation: The field reference specified in the FMAP command cannot be found in the current template.

User response: Specify the correct field reference in the FMAP command.

FMNBF003

Not enough space.

Explanation: The data is displayed in the CCSID of the terminal, but is stored internally in Unicode. After conversion to Unicode there are not enough characters to pad the field with Unicode spaces.

User response: Remove one or more characters using HEX ON to see the characters in Unicode.

FMNBF123

Converted UNICODE data too big for receiving field. Field *name* length */////*.

Explanation: The receiving field *name* is not large enough to hold the converted Unicode field of length */////*.

User response: Increase the size of the receiving field in the template by either changing the copybook and regenerating the template or editing the dynamic template and changing the field size.

FMNBF124

Return code *rc*, reason *code* *rsn* from CUNLCNV routine. Field *name*.

Explanation: The routine CNVLCNV could not convert the field *name*.

User response: For an explanation of the return code and reason code refer to the z/OS® V1R11.0 Support for Unicode Using Unicode Services.

FMNBF126

Not valid for migrated

Explanation: The command is not able to be used for a migrated data set.

User response: RECALL the data set and reissue the command if required.

FMNBF130

Incompatible field (short). The LOCATE command with a character position can only be used on character fields with lengths > 50 bytes. (long).

Explanation: The user entered a LOCATE command with a field number and character position. The command is invalid because either the specified field is not a character field, or the length of the specified field is 50 bytes or less.

User response: Issue the LOCATE command without the character position. When the display has scrolled to show the field of interest, use the scale line to locate the character position.

FMNBF131

Invalid char posn (short). The character position is invalid for the specified field. (long).

Explanation: The user entered a LOCATE command with a field number and character position. The command is invalid because the specified character position is greater than the maximum number of characters in the field.

User response: Reduce the value for the character position.

FMNBF132

Only in SNGL (short). The CHARPOS command is only available in SNGL display format. (long).

Explanation: The user entered the CHARPOS editor primary command when the display mode was not SINGLE (SNGL). The CHARPOS command is only valid in SNGL display format. The command cannot be processed.

User response: Change the editor display mode to SINGLE and re-issue the command.

FMNBF133

CHARPOS off (short). Character position information is off. (long).

Explanation: The user entered the CHARPOS editor primary command. The character position information has been turned off.

User response: Informational message - none required.

FMNBF134

CHARPOS on (short). Character position information is on. (long).

Explanation: The user entered the CHARPOS editor primary command. The character position information has been turned on.

User response: Informational message - none required.

FMNBF135

FUN not active (short). *FUN* command is only available in TABL display format (long).

Explanation: A HIDE or FREE editor primary command was issued while in SNGL display mode. This is not supported.

User response: Switch to TABL display mode and reissue the command.

FMNBF139

Command not supported (short). Insert, repeat and copy commands are not supported when the Db2® object contains large binary object (BLOB) columns. (long)

Explanation: The user entered either an insert, copy or repeat prefix command in a File Manager/Db2 editor session of an object that contains a binary large object column. Insert, repeat and copy are not supported when the object being processed contains a binary large object column. The operation cannot be performed.

User response: None - informational message.

FMNBF427

Program Binder does not recognize member as a Load Module / Program Object. Function=&fc RC=&rc reason=&rsn.

Explanation: The File Manager View Load Module utility encountered an Binder API error when accessing the module member. The &fc is an internal code to represent the IEWBIND function being executed. The Binder API returned return code &rc and reason code &rsn.

User response: Refer to *z/OS® MVS™ Program Management: Advanced Facilities (SA23-1392)* for an explanation of Binder API return codes and reason codes.

FMNBF434

The module member does not contain any CSECT names.

Explanation: The File Manager View Load Module utility found no CSECT names in the module member and therefore cannot provide any information.

User response: None.

FMNBF912

Sort not supported. Sorting of the files is only supported when a keyed synchronization option is used

Explanation: Sorting of records is only valid when the synchronization option is either keyed or read-ahead keyed.

User response: Set synchronization to either keyed or read-ahead keyed.

FMNBF913

Sort request ignored. The files were not eligible for sort prior to the compare

Explanation: The request to sort the old and new data sets was ignored because the data sets did not fulfill the criteria needed to allow records to be sorted.

A sort request is ignored if the old or new data set has any of the following characteristics:

- RECFM=U
- VSAM linear file
- VSAM file with maximum record length greater than 32K
- QSAM spanned file with a record length greater than 32K
- The template indicates that the file has segmented records
- PDS or PDSE file

A sort request is also ignored when any of the following conditions is true:

- I/O exits are used to process the data sets
- The comparison involves MQ queues

- The comparison involves remote files
- The comparison involves HFS files

User response: Remove the sort option or, for PDS/PDSE files, specify the data sets using old or new DD names.

FMNBF914

Sort failed. The sort of the old file failed

Explanation: The call to the SORT product to request a sort of the old data set failed.

User response: Check SYSPRINT or the File Manager print data set for any error messages issued by the SORT product.

FMNBF915

Sort failed. The sort of the new file failed

Explanation: The call to the SORT product to request a sort of the new data set failed.

User response: Check SYSPRINT or the File Manager print data set for any error messages issued by the SORT product.

FMNBF916

No sort fields specified. No key segments have been specified to use to sort the file

Explanation: “*Sort before compare*” could not be done because no key fields or key locations, lengths, and type values were specified for either the old or new data set.

User response: Ensure that either key fields or key locations, lengths and type values are specified for both the old or new data sets using the keyed synchronization options.

FMNBF917

Sort requested, PACK option set to NONE

Explanation: When “*sort before compare*” is requested the ISPF PACK option is forced to a setting of NONE. This is because the SORT product will not recognize data in ISPF packed format.

User response: None.

Programmer response: None.

FMNBF918

Pack option restricted. When sort is requested, the ISPF packing option is restricted to NONE

Explanation: When “*sort before compare*” is requested the only acceptable ISPF PACK option is NONE.

User response: Change the specified ISPF PACK option setting to NONE.

Programmer response: None.

FMNBF919

SORT error RC=*rc* - please check the related SORT messages

Explanation: The SORT product failed and set the return code to *rc*.

User response: Check SYSPRINT or the File Manager print data set for any error messages issued by the SORT product.

FMNBF920

SORT abended. User abend code:*cc* Reason code:*rsn*

Explanation: The SORT product abended with the indicated user abend code and reason code.

User response: Check SYSPRINT or the File Manager print data set for any error messages issued by the SORT product.

FMNBF921

SORT abended. System abend code:*cc* Reason code:*rsn*

Explanation: The SORT product abended with the indicated system abend code and reason code.

User response: Check SYSPRINT or the File Manager print data set for any error messages issued by the SORT product.

FMNBF922

Output to same data set. Inserted and new changed records are written to the same output data set

Explanation: File Manager detected that the same output data set was used to collect the inserted and new changed records that were found during compare processing.

User response: None.

Programmer response: None.

FMNBF923

Output to same data set. Deleted and old changed records are written to the same output data set

User response: None.

Programmer response: None.

FMNBF924

Invalid file status value *status* specified

Explanation: The file status value specified by the SETCICS function STATUS parameter is not a valid value.

User response: Change the file status to one of the valid values OPE, CLO, ENA, DIS, REA, NOR, UPD, NOU, ADD, NOA, BRO, NOB, DEL, or NOD.

FMNBF925

Conflicting file status values *status_1* and *status_2* specified

Explanation: The STATUS parameter for the SETCICS function includes conflicting status values. For example, it is not valid to specify both OPE (open) and CLO (close) in the same invocation of the SETCICS function.

User response: Correct the conflicting file status values.

FMNBF926

Duplicate file status value *status* specified

Explanation: The STATUS parameter for the SETCICS function includes duplicate status values.

User response: Remove one of the duplicated file status values.

FMNBF927

No matching CICS files found

Explanation: The FILE parameter for the SETCICS function specified file name values that did not match any files for the specified CICS region.

User response: Check that the correct file name values were specified in the FILE parameter.

FMNDJ999

File Manager problem - message *nnnn* not found in table

Explanation: File Manager cannot find the message number *nnnn* in the message table. This is probably a File Manager error.

User response: Contact your system support.

Appendix B. XML definitions for a template

Table 32. XML definitions for a template

Lvl	Element	Attribute	Type	Description
1	template	lang	BASE IMS	For templates derived from copybooks. Values: <ul style="list-style-type: none"> • COBOL • PLI • ASM
		type	All	Type of template. Values: <ul style="list-style-type: none"> • BASE • IMS™ • IMSVIEW • IMSCRIT • Db2® • DYNAMIC
		segmented	BASE	Applies to File Manager Base component templates only and is a Boolean value to indicate the template is segmented or not. Values: <ul style="list-style-type: none"> • 0 • 1 • true • false
2	describe		all	This is a template description. You can provide up to five occurrences of this element and it equates to five description lines. Maximum length is 54 characters per description line.
2	db2object		Db2®	This is the Db2® object in the form owner name.objectname.
2	ssid		Db2®	This is the four character Db2® subsystem. This value has no effect for import which uses the SSID of the Db2® session for which it is run.

Table 32. XML definitions for a template (continued)

Lvl	Element	Attribute	Type	Description
2	db2rel		Db2®	The Db2® release for the template object. This is for information purposes only.
2	dbd		IMS IMSVIEW IMSCRIT	This is the DBD name. It is used as the originating template name for view and extract criteria, when an import is being performed.
2	imstp		IMS IMSVIEW IMSCRIT	This is the IMS™ template data set name. This overrides the default template data set names provided in the options when importing a view or extract criteria.
2	dbdlib		IMS IMSVIEW IMSCRIT	This is the IMS™ DBDLIB that is used to build the IMS™ template. You can specify this element up to six times to provide more than one DBD library to be searched.
2	relcrit	max	IMSCRIT	Relation criteria definitions. max="nnn" Integer Enter a number to be used as the default maximum number of target database records to be selected per source database record for the listed logical and application relationships. If you do not specify, there is no default maximum selections per database record.
		sel		Boolean Values: 1 Selected 0 Not selected
3	reldb	name		name="DBD name" Source DBD name
		seg		seg="segment name" Source Segment
		targ		targ="DBD name" Target DBD name
		bidir		Boolean and appears on export (<code>bidir="1"</code>) if the relationship is bidirectional.

Table 32. XML definitions for a template (continued)

Lvl	Element	Attribute	Type	Description
		sel		Boolean Values: 1 Selected 0 Not selected
		max		max="nnn" Integer Enter a number to be used as the maximum number of target database records to be selected per source database record for the listed logical and application relationships. If you do not specify, the relcrit max value is used if specified. If both are unspecified then there is no limit. It is recommended that a value of 2 or 3 is used for bidirectional logical relationships.
2	cset	subset	IMSCRIT	Criteria set subset number.
		sel	IMSCRIT	Boolean. Values: 1 Selected 0 Not selected
		desc	IMSCRIT	Optional description.
2	copybooks		BASE IMS	Group element for copybook definitions.
3	library			Data set name where a copybook can be found. This element can be repeated up to 12 times.
3	syslib			Data set name where nested copybooks can be found. This element can be repeated up to ten times.
3	member	name		Copybook member name.

Table 32. XML definitions for a template (continued)

Lvl	Element	Attribute	Type	Description
		lib		This specifies the library element number from which this copybook must be taken. If not specified the first occurrence in the library data sets specified.
		name01		01 name to be inserted by File Manager.
		segname	IMS™ only	Associated IMS™ segment name.
4	segdesc		IMS™ only	Segment description.
4	redefine	offset		Boolean. Set to "1" to tell File Manager to automatically adjust the offset value for each layout so that the starting location is the redefines, union or org field start location.
		chglvl		<p>Boolean. Set to "1" if required. COBOL level change.</p> <p>This is a COBOL ONLY option which changes the way the level value (specified below) is processed. If you set this option then every occurrence of the specified level value is changed to 01 before the compile step, irrespective of whether the data item has a redefines clause. This option should be used with care as it may result in incorrect offsets to data items, or compile errors as the structure is changed from its intended programmable form.</p>
		level		<p>Source level value that is used to identify redefines or union level clauses that are to generate new record layouts.</p> <p>This value is used when you have a structure that has defined multiple layouts using COBOL redefines or PL/I unions. File Manager creates a separate record layout or each redefines clause at the given level. After the first matching redefines is found, File Manager creates new layouts for the next and subsequent redefines for the same level and start location. Header and trailing data items are included in each record layout. This field is ignored for Assembler copybooks.</p>
		name		<p>Field Name: This specifies the target field name of the redefines (COBOL), Union (PL/I) or ORG (Assembler) clause.</p> <p>File Manager uses this value to determine the redefines, union or org statements that are to be represented in a new layout. This is an alternative way of identifying redefines, union and org statements that require new layouts to be generated. You</p>

Table 32. XML definitions for a template (continued)

Lvl	Element	Attribute	Type	Description
				can specify both Level and Field name values and File Manager checks both when generating new layouts.
4	sourcerange	fromstr		From string. File Manager searches each source statement for the specified string. The first statement with a matching string starts the extract process. If the From statement is specified (not the default value), then it is used if the string is not found first.
		tostr		To string. File Manager searches each source statement for the specified string. The first statement with a matching string ends the extract process. If the To statement is specified, then the first statement that matches either the To statement value or contains the To string ends the extract.
		fromstmt		From Statement: Start source line number. This tells File Manager the starting statement for extract. If not specified the default start location is statement 1.
		tostmt		To Statement: End source line number. This tells File Manager the ending statement for extract. If not specified the default end location is the last source statement.
3	cobol	dbcs	BASE IMS	Boolean. Set <code>DBCS="1"</code> if the DBCS COBOL compiler option is required.
		maxrc		Maximum acceptable compiler RC, 0-20.
		mixedcase		Boolean. Set <code>mixedcase="1"</code> to retain the original case of the field name as coded in the COBOL copybooks. This feature is only available if you are running with the File Manager COBOL compiler or a minimum compiler level of Enterprise COBOL V4R1.
		dpc		Boolean. Set <code>dpc="1"</code> to use the Decimal-point is comma SPECIAL-NAMES paragraph when compiling COBOL copybooks.
		arith		Boolean. Set <code>arith="1"</code> to use the Arith(extend) COBOL compile option when compiling COBOL copybooks.
4	replace			Group element to provide COBOL replacing strings.
5	repfrom			COBOL replace from string. There should be a matching repto element. Up to five replace from elements supported
5	repto			COBOL replace to string. Should be one for every repfrom string specified.

Table 32. XML definitions for a template (continued)

Lvl	Element	Attribute	Type	Description
4	cbladdopp			Additional COBOL compiler options which is added via the CBL statement when a COBOL compile is run to build or update a template. These options are validated during the compile process. To avoid compile errors please ensure the syntax is correct and that any additional data sets required by these options are allocated prior to invoking FMN. Do not exceed 50 bytes. <pre><cbladdopp>compiler options</cbladdopp></pre>
3	pli	graph	BASE IMS	Boolean. Set <code>graph="1"</code> to use the GRAPHIC PL/I compiler option.
		maxrc		Maximum acceptable compiler RC: 0-20.
		bin63		Boolean. Set <code>bin63="1"</code> to use the LIMITS(FIXEDBIN(63)) PL/I compiler option.
		fixdec		Boolean. Set <code>fixdec="1"</code> to use the LIMITS(FIXEDDEC(31)) PL/I compiler option.
		unalign		Boolean. Set <code>unalign="1"</code> to add the statement DEFAULT RANGE(*) UNALIGNED;. This changes the default for structure alignments.
4	pliaddopp			Additional PL/I compiler options which are added via the *PROCESS statement when a PL/I compile is run to build or update a template. These options are validated during the compile process. To avoid compile errors please ensure the syntax is correct and that any additional data sets required by these options are allocated prior to invoking FMN. Do not exceed 50 bytes. <pre><pliaddopp>compiler options</pliaddopp></pre>
3	asm	dbcs	BASE IMS	Boolean. Set <code>dbcs="1"</code> to use the DBCS assembler compiler option.
		noalign		Boolean. Set <code>noalign="1"</code> to use the NOALIGN assembler compiler option.
4	asmaddopp			Additional HLASM compiler options which are added via the *PROCESS statement when a assembler is run to build or update a template. These options are validated during the assembly

Table 32. XML definitions for a template (continued)

Lvl	Element	Attribute	Type	Description
				process. To avoid assembly errors please ensure the syntax is correct and that any additional data sets required by these options are allocated prior to invoking FMN. Do not exceed 50 bytes. <code><asmaddop>compiler options</asmaddop></code>
2	layout	name	Not Db2®	01 layout name - not applicable to Db2® templates
		copybook	BASE IMS	The name of the copybook where this 01 layout originated.
		sel	Not Db2®	Boolean. The default value is "1". Specify <code>sel="0"</code> to deselect the layout.
		segment	IMS IMSVIEW IMSCRIT	Segment name
		segssel	IMS IMSVIEW IMSCRIT	Boolean. The default value is "1". This is segment selection - it only has value when used for Views and Criteria sets - Typically you can use this to turn off segment selection by setting <code>segssel="0"</code> .
		offset	not Db2®	<code>offset="nnnn"</code> The default value is 0. The start location of all fields in the layout is adjusted by the value provided, which must be in the range -32760 to 32760.
3	criteria	type	Not Db2®	Specify: type="ID" Identification criteria type="SEL" Selection criteria type="RID" Related identification criteria
		byfield		Boolean. The default value is "0". Specify <code>byfield="1"</code> if expressions are specified using byline elements as opposed free format. <code><exp>expressions</exp></code> values are ignored if you specify <code>byfield="1"</code> .

Table 32. XML definitions for a template (continued)

Lvl	Element	Attribute	Type	Description
		or	segmented	Boolean. The default value is "0" Specify <code>or="1"</code> to OR this criteria with related 01 criteria.
		rname	segmented	The name of related 01 layout. This is only valid if <code>type="RID"</code> is also specified.
		cset	IMSCRIT	<code>cset=nnn</code> The subset number this criteria belongs to. The subset number is defined on the cset element subset attribute described above.
4	exp		ALL	This is a free format expression or a where clause for Db2® templates. Note: As expressions generally contain special XML characters it is advisable to specify using CDATA as follows: <pre><exp><![CDATA[my expression]]></exp></pre>
4	byline		ALL	Use the byline and child elements to describe your expression by field. The elements described here map to the by field representation entered through the ISPF interface to provide an expression by field. <code>byfield="1"</code> must be specified on the layout to specify these elements.
		seq		This is the sequence number starting from 1 and incrementing by 1 for each subsequent byline.
		lparen		Specify <code>lparen=" ("</code> to insert a left parenthesis before the expression defined by this element.
		rparen		Specify <code>rparen=")"</code> to insert a right parenthesis after the expression defined by this element
		conn		How this expression is to be connect to subsequent expressions. Specify <code>conn="AND"</code> or <code>conn="OR"</code> .
		name		The name of the field this expression is to use as the left hand side operand.
5	oper		not Db2®	The arithmetic relational operation. See the operators described for the dynamic template panel in this manual for a full description. As operators generally contain special XML characters it is advisable to specify using CDATA as follows: <pre><oper><![CDATA[<]]></oper></pre>

Table 32. XML definitions for a template (continued)

Lvl	Element	Attribute	Type	Description
	oper2		Db2®	<p>This is the Db2® operator as described in the <i>File Manager User's Guide and Reference for DB2 Data</i>, see "Row Selection Criteria" and the supported operators.</p> <p>As operators generally contain special XML characters it is advisable to specify using CDATA as follows:</p> <pre><oper2><![CDATA[<]]></oper2></pre>
	byval		ALL	<p>This specified the right hand or second operand which must be a valid value for the specified operator and field or column referenced.</p> <p>It must not exceed 255 characters.</p>
3	symbol		all	<p>This element, with its attributes and child elements are used to specify the formatting, create, scrambling and for dynamic templates the field definition itself.</p>
		name		This is the field or column name.
		sel		Boolean. The default value is "1". Specify <code>sel="0"</code> to deselect the column or field.
		seq	not Db2®	This is a number representing the display order. Lowest number appears first. For example, <code>seq="1"</code> .
		hold		Boolean. The default value is "0". Specify <code>hold="1"</code> if you want this field or column to be held in a edit, view or browse session.
		lzero		Boolean. The default value is "0". Specify <code>lzero="1"</code> for numeric fields where the formatting is to include leading zeros
		width		<p>Numeric. This specified an alternate display width for "TABL" formatting of the data.</p> <p>For example, <code>width="10"</code> sets a display width of 10.</p>
		start	dynamic	Defines the start column for a field definition in a dynamic template.
		length	dynamic	Defines the length for a field definition in a dynamic template
		type	dynamic	Defines the type of field. See the types described for the dynamic template panel in this manual for a full description.
		keyseq		Integer. <code>keyseq='nnnn'</code>

Table 32. XML definitions for a template (continued)

Lvl	Element	Attribute	Type	Description
				Specify this value to provide a key sequence number used to define the composite key field for data set comparison.
		db2ord	Db2®	Integer. <code>db2ord='nnnn'</code> This is a sequence number for Db2® templates that indicates how to order the data based on the data values for the column, when the data is retrieved from Db2®.
		db2AD	Db2®	Integer. Ascending or Descending indicator. (<code>db2AD="A"</code>) This is only valid when db2ord is specified and indicates whether the data retrieved from Db2® is to be in A(ascending) or D(descending) order.
		ref		Integer. This is the field or column reference number and is used to identify the field.  Note: A field can also be identified by the <code>name="field name"</code> . If this value is provided it takes precedence in identifying the field or column.
4	heading		ALL	Alternate heading <code><heading>Myfield name</heading></code>
4	lenfld		segmented	Tells us that the associated parent symbol is a length field for determining the length of the actual segment. This element should only be provided once for any given layout.
		excl		Boolean. Default value is "0". Specify <code>excl="1"</code> to say the length of the segment is the length provided in this field plus the length of the field. If not specified or "0" then the length of the segment is the length value provided in this field.
4	createN	start	ALL	The default value is 0. <code>start="nnnn"</code> , where nnn is numeric. Specifies the initial value you want a field to contain, before being adjusted by the increment you specify. The value must be

Table 32. XML definitions for a template (continued)

Lvl	Element	Attribute	Type	Description
				<p>a number that, when converted to the appropriate numeric data type, the field can hold, and, for a field with decimal places, must not specify more decimal integers than the number of decimal places in the field definition.</p> <p>If you specify a negative number, the sign is honored, even if the field is unsigned.</p> <p>If the field is a floating-point field, the start value can be specified as a floating-point number consisting of a mantissa and an exponent (such as -1.14579E01). The mantissa consists of an optional sign (+ or -) followed by 1 to 16 digits. The mantissa can also contain a decimal point. The exponent consists of the letter E, an optional sign (+ or -), and 1 or 2 digits.</p>
		end		<p>The default value is the largest positive or negative number the field can contain. <code>end="nnnn"</code></p> <p>Specifies the maximum value (if the increment is a positive number) or minimum value (if the increment is a negative number) you want a field to contain. See rules for start attribute in specifying the number.</p>
		inc		<p>The default value is 0. <code>inc="nnnn"</code></p> <p>Specifies a positive or negative number by which you want the value in the field adjusted for each record (or cycle of records). See rules for start attribute in specifying the number.</p>
		cycle		<p>The default value is 1. <code>cycle="nnnn"</code></p> <p>Specifies the number of output records that are to be generated before the increment value is applied to the field value. For example, if you specify a field start value of 100, an increment value of 10, and a cycle value of 3, the field in the first three records contains 100, 110 in next three records, 120 in the next three records, and so on.</p> <p>If cycle is zero, the value in the field is always set to the start value.</p>
4	createdDT	value	Db2®	<code>createdt="dd/mm/yy etc"</code>

Table 32. XML definitions for a template (continued)

Lvl	Element	Attribute	Type	Description
				<p>Specify a date value to be used when creating a new row. The creation attribute is only used for those functions where FM/Db2 is to create rows, for example the create utility. You can specify a date value in the same format shown in the Format field. You can specify an = to indicate that the current date is to be used. When you specify this the current value is retrieved and replaces the = in the field. The value retrieved is a constant, so that if a create utility is run later, the same value is always used to populate the column.</p> <p>You can specify * to indicate that the current date when the row is created should be used to populate the column. Specifying * indicates a variable value for the column when a create utility is run, since the value is the date on which the create utility is executed.</p>
		inc		<p><code>inc="nnnn"</code></p> <p>Specify an increment value to be used when creating multiple rows. Valid values are integers. A value of 1 indicates that each subsequent row should have a date value one day later than the previous date value. A value of -1 indicates that each subsequent row should have a date value one day earlier than the previous date value.</p>
4	createC		ALL	Use this to populate field with various patterns.
		act		<p>Action. Specifies how the contents of the field are to be varied for each record. For more information. For example, <code>act="FX"</code>. For details of each action, see Options for "act" on page 1839.</p>
		repeat		<p>The default is NO. <code>repeat="YES"</code></p> <p>Repeat user pattern. Specify YES if you have provided a user-supplied pattern that is shorter than this field and you want the pattern to be repeated as many times as necessary to fill the field. By default, File Manager uses the fill character to pad the receiving field when the user-supplied pattern is shorter than the field. This option has no effect when the RA action is specified.</p> <p>IBM®-supplied patterns are always repeated in a field, as necessary.</p>

Table 32. XML definitions for a template (continued)

Lvl	Element	Attribute	Type	Description
5	filler		ALL	<pre><filler>cccc</filler></pre> <p>Specifies a value that is to be placed in each byte of the field before any other operation in the construction of the field. Can be one of:</p> <p>char</p> <p>A character such as 0 to be written in each byte.</p> <p>X'cc'</p> <p>A hexadecimal value, such as X'FF' to be written in each byte.</p>
5	start			<pre><start>cccc<start></pre> <p>Start character</p> <p>Sets the starting character to be used when you specify an IBM®-supplied pattern (AL, AN, or CO) or a user-supplied pattern (with the exception of RO, WV, and FX). The specified character must be one of the characters in the IBM®-supplied pattern or user-supplied pattern.</p> <p>Default: First character in IBM®-supplied pattern or user-supplied pattern.</p>
5	pattern			<pre><pattern>cccc<pattern></pre> <p>Specifies the pattern to be used when generating data for this field. You can specify either an IBM®-supplied pattern indicator or a user-supplied pattern. The user-supplied pattern can be either a character string or a hexadecimal string. A character string must be enclosed in quotation marks, while a hexadecimal string must be enclosed in quotation marks and be preceded by a X. The hexadecimal string must contain an even number of valid hexadecimal characters. The IBM®-supplied patterns you can specify are:</p> <p>AL</p> <p>Alphabetic - characters A-Z, inclusive.</p> <p>AN</p> <p>Alphanumeric - characters A-Z, 0-9 inclusive.</p>

Table 32. XML definitions for a template (continued)

Lvl	Element	Attribute	Type	Description
				<p>AX</p> <p>Alphanumeric displayed in long hexadecimal.</p> <p>CO</p> <p>Collating sequence - all printable characters in the range X'40' - X'F9'.</p> <p>If you provide a user-supplied pattern that is longer than the field, for actions other than RA and RP the pattern is first truncated on the right to fit the receiving field before the specified action is performed. For the RA action, characters are randomly selected from the entire user-supplied pattern. For the RP action, the entire pattern is rippled for each record before it is truncated to fit the receiving field. If you provide a user-supplied pattern that is shorter than the field, you can specify that you want the pattern to be repeated to fill the field.</p> <p>Default: None</p>
4	scramble		ALL	<p>Use the scramble element to specify all the scrambling type options for the associated parent symbol.</p>
		type		<p>For example, <code>type="1"</code> Scramble Type. Specify one of these values:</p> <p>Blank</p> <p>No scrambling is performed.</p> <p>Value or range specifications are saved but ignored for the associated function.</p> <p>1 (Random)</p> <p>Performs random scrambling.</p> <p>The same input value produces different output values on subsequent invocations.</p> <p>2 (Repeatable)</p> <p>Performs repeatable scrambling.</p> <p>The same input value produces the same output value on subsequent invocations.</p>

Table 32. XML definitions for a template (continued)

Lvl	Element	Attribute	Type	Description
				<p>3 (Translate)</p> <p>Performs translation.</p> <p>The value data set is searched to find a matching input value. If a match is found, then the output value is taken from the output column of the matching record.</p> <p>4 (Exit)</p> <p>Invokes a scrambling user exit.</p> <p>5 (ODPP)</p> <p>If you set this value then you must provide the ODPP command using the ODPP attribute described below.</p>
		ODPP		<p>This is the Optim™ Data Privacy Provider command input area. Refer to the ODPP Syntax Guide for the command syntax.</p>
5	translate	incol		<p>incol="nnn"</p> <p>Defines the start location of the input field value on the value data set, and is used when the translate process is run during a copy operation to match the input field with a value on the value data set. The length of the field is set to the length of the input field that is mapped to this field during the copy process.</p>
		outcol		<p>outcol="nnn"</p> <p>Defines the start location of the output field value on the value data set, and is used as follows during a copy operation:</p> <p>For scramble type Translate</p> <p>If an input field value is matched on the value data set, then the corresponding output value is used.</p> <p>For scramble types Random or Repeatable</p> <p>The input value is used to randomly or repeatably select an output value from the value data set.</p> <p>The length of the field is the current field length as displayed on this panel.</p>

Table 32. XML definitions for a template (continued)

Lvl	Element	Attribute	Type	Description
				This value is required when you select the scramble type Translate. If you select Random or Repeatable, and also select Value, then the start location defaults to 1 if a value data set name (Dsn) has been provided.
		dsn		dsn="data set name" Defines the value data set. It can be any catalogued sequential, partitioned or VSAM data set containing data that is used to determine the output field value during a copy process.
5	range			This restricts scrambling values to a range of numbers between the min and max values provided on the attributes. You must provide a min and max value
		min		Minimum value. Must be less than the maximum value and greater than or equal to -2GB.
		max		Maximum value. Must be greater than the minimum value and less than or equal to 2GB
5	value	outcol		outcol="nnn" Defines the start location of the output field value on the value data set, and is used as follows during a copy operation: For scramble type Translate If an input field value is matched on the value data set, then the corresponding output value is used. For scramble types Random or Repeatable The input value is used to randomly or repeatably select an output value from the value data set.
		dsn		dsn="data set name" Defines the value data set. It can be any cataloged sequential, partitioned or VSAM data set containing data that is used to determine the output field value during a copy process.
6	sval			<sval>field value</sval> The values you provide are randomly or repeatably selected depending on your scrambling option to populate the output field

Table 32. XML definitions for a template (continued)

Lvl	Element	Attribute	Type	Description
				during the scrambling operation. The field value must be valid data for the associated parent symbol.
5	exitprog	name	all	Enter a 1 to 8 character valid load module member name to identify the scramble exit that is invoked during a copy operation for this output field. Any exit you provide must be in the form of a load module, in any load library available to File Manager at the time of the copy process, either by a STEPLIB DD statement, or in LINKLIST, or LPALIST.
		parm		You can specify a constant value that is passed to the exit for each call type by entering a non blank value in this field.
		format		Boolean. Default value is "0". Specify <code>format="1"</code> to format the field value passed to the exit as display numeric with leading zeros suppressed.
		lzero		Boolean. Default value is "0". Specify <code>lzero="1"</code> to format the field value passed to the exit as display numeric with leading zeros.

Options for "act"

Here are the possible values for "act" (which specifies how the contents of the field are to be varied for each record):

FX

The contents of the field are to remain fixed.

RA

The contents of the field are to be generated from characters selected at random from the specified pattern. A different set of characters is selected for each record.

RO

The contents of the field are to be rolled. The pattern you specify is shifted left one byte for each record until the first non-blank character of the pattern is in the first byte of the field. Then, the pattern is shifted right one byte for each output record until it returns to its original position in the field. RO can only be used with a user-supplied pattern, not with an IBM®-supplied pattern.

The pattern must start with a blank, or the result is the same as FX. The roll only occurs within the length of the pattern.

RP

The contents of the field are to be rippled. The pattern you specify is shifted left one byte for each record and the truncated character is appended to the right hand end of the pattern.

SL

The contents of the field are to be shifted left for each record. The pattern you specify is shifted left one character and filled to the right with a space. When all characters in the pattern have been shifted out, the original pattern is restored and the process is repeated.

SR

The contents of the field are to be shifted right for each record. The pattern you specify is shifted right one character and filled to the left with a space. When all characters in the pattern have been shifted out, the original pattern is restored and the process is repeated.

TL

The contents of the field are to be truncated on the left for each record. The pattern you specify is left truncated (the leftmost character replaced with a space) one character at a time until all characters in the pattern have been truncated. Then, the original pattern is restored and the process is repeated.

TR

The contents of the field are to be truncated on the right for each record. The pattern you specify is right truncated (the rightmost character replaced with a space) one character at a time until all characters in the pattern have been truncated. Then, the original pattern is restored and the process is repeated.

WV

The contents of the field are to be waved. The pattern you specify is shifted left one byte for each record until the first non-blank character of the pattern is in the first byte of the field. Then, the original pattern is restored and the process repeated. WV can only be used with a user-supplied pattern, not with an IBM®-supplied pattern.

The pattern must start with a blank, or the result is the same as FX. The roll only occurs within the length of the pattern.

Support resources

Use these resources to find product details, fixes, and support.

Search knowledge bases

- Download a Program Directory from the [IBM Publications Center](#).
- Get up-to-date details about installing, customizing, and using these products:
 - [Application Delivery Foundation for z/OS Common Components Customization Guide and User Guide](#)
 - [Fault Analyzer User's Guide and Reference](#)
 - [File Manager Customization Guide](#)
 - [File Manager User's Guide and Reference](#)
 - [File Manager User's Guide and Reference for DB2](#)
 - [File Manager User's Guide and Reference for CICS](#)
 - [File Manager User's Guide and Reference for IMS](#)

Get the latest PTFs

- [ADFz Common Components](#)
- [Fault Analyzer for z/OS](#)
- [File Manager for z/OS](#)
- [z/OS Debugger](#)
- [IBM Developer for z/OS Enterprise Edition](#)
- [Application Performance Analyzer for z/OS](#)

Collect diagnostic data

Before you contact Support, be ready to answer these questions:

- What software versions are you running?
- Do you have logs, traces, and messages related to the problem?
- Can you re-create the problem? If so, how do you re-create the problem?
- Did you make hardware, operating system, or networking software changes?
- Do you have a workaround for the problem?

Contact Support

Open a case, chat with Support, or connect to resources and communities through <https://www.ibm.com/mysupport>.

Accessibility features for File Manager

Accessibility features assist users who have a disability, such as restricted mobility or limited vision, to use information technology content successfully.

Overview

File Manager includes the following major accessibility features:

- Keyboard-only operation
- Operations that use a screen reader

File Manager uses IBM® z/OS® SMP/E to install the product. You can read about the accessibility features of IBM® z/OS® SMP/E at https://www.ibm.com/support/knowledgecenter/en/SSLTBW_2.4.0/com.ibm.zaddinfor.doc/access.html.

File Manager uses IBM® Explorer for z/OS® to install the optional File Manager Eclipse plug-in. You can read about the accessibility features of IBM® Explorer for z/OS® at https://www.ibm.com/support/knowledgecenter/SSBDYH_3.2/com.ibm.zexpl.doc/accessibility.html.

The File Manager product documentation is available at <https://help.blueproddoc.com/filemanager/welcome/index.html> which is viewable from a standard web browser, and as PDF files.

PDF files have limited accessibility support. With PDF documentation, you can use optional font enlargement, high-contrast display settings, and can navigate by keyboard alone.

Keyboard navigation

For information about navigating ISPF panels by using TSO/E or ISPF, refer to https://www.ibm.com/support/knowledgecenter/en/SSLTBW_2.4.0/com.ibm.zaddinfor.doc/access.html. This topic describes how to navigate through the interface, including how to use keyboard shortcuts or function keys.

Interface information

The File Manager user interfaces do not have content that flashes 2 - 55 times per second.

Dotted decimal syntax diagrams

Syntax diagrams are provided in dotted decimal format for users who access the online product documentation with a screen reader. In dotted decimal format, each syntax element is written on a separate line. If two or more syntax elements are always present together (or always absent together), they can appear on the same line because they are considered a single compound syntax element.

Each line starts with a dotted decimal number; for example, 3 or 3.1 or 3.1.1. To hear these numbers correctly, make sure that the screen reader is set to read out punctuation. All the syntax elements that have the same dotted decimal number (for example, all the syntax elements that have the number 3.1) are mutually exclusive alternatives. If you hear the lines 3.1 USERID and 3.1 SYSTEMID, your syntax can include either USERID or SYSTEMID, but not both.

The dotted decimal numbering level denotes the level of nesting. For example, if a syntax element with dotted decimal number 3 is followed by a series of syntax elements with dotted decimal number 3.1, all the syntax elements numbered 3.1 are subordinate to the syntax element numbered 3.

Certain words and symbols are used next to the dotted decimal numbers to add information about the syntax elements. Occasionally, these words and symbols might occur at the beginning of the element itself. For ease of identification, if the word or symbol is a part of the syntax element, it is preceded by the backslash (\) character. The * symbol is placed next to a dotted decimal number to indicate that the syntax element repeats. For example, syntax element *FILE with dotted decimal number 3 is given the format 3 * FILE. Format 3* FILE indicates that syntax element FILE repeats. Format 3* * FILE indicates that syntax element * FILE repeats.

Characters such as commas, which are used to separate a string of syntax elements, are shown in the syntax just before the items they separate. These characters can appear on the same line as each item, or on a separate line with the same dotted decimal number as the relevant items. The line can also show another symbol to provide information about the syntax elements. For example, the lines 5.1*, 5.1 LASTRUN, and 5.1 DELETE mean that if you use more than one of the LASTRUN and DELETE syntax elements, the elements must be separated by a comma. If no separator is given, assume that you use a blank to separate each syntax element.

If a syntax element is preceded by the % symbol, it indicates a reference that is defined elsewhere. The string that follows the % symbol is the name of a syntax fragment rather than a literal. For example, the line 2.1 %OP1 means that you must refer to separate syntax fragment OP1.

The following symbols are used next to the dotted decimal numbers.

? indicates an optional syntax element

The question mark (?) symbol indicates an optional syntax element. A dotted decimal number followed by the question mark symbol (?) indicates that all the syntax elements with a corresponding dotted decimal number, and any subordinate syntax elements, are optional. If there is only one syntax element with a dotted decimal number, the ? symbol is displayed on the same line as the syntax element, (for example 5? NOTIFY). If there is more than one syntax element with a dotted decimal number, the ? symbol is displayed on a line by itself, followed by the syntax elements that are optional. For example, if you hear the lines 5 ?, 5 NOTIFY, and 5 UPDATE, you know that the syntax elements NOTIFY and UPDATE are optional. That is, you can choose one or none of them. The ? symbol is equivalent to a bypass line in a railroad diagram.

! indicates a default syntax element

The exclamation mark (!) symbol indicates a default syntax element. A dotted decimal number followed by the ! symbol and a syntax element indicate that the syntax element is the default option for all syntax elements that share the same dotted decimal number. Only one of the syntax elements that share the dotted decimal number can specify the ! symbol. For example, if you hear the lines 2? FILE, 2.1! (KEEP), and 2.1 (DELETE), you know that (KEEP) is the default option for the FILE keyword. In the example, if you include the FILE keyword, but do not specify an option, the default option KEEP is applied. A default option also applies to the next higher dotted decimal number. In this example, if the FILE keyword is omitted, the default FILE(KEEP) is used. However, if you hear the lines 2? FILE, 2.1, 2.1.1! (KEEP), and 2.1.1 (DELETE), the default option KEEP applies only to the next

higher dotted decimal number, 2.1 (which does not have an associated keyword), and does not apply to 2? FILE. Nothing is used if the keyword FILE is omitted.

*** indicates an optional syntax element that is repeatable**

The asterisk or glyph (*) symbol indicates a syntax element that can be repeated zero or more times. A dotted decimal number followed by the * symbol indicates that this syntax element can be used zero or more times; that is, it is optional and can be repeated. For example, if you hear the line 5.1* data area, you know that you can include one data area, more than one data area, or no data area. If you hear the lines 3* , 3 HOST, 3 STATE, you know that you can include HOST, STATE, both together, or nothing.

Notes:

1. If a dotted decimal number has an asterisk (*) next to it and there is only one item with that dotted decimal number, you can repeat that same item more than once.
2. If a dotted decimal number has an asterisk next to it and several items have that dotted decimal number, you can use more than one item from the list, but you cannot use the items more than once each. In the previous example, you can write HOST STATE, but you cannot write HOST HOST.
3. The * symbol is equivalent to a loopback line in a railroad syntax diagram.

+ indicates a syntax element that must be included

The plus (+) symbol indicates a syntax element that must be included at least once. A dotted decimal number followed by the + symbol indicates that the syntax element must be included one or more times. That is, it must be included at least once and can be repeated. For example, if you hear the line 6.1+ data area, you must include at least one data area. If you hear the lines 2+, 2 HOST, and 2 STATE, you know that you must include HOST, STATE, or both. Similar to the * symbol, the + symbol can repeat a particular item if it is the only item with that dotted decimal number. The + symbol, like the * symbol, is equivalent to a loopback line in a railroad syntax diagram.

Related accessibility information

In addition to standard IBM® help desk and support websites, IBM® has a TTY telephone service for use by deaf or hard of hearing customers to access sales and support services:

TTY service 800-IBM®-3383 (800-426-3383) (within North America)

For more information about the commitment that IBM® has to accessibility, see [IBM® Accessibility \(www.ibm.com/able\)](http://www.ibm.com/able).

Notices

IBM File Manager for z/OS License Materials - Property of IBM Corp. and HCL Technologies Ltd. © Copyright IBM Corporation 2000, 2016. © Copyright HCL Technologies Limited 2017, 2023

This information was developed for products and services offered in the U.S.A.

IBM® may not offer the products, services, or features discussed in this document in other countries. Consult your local IBM representative for information on the products and services currently available in your area. Any reference to an IBM product, program, or service is not intended to state or imply that only that IBM product, program, or service may be used. Any functionally equivalent product, program, or service that does not infringe any IBM intellectual property right may be used instead. However, it is the user's responsibility to evaluate and verify the operation of any non-IBM product, program, or service.

IBM may have patents or pending patent applications covering subject matter described in this document. The furnishing of this document does not give you any license to these patents. You can send license inquiries, in writing, to:

*IBM Director of Licensing
IBM Corporation
North Castle Drive, MD-NC119
Armonk, NY 10504-1785
US*

For license inquiries regarding double-byte (DBCS) information, contact the IBM Intellectual Property Department in your country or send inquiries, in writing, to:

*Intellectual Property Licensing
Legal and Intellectual Property Law
IBM Japan Ltd.
19-21, Nihonbashi-Hakozakicho, Chuo-ku
Tokyo 103-8510, Japan*

INTERNATIONAL BUSINESS MACHINES CORPORATION PROVIDES THIS PUBLICATION "AS IS" WITHOUT WARRANTY OF ANY KIND, EITHER EXPRESS OR IMPLIED, INCLUDING, BUT NOT LIMITED TO, THE IMPLIED WARRANTIES OF NON-INFRINGEMENT, MERCHANTABILITY OR FITNESS FOR A PARTICULAR PURPOSE. Some jurisdictions do not allow disclaimer of express or implied warranties in certain transactions, therefore, this statement may not apply to you.

This information could include technical inaccuracies or typographical errors. Changes are periodically made to the information herein; these changes will be incorporated in new editions of the publication. IBM may make improvements and/or changes in the product(s) and/or the program(s) described in this document at any time without notice.

Any references in this information to non-IBM websites are provided for convenience only and do not in any manner serve as an endorsement of those websites. The materials at those websites are not part of the materials for this IBM product and use of those websites is at your own risk.

IBM may use or distribute any of the information you provide in any way it believes appropriate without incurring any obligation to you.

Licensees of this program who want to have information about it for the purpose of enabling: (i) the exchange of information between independently created programs and other programs (including this one) and (ii) the mutual use of the information which has been exchanged, should contact:

*IBM Director of Licensing
IBM Corporation
North Castle Drive, MD-NC119
Armonk, NY 10504-1785
US*

Such information may be available, subject to appropriate terms and conditions, including in some cases, payment of a fee.

The licensed program described in this information and all licensed material available for it are provided by IBM under terms of the IBM Customer Agreement, IBM International Program License Agreement, or any equivalent agreement between us.

The performance data discussed herein is presented as derived under specific operating conditions. Actual results may vary.

Information concerning non-IBM products was obtained from the suppliers of those products, their published announcements or other publicly available sources. IBM has not tested those products and cannot confirm the accuracy of performance, compatibility or any other claims related to non-IBM products. Questions on the capabilities of non-IBM products should be addressed to the suppliers of those products.

Statements regarding future direction or intent of IBM File Manager for z/OS are subject to change or withdrawal without notice, and represent goals and objectives only.

This information contains examples of data and reports used in daily business operations. To illustrate them as completely as possible, the examples include the names of individuals, companies, brands, and products. All of these names are fictitious and any similarity to the names and addresses used by an actual business enterprise is entirely coincidental.

COPYRIGHT LICENSE:

This information contains sample application programs in source language, which illustrates programming techniques on various operating platforms. You may copy, modify, and distribute these sample programs in any form without payment to IBM, for the purposes of developing, using, marketing or distributing application programs conforming to the application programming interface for the operating platform for which the sample programs are written. These examples have not been thoroughly tested under all conditions. IBM, therefore, cannot guarantee or imply reliability, serviceability, or function of these programs. The sample programs are provided "AS IS", without warranty of any kind. IBM shall not be liable for any damages arising out of your use of the sample programs.

Each copy or any portion of these sample programs or any derivative work must include a copyright notice as follows:

© (your company name) (year).

Portions of this code are derived from IBM Corp. and/or

HCL Ltd. sample programs.

© Copyright IBM Corp. 2000, 2016. © Copyright HCL Ltd. 2017, 2023.

Programming interface information

This documentation describes intended Programming Interfaces that allow the customer to write programs to obtain the services of File Manager.

Trademarks

IBM®, the IBM® logo, and ibm.com® are trademarks or registered trademarks of International Business Machines Corp., registered in many jurisdictions worldwide. Other product and service names might be trademarks of IBM® or other companies. A current list of IBM® trademarks is available on the web at "Copyright and trademark information" at www.ibm.com/legal/copytrade.shtml.

Terms and conditions for product documentation

Permissions for the use of these publications are granted subject to the following terms and conditions.

Applicability

These terms and conditions are in addition to any terms of use for the IBM® website.

Personal use

You may reproduce these publications for your personal, noncommercial use provided that all proprietary notices are preserved. You may not distribute, display or make derivative work of these publications, or any portion thereof, without the express consent of IBM®.

Commercial use

You may reproduce, distribute and display these publications solely within your enterprise provided that all proprietary notices are preserved. You may not make derivative works of these publications, or reproduce, distribute or display these publications or any portion thereof outside your enterprise, without the express consent of IBM®.

Rights

Except as expressly granted in this permission, no other permissions, licenses or rights are granted, either express or implied, to the publications or any information, data, software or other intellectual property contained therein.

IBM® reserves the right to withdraw the permissions granted herein whenever, in its discretion, the use of the publications is detrimental to its interest or, as determined by IBM®, the above instructions are not being properly followed.

You may not download, export or re-export this information except in full compliance with all applicable laws and regulations, including all United States export laws and regulations.

IBM® MAKES NO GUARANTEE ABOUT THE CONTENT OF THESE PUBLICATIONS. THE PUBLICATIONS ARE PROVIDED "AS-IS" AND WITHOUT WARRANTY OF ANY KIND, EITHER EXPRESSED OR IMPLIED, INCLUDING BUT NOT LIMITED TO IMPLIED WARRANTIES OF MERCHANTABILITY, NON-INFRINGEMENT, AND FITNESS FOR A PARTICULAR PURPOSE.

IBM Online Privacy Statement

IBM Software products, including software as a service solutions, ("Software Offerings") may use cookies or other technologies to collect product usage information, to help improve the end user experience, to tailor interactions with the end user, or for other purposes. In many cases no personally identifiable information is collected by the Software Offerings. Some of our Software Offerings can help enable you to collect personally identifiable information. If this Software Offering uses cookies to collect personally identifiable information, specific information about this offering's use of cookies is set forth below.

This Software Offering does not use cookies or other technologies to collect personally identifiable information.

If the configurations deployed for this Software Offering provide you as customer the ability to collect personally identifiable information from end users via cookies and other technologies, you should seek your own legal advice about any laws applicable to such data collection, including any requirements for notice and consent.

For more information about the use of various technologies, including cookies, for these purposes, see IBM's Privacy Policy at <http://www.ibm.com/privacy> and IBM's Online Privacy Statement at <http://www.ibm.com/privacy/details> in the section entitled "Cookies, Web Beacons and Other Technologies," and the "IBM Software Products and Software-as-a-Service Privacy Statement" at <http://www.ibm.com/software/info/product-privacy>.

Programming interface information

The User's Guide and Reference documents intended Programming Interfaces that allow the customer to write programs to obtain the services of File Manager.

Glossary

This publication includes definitions developed by the American National Standards Institute (ANSI) and the International Organization for Standardization (ISO). This material is reproduced from the *American National Dictionary for Information Processing*, copyright 1977 by the Computer and Business Equipment Manufacturers Association, copies of which may be purchased from the American National Standards Institute, 1430 Broadway, New York, New York 10018.

The following terms are defined as they are used in this manual. If you do not find the term you are looking for, refer to the Index or to the *IBM® Dictionary of Computing*.

ANSI definitions are preceded by an asterisk.

A

across format

A File Manager dump format that has the same appearance as a system dump. To get this format for your listings, use the SET DUMP=ACROSS processing option.

action bar

The area at the top of a window that contains choices that give a user access to choices available in that window.

ASCII

* American National Standard Code for Information Interchange. The standard code, using a coded character set consisting of 7-bit coded characters (8-bits including parity check), that is used for information interchange among data processing systems, data communication systems, and associated equipment. The ASCII set consists of control characters and graphic characters.

B

block

* A collection of contiguous records recorded as a unit. Blocks are separated by interblock gaps and each block may contain one or more logical records.

A block is a *physical record* but it may be composed of several contiguous *logical records* or parts of *logical records*.

blocking

The process of combining two or more *logical records* in one block.

BLP

Bypass label processing.

bounds

In editor functions, the default *column range* within which commands operate. In editor functions, the bounds can be changed using the BOUNDS command.

buffer

A portion of storage used to hold input or output data temporarily.

C

cards

Lines in a batch job.

cartridge

A storage device that consists of magnetic tape, on supply and takeup reels, in a protective housing.

catalog

* A directory of files and libraries, with reference to their locations. A catalog may contain other information such as the types of devices in which the files are stored, passwords, and blocking factors. * To enter information about a file or library into a catalog.

character fill

* To insert as often as necessary into a storage medium the representation of a specified character that does not itself convey data but may delete unwanted data.

CKD

Count key data, a disk architecture.

collection

See *object collection*.

column range

In editor functions, the left and right columns that control which data is processed by edit commands. Some editor commands allow you to specify a column range to override the *bounds*.

console

See *operator console*.

control interval

A fixed-length area of direct access storage in which VSAM stores records and creates distributed free space. Also, in a key-sequenced data set or file, the set of records pointed to by an entry in the sequence-set index record. The control interval is the unit of information that VSAM transmits to or from direct access storage. A control interval always comprises an integral number of *physical records*.

copybook

In general, a copybook is a file containing a sequence of code that is included in a source program at compile time. In File Manager, the term "copybook" refers specifically to a file containing descriptions of record structures.

cylinder

The tracks of a disk storage device that can be accessed without repositioning the access mechanism.

D**data definition (DD) statement**

A job control statement describing a data set associated with a specific job step.

data definition name (ddname)

The name of a data definition (DD) statement that corresponds to a data control block that contains the same name.

data-in-virtual data set

A data set that is considered a continuous stream of uninterrupted data.

DBCS

Double-byte character set.

deblocking

The process of making each *logical record* of a block available for processing. Contrast with *blocking*.

D**EBCDIC**

* Extended Binary-Coded Decimal Interchange Code. A coded character set consisting of 8-bit coded characters.

end of file (EOF)

An internal label or special record immediately following the last record of a file, signaling the end of that file. It may include control totals for comparison with counts accumulated during processing.

end of volume (EOV)

An internal label, or 2 consecutive tape marks, that follows and indicates the end of a set of data contained in a volume.

excluded record

In edit functions, a record that has been excluded from display using the EXCLUDE *primary command* or the X *prefix command*.

extended help

Help text that applies to an entire function or panel. Contrast with *field help*.

extent

Continuous space on a disk that is occupied by or reserved for a particular data set, data space, or file.

F**field help**

Help text that applies to a specific entry field, parameter, or term. Contrast with *extended help*.

field mapping

The relationship between fields in the “from” data set and fields in the “to” data set. Field mapping defines which fields in the “from” data set are copied to which fields in the “to” data set. The field mapping is defined using the Template Workbench.

field list

When data is displayed in TABL or SNGL display format, specifies which fields an editor command is to operate on.

file, tape

See *tape file*.

fill

See *character fill*.

full-screen mode

A type of File Manager session, in which you can use full-screen panels to select functions, specify parameters, view data, and update data.

H

header label

An internal label, immediately preceding the first record of a file, that identifies the file and contains data used in file control.

I

interactive (processing)

Pertaining to an application in which each entry calls for a response from a system or program, as in an inquiry system or an airline reservation system. An interactive system may also be conversational, implying a continuous dialog between the user and the system.

K

KSDS

Key-sequenced data set.

L

label

A record that identifies a volume on tape or disk or that identifies a file on the volume.

label, header

See *header label*.

label, record

See *record label*.

line command

In full-screen mode, a command that you can enter on any *list panel* by typing the command over the beginning of a list entry.

linear data set

A named linear string of data, stored in such a way that it can be retrieved or updated in 4096-byte units.

list panel

In full-screen mode, a panel that displays a list of entries such as data sets, members, or objects, and that enables you to perform functions on one or more of the entries.

logical record

A record from the standpoint of its content, function, and use rather than its physical attributes, that is, a record defined in terms of the information it contains. In VSAM, a unit of information normally pertaining to a single subject; a logical record is the user record requested of or given to the data management function.

M**multiple record types**

Records in a single file that are of different lengths or contain different types of data.

N**not-selected record**

A record that has not been selected for processing by the function because it does not meet the record identification criteria or the record selection criteria.

object

In OAM, data consisting of a contiguous stream of bytes of arbitrary length, up to a maximum of 15 megabytes. The contents and internal structure of an object are defined by the application using it. Objects are increasingly used in image processing and other advanced application areas.

object collection

A collection of user-defined objects.

operator console

A functional unit containing devices that are used for communications between a computer operator and a computer.

O**OAM**

Object Access Method.

P

parameter string

Two or more parameters separated by commas or blanks.

PDS

Partitioned data set.

physical record

A record whose characteristics depend on the manner or form in which it is stored, retrieved, or moved. A physical record may contain all or part of one or more *logical records*.

prefix commands

In full-screen mode, commands you enter in the prefix area of the panel. Prefix commands are used by File Manager edit functions.

primary command

In full-screen mode, commands you enter on the Command line. File Manager provides common primary commands that are available across a range of functions, and function-specific primary commands, such as editor commands.

Q

QSAM

Queued Sequential Access Method, an access method for sequential data sets.

R

record identification criteria

Criteria that are used to identify different record types in a file. The two types of record identification criteria are implicit and explicit. The default (implicit) record identification criteria are the minimum and maximum lengths of records of a given record type. Explicit record identification criteria are criteria you specify using the Template Workbench.

record label

In edit functions, an alphabetic character string used to name a particular record for easy reference.

record label range

In edit functions, a pair of *record labels* specified in an edit command to define the records on which the command is to operate.

record selection criteria

Criteria that are used for selecting records for processing by a function, and specified using the Template Workbench.

record size

The number of characters or bytes in a record.

record type

The set of records in a single file that are the same length or contain the same type of data.

RRDS

Relative record data set.

S**SAF**

System Authorization Facility, a system facility for security.

service provider

File Manager Service Provider for IBM® z/OS® Connect Enterprise Edition, which enables client applications to access IBM® Z data sources using z/OS® Connect.

shadow line

In editor functions, a line that indicates the position of records that have been excluded from display. A shadow line can represent *excluded records*, *not-selected records*, or *suppressed records*.

shift-out/shift-in

Characters that mark the beginning and end of double-byte character set data. The shift-out character is X'0E', and the shift-in character is X'0F'.

SMS

Storage Management Subsystem.

standard label

A fixed-format record that identifies a tape that is part of a multivolume tape file.

suppressed record

In editor functions, a record that has been selected for processing by the function, but is of a different record type to the currently displayed record type.

T**tape file**

One or more data blocks between tape marks.

tape mark

An indicator record that marks the beginning or the end of a set of data such as a file.

tape unit

A device containing a magnetic tape drive, magnetic heads, and associated controls.

tape volume

A reel of magnetic tape.

template

A set of information, created using the *Template Workbench*, that describes the format of records in a file, how different record types are identified, what records and fields are to be selected for processing, how fields are to be presented when displayed or printed, how records are to be mapped when copied from one file to another, and how fields are to be initialized.

Template Workbench

A series of File Manager panels. With the Template Workbench you can specify the name of a copybook that describes your data, and you can create and edit a template that specifies which records and fields within your data set you want to process.

U

unit, tape

See *tape unit*.

updown format

A File Manager dump format with hexadecimal representation of data in 3 lines: character, zone, and number. To get this format for your listings, use the SET DUMP=UPDOWN processing option.

utility program

A computer program in general support of computer processes; for example, a diagnostic program, a trace program, a sort program.

V

volume

Tape volume: A reel of magnetic tape. Disk volume: A disk pack or part of a disk storage module.

volume serial number (volser)

A number in a volume label assigned when a volume is prepared for use in the system.

volume table of contents (VTOC)

A table on a direct access volume that describes each file on the volume.

VSAM

Virtual Storage Access Method.

W

WLP

WebSphere Liberty Profile.

Index

Special Characters

- .xxxx prefix command 858, 1088
- (prefix command 859, 1088
- ((prefix command 859, 1088
- ((n prefix command 859, 1088
- (n prefix command 859, 1088
-) prefix command 859, 1088
-)) prefix command 859, 1088
-))n prefix command 859, 1088
-)n prefix command 859, 1088
- @ national character 84
- * showing invalid values 110
- * symbol in names 1493, 1525, 1532, 1535, 1547, 1567, 1616
- ** symbol in names 1493, 1525, 1532, 1535, 1547, 1567, 1616
- /BATCH parameter 507
- # national character 84
- % symbol in names 1493, 1525, 1532, 1535, 1547, 1567, 1616
- + prefix
 - in Find/Change Utility 377
- = to repeat command 421, 436
- =DATA prefix value for not-selected record 313
- =LGTH prefix value for not-selected record 313
- / prefix command 859, 1088
- \$ national character 84

Numerics

- 31 digit decimal processing option 205, 1025
- 63 bit binary processing option 205, 1024

A

- A prefix command 854, 1084
- ABOUT primary command 1118
- absolute disk addresses 477, 1553
- absolute generation number 638
- Absolute start position
 - REXX external functions 1627
- accessibility features mdccccli
- across hexadecimal display format 106
- Additional options, Find/Change Utility panel 903
- ADDKEY primary command 480
- addresses
 - disk
 - see* disk addresses
- advanced member selection option 70
- AF-authorized 37, 1236
- AFP Print Browse 437
- AL tape processing 446, 448
- allocation, tape 446
- alphanumeric field
 - changing attributes 229
- AMSMMSG primary command 1118
- ANSI tape labels, creating 1560
- APPEND primary command 1119
- APPENDX primary command 1119
- Array
 - variable length 182
- array elements
 - denoting with subscript 110
- ASCII
 - converting from EBCDIC 1553
 - converting to EBCDIC 1553
- ASSIGN clause 180
- ASSOCS primary command 423
- asterisks

- showing invalid values 110
- attributes
 - changing for alphanumeric field 229
- AUD function 1245
- audit trail report 414
 - printing in batch 1245
- Auto retry for CHANGE ALL option 140
- AUTORTRY primary command 140
- AUTOSAVE frequency option 133
- Aux Edit, denotation in editor panel 141
- auxiliary edit 143
- available services, Catalog Services 415

B

- B prefix command 854, 1084
- BACK primary command
 - for Memory Browse 953
- BACKWARD primary command 41, 41
- Batch Job Card Information 82, 1015
- batch mode
 - JCL syntax 508
 - running
 - File Manager 507, 508
 - using edit models 510
- BID primary command 454
- block of lines prefix command 102
- BLP tape processing 448
- BND prefix command 854, 1084
- BOT
 - external function 1635
- BOTTOM primary command 41, 1122
- bounds
 - resetting to default 155
 - setting 154
- bounds line
 - showing 854, 1084
- BOUNDS primary command 1123
- BSF function 1248
- BSF primary command 454
- BSR function 1249
- BSR primary command 455
- BT function 1250
- BTB function 1253
- BTU function 1263
- bypass label processing 448

C

- C prefix
 - in Find/Change Utility 377
- C prefix command 855, 1084
- CA-Panvalet 31, 42
- CANCEL primary command 1124
- CAPS primary command 147, 1124
- CASE primary command 147, 1125
- case-significant search string 1129
- catalog
 - defining entries 426
 - displaying entry information 415
 - listing, overview 503
- catalog entries
 - changing 416
 - defining 416
 - deleting 416
 - printing 1547
 - recalling 431
- Catalog Services 415
 - available services 415

- processing options
 - Entry type 416
- CC prefix command 855, 1084
- CC Template Workbench command 212
- CE primary command 1126
- CEDIT primary command 1128
- CHANGE ALL autosave frequency option 133, 140
- Change Extended (CX) command 152
- CHANGE external function 1635
- CHANGE primary command 1129
 - effect on excluded records 150
 - effect on not-selected records 150
 - effect on record length 150
 - effect on suppressed records 150
 - effect when zoomed 150
 - highlighting search string 149
 - in Find/Change Utility 1129
- changes
 - not saving 1124
 - saving 1215
- CHAR display format 106
- character search string 1129, 1129
- character string
 - see* string, finding
- CHG_OUT external function 1637
- CHG_VAR external function 1640
- CHGASAVE primary command 140
- CICS resources
 - accessing 50
 - accessing, examples 50
 - changing file status in batch 1561
 - functions that can access 50
 - specifying on panel or function 48
- clearing outstanding prefix commands 103
- clipboard
 - copying data from 167, 1196
 - copying data to 167, 1140
 - manager panel 762
- CLIPBOARD primary command 953
- CLM function 1274
- Clone
 - overview 559
- CLONE command
 - define 360, 360
- clone data sets 360
 - review data sets before copy 367
- clone data sets panel 361
- clone member list panel 366
- closing
 - tapes 1546
- closing a tape 1546
- CM Template Workbench command 214
- CMP_DATE external function 1645
- CMP_TIME external function 1648
- Cn prefix command 855, 1084
- COBOL
 - compiler, displaying details 39
 - data description support
 - ASSIGN clause 180
 - OCCURS clause 180
 - OCCURS DEPENDING ON 180
 - PICTURE clause 180
 - REDEFINES clause 180
 - RENAMES clause 180
 - USAGE clause 180
 - VALUE clause 180
 - Data description support

- not supported 180
- COBOL COPY statement 203
- COBOL Processing Options 202, 1016
- COBOL REPLACE 1260, 1271, 1299, 1331, 1348, 1365, 1383, 1418, 1457, 1477, 1487, 1541
- COBOL replacing options 1017
- COBOL replacing options, strings 203
- coding end of file procedure 529
- Col field 464, 464, 479, 479, 493, 493
- COLs prefix command 855
- COLS prefix command 1084
- column
 - identification line, displaying 110
- Column descriptions
 - Template Member List panel 280
- column number
 - scrolling to 121
- column ranges 155
- columns
 - holding for scrolling 227
 - index listpanel 630
 - index search panel 633
 - limiting for search 1123
 - selection lists
 - changing order 69
 - suppressing display 69
 - sorting by 123
- command ? to list valid prefix commands 101
- commands
 - continuation 509
 - reading syntax diagrams xvii
 - using with Tape Specific Functions 453
- Compare load module options
 - compare levels 769, 769
- Compare modules
 - load module options 769
- Compare options
 - compare types 774
 - keyed synchronization
 - specifying key segments in a template 390, 777
 - specifying key segments in batch 1429
 - listing options 773, 782
 - listing types 769, 780
 - long report 770, 780
 - one-to-one synchronization
 - specifying online 389, 776
 - processing options 772, 781
 - read-ahead synchronization
 - specifying online 389, 776
 - synchronization 776
- Compare output 393
 - comparison flags 396
 - report sections 393
- Compare types
 - formatted comparison 775
 - record comparison 774
- Compare Utility
 - using templates 384
- comparing
 - data sets 1388
 - load modules 400
 - tapes 471, 1598
- Comparison options
 - keyed synchronization
 - specifying key segments in a template 392
 - specifying key segments online 778
 - one-to-one synchronization
 - specifying in batch 1421

- read-ahead synchronization
 - specifying in batch 1421
- record synchronization 389
- Compiler Language Selection 201, 788
- compiler specifications
 - setting 82
- compiler, COBOL, displaying details 39
- CONTAINS external function 1644
- continuation character 509
- control statement, continuation 509
- controlling scroll amount 64, 119
- conversion mode, tape 449
- COPY primary command 1138
 - disk records 479
 - OAM objects 493
 - tape blocks 464
 - Tape Specific Functions 455
- COPY REPLACING 1017, 1260, 1271, 1299, 1331, 1348, 1365, 1383, 1418, 1457, 1477, 1487, 1541
- Copy To panel 796
- Copy Utility
 - enhanced processing 534
 - with copybook or template 347
 - with no template 342
- copybook
 - creating a template 211
 - extracting subset 209
 - function
 - batch example 1263, 1272, 1341, 1341
 - generating multiple record layouts 210
 - printing 1536
 - replacing options, strings (COBOL only) 203
 - replacing strings (COBOL only) 1017, 1260, 1271, 1299, 1331, 1348, 1365, 1383, 1418, 1457, 1477, 1487, 1541
 - stored in CA-Panvalet library 31, 42
 - updating a template 242
- Copybook View and Print Utility 260
- copying
 - data sets 1302
 - external format 353
 - from Exported Stacked Volume to physical volume 1499
 - from REXX stem variable to tape 1621
 - from REXX stem variable to VSAM record 1623
 - from tape to REXX stem variable 1605
 - from tape to tape 1596
 - from tape to tape with reblocking 1599
 - from VSAM records to REXX stem variable 1619
 - JCL 356
 - OAM object from sequential data set 1565
 - OAM object to sequential data set 1530
 - OAM object to VSAM data set 1533
 - OAM objects 493, 1526
 - records from sequential data set to tape file 1568
 - records from tape records to sequential data set 1592
 - records from tape records to VSAM data set 1602
 - records from VSAM records to tape file 1616
 - scrambling data 350
 - segmented data 351
 - tape data across a network 463
 - tapes with label processing 1573
 - VSAM data set to OAM object 1614
 - XML format 353

- copying records 855, 1084
- Create data sets 328
- CREATE primary command 1141
- Create records 328
- Create Tape Data, description 469
- CREATEX primary command 1141
- creating
 - ANSI labels on tapes 1560
 - data for a field 258
 - mappings 244
 - test data on tape 469, 1250
- creating files, CREATE primary command 1141
- CSECT comparison 769
- current data set list, Process pull-down menu 321
- current member 638
- current record type 309
- current, making data set list 322
- Customizing and sorting columns
 - Template Member List panel 276
- CUT primary command 1140
- CX (Change Extended) command 152
- CX primary command 1129
- Cx(compare) commands
 - member generations 278, 643
- CYLHD processing option 477, 1553
- cylinder head values 477, 1553

D

- D prefix command 855, 1084
- data
 - adding to existing data 338
 - adding with APPEND primary command 1119
 - appending with APPEND primary command 1119
 - copying, overview of functions 504
 - creating from existing data 334, 339
 - editing, updating, comparing and creating (overview) 503
 - erasing, overview of functions 505
 - header, omitting 1553
 - overtyping with CAPS ON 148, 1124
 - printing, overview of functions 504
 - quitting without saving changes 1124
 - recovering deleted 163, 1205
 - replacing from existing data 336
 - security erase 1498
 - sorting 123
 - statistics, listing 1205
 - translating to uppercase 147
- Data Create Utility 328
- Data description support
 - COBOL
 - ASSIGN clause 180
 - not supported 180
 - OCCURS clause 180
 - OCCURS DEPENDING ON 180
 - PICTURE clause 180
 - REDEFINES clause 180
 - RENAMES clause 180
 - USAGE clause 180
 - VALUE clause 180
 - PL/I
 - not supported 181
 - REFER 181
 - VARYING 181
 - VARYINGZ 181
- DATA prefix value for not-selected record 313
- data set
 - displaying information, DSI function 1386

- data set compare
 - function
 - batch example 1437, 1437
- Data Set Edit in Batch function
 - enhanced processing 535
- data set extents 487
- data set information, reporting 1259, 1298, 1330, 1347, 1364, 1382, 1457, 1476, 1486, 1540, 1554
- data set lists
 - accessing 321
 - adding description for entry in 325
 - adding new entry to 323
 - changing details 325
 - creating 322
 - deleting 326
 - deleting entry from 324
 - description 320
 - editing 323
 - function keys, allocating 327
 - making current 322
 - managing 322
 - point-and-shoot retrieval 326
 - progressive retrieval 326
 - reference list (REFLIST) 320
 - retrieving details from 326
- data set name
 - specifying on panel 42
- Data Set Update function
 - enhanced processing 535
- data sets
 - allocating 1371
 - browsing 1293
 - changing 1369
 - compared using templates 384
 - comparing 1388
 - copying 1302
 - copying from one to another 1119
 - deleting 1371
 - displaying extents 1490
 - editing 1342
 - editing large files 142, 144, 144
 - generating 1372
 - initializing 1372
 - managing, overview of functions 505
 - print
 - SEE* print data set
 - printing 1438
 - renaming 1371
 - saving 1148
 - selecting to view 1092
 - supported 30
 - types you can view or edit 30
 - viewing 1480
 - SEE* strings in data sets
- Data sets
 - creating 328
- data type 109
- data-check errors, correcting 451
- DATAHDR processing option 1553
- date attributes
 - changing 231
 - defining 231
 - selecting field 231
- date fields
 - entering criteria 295
 - specifying scrambling options 250
- Date/Time Attributes panel 830
- date/time fields
 - described 131
- DBCS
 - displaying or editing 83
 - DBCS printing
 - FMT function 1517
 - output formats 410
 - DBCS processing option 204, 1020
 - DBCS search string 1129
 - DD prefix command 855, 1085
 - ddname, tape 447
 - decimal to hexadecimal converter 73, 1147
 - DEDIT primary command 1142
 - default bounds 155
 - define
 - VSAM statements 1285
 - define template list command 273, 274
 - DEFV function 1285
 - DELETE command
 - member generations 642
 - DELETE primary command 1143, 1144
 - deleted data
 - recovering 163, 1205
 - deleting
 - data sets 1371
 - OAM objects 1526
 - deleting all records within range 1145
 - deleting entry from data set list 324
 - deleting excluded records 163
 - deleting member generations 1143
 - deleting records 855, 1084, 1144
 - deleting, data set list 326
 - density, tape 449
 - description, adding to data set list entry 325
 - DFSORT, disabling 1523
 - directories, listing, overview 503
 - disabling DFSORT 1523
 - discarding editing changes 98
 - disk
 - end-of-file record, writing 487
 - extents 477, 485, 487
 - functions 477
 - getting data from a buffer 479
 - input 477, 485
 - overview of functions 477
 - printing records 485
 - scanning 486
 - specifying a range for printing 485
 - update 478
 - disk addresses
 - specifying absolute or relative 477, 1553
 - disk browse 477
 - disk data set records
 - updating 1351, 1462
 - disk track edit 478
 - Disk/VSAM Data Functions panel 837
 - disks
 - locating data 1289
 - printing physical records 1286
 - display
 - picture clause 1197
 - redefines fields and information 1203
 - start location 1224
 - template structure 1228
 - display area
 - cleaning up 1208
 - display format
 - changing 106
 - initial 105
 - setting to hexadecimal 1172, 1200
 - using Zoom function key 113
 - when viewing 105
 - display formats
 - available 106
 - CHAR 106
 - HEX 106
- display ruler 109
- displaying
 - data set extents 1490
 - data set list 1491
 - disk VTOC 1491
 - editor options 98
 - extents of a data set 1490
 - template list 271, 273, 274
- disposition 448
- Dn prefix command 855, 1084
- double-byte character set data 410, 1517
- DOWN external function 1652
- DOWN primary command 41, 1146
- DP function 1286
- DROP MEMBER, RETURN return value 1715
- DROP, RETURN return value 1714
- DRS function 1289
 - how to use 486
- DSB
 - example
 - Command line invocation 1302
 - procedure invocation 1302
- DSB function 1293
- DSC function 1302
- DSCMP function 1388
- DSE
 - example
 - Command line invocation 1351
 - procedure invocation 1351
- DSE function 1342
- DSEB function 1351
- DSFA function 1369
- DSFC function 1371
- DSFD function 1371
- DSFR function 1371
- DSG function 1372
- DSI function 1386
- DSINFO processing option 1259, 1298, 1330, 1347, 1364, 1382, 1457, 1476, 1486, 1540, 1554
- DSM function 1388
- DSP function 1438
- DSU function 1462
- DSV
 - example
 - Command line invocation 1490
 - procedure invocation 1490
- DSV function 1480
- DSX function 1490
 - how to use 487
- dump formats 1554
- DUMP processing option 1554
- DVT function 1491
- DX primary command 73, 1147
- dynamic scrambling 187
- dynamic template
 - specifying 754, 792, 1094, 1113

E

- E Template Workbench primary command 233, 233
- EBCDIC
 - converting from ASCII 1553
 - converting to ASCII 1553
- EChange command
 - define 557, 558
 - syntax 568
- Edit (option 2) 87
- Edit Entry panel 862

- edit models
 - example 511
 - inserting in JCL 510
- Edit panel 87
- EDIT primary command, description 1147
- Edit, denotation in editor panel 141
- editing
 - auxiliary 143
 - data sets 1342
 - in-memory edit 142
 - in-place 142
 - in-place-in-memory edit 142
 - KSDS edit 144
- editing changes
 - discarding 98
 - saving 98, 99
- Editing data
 - inserting records 162
- editing large files 142, 144, 144
- editing load modules 145
- editing methods 145
- editing template 1128, 1142, 1230, 1231
- editor
 - locating line number 121
 - specifying data sets 89
- editor options
 - displaying 98
 - panel 868
 - setting 82
- editor sessions
 - ending 98
- EFind command
 - define 556, 558
 - syntax 565
- EList command
 - define 556, 558
- end of file procedures
 - coding 529
- END primary command 1148
- end-of-file record, disk 487
- end-of-volume mark, tape 450
- ending editor sessions 98
- ending session 1148
- Enhanced Change
 - overview 559
- Enhanced Change command
 - define 557, 558
- Enhanced Change Facility
 - EChange command syntax 568
- enhanced ISPF commands
 - setting up 553
- enhanced processing
 - by member 536
 - by record 534
 - modes 534
- Enhanced Reference List
 - overview 559
- Enhanced Reference List and Search Facility 553
 - Data set name variable substitution 585
 - Examples 564
 - Line Commands 562
 - Specifying resource names in an index member 563
- Enhanced Reference List command
 - define 556, 558
- enhanced search
 - assign to F4 in edit or view 553
- Enhanced Search
 - overview 559
- Enhanced Search command
 - define 556, 558
- Enhanced Search Facility 553
 - EFind command syntax 565
 - Reference data set 560
- Enhanced Search member hit selection list panel 573
- EOD
 - parameter of TT function 1597
 - processing option
 - description 1554
 - used to process tapes beyond EOV 450
- EOF function
 - how to use 487
- EOFFPROC
 - how to code 529
- EOJ function 1498
- EOT, parameter of TT function 451, 1597
- EOV
 - parameter of TT function 1597
 - processing all tape files 450
- Erase Tape, description 474
- erasing
 - OAM objects 493, 1526
 - tapes 1498
- erasing a tape 474
- error handling 515
- errors
 - data check, correcting 451
 - messages 1717
- ERT function 1498
- EVC function 1499
 - how to use 452
- EVL function 1501
 - how to use 452
- example
 - index search 634
- Exclude Extended (XX) command 130
- EXCLUDE primary command 1148
 - effect on not-selected records 1151
 - effect on suppressed records 1151
- excluded records 1129
 - affect of prefix commands 103
 - deleting 163
 - limiting data to be displayed 129
 - limiting data to be edited 158
 - show 855, 856, 1085, 1085
 - sorting 123
- excluding
 - long strings 130
- excluding records from display 858, 1087, 1148
- Exit 39
- exiting
 - File Manager
 - 1498
- EXPAND primary command 1154
- expiration date
 - tape 448
- export history utility, template repository 196
- export utility, template repository 193
 - XML format 198
- Exported Stacked Volume
 - copying to physical volume 1499
 - defined 452
 - EVC function 452
 - EVL function 452
 - listing contents 1501
 - options 452
 - printing table of contents 475
 - requirements 452
 - terms 452
 - working with 452
- Exported Stacked Volume Copy
 - how to use 452
- Exported Stacked Volume List
 - how to use 452
- Exported Stacked Volume List, description 475
- extent
 - details, displaying 424
- EXTENT primary command 424, 1154
- extents
 - displaying 1490
- extents, disk 477, 485, 487
- external format
 - copying data 353
- external functions provided by File Manager
 - BOT 1635
 - CHANGE 1635
 - CHG_OUT 1637
 - CHG_VAR 1640
 - CMP_DATE 1645
 - CMP_TIME 1648
 - CONTAINS 1644
 - DOWN 1652
 - FINDNEXT 1652
 - FINDPREV 1652
 - FLD 1653
 - FLD_CO 1655
 - FLD_OUT 1657
 - FLD_TM 1659
 - FLD_TYPE 1661
 - FLDI 1663
 - FLDO 1666
 - L_LENGTH 1666
 - MOD_DATE 1667
 - NCONTAIN 1672
 - O_LENGTH 1673
 - OFLD_CO 1673
 - OVLY_OUT 1675
 - OVLY_VAR 1678
 - PRINT 1681
 - PRT_IN 1683
 - PRT_OUT 1684
 - PRT_VAR 1685
 - PRTCOUNT 1683
 - RECCUR 1686
 - RECSIN 1686
 - RECSOUT 1687
 - RSTR_OUT 1688
 - SAVE_OUT 1688
 - SEGCNT 1689
 - SEGLen 1689
 - SEGNO 1691
 - SEGOFF 1690
 - SET_FLD 1691
 - SET_OLEN 1692
 - SETC 1693
 - SETN 1694
 - SETRC 1564, 1695
 - STATS 1696
 - TALLY 1697
 - TESTC 1699
 - TESTN 1702
 - TFLD 1703
 - TID 1706
 - TM 1706
 - TOP 1707
 - UP 1707
 - UPDATE 1708
 - VAL_FLD 1708
 - VAR_OUT 1708

VAR_TM 1710
WRITE 1712

F

F prefix command 855, 1085
F4 function key
 enhanced search functions 553
fastpath commands, data set lists 321
FASTREXX
 choosing whether to use 521
 examples of tasks 540
 variables, using 1631
FC prefix command 855
FCH function 1503
FE primary command 1154
FH prefix command 855
field
 alphanumeric
 see alphanumeric field
 mapping
 contiguous fields 245, 258
 rules 259
 numeric
 changing attributes 229
 scrolling to 121
 selecting for attribute change 229
 selecting for specifying scrambling
 options 246
field data type 109
field descriptions
 Template Member List panel 277
Field Descriptions 562
field heading 109
field length 109
field list 156
field range 156
field reference 109
Field Reference column
 turning display on or off 1206
field start column 109
fields
 changing fields in error 1126
 finding next in error 1154
 finding particular numeric value 1157
 holding when scrolling 120
 index list panel 629
 overtyping with CAPS ON 148, 1124
 padding 348
 scrolling to specified field 1182
 sorting by 123
 specifying for search 1129, 1153, 1166,
 1186
 specifying for sort 1226
 truncating 348
fields in error
 changing 1126
 defined 1154
fields of data
 holding when scrolling 65
File Manager
 actions, overview 29
 exiting 39, 1498
 external functions
 BOT 1635
 CHANGE 1635
 CHG_OUT 1637
 CHG_VAR 1640
 CMP_DATE 1645
 CMP_TIME 1648
 CONTAINS 1644
 DOWN 1652

FINDNEXT 1652
FINDPREV 1652
FLD 1653
 FLD_CO 1655
 FLD_OUT 1657
 FLD_TM 1659
 FLD_TYPE 1661
 FLDI 1663
 FLDO 1666
 LLENGTH 1666
 MOD_DATE 1667
 NCONTAIN 1672
 O_LENGTH 1673
 OFLD_CO 1673
 OVLY_OUT 1675
 OVLY_VAR 1678
 PRINT 1681
 PRT_IN 1683
 PRT_OUT 1684
 PRT_VAR 1685
 PRTCOUNT 1683
 RECCUR 1686
 RECSIN 1686
 RECSOUT 1687
 RSTR_OUT 1688
 SAVE_OUT 1688
 SEGCNT 1689
 SEGLN 1689
 SEGNO 1691
 SEGOFF 1690
 SET_FLD 1691
 SET_OLEN 1692
 SETC 1693
 SETN 1694
 SETRC 1694, 1695
 STATS 1696
 TALLY 1697
 TESTC 1699
 TESTN 1702
 TFLD 1703
 TID 1706
 TM 1706
 TOP 1707
 UP 1707
 UPDATE 1708
 VAL_FLD 1708
 VAR_OUT 1708
 VAR_TM 1710
 WRITE 1712
functions, overview 503
 launching 36
 REXX procedures
 examples 531, 531
 interfacing with 530
 interfacing with, description 517
File Manager
 Service Provider
 see service provider
FILE primary command 1157
filtering, selection list 68
FIND
 for AFP Print Browse 1160
 for Catalog Services 1160
 for Find/Change Utility 1159
 for Work with VTOC 1160
Find Extended (FX) command 127
FIND primary command
 for View and Edit 1157
 Tape Specific Functions 455
 use in Find/Change Utility 1159
Find/Change Utility 368

 enhanced processing 536
 FINDNOT command 371
 panel 901
 processing options 372
 record number prefixes 376, 377
 refining the list of selected members 370
 selecting PDS members 369
 VCONTEXT command 376
finding
 data in selection lists 67
 data in tapes 1589
 long strings 127
finding a field with a particular numeric
value 1157
finding next field in error 1154
finding string 125
FINDNEXT external function 1652
FINDNOT
 use in batch processing 1168, 1516
FINDNOT primary command 371
FINDPREV external function 1652
first page
 scrolling to 41, 1232
FKEY primary command 1156
FL prefix command 855
FLD external function 1653
FLD_CO external function 1655
FLD_OUT external function 1657
FLD_TM external function 1659
FLD_TYPE external function 1661
FLDI external function 1663
FLDO external function 1666
FMAP primary command 1169
FMN
 ELIBD
 553
 FMN
 EXEC
 531
 FMNIN
 507, 508
 FMNPRINT
 ddname
 507, 508, 514
 fm
 Service.sar archive file
 667
 FMT function 1517
 Fn prefix command 855, 1085
 FORMAT primary command 1170
 Formatted comparison 775
 FORWARD primary command 41, 41
 fragments, syntax diagrams xvii
 FREE command, TSO 448
 FREE primary command 1171
 free space
 displaying information on 1491
FS prefix command 855
FSF function 1519
FSF primary command 456
FSR function 1520
FSR primary command 456
FT prefix command 855
function entry panel 320
function keys
 allocating, data set lists 327
 extent details 424
 F4 553
 Process 436
 Rfind 481, 1158
 Rgleft 436

scrolling 63, 117
 Statistics 423
 volume information 424
 Zoom 113
 ZOOM 464
 functions
 AUD 1245
 BSF 1248
 BSR 1249
 BT 1250
 BTB 1253
 BTU 1263
 CLM 1274
 DEFV 1285
 disk 477
 DP 1286
 DRS 1289
 DSB 1293
 DSC 1302
 DSCMP 1388
 DSE 1342
 DSEB 1351
 DSFA 1369
 DSFC 1371
 DSFD 1371
 DSFR 1371
 DSG 1372, 1388
 DSI 1386
 DSP 1438
 DSU 1462
 DSV 1480
 DSX 1490
 DVT 1491
 EOJ 1498
 ERT 1498
 EVC 1499
 EVL 1501
 external, provided by
 File Manager
 BOT 1635
 CHANGE 1635
 CHG_OUT 1637
 CHG_VAR 1640
 CMP_DATE 1645
 CMP_TIME 1648
 CONTAINS 1644
 DOWN 1652
 FINDNEXT 1652
 FINDPREV 1652
 FLD 1653
 FLD_CO 1655
 FLD_OUT 1657
 FLD_TM 1659
 FLD_TYPE 1661
 FLDI 1663
 FLDO 1666
 L_LENGTH 1666
 MOD_DATE 1667
 NCONTAIN 1672
 O_LENGTH 1673
 OFLD_CO 1673
 OVLY_OUT 1675
 OVLY_VAR 1678
 PRINT 1681
 PRT_IN 1683
 PRT_OUT 1684
 PRT_VAR 1685
 PRTCOUNT 1683
 RECCUR 1686
 RECSIN 1686
 RECSOUT 1687

RSTR_OUT 1688
 SAVE_OUT 1688
 SEGCNT 1689
 SEGLN 1689
 SEGNO 1691
 SEGOFF 1690
 SET_FLD 1691
 SET_OLEN 1692
 SETC 1693
 SETN 1694
 SETRC 1564, 1695
 STATS 1696
 TALLY 1697
 TESTC 1699
 TESTN 1702
 TFLD 1703
 TID 1706
 TM 1706
 TOP 1707
 UP 1707
 UPDATE 1708
 VAL_FLD 1708
 VAR_OUT 1708
 VAR_TM 1710
 WRITE 1712
 FCH 1503
 FMT 1517
 FSR 1520
 INT 1521
 NOSORT 1523
 OAM 490
 OD 1523
 OE 1526
 OO 1526
 OP 1528
 OS 1530
 OV 1533
 PBK 1536
 performance tips 1243
 PWB 1544
 PWT 271
 REW 1545
 RUN 1546
 SCS 1547
 SET 1550
 SETCICS 1561
 SO 1565
 ST 1568
 TLB 1571
 TLT 1573
 TMP 1575
 TP 1577
 TPEXP 1579
 TPIMP 1584
 TRS 1589
 TS 1592
 TT 1596
 TTC 1598
 TTR 1599
 TV 1602
 TX 1605
 using with REXX procedures,
 description 517
 VER 1607
 VLM 1607
 VO 1614
 VT 1616
 VX 1619
 WTM 1621
 XT 1621
 XV 1623

FX (Find Extended) command 127
 FX primary command 1157

G

GDG (generation data group), catalog
 entries 1105
 generating
 data sets 1372
 Generation Member List panel 911
 generations 638
 generation limit 638
 generic names 1493, 1525, 1532, 1535, 1547,
 1567, 1616
 GET primary command
 updating
 disk records 479
 OAM objects 493
 tape blocks 464
 glossary mdcccxlix
 GRAPHIC processing option 205, 1024

H

handling errors 515
 HEADERPG processing option 1555
 headers, omitting 1553, 1555
 Help
 accessing 74
 fields 74
 tutorial 75
 HEX display format
 SEE hexadecimal display formats
 HEX primary command 1172
 hexadecimal
 data in selection lists 69
 printing current record 1202
 hexadecimal display format
 setting 1172, 1200
 hexadecimal display formats
 across 106
 updown 106
 hexadecimal search string 1129
 hexadecimal to decimal converter 73, 1239
 hexadecimal values
 showing 107
 HFS
 accessing HFS services 497
 files, types supported 31
 nomenclature xvi
 on Primary Option Menu panel 36
 hidden records
 indicated 120
 HIDE command 642
 HIDE primary command 1173
 hiding not-selected records 311
 hiding shadow lines 312, 1220
 Hierarchical File System
 SEE Primary Option Menu, HFS (option 8)
 highlighting
 search string of CHANGE primary
 command 149
 turning off 149, 1208
 HISTORY primary command 1174
 History Selection panel 911
 HLASM
 copybooks, using 184
 processing options, setting 204
 HLASM Processing Options 1020
 HOLD primary command 1175
 holding fields of data when scrolling 65
 holding fields when scrolling 120
 how the data set or resource list is
 determined 567

I

- I prefix command 855, 1085
- _LENGTH external function 1666
- I/O exit, in data set copy 794
- IAM Entry Detail 425
- ICLK> indicator 136
- identification line, displaying 110
- Immediate change 373, 901, 905
- import utility, template repository 194
- In prefix command 856, 1085
- in-memory edit 142
- in-place editing 142
- in-place-in-memory edit editing 142
- index list
 - panel 628
 - primary commands 630
- index list panel
 - column descriptions 630
 - fields 629
 - line commands 631
- index search
 - column descriptions 633
 - example 634
 - navigation 633
 - panel 631
 - specifying search expression 632
- Indexed search 616
- Indexed Search
 - XFind command syntax 618
- Indexed search command
 - define 617, 618
- INFO primary command 423, 423
- initial display format 105
- Initialize Tape, description 473
- initializing
 - data sets 1372
 - tapes 1521
- INOUT used for tape open 448
- Inplace Edit, denotation in editor panel 141
- Inplace edit, option on Edit Entry panel 90, 144
- Inplace edit, option on editor entry panel 141, 143
- INPOS
 - setting 1629
 - specifying in functions 1630
- input
 - disk 477, 485
 - tape
 - data-check errors 451
 - specifying 445
- input record relative positioning
 - examples 543
- INPUT used for tape open 448
- inserting records 855, 1085
- Inserting records 162
- INT function 1521
- integrity check, definition 133
- Internal Stacked Volume
 - defined 452
- invalid data
 - shown as asterisks 314
- invalid values
 - displayed as * 110
- invoke template list 271, 273, 274
- invoking
 - template list 271, 273, 274
- ISPF commands
 - invoke template list 273

J

Japanese

Katakana characters
processing option for 1559

JCL

- copying data 356
- running
 - File Manager
 - batch mode 508
- JES class, PRINTOUT processing option 1558
- JES spool queue 1558, 1560
- JOIN primary command 1176
- joining lines 170, 1176
- JSON
 - request schema 667
- JUST primary command 1177

K

K prefix, Find/Change Utility 376

Katakana characters

- using SET PRTRTRANS 1559

KEY primary command 1177

Key sequence

- specifying key segments in a template 392

Keyed synchronization

- specifying online 390, 777

KEYFLDS 392

keywords, syntax diagrams xvii

KSDS editing 144

KX prefix, Find/Change Utility 376

L

L prefix command 856, 1085

label

- value for tapes 448

label lines 858, 1088

labels

- assigning to records to create ranges 159
- editor-assigned
 - ZCSR 161
 - ZFST 161
 - ZLST 161
- to provide record range for search and replace 1129

Language and Compiler Specifications 1021

LANGUAGE processing option 1556

language specifications

- setting 82

large files

- editing 142, 144, 144

last page

- scrolling to 41, 1122

Launching 36

layout

- generating multiple 210

LC prefix command 856, 1085

LCC prefix command 856, 1085

LCn prefix command 856, 1085

left justify numeric fields 1177

LEFT primary command 1178

Len column

- toggle display 1233

LGTH prefix value for not-selected record 313

LHEX display format 107

LHEX primary command 1180

LIBLIST primary command, description 1181

license inquiry mdcccxlv

limiting columns for search 1123

limiting data 156

- column ranges 155
- setting bounds 154
- using record ranges 159

limiting data from display

- excluded and not-excluded records 129

limiting data from editing

- excluded and not-excluded records 158

limiting effect of primary commands 154

limiting tape capacity 1522

line

- commands
 - Catalog Services 421
 - Display VTOC 436
 - Work with VTOC 436
- first, scrolling to 65
- last, scrolling to 65
- length for print output 1558
- numbers, using for creating copybook subset 209
- scrolling to first 65
- scrolling to last 65

line commands

- index list panel 631

lines

- copying from one data set to another 1119
- joining 170, 1176
- labelling 858, 1088
- splitting 170

lines per page, print output 1557

list of prefix commands 854, 1084

LIST primary command 411, 1181

listing

- contents of Exported Stacked Volume 1501
- OAM objects 1523

listing objects 490

lists, data set lists, description 320

LISTVIEW primary command 325, 327

LISTVIEW primary command, description 1181

Ln prefix command 856, 1085

Load module criteria

- selecting options 771

load modules

- comparing 400
- editing 145
- viewing 278, 438, 643

LOCATE primary command 121, 1182

- for AFP Browse 1184, 1184
- for Catalog Services 1183
- for Non-VSAM Extent Information panel 1183
- Tape Specific Functions 456
- use in Find/Change Utility 1183

locating

- data in tapes 1589
- data on a disk 1289
- label assigned to line 147

logical view

- showing data without 753, 792, 1094, 1113

Logical view

- changing 94

logical volume

- defined 452

long report, compare option 770, 780

long strings

- changing 152
- excluding 130
- finding 127

LRECL=X 90, 742, 1244

LZ primary command

- see LZERO primary command

LZERO primary command 1190

M

M prefix command 856, 1086

manager, MQ

- specifying on panel 48

- mandatory repository 186, 187
- mapping
 - contiguous fields 245, 258
- mapping, rules 259
- mappings
 - creating 244
- MAXGENS keyword 637
- MC Template Workbench primary command 244
- member generation 638
 - DELETE command 642
 - HIDE command 278, 642, 643
 - prefix commands 278, 643
- member generations
 - deleting 1143
- member name
 - specifying on panel 42
- member name, PDS
 - specifying on panel 42
- members
 - deleting 1143
- members, selecting multiple 70
- Memory Browse 437
- messages
 - list 1717
 - selecting language for 1556
- mm (tape mode) values 449
- MM prefix command 856, 1086
- Mn prefix command 856, 1086
- MOD_DATE external function 1667
- mode, tape 449
- module
 - load module comparison 1274
- moving
 - tapes backwards 1248, 1249
 - tapes forwards 1519, 1520
- moving records 856, 1086
- moving to next record 1191, 1192
- moving to previous record 1198, 1199
- MQ manager or queue
 - specifying on panel 48
- MQSeries
 - See* WebSphere MQ, working with
- MT Template Workbench primary command 244
- Multi-segment keys
 - specifying key segments in a template 392
 - specifying key segments in batch 1429
 - specifying key segments online 778
- Multiple copybook templates 208
- multiple templates
 - building 1253
- multiple templates, updating 1263

N

- national characters 84
- navigating
 - index search 633
- NCONTAIN external function 1672
- network, copying a tape across 463
- NEXT primary command 1191
 - for Memory Browse 953
- NEXTPAGE primary command
 - for AFP Print Browse 733
- NEXTREC primary command 1192
- nfiles parameter, specifying EOD 1554
- NL tape processing 448
- NOALIGN processing option 204, 1020
- non-displayable characters
 - representing 110
- NOSORT function 1523

- not-excluded records 1129
 - limiting data to be displayed 129
 - limiting data to be edited 158
 - sorting 123
- not-selected records
 - affect of prefix commands 103
 - hiding 311, 311, 1208, 1222
 - indicating reason 312
 - representing with shadow line 311
 - showing 311, 1222
- NRETRIEV primary command 322, 326, 1193
- number
 - find and replace 1129
- numeric fields
 - left justify 1177
 - overtyping 145
 - searching 126

O

- O prefix command 857, 1086
- O_LENGTH external function 1673
- OAM
 - copy an object from a sequential data set 1565
 - copying an object 1526
 - copying an object to a sequential data set 1530
 - copying an object to a VSAM data set 1533
 - copying from a VSAM data set to an object 1614
 - copying objects 493
 - erasing objects 493, 1526
 - functions 490
 - getting data from a buffer 493
 - listing objects 1523
 - object list 490
 - printing
 - list of objects 490
 - printing an object 1528
 - restoring an object from a sequential data set 1565
 - restoring objects 495
 - updating objects 493
- OAM Functions panel 959
- OAM objects
 - backing up 494
 - backing up many 495
 - backing up one 494
 - browsing 492
- objects
 - See* OAM objects
- OCCURS clause 180
- OCCURS DEPENDING ON 180
- ODL function 1523
- OE function 1526
- OFFSET
 - adjusting record views 316
 - example of negative value 317
 - example of positive value 317
 - specifying a value 318
- OFD_CO external function 1673
- On prefix command 857, 1086
- One-to-one synchronization
 - specifying online 389, 776
- OO function 1526
- OO prefix command 857, 1086
- OP function 1528
- open for write, tape 448
- ORDER primary command 1195
- orphan member 642
- OS function 1530

- OUTIN used for tape open 447
- OUTPOS
 - setting 1629
 - specifying in functions 1630
- output
 - tape, specifying 445
- Output Data Set Allocations options 83
- output record relative positioning
 - examples 543
- output width
 - changing 229
- OV function 1533
- over-large values
 - editing template to avoid truncation 110
 - showing 110
 - truncating 110
- overlying records 857, 1086
- overriding scrolling amount 65, 120
- overtyping, numeric fields 145
- overview
 - disk functions 477
 - File Manager
 - actions
 - 29
 - File Manager
 - functions
 - 503
 - functions
 - copying data 504
 - editing, updating, comparing, and creating 503
 - erasing data 505
 - listing catalogs and directories 503
 - managing data sets and tapes 505, 505
 - managing processing environment 506
 - printing data 504
 - OAM functions 490
 - primary commands
 - Tape Specific Functions 453
 - Template Workbench 233
 - OVLY_OUT external function 1675
 - OVLY_VAR external function 1678

P

- P prefix command 857, 1086
- PAD processing option 1557
- padding to maintain record length 151
- page length, print output 1557
- pages
 - scrolling to first 41, 1232
 - scrolling to last 41, 1122
- PAGESIZE processing option 1557
- PAGESKIP processing option 1557
- panel
 - Enhanced Search member hit selection list panel 573
 - Template Member List panel 276
- panels
 - Date/Time Attributes 830
 - index list 628
 - index search 631
 - invoking from outside
 - File Manager
 - 39
 - selecting language for 1556
 - summary,
 - File Manager
 - 717
 - template list 275, 1063
 - template member list panel 1064
- partitioned data sets

searching 616, 616
 types supported 30
 PASTE primary command 1196
 pattern
 set for created fields 229
 PBK function 1536
 PDS(E) members, selecting multiple 70
 PDSE Workbench
 invoking 639
 Member List panel 637
 overview 639
 PWB function 1544
 PDSE Workbench command
 define 557, 559
 performance tips
 functions 1243
 REXX procedures 537
 personal data set list, Process pull-down
 menu 321
 physical disk records
 printing 1286
 physical records
 disk, processing 477
 PIC primary command 1197
 picture clause
 display 1197
 PICTURE clause 180
 PL/I
 data description support
 REFER 181
 VARYING 181
 VARYINGZ 181
 Data description support
 not supported 181
 editing rules for VARYING 183
 editing rules for VARYINGZ strings 184
 PL/I Processing Options 205, 1024
 positioning prefix area 1197
 positioning RECLen area 1204
 prefix area
 indicating reason for record non-
 selection 312
 listing valid commands 101
 positioning 1197
 setting position 101
 showing 1197
 showing reason for non-selection 312
 prefix commands
 .xxxx 858, 1088
 (859, 1088
 ((859, 1088
 ((n 859, 1088
 (n 859, 1088
) 859, 1088
)) 859, 1088
))n 859, 1088
)n 859, 1088
 /859, 1088
 A 854, 1084
 affect on excluded records 103
 affect on not-selected records 103
 affect on suppressed records 103
 B 854, 1084
 block of lines operations 102
 block operations 102
 BND 854, 1084
 C 855, 1084
 CC 855, 1084
 clearing outstanding 103
 Cn 855, 1084
 COLs 855
 COLS 1084
 D 855, 1084
 DD 855, 1085
 Dn 855, 1084
 F 855, 1085
 FC 855
 FH 855
 FL 855
 Fn 855, 1085
 FS 855
 FT 855
 general 42
 I 855, 1085
 In 856, 1085
 L 856, 1085
 LC 856, 1085
 LCC 856, 1085
 LCn 856, 1085
 listed 854, 1084
 listing valid 101
 Ln 856, 1085
 M 856, 1086
 MM 856, 1086
 Mn 856, 1086
 O 857, 1086
 On 857, 1086
 OO 857, 1086
 P 857, 1086
 R 857, 1086
 resolving ambiguity in 102, 162
 RF 137, 857, 1086
 RFF 857, 1087
 RFn 857, 1086
 Rn 857, 1086
 RR 857, 1087
 RRn 857, 1087
 single line operations 102
 SV 138, 857, 1087
 SVF 857, 1087
 SVn 857, 1087
 UC 858, 1087
 UCC 858, 1087
 UCn 858, 1087
 V 858, 1087
 X 858, 1087
 Xn 858, 1088
 XX 858, 1088
 PREFIX primary command 101, 1197
 prefixes
 in Find/Change Utility 377
 prefixes, Find/Change Utility 376
 Preserve copybook library option 206, 789,
 1069
 PREVIOUS primary command 1198
 PREVPAGE primary command
 for AFP Print Browse 733
 PREVREC primary command 1199
 primary command
 Zoom 479
 primary commands
 ADDKEY 480
 AMSMMSG 1118
 APPEND 1119
 APPENDX 1119
 AUTORTRY 140
 BACK
 for Memory Browse 953
 BACKWARD 41, 41
 BID 454
 BOTTOM 41, 1122
 BOUNDS 1123
 BSF 454
 BSR 455
 CANCEL 1124
 CAPS 147, 1124
 CASE 147, 1125
 CE 1126
 CHANGE 1129
 in Find/Change Utility 1129
 CHGASAVE 140
 CLIPBOARD 953
 COPY 1138
 Tape Specific Functions 455
 CREATE 1141
 CREATEX 1141
 CUT 1140
 CX 1129
 DEDIT 1128, 1142
 DELETE 1144
 DELETE members 1143
 differences between View and Edit
 sessions 147
 DOWN 41, 1146
 EDIT 1147
 editor panel 146
 editor session 103
 END 1148
 EXCLUDE 1148
 EXPAND 1154
 EXTENT 1154
 FE 1154
 FILE 1157
 FIND 1157
 for AFP Print Browse 1160
 for Catalog Services 1160
 for Find/Change utility 1159
 for Find/Change Utility 1159
 for Work with VTOC 1160
 Tape Specific Functions 455
 FKEY 1156
 FORMAT 1170
 FORWARD 41, 41
 FREE 1171
 FSF 456
 FSR 456
 FX 1157
 general 42
 HEX 1172
 HIDE 1173
 HISTORY 1174
 HOLD 1175
 index list panel 630
 JOIN 1176
 JUST 1177
 KEY 1177
 LEFT 1178
 LHEX 1180
 LIBLIST 1181
 limiting effect of 154
 LIST 411, 1181
 list of
 Tape Specific Functions 453
 LOCATE 1182
 for AFP Browse 1184, 1184
 for Catalog Services 1183
 for Non-VSAM Extent Information
 panel 1183
 in Find/Change Utility 1183
 Tape Specific Functions 456
 NEXT 1191
 for Memory Browse 953
 NEXTPAGE

- for AFP Print Browse 733
- NEXTREC 1192
- ORDER 1195
- PASTE 1196
- PIC 1197
- PREFIX 1197
- PREVIOUS 1198
- PREVPAGE
 - for AFP Print Browse 733
- PREVREC 1199
- PROFILE 1200
- QUIT 1124
- RBALEN 1200
- RCHANGE 1201
- RD 411, 457, 1202
- RDF 1203
- RECLEN 1204
- RECOVER 163, 1205
- RECSTATS 1205
- REFRESH 1206
- REFS 1206
- REPLACE 1207
- REPLACEX 1207
- RESET 411, 1208, 1208
- REW 457
- RF 137, 1210
- RFIND 1211
 - Tape Specific Functions 457
- RIGHT 1212
- RP 411, 457, 1214
- RUN 457
- SAVE 133, 1215
- SAVEAS 1216
- SAVEASX 1216
- selection lists 62
- SHADOW 1220
- SHOW (FLD) 1221
- SHOW (REC) 1222
- SHOWCOB 1223
- SLOC 1224
- SORT 1224
- SPLT 1227
- SPLTJOIN 1228
- STR 1228
- SV 133, 138, 1229
- SVV 133, 138
- TAILOR 1230
- Tape Specific Functions
 - list of 453
- TEDIT 1231
- Template List 277
- TOF 457
- TOP 41, 1232
- TVIEW 1233
- TYPE 1233
- UP 41, 1234
- UPDATE 1235
- VIEW 1237
- VOLUME 1237
- WIDTH 1237
- XX 1148
- ZOOM 1239
 - Tape Specific Functions 457
- Primary commands
 - ASSOCS 423
 - EXTENT 424
 - FINDNOT 371
 - INFO 423, 423
 - KEYFLDS 392
 - VCONTEXT 376
 - VOLUME 424
- Primary Commands 561
- Primary option Menu
 - Templates (option 7) 1072
- Primary Option Menu 477, 490, 497
 - Edit (option 2) 87
 - Set Processing Options (option 0) 78
 - Tapes (option 4) 445
 - View (option 1) 87
- print a copybook 1536
- Print audit trail report 413
- print data set
 - appending to 1559
 - replacing 1559
- PRINT external function 1681
- print output
 - destination 1558
 - handling 514
 - line length 1558
 - page size 1557
 - translation 1559
- print processing options 80
- Print Processing Options 403, 1025
- Print Utility 404
 - enhanced processing 535
- PRINTDSN processing option 1558
- printing
 - catalog entries 1547
 - copybooks 1536
 - data sets 404, 1438
 - DBCS characters 410, 1517
 - destination 1558
 - disk records 485
 - OAM objects 492, 1528
 - physical disk records 1286
 - REXX member selection 408
 - tape files 1577
 - tape labels 1571
 - translation tables 1559
- printing current record 1202, 1214
- PRINTOUT processing option 1558
- procedures
 - interfacing with
 - File Manager
 - functions
 - 530
- Process
 - function key 436
 - pull-down menu 321
- PROCESS MEMBER, RETURN return value 1715
- processing
 - enhancing 517
 - environment, overview of functions 506
 - options 1550
 - tapes beyond double tape mark 450
- processing options
 - CYLHD 1553, 1553
 - DSINFO 1259, 1298, 1330, 1347, 1364, 1382, 1457, 1476, 1486, 1540, 1554
 - DUMP 1554
 - EOD 1554
 - HEADERPG 1555
 - HLASM
 - DBCS 204, 1020
 - NOALIGN 204, 1020
 - JES class 1558
 - LANGUAGE 1556
 - PAD 1557
 - PAGESIZE 1557
 - PAGESKIP 1557
 - PL/I
 - 31 bit decimal 205, 1025
 - 63 bit binary 205, 1024
 - GRAPHIC 205, 1024
- PRINTDSN 1558, 1558
- PRTCLASS 1558
- PRTDISP 1559
- PRTTRANS 1559
- RECLIMIT 1559
- TAPELBL 1560
- TRACECLS 1560
- Processing Options 78
- PROFILE primary command 1200
- Program Directory mdcxxxli
- PRT_IN external function 1683
- PRT_OUT external function 1684
- PRT_VAR external function 1685
- PRTCLASS processing option 1558
- PRTCOUNT external function 1683
- PRTDISP processing option 1559
- PRTTRANS processing option 1559
- PTF level, displaying
- File Manager
 - 37, 1118, 1236
- PUT primary command
 - updating
 - disk records 479
 - OAM objects 493
 - tape blocks 464
- PWB command
 - define 557, 559
- PWB function 1544
- PWT function 271

Q

- queue, MQ
 - specifying on panel 48
- QUIT primary command 1124

R

- R prefix command 857, 1086
- ranges
 - setting up with labels 159
- RBALEN primary command 1200
- RC Template Workbench primary command 243
- RCHANGE primary command 1201
- RD primary command 411, 457, 1202
- RDF primary command 1203
- re-edit template 221
- Read-ahead synchronization
 - specifying online 389, 776
- RECALL line command 431
- RECCUR external function 1686
- RECLEN area
 - positioning 1204
 - showing 1204
- RECLEN primary command 1204
- RECLIMIT processing option 1559
- record
 - first, scrolling to 120
 - generating multiple layouts 210
 - identifying move or copy target 854, 854, 1084, 1084
 - integrity 132
 - last, scrolling to 120
 - not-selected
 - reason displayed 312
 - sampling 89
 - scrolling to first 120
 - scrolling to last 120
 - showing all by zooming in 112
 - synchronization 389

Record comparison 774
record editing
 examples using FASTREXX 540
record identification criteria 285
record length
 changing 171
 displaying 114, 1204
 effect of CHANGE primary command 150
 padding to maintain 151
 RECLEN primary command 1204
 variable-length records, CHANGE command 1129
record number
 scrolling to 121
record number prefixes
 in Find/Change Utility 377
record ranges
 setting up with labels 159
record type
 changing display 310
 current 309
 selecting for view or edit 285
 suppressed 309
records
 copying 855, 1084
 copying from another data set 1138
 copying from clipboard 1196
 copying to clipboard 1140
 deleting 855, 1084, 1144
 deleting current 1144
 excluded
 effect of CHANGE primary command 150, 150
 excluding from display 858, 1087, 1148
 hiding in SNGL display format 313
 hiding not-selected 311
 identifying 285
 inserting 855, 1085
 labeled range 1129
 labelling 159
 moving 856, 1086
 moving to next 1191, 1192
 moving to previous 1198, 1199
 not-selected
 effect of CHANGE primary command 150
 effect of EXCLUDE primary command 1151
 hiding 311
 showing 311
 overlying 857, 1086
 padding to maintain record length 151
 printing current 1214
 printing current in dump format 1202
 repeating (copying) 857, 1086
 saving 1215
 scrolling to specified number 1182
 setting up range 159
 shifting left 859, 1088
 shifting right 859, 1088
 show currently suppressed 858, 1087
 showing in SNGL display format 313
 showing not-selected 311
 sorting 1224
 suppressed
 effect of CHANGE primary command 150
 effect of EXCLUDE primary command 1151
 translating to lower case 856, 1085
 translating to upper case 858, 1087
 unexcluding from display 1149
 zooming 1239
 SEE lines , not-selected records , suppressed records
Records
 adding to existing data 338
 creating 328
 creating from existing data 334, 339
 replacing from existing data 336
RECOVER primary command 163, 1205
recovering deleted data 163, 1205
RECSIN external function 1686
RECSOUT external function 1687
RECSTATS primary command 1205
redefines
 display 1203
 displayed 109
 generating multiple 01-levels 210
REDEFINES clause 180
Redefines criteria 545
REFA fastpath command 321, 324
REFD fastpath command 321, 322, 325
REFER 181
REFL fastpath command 321, 324, 324, 325
REFLIST, data set reference list 320
REFRESH primary command 1206
refreshing, record 137
REFS primary command 1206
related ID criteria
 editing 233
relative disk addresses 477, 1553
relative generation number 638
relative positioning
 examples using FASTREXX 543
Relative start position
 functions supporting 1629
 INPOS 1629
 OUTPOS 1629
 REXX external functions 1627
 specifying in functions 1630
 VARPOS 1630
release, displaying
File Manager
 37, 1118, 1236
remote resources
 accessing 56
 functions supporting 56
 specifying 56
Remote System Definition List panel 1011
Remote System Definition panel 1009
RENAMES clause 180
renaming
 data sets 1371
repeatable items, syntax diagrams xvii
repeating (copying) one record 857, 1086
repeating search 1211
REPLACE primary command 1207
REPLACEX primary command 1207
replacing data, REPLACE primary command 1207
REPOS definition 186
repository
 SEE template repository
repository entry
 insert or update 190
representing non-displayable characters 110
RESET
 processing option 1551
RESET primary command 411, 1208, 1208
resolving ambiguity in prefix commands 102, 162
REST API 647, 667
restoring
 OAM object from sequential data set 1565
 objects 495
retrieving details, data set list 326
RETURN instruction, return values
 DROP 1714
 DROP MEMBER 1715
 PROCESS MEMBER 1715
 STOP 1715
 STOP IMMEDIATE 1716
review clone list panel 367
REW function 1545
REW primary command 457
rewind a tape 1545
 and unload 1546
rewinding
 tapes 1545, 1546
REXX
 execs
 examples 531, 531
 performance tips 537
 procedures
 interfacing with
 File Manager
 functions
 530
 making FASTREXX eligible 537
 SAY instruction 532
 using with
 File Manager
 functions, description
 517
 stem variable
 from tape records 1605
 from VSAM records 1619
 print output 1558
 to tape file 1621
 to VSAM data set 1623
 variables
 INREC 533
 OUTREC 533
REXX exec
 invoke template list 274
REXX external functions
 absolute and relative start positions 1627
 INPOS 1629
 OUTPOS 1629
 VARPOS 1630
REXX member selection
 printing PDS(E) members 408
REXX procedures
 updating data set records
 one record at a time 1462
 under procedure control 1351
RF prefix command 137, 857, 1086
RF primary command 137, 1210
RFF prefix command 857, 1087
Rfind function key 481, 1158
RFIND primary command 1211
 Tape Specific Functions 457
RFn prefix command 857, 1086
RgtLeft function key 436
RIGHT primary command 1212
Rn prefix command 857, 1086
routing output 1558
RP primary command 411, 457, 1214
RR prefix command 857, 857, 1087, 1087
RSTR_OUT external function 1688
RT Template Workbench primary command 243

- ruler 109
- rules, field mapping 259
- RUN function 1546
- RUN primary command 457
- running a function using a copybook or template 243
- running
 - File Manager
 - batch mode 508
 - in REXX procedures 506

S

- S prefix
 - in Find/Change Utility 377
- sampling, records 89
- SAVE primary command 133, 1215
 - saving editing changes 99
- SAVE_OUT external function 1688
- SAVEAS primary command 1216
- SAVEASX primary command 1216
- saving changes 1215
- saving data
 - using SAVE primary command 99
- saving data, SAVEAS primary command 1216
- saving editing changes 98
- saving, individual records 138
- scaling maximum tape capacity 1522
- scanning
 - disk records 486, 1289
- scanning tapes 471
- scramble
 - options
 - value list 249
- scramble options
 - specifying range values 249
 - specifying scramble type, specifying 246
 - specifying value columns 248
 - specifying value data set name 249
 - specifying value option 247
- scrambling data
 - copy process 350
 - rules 350
 - template repository 187
- scrambling options
 - date fields 250
 - time fields 250
- scratch tapes 447
- scroll amount
 - setting 64, 119
- scrolling
 - automatic after CHANGE 149
 - automatic as result of FIND primary command 1157
 - columns 227
 - controlling amount 64, 119
 - down 1146
 - effect in TABL display format 120
 - holding fields 120
 - holding fields of data 65
 - in panels 41, 41
 - left 1178
 - primary commands
 - BOTTOM 1122
 - DOWN 1146
 - LEFT 1178
 - RIGHT 1212
 - TOP 1232
 - right 1212
 - temporary override 65, 120
 - to column number 121
 - to field 121

- to first column 65, 120
- to first line 65
- to first page 41, 1232
- to first record 120
- to last column 65, 120
- to last line 65
- to last page 41, 1122
- to last record 120
- to record number 121
- to specified field 1182
- to specified record 1182
- up 1234
- with function keys 63, 117
- with primary commands 64, 118
- SCS function 1547
- search
 - disk record 1289
 - order for copybooks 206
 - partitioned data sets 616
 - repeating 1211
- search expressions
 - index search 632
- search string
 - case-significant 1129
 - character 1129
 - DBCS 1129
 - hexadecimal 1129
- searching numeric fields 126
- SEGCNT external function 1689
- SEGLen external function 1689
- segmented data templates
 - copying data 351
 - overview 177
 - setting up 212
 - viewing data 314
- segmented data, templates
 - editing 233
- segmented records
 - moving to next 1192
 - moving to previous 1199
- SEGNO external function 1691
- SEGOFF external function 1690
- selecting a field for attribute change 229
- selecting a field for specifying scrambling options 246
- selecting a record type for editing 284
- selecting display format 105
- selecting multiple PDS(E) members 70
- selection lists 69
 - changing width of columns 67
 - displaying in hexadecimal 69
 - filtering 68
 - finding data 67
 - sorting 66
- sending tapes across a network 463
- sequence number, tape 448
- sequential data set
 - copying an OAM object from a sequential data set 1565
 - copying an OAM object to a sequential data set 1530
 - restoring an OAM object from a sequential data set 1565
- sequential data sets
 - copying records from sequential data set to tape file 1568
 - copying tape records to a sequential data set 1592
 - types supported 30
- Sequential Data to Tape
 - copying tapes across a network 463

- service archive file 667
- service provider
 - CICS VSAM data set example, generic method 684
 - CICS VSAM data set example, specific method 696, 699
 - Db2 example: sequential read 691, 707
 - Db2 example: WHERE clause 694, 709
 - deploying 675
 - IMS example: position then read 689
 - IMS example: sequential read 687, 703, 705
 - MVS data set example, generic method 681
 - MVS example, specific method 701
 - overview 647
 - security 677
 - Swagger documentation 675
 - troubleshooting 678
 - UNIX System Services example, generic method 685
- session
 - ending 1148
- SET function 1550
 - returning to default values 1551
- set print processing options
 - print processing options 80
- Set Processing Options
 - Batch Job Card Information 82, 1015
 - COBOL Processing Options 202, 1016
 - Compiler Language Selection 201, 788
 - compiler specifications 82
 - editor options 82
 - Editor Options 868
 - HLASM Processing Options 204, 1020
 - Language and Compiler Specifications 1021
 - Output Data Set Allocations options 83
 - PL/I Processing Options 205, 1024
 - Print Processing Options 403, 1025
 - System Processing Options 80, 1031
 - Tape Processing Options 82, 1034
 - Temporary Data Set Allocations options 83
 - trace options 83
 - VSAM edit sharing options 83
- SET_FLD external function 1691
- SET_OLEN external function 1692
- SETC external function 1693
- SETCICS function 1561
- SETN external function 1694
- SETRC external function 1564, 1695
- setting hexadecimal display format 1172, 1200
- setting scroll amount 64, 119
- shadow lines
 - assigning labels to 858, 1088
 - hiding 1220
 - not showing 312
 - representing not-selected records 311
 - representing suppressed records 309
 - showing 312, 1220
- SHADOW primary command 1220
- shared files, working with 132
- shifting records left 859, 1088
- shifting records right 859, 1088
- SHOW (FLD) primary command 1221
- SHOW (REC) primary command 1222
- show currently suppressed records 858, 1087
- show excluded records 855, 856, 1085, 1085
- SHOWCOB primary command
 - description 1223
 - using 39
- showing bounds line 854, 1084

- showing hexadecimal values 107
- showing invalid data 314
- showing not-selected records 311, 1222
- showing prefix area 1197
- showing RECLEN area 1204
- showing shadow lines 312, 1220
- showing suppressed records 309, 1222, 1237
- SHOWSORT 522
- single line prefix command 102
- SL tape processing 446, 448
- SLOC primary command 1224
- SNGL display format 107
 - hiding records 313
 - showing records 313
- SO function 1565
- SORT primary command 1224
- sorting
 - by column 123
 - by field 123
 - restricting to excluded or not-excluded records 124
 - setting sequence 124
- sorting data 123
- sorting records 1224
- sorting selection lists 66
- source definition, description 176
- specifying data sets
 - editor session 89
- splitting lines 170
- SPLT primary command 1227
- SPLTJOIN primary command 1228
- ST function 1568
- start location
 - display 1224
- statement continuation 509
- statistics
 - listing for a editor session 96
 - RECSTATS primary command 1205
- STATS external function 1696
- STOP IMMEDIATE, RETURN return value 1716
- STOP, RETURN return value 1715
- STR primary command 1228
- string
 - delimiters 42
 - find and replace 1129
 - find next occurrence 1158
 - finding 125
 - highlighted by CHANGE primary command 149
 - replacement 1129
 - specifying search string for CHANGE primary command 1129
 - using for creating copybook subset 209
- strings
 - entering when quoted 42, 148
 - long
 - SEE long strings
- strings in data sets
 - changing 1503
 - finding 1503
 - replacing 1503
 - searching for 1503
- subscripting array element 110
- subset
 - extracting from copybook 209
- summarizing
 - tape contents 1575
- summary
 - tape labels, printing 469
- supported HFS files 31
- supported partitioned data sets 30

- supported sequential data sets 30
- supported VSAM data sets 30
- suppressed record types 309
- suppressed records 309
 - affect of prefix commands 103
 - hiding 1208, 1222
 - representing by shadow lines 309
 - showing 1222, 1237
 - showing in TABL display format 309
- SV prefix command 138, 857, 1087
- SV primary command 133, 138, 1229
- SVF prefix command 857, 1087
- SVn prefix command 857, 1087
- SVV primary command 133, 138
- Swagger documentation 675
- swagger.json file 675
- synchronization
 - comparison options 389
- Synchronized comparisons 776
- synonym for FIND command 1158
- syntax diagrams 1241
- syntax diagrams, how to read xvii
- SYSOUT class
 - print destination 1558
- SYSPRINT
 - print destination 1558
 - REXX procedures, primary output data set 1687, 1713
 - REXX procedures, TALLY external function 1697
- System Processing Options 80, 1031

T

- TABL display format 109
 - showing suppressed records 309
- tabular display format 109
- TAILOR primary command 639, 1230
- tailoring
- File Manager
 - 1550
- TALLY external function 1697
- tape
 - allocating input and output 446
 - block size 450
 - bypass label processing 448
 - changing 466
 - contents, printing 468
 - conversion mode 449
 - copying, across a network 463
 - data-check errors 451
 - density 449
 - getting data from a buffer 464
 - input, specifying 445
 - labels, printing 469
 - large blocks 450
 - managing, overview of functions 505
 - mark
 - converted during copy 463
 - double 450
 - mode 449
 - output, specifying 445
 - printing 466
 - scaling maximum capacity 1522
 - scratch 447
 - update 465
- Tape Browse, description 458
- Tape Data Copy Function, description 458
- Tape Label Display, description 469
- tape labels
 - printing 1571
- Tape Map, description 468

- Tape Positioning Functions, description 476
- Tape Print, description 466
- Tape Processing Options 82, 1034
- Tape Record Load, description 466
- Tape Record Scan, description 471
- Tape Specific Functions 445, 473
 - Create Tape Data 469
 - Erase Tape 474
 - Exported Stacked Volume List 475
 - Initialize Tape 473
 - primary commands 453
 - primary commands, list of 453
 - Tape Browse 458
 - Tape Data Copy Function 458, 459, 459, 459
 - Exported Stacked Volume Copy 462
 - Sequential Data to Tape 461
 - Tape to Sequential Data 461
 - Tape to VSAM 460
 - VSAM to Tape 461
- Tape Label Display 469
- Tape Map 468
- Tape Positioning Functions 476
- Tape Print 466
- Tape Record Load 466
- Tape Record Scan 471
- Tape to Tape Compare 471
- Tape Update 464
- Tape Specific Functions panel, description 445
- Tape to Sequential Data
 - copying tapes across a network 463
- Tape to Tape Compare, description 471
- Tape to VSAM
 - copying tapes across a network 463
- Tape Update
 - special considerations 465
- Tape Update, description 464
- TAPELBL processing option 1560
- tapes
 - ANSI labels, creating 1560
 - closing 1546
 - comparing 1598
 - copying from a REXX stem variable 1621
 - copying from tape to tape 1596
 - copying from tape to tape with reblocking 1599
 - copying records from sequential data set to tape file 1568
 - copying tape records to a sequential data set 1592
 - copying tape records to a VSAM data set 1602
 - copying to a REXX stem variable 1605
 - copying VSAM records to a tape file 1616
 - copying with label processing 1573
 - creating test data 1250
 - erasing 1498
 - locating data 1589
 - moving backwards
 - by physical records 1249
 - by tape files 1248
 - moving forwards
 - by tape files 1519
 - by tape records 1520
 - printing tape files 1577
 - rewinding 1545, 1546
 - scanning 1589
 - summarizing contents 1575
 - writing tape marks 1621
- tasks
 - enhancing with procedures 517

- TEDIT primary command 1231
- template
 - editing before use 792
 - re-edit 221
 - save from edit or view 221
 - XML definitions 1823
- template list
 - invoking 271, 273
 - panel 275, 1063
 - REXX exec 274
- Template List
 - Primary commands 277
- template list command 273, 274
- template member list
 - panel 1064
- Template Member List panel 276
 - Column descriptions 280
 - Customizing and sorting columns 276
 - Field descriptions 277
- template repository 186
 - editing 188
 - export history utility 196
 - export utility 193
 - import utility 194
 - insert or update entry 190
 - mandatory 186, 187
 - name 186, 187
 - scrambling data 187
- template structure
 - display 1228
- Template Workbench
 - description 199
 - showing 1231, 1233
- Template Workbench commands
 - CC 212
 - CM 214
- Template Workbench primary commands
 - E 233, 233
 - MC 244
 - MT 244
 - RC 243
 - RT 243
 - U 242
- templates
 - advanced copybook selection 208
 - building many 1253
 - changing 94
 - comparing data sets 384
 - copybook templates 175
 - creating from a copybook 211
 - creating from a model 213
 - creating with TVIEW 94
 - description 31
 - dynamic templates 180
 - editing 233, 1231
 - editing before use 755, 1095, 1113
 - editing to avoid field truncation 110
 - exporting to XML 261, 1579
 - holding columns for scrolling 227
 - importing from XML 261, 1584
 - mapping SMF data 179
 - not interchangeable between Base, FM/Db2 and FM/IMS 31
 - overriding SET DBCS Format option 410
 - overview 31
 - removing 94
 - segmented data 177
 - selecting with TVIEW 94

- setting up for segmented data 212
- updating 242
- updating multiple 1263
- viewing segmented data 314
- workbench 199
- Temporary Data Set Allocations options 83
- TESTC external function 1699
- TESTN external function 1702
- TFLD external function 1703
- TID external function 1706
- time attributes
 - changing 231
 - defining 231
 - selecting field 231
- time fields
 - entering criteria 295
 - specifying scrambling options 250
- tips, function performance 1243
- TLB function 1571
- TLT function 1573
- TM external function 1706
- TMP function 1575
- TOF primary command 457
- TOP external function 1707
- TOP primary command 41, 1232
- TP function 1577
- TP primary command
 - SEE* TPRINT primary command
- TPEXP function 1579
- TPIMP function 1584
- TPREPOS ddname 186
- TPRINT primary command 1232
- trace options 83
- TRACELCS processing option 1560
- translate records to lower case 856, 1085
- translating
 - messages and panels 1556
 - unprintable characters 1559
- translating data to uppercase 147
- translating records to upper case 858, 1087
- translation tables
 - SET function 1559
- transmitting tapes across a network 463
- TRIM option, deleting member generations 642
- TRS function 1589
- truncated records 1557
- TS function 1592
- TT function 1596
- TTC function 1598
- TTR function 1599
- turning off highlighting 149
- TV function 1602
- TVIEW primary command 1233
- TX function 1605
- Type column
 - toggling display 1233
- TYPE primary command 1233

U

- U Template Workbench primary command 242
- UC prefix command 858, 1087
- UCC prefix command 858, 1087
- UCn prefix command 858, 1087
- unaligned processing option 1025
- unexcluding records from display 1149
- union statements
 - generating multiple 01-levels 210
- unit, tape 447
- UNIX
 - SEE* HFS, nomenclature

- UNIX System Services
 - SEE* Primary Option Menu, HFS (option 8)
- unloading tape after rewinding 1546
- unprintable characters, translation of 1559
- UP external function 1707
- UP primary command 41, 1234
- UPDATE external function 1708
- UPDATE primary command, description 1235
- updating
 - disk data set records 1351, 1462
 - disk records 478
 - multiple templates 1263
 - OAM objects 493
 - tape blocks 464, 465
- updating a template from a copybook 242
- update hexadecimal display format 106
- uppercase
 - translating data to 147
- USAGE clause 180
- Use I/O exit 794
- user exits
 - SET function 1561
 - system processing options 81
- user profile
 - storing shadow setting 1221
- using F4 for enhanced search report filtering commands 581
- using F4 from any edit or view session when positioned on a string or word 583
- using F4 to edit a resource from the enhanced search report 582
- Using the F4 data set processing options in JCL 595
- using the F4 function key 581
- Utility Functions 341
 - AFP Print Browse 437
 - Catalog Services 415
 - Copybook view and print 260
 - Data Create Utility 328
 - Find/Change Utility 368
 - Memory Browse 437
 - Print audit trail report 413
 - Print Utility 404
 - Set DBCS Format 410
 - Work with VTOC 432

V

- V prefix command 858, 1087
- VAL_FLD external function 1708
- VALUE clause 180
- value list, scrambling data 249
- values
 - over-large
 - showing 110
 - truncating 110
- VAR_OUT external function 1708
- VAR_TM external function 1710
- Variable length arrays
 - data description support 182
- variable-length records, CHANGE command 1129
- variables, syntax diagrams xvii
- VARPOS
 - setting 1630
- VARYING 181
- VARYINGZ 181
- VCONTEXT primary command 376
- VER function 1607
- VER primary command 37, 1236
- version of File Manager

- VER function 1607
- View (option 1) 87
- View and print utility 260
- view load
 - module 1607
- View Load Module utility 438
 - member generations 278, 643
- View panel 87
- VIEW primary command 1237
- viewing
 - data sets 1480
- Virtual VSAM 489
- vim
 - function
 - batch example 1613
 - view load 1607
- VLM
 - function
 - description 1607
- VO function 1614
- VOLSER, tape 447
- volume
 - information, displaying 424
- VOLUME primary command 424, 1237
- volume serial, tape 447
- VSAM
 - SHAREOPTIONS 3 132
 - SHAREOPTIONS 4 132
- VSAM data set
 - copying an OAM object to a VSAM data set 1533
 - copying from a VSAM data set to an OAM object 1614
- VSAM data sets
 - copying tape records to a VSAM data set 1602
 - copying VSAM records to a tape file 1616
 - types supported 30
- VSAM edit sharing options 83
- VSAM records
 - copying from a REXX stem variable 1623
 - copying to a REXX stem variable 1619
- VSAM statements
 - define 1285
- VSAM to Tape
 - copying tapes across a network 463
- VSAM update 488
- VT function 1616
- VTOC
 - displaying 1491
- VTS
 - defined 452
- VX function 1619

W

- WebSphere MQ, working with 439
- width
 - output
 - see* output width
 - width of columns in selection lists 67
- WIDTH primary command 1237
- Work with VTOC 432
- write disk EOF 487
- WRITE external function 1712
- Write Tape Mark 473
- writing
 - disk EOF record 487
 - tape marks 1621, 1621
- WTM function 1621

X

- X prefix command 858, 1087

- X prefix, Find/Change Utility 376
- XD primary command 74, 1239
- XFind command
 - syntax 618
- XFIND command
 - define 617, 618
- XML definitions
 - for a template 1823
- XML format
 - copying data 353
 - template repository export 198
- XML templates 261
- Xn prefix command 858, 1088
- XT function 1621
- XV function 1623
- XX (Exclude Extended) command 130
- XX prefix command 858, 1088
- XX primary command 1148

Z

- z/OS Connect API
 - see* service provider
- z/OS UNIX file systems
 - see* HFS, nomenclature
- z/OS UNIX System Services
 - see* Primary Option Menu, HFS (option 8)
- ZCSR editor-assigned label 161
- zFS
 - see* HFS, nomenclature
- ZFST editor-assigned label 161
- ZLST editor-assigned label 161
- Zoom
 - function 464
- Zoom function key 113
- Zoom primary command 479
- ZOOM primary command 113, 1239
 - Tape Specific Functions 457
- zooming
 - effect on CHANGE primary command 150
- zooming in
 - showing all fields 113
 - to show all one record 112
- zooming on one record 1239
- zooming out 113